



# INSTALLATION MANUAL

Stage2 624

Stage2 634

Stage2 424

Stage2 9634





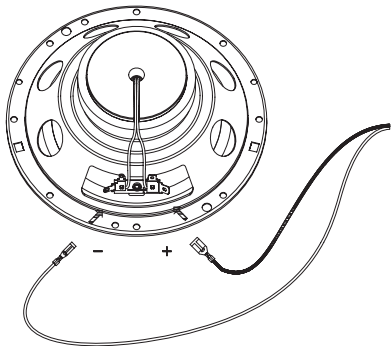
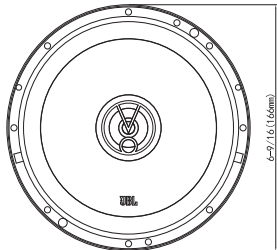
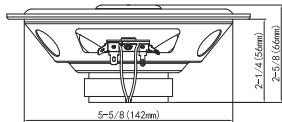

Stage2 604C

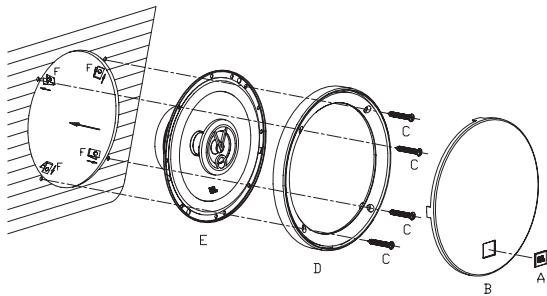
Stage2 524

# Stage2 624





<p>A</p>  <p>2x</p>	<p>B</p>  <p>2x</p>	<p>C</p>  <p>8x</p>	<p>D</p>  <p>2x</p>	<p>E</p>  <p>2x</p>	<p>F</p>  <p>8x</p>
--	--	--	--	--	--

## Specifications

- Type: 6-1/2" (160mm) Two Way Coaxial Car Speaker
- Power Handling: 40Wrms, 240W peak
- Sensitivity (@ 2.83V): 91dB
- Frequency Response: 55 Hz – 20 kHz
- Nominal Impedance: 4 ohms



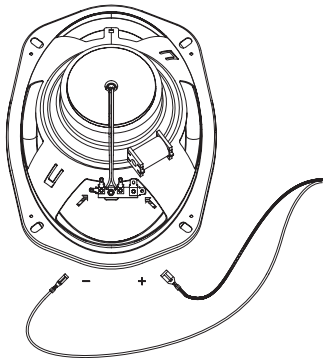
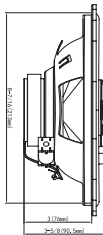
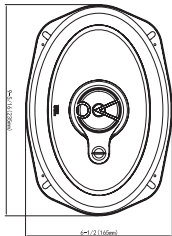
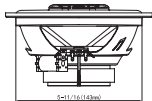

## Thiele-Small Parameters

- BL (Tm): 3.241
- DCR (ohm): 3.2
- Mms (g): 8.031
- Sd (cm<sup>2</sup>): 128.68
- Cms (μm/N): 427.874
- Vas (l): 10.061
- Fs (Hz): 85
- Qes: 1.32
- Qms: 4.242
- Qts: 1.007
- Crossover Point: 4.6 kHz

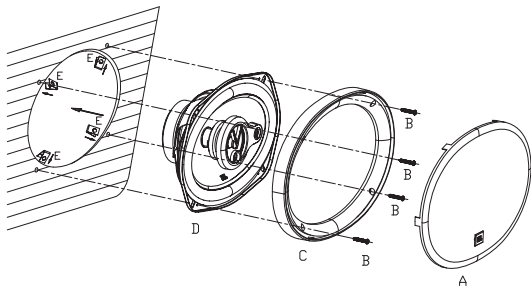
# Stage2 9634





<p>A</p>  <p>2x</p>	<p>B</p>  <p>8x</p>	<p>C</p>  <p>2x</p>	<p>D</p>  <p>2x</p>	<p>E</p>  <p>8x</p>
--	--	--	---	--

## Specifications

- Type: 6" x 9" (152mm x 230mm) Three Way Car Speaker
- Power Handling: 70Wrms, 420W peak
- Sensitivity (@ 2.83V): 92dB
- Frequency Response: 50Hz – 21kHz
- Nominal Impedance: 4 ohms

## Thiele-Small Parameters





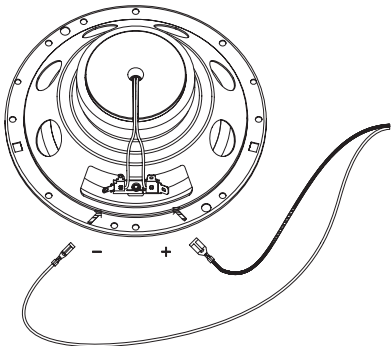
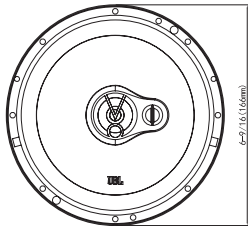
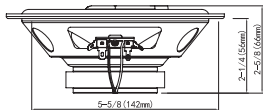

- BL (Tm): 3.496
- DCR (ohm): 2.3
- Mms (g): 17.755
- Sd (cm<sup>2</sup>): 213.565
- Cms (μm/N): 306.333
- Vas (l): 19.84
- Fs (Hz): 70
- Qes: 1.432
- Qms: 3.99
- Qts: 1.054
- Crossover Point: 3.6 kHz

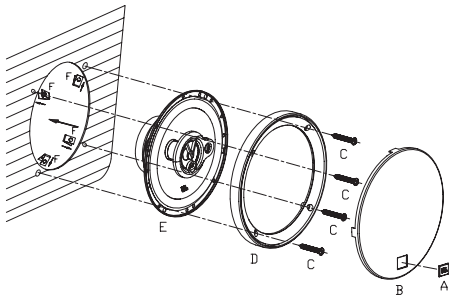
# Stage2 634







<p>A</p>  <p>2x</p>	<p>B</p>  <p>2x</p>	<p>C</p>  <p>8x</p>	<p>D</p>  <p>2x</p>	<p>E</p>  <p>2x</p>	<p>F</p>  <p>8x</p>
--	--	--	--	--	--

## Specifications

- Type: 6-1/2"(160mm) Three Way Car Speaker
- Power Handling: 40Wrms, 250W peak
- Sensitivity (@ 2.83V): 91dB
- Frequency Response: 55 Hz – 20 kHz
- Nominal Impedance: 4 ohms

## Thiele-Small Parameters





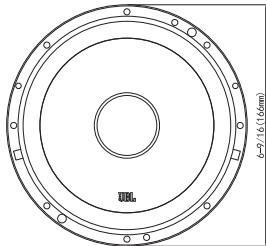
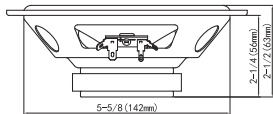

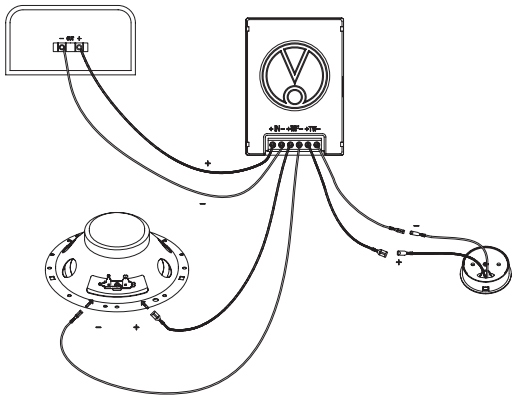

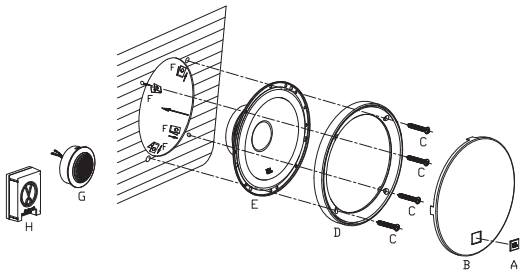
- BL (Tm): 3.241
- DCR (ohm): 3.2
- Mms (g): 8.031
- Sd (cm<sup>2</sup>): 128.68
- Cms (μm/N): 427.874
- Vas (l): 10.061
- Fs (Hz): 85
- Qes: 1.32
- Qms: 4.242
- Qts: 1.007
- Crossover Point: 4.2 kHz

# Stage2 604C







<p>A</p>  <p>2x</p>	<p>B</p>  <p>2x</p>	<p>C</p>  <p>8x</p>	<p>D</p>  <p>2x</p>	<p>E</p>  <p>2x</p>	<p>F</p>  <p>4x</p>	<p>G</p>  <p>2x</p>	<p>H</p>  <p>2x</p>
--	--	--	--	--	--	--	--

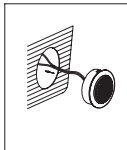

## Specifications

- Type: 6-1/2" (160mm) Two Way Component Speaker System
- Power Handling: 45Wrms, 270W peak
- Sensitivity (@ 2.83V): 91dB
- Frequency Response: 55 Hz – 20 kHz
- Impedance: 4 ohms



## Thiele-Small Parameters

- BL (Tm): 3.588
- DCR (ohm): 3.2
- Mms (g): 11.01
- Sd (cm<sup>2</sup>): 128.68
- Cms (μm/N): 348.261
- Vas (l): 8.189
- Fs (Hz): 85
- Qes: 1.398
- Qms: 3.618
- Qts: 1.008
- Crossover Point: 5.8 kHz

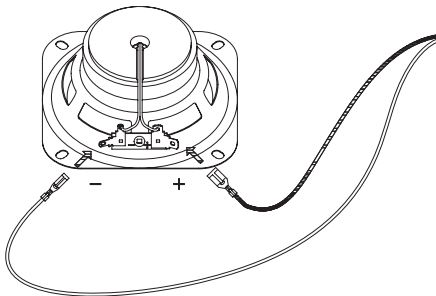
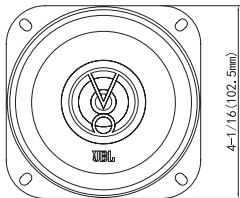
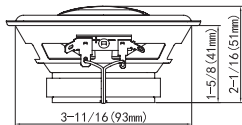
# Stage2 424

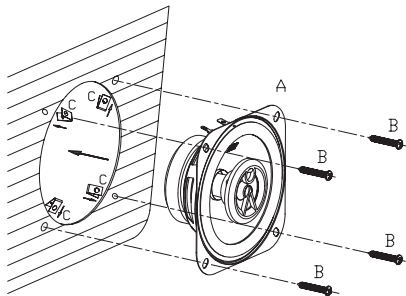



<p>A</p>  <p>2x</p>	<p>B</p>  <p>8x</p>	<p>C</p>  <p>8x</p>
--	--	--



## Specifications

- Type: 4" (100mm) Two Way Car Speaker
- Power Handling: 25Wrms, 150W peak
- Sensitivity (@ 2.83V): 88dB
- Frequency Response: 75Hz – 20kHz
- Nominal Impedance: 4 ohms



## Thiele-Small Parameters

- BL (Tm): 2.965
- DCR (ohm): 3.2
- Mms (g): 4.629
- Sd (cm<sup>2</sup>): 55.389
- Cms (μm/N): 409.235
- Vas (l): 1.785
- Fs (Hz): 115
- Qes: 1.224
- Qms: 4.583
- Qts: 0.966
- Crossover Point: 6.6 kHz

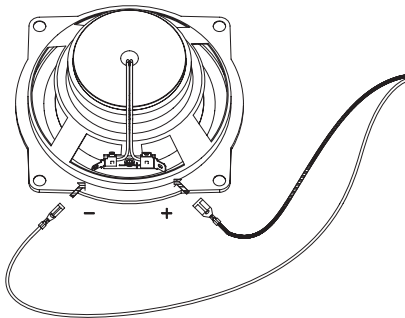
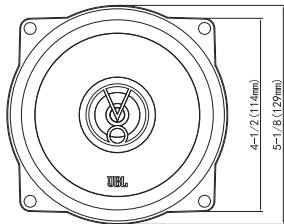
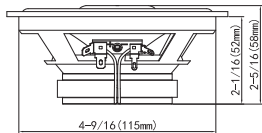
# Stage2 524

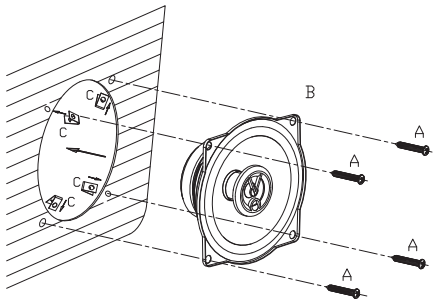



<p>A</p>  <p>8x</p>	<p>B</p>  <p>2x</p>	<p>C</p>  <p>8x</p>
--	--	--

## Specifications

- Type: 5-1/4" (130mm) Two Way Car Speaker
- Power Handling: 35Wrms, 210W peak
- Sensitivity (@ 2.83V): 90dB
- Frequency Response: 75Hz – 20kHz
- Nominal Impedance: 4 ohms

## Thiele-Small Parameters

- BL (Tm): 3.11
- DCR (ohm): 3.2
- Mms (g): 5.269
- Sd (cm<sup>2</sup>): 81.71
- Cms (μm/N): 506.563
- Vas (l): 4.803
- Fs (Hz): 95
- Qes: 1.067
- Qms: 4.525
- Qts: 0.864
- Crossover Point: 5.8 kHz



HARMAN International  
Industries, Incorporated, 8500  
Balboa Boulevard, Northridge,  
CA 91329 USA

© 2019 HARMAN International  
Industries, Incorporated. All

rights reserved. JBL is a trademark of HARMAN International  
Industries, Incorporated, registered in the United States and/or  
other countries.

Features, specifications and appearance are subject to change  
without notice.