

# ANRÄTTA

AU



Design and Quality  
IKEA of Sweden





Please refer to the last page of this manual for the full list of IKEA appointed Authorized Service Centre and relative national phone numbers.

## ENGLISH

4

## Table of contents

Safety Information	4	What to do if ...	16
Product description	7	Technical data	17
Control panel	8	Installation	18
First use	8	Electrical connection for Australia	19
Daily use	9	Environmental concerns	19
Cooking tables	12	IKEA GUARANTEE	20
Cleaning and maintenance	14		

## Safety Information

Before using the appliance, read these safety instructions. Keep them nearby for future reference. These instructions and the appliance itself provide important safety warnings, to be observed at all times. The manufacturer declines any liability for failure to observe these safety instructions, for inappropriate use of the appliance or incorrect setting of controls.

### SAFETY WARNINGS

⚠ Very young children (0-3 years) should be kept away from the appliance. Young children (3-8 years) should be kept away from the appliance unless continuously supervised. Children from 8 years old and above and persons with reduced physical, sensory or mental capabilities or lack of experience and knowledge can use this appliance only if they are supervised or have been given instructions on safe use and understand the hazards involved. Children must not play

with the appliance. Cleaning and user maintenance must not be carried out by children without supervision.

⚠ **WARNING!** The appliance and its accessible parts become hot during use. Care should be taken to avoid touching heating elements. Children less than 8 years old must be kept away unless continuously supervised.

⚠ Never leave the appliance unattended during food drying. If the appliance is suitable for probe usage, only use a temperature probe recommended for this oven - risk of fire.

⚠ Keep clothes or other flammable materials away from the appliance, until all the components have cooled down completely - risk of fire. Always be vigilant when cooking foods rich in fat, oil or when adding alcoholic beverages - risk of fire. Use oven gloves to remove pans and accessories. At the end of cooking, open the door with caution: allowing hot air or

steam to exit gradually before accessing the cavity - risk of burns. Do not obstruct hot air vents at the front of the oven - risk of fire.

⚠ Exercise caution when the oven door is in the open or down position, to avoid hitting the door.

### PERMITTED USE

⚠ **CAUTION:** the appliance is not intended to be operated by means of an external switching device, such as a timer, or separate remote controlled system.

⚠ This appliance is intended to be used in household and similar applications such as: staff kitchen areas in shops, offices and other working environments; farm houses; by clients in hotels, motels, bed & breakfast and other residential environments.

⚠ Do not install the appliance behind a decorative door - risk of fire.

⚠ This appliance is not for professional use. Do not use the appliance outdoors.

No other use is permitted (e.g. heating rooms).

⚠ Do not store explosive or flammable substances (e.g. gasoline or aerosol cans) inside or near the appliance - risk of fire.

### INSTALLATION

⚠ The appliance must be handled and installed by two or more persons - risk of injury. Use protective gloves to unpack and install - risk of cuts.

⚠ Installation, including water supply (if any) and electrical connections, and repairs must be carried out by a qualified technician. Do not repair or replace any part of the appliance unless specifically stated in the user manual. Keep children away from the installation site. After unpacking the appliance, make sure that it has not been damaged during transport. In the event of problems, contact the dealer or your nearest After-sales Service. Once installed, packaging waste (plastic, styrofoam parts etc.) must be stored out of reach of children - risk of suffocation. The appliance must be disconnected from the power supply before any installation operation - risk of electrical shock. During installation, make sure the appliance does not damage the power cable - risk of fire or electrical shock. Only activate the appliance when the installation has been completed.

⚠ Carry out all cabinet cutting works before fitting the appliance in the furniture and

remove all wood chips and sawdust.

Do not obstruct the minimum gap between the worktop and the upper edge of the oven - risk of burn.

Do not remove the oven from its polystyrene foam base until the time of installation.

⚠ After installation, the bottom of the appliance must no longer be accessible - risk of burn.

### **ELECTRICAL WARNINGS**

⚠ The rating plate is on the front edge of the oven (visible when the door is open).

⚠ It must be possible to disconnect the appliance from the power supply by unplugging it if plug is accessible, or by a multi-pole switch installed upstream of the socket and the appliance must be earthed, in conformity with national electrical safety standards.

⚠ Do not use extension leads, multiple sockets or adapters. The electrical components must not be accessible to the user after installation.

Do not use the appliance when you are wet or barefoot.

Do not operate this appliance if it has a damaged power cable or plug, if it is not working properly, or if it has been damaged or dropped.

⚠ If the supply cord is damaged, it must be replaced with an identical one by the manufacturer, its service agent or similarly qualified persons in order to avoid a hazard - risk of electrical shock.

⚠ In case of replacement of power cable, contact an authorized service center.

**Product description**

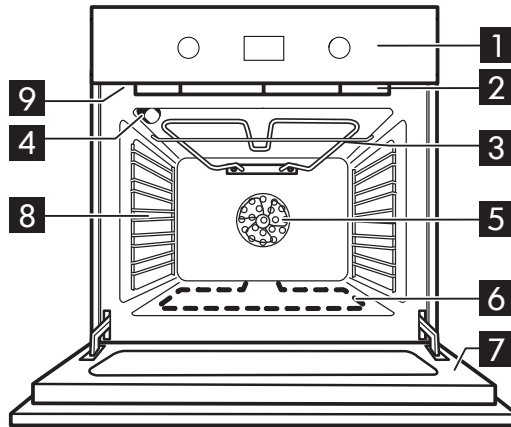

- 1** Control panel
- 2** Cooling fan (not visible)
- 3** Grill element
- 4** Oven lamp
- 5** Oven fan
- 6** Lower heating element (hidden)
- 7** Oven door
- 8** Lateral grids
- 9** Meat probe connection

**Accessories**

Baking tray

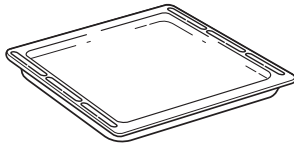

1x

Deep tray

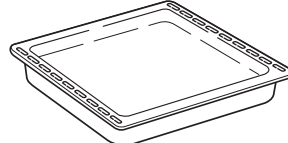

1x

Wire Shelf

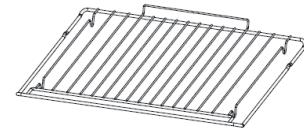

2x

Telescopic Runners

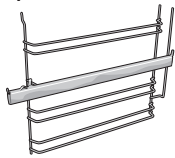

1x

Meat probe

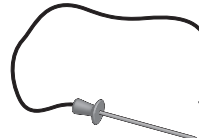

1x

**Inserting the wire shelf and other accessories**

Insert the wire shelf onto the level you require by holding it tilted slightly upwards and resting the raised rear side (pointing upwards) down first. Next, slide it horizontally along the shelf guide as far as possible.

The other accessories, such as the baking tray, are inserted horizontally by sliding them along the shelf guides.

If you want to buy an accessory, call the Authorized Service Centre.

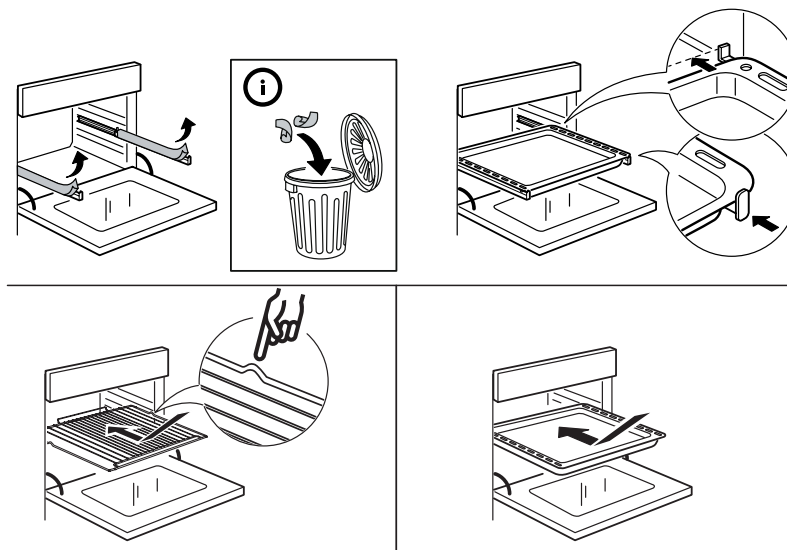

## Control panel

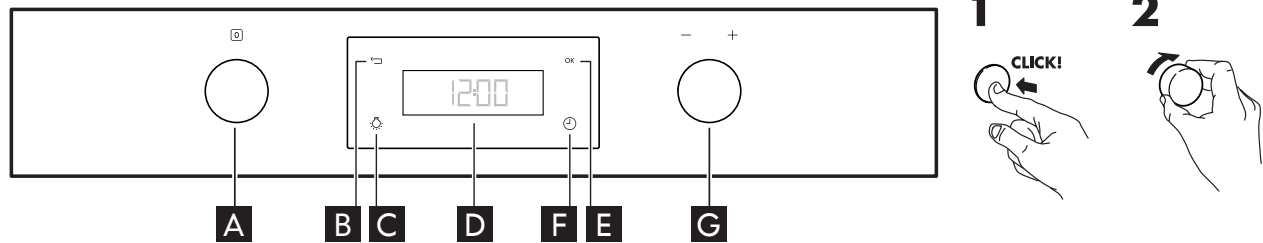

- A** Selection push-push knob
- B** Back button
- C** Light
- D** Display
- E** Confirmation button
- F** Minute minder
- G** Adjust push-push knob

### Retractable knobs

To use this type of knob, press it in the middle. The knob comes out.

Turn it to the required position.

Once cooking is over, turn the knob to **0** and press it again to restore it to its original position.

## First use

Remove the accessories from the oven and heat it at 200° for about an hour to eliminate the smell and fumes from the insulating materials and protective grease

### Settings

Turn the “Functions” knob **A** indicator to display setting and turn the **G** knob to access a submenu containing four display settings which can be changed once cooking is over, turn the knob to its original position.

#### • Clock

Turn the **G** knob to display CLOCK. The two left digits will then start to blink, turn the **G** knob to set hours. Press **E** button to confirm the value and the right two digit will start to blink. Turn the **G** knob to set minutes and press the **E** button to confirm the selection.

#### • Sound

To activate or deactivate the acoustic signal, proceed as follows:

1. Turn the **G** knob to display “SOUND”
2. press **E** button to confirm
3. Use the **G** knob to select the desired setting

4. Press **E** button to confirm

#### • Brightness

To change the display brightness, proceed as follows:

1. Turn the **G** knob to display “BRIGHTNESS and press **E** to confirm.
2. The current brightness value is visible
3. Turn the **G** knob to increase or decrease brightness and confirm by pressing **E** .

#### • Eco

1. Turn the **G** knob to display “ECO”.
2. Press **E** to access the setting (ON/OFF).
3. Turn the **G** knob to select the desired setting and confirm by pressing button **E** .
4. During a cooking function, if the Eco Mode is activated, the display reduces the brightness to the lowest level after 1 minute, the cavity lamp will be switched off after 1 minute of cooking and reactivated by pressing button **C** .



## Daily use

### To activate a Function

1. select the desired function with **A** knob and press **E** button to confirm.
2. the Temperature is Blinking and you can adjust with **G** knob and press **E** button to confirm.
3. the cooking time is visible on the display, you can adjust it with **G** knob or leave to for an immediate start and press **E** button to confirm.
4. if you selected before a desired cooking time, the display will show the expected time of end, you can postpone it with **G** knob and press **E** button to confirm the delay.

### Preheat

The preheat will start automatically when available (Check the table) and is included in the cooking time if you select it before starting the function.

If you select the temperature and a cooking time the preheat starts automatically. If you do not select the cooking time the timer will start only after reached the desired temperature.

Always an audible sound will advise when the temperature is reached.

### Delay to Start



















Will be postpone the end of cooking time, when available (Check the table).

### Meat Probe

Insert the meat probe before activate a function (Check the table). If the meat probe is inserted after the confirmation of the cooking temperature, the display will blink the meat probe temperature, use the **G** knob to adjust it and press **E** button to confirm.

Delay to Start is not applicable when the meat probe is inserted.

When the meat probe tracks the desired temperature, 3 audible signal will sound and the cooking function will ends.

	Function <b>A</b> Knob	Function <b>G</b> Knob	PREHEAT	Temperature 	Time 	Delay to Start 	Meat Probe
	OFF	-	-	-	-	-	-
	FORCED AIR	-	X	X	X	X	X
	CONVENTIONAL (Top and Bottom Heat)	-	X	X	X	X	X
	CONVECTION BAKE	-	X	X	X	X	X
	MAXI COOKING	-	X	X	X	X	X
	GRILL	GRILL	-	level 1-2-3	X	X	-
	GRILL	TURBO GRILL	-	level 1-2-3	X	X	X
	BREAD	BREAD	X	X	X	-	-
	BREAD	PIZZA	X	X	X	-	-
	SPECIALS	ECO FORCED AIR*	-	X	X	X	X
	SPECIALS	DEFROST	-	-	X	X	-
	SPECIALS	WARM KEEPING	-	65°	X	X	-
	SPECIALS	RISING	-	30° 35° 40°	X	X	-
	FAST PREHEAT	-	X	X	X	-	-
	PYRO-CLEANING	PYRO	-	-	120 min	X	-
	PYRO-CLEANING	PYRO-ECO	-	-	75 min	X	-

**IMPORTANT:** Remove all accessories before running the pyrolysis function. To assure a better cleaning results of the bottom of the oven.

**IMPORTANT:** During pyro-cleaning, the oven door is automatically locked and the symbol appears on the display. The door remains locked at the end of the cleaning cycle: “COOL” appears on the display, indicating the oven is still cooling down. When the oven cools to a safe temperature, the door is unlocked and on the display will be shown the time of day.



**N.B.:** if the automatic door lock control procedure fails to execute properly, the symbol appears on the display. If, on the other hand, the door remains closed due to a fault in the locking system, and “DOOR LATCHED” appear on the display. In this case, contact the Authorized Service Centre.

**Browning**

At the end of cooking, with certain functions, the display indicates the possibility of extra browning. This function can only be used when cooking time has been set.









At the end of cooking time, the display shows: “PRESS **E** TO BROWN”. Press **E** , and the oven starts a 5 minute browning cycle. This function can be selected consecutively a maximum of twice.











**Minute Minder**

This option activate the minute minder only when there are no other functions active. Keep pressing  until the  and «00:00» start flashing on the display, select and press ok to confirm. An down the selected audible signal will sound once the timer has finished counting.

**Oven functions table**

The oven has 5 cooking levels. Count up from the lower level.

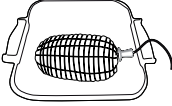
Function		Description of function
	<b>OFF</b>	For switching off the oven.
	<b>FORCED AIR</b>	For cooking different foods that require the same cooking temperature on several shelves (maximum three) at the same time. This function can be used to cook different foods without odours being transferred from one food to another.
	<b>CONVENTIONAL (Top and Bottom Heat)</b>	For cooking any kind of dish on one shelf only. It is best to use the 2nd or the 3rd shelf. Preheat the oven before insert the food.
	<b>CONVECTION BAKE</b>	To cook meat and pies with liquid filling (savoury or sweet) on a single shelf. Use the 2nd shelf. Preheat the oven before cooking.
	<b>MAXI COOKING</b>	To cook large joints of meat (above 2.5 kg). Use the 1st or 2nd shelf, depending on the size of the joint. It is advisable to turn the meat over during cooking for more even browning. It is best to baste the meat every now and again to avoid it drying out.
	<b>GRILL</b>	For grilling steaks, kebabs and sausages, cooking vegetables au gratin or toasting bread. It is best to use the 4th or 5th Shelf. When grilling meat, we recommend using a drip tray to collect the cooking juices: position the pan on the 3rd/4th level and add 500 ml of water. the oven door should be closed during cooking.
	<b>TURBOGRILL</b>	To roast large joints of meat (legs, roast beef, chickens). Position the food on the middle shelves. Use the drip tray to collect the cooking juices. Position it on the 1st/2nd shelf, adding approx. half a litre of water. The oven does not have to be preheated. During cooking the oven door must remain closed.
	<b>BREAD</b>	To bake different types and sizes of bread. Simply indicate the values required (temperature and time) and the oven will manage the cooking cycle automatically. Place the dough on the 2nd shelf.

Function		Description of function
	<b>PIZZA</b>	To bake different types and sizes of pizza. Simply indicate the values required (temperature and time) and the oven will manage the cooking cycle automatically. Place the dough on the 2nd shelf.
	<b>ECO FORCED AIR*</b>	To cook stuffed roasts and meat in pieces on one shelf. This function uses discontinuous, delicate fan assistance, which prevents excessive drying of foods. In this ECO function the light remains off during cooking and can be temporarily switched on again by pressing the confirm button. In order to maximize energy efficiency, it is advisable not to open the door during cooking. It is advisable to use 3rd level. The oven does not have to be preheated.
	<b>DEFROST</b>	To speed up defrosting of food. Place food on the middle shelf. Leave food in its packaging in order to prevent it from drying out on the outside.
	<b>WARM KEEPING</b>	For keeping just-cooked food hot and crisp (e.g: meat, fried food or flans). Place food on the middle shelf.
	<b>RISING</b>	For optimal rising of sweet or savoury dough. To safeguard the quality of proving, the function will not activate if the temperature in the oven is above 40°C. Place the dough on the 2nd shelf. The oven does not have to be preheated.
	<b>FAST PREHEAT</b>	To preheat the oven rapidly. At the end of the preheat the oven will select automatically the CONVENTIONAL function. Wait the end of the preheat before inserting the food inside the oven.
<b>- +</b>	<b>SETTINGS</b>	To set the display (Time, Light, Volumes of sounds, energy saving)
	<b>PYRO-CLEANING</b>	For eliminating cooking spatters using a cycle at a very high temperature (over 400 °C). The duration is automatically set to 120 minutes. Select ECO x 75minutes cycle in case of minor presence of dirt
	<b>MEAT PROBE</b>	<p>The meat probe supplied allows the exact temperature (up to 100°C) to be measured during cooking, to ensure optimum cooking.</p> <p>Based on the food being cooked, the required core temperature can be set. It is very important to position the probe accurately in order to obtain perfect cooking results. Insert the probe fully into the fleshiest part of the meat, avoiding bones and fatty parts (Fig. 1). For poultry, the probe should be inserted sideways, in the middle of the breast, taking care to ensure the tip does not end up in a hollow part (Fig. 2). In the case of meat with very irregular thickness, check it is cooked properly before removing it from the oven. Connect the end of the probe in the hole located on the left bottom part of the control panel</p> <div style="text-align: right;">  <p>FIG. 1</p>  <p>FIG. 2</p> </div>

























\*Function used as reference for the energy efficiency declaration in accordance with Regulation (EU) No. 65 / 2014







**IMPORTANT:**

During the self-clean cycle (pyrolysis) make sure to remove all the accessories supplied, to prevent any further increase in the outside temperature of the door and to ensure more efficient cleaning of the bottom part of the oven.









**IMPORTANT:** if the function selected is not matching the meat probe use, cooking will not start until the probe is removed. A following message is displayed: REMOVE PROBE

## Cooking tables

Type of food	Function	Preheating	Level (from the bottom)	Temperature (°C)	Cooking time (min)
SWEETS, PASTRY, ETC					
Leavened cakes		X	2/3	150-170	30-90
		X	1-4	160-180	30-90
Filled pies (cheesecake, strudel, fruit pie)		X	2	160-200	35-90
		X	2-4	160-200	40-90
Biscuits/tartlets		X	3	150-170	20-45
		X	2-4/5-3-1	150-170	20-45
Choux buns		X	3	180-200	30-40
		X	2-4	170-190	35-45
Meringues		X	2	90	150-200
		X	2-4/5-3-1	90	140-200
Bread		X	2	180-220	30-50
Pizza		X	2	220-250	15-30
Bread/pizza/ focaccia		X	2-4/5-3-1	190-250	20-40
Frozen pizza		X	2	250	10-30
		X	2-4	230-250	10-30
Savoury pies (vegetable pie, quiche)		X	2	180-200	30-50
		X	2-4/5-3-1	180-190	30-60
Vols-au-vent /Puff pastry crackers		X	2	190-200	20-30
		X	2-4/5-3-1	180-190	20-40
Lasagne, baked pasta, cannelloni, flans		X	2	190-200	45-65
Lasagna & Meat		X	2-4	200	50-100***
Meat & Potatoes		X	1-4	190-200	45-100***
Fish & Vegetables		X	1-4	180	30-50***
Complete meal Fruit tart (Level 5) / Lasagna (Level 3) / Meat (Level 1)		X	1-3-5	180-190	40-120***
Roast meat/stuffed roasting joints		-	2	180-200	100-150***

Type of food	Function	Preheating	Level (from the bottom)	Temperature (°C)	Cooking time (min)
<b>MEAT</b>					
<b>Meat pieces (rabbit, chicken, lamb)</b>		-	2	180-200	60-100***
<b>Roast pork with crackling 2 kg</b>		X	2	170-190	110-150
<b>Lamb/Veal/Beef/ Pork 1Kg</b>		X	2	190-200	80-120
<b>Chicken/Rabbit/ Duck 1Kg</b>		X	2	200-230	50-100
<b>Turkey/Goose 3Kg</b>		X	2	200-230	150-200
<b>FISH</b>					
<b>Baked fish/en papillote 0.5Kg (fillet, whole)</b>		X	2	170-190	30-50
<b>VEGETABLES</b>					
<b>Stuffed vegetables (tomatoes, courgettes, aubergines)</b>		X	2	180-200	50-70

**Cooking table with GRILL function**

Type of food	Function	Preheating	Level (from the bottom)	Temperature (°C)	Cooking time (min)
<b>Toast</b>		5'	5	3 (High)	1-3
<b>Fish fillets/slices</b>		5'	3/4	2 (Medium)	15-30*
<b>Sausages/kebabs/ spare ribs/ hamburgers</b>		5'	4/5	2-3 (Medium-High)	15-30*
<b>Leg of lamb/ knuckle</b>		-	3	2 (Medium)	60-90**
<b>Vegetable gratin</b>		-	3	3 (High)	10-25
<b>Roast potatoes</b>		-	3	2 (Medium)	35-60**
<b>Roast chicken 1-1.3 Kg</b>		-	2	2-3 (Medium-High)	55-80**
<b>Roast beef rare 1Kg</b>		-	3	2 (Medium)	35-50**

**Note:** cooking temperatures and times are for guidance only.

\* Turn food halfway through cooking

\*\* Turn food two-thirds of the way through cooking (if necessary).

\*\*\* Estimated length of time: dishes can be removed from the oven at different times depending on personal preference.

## Cleaning and maintenance

### CLEANING

#### **WARNING!**

- Never use steam cleaning equipment.
- Only clean the oven when it is cool to the touch.
- Disconnect the appliance from the power supply.

#### Oven exterior

 **IMPORTANT:** do not use corrosive or abrasive detergents. If any of these products accidentally comes into contact with the appliance, clean immediately with a damp cloth.

- Clean the surfaces with a damp cloth. If it is very dirty, add a few drops of washing up detergent to the water. Finish off with a dry cloth.

#### Oven interior

 **IMPORTANT:** do not use abrasive sponges or metallic scrapers or scourers. Over time, these can ruin enamelled surfaces and the oven door glass.

- After every use, allow the oven to cool then clean it preferably while it is still warm in order to remove built-up dirt and stains caused by food residues (e.g. food with a high sugar content).
- Use proper oven detergents and follow the manufacturer's instructions to the letter.
- Clean the door glass with a suitable liquid detergent. The oven door can be removed to facilitate cleaning (see MAINTENANCE). Inner glass is smooth to facilitate cleaning.

**NOTE:** during prolonged cooking of foods with a high water content (e.g. pizza, vegetables, etc.) condensation may form on the inside of the door and around the seal. When the oven is cold, dry the inside of the door with a cloth or sponge.

### Accessories

- Soak the accessories in water with washing up detergent immediately after use, handling them with oven gloves if still hot.
- Food residues can be easily removed using a brush or sponge.

### MAINTENANCE

#### **WARNING!**

- Use safety gloves.
- Ensure the oven is cold before carrying out the following operations.
- Disconnect the oven from the power supply.

#### To remove the shelf guides

firmly grip the external part of the guide, and pull it towards you to extract the support and the two internal pins from the lodging.

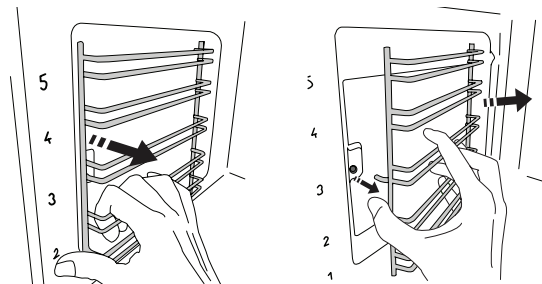

#### To reposition the shelf guides

position them near the cavity and initially insert the two pins into their lodgings. Next, position the external part near its lodging, insert the support, and firmly press towards the wall of the cavity to make sure the shelf guide is properly secured.

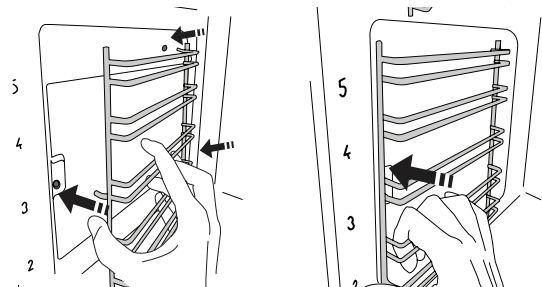

**To remove the door**

1. Open the door fully.
2. Lift the catches and push them forwards as far as they will go (Fig. 1).

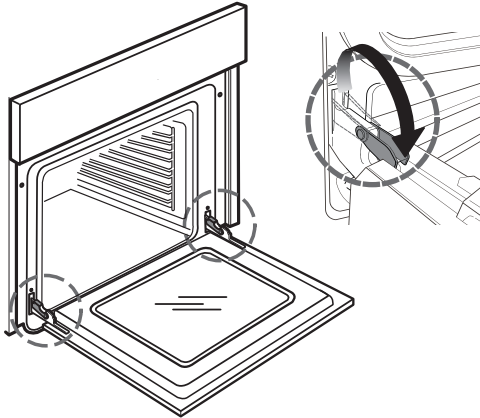

Fig. 1

3. Close the door as far as it will go (A), lift it up (B) and turn it (C) until it is released (D) (Fig. 2, 3, 4).

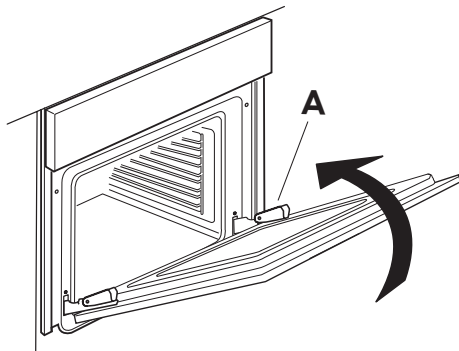

Fig. 2

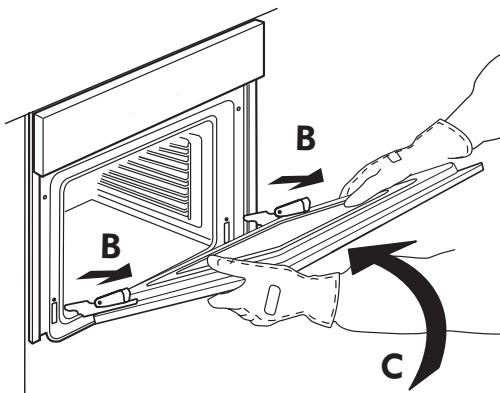

Fig. 3

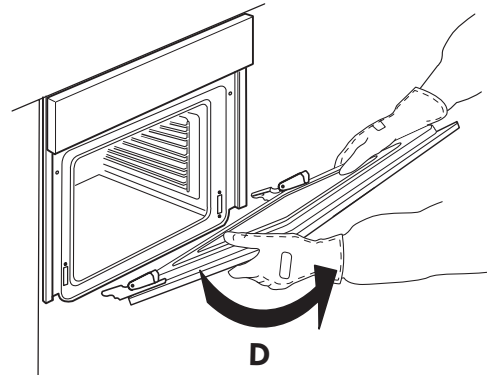

Fig. 4

**To refit the door**

1. Insert the hinges in their seats.
2. Open the door fully.
3. Lower the two catches.
4. Close the door

**Cleaning the glass**

1. After removing the door and resting it on a soft surface with the handle downwards, simultaneously press the two retaining clips and remove the upper edge of the door by pulling it towards you.

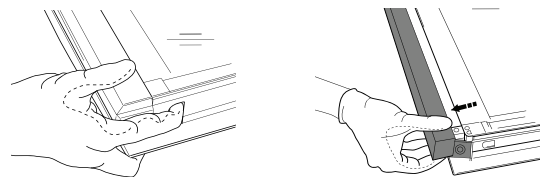

2. Lift and firmly hold the inner glass with both hands, remove it and place it on a soft surface before cleaning it. Do the same operation for the intermediate glass.
3. To reposition both the intermediate and the internal glass properly, be sure that the "R" can be seen in the left corner. First insert the long side of the glass indicated by "R" into the support seats, then lower it into position.

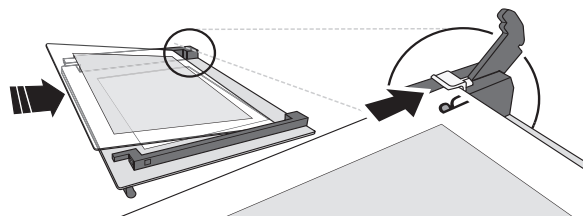



4. Refit the upper edge: A click will indicate correct positioning. Make sure the seal is secure before refitting the door.

**To replace the lamp**

1. Disconnect the oven from the power supply.

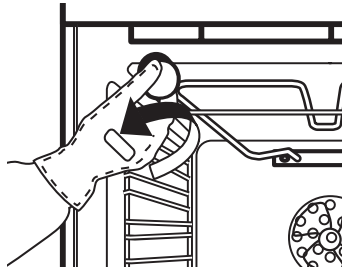

Fig. 5

2. Unscrew the lamp cover (Fig. 5), replace the lamp (see note for lamp type) and screw the lamp cover back on.
3. Reconnect the oven to the power supply.

**NOTE:**

- Only use 25W/230 V type G9, T300°C halogen lamps.
- The lamp used in the appliance is specifically designed for electrical appliances and it is not suitable for household room illumination (Commission Regulation (EC) No 244/2009).
- Lamps are available from IKEA Authorized Service Centre.

**What to do if ...**

Problem	Possible cause	Solution
The oven does not work.	No presence of mains electrical power.	Verify the presence of mains electrical power.
	The oven is not connected to the electrical supply.	Connect the oven to the power supply.
The display shows the letter "F" followed by a number	Software problem	Contact you nearest After-sales Service Centre and state the letter or number that follows the letter "F"

**Before calling the Authorized Service Centre:**

1. See if you can solve the problem yourself with the help of the suggestions given in the "What to do if ..." table.
2. Switch the appliance off and back on again it to see if the fault persists. If after the above checks the fault still occurs, contact IKEA Authorized Service Centre.

Always specify:

- a brief description of the fault;
- the type and exact model of the oven;

- the service number (number after the word Service on the rating plate), located on the right hand edge of the oven cavity (visible when the oven door is open);

**SERVICE** 0000 000 00000



- your full address;
- your telephone number.

If any repairs are required, please contact IKEA Authorized Service Centre (to guarantee that original spare parts will be used and repairs carried out correctly).



## Technical data

Type of product: Built-in Electrical Oven	
Model identification: ANRÄTTA 604.169.49	
Number of cavities	1
Heat source	Electrical
Number of functions	9
Usable volume. Measured with any side grids and catalytic panels removed l	71
Area of the largest baking sheet cm <sup>2</sup>	1191
Energy Efficiency Class (Lowest Consumption)	A+
Energy Efficiency Index	81,2
Energy consumption Conventional function (with a standard load and top + bottom heating) kWh/cycle	0,89
Energy consumption Fan Forced function (with a standard load and forced air heating) kWh/cycle	0,69
Top heating element W	2200
Bottom heating element W	1000
Grill heating element W	2200
Fan heating element W	1800
Cooling fan W	33
Oven lamp W	25
Oven Fan Wattage W	22
Total rating W	2450
Dimensions	
Width mm	595
Height mm	595
Depth mm	550
Mass of the appliance ANRÄTTA Kg	32,2

**Technical data**

The technical informations are situated in the rating plate inside the appliance.

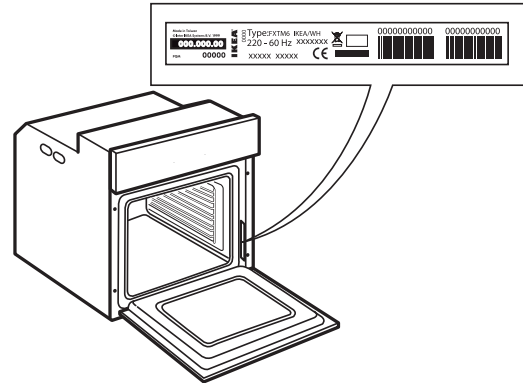

**Installation**

**Door lock device**

To open the door with the door lock device see Fig 1.

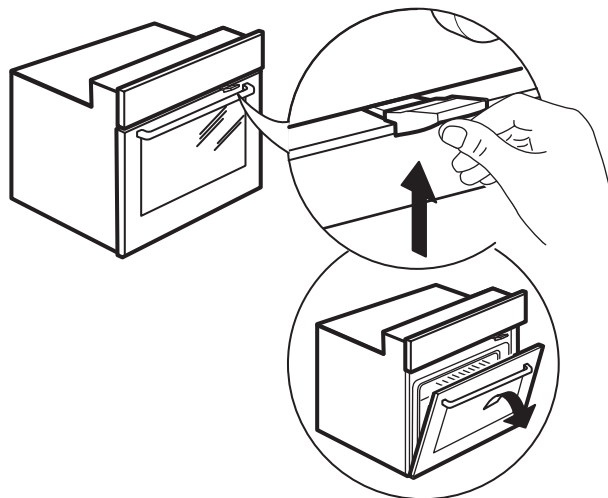

Fig. 1

The door safety device can be removed by following the sequence of images (see Fig. 2).

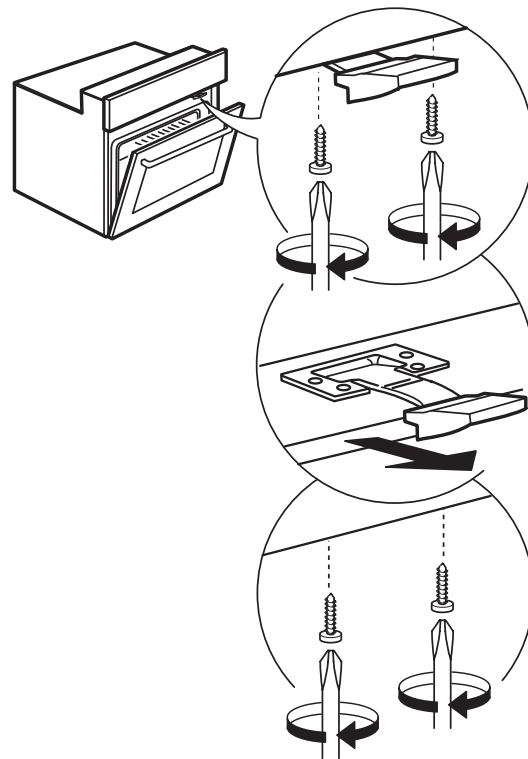

Fig. 2

## Electrical connection for Australia

Power Cord and Plug: Declared Article – Mandatory Approval Applies:

Current Australian Approval Certificates will need to be forwarded, showing compliance with applicable Australian Standards, as noted below. Plug to have insulated pins. Plug and Cord to have approval marking, as required by the relevant Approval Certificate

- AS/NZS 3112: 2004 with Amendment 1, for Plug
- AS 3191: 2008, for Cord, or;
- 'HAR' Certification, for Cord

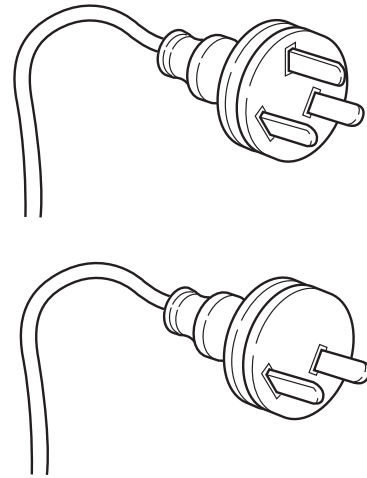

## Environmental concerns

**⚠ WARNING!** Ensure that the appliance is switched off and disconnected from the power supply before performing any maintenance operation - risk of electrical shock. Never use steam cleaning equipment.

**⚠** Do not use harsh abrasive cleaners or metal scrapers to clean the door glass since they can scratch the surface, which may result in shattering of the glass.

**⚠** Ensure the appliance is cooled down before any cleaning or maintenance. - risk of burn.

**⚠ WARNING!** Switch off the appliance before replacing the lamp - risk of electrical shock.

### DISPOSAL OF PACKAGING MATERIALS

The packaging material is 100% recyclable and is marked with the recycle symbol.  The various parts of the packaging must therefore be disposed of responsibly and in full compliance with local authority regulations governing waste disposal.

### SCRAPPING OF HOUSEHOLD APPLIANCES

This appliance is manufactured with recyclable or reusable materials. Dispose of it in accordance with local waste disposal regulations. For further information on the treatment, recovery and recycling of household electrical appliances, contact your local authority, the collection service for household waste or the store where you purchased the appliance. This appliance is marked in compliance with European Directive 2012/19/EU, Waste Electrical and Electronic Equipment (WEEE). By ensuring this product is disposed of correctly, you will help prevent negative consequences for the environment and human health.



The symbol  on the product or on the accompanying documentation indicates that it should not be treated as domestic waste but must be taken to an appropriate collection center for the recycling of electrical and electronic equipment.

### ENERGY SAVING TIPS

Only preheat the oven if specified in the cooking table or your recipe. Use dark lacquered or enamelled baking trays as they absorb heat better. Food requiring prolonged cooking will continue to cook even once the oven is switched off.

## IKEA GUARANTEE

### How long is the IKEA guarantee valid?

This guarantee is valid for five years from the original date of purchase of your appliance at IKEA Pty Ltd, ABN 84 006 270 757 or at Cebas Pty Ltd, ABN 15 009 156 003. The original sales receipt, is required as proof of purchase. If service work is carried out under guarantee, this will not extend the guarantee period for the appliance.

### Who will execute the service?

IKEA Authorized Service Centre will provide the service through its own service operations or Authorized Service Centre network.

Contact IKEA for further information.

- If you encounter any trouble with the appliance and wish to register a service call or make a claim, please refer to [www.ikea.com.au](http://www.ikea.com.au) for your local store aftersales customer service center phone number, online email and opening times or refer to the phone numbers shown below.

### The principal address and contact details in Australia are:

IKEA Authorized Service Centre at [www.IKEA.com.au](http://www.IKEA.com.au) or

- For Queensland, New South Wales and Victorian customers please contact:

#### **IKEA Pty Ltd**

IKEA Service Office L1 Clock Tower, 630 Princes Highway Tempe, NSW 2044

Victoria: (03) 8523 2154

New South Wales: (02) 8020 6641

Queensland: (07) 3380 6800

IKEA Perth: (08) 9201 4532

IKEA Adelaide: (08) 8154 4532

- For Western Australian and South Australian customers please contact:

#### **Cebas Pty Ltd**

8c Sunray Drive,  
Innaloo WA 6018 Australian  
IKEA Perth: (08) 9201 4532

IKEA Adelaide: (08)8154 4532

### What does this guarantee cover?

The guarantee covers applicable faults of the appliance, which have been caused by faulty construction or material faults from the date of purchase from IKEA. This guarantee applies to domestic use only. The products have been designed and tested for domestic purposes only and this guarantee does not cover damage arising from use of the Product in a commercial environment. The exceptions are specified under the headline "What is not covered under this guarantee?" Within the guarantee period, the costs to remedy the fault e.g. repairs, parts, labour and travel will be covered, provided that the appliance is accessible for repair without special expenditure. Replaced parts become the property of IKEA.

The guarantee exists only if the appliance complies and is installed in accordance with:

- The technical specifications.
- The Assembly Instructions and user manual Safety Information.

IKEA's guarantee is subject to Australian Consumer Law - see Schedule 2 to Competition and Consumer Act, 2010. This guarantee is in addition to (and does not exclude, restrict or modify in any way) any non-excludable statutory warranties in Australia.

### What will IKEA do to correct the problem?

IKEA appointed service provider will examine the product and decide, at its sole discretion, if it is covered under this guarantee. If considered covered, IKEA service provider or its authorized service partner through its own service operations, will then, at its sole discretion, either repair the defective product or replace it with the same or a comparable product.

### What is not covered under this guarantee?

- What is not covered under this guarantee?
- Normal wear and tear.
- Deliberate or negligent damage, damage caused by failure to

- observe operating and maintenance instructions, incorrect installation or by connection to the wrong voltage, damage caused by chemical or electrochemical reaction, rust, abrasion or scratching, corrosion or water damage including but not limited to damage caused by excessive lime in the water supply, damage caused by abnormal environmental conditions.
- Damage caused from the use of the appliance in a manner other than the use for which it was specifically designed.
  - Damage caused by power outages, electrical power surge or improper supply voltage via connection to Supply Authority mains or alternative supply systems.
  - Consumable parts including batteries and lamps, removable wire, glass and plastic trays and other accessories.
  - Internal or external damage as a result of excessive use of cleaning products or cleaning agents.
  - Non-functional and decorative parts which do not affect normal use of the appliance, including any scratches and possible color differences.
  - Accidental damage or blockages caused by foreign objects, eg. coins, underwires, nails, buttons or jewellery, or substances and cleaning or unblocking of filters, drainage systems or soap drawers
  - Damage caused by vermin, insects or pets.
  - Note – internal or external cabinet transport damage must be reported within 7 days of purchase date.
  - Damage to the following parts: ceramic glass, accessories, crockery and cutlery baskets, feed and drainage pipes, seals, lamps and lamp covers, screens, knobs, casings and parts of casings. Unless such damages can be proved to have been caused by production faults.
  - Cases where no fault could be found during a technician's visit.
  - Any consequential loss due to appliance failure.
- Repairs not carried out by our appointed service providers and/or an authorized service contractual partner or where non-original parts have been used.
  - Repairs to parts or systems caused by unauthorized modifications made to appliance.
  - Repairs caused by installation which is faulty or not according to specification.
  - Problems caused by incorrect or inadequate venting of the appliance.
  - The use of the appliance in a non-domestic environment i.e. professional use.
  - Transportation damages. If a customer transports the product to his home or another address, IKEA is not liable for any damage that may occur during transport. However, if IKEA delivers the product to the customer's delivery address, then damage to the product that occurs during this delivery will be covered by IKEA.
  - Cost for carrying out the initial installation of the IKEA appliance. However, if an IKEA appointed Authorized Service Centre or its authorized service partner repairs or replaces the appliance under the terms of this guarantee, the Authorized Service Centre or its authorized service partner will reinstall the repaired appliance or install the replacement, if necessary.
  - The benefits conferred by this express warranty are in addition to all other conditions, warranties, guarantees, rights and remedies expressed or implied by the Trade Practices Act and similar State and Territory laws and all other obligations and liabilities on the part of the manufacturer or supplier and nothing contained herein shall restrict or modify such rights, remedies, obligations or liabilities.
- How country law applies?**  
Our goods come with guarantees that cannot be excluded under the Australian Consumer Law (ACL).

You are entitled to a replacement or refund for a major failure and for compensation for any other reasonably foreseeable loss or damage.

You are also entitled to have the goods repaired or replaced if the goods fail to be of acceptable quality and the failure does not amount to a major failure.

This guarantee is not intended in any way to limit or exclude such rights and remedies that you may have under law.

You can find out more information about the Australian Consumer Law on the ACCC website: [www.accc.gov.au](http://www.accc.gov.au)

### Area of validity

The IKEA guarantee applies only to products purchased and installed in AUSTRALIA .

### What you must do to make a claim under the guarantee

To make a claim under the guarantee contact IKEA Authorized Service Centre at the above address, the IKEA catalogue or refer to [www.ikea.com.au](http://www.ikea.com.au) for your local store customer service phone number, online email and opening times. Please describe the problem that you are facing with the appliance in detail along with your product article number (8 digit code) and date of purchase at the time of call registration.

### Please do not hesitate to contact the dedicated Authorized Service Centre for IKEA appliances to:

1. Make a service request under this guarantee.
2. Ask for clarification on installation of the IKEA appliance in the dedicated IKEA kitchen furniture.
3. Ask for clarification on user manual contents and specifications of the IKEA appliance.

To ensure that we provide you with the best assistance, please read carefully the Assembly Instructions and/or the User Manual section of this booklet before contacting us.

### How to reach if you need our service

The IKEA Authorized Service Centre will assist you on the phone with basic trouble shooting for your appliance at the time of warranty call registration.

Please refer to the IKEA catalogue or [www.ikea.com.au](http://www.ikea.com.au) or to below phone numbers and select your local store .



Victoria: (03) 8523 2154  
 New South Wales: (02) 8020 6641  
 Queensland: (07) 3380 6800  
 IKEA Perth: (08) 9201 4532  
 IKEA Adelaide: (08) 8154 4532u

**Please describe the problem that you are facing with the appliance in detail along with your product model number, serial number, date of purchase at the time of call registration.**

**Please also always refer to the IKEA article number (8 digit code) and 12 digit service number placed on the rating plate of your appliance.**



### SAVE THE SALES RECEIPT!

**Kindly keep all these details and original invoice of purchase handy during the service technician's visit to enable him to carry out the job. It is your proof of purchase and required for the guarantee to apply.**



400011234418



23256

AA-2096734-1

© Inter IKEA Systems B.V. 2018