



SHARP

OPERATION MANUAL



R-270 MICROWAVE OVEN

800W (IEC 60705)



OPERATION MANUAL

This operation manual contains important information which you should read carefully before using your microwave oven.

IMPORTANT: There may be a serious risk to health if this operation manual is not followed or if the oven is modified so that it operates with the door open.

If you require any advice or assistance regarding your Sharp product, please visit our website:

<http://www.sharp.co.uk/support>

Customers without Internet access may telephone (during office hours):

0845 888 8112

or from Ireland

(01) 676 0648



Attention:

Your product is marked with this symbol.

It means that used electrical and electronic products should not be mixed with general household waste. There is a separate collection system for these products.

A. Information on Disposal for Users (private households)

1. In the European Union

Attention: If you want to dispose of this equipment, please do not use the ordinary dust bin! Used electrical and electronic equipment must be treated separately and in accordance with legislation that requires proper treatment, recovery and recycling of used electrical and electronic equipment.

Following the implementation by member states, private households within the EU states may return their used electrical and electronic equipment to designated collection facilities free of charge*.

In some countries* your local retailer may also take back your old product free of charge if you purchase a similar new one.

*) Please contact your local authority for further details.

If your used electrical or electronic equipment has batteries or accumulators, please dispose of these separately beforehand according to local requirements.

By disposing of this product correctly you will help ensure that the waste undergoes the necessary treatment, recovery and recycling and thus prevent potential negative effects on the environment and human health which could otherwise arise due to inappropriate waste handling.

2. In other Countries outside the EU

If you wish to discard this product, please contact your local authorities and ask for the correct method of disposal.

For Switzerland: Used electrical or electronic equipment can be returned free of charge to the dealer, even if you don't purchase a new product. Further collection facilities are listed on the homepage of www.swico.ch or www.sens.ch.

B. Information on Disposal for Business Users

1. In the European Union

If the product is used for business purposes and you want to discard it:

Please contact your SHARP dealer who will inform you about the take-back of the product. You might be charged for the costs arising from take-back and recycling. Small products (and small amounts) might be taken back by your local collection facilities.

For Spain: Please contact the established collection system or your local authority for take-back of your used products.

2. In other Countries outside the EU

If you wish to discard of this product, please contact your local authorities and ask for the correct method of disposal.





CONTENTS

OVEN AND ACCESSORIES	2
CONTROL PANEL	3
SAFETY:	
Installation	4 - 5
Important Safety Instructions	5
OPERATION:	
Maff Heating Category	6
How Your Oven Works	6
Microwave Power Levels	7
Before Operation	7
How to Operate Your Oven	8 - 9
Auto Weight Cook / Defrost	10
Auto Weight Cook Chart	11
Speed Defrost	12
Auto Cook	12
Auto Cook Chart	13
Convenient Functions	14 - 16
COOKING ADVICE:	
Microwave Cooking Advice	17 - 18
Suitable Cookware	19
Defrosting Advice	20
Reheating Advice	21
AFTERCARE:	
Cleaning & Maintenance	22
Troubleshooting	23
To Replace the Mains Plug	24
Calling for Service	24
GUARANTEE	25
SPECIFICATIONS	26



OVEN AND ACCESSORIES

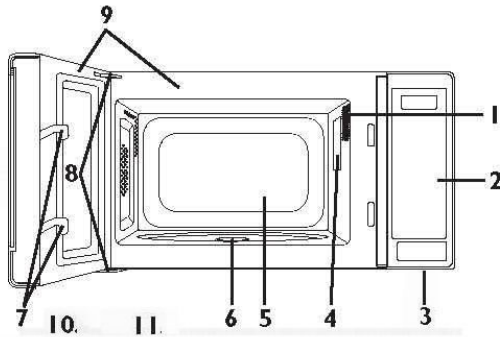

OVEN:

1. Oven lamp
2. Control panel
3. Door opening button
4. Waveguide cover (DO NOT REMOVE)
5. Oven cavity
6. Coupling
7. Door latches
8. Door hinges
9. Door seals and sealing surfaces
10. Power cord
11. Ventilation openings
12. Outer cabinet

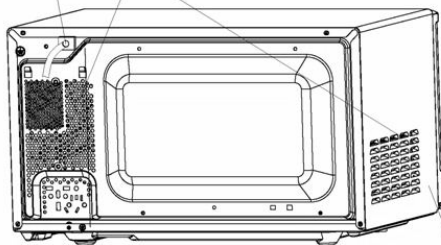

12.

ACCESSORIES:

Check to make sure the following accessories are provided:

13. Turntable
14. Roller stay

- Place the roller stay in the coupling on the oven floor, then place the turntable on to the roller stay, ensuring it is located firmly.
- To avoid turntable damage, ensure dishes or containers are lifted clear of the turntable rim when removing them from the oven.

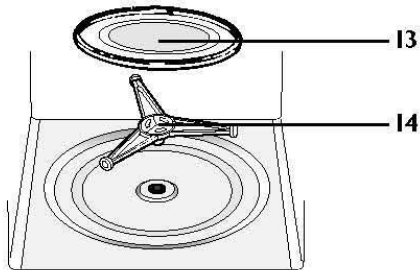

NOTES:

- The waveguide cover is fragile. Care should be taken when cleaning inside the oven to ensure that it is not damaged.
- Always operate the oven with the turntable and roller stay fitted correctly. This promotes thorough, even cooking. A badly fitted turntable may rattle, may not rotate properly and could cause damage to the oven.
- The turntable rotates clockwise or anti-clockwise. The rotary direction may change each time you start the oven. This does not affect cooking performance.
- When you order accessories, please quote both the **PART NAME** and **MODEL NUMBER** to your dealer or SHARP approved service facility.



WARNING:

The door, outer cabinet, oven cavity, turntable and dishes will become very hot during operation. To prevent burns, always use thick oven gloves.





CONTROL PANEL

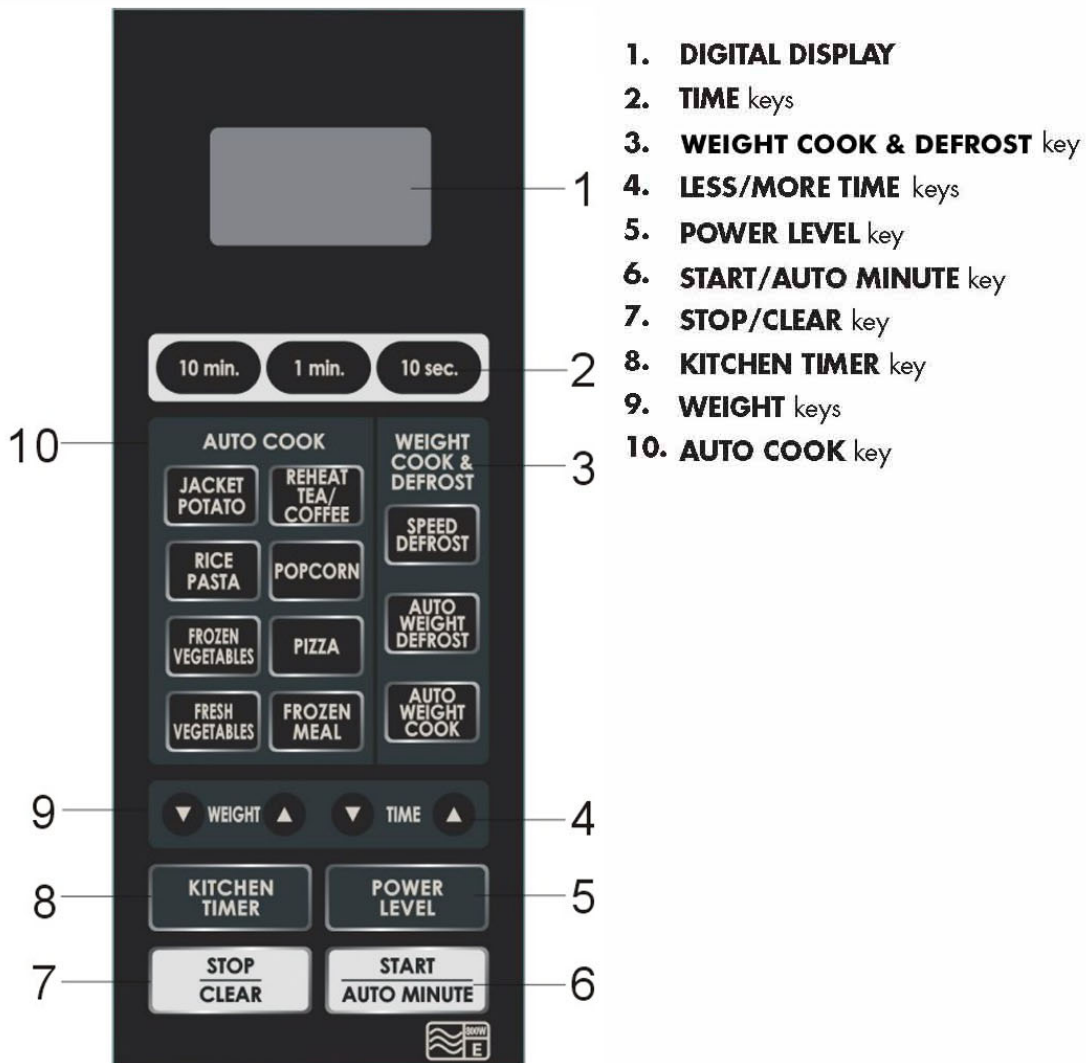



INSTALLATION



WARNING:

Inspect the Oven:

- Check the oven carefully for damage before and regularly after installation.
- Make sure the door closes properly, that it is not misaligned or warped.
- Check the hinges and door safety latches are not broken or loose.
- Ensure the door seal and sealing surfaces are not damaged. If the door or door seals are damaged, the oven must not be operated until it has been repaired by a competent person.
- Inspect the oven interior and door for dents.

IMPORTANT:

If any damage is apparent, do not operate the oven in any way, until it has been repaired by a SHARP trained engineer.

5. Make sure the power supply cord is undamaged (See "ELECTRICAL CONNECTION" below).
Do not allow the power supply cord to run over any hot or sharp surfaces, such as the hot air vent area at the top rear of the oven.
6. The socket must be readily accessible so that it can be easily unplugged in an emergency.
7. Do not use the oven outdoors.

BUILDING-IN-KIT.

No built-in kit is available for this oven.

This oven is designed to be used on a countertop only.

ELECTRICAL CONNECTION.

- Do not allow water to come into contact with the power supply cord or plug.
- Insert the plug properly into the socket.
- Do not connect other appliances to the same socket using an adaptor plug.
- If the power supply cord is damaged, it must be replaced by a Sharp approved service facility or a similarly qualified person to avoid a hazard.
- When removing the plug from the socket always grip the plug, never the cord as this may damage the power supply cord and the connections inside the plug.
- If the plug fitted to your oven is a rewirable type and in the event of the socket outlet in your home not being compatible with the plug supplied, remove the plug properly (do not cut off).
- If the plug fitted to your oven is a non-rewirable type and in the event of the socket outlet in your home not being compatible with the plug supplied, cut-off the mains plug.
- Refit with a suitable type, observing the wiring code given in 'To replace the mains plug' on page 24.

1. Remove all packing materials including the feature sticker (if applicable). Do not remove the plastic film from the inside of the oven window as this protects it from dirt. The waveguide cover prevents food and grease from entering the waveguide area where it could cause damage. **DO NOT REMOVE THE WAVEGUIDE COVER.**
2. Place oven on a secure, level surface. Ensure it is strong enough to take the oven weight, plus the heaviest item likely to be cooked in the oven.
3. The minimum height of free space necessary above the top surface of the oven is 15cm.
4. Do not place the oven where heat, moisture or high humidity are generated, (for example, near or above a conventional oven) or near combustible materials (for example, curtains). Do not block or obstruct air vent openings. Do not place objects on top of the oven.



INSTALLATION

IMPORTANT!

- The fuse from the cut-off plug should be removed and the plug disposed of in a safe manner.
- Under no circumstances should the cut-off plug be inserted into a socket outlet as a serious electric shock may occur.
- The plug must not be used without the fuse cover fitted.
- If you have any doubt about your microwave oven obtain the help of a qualified electrician.
- When replacing the plug please ensure that you use a BSI or ASTA approved plug to BS1363, this should be fitted with a brown coloured 13 amp fuse approved by BSI or ASTA to BS1362. If you have any doubt about electrical connection seek the help of a qualified electrician.



WARNING: THIS APPLIANCE MUST BE EARTHED

To wire an appropriate plug, follow the wiring code given in 'To replace the mains plug' on page 24.

IMPORTANT SAFETY INSTRUCTIONS

PLEASE READ CAREFULLY AND KEEP FOR FUTURE REFERENCE

Oven Use:

- The oven is for domestic food use only.
- Never operate the oven when empty.
- Do not leave or store anything inside the oven when not in use.
- Never attempt to use the oven with the door open. It is important not to force or tamper with the door safety latches.
- Never operate the oven with any object caught in the door.
- Do not insert fingers or objects in the holes of the door latches or air-vent openings as this may damage the oven and cause an electric shock.
- If water or food drops inside the air vent openings switch off the oven immediately, unplug it and call a SHARP approved service facility. (See page 24).
- Never move the oven while it is operating.

Pacemaker: If you have a heart pacemaker, consult your doctor or the pacemaker manufacturer prior to oven use.

WARNING: Only allow children to use the oven without supervision when adequate instructions have been given so that the child is able to use the oven in a safe way and understands the hazards of improper use. This appliance is not intended for use by persons (including children) with reduced physical, sensory or mental capabilities, or lack of experience and knowledge, unless they have been given supervision or instruction concerning use of the appliance by a person responsible for their safety. Children should be supervised to ensure that they do not play with the appliance.

WARNING: Liquids and other foods must not be heated in sealed containers since they are liable to explode. Microwave heating of beverages can result in delayed eruptive boiling, therefore care has to be taken when handling the container. Stir the liquid prior to and during heating/ reheating, let liquid stand for at least 20 seconds in the oven after cooking.

FIRE: If smoke is observed, switch off and unplug the appliance and keep the door closed in order to stifle any flames.



MAFF HEATING CATEGORY

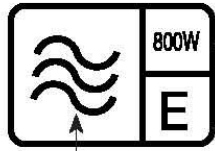

Microwave Symbol.

Microwave output power in Watts (based on international (IEC 60705) standard).
Letter representing the oven heating category.

The heating category (a letter A to E) developed by MAFF (Ministry of Agriculture, Fisheries and Food) with microwave oven and food manufacturers indicates the ability of the oven to heat small quantities of food (up to 500g [1 lb 2oz]). It does not represent the general performance of the oven.

OVEN OUTPUT POWER	<p>Less heating time required →</p> <p>600 700 800 900 1000 Watts</p> <p>← More heating time required</p>
OVEN OUTPUT CATEGORY	<p>Less heating time required →</p> <p>A B C D E</p> <p>← More heating time required</p>

Food packs carry cooking instructions for heating categories A to E. Follow instructions for the letter corresponding to the oven's heating category. The higher the output power and heating category of the oven the less heating time is required as shown opposite.

HOW YOUR OVEN WORKS

Microwaves are energy waves, similar to those used for TV and radio signals.

Electrical energy is converted into microwave energy, which is directed into the oven cavity via a waveguide. To prevent food and grease entering the wave guide it is protected by the waveguide cover.

Microwaves cannot pass through metal, because of this the oven cavity is made of metal and there is a fine metal mesh on the door.

During cooking the microwaves bounce off the sides of the oven cavity at random.

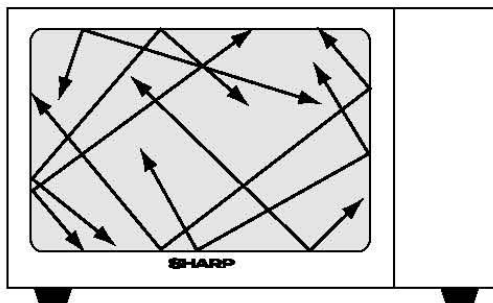

Microwaves will pass through certain materials, such as glass and plastic, to heat the food. (See "Suitable Cookware" on page 19).

Water, sugar and fat in food absorb microwaves which cause them to vibrate. This creates heat by friction, in the same way your hands get warm when you rub them together.

The outer areas of the food are heated by the microwave energy, then the heat moves to the centre by conduction, as it does in conventional cooking. It is important to turn, rearrange or stir food to ensure even heating.

Once cooking is complete, the oven automatically stops producing microwaves.

Standing time is necessary after cooking, as it enables the heat to disperse equally throughout the food.



MICROWAVE POWER LEVELS

Power Level	Press the POWER LEVEL key	Percentage
HIGH	X1	P100
	X2	P90
MEDIUM HIGH	X3	P80
	X4	P70
MEDIUM	X5	P60
	X6	P50
MEDIUM LOW (Defrost)	X7	P40
	X8	P30
LOW (Defrost)	X9	P20
	X10	P10

IMPORTANT: The microwave power level will default to 100P unless you press the **POWER LEVEL** key.

- Your oven has 10 power levels, as shown.
- To change the power level for cooking, enter the required time and then press the **POWER LEVEL** key until the display indicates the desired level.

• Power level

The microwave power level is varied by the microwave energy switching on and off. When using power levels other than P100 you will be able to hear the microwave energy pulsing on and off as the food cooks or defrosts.

• Check the power level

To check the microwave power level during cooking, press the **POWER LEVEL** key. As long as your finger is pressing the **POWER LEVEL** key the power level will be displayed. The oven continues to count down although the display will show the power level.

Generally the following recommendations apply:
P100/90-(HIGH output = 800/720W) used for fast cooking or reheating e.g. for casseroles, hot beverages, vegetables etc.

P80/70-(MEDIUM HIGH output = 640/560W) used for longer cooking of dense foods such as roast joints, meat loaf and plated meals, also for sensitive dishes such as sponge cakes. At this reduced setting, the food will cook evenly without over cooking at the sides.

P60/50-(MEDIUM output = 480/400W) for dense foods which require a long cooking time when cooked conventionally, eg. beef casserole, it is advisable to use this power setting to ensure the meat will be tender.

P40/30-(MEDIUM LOW output = 320/240W Defrost setting) to defrost, select this power setting, to ensure that the dish defrosts evenly. This setting is also ideal for simmering rice, pasta, dumplings and cooking egg custard.

P20/10-(LOW output = 160/80W) For gentle defrosting, eg. cream gateaux or pastry.

BEFORE OPERATION

Plug in the oven.

I. The oven display will show:



NOTE: Please note that this model does NOT have a clock function.





HOW TO OPERATE YOUR OVEN

Opening the door:

To open the oven door, push the door opening button.

Starting the oven:

Prepare and place food in a suitable container onto the turntable or place directly onto the turntable. Close the door and press the **START/AUTO MINUTE** key.



Stopping the oven:

If you want to stop the oven during cooking press the **STOP/CLEAR** key once or open the oven door. If you want to cancel the cooking programme, press the **STOP/CLEAR** key twice.



Your oven enables you to cook and defrost food using the automatic programmes, or to cook and defrost food manually.

Automatic cooking and defrosting allows you to cook and defrost using preset programmes where the timings have been calculated for you, e.g. **AUTO WEIGHT COOK**, **SPEED DEFROST**, **AUTO WEIGHT DEFROST**.

Manual cooking and defrosting allows you to cook/defrost foods and weights which are not included in the automatic programmes.

Following are examples of manual cooking and defrosting.

For automatic cooking and defrosting refer to pages 11 - 13.

MANUAL COOKING

- Enter the cooking time and use microwave power levels P10 to P100 to cook (refer to page 7).
- Stir or turn the food, where possible, 2 - 3 times during cooking.
- After cooking, cover the food and leave to stand, where recommended.

Example:

To cook for 2 minutes and 30 seconds on P70 microwave power:

1. Input the power level by pressing the **POWER LEVEL** key 4 times for P70.
2. Enter the cooking time by pressing the **1 MIN** key twice and then the **10 SEC** key 3 times.
3. Press the **START/AUTO MINUTE** key once to start cooking.

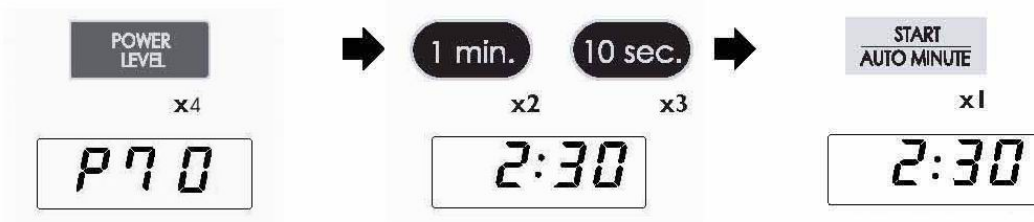

The display will count down through the set cooking time.





HOW TO OPERATE YOUR OVEN

MANUAL DEFROSTING

- Enter the defrosting time and use microwave power levels P10 or P30 to defrost (refer to page 7).
- Stir or turn the food, where possible, 2 - 3 times during defrosting.
- After defrosting, cover the food in foil and leave to stand until thoroughly defrosted.

Example:

To defrost for 10 minutes on P30 microwave power:

1. Input the power level by pressing the **POWER LEVEL** key 8 times.
2. Enter the defrosting time by pressing the **10 MIN.** key once.
3. Press the **START/AUTO MINUTE** key once to start defrosting.



The display will count down through the cooking time.

NOTES:

- When the oven starts, the oven lamp will light and the turntable will rotate clockwise or anti-clockwise.
- Your oven can be programmed up to 99 minutes, 90 seconds (99.90).
- When the door is opened during cooking, the cooking time on the display stops automatically. The cooking time starts to count down again when the door is closed and the **START/AUTO MINUTE** key is pressed.
- If you wish to know the power level during cooking, press the **POWER LEVEL** key. As long as your finger is touching the key the power level will be displayed.



AUTO WEIGHT COOK / DEFROST

AUTO WEIGHT COOK / DEFROST enables you to cook or defrost pre-programmed meals listed. Follow the example below for details on how to operate these functions.

AUTO WEIGHT COOK allows you to cook 3 popular menus.

When cooking beef, press the AUTO WEIGHT COOK key x1 **COO1** will appear on the display.

When cooking lamb, press the AUTO WEIGHT COOK key x2 **COO2** will appear on the display.

When cooking pork, press the AUTO WEIGHT COOK key x3 **COO3** will appear on the display.

Example 1: To cook beef weighing 1.2kg from chilled using AUTO WEIGHT COOK.

1. Press the AUTO WEIGHT COOK key once.
2. Enter the weight by pressing the **WEIGHT** keys until the desired weight is displayed.
3. Press the **START/AUTO MINUTE** key once to start cooking.



The display will count down through the cooking time.

Example 2: To defrost a Meat Joint weighing 1.2kg using AUTO WEIGHT DEFROST.

1. Select the menu required by pressing the AUTO WEIGHT DEFROST key once.
2. Enter the weight by pressing the **WEIGHT** keys until the desired weight is displayed.
3. Press the **START/AUTO MINUTE** key once to start defrosting.



The display will count down through the defrosting time.



AUTO WEIGHT COOK CHART



WEIGHT RANGE:

- Food weight should be rounded up or down to the nearest 0.1 kg, for example, 0.65kg to 0.7kg or 0.34kg to 0.3kg.
- You are restricted to enter a weight within the range (see the following charts).

NOTES:

- When action is required (example, to turn food over), the oven stops, the audible signals sound, the remaining cooking time and an indicator will flash on the display. To continue cooking, press the **START/AUTO MINUTE** key.
- The final temperature will vary according to the initial food temperature. Check food is piping hot after cooking. If necessary, you can extend the cooking manually.

AUTO WEIGHT COOK

MENU	WEIGHT RANGE	COOKING PROCEDURE
Roast Beef 	0.1kg - 2.0kg	<ul style="list-style-type: none"> • Place meat in a flan dish on the turntable. • Turn meat over when the audible signal sounds. • After cooking, leave meat to stand wrapped in aluminium foil for 10 minutes.
Roast Lamb 	0.1kg - 2.0kg	<ul style="list-style-type: none"> • Place meat in a flan dish on the turntable. • Turn meat over when the audible signal sounds. • After cooking, leave meat to stand wrapped in aluminium foil for 10 minutes.
Roast Pork 	0.1kg - 2.0kg	<ul style="list-style-type: none"> • Place meat in a flan dish on the turntable. • Turn meat over when the audible signal sounds. • After cooking, leave meat to stand wrapped in aluminium foil for 10 minutes.

SPEED DEFROST

This function quickly defrosts food while enabling you to choose a suitable defrost period, depending on the food type. Follow the example below for details on how to operate this function.

Example: To defrost the food for 10 minutes.

1. Select the menu required by pressing the **SPEED DEFROST** key once.
2. Enter the cooking time by pressing the **10 MIN** key once.
3. Press the **START/AUTO MINUTE** key start cooking.



NOTE: During the defrosting process the system will pause and bleep to remind you to turn the food over to ensure even defrosting. When this is complete, press START/AUTO MINUTE pad to resume defrosting.

AUTO COOK

AUTO COOK enables you to cook foods listed on the control panel and the chart on page 13. Follow the example below for details on how to operate this function.



Example: To cook 0.3kg Rice using Auto Cook RICE PASTA.

1. Select the menu required by pressing the **RICE PASTA** key once.
2. Enter the weight by pressing the **WEIGHT** keys until the desired weight is displayed.
3. Press the **START/AUTO MINUTE** key to start cooking.





AUTO COOK CHART

SELECTING MENU: You can select the Menu directly on the Key Sheet by pressing the relevant key.

Auto cook menus:

Food	Note
Jacket Potato (each 230g)	1. For beverage and potatoes, parameters on display are not weight but number of servings.
Reheat tea/Coffee (200ml /cup)	
Rice Pasta (g)	2. For Popcorn, touch POPCORN pad once to cook 100g popcorn, touch START/AUTO MINUTE to start; if the default cooking time for 100g popcorn is not suitable, just touch POPCORN pad twice, and touch number pads to enter a suitable cooking time, touch START/AUTO MINUTE to start.
Popcorn (default, 100g)	
Frozen Vegetable (g)	3. For Rice Pasta and Frozen Meal, during cooking, the system will pause and sound beeps to remind user to take operation, then touch START/AUTO MINUTE to resume cooking.
Pizza (g)	
Fresh Vegetable (g)	
Frozen Meal (g)	

WEIGHT RANGE:

- Food weight should be rounded up or down to the nearest 0.1 kg, for example, 0.65kg to 0.7kg or 0.34kg to 0.3kg.

NOTES:

- If there is a requirement to stir the food during the auto cook process the oven will stop and the audio signal will sound, at the same time the remaining cook time will show on the display. To continue cooking once the food has been stirred press the START / AUTO MINUTE key.
- The final temperature will vary according to the initial food temperature. Check food is piping hot after cooking. If necessary, you can extend the cooking manually.
- The results when using auto cook depend on variances such as the shape and size of the food and your personal preference as regards cooking results. If you are not satisfied with the programmed result, please adjust the cooking time to match your requirement.



CONVENIENT FUNCTIONS

I. SEQUENCE COOKING:

This function enables continued and uninterrupted operation for 2 different stages.

Example:

To cook for: 5 minutes on P100 power (Stage 1)
16 minutes on P30 power (Stage 2)

STAGE 1

1. Input the power level by pressing the **POWER LEVEL** key once.
2. Enter the cooking time by pressing the **1 MIN** key 5 times.

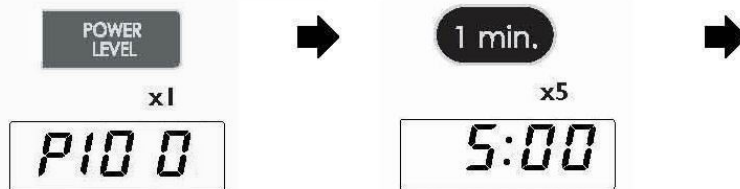

STAGE 2

3. Input the power level by pressing the **POWER LEVEL** key 8 times.
4. Enter the cooking time by pressing the **10 MIN** key once and then the **1 MIN** key 6 times.
5. Press the **START/AUTO MINUTE** key once to start.



The oven will begin to cook for 5 minutes on P100 and then for 16 minutes on P30.

NOTE: If P100 is selected as the final power level, it is not necessary to input the power level.

2. AUTO MINUTE:

AUTO MINUTE enables you:

- To cook on P100 microwave power in multiples of 1 minute.
- To extend the cooking times in multiples of 1 minute when using manual cook mode.

Example: To cook on P100 for 2 minutes, press the **START/AUTO MINUTE** key twice.

NOTE:

- The cooking time may be extended to a maximum of 99 minutes.

Example:





CONVENIENT FUNCTIONS

3. LESS (▼) and MORE (▲) TIME:

The **LESS (▼) TIME** and **MORE (▲) TIME** keys enable you to:

- Decrease or increase cooking/defrosting time whilst the oven is in use (manual cooking only).

TO USE LESS AND MORE WITH MANUAL COOKING

Press the **LESS (▼) TIME** or **MORE (▲) TIME** key to decrease or increase the cooking or defrosting time in multiples of 1 minute whilst the oven is in use. The overall cooking time can be increased to a maximum of 99 minutes.

Example: To cook on P50 for 10 minutes and then decrease the cooking time by 2 minutes:

1. Input the power level by pressing the **POWER LEVEL** key six times.
2. Enter the cooking time by pressing the **10 MIN** key once.
3. Press the **START/AUTO MINUTE** key once to start cooking.



4. Reduce the cooking time by pressing the **LESS TIME** key twice.

Cooking time is reduced by 2 minutes and continues to count down, for example:

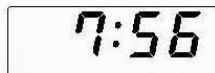



CONVENIENT FUNCTIONS

4. KITCHEN TIMER:

Use the KITCHEN TIMER as a minute timer or to monitor the standing time for cooked / defrosted food.

Example:

To set the timer for 5 minutes.

1. Press the **KITCHEN TIMER** key once.
2. Enter the desired time by pressing the **1 MIN** key 5 times.
3. Press the **START/AUTO MINUTE** key once to start.

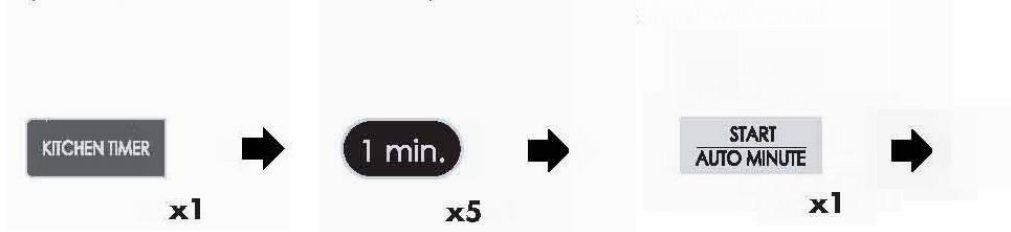

The display will count down. When the display reaches zero, the audible signal will sound.

5:00

You can enter any time up to 99 minutes, 90 seconds. To cancel the KITCHEN TIMER whilst counting down, simply press the **STOP/CLEAR**.

NOTE: The KITCHEN TIMER function cannot be used whilst cooking.



MICROWAVE COOKING ADVICE

Microwaves cook food faster than conventional cooking. It is therefore essential that certain techniques are followed to ensure good results.

COOKING ADVICE NOTES:

- When heating food in plastic or paper containers, keep an eye on the oven due to the possibility of ignition.
- Ensure that the utensils are suitable for use in a microwave oven. (See "Suitable Cookware" on page 19).
- Do not place hot foods/utensils on a cold turntable or cold foods/utensils on a hot turntable.
- Always attend the oven when in use.
- Liquids and foods must not be heated in sealed containers or jars/containers with lids on, as pressure will build up inside and may cause the container/jar to explode.
- Only use microwave popcorn within the recommended packaging (follow the manufacturer's instructions). Never use oil unless specified by the manufacturer and never cook for longer than instructed.



WARNING:

Follow instructions in the SHARP operation manual at all times.
If you exceed recommended cooking times and use power levels that are too high, food may overheat, burn and in extreme circumstances, catch fire and damage the oven.

Cooking Techniques

Arrange

Place the thickest parts of food towards the outside of the dish. e.g. Chicken drumsticks.
Foods that are placed towards the outside of the dish will receive more energy, so cook quicker, than those in the centre.



Cover

Certain foods benefit from being covered during microwave cooking, follow recommendations where given.
Use vented microwave cling film or a suitable lid.

Pierce

Foods with a shell, skin or membrane must be pierced in several places before cooking or reheating as steam will build up and may cause food to explode.
e.g. Potatoes, Fish, Chicken, Sausages.



NOTE: Eggs in their shells and hard / soft boiled eggs should not be heated in the microwave oven as they may explode, even after cooking has ended.

Stir, turn and rearrange

For even cooking it is essential to stir, turn and rearrange food during cooking. Always stir and rearrange from the outside towards the centre.

Stand

Standing time is necessary after cooking as it enables the heat to disperse equally throughout the food.



MICROWAVE COOKING ADVICE

Food Characteristics	
Composition	Foods high in fat or sugar (e.g. Christmas pudding, mince pies) require less heating time. Care should be taken as overheating can lead to fire. Bones in food conduct heat, making the food cook more quickly. Care must be taken so that the food is cooked evenly.
Density	Food density will affect the amount of cooking time needed. Light, porous foods, such as cakes or bread, cook more quickly than heavy, dense foods, such as roasts and casseroles.
Quantity	The number of microwaves in your oven remains the same regardless of how much food is being cooked. The cooking time must be increased as the amount of food placed in the oven increases. e.g. Four potatoes will take longer to cook than two.
Size	Small foods and small pieces cook faster than large ones, as microwaves can penetrate from all sides to the centre. For even cooking make all the pieces the same size.
Shape	Foods which are irregular in shape, such as chicken breasts or drumsticks, take longer to cook in the thicker parts. For even cooking, place the thickest parts to the outside of the dish where they will receive more energy. Round shapes cook more evenly than square shapes when microwave cooking.
Temperature of food	The initial temperature of food affects the amount of cooking time needed. Chilled foods will take longer to cook than food at room temperature. e.g. A cake made with chilled ingredients, (i.e. margarine) will take longer to cook than a cake made with ingredients at room temperature. The temperature of the container is not a true indication of the temperature of the food or drink. Cut into foods with fillings, for example jam doughnuts, to release heat or steam.



Face & Hands: Always use oven gloves to remove food or cookware from the oven. Stand back when opening the oven door to allow heat or steam to disperse. When removing covers (such as cling film), opening roasting bags or popcorn packaging, direct steam away from face and hands.



Check the temperature of food and drink and stir before serving. Take special care when serving to babies, children or the elderly. The contents of feeding bottles and baby food jars are to be stirred or shaken and the temperature is to be checked before consumption to avoid burns.



SUITABLE COOKWARE

To cook/defrost food in a microwave oven, the microwave energy must be able to pass through the container to penetrate the food. Therefore it is important to choose suitable cookware.

Round/oval dishes are preferable to square/oblong ones, as the food in the corners tends to overcook. A variety of cookware can be used as listed below.

Cookware	Microwave Safe	Comments
Aluminium foil Foil Containers	✓ / ✗	Small pieces of aluminium foil can be used to shield food from overheating. Keep foil at least 2cm from the oven walls, as arcing may occur. Foil containers are not recommended unless specified by the manufacturer; e.g. Microfoil®, follow instructions carefully.
Browning dishes	✓	Always follow the manufacturers instructions. Do not exceed heating times given. Be very careful as these dishes become very hot.
China and ceramics	✓ / ✗	Porcelain, pottery, glazed earthenware and bone china are usually suitable, except for those with metallic decoration.
Glassware e.g. Pyrex®	✓	Care should be taken if using fine glassware as it can break or crack if heated suddenly.
Metal	✗	It is not recommended to use metal cookware as it will arc, which can lead to fire.
Plastic/Polystyrene e.g fast food containers	✓	Care must be taken as some containers warp, melt or discolour at high temperatures.
Cling film	✓	It should not touch the food and must be pierced to let the steam escape.
Freezer/Roasting bags	✓	Must be pierced to let steam escape. Ensure bags are suitable for microwave use. Do not use plastic or metal ties, as they may melt or catch fire due to the metal 'arcing'.
Paper - Plates, cups and kitchen paper	✓	Only use for warming or to absorb moisture. Care must be taken as overheating may cause fire.
Straw and wooden containers	✓	Always attend the oven when using these materials as overheating may cause fire.
Recycled paper and newspaper	✗	May contain extracts of metal which will cause 'arcing' and may lead to fire.

NOTE: When heating food in plastic or paper containers, monitor the oven due to the possibility of ignition.



DEFROSTING ADVICE

Defrosting food using your microwave oven is the quickest method of all.

It is a simple process but the following instructions are essential to ensure the food is thoroughly defrosted.

Rearrange	Foods that are placed towards the outside of the dish will defrost quicker than foods in the centre. It is therefore essential that the food is rearranged up to 4 times during defrosting. Move closely packed pieces from the outside to the centre and rearrange over-lapping areas. This will ensure that all parts of the food defrosts evenly.
Separate	Foods may be stuck together when removed from the freezer. It is important to separate foods as soon as it is possible during defrosting. e.g. bacon rashers, chicken fillets.
Shield	Some areas of food being defrosted may become warm. To prevent them becoming warmer and starting to cook, these areas can be shielded with small pieces of foil, which reflect microwaves. e.g. legs and wings on a chicken.
Stand	Standing time is necessary to ensure food is thoroughly defrosted. Defrosting is not complete once the food is removed from the microwave oven. Food must stand, covered, for a length of time to ensure the centre has completely defrosted.
Turn over	It is essential that all foods are turned over at least 3 - 4 times during defrosting. This is important to ensure thorough defrosting.





NOTES:

- Remove all packaging and wrapping before defrosting.
- To defrost food, use microwave power levels MEDIUM LOW or LOW.



REHEATING ADVICE

For the reheating of foods, follow the advice and guidelines below to ensure food is thoroughly reheated before serving.

Plated meals	<p>Remove any poultry or meat portions, reheat these separately, see below.</p> <p>Place smaller items of food to the centre of the plate, larger and thicker foods to the edge. Cover with vented microwave cling film and reheat on MEDIUM, stir/ rearrange halfway through reheating.</p> <p>NOTE: Ensure the food is thoroughly reheated before serving.</p>	
Sliced meat	<p>Cover with vented microwave cling film and reheat on MEDIUM. Rearrange at least once to ensure even reheating.</p> <p>NOTE: Ensure the meat is thoroughly reheated before serving.</p>	
Poultry portions	<p>Place thickest parts of the portions to the outside of the dish, cover with vented microwave cling film and reheat on MEDIUM HIGH. Turn over halfway through reheating.</p> <p>NOTE: Ensure the poultry is thoroughly reheated before serving.</p>	
Casseroles	<p>Cover with vented microwave cling film or a suitable lid and reheat on MEDIUM. Stir frequently to ensure even reheating.</p> <p>NOTE: Ensure the food is thoroughly reheated before serving.</p>	

To achieve the best results when reheating, select a suitable microwave power level appropriate to the type of food. e.g. A bowl of vegetables can be reheated using HIGH, while a lasagne which contains ingredients that cannot be stirred, should be reheated using MEDIUM.

NOTES:

- Remove food from foil or metal containers before reheating.
- Reheating times will be affected by the shape, depth, quantity and temperature of food together with the size, shape and material of the container.



Never heat liquids in narrow-necked containers, as this could result in the contents erupting from the container and may cause burns.

- To avoid overheating and fire, special care must be taken when reheating foods with a high sugar or fat content, e.g. mince pies or Christmas pudding.
- Never heat oil or fat for deep frying as this may lead to overheating and fire.
- Canned potatoes should not be heated in the microwave oven, follow the manufacturer's instructions on the can.



The contents of feeding bottles and baby food jars are to be stirred or shaken and the temperature is to be checked before consumption to avoid burns.





CLEANING & MAINTENANCE

OVEN INTERIOR

- It is important to clean the interior of your microwave oven after each use.
- To clean the oven interior, use a mild detergent solution, such as washing-up liquid, with warm water on a soft cloth.
- Food and liquid splashes will build-up on the oven walls and ceiling. If grease, fat and food debris is allowed to build-up in the oven interior it may overheat, smoke or even catch fire when next using the oven.
- Keep the **waveguide cover** clean at all times. The waveguide cover is constructed from a fragile material and should be cleaned with care (follow the cleaning instructions above). NOTE: Excessive soaking may cause disintegration of the waveguide cover. The waveguide cover is a consumable part and without regular cleaning, will need to be replaced.
- Food will release steam during cooking and cause condensation inside the oven and door. It is important to wipe the oven dry. A build-up of condensation will eventually lead to rust forming on the oven interior.
- **Do not allow grease or dirt to build-up on the door seals or areas around the door. This may prevent the door from closing correctly and may cause a leakage of microwaves (follow the cleaning instructions opposite).**
- Ensure the turntable and roller stay are cleaned after every use with a mild washing-up liquid solution and dried. This will prevent the build-up of grease and food debris. The turntable is dishwasher safe.
- **CLEAN THE OVEN AT REGULAR INTERVALS AND REMOVE ANY FOOD DEPOSITS.** Failure to maintain the oven in a clean condition could lead to a deterioration of the surface that could adversely affect the life of the appliance and possibly result in a hazardous situation.

OUTER CABINET

- Wipe the outside of the microwave oven with a mild detergent solution, such as washing-up liquid, with warm water on a soft cloth.
- The control panel must be wiped clean and dried with the door open, therefore inactivating the oven.

NOTES:

- Never use spray cleaners, oven pads or abrasive scourers as these damage the surface of the oven.
- A steam cleaner should not be used.
- Take care not to let soapy water drip through the small holes in the oven walls and the cavity floor. Excess water spillage through these holes will cause damage to the oven interior.



TROUBLESHOOTING

If you think the oven is not working properly there are some simple checks you can carry out yourself before calling an engineer. This will help prevent unnecessary service calls if the fault is something simple.

Follow this simple check below:

Place half a cup of water on the turntable and close the door. Select HIGH and programme the oven to cook for 1 minute.

1. Does the oven lamp come on when it is cooking?
2. Does the turntable rotate?
3. Does the cooling fan work? (Check by placing your hand above the air vent openings.)
4. After 1 minute does the audible signal sound?
5. Is the water in the cup hot?

If you answer "NO" to any question first check that the oven is plugged in properly and the fuse has not blown. If there is no fault with either, check against the chart below.

NOTE:

If you cook food for more than the standard time (see chart below) using the same cooking mode, the oven's safety mechanisms automatically activate. The microwave power level will be reduced.

Cooking Mode	Standard Time
Microwave HIGH cooking	20 Minutes

WARNING:

Never adjust, repair or modify the oven yourself. It is hazardous for anyone other than a SHARP trained engineer to carry out servicing or repairs.

This is important as it may involve the removal of covers that provide protection against microwave energy.

- The door seal stops microwave leakage during oven operation, but does not form an airtight seal. It is normal to see drops of water, light or feel warm air around the oven door. Food with a high moisture content will release steam and cause condensation inside the door which may drip from the oven.
- Repairs and Modifications: Do not attempt to operate the oven if it is not working properly.
- Outer Cabinet & Lamp Access: Never remove the outer cabinet. This is very dangerous due to high voltage parts inside which must never be touched, as this could be fatal. Your oven is not fitted with a lamp access cover. If the lamp fails, do not attempt to replace the lamp yourself, call a SHARP approved service facility.

QUERY	ANSWER
Draught circulates around the door.	When the oven is working, air circulates within the cavity. The door does not form an airtight seal so air may escape from the door.
Condensation forms in the oven, and may drip from the door.	The oven cavity will normally be colder than the food being cooked, and so steam produced when cooking will condense on the colder surface. The amount of steam produced depends on the water content of the food being cooked. Some foods, such as potatoes have a high moisture content. Condensation trapped in the door glass should clear after a few hours.
Flashing or arcing from within the cavity when cooking.	Arcing will occur when a metallic object comes into close proximity to the oven cavity during cooking. This may possibly roughen the surface of the cavity, but would not otherwise damage the oven.
Arcing potatoes.	Ensure all "eyes" are removed and the potatoes have been pierced, place directly onto the turntable or in a heat resistant flan dish or similar.
The display is lit but the control panel will not work when pressed.	Check the door is closed properly.
Oven cooks too slowly.	Ensure correct power level has been selected.
Oven makes a noise.	The microwave energy pulses ON and OFF during cooking/defrosting.
Outer cabinet is hot.	The cabinet may become warm to the touch - keep children away.



TO REPLACE THE MAINS PLUG

The wires in the mains cable are colour coded as shown:

Green and yellow stripes = **EARTH**
Blue = **NEUTRAL**
Brown = **LIVE**

As the colours in the mains lead of your oven may not correspond with the coloured marking identifying the terminals in your plug, connect the wires as described:

- The green and yellow wire to the plug terminal marked E or  or coloured green or coloured green and yellow.
- The blue wire to the plug terminal marked N or coloured black or coloured blue.
- The brown wire to the plug terminal marked L or coloured red or coloured brown.

Make sure the terminal screws are tight and the cable is held securely by the cable grip where it enters the plug.

Like most appliances in your home, your oven must be connected to a single phase 230-240V, 50Hz alternating current supply.

If you do not make the proper electrical connections you might damage the oven or injure yourself. Neither SHARP nor the supplier will be liable if this happens.



**WARNING: THIS APPLIANCE
MUST BE EARTHED**

**If you have any doubts about your
electrical supply ask a qualified
electrician.**

CALLING FOR SERVICE

- If you are unable to resolve a problem using the checks covered on the last few pages, **do not attempt to service this microwave oven yourself.**
- Contact the dealer or supplier from whom the oven was purchased in order to obtain service. Where this is not possible, please contact the SHARP Customer Information Centre. Telephone: 08705 274277 (office hours).

- For general information and assistance with oven queries, please contact our **Customer Information Centre:**
U.K.: 0845 888 8112 (office hours)
Ireland: 01 676 0648 (office hours)
Website: <http://www.sharp.co.uk/support>
- Replacement accessories may be obtained from our main parts distributor:
Wizard Distributors
Telephone: 01925 759 627



GUARANTEE

Sharp Electronics (UK) Ltd. ("Sharp") guarantees that for a period of 12 months from the date of purchase the enclosed product will be free from defects in materials and workmanship. Sharp agrees to provide for the repair or, at its option, the replacement of a defective product. Sharp reserves the right to replace defective parts, or the product, with new or refurbished items. Items that are replaced become the property of Sharp.

To benefit from this guarantee, any fault that occurs must be notified to Sharp, or its appointed Service Facility, within one year from the date the product was purchased. Proof of purchase, such as a receipt or invoice, must be provided.

If the product is exchanged, the replacement shall be covered by the unexpired portion of the original guarantee.

In the unlikely event of the product requiring repair, please contact the supplier from whom it was purchased. Where this is not possible, please contact an appointed Service Facility. Details of Service Facilities appointed by Sharp can be obtained from www.sharp.co.uk/customersupport/service or by contacting the **Sharp Customer Information Centre** whose details are given below.

This guarantee shall only apply to faults that are due to inferior workmanship or materials. It does not cover faults or damage caused by accident, misuse, fair wear and tear, neglect, tampering with the product, or repair other than by a Service Facility appointed by Sharp.

The product is intended for private domestic use only. The guarantee will not apply if the product is used in the course of a business, trade or profession.

The guarantee does not cover:

- Glass/ceramic turntables, as they can be damaged by handling/cleaning methods.
- Faults resulting from inadequate cleaning. Regular cleaning is required to prevent a build up of food residue that can also affect the performance of the product.
- Carriage costs to or from the repair centre.

No person has any authority to vary the terms or conditions of this guarantee.

This guarantee is offered as an additional benefit to your statutory rights, and does not affect these rights in any way.

You may not transfer your rights or obligations under this warranty to anyone else.

If you have any difficulty operating the product, or would like information on other Sharp products, please telephone the Sharp Customer Information Centre on the number given below.

Sharp Customer Information Centre

Website: www.sharp.co.uk/customersupport

Telephone: **0845 888 8112** (01 676 0648 in Southern Ireland)

Sharp Electronics (UK) Ltd is a company registered in England under number 965877

whose registered office is at

4 Furzeground Way, Stockley Park, Uxbridge, Middlesex, UB11 1EZ.



SPECIFICATIONS

AC Line Voltage	Single phase 230-240V, 50Hz
Power Consumption:	
Microwave.....	1200W
Input Current:	
Microwave.....	5.2A
Output Power:	
Microwave.....	800W (IEC 60705)
MAFF Heating Category	E
Microwave Frequency	2450Mhz* (Group 2/Class B)
Outside Dimensions	452(W) x 262(H) x 342(D)mm
Cavity Dimensions.....	315(W) x 210(H) x 329(D)mm**
Oven Capacity	20 litres**
Cooking Uniformity.....	Turntable diameter 245mm
Weight	Approx. 12kg

* This Product fulfils the requirement of the European standard EN55011. In conformity with this standard, this product is classified as group 2 class B equipment. Group 2 means that the equipment intentionally generates radio-frequency energy in the form of electromagnetic radiation for the heat treatment of food. Class B equipment means that the equipment is suitable to be used in domestic establishments.

** Internal capacity is calculated by measuring maximum width, depth and height.
Actual capacity for holding food is less.

As part of a policy of continuous improvement, we reserve the right to alter design and specifications without notice.

No part of this publication may be reproduced, stored in a retrieval system or transmitted in any form, electronic, mechanical, photocopying, recording, translating or other means without prior permission from SHARP Electronics (U.K.) Ltd.

The illustrations, technical information and data contained in this publication are, to our best knowledge, correct at the time of going to print. The right to change specifications, at any time, without notice, is reserved as a part of our policy of continuous development and improvement.





SHARP

Sharp Electronics (U.K.) Ltd
London, U. K.

U.K.: 0845 888 8112 (office hours)
Ireland: 01 676 0648 (office hours)
Website: <http://www.sharp.co.uk/support>