

INSTRUCTION MANUAL

FREE-STANDING COOKER

EN

TRA4110P
TRA4110BL



Dear customer, we would like to thank you for your confidence in us.

By choosing our product, you have opted for solutions where research for beauty meets innovative technical design to provide unique pieces of furniture.

We hope you get the most out of your household appliance.

Kindest regards.

Contents

1	Instructions	4
1.1	General safety instructions	4
1.2	Manufacturer liability	5
1.3	Appliance purpose	5
1.4	Disposal	5
1.5	Identification plate	6
1.6	This user manual	6
1.7	How to read the user manual	6
2	Description	7
2.1	General description	7
2.2	Cooking hob	8
2.3	Control panel	8
2.4	Other parts	9
2.5	Available accessories	10
3	Use	12
3.1	Instructions	12
3.2	First use	13
3.3	Using the accessories	13
3.4	Using the hob	14
3.5	Teppanyaki plate	15
3.6	Using the storage compartment	16
3.7	Using the ovens	16
3.8	Cooking advice	18
3.9	Programming clock	19
4	Cleaning and maintenance	23
4.1	Instructions	23
4.2	Cleaning the appliance	23
4.3	Removing the door of the auxiliary oven	24
4.4	Cleaning the door glazing	25
4.5	Removing the internal glass panels	25
4.6	Cleaning the inside of the oven	27
4.7	Vapor Clean: assisted oven cleaning	28
4.8	Extraordinary maintenance	29
5	Installation	30
5.1	Clearances above and around domestic appliances	30
5.2	Gas connection	31
5.3	Adaptation to different types of gas	33
5.4	Electrical connection	35
5.5	Positioning	36

We advise you to read this manual carefully, which contains all the instructions for maintaining the appliance's aesthetic and functional qualities.

For further information on the product: www.smeg.com



Instructions

1 Instructions

1.1 General safety instructions

Risk of personal injury

- During use the appliance and its accessible parts become very hot.
- Never touch the heating elements during use.
- Keep children under eight years of age at a safe distance if they are not constantly supervised.
- Children must never play with the appliance.
- Never rest metallic objects such as knives, forks, spoons and lids on the appliance during use.
- Switch the appliance off immediately after use.
- Never try to put out a fire or flames with water: turn off the appliance and smother the flames with a fire blanket or other appropriate cover.
- The appliance must never be cleaned by unsupervised children.
- Have qualified personnel carry out installation and assistance interventions according to the standards in force.
- Do not modify this appliance.

- Do not insert pointed metal objects (cutlery or utensils) into the slots in the appliance.
- Do not try to repair the appliance yourself or without the intervention of a qualified technician.
- If the power supply cable is damaged, contact technical support immediately and they will replace it.

Risk of damaging the appliance

- Do not use abrasive or corrosive detergents on glass parts (e.g. powder products, stain removers and metallic sponges).
- Use wooden or plastic utensils.
- Do not seat on the appliance.
- Do not use steam jets for cleaning the appliance.
- Do not obstruct ventilation openings and heat dispersal slots.
- Never leave the appliance unattended during cooking operations where fats or oils could be released.
- Never leave objects on the cooking surface.
- Do not use the appliance to heat rooms for any reason.



For this appliance

- Ensure that the appliance is switched off before replacing the bulb.
- Do not rest any weight or sit on the open door of the appliance.
- Take care that no objects are stuck in the doors.

1.2 Manufacturer liability

The manufacturer declines all liability for damage to persons or property caused by:

- use of the appliance other than the one envisaged;
- non-observance of the user manual provisions;
- tampering with any part of the appliance;
- use of non-original spare parts.

1.3 Appliance purpose

- This appliance is intended for cooking food in the home environment. Every other use is considered improper.
- This appliance may be used by children aged at least 8 and by people of reduced physical and mental capacity, or lacking in experience in the use of electrical appliances, as long they are supervised or instructed by adults who are responsible for their safety.
- The appliance is not designed to operate with external timers or with remote-control systems.

1.4 Disposal



This appliance must be disposed of separately from other waste (Directives 2002/95/EC, 2002/96/EC, 2003/108/EC). The appliance does not contain substances in quantities sufficient to be considered hazardous to health and the environment, in accordance with current European directives.

To dispose of the appliance:

- Cut the power supply cable and remove it along with the plug.



Power voltage

Danger of electrocution

- Disconnect the main power supply.
- Disconnect the power cable from the electrical system.
- Consign the appliance to the appropriate selective collection centres for electrical and electronic equipment waste, or deliver it back to the retailer when purchasing an equivalent product, on a one for one basis.



Instructions

Our appliances are packed in non-polluting and recyclable materials.

- Consign the packing materials to the appropriate selective collection centres.



Plastic packaging Danger of suffocation

- Do not leave the packaging or any part of it unattended.
- Do not let children play with the packaging plastic bags.

1.5 Identification plate

The identification plate bears the technical data, serial number and brand name of the appliance. Do not remove the identification plate for any reason.

1.6 This user manual

This user manual is an integral part of the appliance and must therefore be kept in its entirety and in an accessible place for the whole working life of the appliance.

Read this user manual carefully before using the appliance.

1.7 How to read the user manual

This user manual uses the following reading conventions:

Instructions



General information on this user manual, on safety and final disposal.

Description



Description of the appliance and its accessories.

Use



Information on the use of the appliance and its accessories, cooking advice.

Cleaning and maintenance



Information for proper cleaning and maintenance of the appliance.

Installation



Information for the authorized persons: installation, operation and inspection.



Safety instructions



Information



Advice

1. Use instruction sequence.

- Single use instruction.



2 Description

2.1 General description

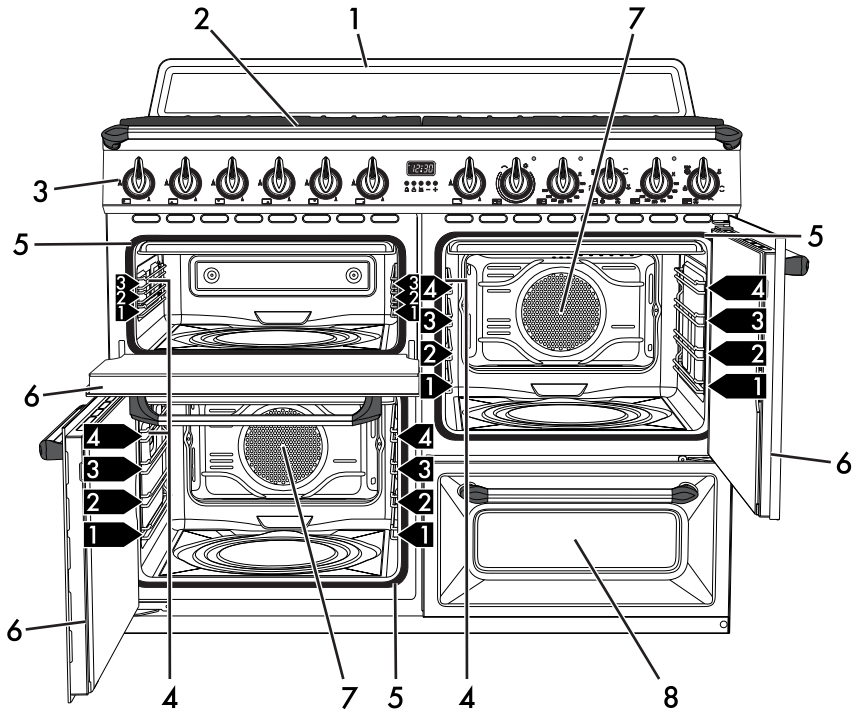

1 Skirt

2 Cooking hob

3 Control panel

4 Oven light

5 Seal

6 Door

7 Fan

8 Storage compartment

1,2,3... Shelf for racks/trays support frames



Description

2.2 Cooking hob

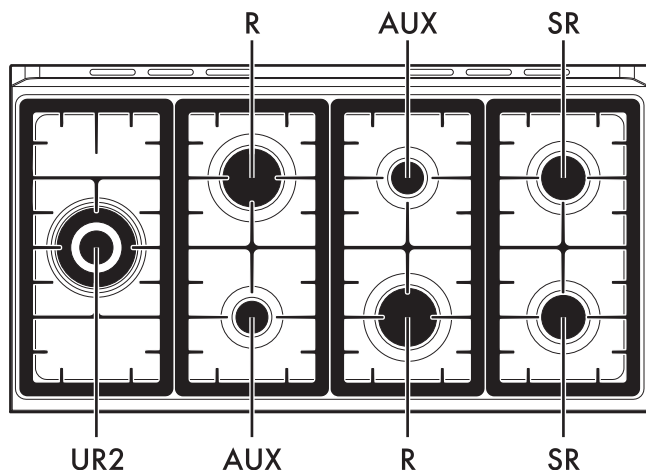

AUX = Auxiliary
SR = Semi-rapid

R = Rapid
UR2 = Ultra rapid

2.3 Control panel

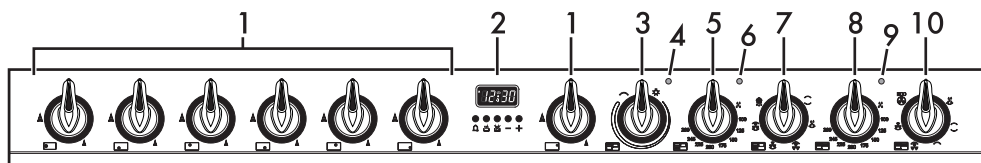

Hob burner knobs

Useful for lighting and adjust the hob burners.

Press and turn the knobs anti-clockwise to the value to light the relative burners. Turn the knobs to the zone between the maximum and minimum setting to adjust the flame.

Return the knobs to the position to turn off the burners.

2 Programming clock

Useful for displaying the current time, set programmed cooking operations and program the timer.

3 Auxiliary oven variable grill knob

It turns on the light inside the oven or starts the grill heating element to a temperature ranging from a minimum of 50°C to a maximum of 245°C.



4 Auxiliary oven variable grill indicator light

The indicator light comes on to indicate that the auxiliary oven is heating up. It turns off as soon as it reaches the set temperature. It flashes regularly to indicate that the temperature set inside the oven is kept constant.

5 Lower multifunction oven temperature knob

This knob allows you to select the cooking temperature.

Turn the knob clockwise to the required value, between the minimum and maximum settings.

6 Lower multifunction oven indicator light

The indicator light comes on to indicate that the oven is heating up. It turns off as soon as it reaches the set temperature. It flashes regularly to indicate that the temperature set inside the oven is kept constant.

7 Lower multifunction oven function knob

The oven's various functions are suitable for different cooking modes. After selecting the required function, set the cooking temperature using the temperature knob.

8 Upper multifunction oven temperature knob

This knob allows you to select the cooking temperature and the Vapor Clean temperature.

Turn the knob clockwise to the required value, between the minimum and maximum settings.

9 Upper multifunction oven indicator light

The indicator light comes on to indicate that the oven is heating up. It turns off as soon as it reaches the set temperature. It flashes regularly to indicate that the temperature set inside the oven is kept constant.

10 Upper multifunction oven function knob

The oven's various functions are suitable for different cooking modes. After selecting the required function, set the cooking temperature using the temperature knob.

2.4 Other parts

Oven shelves

The oven features shelves for positioning trays and racks at different heights. The insertion heights are indicated from the bottom upwards (see 2.1 General description).

Cooling fan

The fan cools the ovens and comes into operation during cooking.

The fan causes a steady outflow of air that exits from the rear of the appliance and which may continue for a brief period of time even after the appliance has been turned off.

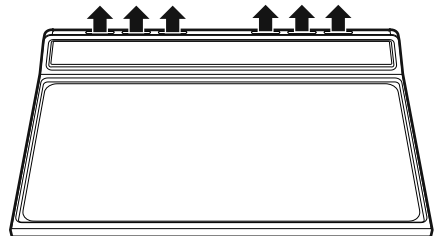



Description

Internal light

The internal light of the ovens comes on when any function is selected.

2.5 Available accessories



Some models are not provided with all accessories.

Rack

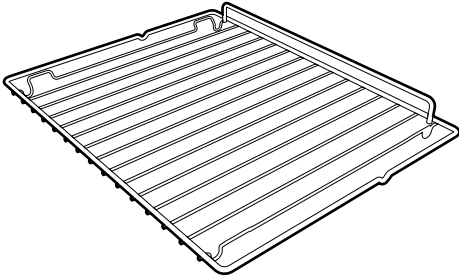

Useful for holding cooking containers.

Tray rack

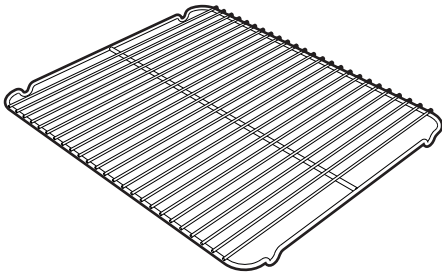

To be placed over the top of the oven tray; for cooking foods which may drip.

Oven tray

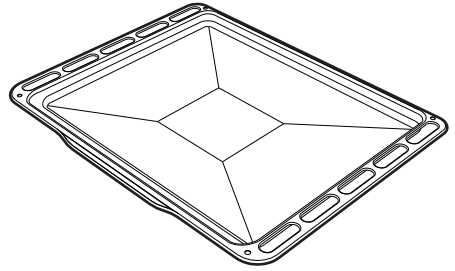

Useful for collecting fat from foods placed on the rack above.

Deep tray

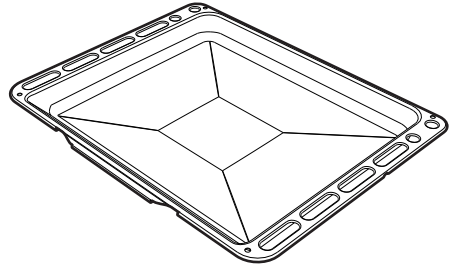

Useful for collecting fat from foods placed on the rack above and for cooking pies, pizzas and baked desserts.



Reduction pan stand

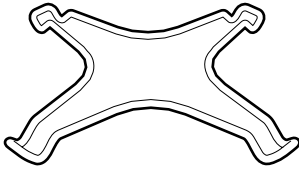

Useful when using small cookware.

WOK Reduction pan stand

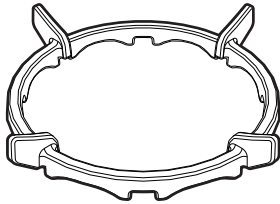

Useful when using a wok.

Teppanyaki plate

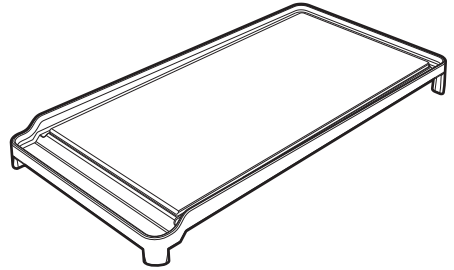

Useful for cooking meat, fish and vegetables directly on the plate without adding fats or oils, staying true to the tradition of Japanese cuisine that seeks to exalt the natural flavours and aromas of food ensuring light nourishment while preserving all nutritional elements.

Scraper

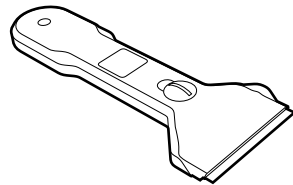

Useful for cleaning the Teppanyaki plate.

Do not use on other surfaces.



The accessories intended to come into contact with food are made of materials that comply with the provisions of current legislation.



Original and optional accessories can be requested to Authorised Assistance Centres. Use only original accessories supplied by the manufacturer.



Use

3 Use

3.1 Instructions



High temperature inside the oven during use

Danger of burns

- Keep the oven door closed during cooking.
- Protect your hands using heat resistant gloves when moving food inside the oven.
- Do not touch the heating elements inside the oven.
- Do not pour water directly on very hot trays.
- Do not allow children younger than 8 year old to come near the appliance when in operation.
- If you need to move food or at the end of cooking, open the door 5 cm for a few seconds, let the steam come out, then open it fully.



High temperature inside the storage compartment

Danger of burns

- Do not open the storage compartment when the oven is on and still hot.
- The items inside the storage compartment could be very hot after using the oven.



Improper use

Danger of burns

- Make sure that the flame-spreader crowns are correctly positioned in their housings with their respective burner caps.
- Oils and fat could catch fire if overheated. Be very careful.



High temperature inside the oven during use

Danger of fire or explosion

- Do not spray any spray products near the oven.
- Do not use or leave flammable materials near the oven or the storage compartment.
- Do not use plastic kitchenware or containers when cooking food.
- Do not put sealed tins or containers in the oven.
- Do not leave the oven unattended during cooking operations where fats or oils could be released.
- Remove from the oven compartment all trays and racks not used during cooking.



Improper use Risk of damage to surfaces

- Do not cover the bottom of the oven with aluminium or tin foil sheets.
- If you wish to use greaseproof paper, place it so that it will not interfere with the hot air circulation inside the oven.
- Do not place pans or trays directly on the bottom of the cooking compartment.
- Do not use the open door to rest pans or trays on the internal glass pane.
- Do not pour water directly on very hot trays.
- Make sure that the flame-spreader crowns are correctly positioned in their housings with their respective burner caps.
- The cooking vessels or griddle plates should be placed inside the perimeter of the hob.
- All pans must have smooth, flat bottoms.
- If any liquid does boil over or spill, remove the excess from the hob.

3.2 First use

1. Remove any protective film from the outside or inside of the appliance, including accessories.
2. Remove any labels (apart from the technical data plate) from the accessories and from the cooking compartments.
3. Remove all the accessories from the appliance and clean them (see 4 Cleaning and maintenance).

4. Heat the empty ovens at the maximum temperature to burn off any residues left by the manufacturing process.

3.3 Using the accessories

Racks and trays

Racks and trays have to be inserted into the side guides until they come to a complete stop.

- The mechanical safety locks that prevent the rack from being taken out accidentally have to face downwards and towards the oven back.

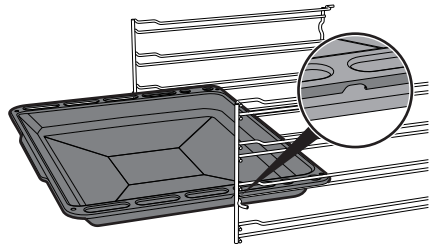
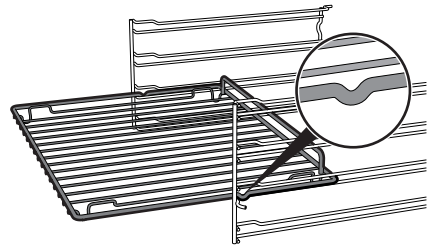

Gently insert racks and trays into the oven until they come to a stop.



Clean the trays before using them for the first time to remove any residues left by the manufacturing process.



Tray rack

The tray rack has to be inserted into the tray. In this way fat can be collected separately from the food which is being cooked.

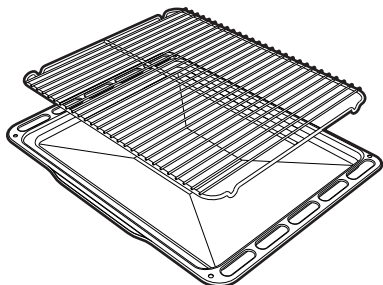

Reduction pan stands

The reduction pan stands have to be placed on the hob grids. Make sure they are properly placed.

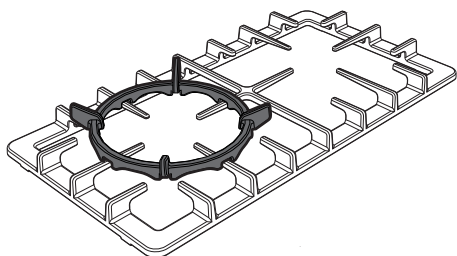
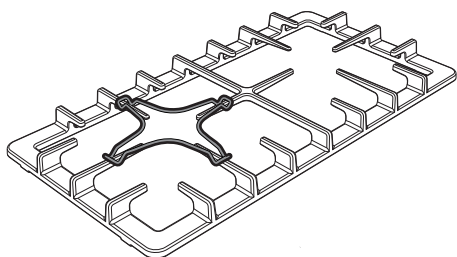

3.4 Using the hob

All the appliance's control and monitoring devices are located together on the front panel. The burner controlled by each knob is shown next to the knob. The appliance is equipped with an electronic ignition device. Simply press the knob and turn it anti-clockwise to the maximum flame symbol, until the burner lights. If the burner does not light in the first 15 seconds, turn the knob to  and wait 60 seconds before trying again. After lighting, keep the knob pressed down for a few seconds to allow the thermocouple to heat up. The burner may go out when the knob is released: in this case, the thermocouple has not heated up sufficiently. Wait a few moments and repeat the operation. Keep the knob pressed in longer.



In case of an accidental switching off, a safety device will be tripped, cutting off the gas supply, even if the gas tap is open. Return the knob to  and wait at least 60 seconds before lighting it again.



Correct position for flame-spreader crowns and burner caps

Before lighting the hob burners, make sure that the flame-spreader crowns are correctly positioned in their housings with their respective burner caps. Make sure that the holes in the flame-spreader crowns are aligned with the igniters and thermocouples.

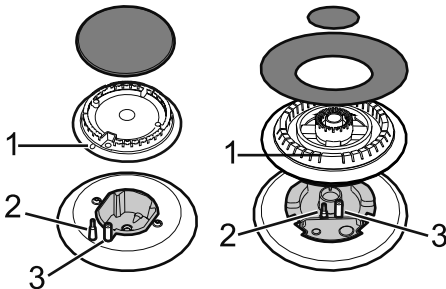

Practical tips for using the hob

For better burner efficiency and to minimise gas consumption, use pans with lids and of suitable size for the burner, so that flames do not reach up the sides of the pan. Once the contents come to the boil, turn down the flame far enough to ensure that the liquid does not boil over.



Cookware diameters:

- Auxiliary: 12 - 14 cm.
- Semi-rapid: 16 - 24 cm.
- Rapid: 18 - 26 cm.
- Ultra-rapid: 18 - 28 cm.

3.5 Teppanyaki plate



Improper use

Risk of damage to surfaces

- The plate must not be used for more than 60 minutes.
- The burners under the plate can be lit at the same time to the maximum setting for no more than 10 minutes. After this time they should be set at the minimum setting.
- After use, it is advisable to wait for at least 15 minutes before removing the accessory from the appliance.

Use the Teppanyaki plate on the pair of **SR** burners on the right of the hob.

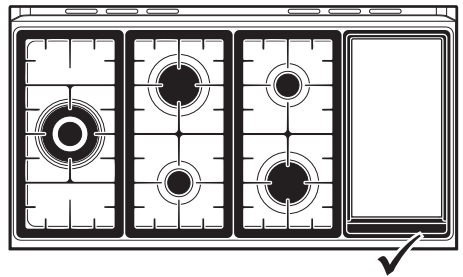

The Teppanyaki plate should be positioned in place of the rack.



3.6 Using the storage compartment

The storage compartment is at the bottom right of the cooker. It can be used to store cookware or metallic objects necessary when using the appliance.

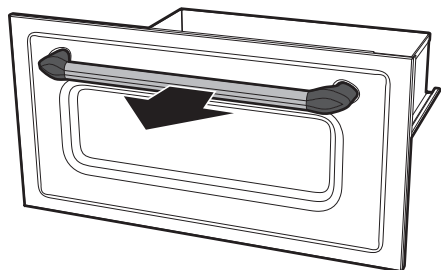

3.7 Using the ovens

Switching on multifunction ovens



To switch on multifunction ovens:

1. Select the cooking function using the function knob.
2. Select the temperature using the temperature knob.

Opening and closing the doors of multifunction ovens

Multifunction ovens are equipped with a swing door. To open, pull the door handle towards you. To close, push the doors until you hear a mechanical "click".

i The doors of multifunction ovens have a maximum opening of 110°

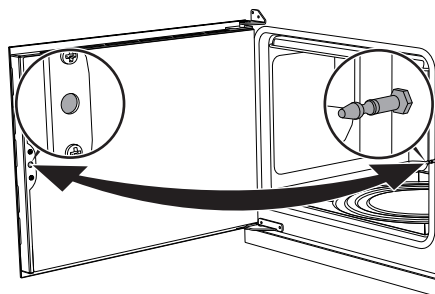

Multifunction oven doors do not block laterally when opening and they might close. During use, pay attention not to come into contact with the internal glass pane to prevent burns.



Over time the swing doors might get difficult to open and close. Grease the hinges.

Switching on the auxiliary oven



To switch the auxiliary oven:

- Select the temperature using the variable grill knob. The temperature ranges indicatively from a minimum of 50°C and a maximum of 300°C.





Functions list



ECO

Depending on the function it is used with, it ensures maximum energy savings during cooking.



Static

As the heat comes from above and below at the same time, this system is particularly suitable for certain types of food. Traditional cooking, also known as static cooking, is suitable for cooking just one dish at a time. Perfect for all types of roasts, bread and cakes and in any case particularly suitable for fatty meats such as goose and duck.



Bottom

The heat coming just from the bottom allows you to complete the cooking of foods that require a higher bottom temperature, without affecting their browning. Perfect for cakes, pies, tarts and pizzas.



Fan-assisted grill

The air produced by the fan softens the strong heatwave generated by the grill, grilling perfectly even very thick foods. Perfect for large cuts of meat (e.g. shin of pork).



Fan-assisted static

The operation of the fan, combined with traditional cooking, ensures uniform cooking even with complex recipes. Perfect for biscuits and cakes, even when simultaneously cooked on several levels. (For multiple-level cooking, we recommend using the 2nd and 4th shelves.)



Fan-assisted bottom

The combination of the fan with just the lower heating element allows cooking to be completed more rapidly. This system is recommended for sterilising or for finishing off the cooking of foods which are already well-cooked on the surface, but not inside, which therefore need a little more heat. Perfect for any type of food.

In pyrolytic models, the special defrosting and proving functions are brought together under the same function.



Defrosting

Rapid defrosting is helped by switching on the fan provided and the top heating element that ensure uniform distribution of low temperature air inside the oven.



Grill

The heat coming from the grill element gives perfect grilling results above all for thin and medium thickness meat and in combination with the rotisserie (where present) gives the food an even browning at the end of cooking. Perfect for sausages, ribs and bacon. This function enables large quantities of food, particularly meat, to be grilled evenly.



Fan-assisted circulaire

The combination of the fan and the circular element (incorporated in the rear of the oven) allows you to cook different foods on several levels, as long as they need the same temperatures and same type of cooking. Hot air circulation ensures instant and uniform distribution of heat. It will be possible, for instance, to cook fish, vegetables and biscuits simultaneously (on different levels) without mixing odours and flavours.

- Use a meat thermometer when roasting meat, or simply press on the roast with a spoon. If it is hard, it is ready; if not, it needs another few minutes cooking.

Advice for cooking with the Grill and the Fan-assisted grill

- Meat can be grilled even when it is put into the cold oven or into the preheated oven if you wish to change the effect of the cooking.
- With the Fan-assisted grill function, we recommend that you preheat the oven before grilling.
- We recommend placing the food at the centre of the rack.
- With the Grill function, we recommend that you turn the temperature knob to the maximum value near the  symbol to optimise cooking.
- Foods should be seasoned before cooking. Foods should also be coated with oil or melted butter before cooking.
- Use the oven tray on the first bottom shelf to collect fluids produced by grilling.
- Grilling processes should never last more than 60 minutes using multifunction ovens, 30 minutes inside the auxiliary oven.

3.8 Cooking advice

General advice

- Use a fan-assisted function to achieve uniform cooking at several levels.
- It is not possible to shorten cooking times by increasing the temperature (the food could be overcooked on the outside and undercooked on the inside).

Advice for cooking meat

- Cooking times vary according to the thickness and quality of the food and to consumer taste.

Advice for cooking desserts and biscuits

- Use preferably dark metal moulds: they help to absorb the heat better.
- Temperature and cooking time depend on the quality and consistency of the dough.
- To check whether the dessert is cooked right through: at the end of the cooking time, put a toothpick into the highest point of the dessert. If the dough does not stick to the toothpick, the dessert is cooked.



- If the dessert collapses when it comes out of the oven, on the next occasion reduce the set temperature by about 10°C, selecting a longer cooking time if necessary.
- While cooking desserts or vegetables, excessive condensation may form on the glass. In order to avoid this, open the door very carefully a couple of times while cooking.

Advice for defrosting and proving

- Place frozen foods without their packaging in a lidless container on the first shelf of the oven.
- Avoid overlapping the food.
- To defrost meat, use the rack placed on the second level and a tray on the first level. In this way, the liquid from the defrosting food drains away from the food.
- The most delicate parts can be covered with aluminium foil.
- For successful proving, a container of water should be placed in the bottom of the oven.

To save energy

- Stop cooking a few minutes before the time normally used. Cooking will continue for the remaining minutes with the heat which has accumulated inside the oven.
- Reduce any opening of the door to a minimum to avoid heat dispersal.
- Keep the inside of the appliance clean at all times.

3.9 Programming clock

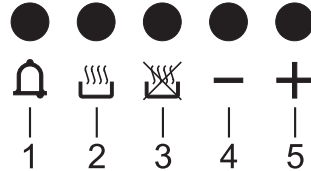

1 Timer key

2 Cooking time key

3 End of cooking key

4 Value decrease key



5 Value increase key



The programmer clock controls exclusively the right multifunction oven and has not any control on the other ovens.



Please make sure the programmer clock shows the cooking duration symbol  otherwise the oven will not switch on.

Press keys  and  at the same time to reset the programmer clock.









Setting the time



If the time is not set, the oven will not switch on.





On the first use, or after a power failure, the digits  will be flashing on the appliance's display.







1. Press the  and  keys at the same time. The dot between the hours and the minutes flashes.
2. The time can be set using  or . Hold down the key to increase or decrease rapidly.
3. Press the  key or wait 5 seconds. The dot between the hours and the minutes stops flashing.
4. The symbol  on the display indicates that the appliance is ready to start cooking.

Timed cooking



Timed cooking is the function which allows a cooking operation to be started and then ended after a specific length of time set by the user.

1. After selecting a cooking function and temperature, press key . The display will show the digits  and the symbol  displayed between the hours and the minutes.
2. Use the key  or  to set the required minutes.

3. Wait approx. 5 seconds without pressing any key in order for the function to activate. The current time and the symbols  and  will appear on the display.
4. At the end of cooking the heating elements will be deactivated. On the display, symbol  turns off, symbol  flashes and the buzzer sounds.
5. To turn off the buzzer just press any key of the programmer clock.
6. Press keys  and  at the same time to reset the programmer clock.





It is not possible to set a cooking time of more than 10 hours.



After the setting, to display the cooking time left press the  key.



To reset the set program, press keys  and  at the same time and switch off the oven manually.



Programmed cooking

i Programmed cooking is the function which allows a cooking operation to be started at a set time and then ended after a specific length of time set by the user.

1. Set the cooking time as described in the previous point "Timed cooking".
2. Press key. The sum of the current time plus the pre-set cooking duration will appear on the display.
3. Use the or key to set the required minutes.
4. Wait approx. 5 seconds without pressing any key in order for the function to activate. The current time and the symbols and will appear on the display.
5. At the end of cooking the heating elements will be deactivated. On the display, symbol turns off, symbol flashes and the buzzer sounds.
6. To turn off the buzzer just press any key of the programmer clock.
7. Press keys and at the same time to reset the programmer clock.

After the setting, to display the cooking time left press the key. To display the end of cooking time, press the key.

Timer

i The timer does not stop the cooking but rather informs the user when the set time has run out.

The timer can be activated at any time.

1. Press key. The display will show the digits and the indicator light flashing between the hours and the minutes.
2. Use the or key to set the required minutes.
3. Wait approx. 5 seconds without pressing any key to finish setting the timer. The current time and the symbols and appear on the display.

It is not possible to set a cooking time of more than 24 hours.

After the timer has been programmed, the display will go back to showing the current time; to display the remaining time, press .

Adjusting the buzzer volume

The buzzer volume can be set to 3 different levels. When the buzzer is in operation, press to change the setting.

Deleting the set data

Press keys and at the same time to reset the programs set. Then switch off the oven manually if cooking is in progress.



Use

Cooking information table

Food	Weight (Kg)	Function	Runner position from the bottom	Temperature (°C)	Time (minutes)	
Lasagne	3 - 4	Static	1	220 - 230	45 - 50	
Pasta bake	3 - 4	Static	1	220 - 230	45 - 50	
Roast veal	2	Fan assisted	2	180 - 190	90 - 100	
Pork	2	Fan assisted	2	180 - 190	70 - 80	
Sausages	1.5	Fan with grill	4	260	15	
Roast beef	1	Fan assisted	2	200	40 - 45	
Roast rabbit	1.5	Circulaire	2	180 - 190	70 - 80	
Turkey breast	3	Fan assisted	2	180 - 190	110 - 120	
Roast pork neck	2 - 3	Fan assisted	2	180 - 190	170 - 180	
Roast chicken	1.2	Fan assisted	2	180 - 190	65 - 70	
					1 st surface	2 nd surface
Pork chops	1.5	Fan with grill	4	260	15	5
Spare ribs	1.5	Fan with grill	4	260	10	10
Bacon	0.7	Grill	5	250 - 260	7	8
Pork fillet	1.5	Fan with grill	4	250 - 260	10	5
Beef fillet	1	Grill	5	250 - 260	10	7
Salmon trout	1.2	Fan assisted	2	150 - 160	35 - 40	
Monkfish	1.5	Fan assisted	2	160	60 - 65	
Turbot	1.5	Fan assisted	2	160	45 - 50	
Pizza	1	Fan assisted	2	260	8 - 9	
Bread	1	Circulaire	2	190 - 200	25 - 30	
Focaccia	1	Fan assisted	2	180 - 190	20 - 25	
Bundt cake	1	Circulaire	2	160	55 - 60	
Jam tart	1	Circulaire	2	160	35 - 40	
Ricotta cake	1	Circulaire	2	160 - 170	55 - 60	
Jam tarts	1	Circulaire	2	160	20 - 25	
Paradise cake	1.2	Circulaire	2	160	55 - 60	
Profiteroles	1.2	Circulaire	2	180	80 - 90	
Sponge cake	1	Circulaire	2	150 - 160	55 - 60	
Rice pudding	1	Circulaire	2	160	55 - 60	
Brioches	0.6	Circulaire	2	160	30 - 35	

The times indicated in the table do not include preheating times and are provided as a guide only.



4 Cleaning and maintenance

4.1 Instructions



Improper use Risk of damage to surfaces

- Do not use steam jets for cleaning the appliance.
- Do not use cleaning products containing chlorine, ammonia or bleach on steel parts or parts with metallic finishes on the surface (e.g. anodizing, nickel- or chromium-plating).
- Do not use abrasive or corrosive detergents on glass parts (e.g. powder products, stain removers and metallic sponges).
- Do not use rough or abrasive materials or sharp metal scrapers.
- Do not wash the removable components such as the hob pan stands, flame-spreader crowns and burner caps in a dishwasher.

4.2 Cleaning the appliance

To keep the oven surfaces in good condition, they should be cleaned regularly after use. Let them cool first.

Ordinary daily cleaning

Always use only specific products that do not contain abrasives or chlorine-based acids.

Pour the product onto a damp cloth and wipe the surface, rinse thoroughly and dry with a soft cloth or a microfibre cloth.

Igniters and thermocouples

Food stains or residues

Do not use metallic sponges or sharp scrapers as they will damage the surfaces.

Use ordinary non-abrasive products with the aid of wooden or plastic utensils if necessary. Rinse thoroughly and dry with a soft cloth or a microfibre cloth.

Do not allow residues of sugary foods (such as jam) to set inside the oven. If left to set for too long, they might damage the enamel lining of the oven.

Cooking hob pan stands

Remove the pan stands and clean them with lukewarm water and non-abrasive detergent. Make sure to remove any encrustations. Dry them thoroughly and return them to the hob.



Continuous contact between the pan stands and the flame can cause modifications to the enamel over time in those parts exposed to heat. This is a completely natural phenomenon which has no effect on the operation of this component.

Flame-spreader crowns and burner caps

For easier cleaning, the flame-spreader crowns and the burner caps can be removed. Wash them in hot water and non-abrasive detergent. Carefully remove any encrustation, then wait until they are perfectly dry. Refit the flame-spreader crowns making sure that they are correctly positioned in their housings with their respective burner caps.

For correct operation the igniters and thermocouples must always be perfectly clean. Check them frequently and clean



Cleaning and maintenance

them with a damp cloth if necessary. Remove any dry residues with a wooden toothpick or a needle.

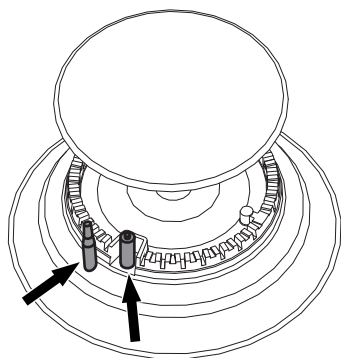

Teppanyaki plate

The Teppanyaki plate is easier to clean when it is still lukewarm.

Use conventional specific detergents for stainless steel and non-abrasive sponges. Any remaining encrustations or food residues can be easily removed by soaking the plate for a while. For very stubborn encrustations, we recommend using the supplied scraper. Dry it carefully.



Do not soak the plate in water immediately after use. Wait for it to cool down.

4.3 Removing the door of the auxiliary oven

For easier cleaning, the door can be removed and placed on a canvas.

To remove the door proceed as follows:

1. Open the door completely and insert two pins into the holes on the hinges indicated in the figure.

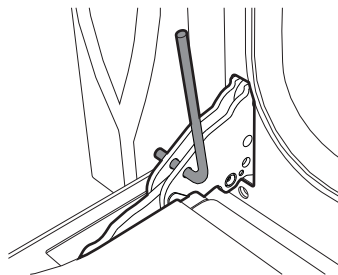

2. Grasp the door on both sides with both hands, lift it forming an angle of around 30° and remove it.

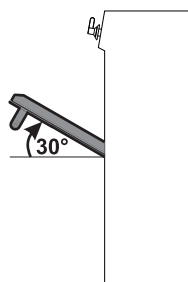



3. To reassemble the door, put the hinges in the relevant slots in the oven, making sure that grooved sections **A** are resting completely in the slots. Lower the door and once it is in place remove the pins from the holes in the hinges.

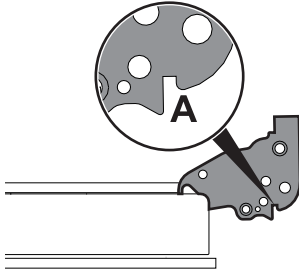

2. Then, pull the bottom part upwards (2). In this way, the 4 pins attached to the glass detach from their housings in the oven door.

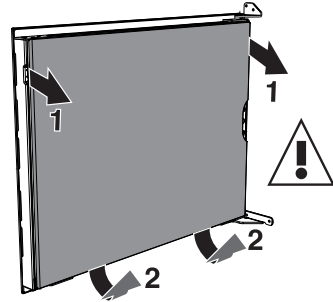

3. Take hold of the intermediate glass panel and unscrew the screw to remove the lower plate that blocks it.

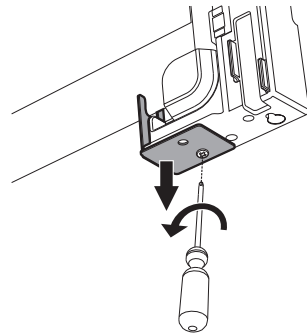

4.4 Cleaning the door glazing

The glass in the door should always be kept thoroughly clean. Use absorbent kitchen roll. In case of stubborn dirt, wash with a damp sponge and an ordinary detergent.



We recommend the use of cleaning products distributed by the manufacturer.

4.5 Removing the internal glass panels

For easier cleaning the door internal glass panels can be disassembled.

Multifunction oven doors

1. Remove the internal glass panel by pulling the top part gently, following the movement indicated by the arrows (1).



Improper use
Danger of cuts and glass crack

- Pay attention to the intermediate glass panel that could accidentally come out of its seat during this phase.



Cleaning and maintenance

4. Remove the intermediate glass panel.
First raise it upwards (1) and then remove it pulling it downwards (2).

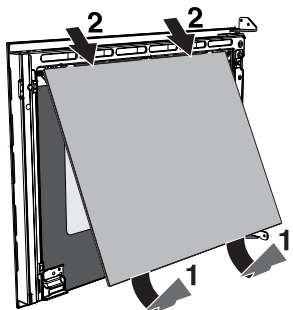

5. Clean the external glass panel and the panels previously removed. Use absorbent kitchen roll. In case of stubborn dirt, wash with a damp sponge and neutral detergent.

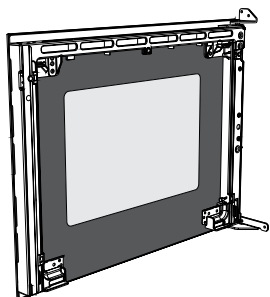

6. Replace the panels in the reverse order in which they were removed.
7. Reposition the internal glass panel. Take care to centre and insert the 4 pins into their housings in the oven door by applying slight pressure.

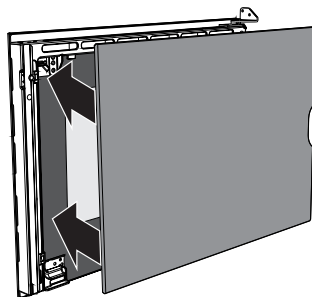

Auxiliary oven door

1. Remove the internal glass panel by pulling the rear part gently upwards, following the movement indicated by the arrows (1).
2. Then, pull the front part upwards (2). In this way, the 4 pins attached to the glass detach from their housings in the oven door.

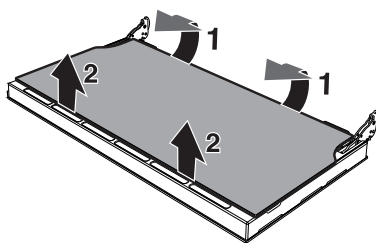

3. Remove the intermediate glass panel by lifting it upwards.

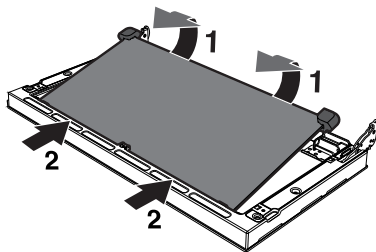

4. Clean the external glass panel and the panels previously removed. Use



absorbent kitchen roll. In case of stubborn dirt, wash with a damp sponge and neutral detergent.

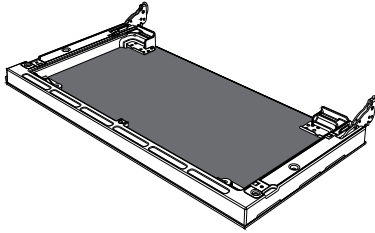

5. Replace the panels in the reverse order in which they were removed.
6. Reposition the internal glass panel. Take care to centre and insert the 4 pins into their housings in the oven door by applying slight pressure.

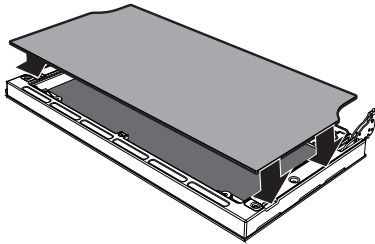

4.6 Cleaning the inside of the oven

For the best oven upkeep, clean it regularly after having allowed it to cool. Take out all removable parts.



Clean the oven racks with warm water and non-abrasive detergent. Carefully rinse and dry the damp parts.



The oven should be operated at the maximum temperature for about 15-20 minutes after the use of specific products, to burn off the residues left inside the oven.



For easier cleaning, remove the door.

Removing racks/trays support frames

Removing the guide frames enables the sides to be cleaned more easily. This operation should be performed each time the automatic cleaning cycle is used (on some models only).

To remove the guide frames: pull the frame towards the inside of the oven to unhook it from its groove **A**, then slide it out of the seats **B** at the back.

When cleaning is complete, repeat the above procedures to put the guide frames back in.

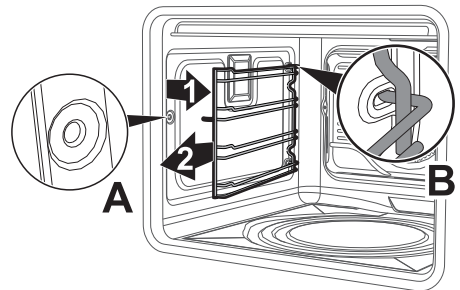



Cleaning and maintenance

4.7 Vapor Clean: assisted oven cleaning



Vapor Clean is an assisted cleaning procedure which facilitates the removal of dirt. Thanks to this process, it is possible to clean the inside of the oven very easily. The dirt residues are softened by the heat and water vapour for easier removal afterwards.



Improper use Risk of damage to surfaces

- Remove any food residues or large spills from previous cooking operations from the inside of the oven.
- Carry out assisted oven cleaning operations only when the oven is cold.

Preliminary operations

Before starting the Vapor Clean function:

- Completely remove all accessories from inside the oven. The roof lining can be left inside the oven.
- Pour approx. 40 cc of water onto the floor of the oven. Make sure it does not overflow out of the cavity.

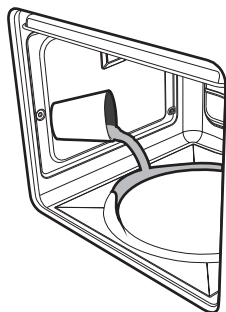

- Spray a water and washing up liquid solution inside the oven using a spray nozzle. Direct the spray against the side walls, upwards, downwards and towards the deflector.

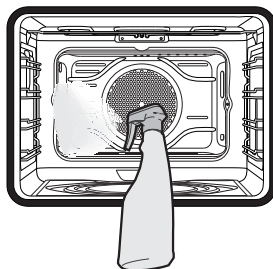

- Close the door.



We recommend spraying approx. 20 times at the most.

Vapor Clean setting

1. Turn the function knob and the temperature knob to the  symbol.
2. Set a cooking time of 18 minutes using the cooking time procedure described in more detail in "Programmed cooking";
3. The Vapor Clean cycle starts approximately 6 seconds after the last pressure on the programmer's keys.
4. At the end of the Vapor Clean cycle, the timer will deactivate the oven heating elements, the buzzer will start to sound and the numbers on the dial will flash.

End of the Vapor Clean cycle

5. Open the door and wipe away the less stubborn dirt with a microfibre cloth.
6. Use an anti-scratch sponge with brass filaments on tougher encrustations.



7. In case of grease residues use specific oven cleaning products.

8. Remove the water left inside the oven.

For improved hygiene and to avoid food being affected by any unpleasant odours, we recommend that the oven is dried using a fan-assisted function at 160°C for approximately 10 minutes.



We recommend that you use rubber gloves for these operations.



For easier manual cleaning of the parts difficult to reach, we recommend that you remove the door.

4.8 Extraordinary maintenance



Live parts
Danger of electrocution

- Disconnect the oven power supply.

Replacing the internal light bulb

1. Completely remove all accessories from inside the oven.
2. Remove the racks/trays support frames.
3. Remove the bulb cover using a tool (e.g. a screwdriver).

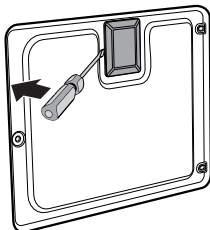

4. Slide out and remove the lamp.

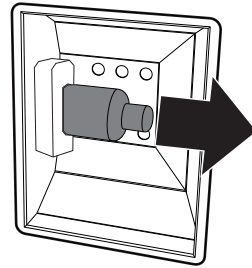

Do not touch the halogen lamp directly with your fingers, but wrap it in insulating material.

5. Replace the lamp with one of the same type (40W).
6. Refit the cover correctly, so that the moulded part of the glass is facing the door.
7. Press the cover completely down so that it attaches perfectly to the bulb support.

Removing the seal of the auxiliary oven

To permit thorough cleaning of the oven, the door seal can be removed. There are hooks on all four sides to attach it to the edge of the oven. Pull the edges of the seal outwards to detach the hooks.

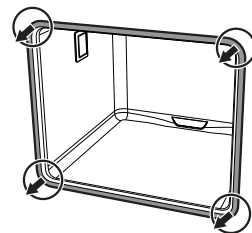

To keep the seals clean, use a non-abrasive sponge and lukewarm water. Seals should be soft and elastic.



Installation

5 Installation

5.1 Clearances above and around domestic appliances

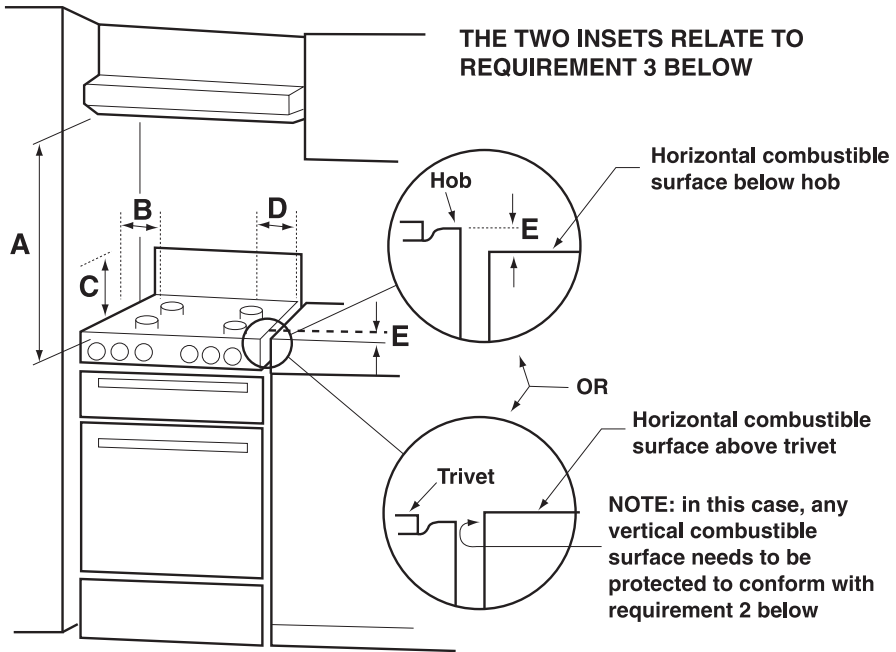

Requirements

1. **Overhead clearances – (Measurement A)** Range hoods and exhaust fans shall be installed in accordance with the manufacturer’s instructions and AS/NZS 5601 - current edition. However, in no case shall the clearance between the highest part of the hob of the cooking appliance and a range hood be less than 600 mm or, for an overhead exhaust fan, 750 mm. Any other downward facing combustible surface less than 600 mm above the highest part of the hob shall be protected for the full width and depth of the cooking surface area in accordance with Clause 5.12.1.2. However, in no

case shall this clearance to any surface be less than 450 mm.

2. **Side clearances – (Measurements B & C)** Where B, measured from the periphery of the nearest burner to any vertical combustible surface, is less than 200 mm, the surface shall be protected in accordance with Clause 5.12.1.2 to a height C of not less than 150 mm above the hob for the full dimension (width or depth) of the cooking surface area. Where the cooking appliance is fitted with a ‘splashback’, protection of the rear wall is not required.



3. Additional requirements for Freestanding and Elevated Cooking Appliances – (Measurements D & E)

Where D, the distance from the periphery of the nearest burner to a horizontal combustible surface is less than 200 mm, then E shall be 10 mm or more, or the horizontal surface shall be above the trivet. See insets above.

Notes

1. Requirement 3 does not apply to a freestanding or elevated cooking appliance which is designed to prevent flames or the cooking vessels from extending beyond the periphery of the appliance.
2. The 'cooking surface area' is defined as that part of the appliance where cooking normally takes place and does not include those parts of the appliance containing control knobs.
3. For definition of hob, only refer AS/NZS 5601 - current edition.
4. For definition of trivet, only refer AS/NZS 5601 - current edition.
5. Consideration is to be given to window treatments when located near cooking appliances. only refer AS/NZS 5601 - current edition.



The appliance connection point shall be accessible with the appliance installed.

5.2 Gas connection



Gas leak

Danger of explosion

- After carrying out any operation, check that the tightening torque of gas connections is between 10 Nm and 15 Nm.
- If required, use a pressure regulator that complies with current regulations.
- At the end of the installation, check for any leaks with a soapy solution, never with a flame.
- Installation with flexible hose must be carried out so that the length of the piping does not exceed 1.2 metres when fully extended; make sure that the hoses do not come into contact with moving parts and that they are not crushed in any way.
- The hoses should not to contact any surface which may become hot.

General informations

This appliance is suitable for installation with Natural Gas or ULPG (propane/butane). Refer to "Burner and nozzle characteristics tables" paragraph for the relevant burner pressure and appropriate injector sizes. When the appliance is to be connected to Natural Gas then the pressure regulator supplied must be fitted to the gas inlet. A test point (for checking the gas pressure) is supplied either with the regulator or as a separate fitting in the case of ULPG (propane) appliances.



Installation

Connection of the appliance to the gas supply must be in accordance with the requirements of AS/NZS5601. A 1/2" BSP connector at the inlet is recommended and the gas supply line to the appliance must be of adequate length to allow sufficient withdrawal of appliance for service or disconnection and be:

1. annealed copper pipe or;
2. flexible hose according to AS/NZS1869 & be at least Class "B", 10 mm diameter.

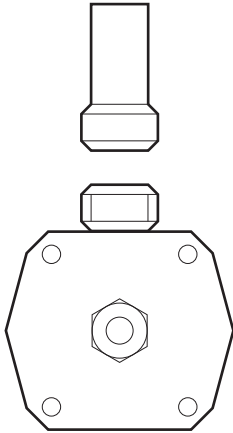

The appliance must be installed with provision to allow the gas to be turned off and disconnected for servicing and removal of the appliance as required from the gas supply. Before the appliance is operated make certain all relevant parts are placed in the correct position.

On completion of the installation, the installer **MUST** check for gas leaks and test each burner individually for the correct flame. Once all burners have been tested individually, turn all burners on together. Warranty service calls do not cover these adjustments!

To check the operating pressure of the appliance it is recommended at least 2 large size burners are used. Ensure appliance is secured to wall when installation is completed.

N.G. The regulator supplied must be fitted to the 1/2 BSP thread at the rear of the appliance. An approved manual shut-off valve must be installed. The N.G. regulator must be checked and adjusted to 1.0kPa after installation.

U.L.P.G. Can be connected to the inlet fitting directly. The pressure must be checked to ensure it is operating at 2.75kPa. A separate test point fitting must be installed between the piping & the appliance for the pressure to be checked to ensure it is operating at 2.75kPa.

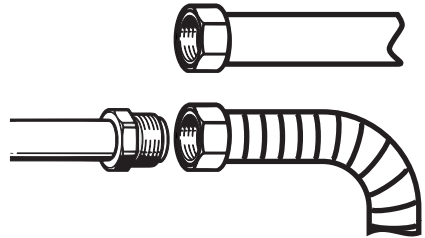

Connection to liquid gas

Use a pressure regulator and make the connection on the gas cylinder following the guidelines set out in the regulations in force.

Make sure that the supply pressure complies with the values indicated in the paragraph "Burner and nozzle characteristics tables".

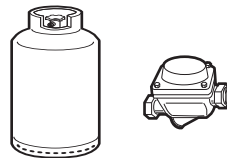



Room ventilation

The room containing the appliance should have a permanent air supply in accordance with the standards in force. The room where the appliance is installed must have enough air flow needed for the regular combustion of gas and the necessary air change in the room itself. The hob shall be installed in rooms with natural ventilation, as required by Standards regulations AS/NZS5601.

Combustion gas discharge

Combustion gases may be discharged by means of hoods connected to a flue with reliable natural draught, or a fan extraction system. An effective extraction system requires careful design by an authorised specialist, and must comply with the regulation distances and positions. After installation, the engineer must issue a certificate of compliance.

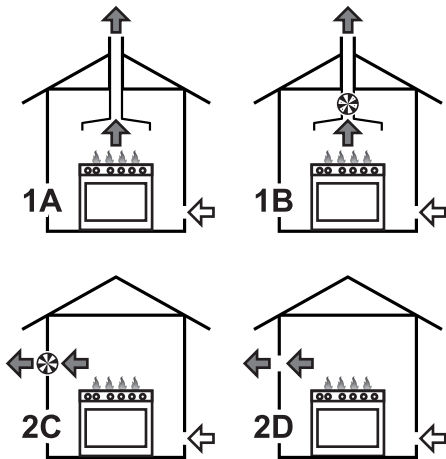

- 1 Extraction using a hood.
- 2 Extraction without a hood.

- A Single natural draught chimney.
- B Single chimney with extractor fan.

- C Directly outdoors with wall- or window-mounted extractor fan.
- D Directly outdoors through wall.

- Air
- Combustion products
- Extractor fan

5.3 Adaptation to different types of gas

In case of operation with other types of gas, the burner nozzles must be changed and the minimum flame adjusted on the gas taps.

Replacing nozzles

1. Remove the pan stands, burner caps and flame-spreader crowns to access the burner casings.
2. Replace the nozzles using a 7 mm socket wrench according to the gas to use (see "Burner and nozzle characteristics tables").

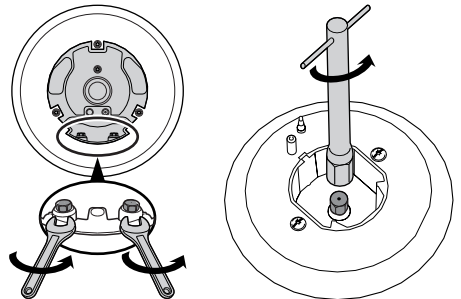

3. Replace the burners in the correct position.



Installation

Adjusting the minimum setting for natural or city gas

Light the burner and turn it to the minimum position. Extract the gas tap knob and turn the adjustment screw next to the tap rod (depending on the model) until the correct minimum flame is achieved.

Refit the knob and verify that the burner flame is stable.

Turn the knob rapidly from the maximum to the minimum setting; the flame should not go out. Repeat the operation on all gas taps.

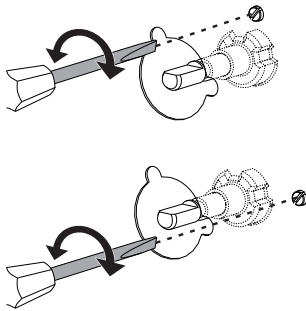

Adjusting the minimum setting for LPG

Tighten the screw located at the side of the tap rod clockwise all the way.



Following adjustment to a gas other than the one originally set in the factory, replace the gas setting label fixed to the appliance with the one corresponding to the new gas. The label is inserted inside the nozzle pack (where present).

Lubrication of gas taps

Over time the gas taps may become difficult to turn and get blocked. Clean them internally and replace the lubrication grease.



The greasing of the gas taps should be performed by a specialised technician.

Burner and nozzle characteristics tables

1 ULPG 2.75 kPa	AUX	SR	R	UR2
Nominal gas consumption (MJ/h)	3.9	6.3	10.8	13.5
Injector (1/100 mm)	54	68	88	46 + 90
2 NG 1.0 kPa	AUX	SR	R	UR2
Nominal gas consumption (MJ/h)	3.9	7.5	12	15.2
Injector (1/100 mm)	90	120	155	80 + 165



5.4 Electrical connection



**Power voltage
Danger of electrocution**

- Have the electrical connection performed by authorised technical personnel.
- Use personal protective equipment.
- The appliance must be connected to earth in compliance with electrical system safety standards.
- Disconnect the main power supply.
- Do not pull the cable to remove the plug.
- Use cables withstanding a temperature of at least 90°C.
- The tightening torque of the screws of the terminal supply wires must be 1.5 - 2 Nm.

General information

Check the grid characteristics against the data indicated on the plate.

The identification plate bearing the technical data, serial number and brand name is visibly positioned on the appliance.

Do not remove this plate for any reason.

Perform the ground connection using a wire that is 20 mm longer than the other wires.

The appliance can work in the following modes:

- **220-240 V 1N~**

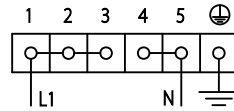

use a **3 x 6 mm² three-core** cable.

- **380-415 V 2N~**

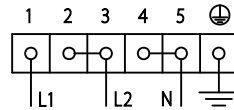

use a **4 x 4 mm² four-core** cable.

- **380-415 V 3N~**

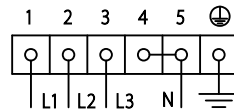

use a **5 x 1.5 mm² five-core** cable.



The values indicated above refer to the cross-section of the internal conductor.



The aforementioned power cables are sized taking into account the coincidence factor (in compliance with standard EN 60335-2-6).



Installation

Fixed connection

Fit the power line with an omnipolar circuit breaker in compliance with installation regulations.

The circuit breaker should be located near the appliance and in an easily reachable position.

Connection with plug and socket

Make sure that the plug and socket are of the same type.

Avoid use of adapters and shunts as these could cause overheating and a risk of burns.

Overall dimensions

Location of gas and electrical connection points.

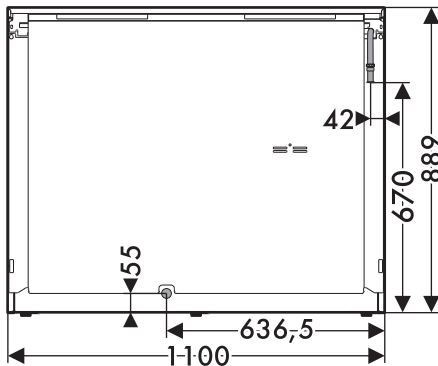

5.5 Positioning



Heavy appliance
Danger of crush injuries

- Place the appliance into the piece of furniture with the aid of a second person.



Pressure on the open door
Risk of damages to the appliance

- When positioning the appliance during installation, do not use the door handle to lift up or move this appliance.
- Never use the oven door to lever the appliance into place when fitting.
- Avoid exerting too much pressure on the oven door when open.



Heat production during appliance operation
Risk of fire

- Veneers, adhesives or plastic coatings on adjacent furniture should be temperature-resistant (no less than 90°C).



General information

This appliance may be installed next to walls, one of which must be higher than the worktop, at a minimum distance of 50 mm from the side of the appliance.

Any wall units positioned above the worktop must be at a minimum distance of at least 750 mm. If a hood is installed above the hob, refer to the hood instruction manual to ensure the correct clearance is left.



The appliance must be installed by a qualified technician and according to the regulations in force.

Assembling the skirt



The skirt provided is an integral part of the product; it must be fastened to the appliance prior to installation.

The skirt must always be positioned and secured correctly on the appliance.

1. Loosen the 6 screws on the back of the top (A) and unscrew the 2 screws (B) on the side part of the skirt.

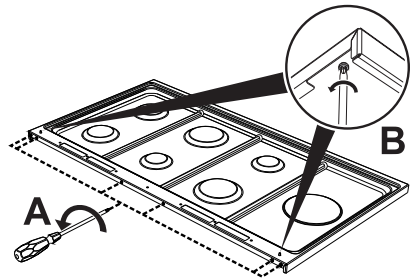

2. Place the skirt on the top. Align the 6 bottom slots of the skirt with the 6 screws on the back of the top that were previously loosened.
3. Tighten the 6 screws on the back of the hob (A) and tighten the 2 screws under the top (B) to secure the skirt.

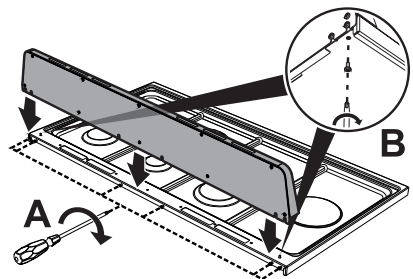



Installation

Mounting the bottom skirting

i The bottom skirting provided is an integral part of the product; it must be fastened to the appliance prior to installation.

The bottom skirting must always be positioned and secured correctly on the appliance.

1. Place the skirting in the front bottom part of the appliance.
2. Screw the two side screws to fasten the skirting to the appliance.
3. Cover the holes of the skirting with the plugs provided.

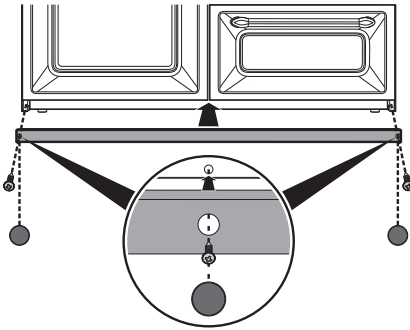

Wall fixing

1. Attach the chain to the cooker
2. Stretch out the chain attached to the cooker horizontally so that the other end touches the wall.
3. Mark the wall in the position where the hole is to be drilled.
4. Drill the hole, insert a wall plug and attach the chain.
5. Once the chain is in position, push the cooker against the wall and reduce the amount of chain links to keep the chain tight to prevent any excess movement.

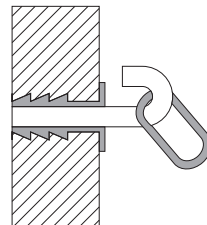
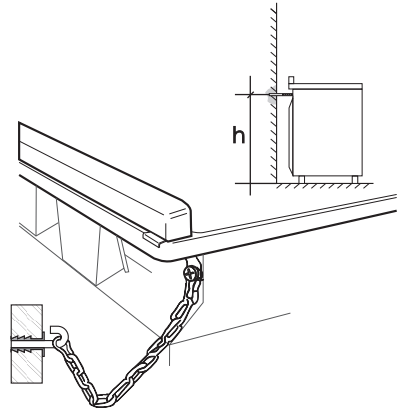

914775893/B

IN CASE OF ABNORMAL OPERATION SUCH AS FAILURE TO LIGHT OR
YELLOW FLAMES CONTACT YOUR LOCAL DEALER FOR SERVICE ATTENTION.

CIRCUIT DIAGRAM

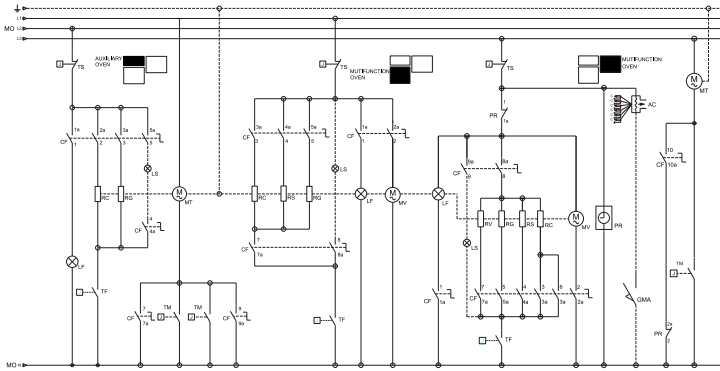

LEGEND

CF	SELECTOR SWITCH CONTACTS	TM	COOLING FAN CONTROL THERMOSTAT	RS	LOWER HEATING ELEMENT	LF	COOKER LAMPS	AC	SPARK IGNITER
TS	THERMAL CUT-OUT	C	SPARK PLUGS	RV	CIRCULAR HEATING ELEMENT	LS	THERMOSTAT SIGNALLING LAMP	GMA	SPARK IGNITER MICROSWITCH
PR	ELECTRONIC PROGRAMMER	RC	UPPER HEATING ELEMENT	TF	OVEN THERMOSTAT	MO	TERMINAL STRIP	L	PHASE
MV	COOLING FAN MOTOR	RG	BROIL-GRILL ELEMENT	MT	COOLING FAN MOTOR	MP	DOOR LIMIT SWITCH	N	NEUTRAL

STABILISING MEANS MUST BE FITTED TO THIS PRODUCT. REFER TO INSTRUCTIONS.

ADJUSTED FOR NATURAL GAS 1.0 kPa

THIS COOKER IS SUITABLE FOR
A HOSE ASSEMBLY INSTALLATION.

DANGER, 240 V ac
DISCONNECT POWER BEFORE SERVICING UNIT.

TO BE INSTALLED BY AN AUTHORIZED PERSON ONLY

The manufacturer reserves the right to make any changes deemed useful for improvement of his products without prior notice. The illustrations and descriptions contained in this manual are therefore not binding and are merely indicative.

Space for rating plate



914775893/B