

# CANDY

## OVENS USER INSTRUCTIONS

GB



## GENERAL WARNINGS

Thank you for choosing one of our products. To get the most out of your oven we recommend that you:

- Read the notes in this manual carefully: they contain important instructions on how to install, use and service this oven safely.
- Keep this booklet in a safe place for easy, future reference.

When the oven is first switched on it may give out acrid smelling fumes. This is because the bonding agent for insulating panels around the oven has been heated up for the first time.

This is a completely normal, if it does occur you merely have to wait for the fumes to clear before putting the food into the oven. An oven by its very nature becomes very hot. Especially the glass of the oven door.

Do not allow children to go near the oven when it is hot, especially when the grill is on.

## DECLARATION OF COMPLIANCE

- The parts of this appliance that may come into contact with foodstuffs comply with the provisions of EEC Directive 89/109.

CE Appliance complies with European Directives 73/23/EEC and 89/336/EEC, replaced by 2006/95/EC and 2004/108/EC, and subsequent amendments.

When you have unpacked the oven, make sure that it has not been damaged in any way. If you have any doubts at all, do not use it: contact a professionally qualified person. Keep packing materials such as plastic bags, polystyrene, or nails out of the reach of children because they are dangerous for children.

## SAFETY HINTS

- The oven must be used only for the purpose for which it was designed: it must only be used for cooking food. Any other use, e.g. as a form of heating, is an improper use of the oven and is therefore dangerous.
- The manufacturers cannot be held responsible for any damage caused by improper, incorrect or unreasonable use. **When using any electrical appliance you must follow a few basic rules.**
  - Do not pull on the power cable to remove the plug from the socket.
  - Do not touch the oven with wet or damp hands or feet.
  - Do not use the oven unless you are wearing something on your feet.
  - Do not allow children or irresponsible people to use the oven unless they are carefully supervised.
  - It is not generally a good idea to use adapters, multiple sockets for several plugs and cable extensions.
  - If the oven breaks down or develops a fault switch it off at the mains and do not touch it.
- If the cable is at all damaged it must be replaced promptly. When replacing the cable, follow these instructions. Remove the power cable and replace it with one of the HO5RR-F, H05VV-F, H05V2V2-F type. The cable must be able to bear the electrical current required by the oven. Cable replacement must be carried out by properly qualified technicians. The earthing cable (yellow-green) must be 10 mm longer than the power cable. Use only an approved service centre for repairs and ensure that only original parts are used. If the above instructions are not adhered to the manufacturers cannot guarantee the safety of the oven.
- This appliance is not intended for use by persons (including children) with reduced physical, sensory or mental capabilities, or lack of experience and knowledge, unless they have been given supervision or instruction concerning use of the appliance by a person responsible for their safety.
- Children should be supervised to ensure that they do not play with the appliance.

## INSTALLATION

Installation is the customer's responsibility. The manufacturers have no obligation to carry this out. If the assistance of the manufacturer is required to rectify faults arising from incorrect installation, this assistance is not covered by the guarantee. The installation instructions for professionally qualified personnel must be followed. Incorrect installation may cause harm or injury to people, animals or belongings. The manufacturer cannot be held responsible for such harm or injury.

## FITTING THE OVEN INTO THE KITCHEN UNIT

Fit the oven into the space provided in the kitchen unit; it may be fitted underneath a work top or into an upright cupboard. Fix the oven in position by screwing into place, using the four fixing holes in the frame.

To locate the fixing holes, open the oven door and look inside. To allow adequate ventilation, the measurements and distances indicated in the diagram on front page must be adhered to when fixing the oven.

Note: For ovens that are combined with a hob unit the instructions contained in the manual for the hob unit must be followed.

## IMPORTANT

If the oven is to work properly, the kitchen housing must be suitable. The panels of the kitchen unit that are next to the oven must be made of a heat resistant material. Ensure that the glues of units made of veneered wood can withstand temperatures of at least 120 °C. Plastics or glues that cannot withstand such temperatures will melt and deform the unit. Once the oven has been lodged inside the unit, the electrical parts must be completely insulated. This is a legal safety requirement. All guards must be firmly fixed into place so that it is impossible to remove them without using special tools.

**Remove the back of the kitchen unit to ensure an adequate current of air circulates around the oven. The hob must have a rear gap of at least 45 mm.**

## CONNECTING TO THE POWER SUPPLY

Plug into the power supply. Ensure first that there is a third contact that acts as earthing for the oven. **The oven must be properly earthed.**

If the model of oven is not fitted with a plug, fit a standard plug to the power cable. It must be able to bear the power supply indicated on the specifications plate. The earthing cable is yellow-green. The plug must be fitted by a properly qualified person. If the socket and the plug are incompatible the socket must be changed by a properly qualified person. A properly qualified person must also ensure that the power cables can carry the current required to operate the oven.

An ON/OFF switch with a minimum distance of 3 mm between contacts may also be connected to the power supply. The connections must take account of the current supplied and must comply with current legal requirements. The yellow-green earthing cable must not be governed by the ON/OFF switch. The socket or the ON/OFF switch used for connecting to the power supply must be easily accessible when the oven has been installed. Important: During installation, position the power cable in such a way that it will not be subjected to temperatures of above 50°C at any point.

The oven complies with safety standards set by the regulatory bodies. The oven is safe to use only if it has been adequately earthed in compliance with current legal requirements on wiring safety. You must ensure that the oven has been adequately earthed.

**The manufacturers cannot be held responsible for any harm or injury to persons, animals or belongings caused by failure to properly earth the oven.**

**WARNING: the voltage and the supply frequency are showed on the rating plate (fig. on front page).**

The cabling and wiring system must be able to bear the maximum electric power required by the oven. This is indicated on the specifications plate.

If you are in any doubt at all, use the services of a professionally qualified person.

## USEFUL TIPS

### SHELF SAFETY SYSTEM

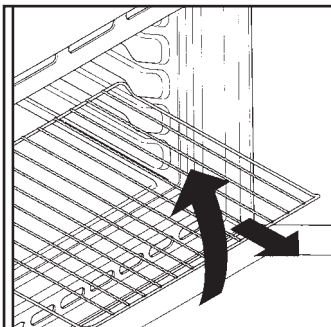

The oven features a new shelf safety system. This allows you to pull out the oven shelves when inspecting the food without danger of food spillages or shelves falling accidentally out of the oven. To remove the shelves pull out and lift.

### GRILLING

Grilling makes it possible to give food a rich brown colour quickly. For browning we recommend that you insert the grill onto the fourth level, depending on the proportions of the food (see fig. page 6).

Almost all food can be cooked under the grill except for very lean game and meat rolls.

Meat and fish that are going to be grilled should first be lightly doused with oil.

### COOKING TIME

For recommended cooking times and temperatures the first time you use the oven, refer to the tables on pages 6, 7. You may then wish to vary these times and settings in the light of your own experience.

### CLEANING AND MAINTENANCE

Clean the stainless steel and enamelled surfaces with warm, soapy water or with suitable brand products. On no account use abrasive powders that may damage surfaces and ruin the oven's appearance. It is very important to clean the oven each time that it is used. Melted fat is deposited on the sides of the oven during cooking. The next time the oven is used this fat could cause unpleasant odours and might even jeopardise the success of the cooking. Use hot water and detergent to clean; rinse out thoroughly. To make this chore unnecessary all models can be lined with catalytic self-cleaning panels: these are supplied as an optional extra (see the section SELF-CLEANING OVEN WITH CATALYTIC LINING).

Use detergents and abrasive metal pads like «brillo pads» for the stainless steel grills.

The glass surfaces as the top, oven door and warming compartment door must be cleaned when they are cold. Damage that occurs to them because this rule was not adhered to are not covered by the guarantee.

To replace the interior light: switch off the mains power supply and unscrew bulb. Replace with an identical bulb that can withstand very high temperatures.

### SELF-CLEANING OVEN WITH CATALYTIC

Special self-cleaning panels covered in a micro-porous coating are available as optional extras for all models. If they are fitted, the oven no longer needs to be cleaned by hand. The fat that is splattered onto the sides of the oven during roasting is eliminated by the microporous coating which breaks the fat down by catalysis and transforms it into gas.

Excessive splattering may nevertheless block the pores and therefore hinder self-cleaning. The self-cleaning capacity may be restored by switching on the empty oven to maximum for about 10-20 minutes.

Do not use abrasive products, metal cleaning wads, sharp objects, rough cloths, or chemical products and detergents that may permanently damage the catalytic lining.

It is a good idea to use deep roasting trays to roast fatty foods such as joints of meat etc. and to put a tray underneath the grill to catch surplus fat.

If the walls of the oven are so thickly coated in grease that the catalytic lining is no longer effective remove surplus grease with a soft cloth or sponge soaked in hot water.

The lining must be porous for self-cleaning to be effective.

N.B.: All catalytic linings currently on the market have a working life of about 300 hours. They should therefore be replaced after about 300 hours.

### FOLD DOWN GRILL (according to the models)

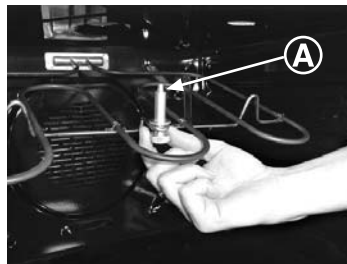

For routine cleaning access can be gained to the upper parts of the oven by removing the screw and washer (A) from the middle of the grill element and then gently tilting the element in a downward direction.

Once cleaned the grill can be returned to the correct position by reversing the above procedure.

NB: For cleaning instructions please refer to the section entitled cleaning and maintenance.

WARNING: the oven must only be used when the grill in its correct position.

### SERVICE CENTRE

Before calling the Service Centre

If the oven is not working, we recommend that:

- you check that the oven is properly plugged into the power supply.

If the cause of the fault cannot be detected:

disconnect the oven from the mains, do not touch the oven and call the after sales service.

**Before calling the Service Centre remember to make a note of the serial number on the serial number specifications plate (see fig. on front page).**

The oven is supplied with a guarantee certificate that ensures that it will be repaired free of charge by the Service Centre.



This appliance is marked according to the European directive 2002/96/EC on Waste Electrical and Electronic Equipment (WEEE). By ensuring this product is disposed of correctly, you will help prevent potential negative consequences for the environment and human health, which could otherwise be caused by inappropriate waste handling of this product. The symbol on the product indicates that this product may not be treated as household waste.

Instead it shall be handed over to the applicable collection point for the recycling of electrical and electronic equipment. Disposal must be carried out in accordance with local environmental regulations for waste disposal.

For more detailed information about treatment, recovery and recycling of this product, please contact your local city office, your household waste disposal service or the shop where you purchased the product.

## USING THE MINUTE TIMER

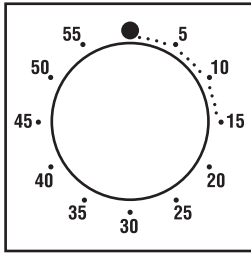

To set the cooking time, turn dial one complete revolution and then position the index to the required time. When the time has lapsed, the signal will ring for a few seconds.

## USING THE END OF COOKING TIMER

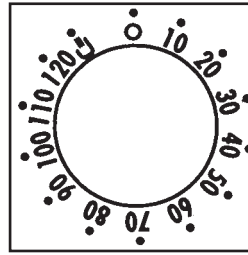

This control enables to set the desired cooking time (max. 120 min.) the oven will automatically switch off at the end of the set time.

The timer will count down from the set time return to the **O** position and switch off automatically.

For normal use of oven set the timer to the position.

To set the oven ensure the timer is not on the **O** position.



To set the time, push the control knob and turn anti-clockwise to position at the correct time. To set as minute minder, set the cooking time by turning anticlockwise the knob without pushing, until the desired time is shown at the small window on the left of the clock (max. 180 minutes). When the preset time is elapsed the alarm will ring and the oven must be switched off manually. To stop the alarm turn the knob until appears in the window.

## USE OF THE ELECTRONIC PROGRAMMER

FUNCTION	HOW TO ACTIVATE IT	HOW TO SWITCH IT OFF	WHAT IT DOES	WHAT IT IS FOR
<b>MINUTE MINDER</b>	<ul style="list-style-type: none"> <li>Press and hold the button </li> <li>Press the buttons  or </li> <li>Release all the buttons</li> </ul>	<ul style="list-style-type: none"> <li>When the set time as elapsed an audible alarm is activated (this alarm will stop on its own, however it can be stopped immediately by pressing the button) </li> </ul>	<ul style="list-style-type: none"> <li>Sounds an alarm at the end of the set time.</li> <li>To check how long is left to run press the button </li> </ul>	<ul style="list-style-type: none"> <li>Allows to use the oven as alarm clock (could be activated either with operating the oven or with out operating the oven)</li> </ul>
<b>MANUAL FUNCTION</b>	<ul style="list-style-type: none"> <li>Press the button </li> <li>Set the cooking function with the oven function selector</li> </ul>	<ul style="list-style-type: none"> <li>Turn the oven function selector to position <b>O</b>.</li> </ul>	<ul style="list-style-type: none"> <li>Enables you to operate the oven.</li> </ul>	<ul style="list-style-type: none"> <li>For cooking the desired recipes</li> </ul>
<b>COOKING TIME</b>	<ul style="list-style-type: none"> <li>Press and hold the <b>TIMER</b> button</li> <li>Press the buttons  or  to set the length of cooking required</li> <li>Release all buttons</li> <li>Set the cooking function with the oven function selector</li> </ul>	<ul style="list-style-type: none"> <li>When the time is elapsed the oven will switch off automatically. Should you wish to stop cooking earlier either turn the function selector to 0, or set time to 0:00 (<b>TIMER</b> and   buttons)</li> </ul>	<ul style="list-style-type: none"> <li>It allows to preset the cooking time required for the recipe chosen</li> <li>To check how long is left to run press the <b>TIMER</b> button.</li> <li>To alter/change the preset time press <b>TIMER</b> and   buttons</li> </ul>	<ul style="list-style-type: none"> <li>At the end of the cooking set time, the oven will switch off automatically and an audible alarm will ring.</li> </ul>
<b>END OF COOKING</b>	<ul style="list-style-type: none"> <li>Press and hold the <b>END</b> button</li> <li>Press the buttons   to set the time at which you wish the oven to switch off</li> <li>Release the buttons</li> <li>Set the cooking function with the oven function selector</li> </ul>	<ul style="list-style-type: none"> <li>At the time set, the oven will switch off. To switch off manually, turn the oven function selector to position <b>O</b>.</li> </ul>	<ul style="list-style-type: none"> <li>Enables you to set the end of cooking time</li> <li>To check the preset time press the <b>END</b> button</li> <li>To modify the preset time press buttons <b>END</b> +  </li> </ul>	<ul style="list-style-type: none"> <li>This function is typically used with "cooking time" function. For example if the dish has to be cooked for 45 minutes and needs to be ready by 12:30, simply select the required function, set the cooking time to 45 minutes and the end of cooking time to 12:30.</li> <li>Cooking will start automatically at 11:45 (12:30 minus 45 mins) and will continue until the pre-set end-of-cooking-time, when the oven will switch itself off automatically.</li> </ul>

## SETTING THE CORRECT TIME

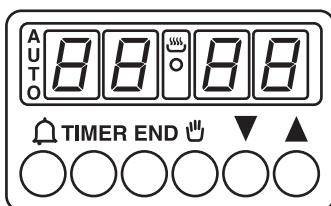

**WARNING :** the first operation to carry out after the oven has been installed or following the interruption of power supply (this is recognizable the display pulsating and showing **0:00**) is setting the correct time. This is achieved as follows

- Press and hold the **TIMER** and **END** buttons ( and **TIMER** on some models)
- Set time with buttons
- Release all buttons

**ATTENTION** the oven only operates if set on manual function or preset time.

**N.B.:** on some models the symbols are replaced by and .

### **WARNING.**

**If the END of cooking is selected without setting the length of cooking time, the oven will start cooking immediately and it will stop at the END of cooking time set.**



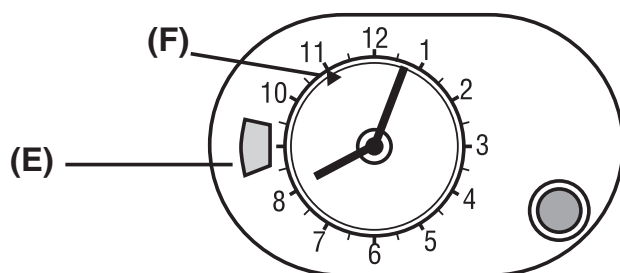

## USE OF ANALOGUE CLOCK/PROGRAMMER



### SETTING THE CORRECT TIME

To set the correct time push and turn anti-clockwise the knob until the clock shows the correct time. Once this is done release the control.

**ATTENTION :** the oven only operates if set on manual function or preset time.

FUNCTION	HOW TO ACTIVATE IT	HOW TO SWITCH IT OFF	WHAT IT DOES	WHAT IT IS FOR
<b>MANUAL FUNCTION</b>	<ul style="list-style-type: none"> <li>Turn the control knob anti-clockwise, without pushing, until the symbol  appears in the window (E)</li> </ul>	<ul style="list-style-type: none"> <li>Turn the oven function selector to position O.</li> </ul>	<ul style="list-style-type: none"> <li>Enables you to operate the oven.</li> </ul>	<ul style="list-style-type: none"> <li>For cooking the desired recipes</li> </ul>
<b>COOKING TIME</b>	<ul style="list-style-type: none"> <li>First of all select the cooking function and the temperature required</li> <li>Set the length of cooking required by turning the control knob anticlockwise until the time matches the length of time shown in the window (E)</li> <li>The oven will start immediately and it will switch off automatically at the end of the preset time</li> <li>Max time 180 minutes (3 hours)</li> </ul>	<ul style="list-style-type: none"> <li>At the end of the set time the oven switches off automatically, this is indicated by an audible alarm.</li> <li>To cancel the setting turn the control knob until the symbol  appears in the window (E)</li> </ul>	<ul style="list-style-type: none"> <li>It allows you to preset the cooking time required for the recipe chosen.</li> </ul>	<ul style="list-style-type: none"> <li>At the end of the cooking time set, the oven will switch off automatically and an audible alarm will ring.</li> </ul>
<b>END OF COOKING</b> <i>(Not available on model 2D 364.)</i>	<ul style="list-style-type: none"> <li>First of all select the cooking function and the temperature required.</li> <li><b>To set the cooking start time</b> pull and turn the control knob anticlockwise until the hand F is in the position indicating the start time required.</li> <li><b>To set the length of cooking</b> required turn clockwise the control knob without pushing it, until the time required appears in the window (E).</li> </ul>	<ul style="list-style-type: none"> <li>At the end of cooking time set the oven will switch off automatically and an audible alarm will ring.</li> <li>To cancel the set function turn the control knob anti-clockwise until the symbol  appears in the window (E)</li> <li>The alarm have to be stopped by turning the control knob until the symbol  appears in the window (E)</li> </ul>	<ul style="list-style-type: none"> <li>Enables to program the oven so that the recipe is ready at the desired time</li> </ul>	<ul style="list-style-type: none"> <li>Example: if the dish has to be cooked for 45 minutes and needs to be ready by 12:30;                             <ul style="list-style-type: none"> <li>- Select the required function</li> <li>- Set start cooking time at 11:45 (12:30 minus 45 minutes)</li> <li>- Set cooking time at 45 minutes</li> </ul> </li> <li><b>At the end of cooking the oven will automatically switch off.</b></li> </ul>

# OPERATING INSTRUCTIONS

Our range includes many different styles and colours. To find the technical specifications and functions of the model which you have bought, study the diagrams below. Some models feature push/pull knobs, press to eject before rotating. During oven operation the internal lamp is on.

## STATIC OVEN - MULTI-FUNCTION OVEN

Function selector control knob (example)



Grill control knob (example)

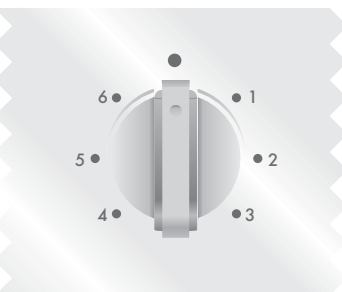

Thermostat control knob (example)

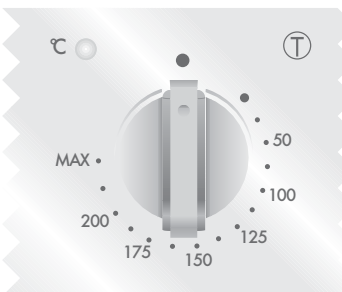

Combined function and temperature control (convection ovens only)

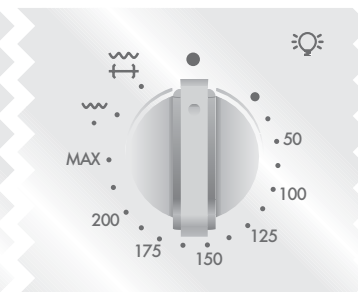

Function dial	Thermostat dial	Function	Static oven	Multi-function oven
		Turns on the oven light This will automatically activate the cooling fan (on fan cooled models only)	●	●
	50	<b>Defrosting</b> When the dial is set to this position. The fan circulates air at room temperature around the, frozen food so that it defrosts in a few minutes without the protein content of the food being changed or altered.		○
	50 ÷ MAX	<b>Fan oven</b> Air that has been heated is blown by the fan onto the different levels. It is ideal for cooking different types of food at the same time (e.g. meat and fish) without mixing tastes and smells. It cooks very gently and is ideal for sponge cakes, pastries, etc.		○
	50 ÷ 200	<b>Door closed fan grill</b> The air is heated by the grill element and the fan blows the air onto the food at the required temperature. This ranges from 50°C to 200°C. The grill/fan is an excellent alternative to roasting on the spit. It is ideal for roasting even large quantities of poultry, sausages and red meats.		●
	50 ÷ MAX	<b>Fan plus lower element</b> This function is ideal for delicate dishes (pies-souffle).		○
	MAX	<b>Warming</b> This is recommended to reheat precooked foodstuff, positioning the shelf on the second level from top, or to defrost bread pizza or pastry by positioning the shelf on the lower level	○	○
	50 ÷ MAX	<b>Natural convection</b> Bottom and top oven elements are used. This is the traditional form of baking and roasting. It is ideal for roasting joints of meat and game, baking biscuits and apples and making the food nice and crunchy.	●	●
	MAX	Grill facility for smaller quantities of food as only the inner section of the element is used. (Only on F102/F112 models).	○	
	MAX 1 ÷ 6 <sup>(1)</sup>	<b>Door closed Grilling</b> The setting of this function switches on the infrared grill element. This function is ideal for cooking meats of medium thickness (sausages and bacon). <sup>(1)</sup> On some models grill power could be controlled by 6 levels, where 1 is minimum and 6 is max using the grill control knob.	●	○
	50 ÷ MAX	<b>Function Pizza</b> This function with hot air circulated in the oven ensure perfect result for dishes such as pizza or focaccia.		○
		<b>Grill/spit element.</b> This is used for roasting on the spit.	○	

\* Tested in accordance with the CENELEC EN 50304.

\*\* Tested in accordance with the CENELEC EN 50304 used for definition of energy class.

N.B. ● All models

○ Only on some models

## TABLES OF COOKING TIMES

The overall suggested cooking times set out below are intended as a rough guide only. They may in fact vary according to the quality, the freshness, the size and the thickness of the food cooked and of course cooking time is also partly a matter of taste. Let the food stand for a few minutes before serving because the ingredients continue cooking after they have been removed from the oven.

**HANDY TIP:** Lower the temperature so as to avoid the surface of the food becoming hard and dry.

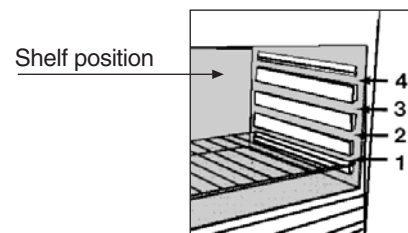

Food	Quantity	Static electric oven			Electric fan oven			Remarks
		Shelf	Time of cooking in minutes	Oven temperature	Shelf	Time of cooking in minutes	Oven temperature	
<b>• Pasta</b>								
Cannelloni	Kg 1,8	2	50 ÷ 60	220	2	40 ÷ 50	200	Put the cannelloni into an unheated oven
Oven baked pasta	Kg 2,5	2	55 ÷ 60	220	2	45 ÷ 50	200	Put the oven baked pasta into an unheated oven
<b>• Baking (not cakes)</b>								
Bread	Kg 1 di pasta	2	35 10 (pre-heating)	200	2	30 ÷ 35 10 (pre-heating)	180	Form the dough into a loaf and make a cross with a knife on top of the dough leave the dough to rise for at least 2 hours. Grease the baking tin and put the dough in the middle of it.
Pizza	Kg 1	1	25 ÷ 35	190	1	20 ÷ 25	190	Warm the oven for 15 minutes and place the pizzas on the greased baking tray. Garnish them with tomatoes, mozzarella, ham, oil, salt and origano.
Pastry (frozen) vol au vents	n° 24	1	30 ÷ 35	220	2	25 ÷ 30	200	Place 24 vol au vents in the oven and bake.
<b>• Meat</b>								
All meats can be roasted in shallow or deep roasting trays. It is advisable to cover the shallow trays to avoid splattering the sides of the oven with grease. The roasting times are the same whether the meat has been covered up or not.								
Whole joint of beef	Kg 1	3	70 ÷ 80	220	3	50 ÷ 60	200	Put the meat into a deep Pyrex dish and season with salt and pepper; turn the meat half way through cooking.
Joint of deboned	Kg 1	2	100 ÷ 110	220	2	80 ÷ 90	200	Cook the meat in a covered Pyrex dish with herbs, spice, oil and butter.
<b>• Fish</b>								
Trout	3 whole trout or / Kg 1	2	40 ÷ 45	220	2	35 ÷ 40	200	Cover the trout with salt, oil and onions and cook in a Pyrex dish.
Salmon	700 g 2,5 cm slice	2	30 ÷ 35	220	2	30 ÷ 25	200	Cook the salmon in an open Pyrex dish with salt, pepper and oil.
Sole	Kg 1	2	40 ÷ 45	220	2	35 ÷ 40	200	Cook the sole with salt and a spoonful of oil.
Bream	2 whole ones	2	40 ÷ 45	220	2	35 ÷ 40	200	Cook the bream in oil and salt in a covered dish.
<b>• Rabbits and Poultry</b>								
Guinea fowl	Kg 1-1,3	2	60 ÷ 80	220	2	60 ÷ 70	200	Place the guinea fowl in a deep Pyrex or pottery dish with very little oil and season with herbs and spices.
chicken	Kg 1,5-1,7	2	110 ÷ 120	220	2	100 ÷ 110	200	Follow the procedure for cooking the guinea fowl.
Rabbit pieces	Kg 1-1,2	2	55 ÷ 65	220	2	50 ÷ 60	200	Put all the pieces of the same size in the glazed tray. Season with herbs and spices. Turn the pieces as and when required.
<b>• Cakes</b>	700 gr	1	40	200	2	30 ÷ 35	180	Use a tin that is 22 cm deep. Pre-heat for 10 mins.
<b>• Vegetable</b>	800 gr	1	70 ÷ 80	220	1	60 ÷ 70	200	Cut the fennel into four pieces, add butter, salt and potatoes if required and place in a Pyrex face up. Cover the dish.
<b>• Fruit</b>	Kg 1	1	45 ÷ 55	220	2	45 ÷ 55	200	Bake the fruit in an open Pyrex or earthenware dish. Leave it to cool inside the oven.

# TABLES OF COOKING TIMES

Food	Quantity	Static electric oven			Electric fan oven			Remarks
		Shelf	Time of cooking in minutes	Oven temperature	Shelf	Time of cooking in minutes	Oven temperature	
<b>• Grilling</b>								
Place the food to be grilled underneath the infra-red grill. Warning: When the grill is on it takes on a bright red colour. Place the tray underneath the grill to collect juices and fat from the food being grilled.								
Squares of bread for toasting	4 pieces	4	5 (5 to heat up grill)	grill	4	5 (10 to heat up grill)	grill	Lay the bread on the grill tray. When one side of the bread has been toasted, turn over and toast the other side. Remember: keep the toast warm at the bottom of the oven until you are ready to serve it.
Sausages	n°6 / Kg 0,9	4	25/30 (5 to heat up grill)	grill	4	15/20 (10 to heat up grill)	grill	Cut the sausages in half and lay them face down on the grill. Half way through grilling turn them over. Every so often, check that they are being cooked equally all over. (If this is not happening, turn and reposition the ones being cooked either less or more than the others.
Ribs of beef	n°4 / Kg 1,5	4	25 (5 to heat up grill)	grill	4	15/20 (10 to heat up grill)	grill	Make sure that the ribs of beef are exposed to the full effect on the main grill.
Chicken legs	n°4 / Kg 1,5	3	50/60 (5 to heat up grill)	grill	3	50/60 (10 to heat up grill)	grill	Turn them over twice during grilling.

## INSTALLATION

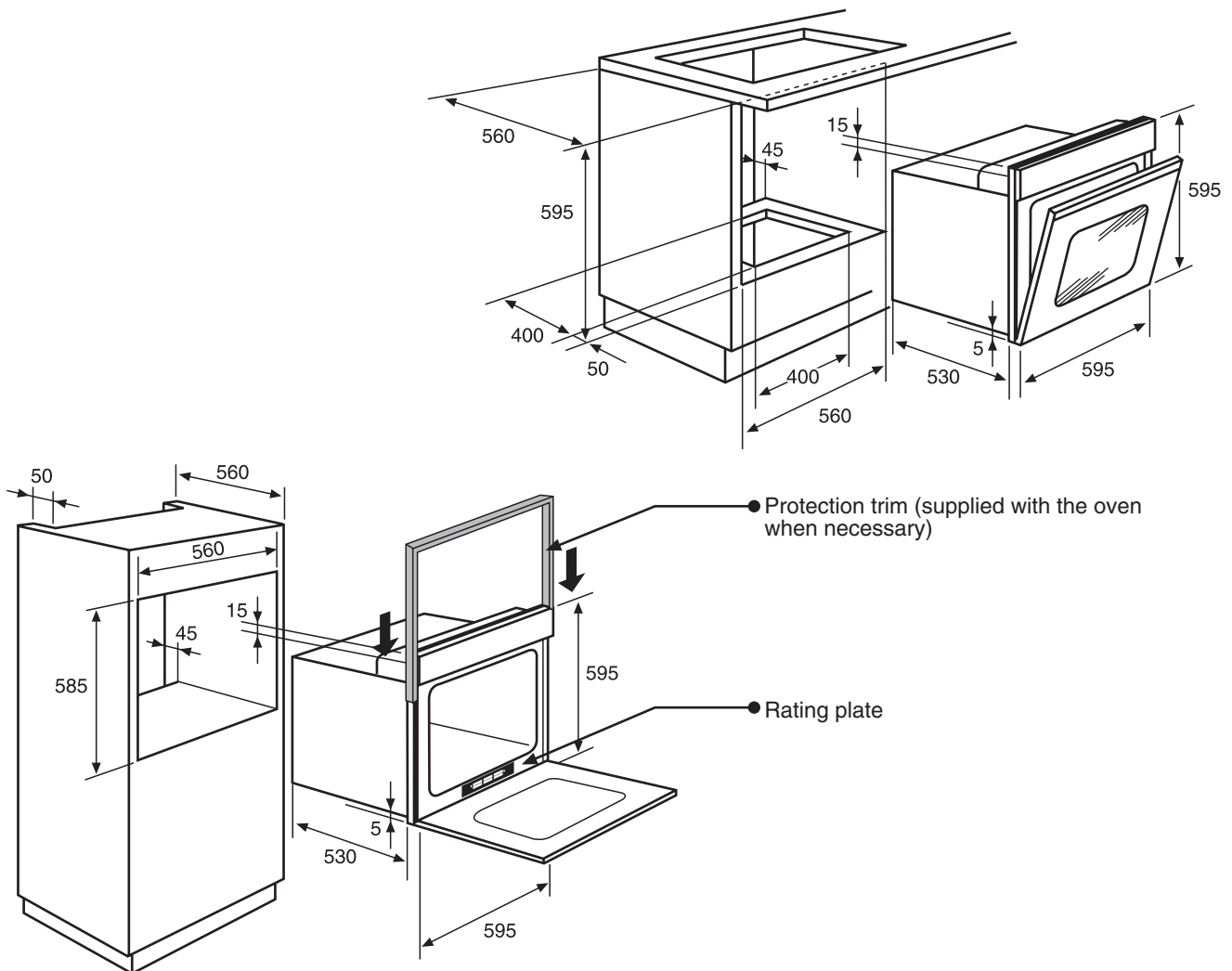

GB

The manufacturer will not be responsible for any inaccuracy resulting from printing or transcript errors contained in this brochure. We reserve the right to carry out modifications to products as required, including the interests of consumption, without prejudice to the characteristics relating to safety or function.