



**MARQUE:** MOULINEX  
**REFERENCE:** MiniFRITO F2200  
**CODIC:** 4251075



**NOTICE**



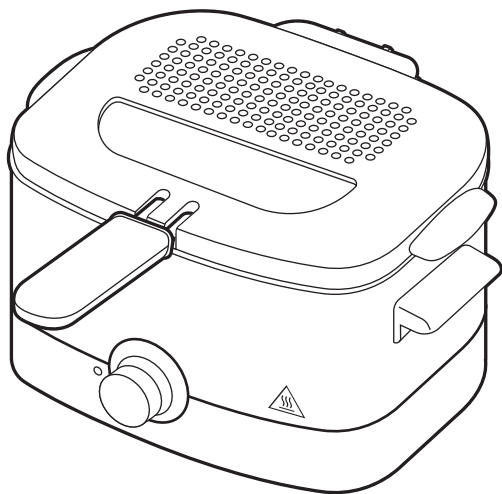

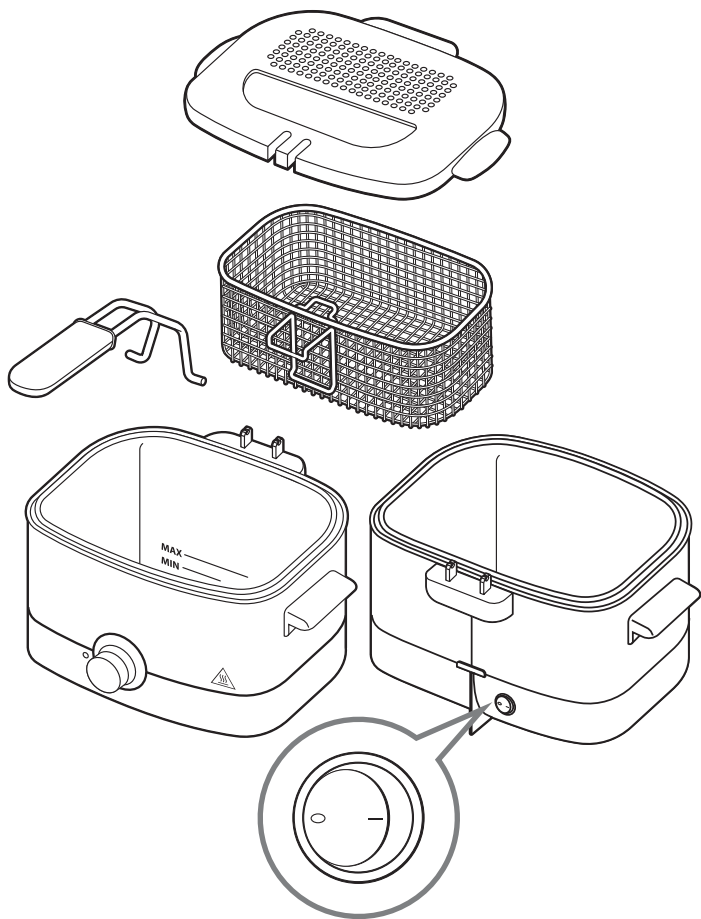



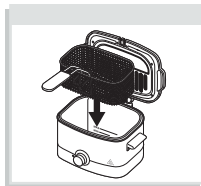
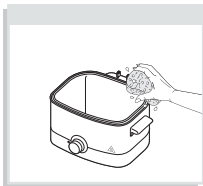
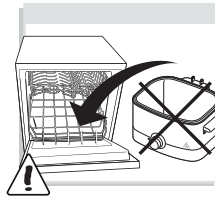
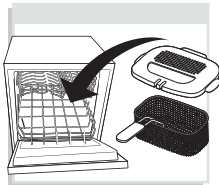
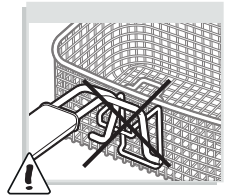
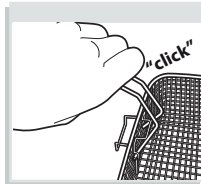
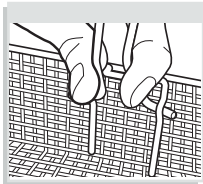
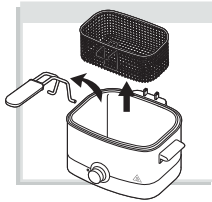
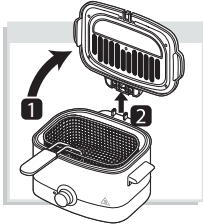
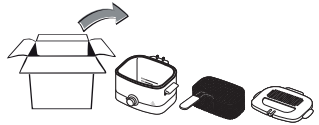



Min. 0,85 L



Max. 1 L

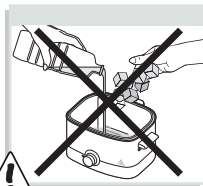
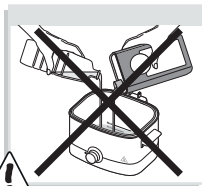
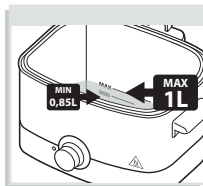
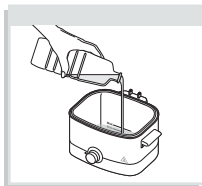

Min. 750 g



Max. 900 g

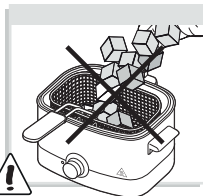
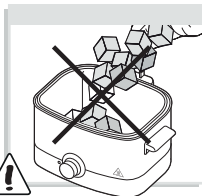
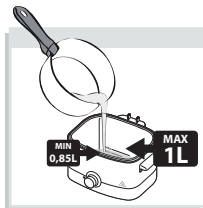
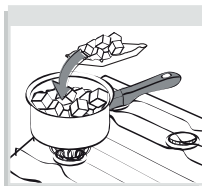

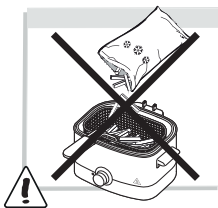
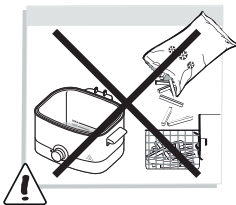
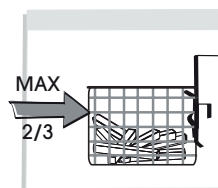
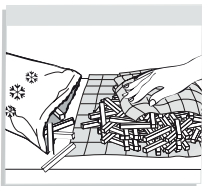
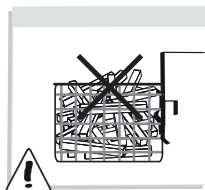
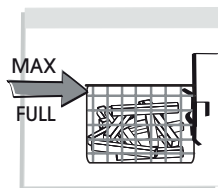
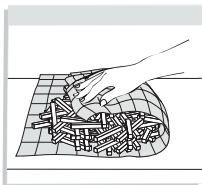
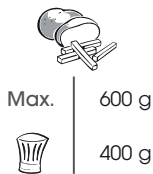

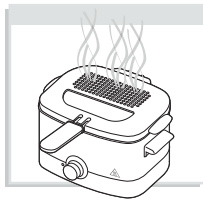
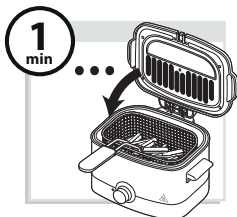
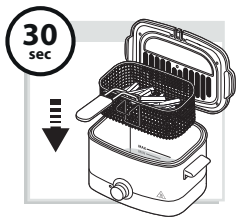
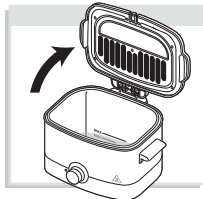
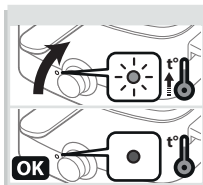
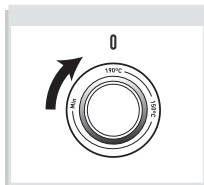
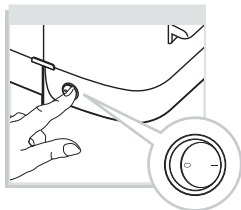
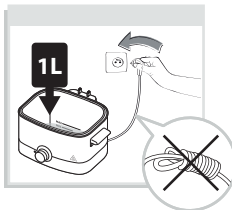
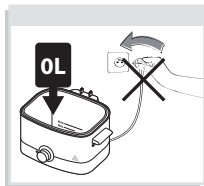





		°C		°C	
	400 g	190 °C	11 - 13 min	-	-
	600 g	190 °C	15 - 18 min	-	-
	250 g	-	-	190 °C	7 - 9 min
	400 g	-	-	190 °C	10 - 12 min
	350 g	170 °C	3 - 5 min	190 °C	6 - 8 min
	150 g	190 °C	2 - 3 min	-	-
	150 g	170 °C	2 - 3 min	190 °C	3 - 4 min
	4 - 5	160 °C	5 - 7 min	190 °C	5 - 7 min
	120 g	180 °C	4 - 6 min	190 °C	4 - 5 min
	250 g	160 °C	4 - 6 min	190 °C	6 - 8 min
	240 g	170 °C	14 - 17 min	-	-
	5	190 °C	8 - 10 min	-	-

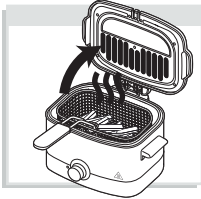
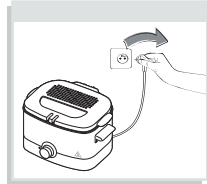
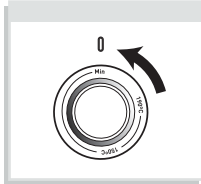
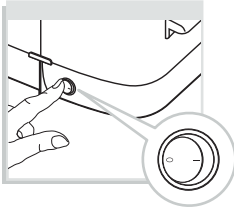

30  
sec

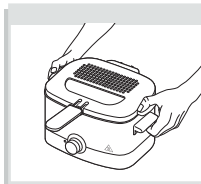
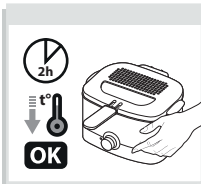
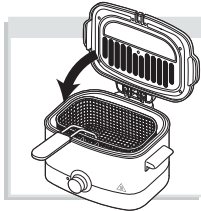
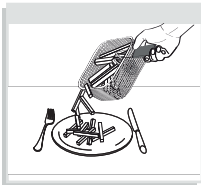
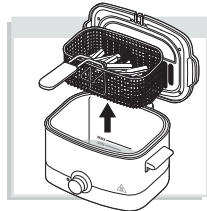
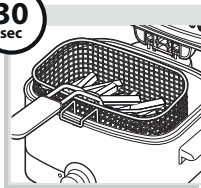

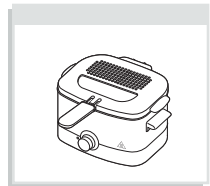
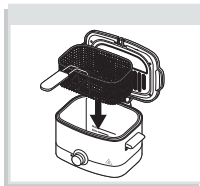
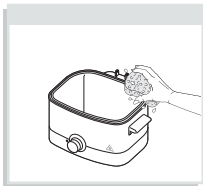
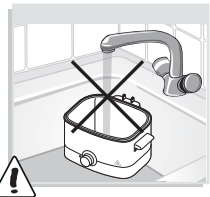
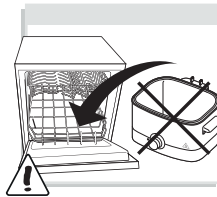
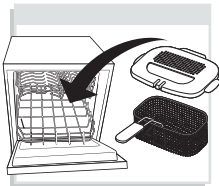
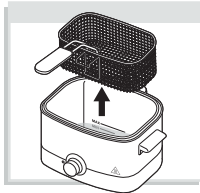
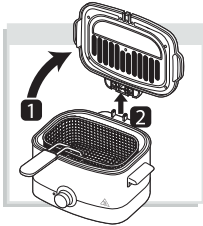
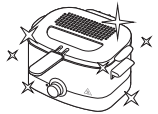

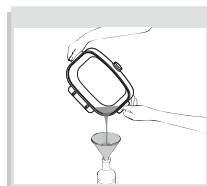
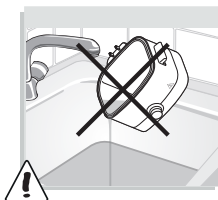
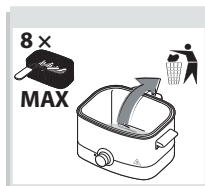
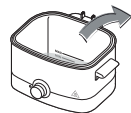

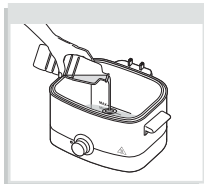
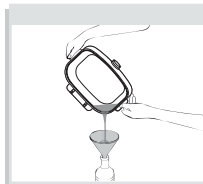
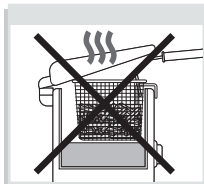
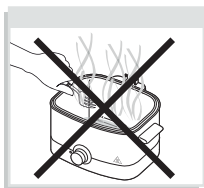









## GUARANTEE COUNTRY LIST

			
<b>ARGENTINA</b>	0800-122-2732	2 años 2 years	GROUPE SEB ARGENTINA S.A. Billinghurst 1833 3° C1425DTK Capital Federal Buenos Aires
<b>ՀԱՅԱՍՏԱՆ ARMENIA</b>	010 55-76-07	2 տարի 2 years	ՓԲԸ «ԳՐՈՒՊԻՊԱ ՍԵԲ» 125171, ՄՈՍԿՎԱ, ԼԵՆԻՆԳՐԱԴՍԿԱՆ ԽՈՒՆՆԻՒՄ, 16Ա, ՇԻՆ.3
<b>AUSTRALIA</b>	1300307824	1 year	GROUPE SEB AUSTRALIA PO Box 7535, Silverwater NSW 2128
<b>ÖSTERREICH AUSTRIA</b>	01 890 3476	2 Jahre 2 years	SEB ÖSTERREICH GmbH Campus 21 - Businesspark Wien Süd, Liebermannstr. A02 702 2345 Brunn am Gebirge
<b>البحرين BAHRAIN</b>	17716666	1 year	www.tefal-me.com
<b>БЕЛАРУСЬ BELARUS</b>	017 2239290	2 года 2 years	ЗАО «Группа СЕБ-Восток», 125171, Москва, Ленинградское шоссе, д. 16А, стр. 3
<b>BELGIQUE BELGIE BELGIUM</b>	070 23 31 59	2 ans 2 jaar 2 years	GROUPE SEB BELGIUM SA NV 25 avenue de l'Espérance - ZI 6220 Fleurus
<b>BOSNA I HERCEGOVINA</b>	Info-linija za potrošače 033 551 220	2 godine 2 years	SEB Developpement Predstavništvo u BiH Vrazova 8/II 71000 Sarajevo
<b>BRASIL BRAZIL</b>	11 2915-4400	1 ano 1 year	SEB COMERCIAL DE PRODUTOS DOMÉSTICOS LTDA Rua Venâncio Aires, 433, Pompéia, São Paulo/SP
<b>БЪЛГАРИЯ BULGARIA</b>	0700 10 330	2 години 2 years	ГРУП СЕБ БЪЛГАРИЯ ЕООД бул. България 81 В, ет. 5 1404 София
<b>CANADA</b>	1-800-418-3325	1 an 1 year	GROUPE SEB CANADA 345 Passmore Avenue Toronto, ON M1V 3N8
<b>CHILE</b>	12300 209207	2 años 2 years	GROUPE SEB CHILE Comercial Ltda Av. Providencia, 2331, piso 5, oficina 501 Santiago
<b>COLOMBIA</b>	018000520022	2 años 2 years	GROUPE SEB COLOMBIA Apartado Aereo 172, Kilometro 1 Via Zipaquira Cajica Cundinamarca
<b>HRVATSKA CROATIA</b>	01 30 15 294	2 godine 2 years	SEB mku & p d.o.o. Vodnjanska 26, 10000 Zagreb
<b>ČESKÁ REPUBLIKA CZECH REPUBLIC</b>	731 010 111	2 roky 2 years	Groupe SEB ČR s.r.o. Futurama Business Park (budova A) Sokolovská 651/136a 186 00 Praha 8
<b>DANMARK DENMARK</b>	44 663 155	2 år 2 years	GROUPE SEB NORDIC AS Tempovej 27 2750 Ballerup
<b>مصر EGYPT</b>	16622	سنة واحدة 1year	جروب سب الجيبیت القاهرة: 121 شارع الحجاز، مصر الجديدة الإسكندرية: طريق 14 مايو، سموحة

			
EESTI ESTONIA	668 1286	2 aastat 2 years	GRUPE SEB POLSKA Sp. z o.o. ul. Bukowińska 22b 02-703 Warszawa
SUOMI FINLAND	09 622 94 20	2 Vuotta 2 years	Groupe SEB Finland Kutojantie 7 02630 Espoo
France Continentale + Guadeloupe, Martinique, Réunion, Saint-Martin	09 74 50 47 74	1 an 1 year	GRUPE SEB France Service Consommateur Tefal 112 Ch. Moulin Carron, TSA 92002 69134 ECULLY Cedex
DEUTSCHLAND GERMANY	0212 387 400	2 Jahre 2 years	GRUPE SEB DEUTSCHLAND GmbH / KRUPS GmbH Theodor-Stern-Kai 1 60486 Frankfurt am Main
ELLADA GREECE	2106371251	2 χρόνια 2 years	SEB GROUPE ΕΜΜΑΔΟΣ Α.Ε. Οδός Καβαλιεράτου 7 Τ.Κ. 145 64 Κ. Κηφισιά
香港 HONG KONG	8130 8998	1 year	SEB ASIA Ltd. Room 903, 9/F, South Block, Skyway House 3 Sham Mong Road, Tai Kok Tsui, Kowloon Hong-Kong
MAGYARORSZÁG HUNGARY	06 1 801 8434	2 év 2 years	GRUPE SEB CENTRAL-EUROPE Kft. Táviró köz 4 2040 Budaörs
INDONESIA	+62 21 5793 7007	1 year	GRUPE SEB INDONESIA (Representative office) Sudirman Plaza, Plaza Marein 8th Floor JL Jendral Sudirman Kav 76-78, Jakarta 12910, Indonesia
ITALIA ITALY	1 99 207 354	2 anni 2 years	GRUPE SEB ITALIA S.p.A. Via Montefeltro, 4 20156 Milano
日本 JAPAN	0570-077772	1 year	株式会社グループセブジャパン 〒144-0042 東京都大田区羽田旭町11-1 羽田クロノゲート事務棟5F
الأردن JORDAN	5665505	1 year	www.tefal-me.com
ҚАЗАҚСТАН KAZAKHSTAN	727 378 39 39	2 жыл 2 years	ЖАҚ «Группа СЕБ- Восток» 125171, Мәскеу, Ленинградское шоссе, 16А, 3 үйі
한국어 KOREA	1588-1588	1 year	(유)그룹 세브 코리아 서울시 종로구 청계천로 35 관정빌딩 2층 110- 790
الكويت KUWAIT	24831000	1 year	www.tefal-me.com
LATVIA LATVIA	6 616 3403	2 gadi 2 years	GRUPE SEB POLSKA Sp. z o.o. ul. Bukowińska 22b, 02-703 Warszawa
لبنان LEBANON	4414727	1 year	www.tefal-me.com
LIETUVA LITHUANIA	5 214 0057	2 metai 2 years	GRUPE SEB POLSKA Sp. z o.o. ul. Bukowińska 22b, 02-703 Warszawa
LUXEMBOURG	0032 70 23 31 59	2 ans 2 years	GRUPE SEB BELGIUM SA NV 25 avenue de l'Espérance - ZI 6220 Fleurus

			
<b>МАКЕДОНИЈА</b> <b>MACE DONIA</b>	(02) 20 50 319	2 години 2 years	Groupe SEB Bulgaria EOOD Office 1, floor 1, 52G Borovo St., 1680 Sofia - Bulgaria ГРУП СЕБ БЪЛГАРИЯ ДООЕЛ Ул. Борово 52 Г, сп. 1, офис 1, 1680 София, България
<b>MALAYSIA</b>	603 7802 3000	1 year	GROUPE SEB MALAYSIA SDN. BHD Unit No. 402-403, Level 4, Uptown 2, No. 2, Jalan SS21/37, Damansara Uptown, 47400, Petaling Jaya, Selangor D.E Malaysia
<b>MEXICO</b>	(01800) 112 8325	1 año 1 year	Groupe.S.E.B. México, S.A. DE C.V. Goldsmith 38 Desp. 401, Col. Polanco Delegación Miguel Hildalgo 11 560 México D.F.
<b>MOLDOVA</b>	22 929249	2 роки 2 years	ТОВ «Груп СЕБ Україна» 02121, Харківське шосе, 201-203, 3 поверх, Київ, Україна
<b>NEDERLAND</b> The Netherlands	0318 58 24 24	2 jaar 2 years	GROUPE SEB NEDERLAND B.V. De Schutterij 27 3905 PK Veenendaal
<b>NEW ZEALAND</b>	0800 700 711	1 year	GROUPE SEB NEW ZEALAND PO Box 17 – 298, Greenlane, 1546 Auckland New Zealand
<b>NORGE</b> <b>NORWAY</b>	815 09 567	2 år 2 years	GROUPE SEB NORDIC AS Tempovej 27 2750 Ballerup
عمان سلطنة <b>OMAN</b>	24703471	1 year	www.tefal-me.com
<b>POLSKA</b> <b>POLAND</b>	801 300 420 koszt jak za połączenie lokalne	2 lata 2 years	GROUPE SEB POLSKA Sp. z o.o. ul. Bukowińska 22b 02-703 Warszawa
<b>PORTUGAL</b>	808 284 735	2 anos 2 years	GROUPE SEB IBÉRICA SA Urb. da Matinha Rua Projectada à Rua 3 Bloco1 - 3º B/D 1950 - 327 Lisboa
قطر <b>QATAR</b>	44485555	1 year	www.tefal-me.com
<b>REPUBLIC OF</b> <b>IRELAND</b>	01 677 4003	1 year	GROUPE SEB IRELAND Unit B3 Aerodrome Business Park, College Road, Rathcoole, Co. Dublin
<b>ROMANIA</b>	0 21 316 87 84	2 ani 2 years	GROUPE SEB ROMÂNIA Str. Daniel Constantin nr. 8 010632 București
<b>РОССИЯ</b> <b>RUSSIA</b>	495 213 32 30	2 года 2 years	ЗАО «Группа СЕБ-Восток», 125171, Москва, Ленинградское шоссе, д. 16А, стр. 3
المملكة العربية السعودية <b>SAUDI ARABIA</b>	920023701	1 year	www.tefal-me.com
<b>SRBIJA</b> <b>SERBIA</b>	060 0 732 000	2 godine 2 years	SEB Developpement Đorđa Stanojevića 11b 11070 Novi Beograd



			
<b>SINGAPORE</b>	6550 8900	1 year	GROUPE SEB SINGAPORE Pty Ltd. 59 Jalan Pemimpin, #04-01/02 L&Y Building Singapore 57218
<b>SLOVENSKO SLOVAKIA</b>	232 199 930	2 roky 2 years	GROUPE SEB Slovensko, spol. s r.o. Cesta na Senec 2/A 821 04 Bratislava
<b>SLOVENIJA SLOVENIA</b>	02 234 94 90	2 leti 2 years	SEB d.o.o. Gregorčičeva ulica 6 2000 MARIBOR
<b>SOUTH AFRICA</b>	0100202222	1 year	GS South Africa Building 17, PO BOX 107 The Woodlands Office Park, 20 Woodlands Drive, Woodmead 2080
<b>ESPAÑA SPAIN</b>	902 31 24 00	2 años 2 years	GROUPE SEB IBÉRICA S.A. C/ Almogàvers, 119-123, Complejo Ecourban 08018 Barcelona
<b>SVERIGE SWEDEN</b>	08 594 213 30	2 år 2 years	TEFAL SVERIGE SUBSIDIARY OF GROUPE SEB NORDIC Truckvägen 14 A, 194 52 Upplands Väsby
<b>SUISSE SCHWEIZ SWITZERLAND</b>	044 837 18 40	2 ans 2 Jahre 2 years	GROUPE SEB SCHWEIZ GmbH Thurgauerstrasse 105 8152 Glattbrugg
<b>ประเทศไทย THAILAND</b>	02 769 7477	2 years	GROUPE SEB THAILAND 2034/66 Italthai Tower, 14th Floor, n° 14-02, New Phetchburi Road, Bangkapi, Huaykwang, Bangkok, 10320
<b>TÜRKIYE TURKEY</b>	444 40 50	2 YIL 2 years	GROUPE SEB ISTANBUL AS Dereboyu Cd. Bilim Sk. Sun Plaza No:5 K:2 Maslak/IST
<b>المتحدة العربية الامارات UAE</b>	8002272	1 year	<a href="http://www.tefal-me.com">www.tefal-me.com</a>
<b>Україна UKRAINE</b>	044 300 13 04	2 роки 2 years	ТОВ «Група СЕБ Україна» 02121, Харківське шосе, 201-203, 3 поверх, Київ, Україна
<b>UNITED KINGDOM</b>	0345 602 1454	1 year	GROUPE SEB UK LTD Riverside House, Riverside Walk Windsor, Berkshire, SL4 1NA
<b>U.S.A.</b>	800-395-8325	1 year	GROUPE SEB USA 2121 Eden Road Millville, NJ 08332
<b>VENEZUELA</b>	0800-7268724	2 años 2 years	GROUPE SEB VENEZUELA Av Eugenio Mendoza, Centro Letonia, Torre ING Bank, Piso 15, Ofc 155 Urb. La Castellana, Caracas

## INTERNATIONAL GUARANTEE

**Date of purchase:** ..... / Date d'achat / Fecha de compra / Data da compra / Data d'acquisto / Kaufdatum / Kobsdato / Inköpsdatum / Kjøpsdato / Ostopäivä / Data zakupu / Data vânzării / Jsigijimo data / Ostukuupäev / Datum nákupu / Sorozatszám / Dátum nákupu / Pirkuma datums / Datum Kupovine / Datum kupnje / Data cumpărării / Datum nákupu / Tarikh pembelian / Tanggal pembelian / Ngáy mua hàng / Satın alma tarihi / Дата продаж / Дата на закупуване / Датум на купување / Сатылган мерәми / Ημερομηνία αγοράς / Λαμβάνη ημερ / 購買日期 / 購入日 / 구입일자 / تاريخ الشراء / تاريخ خري / Дата на закупване / Датум на купување / Сатылган

**Product reference:** ..... / Référence du produit / Referencia del producto / Nome do produto / Tipo de prodotto / Typnummer des Gerätes / Artikelnummer van het apparaat / Referencenummer / Produktreferenz / Artikkelnnummer / Tuotenumero / referencia produktu / Model / Gaminio numeris / Toote viitenumber / Tip aparata / Vásárlás kelte / Тип výroбу / Produkta atsauces numurs / Model proizvoda / Oznaka proizvoda / Cod produs / Produk rujukan / Referensi produk / Mã sản phẩm / Útín kodu / Модел / Модел на уред / Модел / Кодикос προϊόντος / Όηηήη / 產品編號 / 產品模型 / 製品番号 / 제품명 / مرجع المنتج الكامل / مرجع المنتج الكامل

**Retailer name & address:** ..... / Nom et adresse du vendeur / Nombre y dirección del minorista / Nome e endereço do revendedor / Nome e indirizzo del negozio / Name und Anschrift des Händlers / Naam en adres van de dealer / Forhandler navn & adresse / Återförsäljarens namn och adress / Forhandler navn og adresse / Jälleenmyyjän nimi ja osoite / nazwa i adres sprzedawcy / Numele și adresa vânzătorului / Parduotuvės pavadinimas ir adresas / Müllja kauplus ja address / Naziv in naslov trgovine / Tipusszám / Názov a adresa predajcu / Veikala nosaukums un adrese / Naziv i adresa maloprodaje / Naziv i adresa prodavca / Naziv i adresa prodajnog mjesta / Nume și adresă vânzător / Název a adresa prodejce / Nama dan alamat penjual / Nama Toko Penjual dan alamat / Tên và địa chỉ cửa hàng bán/ Sateci firmam adı ve adresi / Название и адрес продавца / Назва i adresa prodavca / Търговен обект / Назив и адреса на продавницата / Сатушынын аты жне мекени-жайы / Επωνυμία και διεύθυνση καταστήματος / 零售商的店名和地址 / 販売店名、住所 / 소매점 이름과 주소 / اسم بائع التجزئة و عنوانه / نام دوس خرد فروش / 零售商的店名和地址 / 販売店印 / 販売店印 / 소매점 직인 / اسم بائع التجزئة / ختم بائع التجزئة

**Distributor stamp** ..... / Cachet distributeur / Sello del distribuidor / Carimbo do revendedor / Timbro del negozio / Händlerstempel / Stempel van de dealer / Förhandler stempel / Återförsäljarens stämpel / Forhandler stempel / Jälleenmyyjän leima / pieczęć sprzedawcy / Stampilla vânzătorului / Antspaudas / Tempel / Žig trgovine / Etadó neve, címe / Razitko prodajcu / Zimogs / Pečat maloprodajce / Pečat prodavca / Pečat prodajnog mjesta / Štampilla vânzătorului / Razitko prodajce / Cap pernici / Cap dari Toko Penjual / Cửa hàng bán đồng dấu / Sateci Firmam Kaşesi / Печатка продавца / Печат на търговския обект / Печат на продавницата / Сатушынын стери / Σφραγίδιο καταστήματος / 零售商的印章 / 販売店印 / 販売店印 / 소매점 직인 / اسم خرد فروش / ختم بائع التجزئة





NC00128579