

User Instruction Book

HOTPOINT

MICROWAVE OVEN

Model

MWH422 AX

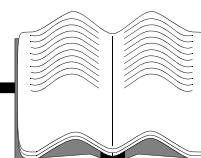

NOTICES TO THE USER	
Operating principle	2
Environmental protection	2
Safety instructions	3
INSTALLATION	
Before connecting	4
Electrical connection	4
Building-in	5
DESCRIPTION	
The appliance	6
Accessories	7
The control panel	8
The function selector knob / the display	9
The display	9
USE	
How to set / change the time	10
Stop turntable option	10
Programming	11
Using the power levels	11
Microwave function	12
Express programme	12
Heat & Hold function	12
Reheating on 2 levels	13
Automatic cook functions	13
Guide to automatic functions	13
Defrosting	14
The automatic defrost function	15
Grill functions	16
Guide to cooking using the Grill function	16
Grill + Microwave function	17
Guide to cooking using the Grill + Microwave function	17
Child lock	18
CARE AND CLEANING	19
TROUBLESHOOTING	20
OPERATING PROFICIENCY TESTING	21

You have chosen a HOTPOINT-ARISTON microwave oven. Optimum ease of use and simple operation were the most important factors in the development of this product.

The combi-microwave oven combines the characteristics of a microwave oven with those of a traditional oven.

The extensive range of settings available enables you to select the exact method of cooking that you have in mind. The design ensures easy to use controls.

The functions are arranged conveniently on the control panel. The display provides information and helps you choose the settings.

operating principle

The microwaves used for cooking are electromagnetic waves. They are found naturally in our environment as radio-electric waves, light or infra-red radiation.

Their frequency is located in the 2450 MHz band. Their properties:

- They are reflected by metals.
- They can pass through all other materials.
- They are absorbed by molecules of water, fat and sugar.

When food is exposed to microwaves, the molecules are quickly shaken up, which causes heating.

The microwaves penetrate into the food to a depth of around 2.5 cm. If the food is thicker, it will be cooked to its core by heat conduction, as with traditional cooking.

It is important to know that microwaves cause a simple thermal reaction inside the food, and that they are not harmful.

environmental protection

This appliance's packaging material is recyclable. Help recycle it and protect the environment by dropping it off in the municipal receptacles provided for this purpose.



Your appliance also contains a great amount of recyclable material. It is marked with this label to indicate the used appliances that should not be mixed with other waste. This way, the appliance recycling organised by your manufacturer will be done under the best possible conditions, in compliance with European Directive 2002/96/EC on Waste Electrical and Electronic Equipment. Contact your town hall or your retailer for the used appliance collection points closest to your home. We thank you for doing your part to protect the environment.

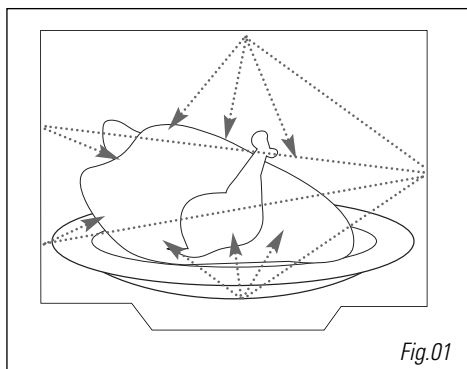

Fig.01



Warning:

Keep this user guide with your appliance. If the appliance is ever sold or transferred to another person, ensure that the new owner receives the user guide. Please become familiar with these recommendations before installing and using your oven. They were written for your safety and the safety of others.

safety instructions

This appliance is not intended to be used by persons (including children) with reduced physical, sensory or mental abilities, or persons lacking experience or awareness, unless using it with the help of a person responsible for their safety, or under supervision and with prior instruction in its use. Children should be supervised to ensure that they do not play with the appliance.

Your appliance is intended exclusively for domestic use for cooking, reheating and defrosting food. The manufacturer declines all responsibility in the event of improper use.

— The appliance is not intended for use by young children or infirm persons unless they have been adequately supervised by a responsible person to ensure that they can use the appliance safely.

Check that utensils are suitable for use in a microwave oven. Do not leave any accessories in the oven when it is not operating.

To avoid damage to your appliance, never operate it when empty or without the turntable.

Do not tamper with the holes of the front lock, as this could damage your appliance and result in the need for repair.

The seal and the frame of the door must be inspected regularly to ensure that they are not damaged. If these areas become damaged, stop using the appliance and have it checked by a specialised technician.

When heating food in plastic or paper containers, keep an eye on the oven due to the risk of fire.

When using the microwave and fan cooking +

microwave function, you should avoid using metal containers, forks, spoons, knives or metal fasteners or staples for freezer bags.

The contents of bottles or jars for babies must be stirred or shaken and the temperature must be checked before use, in order to avoid burns. Never heat a bottle with the teat (risk of explosion).

Never allow children to use the oven without supervision, except when appropriate instructions have been given so that the child can use the oven safely and understand the dangers of improper use.

Always use oven gloves to remove dishes from the oven. Certain dishes absorb heat from the food and can become very hot.

Liquids or other foods must not be heated in closed containers as they may explode.

You should avoid heating eggs in their shell and whole hard-boiled eggs in a microwave oven as they may explode, even after cooking has finished.

When drinks are heated by microwave, boiling liquid may suddenly spurt even after heating, precautions must therefore be taken when handling the container.

When cooking small quantities (e.g. 1 sausage, 1 croissant, etc.), place a glass of water next to the food.

Cooking for too long can dry out food and burn it. To avoid this type of incident, never use the same cooking time as recommended for a traditional oven.

If smoke appears, stop or unplug the oven and keep the door closed to smother any flames.

before connecting



Warning:

Check that your appliance has not been damaged during transport (damage to door or seal, etc.). If you notice any damage, contact your retailer before using the appliance.

In order to easily locate the reference information for your appliance, we recommend that you note these data on the "After-Sales Service" page.

electrical connection

Check that:

- the electrical installation has sufficient voltage.
- the supply cables are in good condition
- the diameter of the wires complies with the installation requirements.
- your equipment has a protection of at least 16 amps.

If in doubt, contact your electrician.

The electrical connections should be made before the appliance is installed in its housing.

Electrical safety must be ensured through proper installation in the housing. During installation and maintenance operations, the appliance must be unplugged from the electrical grid; fuses must be cut off or removed.

The appliance must be connected using a (standardised) feeder cable with 3 conductors of 1.5 mm² (1 live + 1N + ground) which must be connected to the 220-240 V ~ monophasic network using a CEI 60083-standardised 1 live + 1N + ground electrical outlet or one which complies with installation requirements. The protection cable (green-yellow) is connected to the appliance's ⊕ terminal and must be connected to the appliance's ground.

If the connection is made with a plug, it must remain accessible after the appliance has been installed.

The oven's neutral (blue cable) must be connected to the network's neutral.

Ensure your electrical installation has a system accessible to the user which can cut off the appliance from the power grid, with a contact opening of at least 3 mm for all the terminals.

If the supply cable is damaged, it must be replaced by the manufacturer, its after-sales service or any other similarly qualified person to avoid any danger.



Warning:

We cannot be held responsible for any accident resulting from an inexistent, defective or incorrect ground lead.

If the oven presents any irregularity, unplug the appliance or remove the relevant fuse at the oven's connection lead-in.

building-in

The appliance may be installed beneath a work surface or in column housing (open or closed) which has the required built-in measurements (*Fig.02*).

Do not use your appliance immediately (wait 1 or 2 hours) after moving it from a cold to a warm place as condensation may cause a malfunction.

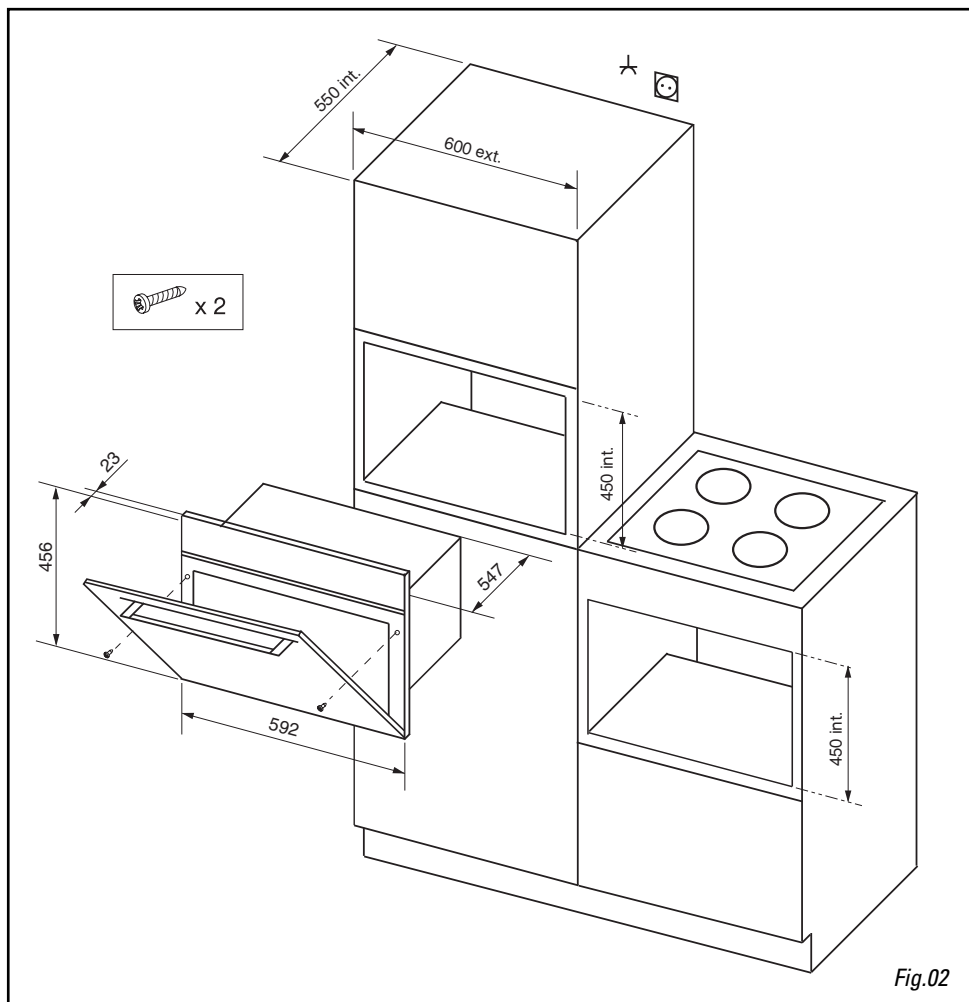

the appliance

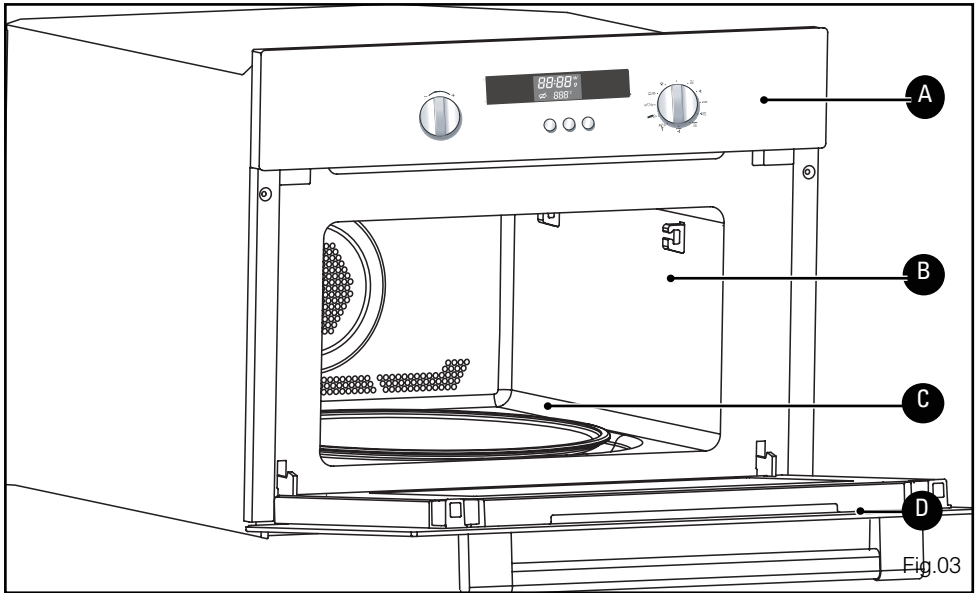

Fig.03

- A** Control panel
- B** Cavity
- C** Turntable
- D** Door handle

- **The turntable:** cooks food uniformly with no need for handling. It revolves in both directions. If it does not revolve, check that all elements are correctly positioned. Do not attempt to turn it manually, as you may damage the drive system. It may also be used as a cooking dish. To remove, grasp it using the access areas provided inside the cavity.
- **The driver:** causes the glass turntable to turn (Fig.04).
- **The base rollers:** Rollers must be positioned in the right direction (Fig.04). If they are not rotating properly, check for foreign bodies under the rollers.

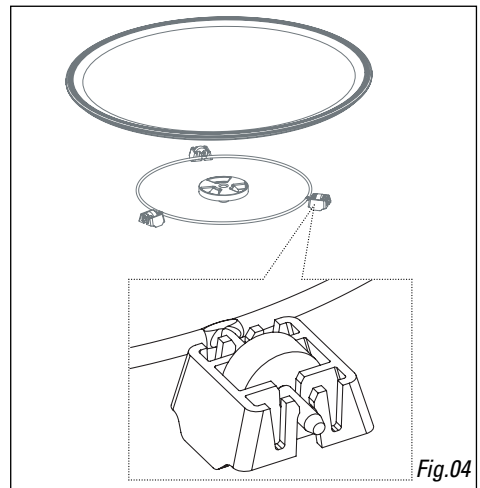



Fig.04

accessories

- **The grill (Fig.05):** may be used to toast, brown or grill. The grill must under no circumstances be used with other metal containers in the microwave, grill + microwave. You may, however, heat food in an aluminium tray by using a plate to separate it from the grill.
- **The enamel tray (Fig.06):** It may be used half filled with water for "bain marie" cooking or fan cooking. It may also be used as a cooking dish.

Comments:

 Ensure that the enamel tray is correctly centred on the side grills so that air may circulate freely.

- **The grill + the enamel tray:** for roasting and to collect cooking juices, place the grill on the enamel tray (Fig.07).

- **The side grills (Fig.08):** 2 shelves with hooks allow you to use the accessories on 3 levels. The 3 insertion levels are available according to the type of cooking and type of food (Fig.08/09).

In the **Grill or Grill + Microwave functions** you use the accessories at the 1st level for thick foods such as roasts, and at the 3rd level for less thick foods such as chops or sausages.

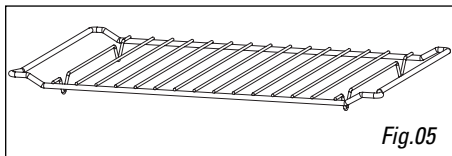

Fig.05

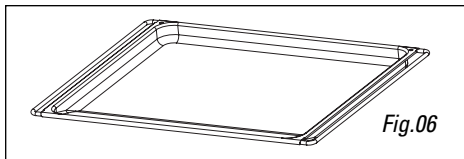

Fig.06

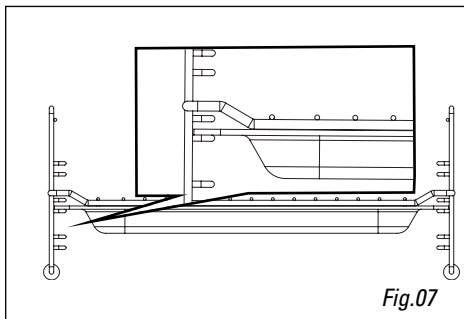

Fig.07

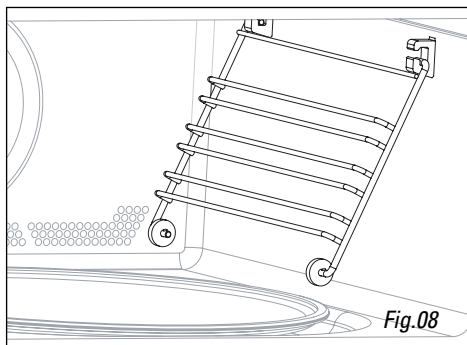

Fig.08

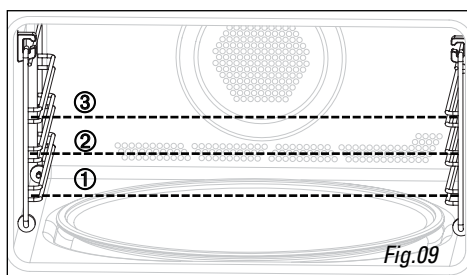

Fig.09

the control panel

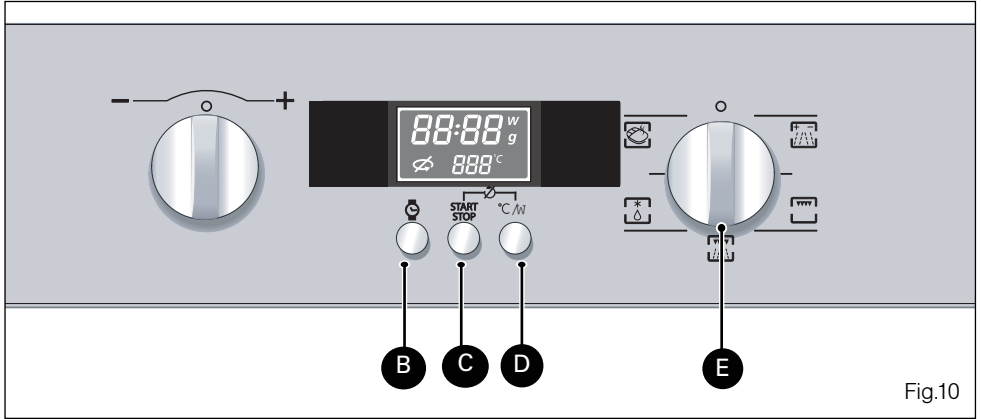
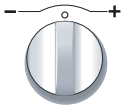

Fig.10



- A** The - / + selector knob allows you to select the time, the programme length, the power levels, the food portion's weight.



- B** The CLOCK key allows you to set the time.



- C** The START/STOP key lets you begin a programme, interrupt or cancel a programme in progress.



- D** The °C/W key allows you to validate your selections.

- E** The FUNCTION/AUTO PROGRAMME selector knob allows you to choose the type of programme, as well as the automatic function and food category.

the function / auto programme selector knob

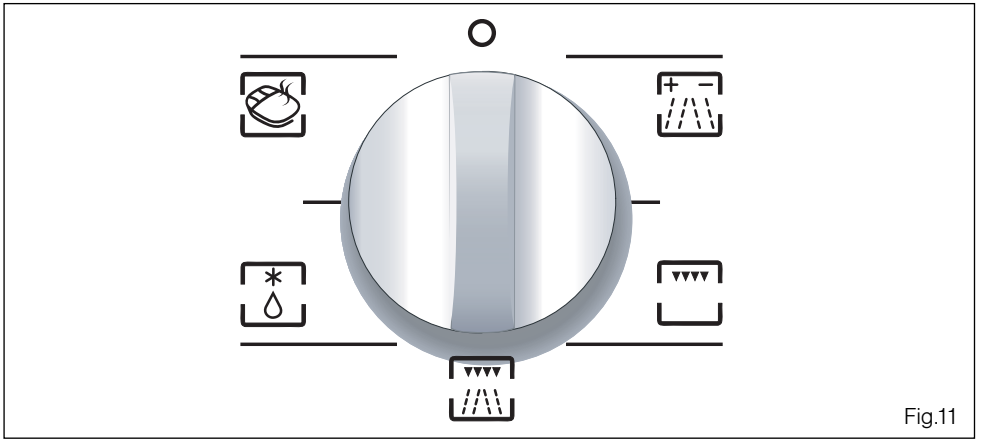

Fig.11

the display

The display guides you in programming the various settings:

- A** Clocktime
Programme time
Microwave power level (Watts)
Food weight (grams)
- B** Stop turntable
- C** Auto programmes

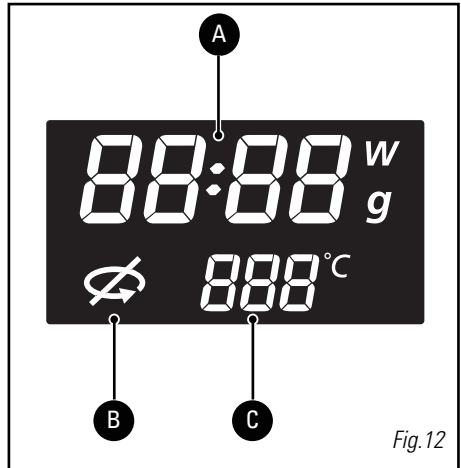

Fig.12

how to set / change the time

After connecting your appliance or after a prolonged power failure, **00:00** flashes in the display.

To set the clock



Turn the selector to set the time, ex. 6:30.



Confirm by pressing the CLOCK key or START.
A beep confirms that your clock is set.

Display



When there is a time change

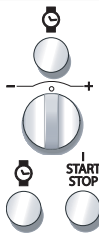

Press the CLOCK key. The time display flashes.

Programme the new time (ex. 7:30) by turning the selector.

Confirm by pressing the CLOCK key or START.
A beep confirms that your clock is set to the new time.

Display

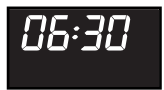

Comments:

If you do not press the clock key, the time displayed is automatically recorded after one minute.

Your appliance is equipped with a back-up so that during a power failure the time remains displayed for a day.

stop turntable option

If there is insufficient space for the dish to turn freely inside the oven, set the STOP TURNTABLE function before or during the programme.

Note: it is not possible to stop the turntable during an automatic defrost programme.

To set:

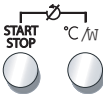

Press the STOP TURNTABLE key, the -symbol lights up and the turntable stops.

To cancel:

To cancel the function, follow the same procedure.
It is necessary to turn the container or stir the contents halfway through the programme when the STOP TURNTABLE function is set.

programming

Your appliance is now connected and displays the correct time.

Open the door using the handle. Place the food in the appliance and close the door.

If the door is not closed properly the appliance will not function.



If the door is opened during operation, the programme is not cancelled but simply interrupted. To start the oven again, close the door and press the START key.



If no action is taken within 1 minute after programming, 3 beeps invite you to start up or modify the programme. With no further instruction, after another minute and a reminder beep, the settings are cancelled and the clocktime is displayed again.



Press the START/STOP key with the door closed to interrupt a programme.

Press the START/STOP key for 2 seconds to cancel a programme, or turn the selector to the OFF position.



If you wish to verify your microwave power level, you may press °C/W to check the display.

In order to set a second programme once the first has ended, open the door and shut it again.



Three beeps signal the end of each programme; the clocktime is displayed again.

If the door is left open, the light shuts off after 3 minutes. You may light up your oven by turning the selector knob to the  position.



In order to evacuate moisture, your appliance is fitted with a delayed ventilation function. Depending on the applied cooking mode (solo / grill), the oven ventilation will continue to operate after the end of the programme. It will switch off automatically.

using the power levels

Power level	Use
1000 W / 900 W	Rapidly heating drinks, water, dishes containing a lot of liquid. Cooking foods containing a lot of water (soups, sauces, tomatoes, etc.).
800 W / 700 W	Cooking fresh or frozen vegetables.
600 W	Melting chocolate.
500 W	Cooking fish and shellfish. Reheating on 2 levels. Simmering pulses. Heating or cooking delicate egg-based foods.
400 W / 300 W	Simmering dairy products, jams.
200 W	Manual defrosting. Softening butter, ice cream.
100 W	Defrosting pastries containing cream.

MICROWAVE OUTPUT POWER: 1000 W

microwave function

Programming by power



Turn the selector knob to select the microwave function. The maximum power level, 1000W, flashes in the display.



Turn the “- / +” selector if you wish to set a lower microwave power level, ex. 500W. Confirm the power level by pressing the °C/W button, the time digits flash in the display.



Turn the “- / +” selector to set the required programme time, ex. 10 minutes.



Confirm by pressing START. The light switches on and the programme starts.

Display



Comments:

If the door is opened during cooking, the appliance stops and the remaining time flashes in the display. To finish the programme, simply close the door and press START.



The time can be adjusted at any time simply by turning the “- / +” selector.

express programme

Express Programming

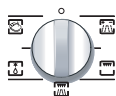

With the selector at the OFF (0) position, press the START key for one second to set an express programme of 30 seconds. The microwave functions at maximum power level (1000W). The light switches on and the programme starts.



You may set an express programme up to 2 min 30 s. Each time you press START an additional 30 seconds of programme time is added. Press 5 times for a maximum of 2 min 30s.

Once the programme has begun, you may modify the programme time by turning the “- / +” selector knob, up to 2 min 30s.

Display



heat & hold function

Heat and hold

If you leave your dish in the oven without opening the door at the end of a microwave programme, a heat and hold function starts up after 2 minutes to maintain the temperature of your dish. A triple beep after 15 min announces the end of the heat and hold programme.

Display



reheating on 2 levels

For best results heating up 2 dishes at the same time, programme the microwave function at the 500 watt setting and place one plate on the turntable and another on the grill at insertion level 3.



Recommendations:

Cover the plates with microwave-safe cling film or another plate turned upside down. The times indicated below are based on heating of refrigerated dishes, or canned goods at room temperature.

Type of food	Quantity	Time
Homogeneous foods such as purees, peas, celery, etc.	2 x 200 g plates	4 - 6 min
Mixed consistency dish such as cassoulet, stews, ravioli, etc.	2 x 300 g plates	6 - 8 min

automatic cook functions

With the automatic cooking functions, the time and function are programmed automatically according to the type of food and its weight.



Fresh, ready-made dishes

This function is used for heating refrigerated, ready-made meals (lasagna, potato gratin, cottage pie, fish gratin, etc.) weighing 100 g - 1000 g.

The dishes are heated with the microwave function.

Remove the product from its packaging and place it in a microwave-safe, heatproof dish of comparable size. For best results, cover with microwave-safe cling film, the special microwave plate cover or another plate turned upside down.

Place the dish on the turntable. Let the dish rest a couple of minutes before serving, to ensure even heat distribution.

defrosting



Defrosting frozen foods in your microwave oven saves you considerable time. To defrost food, use the AUTOMATIC DEFROST function or the MICROWAVE function, power level 200W.

What you need to know:

Small pieces of meat or fish may be cooked immediately after defrosting. Large pieces such as meat roasts or whole fish will remain slightly frozen at the end of the defrost programme. We recommend leaving them to stand for a period at least equal to the defrosting time in order to obtain a uniform temperature.

Food covered with ice crystals will take longer to defrost. In this case, you will need to increase the defrosting time.

Recommendations:

Defrosting time varies according to the type of appliance. It also depends on the shape, size, initial temperature and quality of the food.

Most foods need to be removed from their packaging. Remember to remove metal fasteners from packaging.

Halfway through defrosting, the pieces must be turned, mixed or broken apart if they are frozen together.

If you are defrosting large pieces of meat or fish which prevent the turntable from revolving, use the stop turntable function. In this case, turn the food regularly.

Defrost meat and fish on an upside down saucer on top of another plate so that the juice runs off. If it remains in contact with the food, it will cause it to overheat.
Never refreeze uncooked food.

Defrost programme times:

The lengths of the defrost programmes are calculated for foods frozen at -18°C. They give you an idea of the necessary defrost time, however actual time may vary according to the thickness, shape, size and packaging of the food.

Programming choices:

Auto defrost programmes are available as follows:

- d 1 corresponds to 200W, defrost power level
Select d1 if you wish to defrost any food/quantity that is not proposed in d2, d3, or d4. Programme the defrost time you wish.
You may refer to the chart which follows for suggested defrost times.
- d 2 defrosting meat, poultry, fish, vegetables
- d 3 defrosting bread
- d 4 defrosting ready-made dishes

the automatic defrost function

Select the type and amount of food you wish to defrost and the automatic function will programme the appropriate defrosting time.

Automatic defrosting



Turn the selector knob to the auto defrost position and d1 appears in the display.



°C/W

Turn the “- / +” selector knob to select d2 / d3 / d4, ex. d2. Confirm by pressing °C/W.



For defrost program d1, the time digits flash in the display.
For d2 / d3 / d4 defrost programmes, 100 g (the minimum defrosting weight) appears in the display.



Turn the “- / +” selector knob to set the time (d1) or weight (d2 / d3 / d4), ex. 700g. Confirm by pressing START.

The appropriate time is automatically calculated.
The programme time appears in the display and the defrost programme begins.

Display

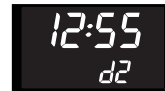

Comments:

Defrosting time is automatically calculated according to the weight of the food. It may vary depending on the initial temperature of the food (times are given for foods frozen at -18°C).

Halfway through an automatic defrost programme of foods weighing over 350g (with the exception of bread), a beep reminds you to turn the food for better results, and “turn” is displayed. Close the door after turning the food and press START to continue the defrost programme.

turn

Defrosting time cannot be changed when using the automatic defrost function.

*To ensure even results, the **STOP TURNTABLE** function may not be used with the automatic defrost function.*

*For foods that do not appear in the suggested food categories, use the **MICROWAVE** function at the 200 W power level or **d 1**. Refer to the indications below for approximate times.*

Food	Quantity	Time	Recommendations
Flaky or shortcrust pastry	400 g	1 - 3 min	Place on kitchen paper, turn midway
Scallops	500 g	5 - 7 min	Place on a plate, stir midway
Peeled prawns	100 g	1 - 2 min	“ ”
Whole pink prawns	200 g	2 - 4 min	“ ”
Langoustines / Gambas (10)	500 g	6 - 8 min	“ ”
Strawberries	250 g	7 - 9 min	
Raspberries/sour cherries		6 - 8 min	
Gooseberries / blueberries / blackcurrants		5 - 7 min	

grill functions

This function is used for cooking and browning foods such as gratin dishes and meats. It may be used before or after cooking, according to the recipe.



Warning:

Accessible areas may become hot when the grill is used. Children should be kept away. If the appliance is operating in combined mode, we recommend that children be supervised by adults when using the oven due to the high temperatures.

When using the grill, you must protect your hands when taking out dishes and use containers made from heatproof materials such as flameproof glass or china.

There are 3 grill levels: low GRILL POWER (GP 1) / medium (GP 2) / high (GP 3).

As a rule, you should use GRILL POWER 3 to grill meat and fish and GRILL POWER 1 or 2 with the MICROWAVE + GRILL FUNCTION for gratin dishes and browning more delicate dishes.

Insert the grill according to the height of the container or the food.

Programming the GRILL function

Display



Turn the selector knob to select the grill function. GP3 flashes, requesting you choose the desired grill level.

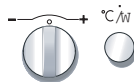

Turn the “ - / + ” selector knob to set a lower grill level, ex. GP2. Confirm by pressing °C/W, the time digits flash in the display.



Turn the “ - / + ” selector knob to set the required grilling time, ex. 20 minutes.



Confirm by pressing START, the light switches on and the programme starts.



Comment:

Grilling time may be changed at any time simply by turning the “ - / + ” selector.

guide to cooking using the high grill function

Place the food item on the grill set inside the enamel tray (to recover the juices) and insert at level 3. Turn the food halfway through cooking.





Food	Quantity	Time
Andouillettes, blood sausage, sausages (pierce with a fork)	4 - 6 units	22 - 30 min
Pork chops	4 units	27 - 32 min
Lamb cutlets	4 units	15 - 17 min
Rib roast	800 g	23 - 25 min
Side bacon	4 - 6 slices	18 - 25 min

the grill & microwave function

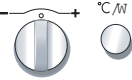

This function lets you use the grill + microwave at the same time, which affords rapid cooking. You may combine any one of the three grill levels with any of the microwave levels up to 700W.

Programming the GRILL + MICROWAVE FUNCTION

-  Turn the selector knob to the GRILL + MICROWAVE function. The power level 500W, flashes in the display, requesting you choose the desired microwave power level.
-  Turn the “-/+” selector knob to set a lower microwave power level, ex. 300W. Confirm by pressing °C/W, GP3 flashes, requesting you choose the desired grill level.
-  Turn the “-/+” selector knob to set a lower grill level, ex. GP2. Confirm by pressing °C/W, the time digits blink.
-  Turn the “-/+” selector knob to set the required combined microwave + grilling time, ex. 20 min.
-  Confirm by pressing START, the light switches on and the programme starts.

Display



Comment:

The programme time may be changed at any time simply by turning the “-/+” selector knob. If you wish to verify your microwave power level, you may press °C/W to check the display.

guide to cooking using the grill & microwave function



Use a microwave-safe and heatproof dish, preferably made of earthenware (less splashing than with glass).

Place the food item in a dish on the grill at level 1, turn halfway through cooking.

Cook preferably non-barded roasts to avoid grease splashes and smoke.

Season when cooked, let the meat sit in aluminium foil for 10 minutes. This helps the meat fibres to relax and the roast will be more tender.

Food	Quantity	Programming	Time
Shoulder of lamb (boned and tied)	1300 g	200 W + GP3	40 - 45 min
Ribeye steak	800 g	200 W + GP3	18 - 23 min
Chicken, guinea fowl	1200 g	500 W + GP3	25 - 27 min
Turkey roast	800 g	300 W + GP3	27 - 32 min
Pork roast	1000 g	300 W + GP3	35 - 40 min
Veal roast	1200 g	300 W + GP2	50 - 55 min

child lock

You can programme the "CHILD LOCK" feature to block unauthorised use of your microwave oven.

To set:

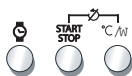

Press the **START/STOP** key for a few seconds with the door open, until the key appears in the display. A short beep confirms that your microwave is temporarily locked. No programme is available.

To cancel:

Follow the same procedure: press the **START/STOP** key, the clock key, and the **°C/W** key for a few seconds with the door open. The key symbol switches off and clock-time is displayed.

We recommend that you clean the oven regularly and remove any food deposits inside and outside the appliance. Use a damp, soapy sponge. If the appliance is not kept clean, its surface may become damaged and this will considerably shorten its lifespan and cause a dangerous situation. If the door or seal are damaged, the oven must not be used until repaired by a qualified person.

Do not clean the appliance with a steam cleaner.

The use of abrasive products, alcohol or solvents is not recommended. They are likely to damage the appliance.

If the oven smells unpleasant or is encrusted with dirt, boil a cup of water with lemon juice for 2 minutes and clean the sides with a little washing-up liquid.

In order to clean the roof of the cavity, tip the grill resistance downwards (*Fig.13*). Unhook the grill resistance by pressing on the rod at top left (*Fig.14*).

The turntable may be removed for easier cleaning. To remove it, grasp it by the access areas provided for this purpose. If you remove the driver, avoid getting any water in the motor axis hole.

Remember to put back the driver, the base rollers and the turntable.

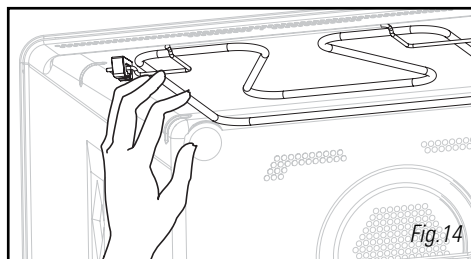
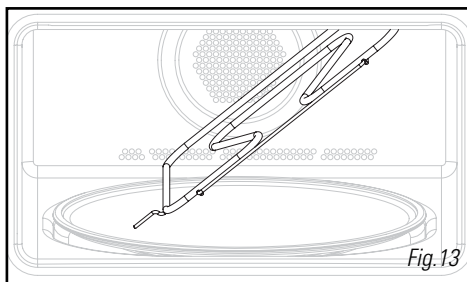

If you have a query concerning the operation of your appliance, this does not necessarily mean that there is a breakdown. In all events, check the following points:

You notice that	Solution
<p>The time is counting down but the appliance is not functioning (the food is not heated) and "DEMO" flashes in the display.</p>	<p>Demonstration mode has been set. To switch back into operating mode, press the following three keys all at the same time:</p> 
<p>The appliance does not switch on.</p>	<p>Check that the appliance is properly connected. Check that the oven door is properly closed. Check that the child lock feature is not programmed.</p>
<p>The appliance continues to make a noise after the programme has finished.</p>	<p>In order to evacuate residual steam, your appliance is equipped with a delayed ventilation feature. According to the cooking mode chosen (solo/grill), the ventilation may continue to function after the end of the programme.</p>
<p>The appliance is noisy. The turntable does not revolve properly.</p>	<p>Clean the rollers and the roller area under the turntable. Check that the rollers are correctly positioned.</p>
<p>You notice steam on the glass.</p>	<p>Wipe off the condensation with a cloth.</p>
<p>The food is not heated in the microwave programme.</p>	<p>Check that the utensils are suitable for use with microwave ovens and that the power level is appropriate.</p>
<p>Smoke comes off the grill at the start of the programme.</p>	<p>Remove all cooking residues from the heating element before each use.</p>
<p>The appliance produces sparks.</p>	<p>Clean the appliance thoroughly: remove grease, cooking particles, etc. Make sure no metal objects are close to the oven walls. Never use metal objects with the grill. Never operate your oven when it is empty.</p>

Operating proficiency testing according to CEI/EN/NF EN 60705 standards;
The International Electrotechnical Commission, SC.59K, has established a standard relative to comparative performance tests conducted on various microwaves.
We recommend the following for this appliance:

Test	Load	Approx. time	Power selector	Containers/ Recommendations
Egg custard (12.3.1)	1000 g	16 - 18 min	500 W	Pyrex 227 On the turntable
	750 g	13 - 15 min		Pyrex 220 On the turntable
Sponge cake (12.3.2)	475 g	6 - 7 min	700 W	Pyrex 827 On the turntable
Meatloaf (12.3.3)	900 g	14 min	700 W	Pyrex 838 Cover with cling film On the turntable
Defrosting meat (13.3)	500 g	11 - 12 min	200 W	On the turntable
Defrosting raspberries (B.2.1)	250 g	6 - 7 min	200 W	On a flat plate On the turntable
Potato gratin (12.3.4)	1100 g	23 - 25 min	Low Grill + 700 W	Pyrex 827 On the turntable
Chicken (12.3.6)	1200 g	24 - 26 min	High Grill + 500 W	Place on a dish on the grill inserted at the 1 st level from the bottom Turn halfway through

