

SKINANDE



Design and Quality
IKEA of Sweden

Contents

Safety information	4	Daily use	11
Safety instructions	5	Hints and tips	13
Product description	7	Care and cleaning	14
Control panel	7	Troubleshooting	16
Programmes	8	Technical information	18
Options	9	ENVIRONMENT CONCERNS	18
Settings	10	IKEA GUARANTEE	18
Before first use	11		

Subject to change without notice.

Safety information

Before the installation and use of the appliance, carefully read the supplied instructions. The manufacturer is not responsible if an incorrect installation and use causes injuries and damages. Always keep the instructions with the appliance for future reference.

Children and vulnerable people safety

- This appliance can be used by children aged from 8 years and above and persons with reduced physical, sensory or mental capabilities or lack of experience and knowledge if they have been given supervision or instruction concerning use of the appliance in a safe way and understand the hazards involved.
- Do not let children play with the appliance.
- Keep all detergents away from children.
- Keep children and pets away from the appliance door when it is open.
- Cleaning and user maintenance shall not be made by children without supervision.

General Safety

- This appliance is intended to be used in household and similar applications such as:
 - farm houses; staff kitchen areas in shops, offices and other working environments;
 - by clients in hotels, motels, bed & breakfast and other residential type environments.
- Do not change the specification of this appliance.
- The operating water pressure (minimum and maximum) must be between 0.5 (0.05) / 8 (0.8) bar (Mpa)
- Obey the maximum number of 12 place settings.
- If the supply cord is damaged, it must be replaced by the manufacturer, its Authorised Service Centre or similarly qualified persons in order to avoid a hazard.
- Put knives and cutlery with sharp points in the cutlery basket with the points down or in a horizontal position.
- Do not keep the appliance door open without supervision to prevent to fall on it.
- Before maintenance, deactivate the appliance and disconnect the mains plug from the mains socket.
- Do not use water spray and steam to clean the appliance.
- The ventilation openings in the base (if applicable) must not be obstructed by a carpet.
- The appliance is to be connected to the water mains using the new supplied hose-sets. Old hose sets must not be reused.

Safety instructions

Installation

- Remove all the packaging.
- Do not install or use a damaged appliance.
- Do not install or use the appliance where the temperature is less than 0 °C.
- Obey the installation instruction supplied with the appliance.
- Make sure that the appliance is installed below and adjacent to safe structures.

Electrical connection

⚠ Warning! Risk of fire and electrical shock.

- The appliance must be earthed.
- Make sure that the electrical information on the rating plate agrees with the power supply. If not, contact an electrician.
- Always use a correctly installed shockproof socket.
- Do not use multi-plug adapters and extension cables.
- Make sure not to cause damage to the mains plug and to the mains cable. Should the mains cable need to be replaced, this must be carried out by our Authorised Service Centre.
- Connect the mains plug to the mains socket only at the end of the installation. Make sure that there is access to the mains plug after the installation.
- Do not pull the mains cable to disconnect the appliance. Always pull the mains plug.
- This appliance complies with the E.E.C. Directives.
- Only for UK and Ireland. The appliance has a 13 amp mains plug. If it is necessary to change the fuse in the mains plug, use fuse: 13 amp ASTA (BS 1362).

Water connection

- Make sure not to cause damage to the water hoses.
- Before you connect the appliance to new pipes or pipes not used for a long time, let the water flow until it is clean.
- The first time you use the appliance, make sure that there is no leakage.
- The water inlet hose has a safety valve that prevents the hose to loosen. To disconnect the hose, press the lever (B)

and turn the fastener (A) clockwise.

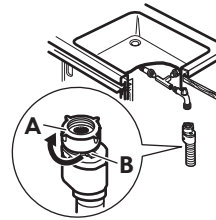

- The water inlet hose has an external transparent sheath. If the hose is damaged, the water in the hose becomes dark.
- If the water inlet hose is damaged, immediately disconnect the mains plug from the mains socket. Contact the Authorised Service Centre to replace the water inlet hose.

Use

- Do not sit or stand on the open door.
- Dishwasher detergents are dangerous. Obey the safety instructions on the detergent packaging.
- Do not drink and play with the water in the appliance.
- Do not remove the dishes from the appliance until the programme is completed. There can be detergent on the dishes.
- The appliance can release hot steam if you open the door while a programme operates.
- Do not put flammable products or items that are wet with flammable products in, near or on the appliance.

Service

- Contact the Authorised Service Centre to repair the appliance. We recommend only the use of original spare parts.
- When you contact the Authorised Service Centre, ensure that you have the following information that is available on the rating plate.

Model :
PNC :

Serial Number :

Disposal

Warning! Risk of injury or suffocation.

- Disconnect the appliance from the mains supply.
- Cut off the mains cable and discard it.
- Remove the door catch to prevent children and pets to get closed in the appliance.

Product description

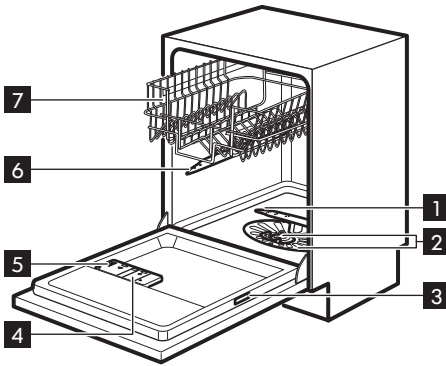

- 1** Lower spray arm
- 2** Filters
- 3** Rating plate
- 4** Rinse aid dispenser
- 5** Detergent dispenser
- 6** Upper spray arm
- 7** Upper basket

Beam-on-Floor

The Beam-on-Floor is a light that shows on the kitchen floor below the appliance door.

- When the programme starts, a red light comes on and stays on for all the duration of the programme.
- When the programme is completed, a green light comes on.

- When the appliance has a malfunction, the red light flashes.
- i** The Beam-on-Floor goes off when the appliance is deactivated.

Control panel

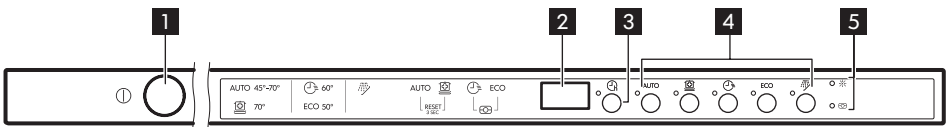



- 1** On/off button
- 2** Display



- 3** Delay button
- 4** Programme buttons

5 Indicators

Indicators

Indicator	Description
	Multitab indicator.
	Rinse aid indicator. It is always off while the programme operates.

Programmes

Programme	Degree of soil Type of load	Programme phases	Consumption values 1)		
			Duration (min)	Energy (kWh)	Water (l)
AUTO ²⁾	All Crockery, cutlery, pots and pans	<ul style="list-style-type: none"> • Prewash • Wash from 45 °C to 70 °C • Rinses • Dry 	40 - 150	0.6 - 1.4	7 - 12
 ³⁾	Heavy soil Crockery, cutlery, pots and pans	<ul style="list-style-type: none"> • Prewash • Wash 70 °C • Rinses • Dry 	140 - 160	1.3 - 1.5	13 - 15
 ⁴⁾	Fresh soil Crockery and cutlery	<ul style="list-style-type: none"> • Wash 60 °C or 65 °C • Rinses 	30	0.9	9
ECO ⁵⁾	Normal soil Crockery and cutlery	<ul style="list-style-type: none"> • Prewash • Wash 50 °C • Rinses • Dry 	128	0.75	10.3

Programme	Degree of soil Type of load	Programme phases	Consumption values 1)		
			Duration (min)	Energy (kWh)	Water (l)
 6)	All	• Prewash	14	0.1	4

1) The pressure and the temperature of the water, the variations of the mains supply, the options and the quantity of dishes can change the values.

2) The appliance senses the degree of soil and the quantity of items in the baskets, it automatically adjusts the temperature and the quantity of the water, the energy consumption and the programme duration.

3) Programme with prolonged rinsing time in high temperature for extra hygienic wash-up. Ideal for baby bottles or when a family member is ill.

4) With this programme you can wash a load with fresh soil. It gives good washing results in a short time.

5) With this programme you have the most efficient use of water and energy consumption for crockery and cutlery with normal soil. (This is the standard programme for test institutes).

6) Use this programme to quickly rinse the dishes. This prevents the remaining food to bond on the dishes and bad odours to come out from the appliance. Do not use detergent with this programme.

Information for test institutes

For all the necessary information for test performance, send an email to:

info.test@dishwasher-production.com

Write down the product number (PNC) that is on the rating plate.

Options

Multitab



Activate this option when you use multi-tablets that integrate the rinse aid and detergent functions. They can also contain other cleaning or rinsing agents.

With the use of this option the programme duration is prolonged to increase the cleaning and drying results with the use of multi-tablets.

You do not need to activate the option Multitab every time you start a programme. Once you have activated the option it will remain active.

How to activate Multitab

Press at the same time  and **ECO**.

- The indicator  comes on = option activated.
- The indicator  goes off = option deactivated.

What to do if you want to stop using multi-tablets

Before you start to use detergent and rinse aid separately do the following procedure.

1. Make sure that the rinse aid container is full.
2. Start the shortest programme with a rinsing phase. Do not add detergent and do not load the baskets.
3. When the programme is completed, adjust the released quantity of rinse aid.

Settings

Programme selection mode and user mode

When the appliance is in programme selection mode it is possible to set a programme and to enter the user mode.

In user mode, the following settings can be changed:

- The activation or the deactivation of the acoustic signal for end of programme.
- The deactivation of the rinse aid dispenser when you want to use the Multitab option without rinse aid.

These settings will be saved until you change them again.

How to set the programme selection mode

The appliance is in programme selection mode when the programme indicator **ECO** is on and the display shows the programme duration.

When you activate the appliance, usually it is in programme selection mode. However, if this does not happen, you can set the programme selection mode in the following way:

Press and hold simultaneously **AUTO** and  until the appliance is in programme selection mode.









Use of rinse aid and multi-tablets

When you activate the option Multitab, the rinse aid dispenser continues to release rinse aid. However you can deactivate the rinse aid dispenser. In this case the drying results may not be satisfactory.

With the rinse aid dispenser deactivated, the rinse aid indicator is always off.

How to deactivate the rinse aid dispenser

The appliance must be in programme selection mode.

1. To enter the user mode, press and hold simultaneously **AUTO** and  until the indicators , **AUTO** and  start to flash and the display is blank.
2. Press .
 - The indicators **AUTO** and  go off.
 - The indicator  continues to flash.
 - The display shows the current setting.
 -  **d** = rinse aid dispenser activated.
 -  **d** = rinse aid dispenser deactivated.
3. Press  to change the setting.
4. Press the on/off button to confirm the setting.



Acoustic signals



The acoustic signals operate when the appliance has a malfunction and it is not possible to deactivate them.

There is also an acoustic signal that operates when the programme is completed. By default, this acoustic signal is on, but it is possible to deactivate it.

How to deactivate the acoustic signal for the end of programme

The appliance must be in programme selection mode.

1. To enter the user mode press and hold simultaneously **AUTO** and  until the indicators , **AUTO** and  start to flash and the display is blank.
2. Press **AUTO**.

- The indicator  and  go off.
- The indicator **AUTO** continues to flash.
- The display shows the current setting:
 - *!b* = Acoustic signal on.

- *Ob* = Acoustic signal off.
3. Press **AUTO** to change the setting.
 4. Press the on/off button to confirm the setting.

Before first use

1. Fill the rinse aid dispenser.
2. Open the water tap.
3. Start a program to remove any processing residuals that can still be inside the appliance. Do not use detergent and do not load the baskets.

Filling the rinse aid dispenser

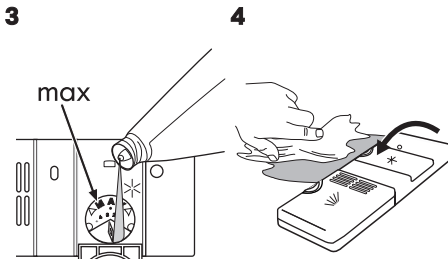
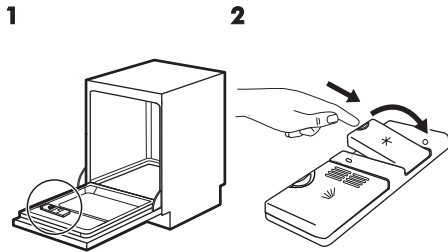

5



To adjust the released quantity of rinse aid, turn the selector between position 1 (lowest quantity) and position 4 (highest quantity).

Daily use

1. Open the water tap.
 2. Press the on/off button to activate the appliance.
- Make sure that the appliance is in programme selection mode.
- If the rinse aid indicator is on, fill the rinse aid dispenser.

3. Load the baskets.
4. Add the detergent. If you use multi-tablets, activate the option Multitab.
5. Set and start the correct programme for the type of load and the degree of soil.

Using the detergent

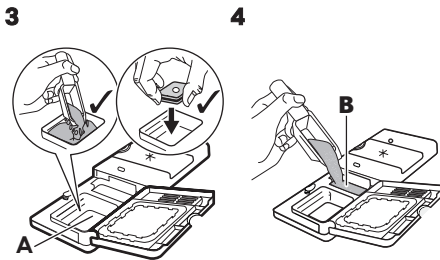
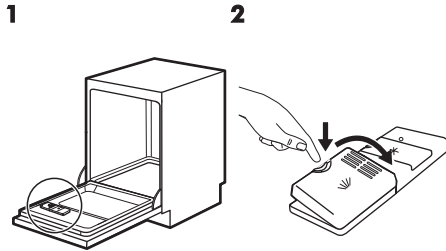

Put the detergent or the multi-tablet in compartment (A).

If the programme has a prewash phase, put a small quantity of detergent in compartment (B).

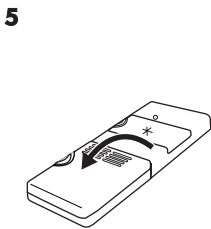

- 5 minutes after the completion of the programme.
- After 5 minutes if the programme has not started.

Starting a programme

1. Keep the appliance door ajar.
2. Press the on/off button to activate the appliance. Make sure that the appliance is in programme selection mode.
3. Press the button related to the programme you want to start. The display shows the programme duration.
4. Set the applicable options.
5. Close the appliance door to start the programme.

Starting a programme with delay start

1. Set a programme.
2. Press repeatedly until the display shows the delay time you want to set (from 1 to 24 hours). The delay indicator comes on.
3. Close the appliance door to start the countdown. While a countdown is running it is possible to increase the delay time but not to change the selection of the programme and options. When the countdown is completed, the programme starts.

Opening the door while the appliance operates

If you open the door while a programme is running, the appliance stops. When you close the door, the appliance continues from the point of interruption.

Setting and starting a programme

The Auto Off function

This function decreases energy consumption by automatically deactivating the appliance when it is not operating.

The function comes into operation:

Canceling the delay start while the countdown operates

When you cancel the delay start you have to set the programme and options again.

Press and hold simultaneously **AUTO** and  until the appliance is in programme selection mode.

Canceling the programme

Press and hold simultaneously **AUTO** and  until the appliance is in programme selection mode.

Make sure that there is detergent in the detergent dispenser before you start a new programme.

End of the programme

When the programme is completed the display shows 0:00 .

1. Press the on/off button or wait for the Auto Off function to automatically deactivate the appliance.
2. Close the water tap.

 For the better drying results keep the appliance door ajar for some minutes before you remove the dishes. Let the dishes cool down before you remove them from the appliance. Hot dishes are easily damaged.

Hints and tips

General

The following hints will ensure optimal cleaning and drying results in daily use and also help to protect the environment.

- Remove larger residues of food from the dishes into the waste bin.
- Do not pre-rinse dishes by hand. When needed, use the prewash programme (if available) or select a programme with a prewash phase.
- Always use the whole space of the baskets.
- When loading the appliance, make sure that the dishes can be completely reached and washed by the water released from the spray arm nozzles. Make sure that items do not touch or cover each other.
- You can use dishwasher detergent and rinse aid separately or you can use the

multi-tablets. Follow the instructions written on the packaging.

- Select the programme according to the type of load and degree of soil. With the ECO programme you have the most efficient use of water and energy consumption for crockery and cutlery with normal soil.

Using rinse aid and detergent

- Only use rinse aid and detergent for dishwasher. Other products can cause damage to the appliance.
- The rinse aid helps, during the last rinsing phase, to dry the dishes without streaks and stains.
- If you use multi-tablets you can select the Multitab option (if available). This option improves the cleaning and drying results with the use of multi-tablets.

- Detergent tablets do not fully dissolve with short programmes. To prevent detergent residues on the tableware, we recommend that you use the tablets with long programmes.
- Do not use more than the correct quantity of detergent. Refer to the instructions on the detergent packaging.

Loading the baskets

-  Refer to the supplied leaflet with examples of the load of the baskets.
- Only use the appliance to wash items that are dishwasher-safe.
- Do not put in the appliance items made of wood, horn, aluminium, pewter and copper.
- Do not put in the appliance items that can absorb water (sponges, household cloths).
- Remove remaining food from the items.
- Soak items with remaining burned food in water.
- Put hollow items (cups, glasses and pans) with the opening down.
- Make sure that cutlery and dishes do not bond together. Mix spoons with other cutlery.
- Make sure that glasses do not touch other glasses.

- Put small items in the cutlery basket.
- Put light items in the upper basket. Make sure that the items do not move.
- Make sure that the spray arm can move freely before you start a programme.

Before starting a programme

Make sure that:



- The filters are clean and correctly installed.
- The spray arms are not clogged.
- There is dishwasher rinse aid (unless you use multi- tablets).
- The position of the items in the baskets is correct.
- The programme is applicable for the type of load and for the degree of soil.
- The correct quantity of detergent is used.

Unloading the baskets

1. Let the tableware cool down before you remove it from the appliance. Hot items can be easily damaged.
2. First remove items from the lower basket, then from the upper basket.

-  At the end of the programme water can still remain on the sides and on the door of the appliance.

Care and cleaning

-  **Warning!** Before maintenance, deactivate the appliance and disconnect the mains plug from the main socket.
-  Dirty filters and clogged spray arms decrease the washing results. Make a check regularly and, if necessary, clean them.

Cleaning the filters

1

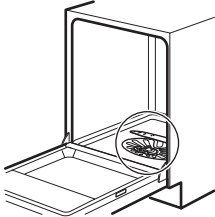

Make sure that there are no residues of food or soil in or around the edge of the sump.

2

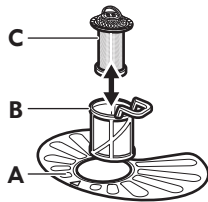

3

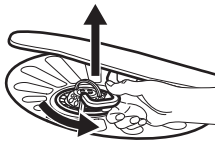

To remove filters (B) and (C) turn the handle counterclockwise and remove. Pull apart filter (B) and (C). Wash the filters with water.

4

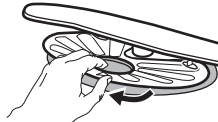

Remove filter (A). Wash the filter with water.

5

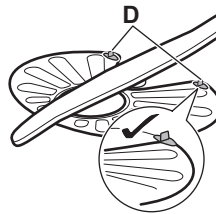

Put the flat filter (A) back in place. Make sure that it is correctly positioned under the 2 guides (D).

6

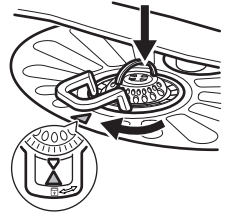

Assemble filters (B) and (C). Put them into position in filter (A). Turn the handle clockwise until it locks.



An incorrect position of the filters can cause bad washing results and damage to the appliance

Cleaning the filter of the inlet hose

1

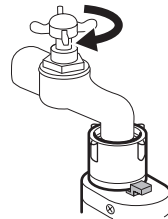

Close the water tap.

2

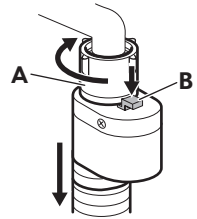

Disconnect the hose. Press the lever B and turn the fastener A clockwise.

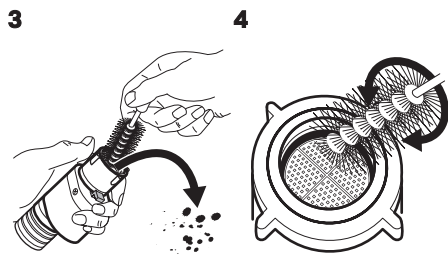

Clean the filter of the inlet hose.

Cleaning the spray arms

Do not remove the spray arms. If the holes in the spray arms are clogged, remove remaining parts of soil with a thin pointed object.

External cleaning

- Clean the appliance with a moist soft cloth.
- Only use neutral detergents.
- Do not use abrasive products, abrasive cleaning pads or solvents.

Internal cleaning

- Carefully clean the appliance, including the rubber gasket of the door, with a soft moist cloth.
- If you regularly use short duration programmes, these can leave deposits of grease and limescale inside the appliance. To prevent this, we recommend to run long duration programmes at least 2 times per month.

Troubleshooting

If the appliance does not start or it stops during operation, before you contact an Authorised Service Centre, check if you can solve the problem by yourself with the help of the information in the table.

With some problems, the display shows an alarm code.

Problem and alarm code	Possible solution
You cannot activate the appliance.	<ul style="list-style-type: none"> • Make sure that the mains plug is connected to the mains socket. • Make sure that there is no damaged fuse in the fuse box.
The programme does not start.	<ul style="list-style-type: none"> • Make sure that the appliance door is closed. • If the delay start is set, cancel the setting or wait for the end of the countdown.

Problem and alarm code	Possible solution
The appliance does not fill with water. The display shows <i>i10</i> .	<ul style="list-style-type: none"> • Make sure that the water tap is open. • Make sure that the pressure of the water supply is not too low. For this information, contact your local water authority. • Make sure that the water tap is not clogged. • Make sure that the filter in the inlet hose is not clogged. Clean the filter. • Make sure that the inlet hose has no kinks or bends.
The appliance does not drain the water. The display shows <i>i20</i> .	<ul style="list-style-type: none"> • Make sure that the sink spigot is not clogged. • Make sure that the drain hose has no kinks or bends.
The anti-flood device is on. The display shows <i>i30</i> .	<ul style="list-style-type: none"> • Close the water tap and contact an Authorised Service Centre.

Once you have checked the appliance, deactivate and activate the appliance. If the problem occurs again, contact an Authorised Service Centre.

For alarm codes not described in the table, contact an Authorised Service Centre.

The washing and drying results are not satisfactory

Problem	Possible solution
There are whitish streaks or bluish layers on glasses and dishes.	<ul style="list-style-type: none"> • The release quantity of rinse aid is too much. Adjust the rinse aid selector to a lower position. • The quantity of detergent is too much.
There are stains and dry water drops on glasses and dishes.	<ul style="list-style-type: none"> • The released quantity of rinse aid is not sufficient. Adjust the rinse aid selector to a higher position. • The quality of the rinse aid can be the cause.
The dishes are wet.	<ul style="list-style-type: none"> • The programme does not have a drying phase or has a drying phase with low temperature. • The rinse aid dispenser is empty. • The quality of the rinse aid can be the cause. • The quality of the multi-tablets can be the cause. Try a different brand or activate the rinse aid dispenser and use rinse aid and multi-tablets together.

 Refer to "**Hints and tips**" for other possible causes.

Technical information

Product denomination	Fully integrated dishwasher	
Dimensions	Width / height / depth (mm)	596 / 818-898 / 555
Electrical connection ¹⁾	Voltage (V)	220 - 240
	Frequency (Hz)	50
Water supply pressure	Min. / max. bar (MPa)	0.5 (0.05) / 8 (0.8)
Water supply	Cold water or hot water ²⁾	max 60 °C
Capacity	Place settings	12
Power consumption	Left-on mode (W)	5.0
Power consumption	Off-mode (W)	0.10

1) Refer to the rating plate for other values.

2) If the hot water comes from alternative source of energy, (e.g. solar panels, aeolian energy), use the hot water supply to decrease energy consumption.

ENVIRONMENT CONCERNS

Recycle the materials with the symbol . Put the packaging in applicable containers to recycle it. Help protect the environment and human health and to recycle waste of electrical and electronic appliances. Do not

dispose appliances marked with the symbol  with the household waste. Return the product to your local recycling facility or contact your municipal office.

IKEA GUARANTEE

How long is the IKEA guarantee valid?

This guarantee is valid for five (5) years from the original date of purchase of Your appliance at IKEA Pty Ltd, ABN 84006270757 or at Cebas Pty Ltd, ABN 15 009 156 003 (Both Trading as IKEA) unless the appliance is named LAGAN in which case two (2) years of guarantee apply. The original sales receipt is required as proof of purchase. If service work is carried out

under guarantee, this will not extend the guarantee period for the appliance.

Which appliances are not covered by the IKEA five (5) years guarantee?

The range of appliances named LAGAN .

Who will execute the service?

IKEA service provider will provide the service through its own service operations or

authorized service partner network. Contact IKEA for further information.

If you encounter any trouble with the appliance and wish to register a service call or make a claim, please refer to www.ikea.com.au for your local store after sales customer service center phone number, online email and opening times.

The principal address and contact details in Australia are:

For Queensland, New South Wales, and Victorian customers please contact:

IKEA Pty Ltd
IKEA Pty Ltd IKEA Service Office L1 Clock Tower, 630 Princes Highway Tempe, NSW 2044
Contact - IKEA Customer Service at www.IKEA.com.au

For Western Australian and South Australian customers please contact:

Cebas Pty Ltd
8c Sunray Drive, Innaloo WA 6018 Australia
Contact - IKEA Customer Service at www.IKEA.com.au

What does this guarantee cover?

The guarantee covers faults of the appliance, which have been caused by faulty construction or material faults from the date of purchase from IKEA. This guarantee applies to domestic use only. The products have been designed and tested for domestic purposes only and this guarantee does not cover damage arising from use of the Product in a commercial environment.

The exceptions are specified under the headline "What is not covered under this guarantee?" Within the guarantee period, the costs to remedy the fault e.g. repairs, parts, labour and travel will be covered, provided that the appliance is accessible for repair without special expenditure. Replaced parts become the property of IKEA.

The guarantee exists only if the appliance complies and is installed in accordance with:

- The technical specifications.
- The Assembly Instructions and user manual Safety Information.

IKEA's guarantee is subject to Australian Consumer Law - see Schedule 2 to Competition and Consumer Act, 2010. This guarantee is in addition to (and does not exclude, restrict or modify in any way) any non-excludable statutory warranties in Australia.

What will IKEA do to correct the problem?

IKEA appointed service provider will examine the product and decide, at its sole discretion, if it is covered under this guarantee. They will notify you as to whether your claim is covered under this guarantee. If your claim is approved, the IKEA service provider or its authorized service partner, will then, at its sole discretion, either repair the defective product or replace it with the same or a comparable product.

What is not covered under this guarantee?

- Normal wear and tear.
- Deliberate or negligent damage, damage caused by failure to observe operating instructions, incorrect installation or by connection to the wrong voltage, damage caused by chemical or electro-chemical reaction, rust, corrosion or water damage including but not limited to dam-

age caused by excessive lime in the water supply, damage caused by abnormal environmental conditions.

- Consumable parts including batteries and lamps.
- Non-functional and decorative parts which do not affect normal use of the appliance, including any scratches and possible colour differences.
- Accidental damage caused by foreign objects including insect or vermin infestation or substances and cleaning or unblocking of filters, drainage systems or soap drawers.
- Damage to the following parts: ceramic glass, accessories, crockery and cutlery baskets, feed and drainage pipes, seals, lamps and lamp covers, screens, knobs, casings and parts of casings. Unless such damages can be proved to have been caused by production faults.
- Cases where no fault could be found during a technician's visit.
- Repairs not carried out by our appointed service providers and/or an authorized service contractual partner or where non-original parts have been used.
- Repairs caused by installation which is faulty or not according to specification.
- The use of the appliance in a non-domestic environment i.e. professional use.
- Transportation damages. If a customer transports the product to their home or other address, IKEA is not liable for any damage that may occur during transport. However, if IKEA delivers the product to the customer's delivery address, then damage to the product that occurs during this delivery will be covered by this guarantee.
- Cost for carrying out the initial installation of the IKEA appliance. However, if an IKEA service provider or its authorized service partner repairs or replaces the appliance under the terms of this guarantee, the service provider or its authorized service partner will re-

install the repaired appliance or install the replacement, if necessary.

- The appliance's serial number or warranty seal has been removed or defaced.

How country law applies

Our goods come with guarantees that cannot be excluded under the Australian Consumer Law (ACL). You are entitled to a replacement or refund for a major failure and compensation for any other reasonably foreseeable loss or damage.

You are also entitled to have the goods repaired or replaced if the goods fail to be of acceptable quality and the failure does not amount to a major failure.

This guarantee is not intended in any way to limit or exclude such rights and remedies that you may have under law.

You can find out more information about the Australian Consumer Law on the ACCC website: www.accc.gov.au

Area of validity

This IKEA guarantee applies only to products purchased and installed in AUSTRALIA .

What you must do to make a claim under the guarantee:

To make a claim under the guarantee contact IKEA after sales customer service center at the above address, the IKEA catalogue or refer to www.ikea.com.au for your local store customer service phone number, online email and opening times. Please describe the problem that you are facing with the appliance in detail along with your product article number (8 digit code) and date of purchase at the time of call registration.

Please do not hesitate to contact the dedicated after sales customer service center for IKEA appliances to:

1. Make a service request under this guarantee;
2. Ask for clarification on installation of the IKEA appliance in the dedicated IKEA kitchen furniture.
3. Ask for clarification on user manual contents and specifications of the IKEA appliance.

To ensure that we provide you with the best assistance, please read carefully the Assembly Instructions and/or the User Manual section of this booklet before contacting us.

How to reach us if you need our service



The IKEA after sales customer service centre will assist you on the phone with basic trouble shooting for your appliance at the time of service call request. Please refer to the IKEA catalogue or www.ikea.com.au and select your local store for local store phone numbers and opening times.

- i** Please describe the problem that you are facing with the appliance in detail along with your product article number (8 digit code) and date of purchase at the time of call registration .



SAVE THE SALES RECEIPT!

Kindly keep all these details and original invoice of purchase handy during the service technician's visit to enable him to carry out the job.

It is your proof of purchase and required for the guarantee to apply. Note that the receipt reports also the IKEA article name and number (8 digit code) for each of the appliances you have purchased.

