



MARQUE: MOULINEX
REFERENCE: WAFFLE TIME WJ170112
CODIC: 4244753



NOTICE
↓

waffle time
croc time

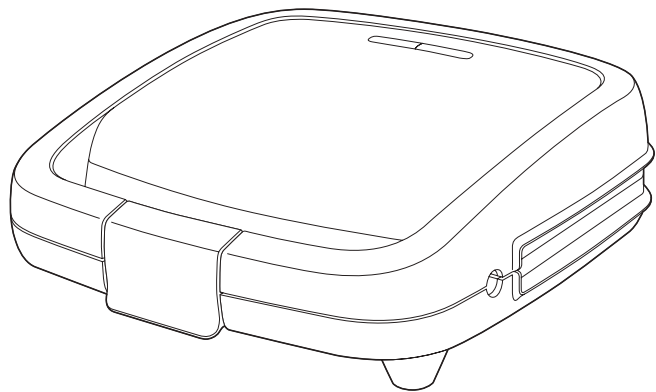

FR
NL
DE
IT
ES
PT
EN
EL
TR
DA
NO
SV
FI
PL
RU
UK
CS
SK
HU
SL
SR
BS
HR
RO
BG
ET
LT
LV
AR
FA
KK

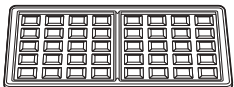
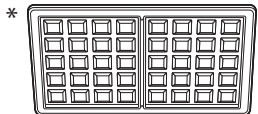
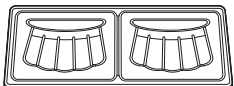
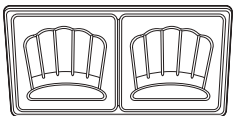
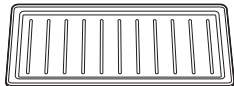
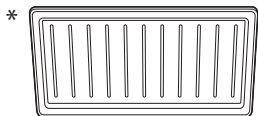
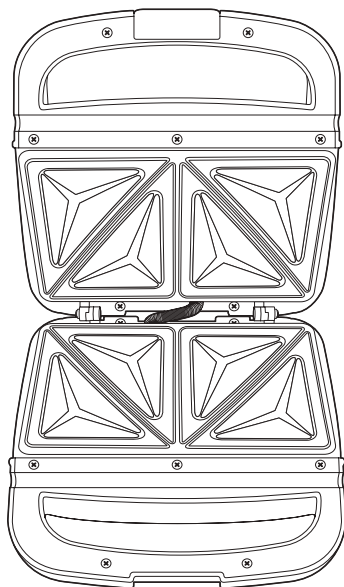
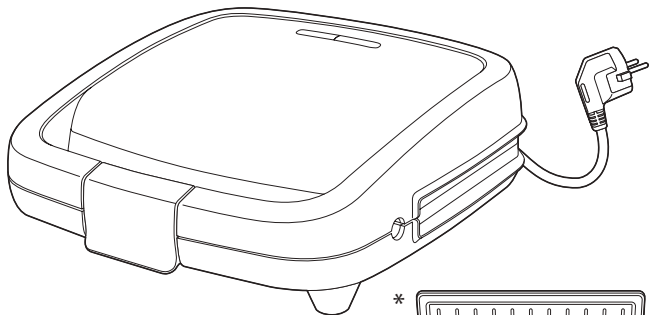

*selon modèle - afhankelijk van het model - je nach Modell - secondo il modello - según modelo - consoante o modelo - depending on the model - Ανάλογα με το μοντέλο - modele göre - afhankelijk af modellen - avhengig av modell - beroende på modell - mallista riippuen - w zależności od modelu - в зависимости от модели - залежно від моделі - podle modelu - podľa modelu - modelitõli függöen - glede na model - u zavisnosti od modela - zavisno od modela - ovisno o modelu - în funcție de model - в зависимости от модели - söltuvalt mudelist - priklausomai nuo modelio - Atkaribā no modeļa - بر حسب الموديل - بر حسب مدل - үлгісіне қарай

1

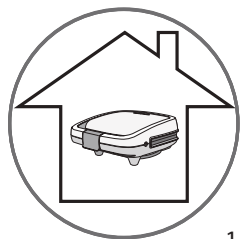

1



2

2

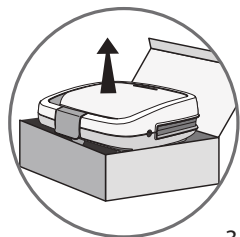
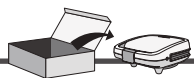

3

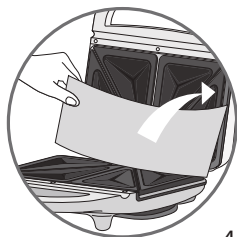

4

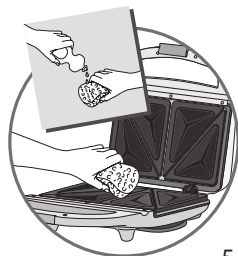

5

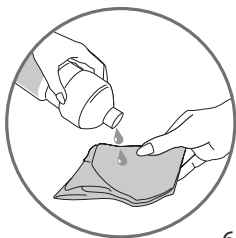
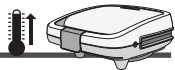

6



7



8

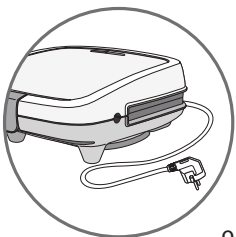

9

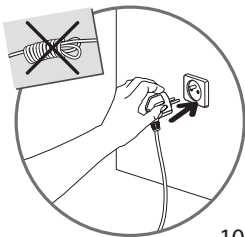

10

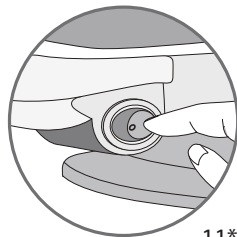

11*

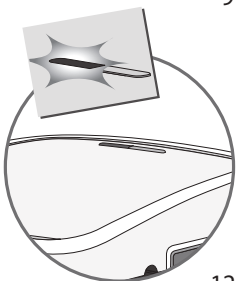

12



13

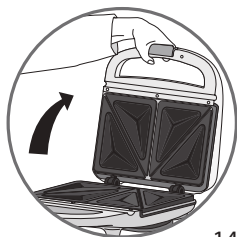

14

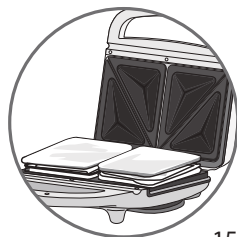

15



16

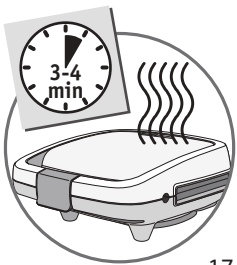

17

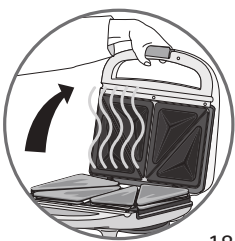

18

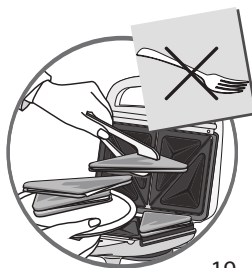

19

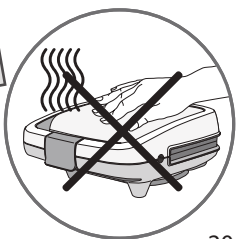

20

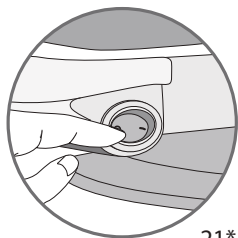
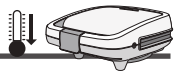

21*

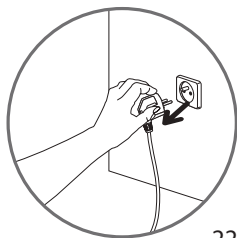

22

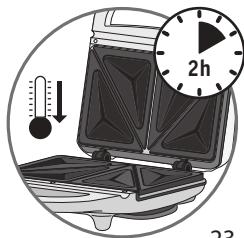

23



24

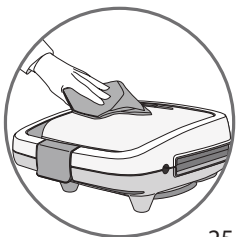

25

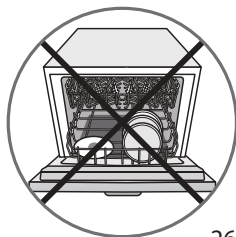

26



27

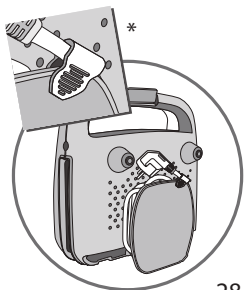

28

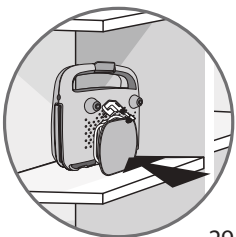

29

INTERNATIONAL GUARANTEE: COUNTRY LIST

ARGENTINA	0800-122-2732	مصر EGYPT	16622	SLOVENIJA SLOVENIA	02 234 94 90	MALAYSIA	603 7802 3000
ՀԱՅԱՍՏԱՆ ARMENIA	010 55-76-07	EESTI ESTONIA	668 1286	ΕΛΛΑΔΑ GREECE	2106371251	MEXICO	(01800) 112 8325
AUSTRALIA	1300307824	SUOMI FINLAND	09 622 94 20	香港 HONG KONG	8130 8998	MOLDOVA	22 929249
ÖSTERREICH AUSTRIA	01 890 3476	France Continentale + Gadeloupe, Martinique, Réunion, Saint-Martin	09 74 50 47 74	MAGYARORSZÁG HUNGARY	06 1 801 8434	NEDERLAND The Netherlands	0318 58 24 24
البحرين BAHRAIN	17716666	DEUTSCHLAND GERMANY	0212 387 400	INDONESIA	+62 21 5793 7007	NEW ZEALAND	0800 700 711
БЕЛАРУСЬ BELARUS	017 2238290	عمان سلطنة OMAN	24703471	ITALIA ITALY	1 99 207 354	NORGE NORWAY	815 09 567
BELGIQUE BELGIE BELGIUM	070 23 31 59	POLSKA POLAND	801 300 420 koszt jak za połączenie lokalne	日本 JAPAN	0570-077772	SOUTH AFRICA	0100202222
BOSNA I HERCEGOVINA	Info-linija za potrošače 033 551 220	PORTUGAL	808 284 735	الاردن JORDAN	5665505	ESPAÑA SPAIN	902 31 24 00
BRASIL BRAZIL	11 2915-4400	قطر QATAR	44485555	ҚАЗАҚСТАН KAZAKHSTAN	727 378 39 39	SVERIGE SWEDEN	08 594 213 30
БЪЛГАРИЯ BULGARIA	0700 10 330	REPUBLIC OF IRELAND	01 677 4003	한국어 KOREA	1588-1588	SUISSE SCHWEIZ SWITZERLAND	044 837 18 40
CANADA	1-800-418-3325	ROMANIA	0 21 316 87 84	التوكيت KUWAIT	24831000	ประเทศไทย THAILAND	02 769 7477
CHILE	12300 209207	РОССИЯ RUSSIA	495 213 32 30	LATVIJA LATVIA	6 616 3403	TÜRKIYE TURKEY	444 40 50
COLOMBIA	018000520022	المملكة العربية المتحدة SAUDI ARABIA	920023701	لبنان LEBANON	4414727	المتحدة العربية الامارات UAE	8002272
HRVATSKA CROATIA	01 30 15 294	SRBIA SERBIA	060 0 732 000	LIETUVA LITHUANIA	5 214 0057	Україна UKRAINE	044 300 13 04
ČESKÁ REPUBLIKA CZECH REPUBLIC	731 010 111	SINGAPORE	6550 8900	LUXEMBOURG	0032 70 23 31 59	UNITED KINGDOM	0345 602 1454
DANMARK DENMARK	44 663 155	SLOVENSKA SLOVAKIA	232 199 930	МАКЕДОНИЈА MACEDONIA	(02) 20 50 319	U.S.A.	800-395-8325
VENEZUELA	0800-7268724						25/03/2015

Date of purchase: / Date d'achat / Fecha de compra / Data da compra / Data d'acquisto / Kaufdatum / Aankoopdatum / Käbsdato / Inköpsdatum / Kjøpsdato / Ostopáivä / Data zakupu / Data vānzāri / Įsigijimo data / Oustukaupjev / Datum nakupa / Sorozatárán / Dátum nákupu / Pirkuma datums / Datum Kupovine / Datum kupnje / Data cumprării / Datum nákuru / Tarikh pembelian / Tanggal pembelian / Ngày mua hàng / Satm ala taribi / Дата продажи / Дата на закупуване / Датум на купување / Satymja merzisi / Παιρoφήης ημερoς / Часопыт'я прoд'ажа / 購買日/購買日 / 購入日 / 購買日 / تاریخ خرید / تاريخ الشراء / 購買日

Product reference: / Référence du produit / Referencia del producto / Nome do produto / Tipo de prodotto / Турномер дес Герiтес / Artikelnummer van het apparaat / Referencenummer / Produktreferens / Artikkelnummer / Tuotenumero / referencia producto / Model / Gaminio numeris / Toote viitenumber / Tip aparat / Visiārās kelle / Тур vыгoрyкa / Produkta atsauces numurs / Model proizvoda / Označka proizvoda / Cod produs / Produkt rujukan / Referens produkt / Mã sản phām / Urin kodu / Модель / Модель / Model на уред / Модел / Кодово; проиштво / Урошћ / 產品編號 / 製品レファレンス番号 / 제품명 / مرجع كاتالوج / مرجع الكاتالوج / 產品名稱 / 產品名稱

Retailer name and address: / Nom et adresse du vendeur / Nombre y dirección del minorista / Nome e endereço do revendedor / Nome e indirizzo del negozio / Name und Anschrift des Händlers / Naam en adres van de dealer / Forhandler navn & adresse / Återförsäljarens namn och adress / Forhandler navn og adresse / Jälleenmyyjän nimi ja osoite / Nazwa i adres sprzedawcy / Numele și adresa vânzătorului / Pardotvoties pavadināms ir adresa / Mütiija kauplus ja address / Naziv in naslov trgovine / Tipusazám / Názov a adresa predajcu / Veikala nosaukums un adrese / Naziv i adresa maloprodaje / Naziv i adresa prodavca / Naziv i adresa prodajnog mjesta / Nome e adressa vânzător / Názve a adresa prodajce / Nama dan alamat peruncit / Nama Toko Penjual dan alamat / Тiн вiдiа чiа сiна хiнг бiн / Satıcı firmam adı ve adresi / Название и адрес продавца / Назва i adresa prodavcu / Търговия обект / Назив и адреса на продавницата / Сагушоныяг аты жөнө мекен-айылы / Επισημύξη και διεύθυνση καταστήματος / Чiа сагушоныяг и сагушоныяг и сагушоныяг / 零售商店的名称和地址/販売店の名前、住所/소매점 이름과 주소 / اسم البيع المتجر و / عنوانه / 地址和名称 / 零售商店的名称和地址/販売店の名前、住所/소매점 이름과 주소 / اسم البيع المتجر و / عنوانه / 地址和名称

Distributor stamp / Cachet distributeur / Sello del distribuidor / Carimbo do revendedor / Timbro del negozio / Händlerstempel / Stempel van de dealer / Forhandler stempel / Återförsäljarens stämpel / Forhandler stempel / Jälleenmyyjän leima / Pieczęć sprzedawcy / Štampila prodavca / Antspaudas / Tempel / Žig trgovine / Eladó neve, címje / Razliko predajcu / Tímogs / Pečat maloprodajce / Pečat prodavca / Pečat prodajnog mjesta / Štampila vânzătorului / Razliko prodajce / Cap peruncici / Cap dari Toko Penjual / Čta hāng bān dōng dōu / Satıcı Firmam Kaşesi / Pečat prodavca / Pečatka prodavca / Pečat na trgovinska objek / Pečat na prodavnica / Сагушоныяг мөри / Σαгушоныяг καταστήματος; / Чiа сагушоныяг и сагушоныяг / 零售商店的蓋印 / 販売店印/소매점 직인 / مهر خرد فروش / 零售商店的名称和地址/販売店の名前、住所/소매점 이름과 주소 / اسم البيع المتجر و / عنوانه / 地址和名称

NC00131951