

FR

EN

DE

NL

IT

ES

PT

EL

AR

FA

ZH

MS

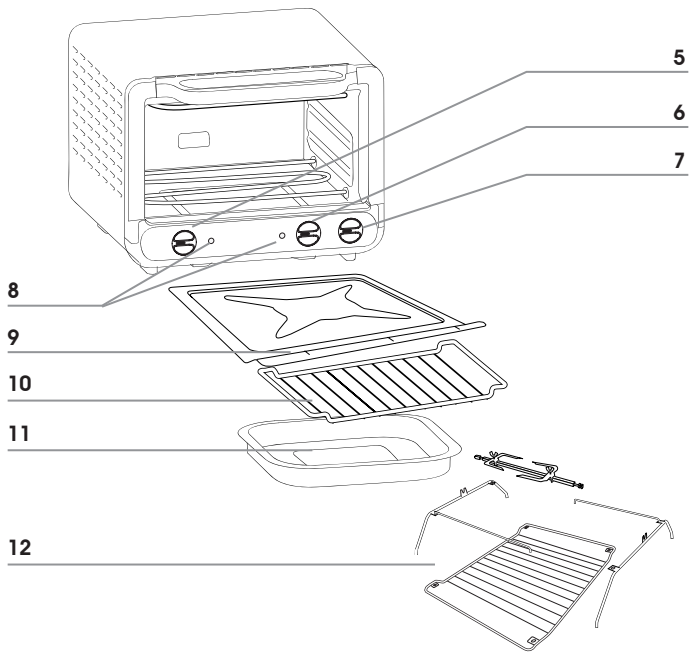
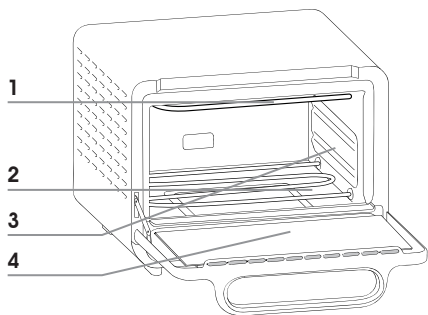

DESCRIPTION

1. Résistance supérieure
2. Résistance inférieure
3. Parois non stick
4. Porte double parois
5. Bouton des fonctions
6. Bouton de réglage température
7. Bouton de minuterie
8. Voyants de fonctionnement
9. Sole ramasse miettes
10. Grille réversible
11. Plat non adhésif
12. Kit tournebroche (1 grille, 2 fourches, 2 supports broche, 1 tige, 1 plat)

DESCRIPTION

1. Top heating element
2. Bottom heating element
3. Non-stick walls
4. Double-wall door
5. Function buttons
6. Temperature control button
7. Timer button
8. Power indicator lights
9. Crumb tray
10. Reversible shelf
11. Non-stick oven tray
12. Rotisserie kit (1 grill, 2 forks, 2 meat holders, 1 spit rod, 1 plate)

BESCHREIBUNG

1. Oberes Heizelement
2. Unteres Heizelement
3. Antihaffbeschichtete Wände
4. Doppelwandige Tür
5. Funktionsknöpfe
6. Temperaturregler
7. Timer-Knopf
8. Betriebsleuchten
9. Krümelblech
10. Umkehrbarer Rost
11. Antihaffbeschichtete Backform
12. Drehspieß-Set (1 Rost, 2 Gabeln, 2 Spießhalterungen, 1 Spieß, 1 Schale)

BESCHRIJVING

1. Bovenste verwarmingselement
2. Onderste verwarmingselement
3. Anti-aanbakwanden
4. Dubbelwandige deur
5. Functieknoppen
6. Temperatuurregelknop
7. Timerknop
8. Aan/uit-controlelampjes
9. Kruimellade
10. Omkeerbaar rooster
11. Anti-aanbakovenschaal
12. Draaispitset (1 rooster, 2 vorken, 2 spithouders, 1 stang, 1 schaal)

DESCRIPCIÓN

1. Resistencia superior
2. Resistencia inferior
3. Paredes antiadherentes
4. Puerta de doble cristal
5. Botones de funciones
6. Botón de ajuste de temperatura
7. Botón de temporizador
8. Pilotos de funcionamiento
9. Bandeja recogemigas
10. Rejilla reversible
11. Fuente antiadherente
12. Kit de asador (1 rejilla, 2 tenedores, 2 soportes para brocheta, 1 varilla, 1 fuente)

DESCRIPTION

1. Resistência superior
2. Resistência inferior
3. Paredes antiaderentes
4. Porta de parede dupla
5. Botões das funções
6. Botão de regulação da temperatura
7. Botão temporizador
8. Indicadores de funcionamento
9. Bandeja para migalhas
10. Grelha reversível
11. Prato não aderente
12. Kit espeto rotativo (1 grelha, 2 forquilhas, 2 suportes para espeto, 1 haste, 1 prato)

DESCRIZIONE

1. Resistenza superiore
2. Resistenza inferiore
3. Pareti anti-adesive
4. Sportello a parete doppia
5. Pulsanti delle funzioni
6. Manopola di regolazione della temperatura
7. Manopola del timer
8. Spie di funzionamento
9. Fondo raccogli-briciole
10. Griglia reversibile
11. Piatto non adesivo
12. Kit girarrosto (1 griglia, 2 forcelle, 2 supporti per spiedo, 1 asta, 1 piatto)

الوصف

1. مقاومة أعلى
2. مقاومة أدنى
3. جدار غير لاصق
4. باب بجدار مزدوج
5. زر التشغيل
6. زر تعديل الحرارة
7. زر التوقيت
8. أضواء التشغيل
9. أرضية لجمع الفتات
10. شواية تعمل بالاتجاهين
11. طبق مقاوم لللصق
12. عدة الشواية (1 قلاية, 2 شوكة, 2 دعامة لسيخ الشواء, 1 ذراع, 1 طبق

περιγραφή

1. Αντίσταση στο επάνω μέρος
2. Αντίσταση στο κάτω μέρος
3. Αντικολλητικοί τοίχοι
4. Διπλής αντοχής πόρτα
5. Κουμπιά λειτουργιών
6. Κουμπιά θερμοκρασίας
7. Χρονόμετρο
8. Φωτεινή ένδειξη λειτουργίας
9. Ψυχολοσουλέκτης
10. Ράφι διπλής όψης
11. Αντικολλητικός δίσκος
12. Kit περιστρεφόμενης σούβλας (1 εσχάρα, 2 διχάλες, 2 στηρίγματα σούβλας, 1 σούβλα, 1 ταψί)

- شرح
1. استحکام عالی
 2. مقاومت کمتر
 3. دیواره نجسب
 4. دیواره دو جداره
 5. دکمه انتخاب عملکردها
 6. دکمه تنظیم دما
 7. دکمه زمان سنج
 8. نشانگرهای عملکرد
 9. دارای اشغال جمع کن
 10. توری برگشت پذير
 11. سطح نجسب
 12. کیت کباب/پريان کردن (1 عدد توری, 2 عدد چنگال, 2 عدد گيره نگهدارنده, 1 عدد ميله گردان, 1 عدد بشقاب

說明

1. 頂部加熱元件
2. 底部加熱元件
3. 不沾壁
4. 雙層門
5. 功能按鈕
6. 溫度控制鈕
7. 計時按鈕
8. 電源指示燈
9. 麵包屑盤
10. 翻轉式層架
11. 不沾爐盤
12. 烤肉用具 (1 個烤架, 2 支烤肉叉, 2 個烤肉固定架, 1 支烤肉夾棍, 1 個烤盤)

PENERANGAN

1. Elemen pemanas atas
2. Elemen pemanas bawah
3. Dinding tak melekat
4. Pintu dinding berganda
5. Butang fungsi
6. Butang kawalan suhu
7. Butang pemasa
8. Cahaya penunjuk kuasa
9. Dulang serdak
10. Rak boleh terbalikkan
11. Dulang ketuهار tak melekat
12. Rotisserie kit (1 gril, 2 garpu, 2 pemegang daging, 1 batang bercabang, 1 pinggan)

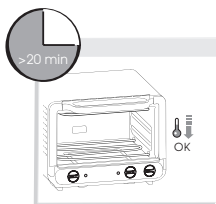
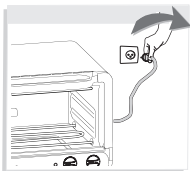
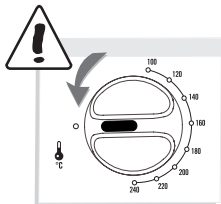
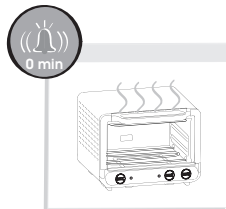
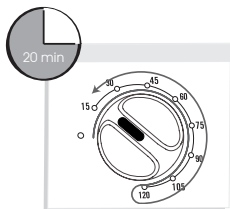
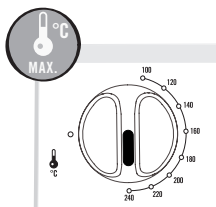
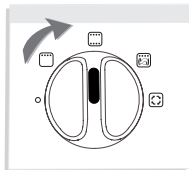
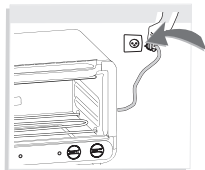
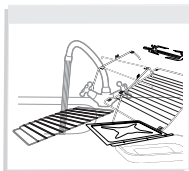
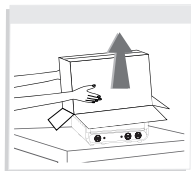
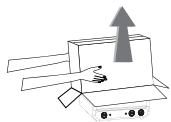

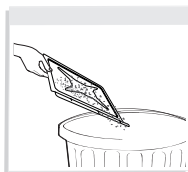
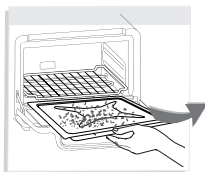

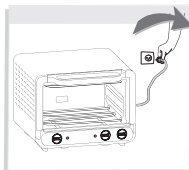
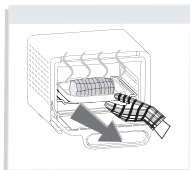
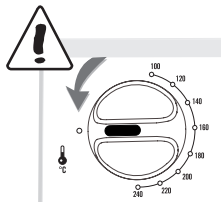
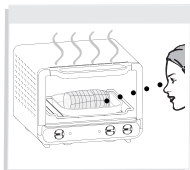
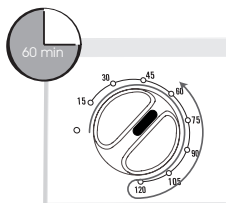
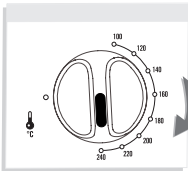
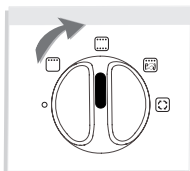
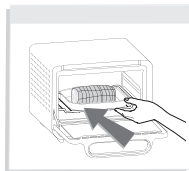
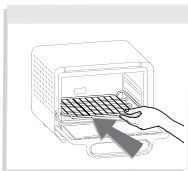
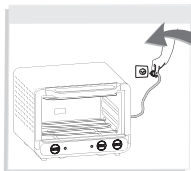

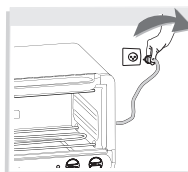
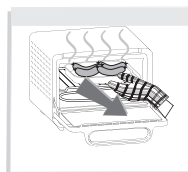
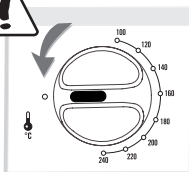
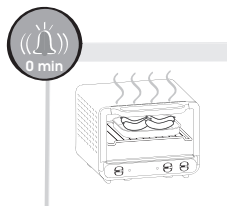
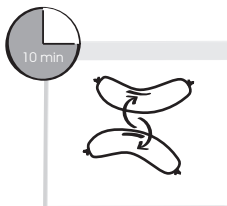
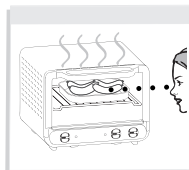
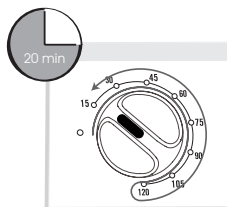
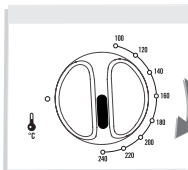
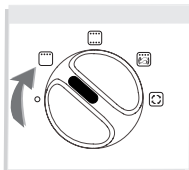
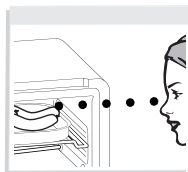
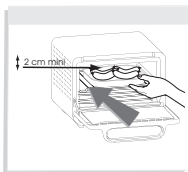
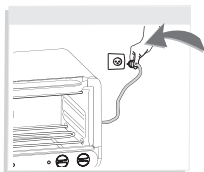

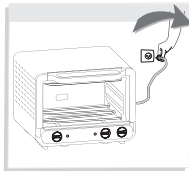
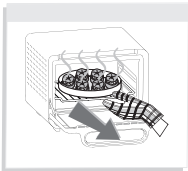
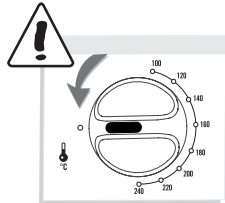
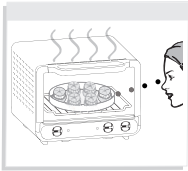
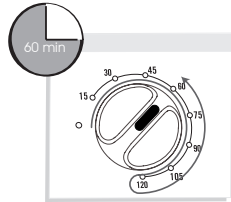
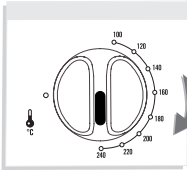
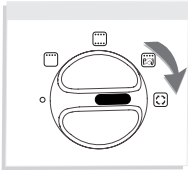
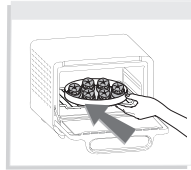
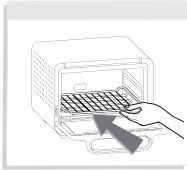
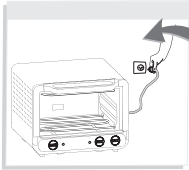

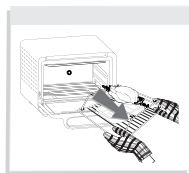
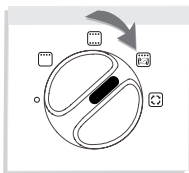
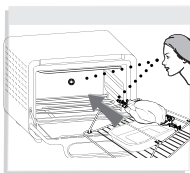
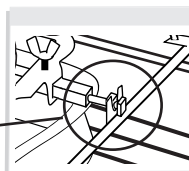
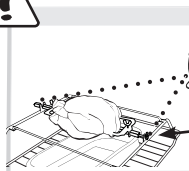
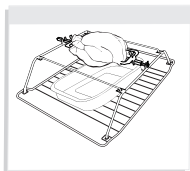
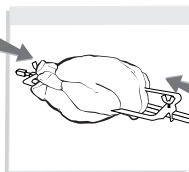
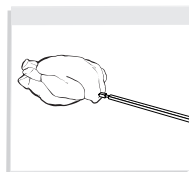
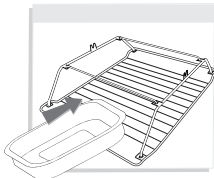
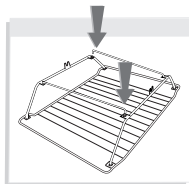
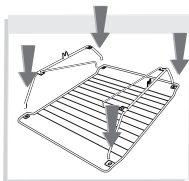
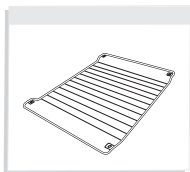

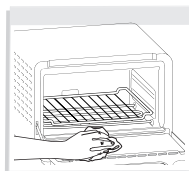
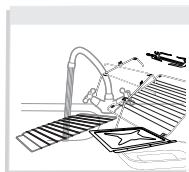
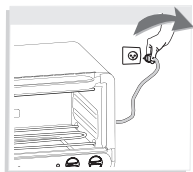





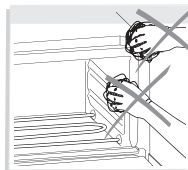
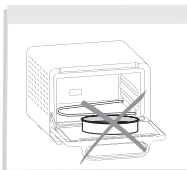
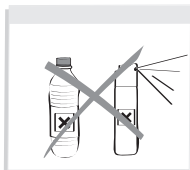
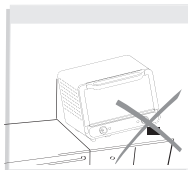
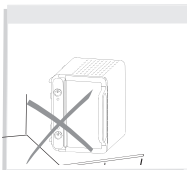
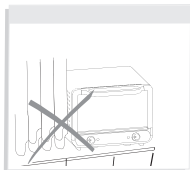
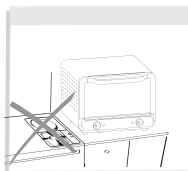
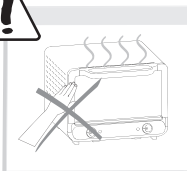
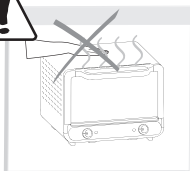
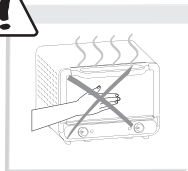
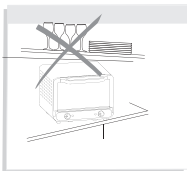
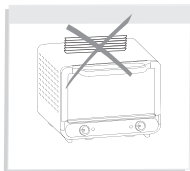

				Préchauffage Preheat	
			°C		min.
		4	240	10 min	20 min
 1,5 kg		3	220	-	70 min
		-	-	-	80 min
 750 g		4	240	10 min	20 min
 1 kg		5	240	-	80 min
 x 4		8	-	10 min	16 + 6 min
 x 9		8	-	5 min	12 + 8 min
		4	240	-	28 min
		2	240	5 min	55 min
		3	220	10 min	25 min
		4	240	-	30 min
		3	180	10 min	50 min
		4	180	10 min	25 min



			
ALGERIA	GRUPE SEB EXPORT Chemin du Petit Bois, Les 4M 69130 ECULLY - FRANCE	213-41 28 18 53	1 year
ARGENTINA	GRUPE SEB ARGENTINA S.A. Billinghurst 1833 3° C1425DJK Capital Federal Buenos Aires	0800-122-2732	2 años
ՀԱՅԱՍՏԱՆ ARMENIA	«Գրուպա ՄԵԲ-Կոստոյ»ՓԲԸ, 119180 Մոսկվա, Ռուսաստան Ստարոմոնետնի քրք., տ. 14, շ. 2	(010) 55-76-07	2 տարի/ years
AUSTRALIA	GRUPE SEB AUSTRALIA PO Box 7535, Silverwater NSW 2128	02 97487944	1 year
ÖSTERREICH	SEB ÖSTERREICH HmbH Campus 21 - Businesspark Wien Süd Liebermannstr. A02 702 2345 Brunn am Gebirge	01 866 70 299 00	2 Jahre
BELGIQUE / BELGIE	GRUPE SEB BELGIUM SA NV 25 avenue de l'Espérance - ZI 6220 Fleurus	32 70 23 31 59	2 ans / years
БЕЛАРУСЬ / BELARUS	ЗАО «Група СЕБ-Восток», 119180 Москва, Россия Старомонетный пер. д. 14 стр.2	017 2239290	2 года/ years
BOSNA I HERCEGOVINA	SEB Développement Predstavništvo u BiH Vrazova 8/II 71000 Sarajevo	Info-linija za potrošače 033 551 220	2 godine
BRASIL	GRUPO SEB DO BRASIL PRODUTOS DOMESTICOS LTDA Avenida Arno, 146 Mooca 03108-900 São Paulo SP	0800-119933	1 ano
БЪЛГАРИЯ/ BULGARIA	ГРУП СЕБ БЪЛГАРИЯ ЕООД Ул. Борово 52 Г., ет. 1, офис 1, 1680 София	0700 10 330	2 ГОДИНИ
CANADA	GRUPE SEB CANADA 345 Passmore Avenue Toronto, ON M1V 3N8	1-800-418-3325	1 year
CHILE	GRUPE SEB CHILE Comercial Ltda Avda. Nueva Los Leones 0252 Providencia, Santiago	+56 2 232 77 22	2 años
COLOMBIA	GRUPE SEB COLOMBIA Apartado Aereo 172, Kilometro 1 Via Zipaquirá Cajica Cundinamarca	18000919288	2 años
HRVATSKA Croatia	SEB Développement S.A.S. Vodnjanska 26 10000 Zagreb	01 30 15 294	2 godine
ČESKÁ REPUBLIK / CZECH REPUBLIC	GRUPE SEB ČR spol. s r. o. Jankovcova 1569/2c 170 00 Praha 7	731 010 111	2 roky
DANMARK	GRUPE SEB NORDIC AS Tempovej 27 2750 Ballerup	44 663 155	2 år
DEUTSCHLAND	GRUPE SEB DEUTSCHLAND GmbH / KRUPS GmbH Herrnrainweg 5 63067 Offenbach	0212 387 400	2 Jahre

			
EESTI/ ESTONIA	GRUPE SEB POLSKA SP Z O.O. ul. Ostrobramska 79 04-175 Warszawa	5 800 3777	2 aastat
SUOMI / FINLAND	Groupe SEB Finland Kutojantie 7 02630 Espoo	09 622 94 20	2 Vuotta
FRANCE Inclus Martinique, Guadeloupe, Réunion & St. Martin	GRUPE SEB France SAS Place Ambroise Courtois 69355 Lyon Cedex 08	09 74 50 47 74	1 an
GREECE / ΕΛΛΑΔΑ	SEB GROUPE ΕΛΛΑΔΟΣ Α.Ε. Οδός Φραγκοκκλησιάς 7 Τ.Κ. 151 25 Παρόδιος Αμαρουσίου	2106371251	2 χρόνια
HONG KONG	SEB ASIA Ltd. Room 901, 9/F, North Block, Skyway House 3 Sham Mong Road, Tai Kok Tsui, Kowloon	852 8130 8998	1 year
MAGYARORSZAG/ Hungary	GRUPE SEB CENTRAL-EUROPE Kft. Tavíro köz 4 2040 Budaörs	(1) 8018434	2 év
INDONESIA	Groupe SEB Indonesia (Representative office) Sudirman Plaza, Plaza Marein 8th Floor JL Jendral Sudirman Kav 76-78, Jakarta 12910, Indonesia	+62 21 5793 6881	1 year
ITALIA	GRUPE SEB ITALIA S.p.A. Via Montefeltro, 4 20156 Milano	199207354	2 anni
JAPAN	GRUPE SEB JAPAN Co. Ltd. 1F Takanawa Muse Building, 3-14-13, Higashi Gotanda, Shinagawa-Ku, Tokyo 141-0022	0570-077772	1 year
ҚАЗАҚСТАН KAZAKHSTAN	«Группа СЕБ-Восток» ЖАҚ, 119180 Мәскеу, Ресей Старомонетный тұйық көш, 14-үй, 2-құрылыс	727 378 39 39	2 жыл / years
KOREA	(유)그룹 세브 코리아 서울시 종로구 서린동 88 서린빌딩 3층 110-790	1588-1588	1 year
LATVJA / LATVIA	GRUPE SEB POLSKA SP Z O.O. ul. Ostrobramska 79 04-175 Warszawa	6 716 2007	2 gadi
LIETUVA/ LITHUANIA	GRUPE SEB POLSKA SP Z O.O. ul. Ostrobramska 79 04-175 Warszawa	6 470 8888	2 metai
MACEDONIA	Groupe SEB Bulgaria EOOD Office 1, floor 1, 52G Borovo St., 1680 Sofia - Bulgaria ГРУП СЕБ БЪЛГАРИЯ ДООЕЛ Ул. Борово 52 Г, сл. 1, офис 1, 1680 София, България	(0)2 20 50 022	2 години / years
MALAYSIA	GRUPE SEB MALAYSIA SDN. BHD Lot No.C/3A/001 & 002, Block C, Kelana Sq. No.17, Jalan SS7/26, 47301 Kelana Jaya Petaling Jaya, Selangor	65 6550 8900	1 year
MEXICO	G.S.E.B. MEXICANA, S.A. de C.V. Goldsmith 38 Desp. 401, Col. Polanco Delegacion Miguel Hildalgo 11 560 Mexico D.F.	(01800) 112 8325	1 años

			
MOLDOVA	ТОВ «Група СЕБ Україна» Вул. Драгоманова 31 Б, офіс 1 02068 Київ, Україна	(22) 929249	2 ani / years
NEDERLAND	GROUPE SEB NEDERLAND BV Generatorstraat 6 3903 LJ Veenedaal	0318 58 24 24	2 jaar
NEW ZEALAND	GROUPE SEB NEW ZEALAND Unit E, Building 3, 195 Main Highway, Ellerslie, Auckland	0800 700 711	1 year
NORGE	GROUPE SEB NORDIC AS Tempovej 27 2750 Ballerup_DANMARK	815 09 567	2 år
PERU	GROUPE SEB COLOMBIA Av. Camino Real N° 111 of. 805 B San Isidro - Lima - Perú	+511 441 4455	1 años
POLSKA/ POLAND	GROUPE SEB POLSKA SP Z O.O. ul. Ostrobramska 79 04-175 Warszawa	0801 300 422 koszt jak za połączenie lokalne	2 lata
PORTUGAL	GROUPE SEB IBÉRICA SA Urb. da Matinha Rua Projectada à Rua 3 Bloco1 - 3ª B/D 1900 - 796 Lisboa	808 284 735	2 anos
REPUBLIC OF IRELAND	GROUPE SEB IRELAND Unit B3 Aerodrome Business Park, College Road, Rathcoole, Co. Dublin	01 677 4003	1 year
ROMÂNIA/ ROMANIA	GROUPE SEB ROMÂNIA Str. Daniel Constantin nr. 8 010632 București	0 21 316 87 84	2 ani
РОССИЯ/ RUSSIA	ЗАО «Группа СЕБ-Восток», 119180 Москва, Россия Старомонетный пер. д. 14 стр.2	495 213 32 37	2 года/ years
SRBIJA Serbia	SEB Developpement Antifasisticke borbe 17/13 11070 Novi Beograd	060 0 732 000	2 godine
SINGAPORE	GROUPE SEB SINGAPORE Pty Ltd. 59 Jalan Pemimpin, #04-01/02 L&Y Building Singapore 577218	65 6550 8900	1 year
SLOVENSKO/ SLOVAKIA	GROUPE SEB SLOVENSKO s.r.o. Rybničná 40 831 07 Bratislava	233 595 224	2 roky
SLOVENIJA	SEB d.o.o Gregorčičeva ulica 6 2000 MARIBOR	02 234 94 90	2 leti
ESPAÑA	GROUPE SEB IBÉRICA S.A. Almogàvers, 119-123, Complejo Ecourban 08018 Barcelona	0902 31 25 00	2 años
SVERIGE	TEFAL SVERIGE SUBSIDIARY OF GROUP SEB NORDIC Truckvägen 14 A, 194 52 Upplands Väsby	08 594 213 30	2 år
SUISSE SCHWEIZ	GROUPE SEB SCHWEIZ GmbH Thurgauerstrasse 105 8152 Glattbrugg	044 837 18 40	2 ans / Jahrre
TAIWAN	SEB ASIA Ltd. Taipei International Building, Suite B2, 6F-1, No. 216, Tun Hwa South Road, Sec. 2 Da-an District Taipei 106, R.O.C.	886-2-27333716	1 year

			
THAILAND	GROUPE SEB THAILAND 2034/66 Italthai Tower, 14th Floor, n° 14-02, New Phetchburi Road, Bangkapi, Huaykwang, Bangkok, 10320	02723 4488	2 years
TÜRKIYE	GROUPE SEB ISTANBUL AS Beybi Giz Plaza Dereboyu Cad. Meydan Sok. No: 28 K.12 Maslak	216 444 40 50	2 YIL.
U.S.A.	GROUPE SEB USA 2121 Eden Road Millville, NJ 08332	800-769-3682	1 year
Україна/ UKRAINE	ТОВ «Груп СЕБ Україна» Вул. Драгоманова 31 Б, офіс 1 02068 Київ, Україна	044 492 06 59	2 роки/ years
UNITED KINGDOM	GROUPE SEB UK Ltd. 11-49 Station Road Langley, Slough Berkshire SL3 8 DR	0845 602 1454	1 year
VENEZUELA	GROUPE SEB VENEZUELA Av Eugenio Mendoza, Centro Letonia, Torre ING Bank, Piso 15, Ofc 155 Urb. La Castellana, Caracas	0800-7268724	2 anno
VIETNAM	GROUPE SEB VIETNAM (Representative office) 127-129 Nguyen Hue Street District 1, Ho Chi Minh City, Vietnam	+84-8 3821 6395	1 year

INTERNATIONAL GUARANTEE

Date of purchase: / Date d'achat / Fecha de compra /
Data da compra / Data d'acquisto / Kaufdatum / Aankoopdatum / Købsdato / Inkøpsdatum /
Kjøpsdato / Ostoppåvä / Data zakupu / Data vânzării / Ísigijimo data/ Ostukuupäev / Datum nakupa /
Sorozatszám / Dátum nákupu / Pirkuma datums / Datum Kupovine / Datum kupnje / Data
cumpărării / Datum nákupu / Tarikh pembelian / Tanggal pembelian / Ngày mua hàng/ Satın alma
tarihi / Дата продажи / Дата продажу / Дата на закупуване / Датум на купување / Сатылган
мерзімі / Ημερομηνία αγοράς / Чыданыш орн / วันที่ซื้อ / 購買日期/購入日/구입일자 / تاريخ
خريد/ تاريخ الشراء

Product reference: / Référence du produit / Referencia del
producto / Nome do produto / tipo de prodotto / Typnummer des Gerätes / Artikelnummer van het
apparaat / Referencenummer / Produktreferens / Artikelnummer / Tuotenumero / referencia
produktu / Model / Gaminio numeris / Toote viitenumber / Tip aparata / Vásárlás kelte / Typ
výrobku / Produkta atsauces numurs / Model proizvoda / Oznaka proizvoda / Cod produs / Produk
rūjūkan / Referenssi tuote / Mã sản phẩm/ Ürün kodu / Модель / Модел на уреда /
Модели / Κωδικός προϊόντος / Уηηηη / รุ่นผลิตภัณฑ์ / 產品模型 / 製品レファレンス番号 / 제품명 /
مرجع المنتج الكامل / مرجع كامل محصول

Retailer name & address:
/ Nom et adresse du vendeur / Nombre y dirección del minorista / Nome e endereço do revendedor
/ Nome e indirizzo delnegozio / Name und Anschrift des Händlers / Naam en adres van de dealer /
Forhandler navn & adresse / Återförsäljarens namn och adress / Forhandler navn og adresse /
Jälleenmyyjän nimi ja osoite / nazwa i adres sprzedawcy / Numele și adresa vânzătorului /
Parduotuvės pavadinimas ir adresas / Mütija kauplus ja address / Naziv in naslov trgovine /
Tipusszám / Názov a adresa predajcu / Veikala nosaukums un adrese / Naziv i adresa malprodaje /
Naziv i adresa prodavca / Naziv i adresa prodajnog mjesta / Nume și adresă vânzător / Název a
adresa prodejece / Nama dan alamat peruncit / Nama Toko Penjual dan alamat / Tên và địa chỉ cửa
hàng bán/ Satici firmanın adı ve adresi / Название и адрес продавца / Назва і адреса продавця /
Търговки обект / Назив и адреса на продавницата / Сатушының аты жөне мекен-жайы /
Επωνυμία και διεύθυνση καταστήματος / Чыданыш һәм үлпүлүнүрлүк һуугуһу /
ชื่อและที่อยู่ของห้าง/ร้านที่ซื้อ / 零售商的店名和地址 / 販売店の名前、住所 / 소매점 이름과 주소 /
نام و آدرس خرده فروش / اسم بائع التجزئة و عنوانه

Distributor stamp / Cachet distributeur / Sello del distribuidor /
Carimbo do revendedor / Timbro del negozio / Händlerstempel / Stempel van de dealer /
Forhandler stempel / Återförsäljarens stämpel / Forhandler stempel / Jälleenmyyjän leima / pieczęć
sprzedawcy / Ştampila vânzătorului / Antspaudas / Tempel / Žig trgovine / Eladó neve, címe/
Razitko predajcu / Zimogs / Pečat malprodaje/ Pečat prodavca / Pečat prodajnog mjesta / Ştampila
vânzătorului/ Razitko prodejece/ Cap peruncit / Cap dari Toko Penjual / Cửa hàng bán đồng dấu/
Satici Firmanın Kaşesi / Печать продавца / Печатка продавца / Печат на търговския обект /
Печат на продавницата / Сатушының мөрі / Σφραγίδα καταστήματος / Чыданыш һәм үлпүлүнүрлүк /
ตราประทับของห้าง/ร้านที่ซื้อ / 零售商的蓋印 / 販売店印 / 소매점 직인 / التجزئة/مهر خرده

فروش

Réf : NC00117666



création **BATOTEAM** : www.batoteam.fr