

**Operator's manual**

**536LiHE3**

Please read the operator's manual carefully and make sure you understand the instructions  
before using the machine.

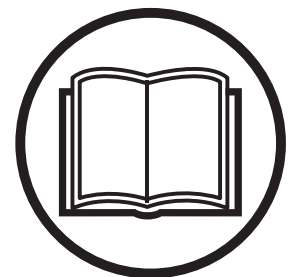

**English**

# KEY TO SYMBOLS

## Symbols on the machine:

Translation of the original Swedish operating instruction.

**WARNING!** Incorrect or careless use of a hedge trimmer can turn it into a dangerous tool that can cause serious or even fatal injury. It is extremely important that you read and understand the contents of this operator's manual.

Please read the operator's manual carefully and make sure you understand the instructions before using the machine.

Always wear:

- A protective helmet where there is a risk of falling objects
- Approved hearing protection
- Approved eye protection

Always wear approved protective gloves.

Wear sturdy, non-slip boots.

This product is in accordance with applicable EC directives.

Symbols on the product or its packaging indicate that this product cannot be handled as domestic waste. It must instead be submitted to an appropriate recycling station for the recovery of electrical and electronic equipment. (Applies to Europe only)

Direct current.

This machine is not electrically insulated. If the machine touches or comes close to high-voltage power lines it could lead to death or serious bodily injury. Electricity can jump from one point to another by arcing. The higher the voltage, the greater the distance electricity can jump. Electricity can also travel through branches and other objects, especially if they are wet. Always keep a distance of at least 10 m between the machine and high-voltage power lines and/or any objects that are touching them. If have to work within this safe distance you should always contact the relevant power company to make sure the power is switched off before you start work.

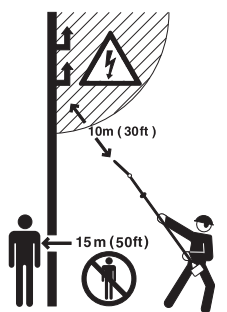

Cutting unit operating cycle, run time/ idle time



Max 40/10 sec



## Symbols on the battery and/or on the battery charger:

Please read the operator's manual carefully and make sure you understand the instructions before using the machine.

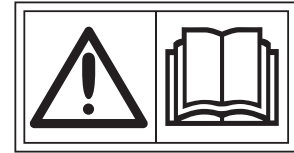

This product must be deposited at an appropriate recycling facility. (Applies to Europe only)

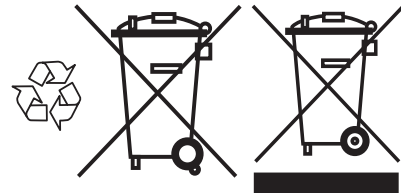

Fail-safe transformer



Use and store battery charger only indoors.



Double insulation

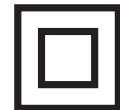

**Other symbols/decals on the machine refer to special certification requirements for certain markets.**

## Symbols in the operator's manual:

The machine is turned on and off by pressing the on and stop button.

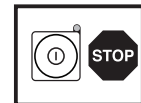

Always wear approved protective gloves.



Remove the battery. **IMPORTANT!** Always remove the battery to prevent the machine being started by accident.

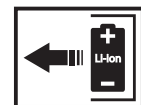

# CONTENTS

## Contents

### KEY TO SYMBOLS

Symbols on the machine: .....	2
Symbols on the battery and/or on the battery charger: .....	2
Symbols in the operator's manual: .....	2

### CONTENTS

Contents .....	3
Note the following before starting: .....	3

### INTRODUCTION

Dear Customer, .....	4
----------------------	---

### WHAT IS WHAT?

What is what? .....	5
---------------------	---

### GENERAL SAFETY PRECAUTIONS

General power tool safety warnings .....	6
Personal protective equipment .....	8
Battery and battery charger .....	8
Machine's safety equipment .....	9

### BATTERY HANDLING

Battery .....	12
Battery charger .....	12
Transport and storage .....	13
Disposal of the battery, battery charger and machine .....	13

### STARTING AND STOPPING

Check before starting .....	14
Connect battery to the machine .....	14
Starting and stopping .....	14

### WORKING TECHNIQUES

General working instructions .....	15
------------------------------------	----

### MAINTENANCE

Inspection and maintenance .....	18
Cleaning and lubrication .....	18
Troubleshooting schedule .....	19
Maintenance schedule .....	20

### TECHNICAL DATA

Technical data .....	21
EC Declaration of Conformity .....	22

## Note the following before starting:

Please read the operator's manual carefully.



**WARNING! Long-term exposure to noise can result in permanent hearing impairment. So always use approved hearing protection.**



**WARNING! Under no circumstances may the design of the machine be modified without the permission of the manufacturer. Always use original accessories. Non-authorized modifications and/or accessories can result in serious personal injury or the death of the operator or others.**



**WARNING! Incorrect or careless use of a hedge trimmer can turn it into a dangerous tool that can cause serious or even fatal injury. It is extremely important that you read and understand the contents of this operator's manual.**

---

# INTRODUCTION

---

## Dear Customer,

Congratulations on your choice to buy a Husqvarna product! Husqvarna is based on a tradition that dates back to 1689, when the Swedish King Karl XI ordered the construction of a factory on the banks of the Husqvarna River, for production of muskets. The location was logical, since water power was harnessed from the Huskvarna River to create the water-powered plant. During the more than 300 years in existence, the Husqvarna factory has produced a lot of different products, from wood stoves to modern kitchen appliances, sewing machines, bicycles, motorcycles etc. In 1956, the first motor driven lawn mowers appeared, followed by chain saws in 1959, and it is within this area Husqvarna is working today.

Today Husqvarna is one of the leading manufacturers in the world of forest and garden products, with quality as our highest priority. The business concept is to develop, manufacture and market motor-driven products for forestry and gardening, as well as for the building and construction industry. Husqvarna's aim is also to be at the front edge for ergonomics, usability, security and environmental protection. That is the reason why we have developed many different features to add to our products within these areas.

We are convinced that you will appreciate with great satisfaction the quality and performance of our product for a very long time to come. The purchase of one of our products gives you access to professional help with repairs and service whenever this may be necessary. If the retailer who sells your machine is not one of our authorized dealers, ask for the address of your nearest service workshop.

It is our wish that you will be satisfied with your product and that it will be your companion for a long time. Think of this operator's manual as a valuable document. By following its content (usage, service, maintenance, etc), the life span and the second-hand value of the machine can be extended. If you sell this machine, make sure that the operator's manual is passed on to the buyer.

Thank you for using a Husqvarna product.

Husqvarna AB has a policy of continuous product development and therefore reserves the right to modify the design and appearance of products without prior notice.

# WHAT IS WHAT?

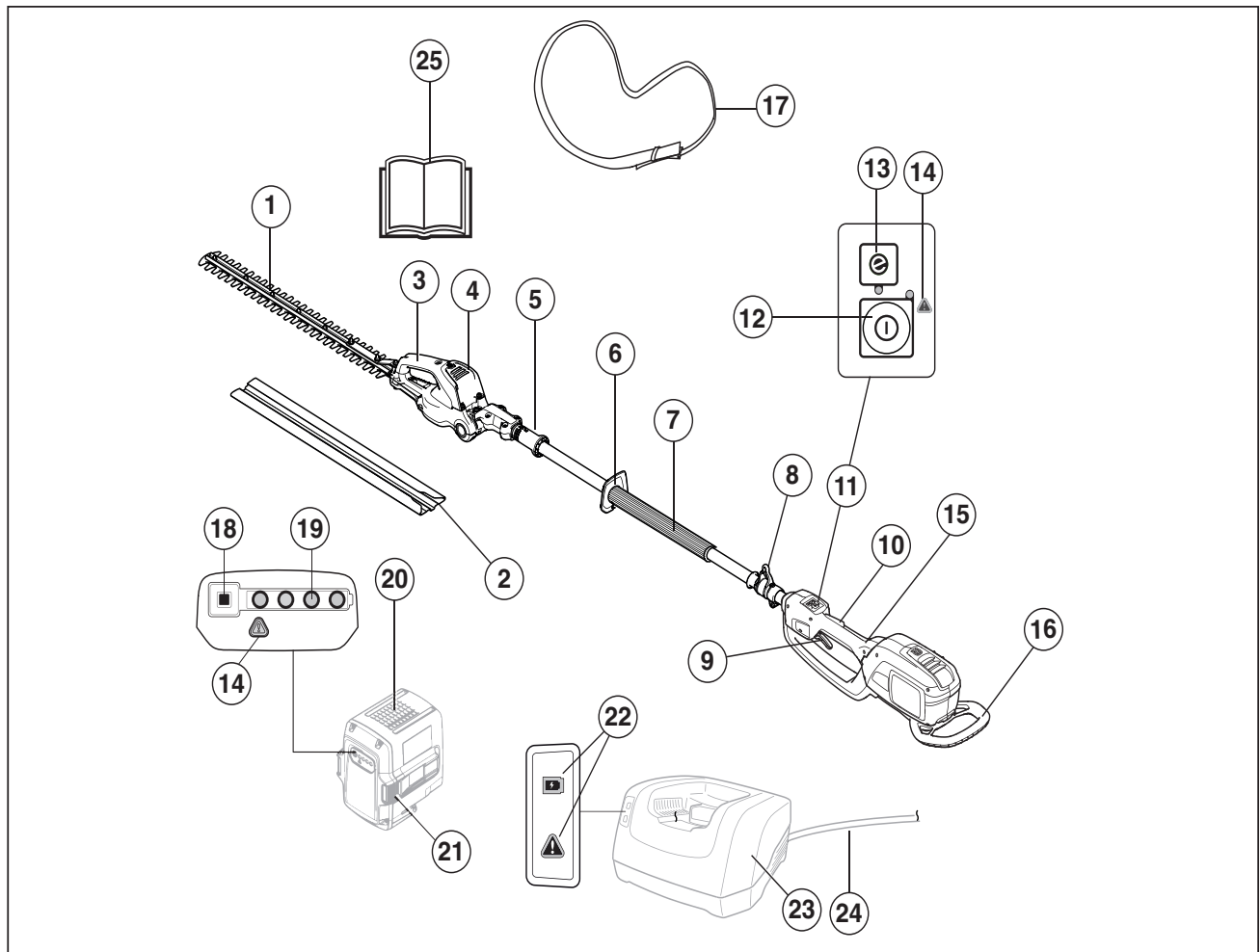

## What is what?

- |                                   |                                   |
|-----------------------------------|-----------------------------------|
| 1 Blade and blade guard           | 14 Warning indicator              |
| 2 Transport guard                 | 15 Rear handle                    |
| 3 Handle for tilt adjustment      | 16 Impact guard                   |
| 4 Tilting cutting head            | 17 Harness                        |
| 5 Lock for tilt adjustment        | 18 Battery indicator button       |
| 6 Hand guard                      | 19 Battery status                 |
| 7 Front handle                    | 20 Battery                        |
| 8 Harness support hook            | 21 Battery release buttons        |
| 9 Power trigger                   | 22 Power on and warning indicator |
| 10 Power trigger lockout          | 23 Battery charger                |
| 11 Control panel                  | 24 Cord                           |
| 12 Activate and deactivate button | 25 Operator's manual              |
| 13 SavE button                    |                                   |

# GENERAL SAFETY PRECAUTIONS

## General power tool safety warnings

Please read the operator's manual carefully and make sure you understand the instructions before using the machine.

The machine is only designed for cutting branches and twigs.

Always remove the battery to prevent the machine being started by accident.



**WARNING! Read all safety warnings and all instructions. Failure to follow the warnings and instructions may result in electric shock, fire and/or serious injury.**

### IMPORTANT!

Save all warnings and instructions for future reference. The term "power tool" in the warnings refers to your mains-operated (corded) power tool or battery-operated (cordless) power tool.

## Work area safety

- **Keep work area clean and well lit.** Cluttered or dark areas invite accidents.
- **Do not operate power tools in explosive atmospheres, such as in the presence of flammable liquids, gases or dust.** Power tools create sparks which may ignite the dust or fumes.
- **Keep children and bystanders away while operating a power tool.** Distractions can cause you to lose control.

## Personal safety

- **Stay alert, watch what you are doing and use common sense when operating a power tool. Do not use a power tool while you are tired or under the influence of drugs, alcohol or medication.** A moment of inattention while operating power tools may result in serious personal injury.
- **Use personal protective equipment. Always wear eye protection.** Protective equipment such as dust mask, non-skid safety shoes, hard hat, or hearing protection used for appropriate conditions will reduce personal injuries.
- **Prevent unintentional starting. Ensure the switch is in the OFF-position before connecting to a power source and/or battery pack, picking up or carrying the tool.** Carrying power tools with your finger on the switch or energising power tools that have the switch on invites accidents.
- **Remove any adjusting key or wrench before turning the power tool on.** A wrench or a key left attached to a rotating part of the power tool may result in personal injury.

- **Do not overreach. Keep proper footing and balance at all times.** This enables better control of the power tool in unexpected situations.
- **Dress properly. Do not wear loose clothing or jewellery. Keep your hair, clothing and gloves away from moving parts.** Loose clothes, jewellery or long hair can be caught in moving parts.
- **If devices are provided for the connection of dust extraction and collection facilities, ensure these are connected and properly used.** Use of dust collection can reduce dust-related hazards.

The vibration emission during actual use of the power tool can differ from the declared total value depending on the ways in which the tool is used. Operators should identify safety measures to protect themselves that are based on an estimation of exposure in the actual conditions of use (taking account of all parts of the operating cycle such as the times when the tool is switched off and when it is running idle in addition to the trigger).

## Power tool use and care

- **Do not force the power tool. Use the correct power tool for your application.** The correct power tool will do the job better and safer at the rate for which it was designed.
- **Do not use the power tool if the switch does not turn it on and off.** Any power tool that cannot be controlled with the switch is dangerous and must be repaired.
- **Disconnect the plug from the power source and/or the battery pack from the power tool before making any adjustments, changing accessories, or storing power tools.** Such preventive safety measures reduce the risk of starting the power tool accidentally.
- **Store idle power tools out of the reach of children and do not allow persons unfamiliar with the power tool or these instructions to operate the power tool.** Power tools are dangerous in the hands of untrained users.
- **Maintain power tools. Check for misalignment or binding of moving parts, breakage of parts and any other condition that may affect the power tool's operation. If damaged, have the power tool repaired before use.** Many accidents are caused by poorly maintained power tools.
- **Keep cutting tools sharp and clean.** Properly maintained cutting tools with sharp cutting edges are less likely to bind and are easier to control.
- **Use the power tool, accessories and tool bits etc. in accordance with these instructions, taking into account the working conditions and the work to be performed.** Use of the power tool for operations different from those intended could result in a hazardous situation.

# GENERAL SAFETY PRECAUTIONS

## Battery tool use and care

- **Recharge only with the charger specified by the manufacturer.** A charger that is suitable for one type of battery pack may create a risk of fire when used with another battery pack.
- **Use power tools only with specifically designated battery packs.** Use of any other battery packs may create a risk of injury and fire.
- **When battery pack is not in use, keep it away from other metal objects, like paper clips, coins, keys, nails, screws or other small metal objects, that can make a connection from one terminal to another.** Shorting the battery terminals together may cause burns or a fire.
- **Under abusive conditions, liquid may be ejected from the battery; avoid contact. If contact accidentally occurs, flush with water. If liquid contacts eyes, additionally seek medical help.** Liquid ejected from the battery may cause irritations or burns.

## Service

- **Have your power tool serviced by a qualified repair person using only identical replacement parts.** This will ensure that the safety of the power tool is maintained.

## Hedge trimmer safety warnings - Personal safety

- Use both hands when operating the hedgetrimmer. Using one hand could cause loss of control and result in serious personal injury.
- **Keep all parts of the body away from the cutter blade. Do not remove cut material or hold material to be cut when blades are moving. Make sure the switch is off when clearing jammed material. Blades coast after turn off.** A moment of inattention while operating the hedge trimmer may result in serious personal injury.
- **Carry the hedge trimmer by the handle with the cutter blade stopped. When transporting or storing the hedgetrimmer always fit the cutting device cover.** Proper handling of the hedge trimmer will reduce possible personal injury from the cutter blades.
- **Hold the power tool by insulated gripping surface only, because the cutter blade may contact hidden wiring.** Cutter blades contacting a "live" wire may make exposed metal parts of the power tool "live" and could give the operator an electric shock.
- **DANGER -Keep hands away from blade.** Contact with blade will result in serious personal injury.

### IMPORTANT!

Always remove the battery before any maintenance on the machine.

Children should be supervised to ensure that they do not play with the appliance.

Store the machine out of reach of children. Never allow children or other persons not trained in the use of the machine and/or the battery to use or service it. Local laws may regulate the age of the user.

Never use a machine that has been modified in any way from its original specification.

Wear personal protective equipment. See instructions under the "Personal protective equipment" heading.

The operator of the machine must ensure, while working, that no persons or animals come closer than 15 meters.

Never use the machine in bad weather, for instance in fog, in rain, strong winds, intense cold, etc. Extremely hot weather may cause overheating of the machine.

Never use a machine that is faulty. Carry out the safety checks, maintenance and service instructions described in this manual. Some maintenance and service measures must be carried out by trained and qualified specialists. See instructions under the Maintenance heading.

Carry out an overall inspection of the machine before use. See the maintenance schedule.



**WARNING! This machine produces an electromagnetic field during operation. This field may under some circumstances interfere with active or passive medical implants. To reduce the risk of serious or fatal injury, we recommend persons with medical implants to consult their physician and the medical implant manufacturer before operating this machine.**



**WARNING! Never allow children to use or be in the vicinity of the machine. Since the machine is easy to start, children may be able to start it if they are not kept under full surveillance. This can mean a risk of serious personal injury. Therefore disconnect the battery when the machine is not under close supervision.**



**WARNING! Faulty blades can increase the risk of accidents.**

# GENERAL SAFETY PRECAUTIONS

## Personal protective equipment

### IMPORTANT!

Incorrect or careless use of a hedge trimmer can turn it into a dangerous tool that can cause serious or even fatal injury. It is extremely important that you read and understand the contents of this operator's manual.

You must use approved personal protective equipment whenever you use the machine. Personal protective equipment cannot eliminate the risk of injury but it will reduce the degree of injury if an accident does happen. Ask your dealer for help in choosing the right equipment.



**WARNING! Listen out for warning signals or shouts when you are wearing hearing protection. Always remove your hearing protection as soon as the engine stops.**

### HEARING PROTECTION

Wear hearing protection that provides adequate noise reduction.



### EYE PROTECTION

Always wear approved eye protection. If you use a visor then you must also wear approved protective goggles. Approved protective goggles must comply with the ANSI Z87.1 standard in the USA or EN 166 in EU countries.

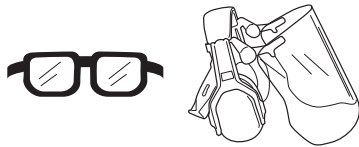

### GLOVES

Gloves should be worn when necessary, e.g. when fitting cutting attachments.

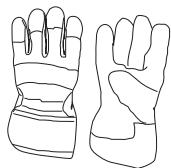

### BOOTS

Wear sturdy, non-slip boots or shoes.



### CLOTHING

Wear clothes made of a strong fabric and avoid loose clothing that can catch on twigs and branches. Always wear heavy, long pants. Do not wear jewellery, shorts sandals or go barefoot. Secure hair so it is above shoulder level.

### FIRST AID KIT

Always have a first aid kit nearby.



## Battery and battery charger

This section describes the battery and battery charger safety for your battery product.

Only use Husqvarna original batteries for Husqvarna products and only charge them in an original battery QC charger from Husqvarna. The batteries are software encrypted.

**Use only a Husqvarna original BLi battery in your machine.**

### Battery safety

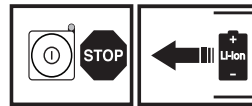

The rechargeable Husqvarna batteries, BLi, are exclusively used as a power supply for the relevant Husqvarna cordless appliances. To avoid injury, the battery must not be used as a power source for other devices.

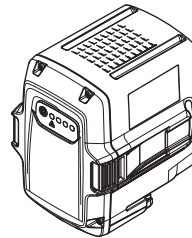

**WARNING! Protect the battery from direct sunlight, heat or open flame. There is a risk the battery may explode if it is thrown into an open fire. There is a risk of burns and/or chemical burns.**



**WARNING! Avoid all skin contact with battery acid. Battery acid may cause skin irritation, burns or corrosive injuries. If you get acid in your eyes, do not rub but flush your eyes with plenty of water for at least 15 minutes. See a doctor. You must wash any exposed skin with copious amounts of water and soap in case of incidental contact.**



# GENERAL SAFETY PRECAUTIONS



**WARNING! Never connect the battery terminals to keys, coins, screws or other metal as this may short-circuit the battery. Never insert objects into the battery's air vents.**

**Unused batteries must be kept away from metal objects such as nails, coins, jewellery. Do not try to disassemble or crush the battery**

- Use the battery in surroundings where temperatures are between -10 °C and 40 °C.
- Do not expose the battery to microwaves or high pressure.
- Never clean the battery or the battery charger with water. See instructions under the Maintenance heading.
- Store the battery out of reach of children.
- Protect the battery from rain and wet conditions.

## Battery charger safety

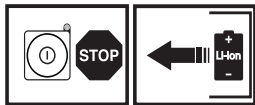

Only use Chargers, Husqvarna QC, for charging the Husqvarna replacement batteries, BLi.

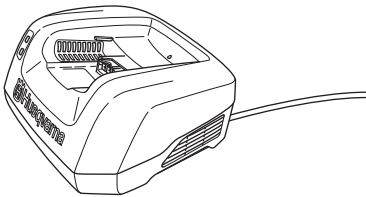

**WARNING! Minimise the risk of electric shock or short circuit as follows:**

**Never insert any object into the charger's cooling slots.**

**Do not try to dismantle the battery charger.**

**Never connect the charger terminals to metal objects.**

**Use approved and intact wall sockets.**



**WARNING! Do not use the battery charger close to corrosive or flammable materials. Do not cover the battery charger. Pull out the plug to the battery charger in the event of smoke or fire. Remember the risk of fire.**

- Regularly check that the battery charger connection wire is intact and that there are no cracks in it.
- Never carry the battery charger using the cord and never pull out the plug by pulling the cord.
- Keep all cables and extension leads away from water, oil and sharp edges. Make sure the cable is not jammed in doors, fences or the like. Otherwise it can cause the charger to become live. Inspect extensions cords periodically and replace if damaged.

Do not use:

- a faulty or damaged battery charger or never use a faulty, damaged or deformed battery.

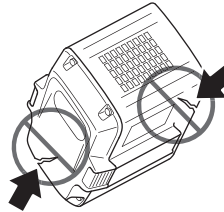

Do not charge:

- non-rechargeable batteries in the battery charger or use them in the machine.
- the battery in the battery charger outdoors.
- the battery in the rain or in wet conditions.
- the battery in direct sunlight.

Use the battery charger only when the surrounding temperature is between 5 °C and 40 °C. Use the charger in an environment which is well ventilated, dry and free from dust.

## Machine's safety equipment

This section describes the machine's safety equipment, its purpose, and how checks and maintenance should be carried out to ensure that it operates correctly. See the "What is what?" section to locate where this equipment is positioned on your machine.

The life span or the runtime of the machine can be reduced and the risk of accidents can increase if machine maintenance is not carried out correctly and if service and/or repairs are not carried out professionally. If you need further information please contact your nearest service workshop.

### IMPORTANT!

All servicing and repair work on the machine requires special training. This is especially true of the machine's safety equipment. If your machine fails any of the checks described below you must contact your service agent. When you buy any of our products we guarantee the availability of professional repairs and service. If the retailer who sells your machine is not a servicing dealer, ask him for the address of your nearest service agent.

# GENERAL SAFETY PRECAUTIONS



**WARNING! Never use a machine with faulty safety equipment. The machine's safety equipment must be checked and maintained as described in this section. If your machine fails any of these checks contact your service agent to get it repaired.**

## Control panel

Make sure the machine is switched on or off when the activate/deactivate button (1) is pressed and held (>1 sec.). The green LED (2) is lit or turned off.

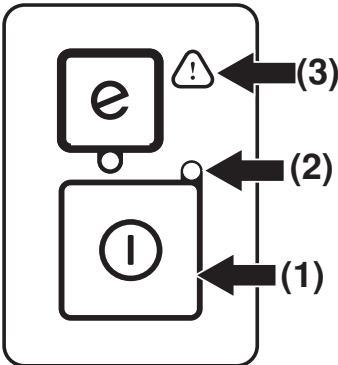

Flashing warning indicator (3) and green LED (2) is lit could indicate that:

- it is not possible to apply full power and, at the same time, activate the machine. Release the power trigger and the machine is active.
- the machine is blocked. Deactivate the machine. Remove the battery from the machine. Remove the twigs, branches or other materials that are jammed in the blades.
- the machine is overloaded due to heavy trimming. Release the power trigger and the machine is active.

If the warning symbol (3) flashes, it indicates that the machine is too hot and the machine deactivates. When the machine is restored to normal temperature it is again ready to run and you can activate the machine.

Solid red warning light (3) indicates service.

## Power trigger lockout

The power trigger is designed to prevent accidental operation. It is necessary to press both the power trigger lockout and the power trigger. The order actuation power trigger lockout and power trigger doesn't matter. When you release the handle, the power trigger and the power trigger lockout both move back to their original positions. This movement is operated by independent springs. This

arrangement means that the power trigger is automatically locked at no operation state.

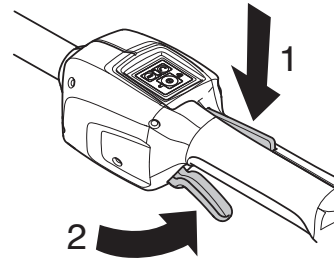

Turn on the machine.

Make sure the power trigger is locked when the power trigger lock is in its original position.

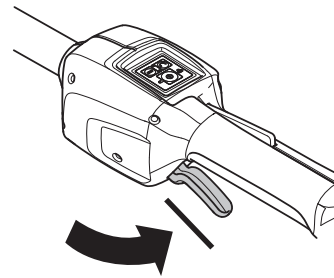

Press the power trigger lockout and make sure it returns to its original position when released.

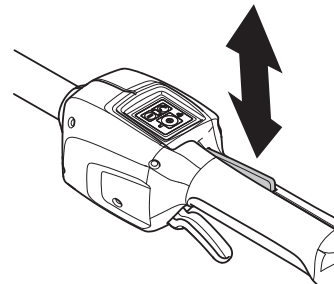

Check that the power trigger and the power trigger lockout move freely and that the return spring works properly.

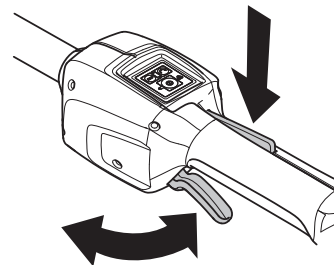

The cutting unit must stop within 3 seconds.

See instructions under the heading Start. Start the machine and apply full power. Release the power trigger and check that the cutting attachment stops and remain at a standstill.

---

## GENERAL SAFETY PRECAUTIONS

---

### Hand guard

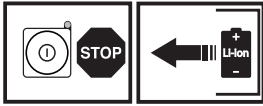

The hand guard prevents hands from coming into contact with the moving blades, for example, if the operator loses grip on the front handle.

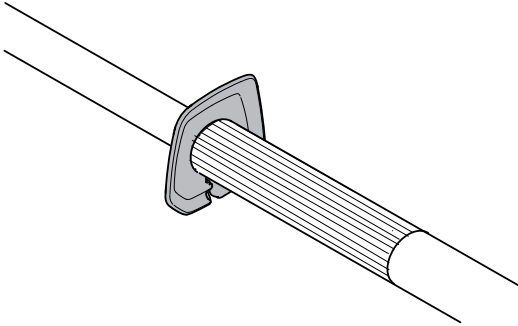

- Check that the hand guard is fitted correctly.
- Check that the hand guard is undamaged.

# BATTERY HANDLING

## Battery

The display shows the battery capacity and if there are any problems with the battery. The battery capacity is displayed for 5 seconds after the machine is switched off or the battery indicator button is pressed. The warning symbol on the battery is lit when an error has occurred. See fault codes.

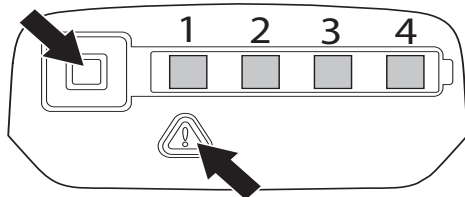

LED lights	Battery status
All LEDs are lit	Fully charged (75-100%).
LED 1, LED 2, LED 3 are lit.	The battery is 50%-75% charged.
LED 1, LED 2 are lit.	The battery is 25%-50% charged.
LED 1 is lit.	The battery is 0%-25% charged.
LED 1 flashes.	The battery is empty. Charge the battery.

## Battery charger



**WARNING! Risk of electric shock and short circuiting. Use approved and intact wall sockets. Make sure that the cable is not damaged. Replace cable if it appears to be damaged in any way.**

## Connect the battery charger

- Connect the battery charger to the voltage and frequency specified on the rating plate. Put the electric plug in a earthed socket-outlet. The LED on the battery charger flashes green once.

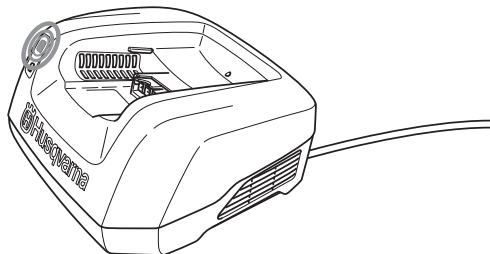

- The battery will not be charged if the battery temperature is over 50 °C. In that case the battery charger will actively cool down the battery.

## Connect the battery to the battery charger.

Regularly check that the battery charger and the battery are intact. See instructions under the Maintenance heading.

The battery must be charged before using it the first time. The battery is only 30% charged when delivered.

- Put the battery in the battery charger. Make sure that the battery is connected to the battery charger.

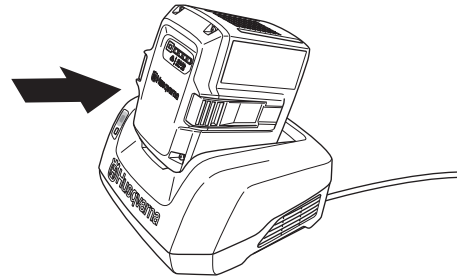

- The green charging light on the charger is lit when the battery is connected to the battery charger.
- When all LEDs are lit the battery is fully charged.

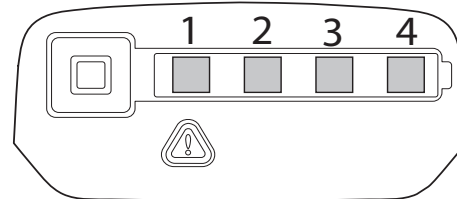

- Pull out the plug. Never jerk the power supply cable to disconnect it from the wall socket.
- Remove the battery from the battery charger.

See separate manual for instructions on how to charge the backpack battery.

## Charging status

Lithium-ion batteries can be charged at whatever charging level. The charging process can be cancelled or started whatever the battery's charge level is. The battery is not damaged. A fully charged battery will not lose its charge even when the battery is left in the charger.

The battery will not be charged if the battery temperature is over 50 °C.

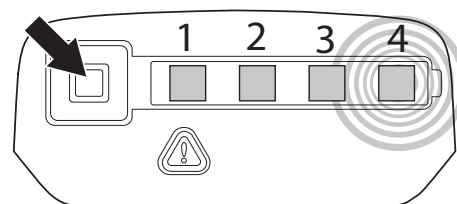

# BATTERY HANDLING

LED display	Charging status
LED 1 flashes.	The battery is 0%-25% charged.
LED 1 is lit, LED 2 flashes.	The battery is 25%-50% charged.
LED 1, LED 2 are lit, LED 3 flashes.	The battery is 50%-75% charged.
LED 1, LED 2, LED 3 are lit, LED 4 flashes.	Battery is 75%-100% charged
LED 1, LED 2, LED 3, LED 4 are lit.	When all the LEDs are lit on the battery, it is fully charged.

## Transport and storage

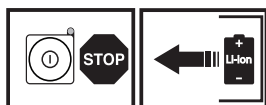

- The contained lithium-ion batteries are subject to the Dangerous Goods Legislation requirements.
- For commercial transports e.g. by third parties, forwarding agents, special requirement on packing and labeling must be observed.
- For preparation of the item being shipped, consulting an expert for hazardous material is required. Please also observe possibly more detailed national regulations.
- Tape or mask off open contacts and pack up the battery in such a manner that it cannot move around in the packing.
- Secure the machine during transport.
- Always remove the battery for storage or transport.
- Store the battery and the battery charger in a dry, moisture-free and frost-free space.
- To prevent accidents, ensure that your battery is not connected to the machine when stored.
- Do not store the battery in places where static electricity can occur. Never store the battery in a metal box.
- Store the battery where the temperature is between 5 °C and 25 °C and never in direct sunlight.
- Store the battery charger where the temperature is between 5 °C and 45 °C and never in direct sunlight.
- A discharged battery must be charged before storing. A discharged battery that is stored without charging can be damaged. Make sure the battery is charged to 30% - 50% before storing for long periods.
- Store the battery charger only in an enclosed and dry space.
- Be sure to store the battery separate from the battery charger. Store the equipment in a lockable area so that it is out of reach of children and unauthorized persons.

- Ensure the machine is cleaned and that a complete service is carried out before long-term storage.

## Disposal of the battery, battery charger and machine

Symbols on the product or its packaging indicate that this product cannot be handled as domestic waste. It must instead be submitted to an appropriate recycling station for the recovery of electrical and electronic equipment.

By ensuring that this product is taken care of correctly, you can help to counteract the potential negative impact on the environment and people that can otherwise result through the incorrect waste management of this product. For more detailed information about recycling this product, contact your municipality, your domestic waste service or the shop from where you purchased the product.

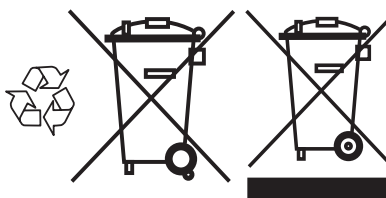

# STARTING AND STOPPING

## Check before starting

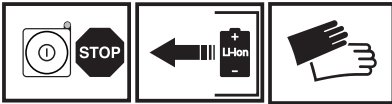

- Inspect the working area. Remove any objects that could be thrown out.
- Check the cutting attachment. Never use blades that are dull, cracked or damaged.
- Check that the machine is in perfect working order. Check that all nuts and screws are tight.
- Only use the machine for the purpose it was intended for.
- Make sure that the handle and safety features are in good working order. Never use a machine that lacks a part or has been modified outside its specifications. Gloves should be worn when necessary.
- All covers must be correctly fitted and undamaged before you start the machine.

## Connect battery to the machine

Use only a Husqvarna original BLi battery in your machine.

- Insert the battery in the machine. The battery should slide easily into the battery holder on the machine. If the battery does not slide in easily, it is not being inserted correctly. The battery will lock itself into place when you hear a click. Make sure the battery is fitted correctly to the machine.

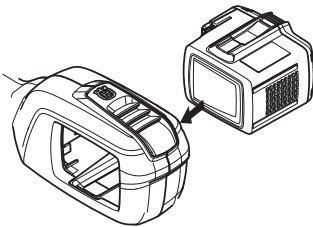

## Starting and stopping



**WARNING!** Make sure no unauthorised persons are in the working area. Otherwise there is a risk of serious personal injury. The safety distance is 15 meters.

### Starting

Turn on the machine. Press and hold the start button (>1 sec.) until the green LED is lit.

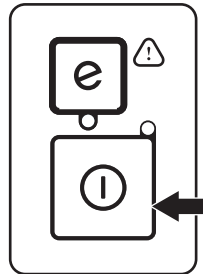

Then press the power trigger up to apply full power.

### Stopping

Stop the machine by releasing the power trigger or the power trigger lockout and deactivate the machine.

Remove the battery from the machine by pressing the two release buttons and pulling out the battery.

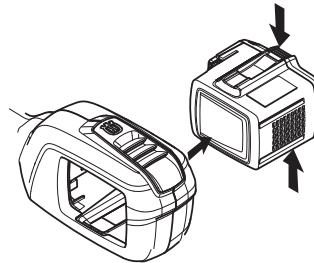

**IMPORTANT!** Always remove the battery to prevent the machine being started by accident.

# WORKING TECHNIQUES

## General working instructions

### IMPORTANT!

This section takes up the basic safety precautions for working with a hedge trimmer.

If you encounter a situation where you are uncertain how to proceed you should ask an expert. Contact your dealer or your service workshop.

Avoid all usage which you consider to be beyond your capability.



**WARNING! The machine can cause serious personal injury. Read the safety instructions carefully. Learn how to use the machine.**



**WARNING! Cutting tool. Do not touch the tool without first switching off the engine. Always remove the battery before any maintenance on the machine.**

## Basic safety rules



- Wear personal protective equipment. See instructions under the "Personal protective equipment" heading.
- Never allow children to use or be in the vicinity of the machine.
- Observe your surroundings and make sure that there is no risk of people or animals coming into contact with the cutting equipment.
- Never allow anyone else to use the machine without first ensuring that they have read and understood the contents of the operator's manual.
- Inspect the working area. Remove any objects that could be thrown out.
- Never work from a ladder, stool or any other raised position that is not fully secured.

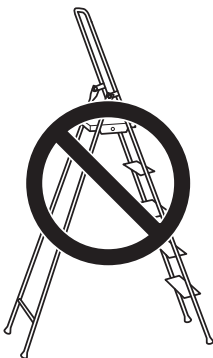

- **CAUTION!** Do not use the machine unless you are able to call for help in the event of an accident. Ensure

that no-one comes closer than 15 metres while you are working.

- Never use the machine in bad weather, for instance in fog, in rain, strong winds, intense cold, etc.
- If any foreign object is hit or if vibrations occur stop the machine immediately. Remove the battery from the machine and check that the machine is not damaged.

## SavE mode

The machine is equipped with a battery saving function (SavE). Activate the function by pressing the SavE button. A green LED will light to indicate that the function is on.

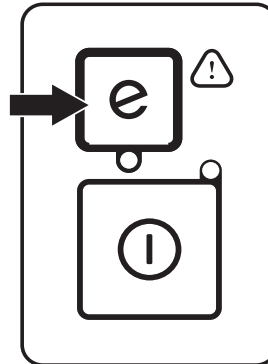

## Automatic switch off functionality

The machine is equipped with a shutdown feature that deactivates the machine if not used. The green LED will be extinguished and the machine turned off after 45 seconds.

## Safety instructions while working



- Do not overreach. Keep proper footing and balance at all times.
- Never put the machine down without turning it off first and always remove the battery.
- Use the harness to support the weight of the machine and make it easier to handle.



**WARNING! Watch out for thrown objects. Always wear approved eye protection. Never lean over the cutting attachment guard. Stones, rubbish, etc. can be thrown up into the eyes causing blindness or serious injury.**

**Keep unauthorised persons at a distance. Children, animals, onlookers and helpers should be kept outside the safety zone of 15 metres. Stop the machine immediately if anyone approaches. Never swing the machine around without first checking behind you to make sure no-one is within the safety zone.**

# WORKING TECHNIQUES

- Always use both hands to hold the machine. Hold the machine at the side of your body.

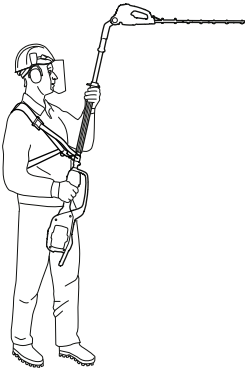

- Make sure that no clothes or parts of the body come in contact with the cutting equipment when it is activated.
- When the motor is switched off, keep your hands and feet away from the cutting attachment until it has stopped completely.
- Watch out for stumps of branches that can be thrown out during cutting. Do not cut too close to the ground. Stones and other objects can be thrown out.
- Check the working area for foreign objects such as electricity cables and animals, etc, or other objects that could damage the cutting attachment, such as metal items.
- If anything jams in the blades while you are working, switch off the motor and wait until it has stopped completely before cleaning the blades. Remove the battery from the machine.
- Never leave the machine unsupervised with the motor running.

## Safety instructions after completing work



- The transport guard should always be fitted to the cutting attachment when the machine is not in use.

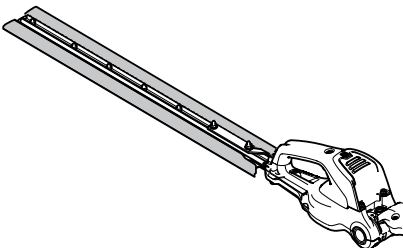

- Make sure the cutting attachment has stopped before cleaning, carrying out repairs or an inspection. Remove the battery from the machine.

- Always wear heavy-duty gloves when repairing the cutting attachment. The blades are very sharp and can easily cause cuts.

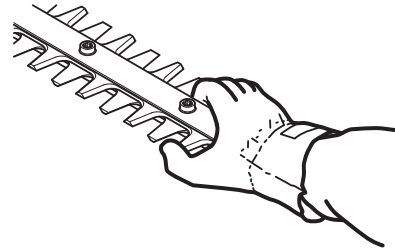

- Store the machine out of reach of children.

## Basic working techniques

- Work with a swinging action from the bottom upwards when trimming sides.

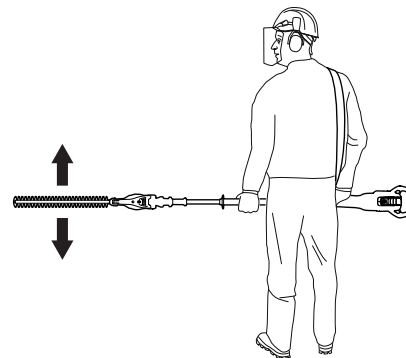

- When trimming a hedge the motor should always face away from the hedge.
- Hold the machine as close to your body as possible to get the best balance.



- Make sure that the tip does not touch the ground.
- Do not rush the work, but work steadily until all the branches have been cut back cleanly.



---

## WORKING TECHNIQUES

---

### Changing the hedge trimmer angle

Remove the battery from the machine.

The cutting unit has 8 adjustment positions to make work easier.

- Pull down the position adjustment handle.

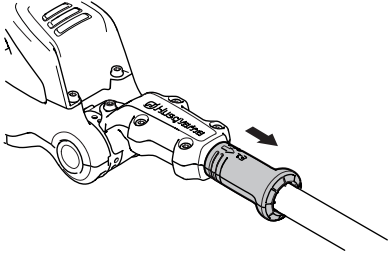

- Tilt the cutting unit with its handle to the desired position.

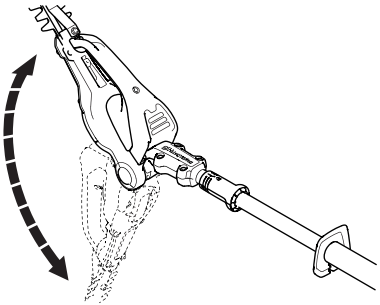

- Release the position adjustment handle so that the cutting unit locks at the correct angle.

### Transport position

- Always be sure to use the transport protection during transport or long movements.
- Remove the battery from the machine.
- Tilt the cutting unit 180° towards yourself.

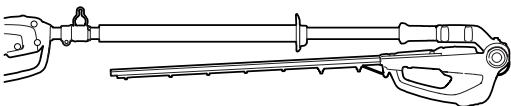

When the machine is in transport position, it cannot be activated.

# MAINTENANCE

## Inspection and maintenance

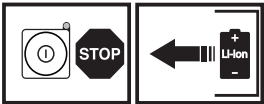

**WARNING!** Always remove the battery before any maintenance on the machine.

**IMPORTANT!** Never clean the battery or the battery charger with water.

Strong cleaning agents can damage the plastic.

All servicing and repair work on the machine requires special training. This is especially true of the machine's safety equipment. If your machine fails any of the checks described below you must contact your service agent. When you buy any of our products we guarantee the availability of professional repairs and service. If the retailer who sells your machine is not a servicing dealer, ask him for the address of your nearest service agent. Only use original spare parts.

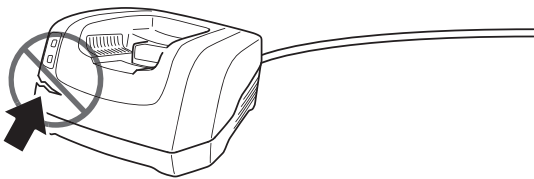

Regularly check that the battery charger and the battery are intact.

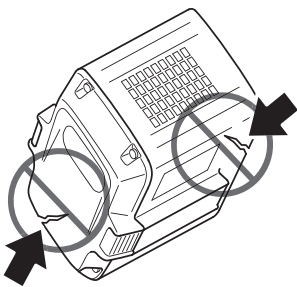

## Cleaning

Clean the machine after use.

Make sure the battery and battery charger are clean and that the terminals on the battery and the battery charger

are always clean and dry before the battery is placed in the battery charger.

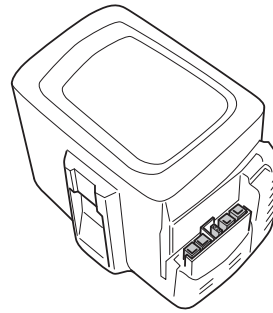

Keep the battery guide tracks clean. Clean plastic parts with a clean and dry cloth.

## Cleaning and lubrication

Clean any resin and plant residue from the blades using cleaning agent before and after using the machine.

Check that the blade edges are not damaged or deformed. File away any burrs. Check that the blades move freely.

Lubricate the blade bars before long periods of storage. Ask your Husqvarna dealer if you need more information.

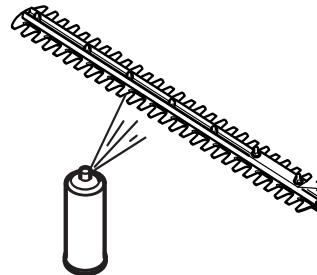

Ask your dealer for information on lubrication points and volume of grease in the gear. Use a high quality grease intended for Husqvarna products.

## Tilt adjustment of cutting unit

Adjust the tension of the tilt adjustment with the screw. Turn the screw clockwise or counterclockwise in order to easily tilt the cutting unit.

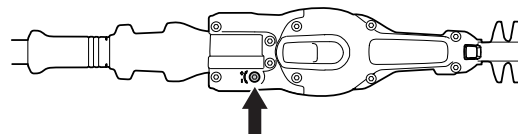

# MAINTENANCE

## Troubleshooting schedule

### Control panel

Troubleshooting takes place from the keypad.

LED display	Possible faults	Possible action
Green activate LED flashing.	Low battery voltage.	Charge the battery.
Error LED flashes.	Overload.	The cutting attachment is jammed. Release the cutting attachment.
	Temperature deviation.	Allow the machine to cool down.
	The power trigger and the activate button are pressed at the same time.	Release the power trigger and the machine is active.
The machine does not start	Dirt in battery connectors.	Clean with compressed air or a soft brush.
Error LED is lit with red light.	Service	Contact your service agent.

Troubleshooting the battery and/or the battery charger during charging.

### Battery

LED display	Possible faults	Possible action
Green activate LED flashing.	Low battery voltage.	Charge the battery.
Error LED flashing	Temperature deviation.	Use the battery in surroundings where temperatures are between -10 °C and 40 °C.
	Over voltage.	Check that the mains voltage corresponds with that stated on the rating plate on the machine.
		Remove the battery from the battery charger.
Error LED is lit	Cell difference too much (1V).	Contact your service agent.

### Battery charger

LED display	Possible faults	Possible action
Error LED flashing	Temperature deviation.	Use the battery charger only when the surrounding temperature is between 5 °C and 40 °C.
Error LED is lit		Contact your service agent.

# MAINTENANCE

## Maintenance schedule



**WARNING! Always remove the battery before any maintenance on the machine.**

The following is a list of the maintenance steps that must be performed on the machine. Most of the items are described in the Maintenance section. The user must only carry out the maintenance and service work described in this Operator's Manual. More extensive work must be carried out by an authorized service workshop.

Maintenance	Before use	Weekly maintenance	Monthly maintenance
Clean the outside of the machine.	After each time the machine is used		
Check that the start and stop switch works correctly and is not damaged.	X		
Make sure that the power trigger and the power trigger lockout function correctly from a safety point of view.	X		
Check that all controls are undamaged and in working order.	X		
Check that the cutter and cutter guard are not damaged or cracked. Replace the cutter or cutter guard if they have been exposed to impact or if they are cracked.	X		
Replace the cutting unit if it is damaged.	X		
Check that the hand guard is not damaged. Replace the guard if damaged.	X		
Check that nuts and screws are tight.	X		
Check that the battery is intact.	X		
Check the battery's charge.	X		
Check that the battery charger is intact and functional.	X		
Ensure the cutting unit position lock is in working order.	X		
Check that the screws that hold the blades together are correctly tightened.		X	
Check the connections between the battery and the machine and also check the connection between battery and the battery charger.			X

---

# TECHNICAL DATA

---

## Technical data

<b>Motor</b>	<b>536LiHE3</b>
Motor type	BLDC (brushless) 36V
<b>Weight</b>	
Weight without battery, kg	4,1
Weight with battery, kg	5,5
Default battery BLi150	
<b>Battery runtime</b>	
Battery runtime, min, (free run) with SavE activated	100
Default battery BLi150	
<b>Cutter</b>	
Type	Double sided
Blade length, mm	550
Blade speed cuts/min with SavE function activated	3200
Blade speed cuts/min with SavE function deactivated	4000
<b>Noise emissions</b>	
(see note 1)	
Sound power level, measured dB(A)	94
Sound power level, guaranteed $L_{WA}$ dB(A)	95
<b>Sound levels</b>	
Sound pressure level at the operator's ear, measured according to EN 60745-1 and EN 60745-2-15, dB (A):	84
<b>Vibration levels</b>	
(see note 2)	
Vibration levels ( $a_h$ ) at handles, measured according to EN 60745-1 and EN 60745-2-15, $m/s^2$ .	
Front/rear handles:	3,5/2,5

Note 1: Noise emissions in the environment measured as sound power ( $L_{WA}$ ) in conformity with EC directive 2000/14/EC. The difference between guaranteed and measured sound power is that the guaranteed sound power also includes dispersion in the measurement result and the variations between different machines of the same model according to Directive 2000/14/EC.

Note 2: Reported data for vibration level has a typical statistical dispersion (standard deviation) of  $1,5 m/s^2$ .

- The declared vibration total value has been measured in accordance with a standard test method and may be used for comparing one tool with another.

- The declared vibration total value may also be used in a preliminary assessment of exposure.

**Use only a Husqvarna original BLi battery in your machine.**

<b>Approved chargers for the specified batteries, BLi.</b>			
Battery charger	<b>QC330</b>	<b>QC80</b>	<b>QC80F</b>
Mains Voltage, V	100-240	100-240	10-15
Frequency, Hz	50-60	50-60	50-60
Power,W	330	100	95

---

## TECHNICAL DATA

---

### EC Declaration of Conformity (Applies to Europe only)

**Husqvarna AB**, SE-561 82 Huskvarna, Sweden, tel: +46-36-146500, declare under sole responsibility that the hedge trimmers **Husqvarna 536LiHE3** from 2016's serial numbers and onwards (the year is clearly stated in plain text on the type plate with subsequent serial number), are in conformity with the standards or other normative documents following the provisions in the COUNCIL'S DIRECTIVES:

- of May 17, 2006 "relating to machinery" **2006/42/EC**.
- of February 26, 2014 "relating to electromagnetic compatibility" **2014/30/EU**.
- of May 8, 2000 "relating to the noise emissions in the environment" **2000/14/EC**.
- of June 8, 2011 on the "restriction of use of certain hazardous substances" **2011/65/EU**.

The following standards have been applied:

**EN 60745-1:2006, EN 12100:2010, EN 55014-1:2006+A1:2009+A2:2011, EN 61000-6-2:2005**

SMP Svensk Maskinprovning AB has also verified agreement with appendix V of the council's directive 2000/14/EG. For information relating to noise emissions, see the Technical data chapter. The report has the number:

**6F009121-2**

Huskvarna March 30, 2016



Lars Roos, Development manager (Authorized representative for Husqvarna AB and responsible for technical documentation.)



**Husqvarna AB**  
**SE-561 82 Huskvarna**  
**Visiting address: Drottninggatan 2**

**1158348-26**



**2016-10-07**