

KETTLER

Montageanleitung Cross-Trainer Ergometer „CTR 1“ Art.-Nr. 7858-600



D

GB

F

NL

Der Umwelt zuliebe: Wir drucken auf 100% Altpapier!



FREIZEIT MARKE KETTLER

Please, thoroughly read these instructions prior to assembly and first use. You will get important information about your safety as well as the use and maintenance of your Cross-Trainer. Keep these instructions for reference and/or for maintenance work or spare parts orders.

For Your Safety

- Cross-Trainer should be used only for its intended purpose, i.e. for physical exercise by adult persons.
- Any other use of the equipment is prohibited and may be dangerous. The manufacturer cannot be held liable for damage or injury caused by improper use of the equipment.
- Exercise has been designed in accordance with the latest standards of safety. Any features which may have been a possible cause of injury have been avoided or made as safe as possible.
- Incorrect repairs and structural modifications (e.g. removal or replacement of original parts) may endanger the safety of the user.
- Damaged components may endanger your safety or reduce the lifetime of the equipment. For this reason, worn or damaged parts should be replaced immediately and the equipment taken out of use until this has been done. Use only original KETTLER spare parts.
- In case of enquiry, please contact your KETTLER dealer.
- If you train regularly and intensively, please check all equipment parts – in particular bolts and nuts – every 1 to 2 months. This is particularly true for the attachment of grip strap and running plate.
- Instruct persons using the equipment (in particular children) on possible sources of danger during exercising.
- Before beginning your program of exercise, consult your doctor to ensure that you are fit enough to use the equipment. **Base your program of exercise on the advice given by your doctor. Incorrect or excessive exercise may damage your health.**

Handling the equipment

- Before using the equipment for exercise, check carefully to ensure that it has been correctly assembled.
- It is not recommended to use or store the apparatus in a damp room as this may cause it to rust. **Please ensure that no part of the machine comes in contact with liquids (drinks, perspiration etc.). This may cause corrosion.**
- The Cross-Trainer is designed for use by adults and children should not be allowed to play with it. Children at play behave unpredictably and dangerous situations may occur for which the manufacturer cannot be held liable. If, in spite of this, children are allowed to use the equipment, ensure that they are instructed in its proper use and supervised accordingly.
- The Cross-Trainer conforms to the safety request of part H of the DIN norm EN 957. It is therefore suitable for therapeutic use.
- On principle, the equipment does not require any special maintenance. All bearings are pre-lubricated (further lubrication is not required) and require little maintenance.
- Do not use corrosive or abrasive materials to clean the equipment. Ensure that such materials are not allowed to pollute the environment.
- The Cross-Trainer has a brake system, which require little maintenance and does not require any adjusting work.
- The Cross-Trainer is independent of revolutions per minute.
- **Please ensure that liquids or perspiration never enter the machine or the electronics.**
- Before use, always check all screws and plug-in connections as well as respective safety devices fit correctly.

Instructions for Assembly

- Ensure that you have received all the parts required (see check list) and that they are undamaged. Should you have any cause for complaint, please contact your KETTLER dealer.
- Before assembling the equipment, study the drawings carefully and carry out the operations in the order shown by the diagrams. The correct sequence is given in capital letters.
- The equipment must be assembled with due care by an adult person. If in doubt call upon the help of a second person, if possible technically talented.
- Please note that there is **always** a danger of injury when working with tools or doing manual work. Therefore please be careful when assembling this machine.
- Ensure that your working area is free of possible sources of danger, for example don't leave any tools lying around. Always dispose packaging material in such a way that it may not cause any danger. There is always a **risk of suffocation** if children play with plastic bags!
- The fastening material required for each assembly step is shown in the diagram inset. Use the fastening material exactly as instructed. The required tools are supplied with the equipment.
- Bolt all the parts together loosely at first, and check that they have been assembled correctly. Tighten the locknuts by hand until resistance is felt, **then use spanner to finally tighten nuts completely against resistance (locking device)**. Then check that all screw connections have been tightened firmly. **Attention:** once locknuts have been unscrewed they no longer function correctly (the locking device is destroyed), and must be replaced.
- For technical reasons, we reserve the right to carry out preliminary assembly work (e.g. addition of tubing plugs).
- Please keep original packaging of this article, so that it may be used for transport at a later date, if necessary.

List of spare parts

When ordering spare parts, always state the full article number, spare-part number, the quantity required and the inspection number stamped on the back.

Example order: Art. no. 7858-600 / spare-part no. 70128562 / 2 pieces / inspection no.....

Important: spare part prices do not include fastening material; if fastening material (bolts, nuts, washers etc.) is required, this should be clearly stated on the order by adding the words „with fastening material“.

KETTLER (GB) Ltd. · Merse Road · North Moons Moat · Redditch,
Worcestershire B98 9HL · Great Britain
KETTLER International Inc. · 1355, P. B. 2747 · Virginia Beach ·
VA 23450 USA
<http://www.kettler.net>

Montagehandleiding

- Controleer bij ontvangst of het apparaat compleet is (zie checklijst) en of het toestel tijdens het transport niet beschadigd is. Voor reclamaties gelieve u zich tot uw vakhandelaar te wenden.
- Bekijk eerst rustig de tekeningen en monteer vervolgens het apparaat in de volgorde van de afbeeldingen. Op de afzonderlijke tekeningen wordt het montageverloop met hoofdletters aangegeven
- Let erop dat bij elk gebruik van gereedschap en bij handenarbeid er **altijd** kans op blessure is. Werk daarom zorgvuldig en voorzichtig bij het monteren van het apparaat!
- Zorg voor een gevarenvrije werkomgeving, laat bijvoorbeeld geen gereedschap slingeren. Deponeer bijv. verpakkingsmateriaal zo, dat geen gevaren daaruit voort kunnen komen. Bij folies/plastic zakken bestaat **verstikkingsgevaar!**
- Het apparaat dient door een volwassene gemonteerd te worden. In geval van twijfel de hulp van een extra, technisch aangelegde persoon inroepen.

- Het voor een bepaalde handeling benodigde schroefmateriaal wordt in het bijbehorende kader afgebeeld. Gebruik het schroefmateriaal precies zoals aangegeven op de afbeeldingen. Het benodigde gereedschap vindt u in het bijgeleverde gereedschapzakje.
- Schroef eerst alle onderdelen losjes vast en controleer of ze op de juiste plek zitten. Draai de borgmoeren met de hand vast tot u weerstand voelt, vervolgens **schroeft u ze met een sleutel tegen de weerstand in (klemborg) goed vast**. Controleer na elke montageschroef of de schroefverbindingen goed vast zitten. **Pas op:** borgmoeren die weer los zijn gegaan zijn onbruikbaar (de klemborg is vernield) en moet door een nieuwe vervangen worden.
- Bewaar de originele verpakking, zodat u deze later indien nodig als transportverpakking kunt gebruiken.
- Om productietechnische redenen behouden wij ons het recht voor sommige delen (bijvoorbeeld buisstoppen) vóór te monteren.

Onderdelenlijst

Geef bij bestelling van onderdelen s.v.p. het volledige artikel- en onderdeelnummer, het benodigde aantal evenals het controlenummer, dat op de achterzijde van de montagehandleiding gedrukt staat, an.

Bestelvoorbeeld: artikelnr. 7858-600 / onderdeelnr. 70128562 / 2 stuks / kontrolennr.....

Belangrijk: Vast te schroeven onderdelen worden in principe zonzonder schroefmateriaal berekend en geleverd. Indien er behoefte aan dit schroefmateriaal bestaat, dan kan dit door de toevoeging „met schroefmateriaal“ bij de bestelling worden vermeld.

der schroefmateriaal berekend en geleverd. Indien er behoefte aan dit schroefmateriaal bestaat, dan kan dit door de toevoeging „met schroefmateriaal“ bij de bestelling worden vermeld.

KETTLER Benelux B.V. · Indumastraat18 · NL-5753 RJ Deurne
KETTLER Benelux B.V. Filiaal België · Brandekensweg 9 · B-2627 Schelle
<http://www.kettler.net>

Messhilfe für Verschraubungsmaterial

GB Measuring help for screw connections

NL Meethulp voor schroefmateriaal

F Gabarit pour système de serrage

Beispiele Exemples Exemples Bij voorbeeld

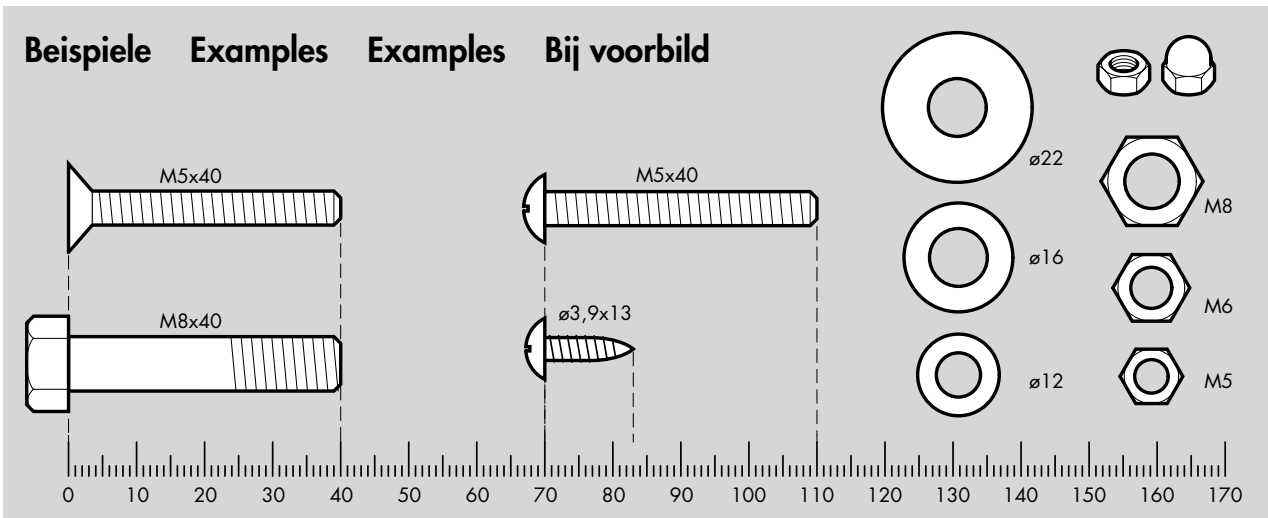









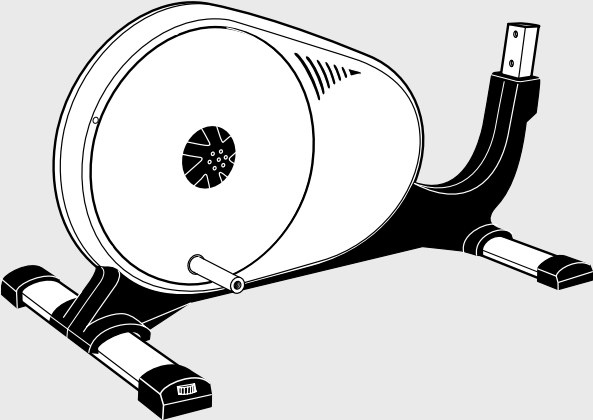
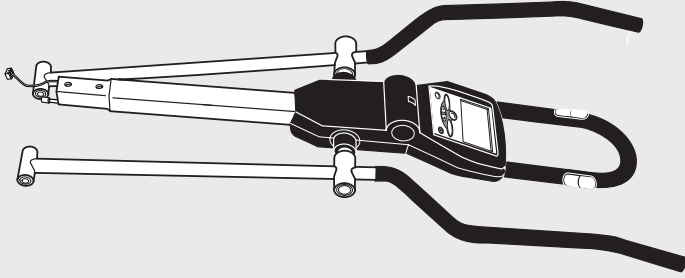
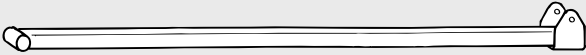

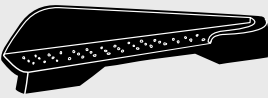





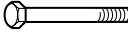



Checkliste (Packungsinhalt)

GB Checklist (contents of packaging)

NL Checklijst (verpakking inhoud)

F Liste de vérification (contenu de l'emballage)

			1		
			1		
			2		
	1			1	
	1			2	
	1			2	
	1				

	M 10 x 105	2	
	M 8 x 16	6	
	M 5 x 45	4	
	M 5	4	
	M 10	2	
	ø 21 x 8,4	2	
	ø 10	4	
	ø 25 x 8,4	2	
	ø 25 x 10,5	4	
		8	
		2	
		2	
	M 5 x 20	2	
		2	

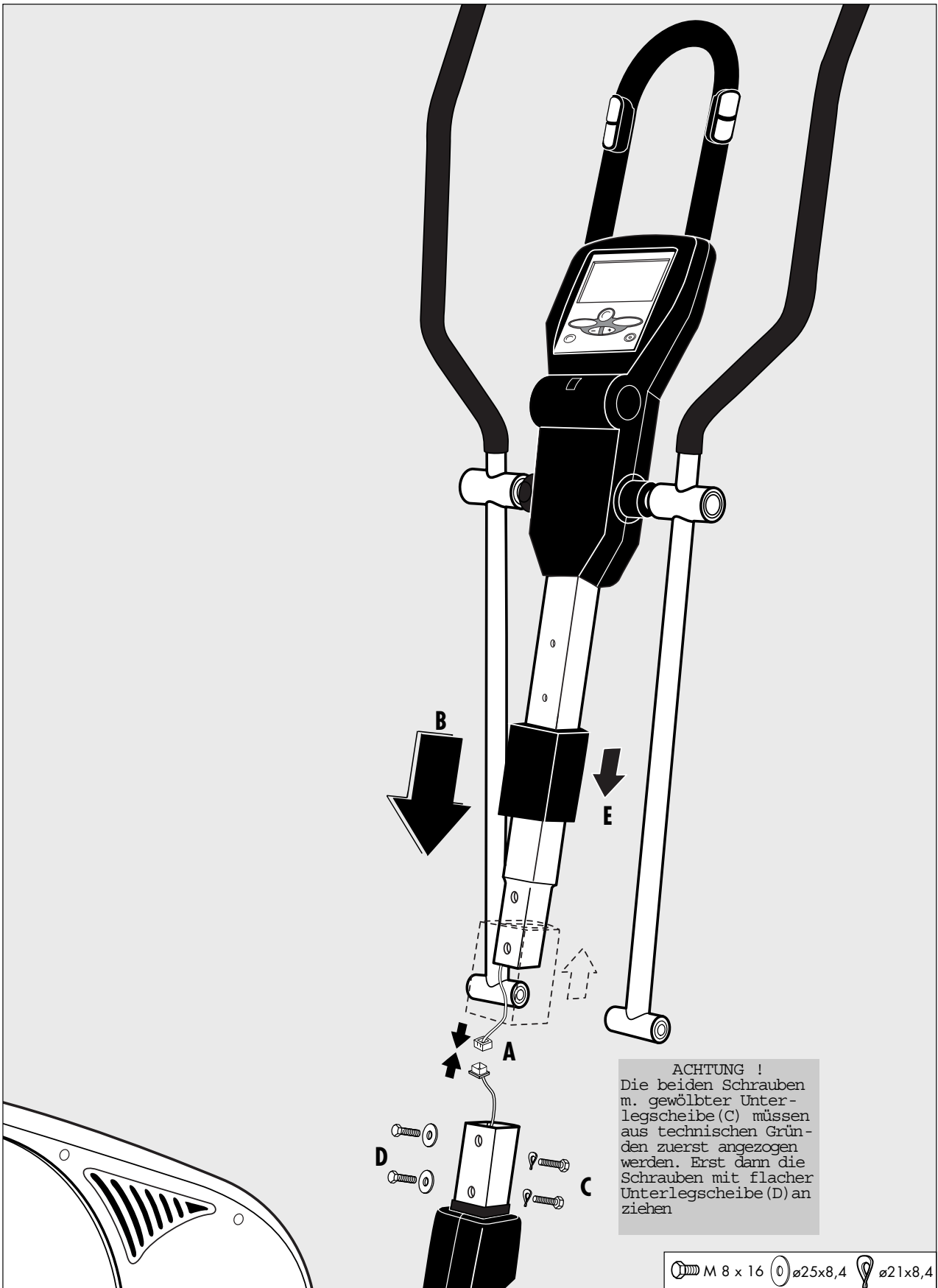

2

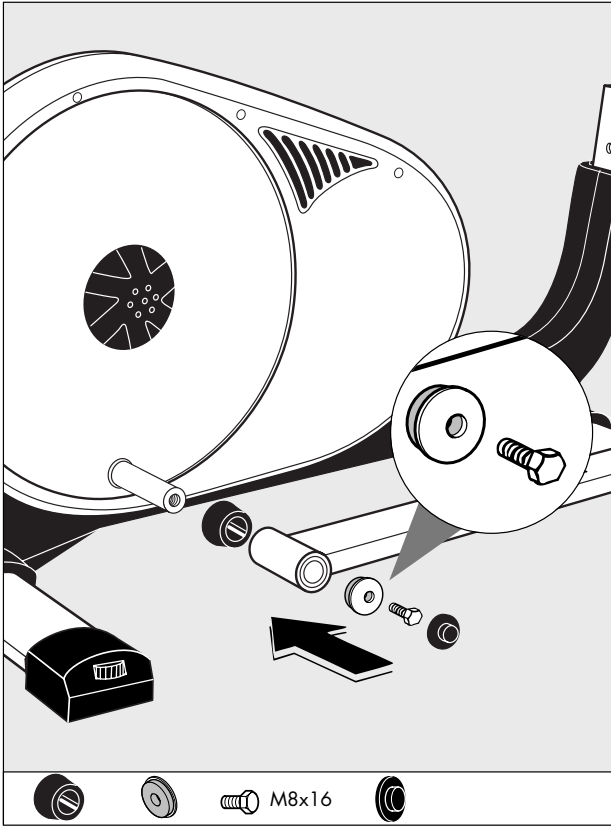



 M8x16
 

3

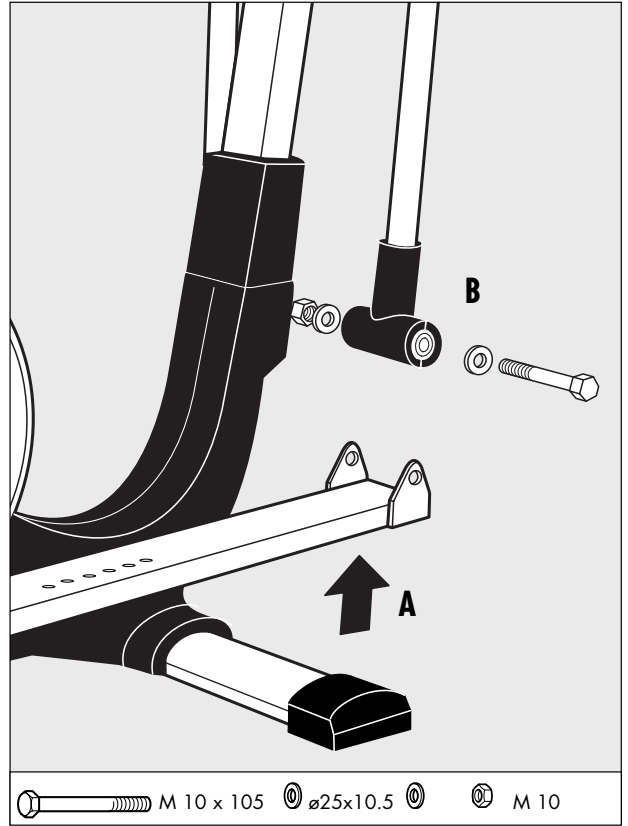

 M 10 x 105
  $\varnothing 25 \times 10.5$

 M 10

4



5

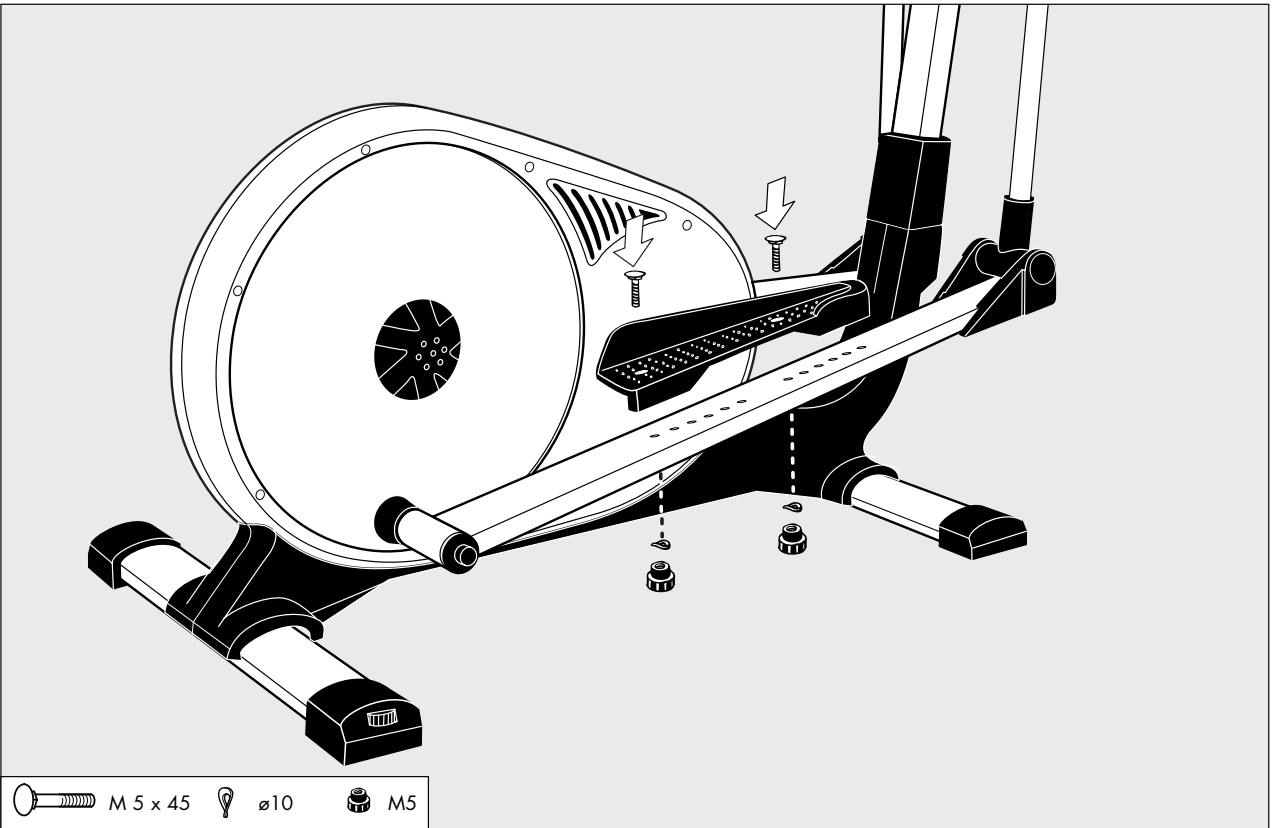

6

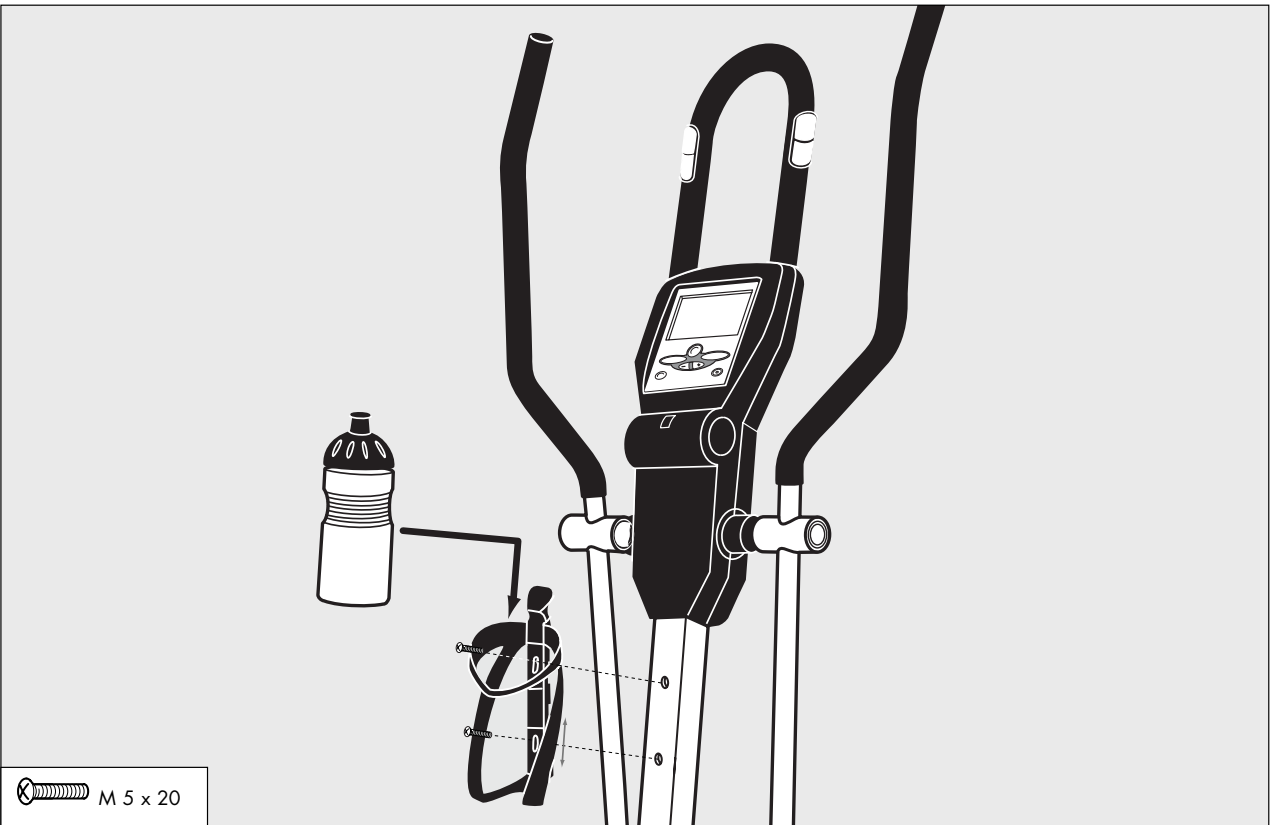

Handhabungshinweise

GB Handling

F Indications relatives à la manipulation

NL Bedieningsinstructies

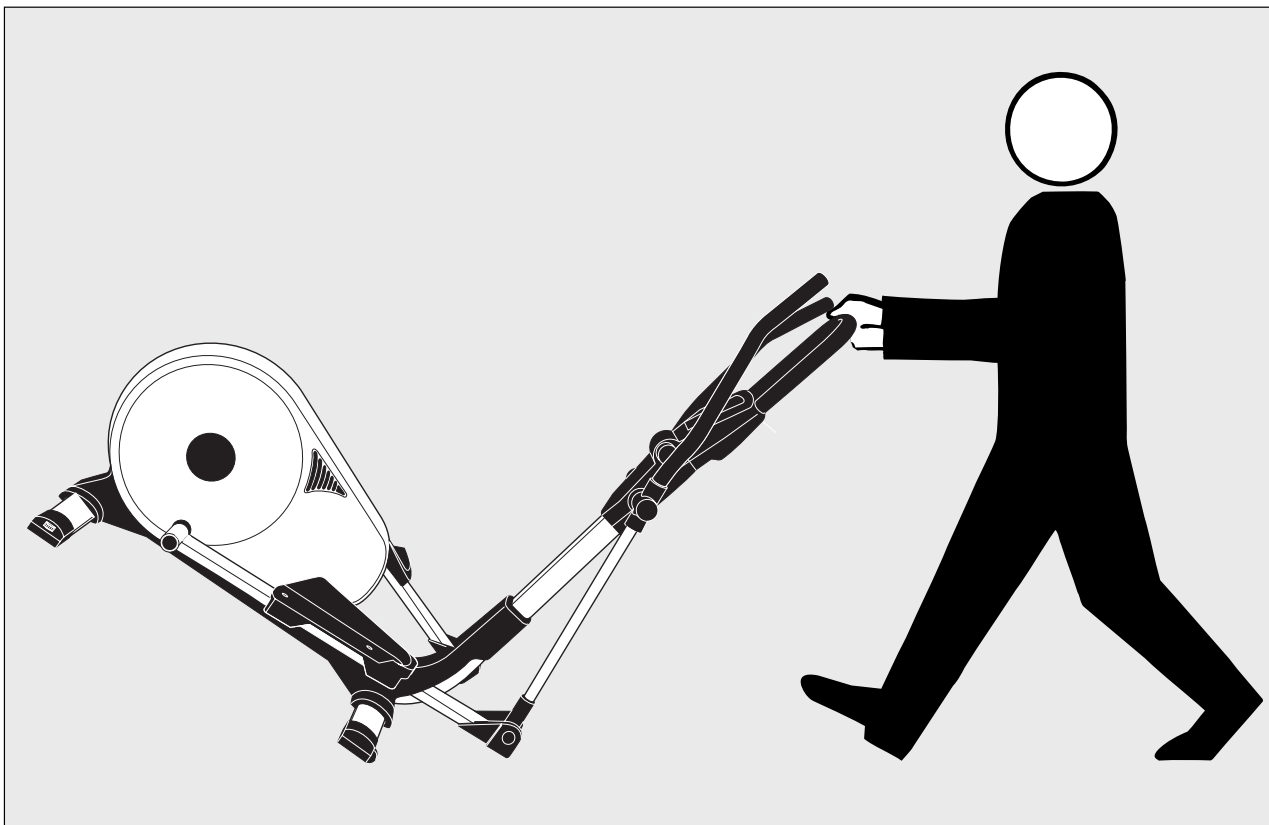
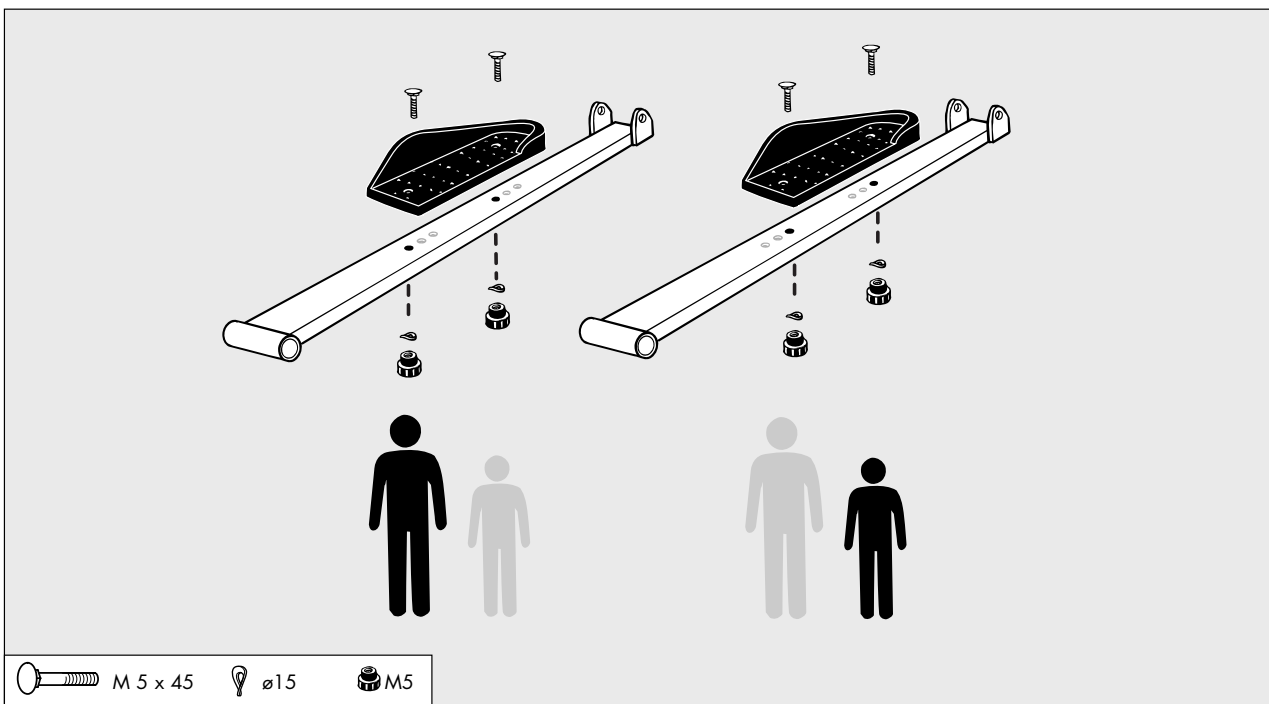

Handhabungshinweise

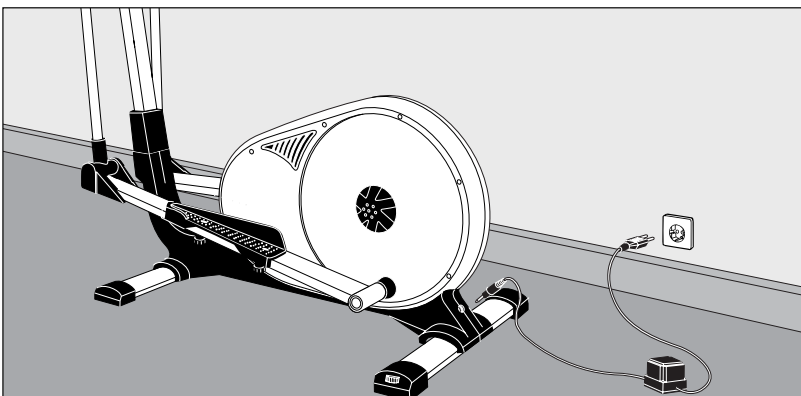
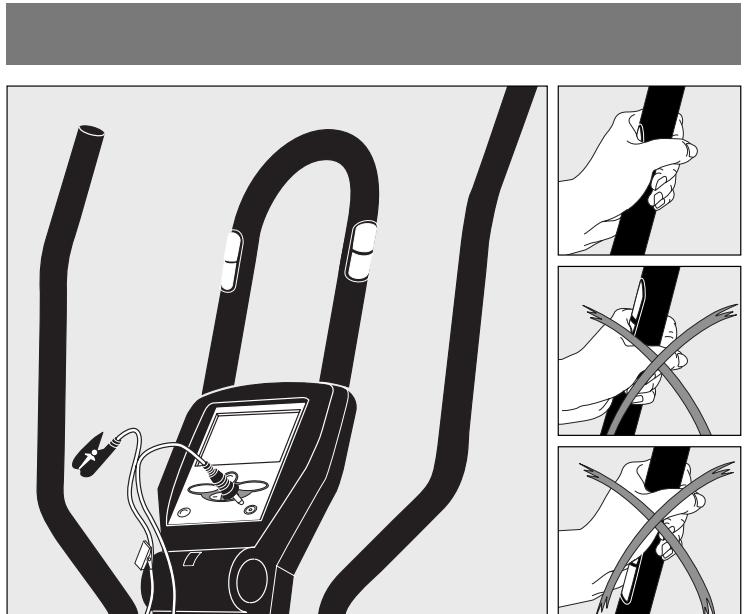
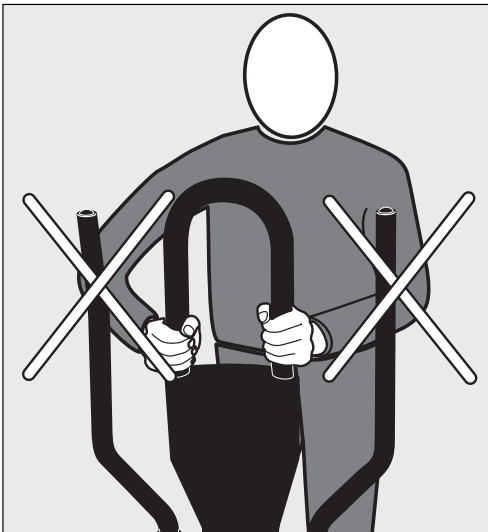
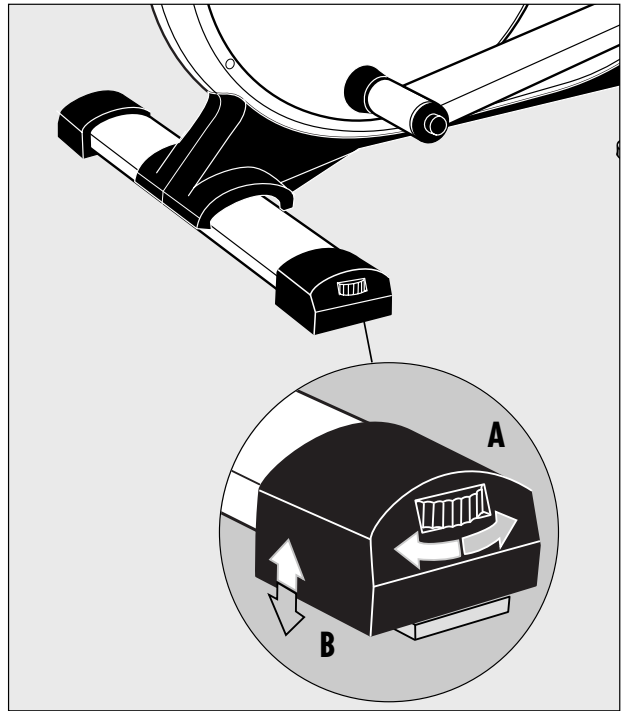
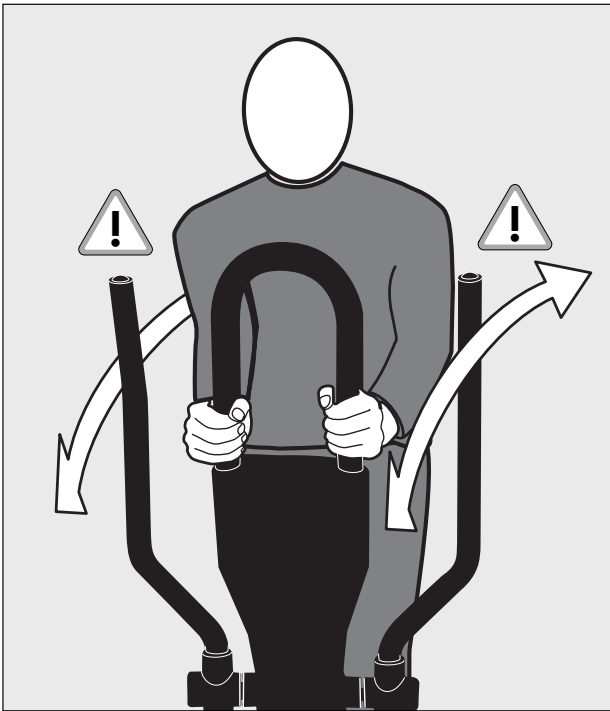

Ersatzteilliste

Teil Nr.	Bezeichnung	Stück	Ersatzteil-Nr. für 7858-600
1	Grundrahmen	1	94313933
2	Kugellager 6203-ZZ C3 für Grundrahmen	2	33100017
3	Welle ø17x114mm mit Bef.-Mat.	1	11300042
4	Geschwindigkeitsaufnahme 375mm	1	67000690
5	Kontakthalteblech	1	97200127
6	Elektromagnet (montiert)	1	94313936
7	Steuerung für Magnetspule	1	42860011
8	Aufnahmeblech	1	97200247
9	Anpresswinkel	1	97201816
11	Stromkabel (unten) 900mm	1	67000718
12	Leitung mit Buchse 850mm	1	42860012
13	Aufnahme für Netzstecker	1	70127365
14	Deckel zu Cockpit-Vorderteil	1	70128509
15	Schnittstelle 300mm	1	67000720
17	Deckel	2	70128469
18	Netztrafo	1	42860006
20	Aufnahmeblech mit Kugellager 6300-ZZ (montiert)	1	94313101
21	Zugfeder für Umlenkrolle	1	25635052
22	Schwungrad (montiert)	1	91140380
23	Poly-V-Riemen 1651 PJ6	1	67005127
24	Laufрад	1	94313975
25	Riemenscheibe	1	94313974
26	Bolzen ø20x133mm (Rechtsgewinde)	1	10900061
27	Verkleidung Seitenteil (rechts)	1	70128513
28	Verkleidung Seitenteil (links)	1	70128514
29	Abdeckkappe für Nabe	2	70128360
30	Verkleidung Unterteil (rechts)	1	70128403
31	Verkleidung Unterteil (links)	1	70128404
32	Gelenkseitenverkleidung (rechts)	2	70128421
33	Gelenkseitenverkleidung (links)	2	70128422
34	Spreizniete ø6x9,5mm	8	10418503
35	Bodenrohr	2	91111287-20
36	Bodenschoner mit Höhenverstellung	2	91170389
37	Rollschoner (rechts)	1	91170387
38	Rollschoner (links)	1	91170388
39	Pedalarm (kpl. mit Stopfen und Kugellagern 6203-ZZ)	2	94315102
40	Bolzen ø20x133mm (Linksgewinde)	1	10900071
41	Kugellager 6203-ZZ für Cross-Trainer	8	33100038
42	Vorderrohr	1	94313796
51	Stützbügel (kpl. mit Handpulsaufnehmer und Griffschlauch)	1	94313942
52	Griffschlauch 750mm	1	10118072
53	Cockpit-Vorderteil	1	70128401
55	Computer ERGO 2001	1	67000712
56	Cockpit-Unterteil	1	70128508
57	Stromkabel 1000mm	1	67000126
58	Pulsaufnahme	1	67000421
59	Hand-Pulsaufnehmer WP 1007-5C	1	67000658
60	Lenkerrohrabdeckung	1	70128475
61	Armhebel rechts (kpl. mit Kugellagern 6200-Z und 6203-ZZ, Distanzrohr ø20x4,5x59mm, Griffschlauch 680mm, Gelenkpunktverkleidungen und Stopfen für ø28mm)	1	94313944
62	Armhebel links (kpl. mit Kugellagern 6200-Z und 6203-ZZ, Distanzrohr ø20x4,5x59mm, Griffschlauch 680mm, Gelenkpunktverkleidungen und Stopfen für ø28mm)	1	94313945
63	Kugellager 6200-ZZ	4	33100036
64	Distanzrohr ø20x4,5x59mm	2	97201447
65	Griffschlauch 680mm	2	10118073
66	Stopfen für ø28mm	2	10100018
67	Kugellager 6203-ZZ	1	33100023
68	Halteblech	2	97200256
69	Fußtritt (rechts)	1	70128398
70	Fußtritt (links)	1	70128399

Ersatzteilliste

Teil Nr.	Bezeichnung	Stück	Ersatzteil-Nr. für 7858-600
71	Drehpunktverkleidung (Teil 1)	2	70128411
72	Drehpunktverkleidung (Teil 2)	2	70128412
73	Gelenkpunktverkleidung (Teil 1)	2	70128413
74	Gelenkpunktverkleidung (Teil 2)	2	70128414
75	Distanzhülse	2	70133275
76	Abdeckkappe	2	70130860
77	Federscheibe A5	4	10601001
78	Rändelmutter M5	4	10104000
79	Schraubenbeutel	1	94313723
80	Trinkflaschenhalter	1	70190051
81	Trinkflasche	1	70190041
83	MITTO-Plastikschraube	8	10224072
84	Einschubteil (rechts)	1	70128426
85	Einschubteil (links)	1	70128427
86	Dichtscheibe ø22x9,2x1mm mit Beschichtung	2	10505000
88	Kassettenblech-Aufsatz	1	70128492
89	Lüfterscheibe	1	70125785
90	Abdeckung für Computer	1	70125804
91	Folienpapier (für Bodenrohre)	2	34010120

Geben Sie bei Ersatzteilbestellungen bitte die vollständige Artikelnummer, die Ersatzteilnummer, die benötigte Stückzahl, die auf der Rückseite aufgestempelte Kontrollnummer und die Gerätenummer (siehe Aufkleber Grundrahmen Bereich Lenkrohr) an.

Bestellbeispiel: Art.-Nr. 7858-600/Ersatzteil-Nr. 10118073 / 2 Stück/Kontroll-Nr:/Kontroll-Nr:/Geräte-Nr:

Wichtig: Zu verschraubende Ersatzteile werden grundsätzlich ohne Verschraubungsmaterial berechnet und geliefert. Falls Bedarf an entsprechendem Verschraubungsmaterial besteht, ist dieses durch den Zusatz „mit Verschraubungsmaterial“ bei der Ersatzteilbestellung anzugeben.

HEINZ KETTLER GmbH & Co. KG · Postfach 1020 · D-59463 Ense-Parsit
KETTLER Austria GmbH · Eisenwang 119 · A-5322 Hof bei Salzburg · Trisport AG · Im Bösch · CH-6331 Hünenberg
www.kettler.net



FREIZEIT MARKE KETTLER

HEINZ KETTLER GmbH & Co. KG · Postfach 1020 · D- 59463 Ense-Parsit
www.kettler.net

- Ⓓ Bei Reklamationen bitte diese Kontrollnummer angeben.
- ⒼⒷ In case of complaint, please state this control number.
- Ⓕ En cas de réclamation, prière de mentionner ce numéro de contrôle.
- ⒼⓃ Bij reclamaties dit controlnummer vermelden.