

Moulinex®

noveo

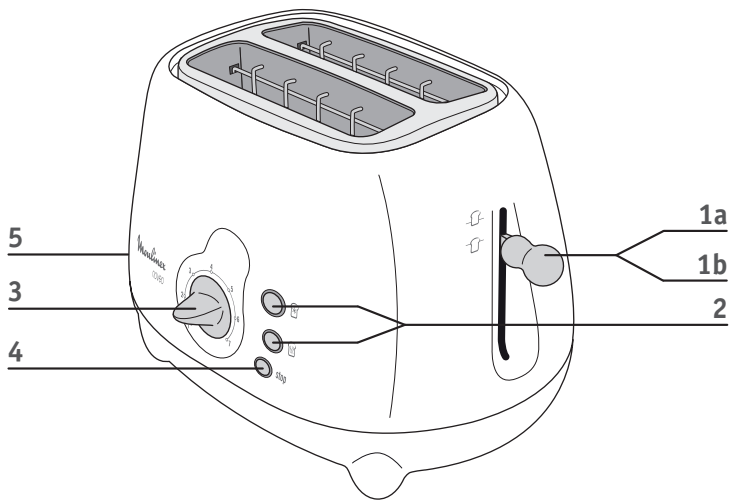

www.moulinex.com

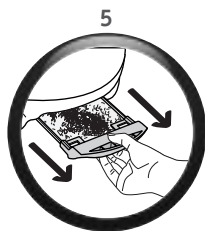
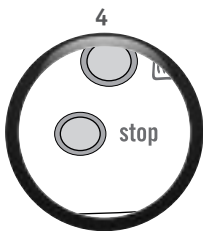
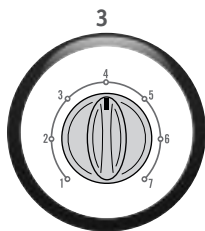
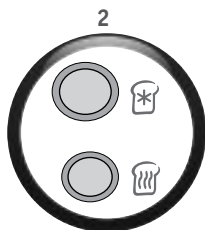
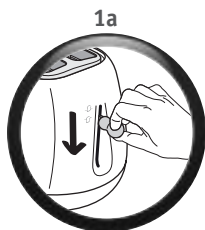

1 FIRST USE

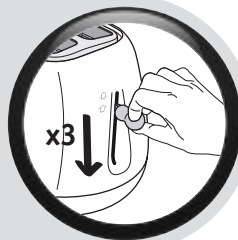
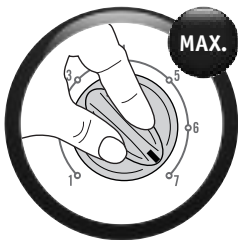
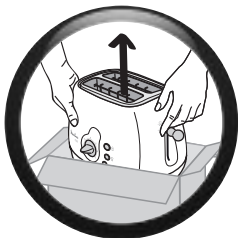



2 TOASTING

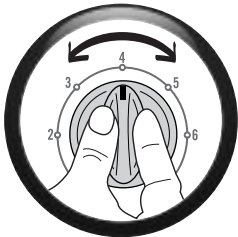

3 STOP/EJECT

STOP/
EJECT

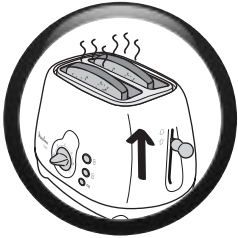

4 REHEAT

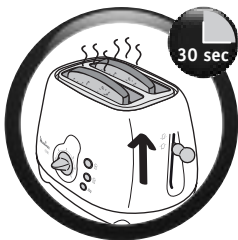
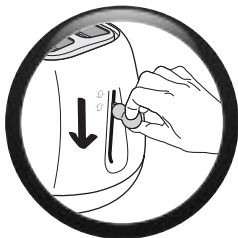

5 DEFROST

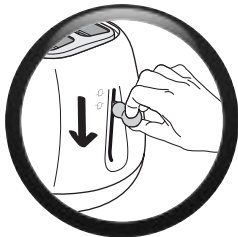

6 CLEANING

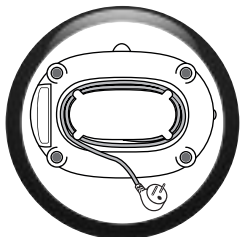
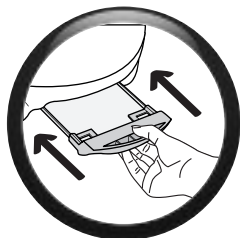
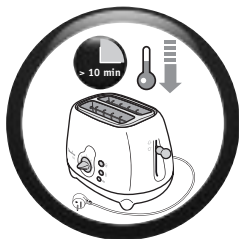

7 DO NOT

