

Radio / CD

## Casablanca CD50

Installation instructions  
Notice de montage  
Instrucciones de instalación  
Instruções de montagem



 **BLAUPUNKT**

# Installation instructions • Notice de montage • Instrucciones de instalación • Instruções de montagem

## **Safety instructions**

**When carrying out installation work and making connections please observe the following safety instructions:**

- Disconnect the negative terminal of the battery! When doing so, please observe the vehicle manufacturer's safety instructions.
- Make sure you do not damage vehicle components when drilling any holes.
- The cross sections of the positive and negative cables must not be less than 1.5 mm<sup>2</sup>.
- Incorrect installation may cause interference with electronic vehicle systems or your car radio.
- Do **not** connect the vehicle's plug connectors to the radio!
- You can obtain the adapter cable required for your vehicle type from any BLAUPUNKT dealer.

## **Consignes de sécurité**

**Respecter les consignes de sécurité suivantes pendant la durée du montage et du branchement.**

- Débrancher le pôle (-) de la batterie ! Respecter les consignes de sécurité du constructeur automobile !
- Veiller à n'endommager aucune pièce du véhicule en perçant des trous.

- La section du câble (+) et (-) ne doit pas dépasser 1,5 mm<sup>2</sup>.
- En cas d'erreur d'installation, des perturbations peuvent survenir dans les systèmes électroniques du véhicule ou dans votre autoradio.
- **Ne pas** brancher les connecteurs du véhicule sur la radio !
- Les câbles d'adaptation nécessaires pour le type de véhicule sont disponibles auprès des revendeurs BLAUPUNKT.

## **Normas de seguridad**

**Durante el montaje y la conexión es imprescindible observar las siguientes normas de seguridad.**

- Desemborne el polo negativo de la batería.  
Observe las normas de seguridad dadas por el fabricante del vehículo.
- Al perforar agujeros, asegúrese de no dañar ninguna pieza del vehículo.
- La sección transversal del cable positivo y del cable negativo no debe ser menor de 1,5 mm<sup>2</sup>.
- Una instalación incorrecta puede provocar perturbaciones en los sistemas electrónicos del vehículo o en la radio.
- ¡**No** conecte a la radio los conectores ubicados en el vehículo!

- Los cables adaptadores necesarios para su vehículo los encontrará en el comercio especializado en artículos de la marca BLAUPUNKT.

**P** **⚠ Instruções de segurança**

**Durante a montagem e a ligação do aparelho, queira respeitar as seguintes instruções de segurança.**

- Separar o pólo negativo da bateria! Respeitar ao mesmo tempo as instruções de segurança do fabricante do automóvel.
- Quando se procede à furagem de buracos, prestar atenção para não serem danificadas quaisquer partes do veículo.
- As secções transversais dos cabos positivo e negativo não devem ser inferiores a 1,5 mm<sup>2</sup>.
- Se a montagem for executada de forma incorrecta podem ocorrer avarias nos sistemas electrónicos do automóvel ou no seu auto-rádio.
- **Não** ligar as fichas existentes do lado do automóvel ao auto-rádio!
- Os cabos adaptadores necessários para o seu automóvel podem ser adquiridos nos revendedores da BLAUPUNKT.

**Supplied Mounting Hardware**  
**Materiel de montage fourni**  
**Ferreteria de montaje**  
**suministrada**

**Elementos de fixação**  
**fornecidos.**

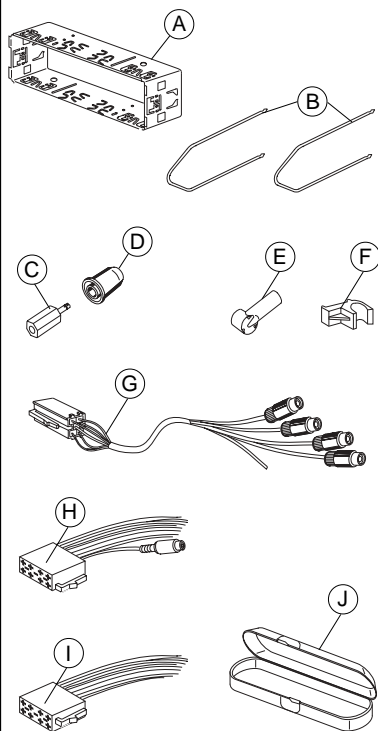

1.

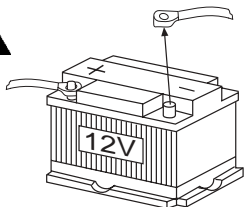

Adaptador específico del vehículo, el cual se puede adquirir en el comercio especializado.

Cabo de adaptação específico do automóvel que pode ser adquirido no comércio especializado.

2.

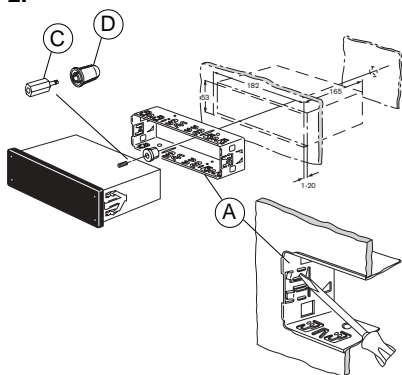

4.

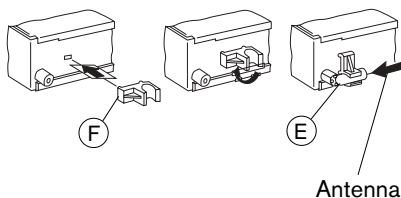

5.

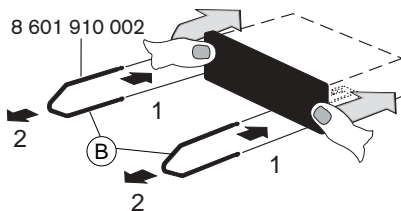

3.

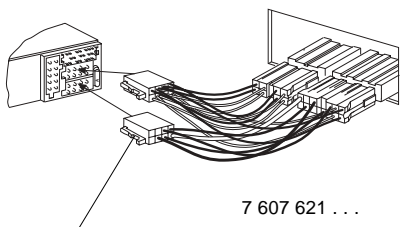

6.

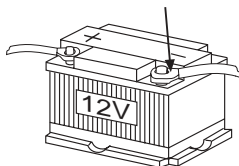

Car-specific adapter cable which is available at your dealer.

Câble adaptateur spécifique au véhicule, disponible dans le commerce.

7.

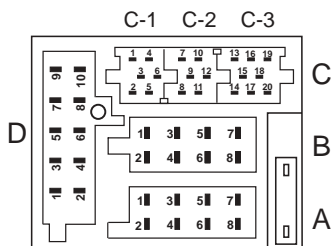

A		B	
1	Automatic Sound	1	Speaker out RR+
2	Radio Mute	2	Speaker out RR-
3	Sub out	3	Speaker out RF+
4	Permanent +12V	4	Speaker out RF-
5	Aut. antenna	5	Speaker out LF+
6	Illumination	6	Speaker out LF-
7	Kl.15/Ignition	7	Speaker out LR+
8	Ground	8	Speaker out LR-

D	
1	AUX 2- NF L
2	AUX 2- NF R
3	AUX 2- REF
4	NC
5	NC
6	NC
7	NC
8	NC
9	NC
10	NC

C					
C1		C2		C3	
1	Line Out LR	7	Telefon / Navi NF in +	13	Bus - In
2	Line Out RR	8	Telefon / Navi NF in -	14	Bus - Out
3	Line Out Masse / Ground	9	Radio / Navi Mute	15	Permanent +12V
4	Line Out LF	10	⚡ FB +12V / RC +12V	16	⚡ +12V
5	Line Out RF	11	Fernbedienung / Remote Control	17	Bus - Masse / GND
6	⚡ +12V Amplifier	12	FB - Masse / RC - GND	18	AF - Masse / GND
				19	Line In - L
				20	Line In - R

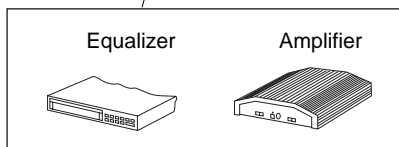

Remote Control



CD-Changer

8.

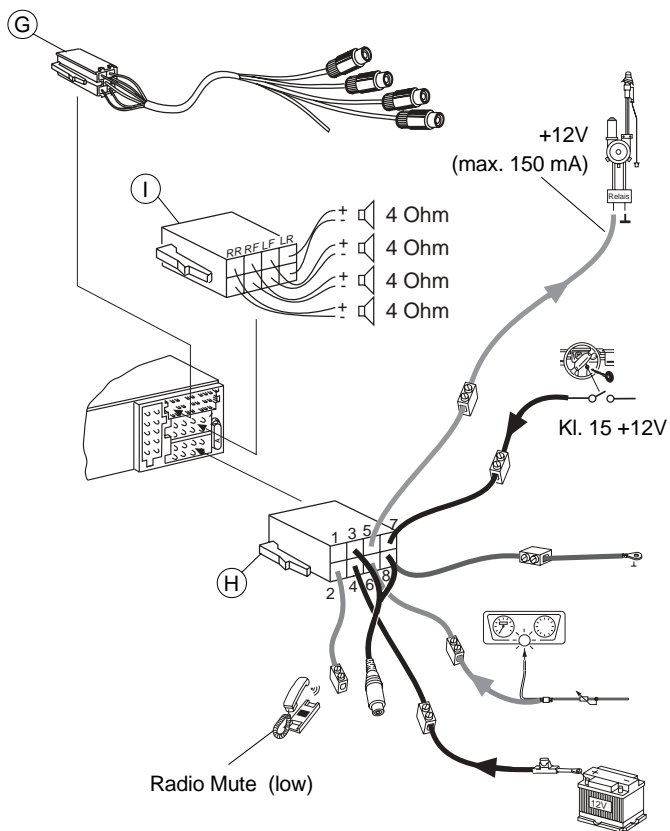

This information is subject to change without notice!

Sous réserve de modifications!

Modificaciones reservadas!

Sob reserva de alterações!