

SONY

2-319-512-12(1)

Digital Video Camera Recorder

HANDYCAM®

Operating Guide

DCR-HC47E/HC48E

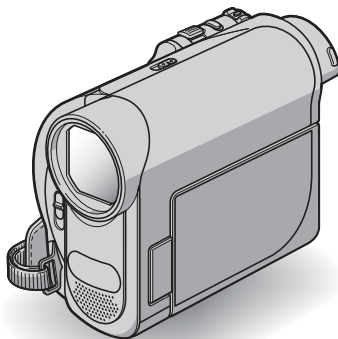

Getting Started 7



Recording/
Playback 16

Using the Menu 30

Dubbing/Editing 51

Using a Computer 59

Troubleshooting 63

Additional Information 73

Quick Reference 85

Mini DV Digital
Video
Cassette

MEMORY STICK™

InfoLITHIUM™ H
SERIES

Read this first

Before operating the unit, please read this manual thoroughly, and retain it for future reference.

WARNING

To reduce fire or shock hazard, do not expose the unit to rain or moisture.



CAUTION

Replace the battery with the specified type only. Otherwise, fire or injury may result.

FOR CUSTOMERS IN THE UNITED KINGDOM

NOTICE ON THE SUPPLIED AC ADAPTOR

A moulded plug complying with BS 1363 is fitted to this equipment for your safety and convenience.

Should the fuse in the plug supplied need to be replaced, a fuse of the same rating as the supplied one and approved by ASTA or BSI to BS 1362, (i.e., marked with an  or  mark) must be used.

If the plug supplied with this equipment has a detachable fuse cover, be sure to attach the fuse cover after you change the fuse. Never use the plug without the fuse cover. If you should lose the fuse cover, please contact your nearest Sony service station.

FOR CUSTOMERS IN EUROPE

ATTENTION

The electromagnetic fields at the specific frequencies may influence the picture and sound of this camcorder.

This product has been tested and found compliant with the limits set out in the EMC Directive for

using connection cables shorter than 3 meters (9.8 feet).

Notice

If static electricity or electromagnetism causes data transfer to discontinue midway (fail), restart the application or disconnect and connect the communication cable (USB, etc.) again.



Disposal of Old Electrical & Electronic Equipment (Applicable in the European Union and other European countries with separate collection systems)

This symbol on the product or on its packaging indicates that this product shall not be treated as household waste. Instead it shall be handed over to the applicable collection point for the recycling of electrical and electronic equipment. By ensuring this product is disposed of correctly, you will help prevent potential negative consequences for the environment and human health, which could otherwise be caused by inappropriate waste handling of this product. The recycling of materials will help to conserve natural resources.

For more detailed information about recycling of this product, please contact your local Civic Office, your household waste disposal service or the shop where you purchased the product.

Applicable Accessory: Remote Commander

Notes on use

Your camcorder is supplied with two kinds of manuals

- “Operating Guide” (This manual)
- “First Step Guide” for connecting the camcorder to a computer and using the supplied software (stored on the supplied CD-ROM)

Type of cassette you can use in your camcorder

You can use mini DV cassettes marked with **Mini DV**. Your camcorder is not compatible with the Cassette Memory function (p. 73).

Types of “Memory Stick” you can use in your camcorder

You can use “Memory Stick Duo” marked with **MEMORY STICK DUO** or **MEMORY STICK PRO DUO** (p. 74).

“Memory Stick Duo”
(This size can be used with your camcorder.)



“Memory Stick”
(You cannot use with your camcorder.)



- You cannot use any type of memory card except “Memory Stick Duo.”
- “Memory Stick PRO” and “Memory Stick PRO Duo” can be used only with “Memory Stick PRO” compatible equipment.
- Do not attach a label or the like on a “Memory Stick Duo” or a Memory Stick Duo adaptor.

When using a “Memory Stick Duo” with “Memory Stick” compatible equipment

Be sure to insert the “Memory Stick Duo” into the Memory Stick Duo Adaptor.

Memory Stick Duo Adaptor



Using the camcorder

- Do not hold the camcorder by the following parts.

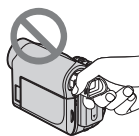

Viewfinder

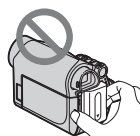

Battery pack



LCD panel

- The camcorder is not dustproof, dripproof or waterproof.
See “On use and care” (p. 78).
- Before connecting your camcorder to another device with a USB or i.LINK cable, be sure to insert the connector plug the correct way, and not forcibly, to avoid damaging the terminal or cause a malfunction of your camcorder.
- Connect the A/V connecting cable to the A/V OUT jack of the Handycam Station when using your camcorder attached to the Handycam Station to output audio and video signals.
- Disconnect the AC Adaptor from the Handycam Station holding both the Handycam Station and the DC plug.
- Be sure to slide the POWER switch to OFF (CHG) when you insert the camcorder into the Handycam Station or remove the camcorder from it.

About menu items, LCD panel, viewfinder, and lens

- A menu item that is grayed out is not available under the current recording or playback conditions.
- The LCD screen and the viewfinder are manufactured using extremely high-precision technology, so over 99.99% of the pixels are operational for effective use. However, there may be some tiny black points and/or bright points (white, red, blue, or green in color) that appear constantly on the LCD screen and the viewfinder. These points are normal results of the manufacturing process and do not affect the recording in any way.

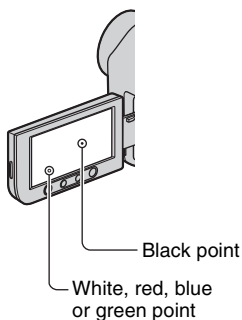

- Exposing the LCD screen, the viewfinder, or the lens to direct sunlight for long periods of time may cause malfunctions.
- Do not aim at the sun. Doing so might cause your camcorder to malfunction. Take pictures of the sun only in low light conditions, such as at dusk.

About changing the language setting

- The on-screen displays in each local language are used for illustrating the operating procedures. Change the screen language before using your camcorder if necessary (p. 12).

On recording

- Before starting to record, test the recording function to make sure the picture and sound are recorded without any problems.
- Compensation for the contents of recordings cannot be provided, even if recording or playback is not possible due to a malfunction of the camcorder, storage media, etc.
- TV color systems differ depending on the country/region. To view your recordings on a TV, you need a PAL system-based TV.
- Television programs, films, video tapes, and other materials may be copyrighted. Unauthorized recording of such materials may be contrary to the copyright laws.

About this manual

- The images of the LCD screen and the viewfinder used in this manual for illustration purposes are captured using a digital still camera, and therefore may appear different.
- The illustrations used on this manual are based on the model DCR-HC48E. The model name is indicated on the bottom of your camcorder.
- Design and specifications of recording media and accessories are subject to change without notice.

About the Carl Zeiss lens

- Your camcorder is equipped with a Carl Zeiss lens, which was developed jointly by Carl Zeiss, in Germany, and Sony Corporation, and produces superior images. It adopts the MTF measurement system for video cameras and offers a quality typical of a Carl Zeiss lens. MTF= Modulation Transfer Function. The number value indicates the amount of light from a subject coming into the lens.

Table of Contents

Read this first	2
-----------------------	---

Getting Started

Step 1: Checking supplied items	7
Step 2: Charging the battery pack	8
Step 3: Turning the power on and setting the date and time	11
Changing the language setting ...	12
Step 4: Making setting adjustments before recording	12
Step 5: Inserting a tape or a "Memory Stick Duo"	14



Recording/Playback

Easy Recording/Playback (Easy Handycam)	16
Recording	18
Zooming	20
Recording in dark places (NightShot plus)	20
Adjusting the exposure for backlit subjects	21
Recording in mirror mode	21
Selecting the aspect ratio (16:9 or 4:3) of the recording picture	21
Playback	22
Using PB zoom	24
Using the guide functions (USAGE GUIDE)	24
Searching for the starting point	25
Searching for the last scene of the most recent recording (END SEARCH)	25
Searching manually (EDIT SEARCH)	26
Reviewing the most recently recorded scenes (Rec review)	26
Searching quickly for a desired scene (Zero set memory)	26

Searching for a scene by date of recording (Date search)	27
Playing the picture on a TV	28

Using the Menu

Using the menu items	30
Menu items	31
CAMERA SET menu	33
Settings to adjust your camcorder to the recording conditions	
MEMORY SET menu	38
Settings for the "Memory Stick Duo"	
PICT.APPLI. menu	40
Special effects on pictures or additional functions on recording/playback	
EDIT/PLAY menu	44
Settings for editing or playing back in various modes	
STANDARD SET menu	46
Settings while recording on a tape or other basic settings	
TIME/LANGU. menu	49
Customizing Personal Menu	49

Dubbing/Editing

Dubbing to VCR or DVD/HDD recorders	51
Recording pictures from a VCR, etc. (DCR-HC48E)	53
Dubbing pictures from a tape to a "Memory Stick Duo"	55
Deleting recorded pictures from the "Memory Stick Duo"	55
Marking images on the "Memory Stick Duo" with specific information (Print mark/Image protection)	56
Printing recorded images (PictBridge compliant printer)	57

Using a Computer

What you can do with Windows computer	59
Installing the “First Step Guide” and software	60
Viewing “First Step Guide”	62
Using a Macintosh computer	62

Troubleshooting

Troubleshooting	63
Warning indicators and messages	70

Additional Information

Using your camcorder abroad	73
Maintenance and precautions	73
Usable cassette tapes	73
About the “Memory Stick”	74
About the “InfoLITHIUM” battery pack	76
About i.LINK	77
On using your camcorder	78
Specifications	82

Quick Reference

Identifying parts and controls	85
Indicators displayed during recording/playback	89
Index	92

Step 1: Checking supplied items

Make sure that you have following items supplied with your camcorder. The number in the parentheses indicates the number of that item supplied.

AC Adaptor (1) (p. 8)

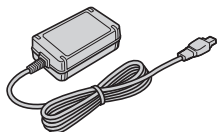

Mains lead (1) (p. 8)

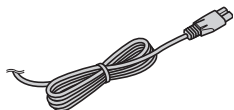

Handycam Station (1) (p. 8, 88)

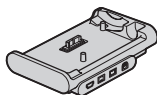

Wireless Remote Commander (1) (p. 88)



A button-type lithium battery is already installed.

A/V connecting cable (1) (p. 28, 51)



USB cable (1) (p. 57)

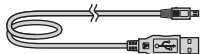

Rechargeable battery pack NP-FH40 (1)
(p. 8, 76)

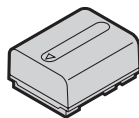

CD-ROM "Handycam Application Software" (1) (p. 59)

21-pin adaptor (1) (p. 29)

For the models with the  mark printed on their bottom surfaces only.

Operating Guide (This manual) (1)

Step 2: Charging the battery pack

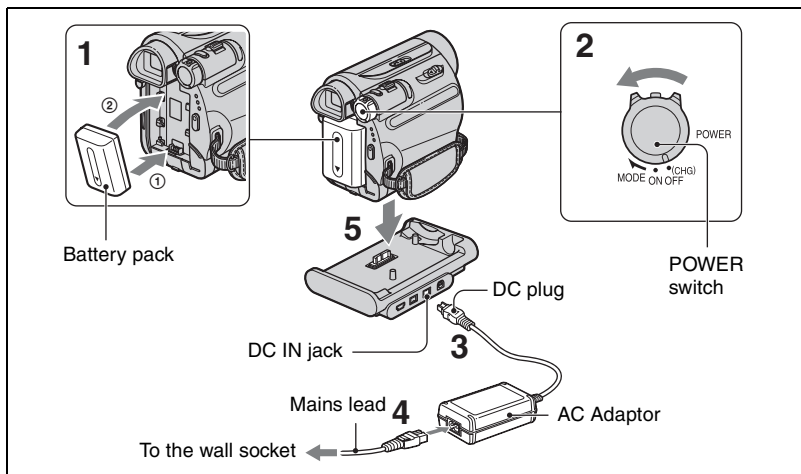

You can charge the “InfoLITHIUM” battery pack (H series) (p. 76) after attaching it to your camcorder.

Notes

- You cannot attach any “InfoLITHIUM” battery pack other than the H series to your camcorder.

1 Align the terminals of the battery pack and your camcorder (①), then attach the battery pack and click it into place (②).

2 Slide the POWER switch to OFF (CHG) (The default setting).

3 With the ▲ mark on the DC plug facing up, connect the AC Adaptor to the DC IN jack on the Handycam Station.

4 Connect the mains lead to the AC Adaptor and the wall socket.

5 Insert the camcorder into the Handycam Station securely, all the way to the bottom.

The CHG (charge) lamp lights up and charging starts. The CHG (charge) lamp turns off when the battery is fully charged. Remove your camcorder from the Handycam Station.

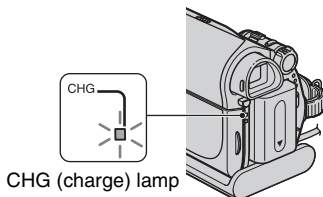

Notes

- When inserting the camcorder into the Handycam Station, close the DC IN jack cover.
- Disconnect the AC Adaptor from the DC IN jack holding both the Handycam Station and the DC plug.

To charge the battery pack using only the AC Adaptor

Turn off the power, then connect the AC Adaptor to the DC IN jack on your camcorder.

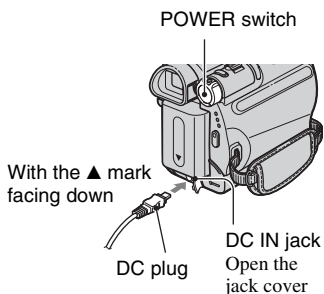

Tips

- You can operate your camcorder connected to a power source such as a wall socket as shown in the illustration. The battery pack will not lose its charge in this case.

To remove your camcorder from the Handycam Station

Turn off the power, then remove the camcorder from the Handycam Station holding both your camcorder and the Handycam Station.

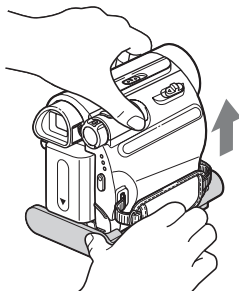

To remove the battery pack

- ① Turn off the power, then press PUSH.
- ② Remove the battery pack in the direction of the arrow.

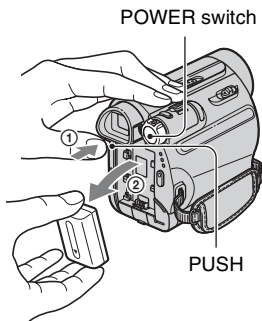

When storing the battery pack

Fully discharge the battery before storing it for an extended period (p. 77).

Step 2: Charging the battery pack (Continued)

To check the remaining battery (Battery Info)

Set the POWER switch to OFF (CHG), then press DISP/BATT INFO.

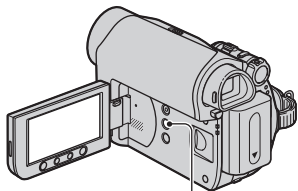

DISP/BATT INFO button

After a while, the approximate recordable time and battery information appear for about 7 seconds. You can view the battery information for up to 20 seconds by pressing DISP/BATT INFO again while the information is displayed.

Remaining battery (approx.)

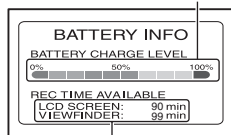

Recording capacity (approx.)

You can check the remaining battery charge on the LCD screen.

Indicator	Status
	Sufficient power remaining
	Battery low, recording/playback will stop soon.
	Replace the battery with a fully charged one, or charge the battery.

Charging time

Approximate time (min.) required when you fully charge a fully discharged battery pack.

Battery pack	Charging time
NP-FH40 (supplied)	125
NP-FH50	135
NP-FH70	170
NP-FH100	390

Recording time

Approximate time (min.) available when you use a fully charged battery pack.

Battery pack	Continuous recording time	Typical recording time*
NP-FH40 (supplied)	100	50
	110	55
	110	55
NP-FH50	115	55
	130	65
	130	65
NP-FH70	245	120
	280	140
	280	140
NP-FH100	565	280
	635	315
	635	315

* Typical recording time shows the time when you repeat recording start/stop, turning the power on/off and zooming.

Notes

- All times measured under the following conditions:
 - Top: When the LCD backlight turns on.
 - Middle: When the LCD backlight turns off.
 - Bottom: Recording with viewfinder while the LCD panel closed.

Playing time

Approximate time (min.) available when you use a fully charged battery pack.

Battery pack	LCD panel opened*	LCD panel closed
NP-FH40 (supplied)	120	150
NP-FH50	140	170

Battery pack	LCD panel opened*	LCD panel closed
NP-FH70	300	370
NP-FH100	695	845

* When the LCD backlight turns on.

On the battery pack

- Before changing the battery pack, slide the POWER switch to OFF (CHG).
- The CHG (charge) lamp flashes during charging, or the Battery Info (p. 10) will not be correctly displayed under the following conditions.
 - The battery pack is not attached correctly.
 - The battery pack is damaged.
 - The battery pack is worn-out (for Battery Info only).
- The power will not be supplied from the battery as long as the AC Adaptor is connected to the DC IN jack of your camcorder or the Handycam Station, even when the mains lead is disconnected from the wall socket.

On the charging/recording/playback time

- Times measured with the camcorder at 25°C (77°F), (10°C - 30°C (50°F - 86°F) is recommended.)
- The recording and playback time will be shorter when you use your camcorder in low temperatures.
- The recording and playback time will be shorter depending on the conditions under which you use your camcorder.

On the AC Adaptor

- Use the nearby wall socket when using the AC Adaptor. Disconnect the AC Adaptor from the wall socket immediately if any malfunction occurs while using your camcorder.
- Do not use the AC Adaptor placed in a narrow space, such as between a wall and furniture.
- Do not short-circuit the DC plug of the AC Adaptor or battery terminal with any metallic objects. This may cause a malfunction.
- Even if your camcorder is turned off, AC power (mains) is still supplied to it while connected to the wall socket via the AC Adaptor.

Step 3: Turning the power on and setting the date and time

Set the date and time when using this camcorder for the first time. If you do not set the date and time, the [CLOCK SET] screen appears every time you turn on your camcorder or change the POWER switch position.

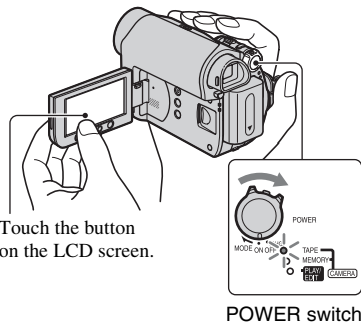

- 1 While pressing the green button, slide the POWER switch in the direction of the arrow to turn on the respective lamp.

CAMERA-TAPE: To record on a tape.

CAMERA-MEMORY: To record on a “Memory Stick Duo.”

PLAY/EDIT: To play or edit pictures.

The [CLOCK SET] screen appears.

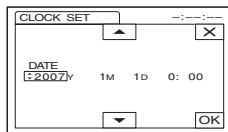

- 2 Set [Y] (year) with \uparrow/\downarrow , then touch [OK].

You can set any year up to the year 2079.

Step 3: Turning the power on and setting the date and time (Continued)

- 3** Set [M] (month), then touch **OK** and repeat for [D] (day), hour and minute.

The clock starts.

To turn off the power

Slide the POWER switch to OFF (CHG).

To reset the date and time

You can set the desired date and time by touching **P-MENU** → [MENU] → **⌚** (TIME/LANGU.) → [CLOCK SET] (p. 30).

Notes

- If you do not use your camcorder for **about 3 months**, the built-in rechargeable battery gets discharged and the date and time settings may be cleared from the memory. In that case, charge the rechargeable battery and then set the date and time again (p. 81).
- At the time of purchase, the power is set to turn off automatically if you leave your camcorder without any operation attempted for approximately 5 minutes, to save battery power ([A.SHUT OFF], p. 48).

Tips

- The date and time are not displayed while recording, but they are automatically recorded on the tape, and can be displayed during playback (see page 47 for [DATA CODE] (During Easy Handycam operation, you can set only [DATE/TIME])).
- If the buttons on the touch panel do not work correctly, adjust the touch panel (CALIBRATION) (p. 79).

Changing the language setting

You can change the on-screen displays to show messages in a specified language. Touch **P-MENU** → [MENU] → **⌚** (TIME/LANGU.) → [LANGUAGE], then select the desired language.

Step 4: Making setting adjustments before recording

Opening the lens cover

Slide the LENS COVER switch to OPEN.



After recording, set the LENS COVER switch to CLOSE, to close the lens cover.

The LCD panel

Open the LCD panel 90 degrees to the camcorder (①), then rotate it to the best angle to record or play (②).

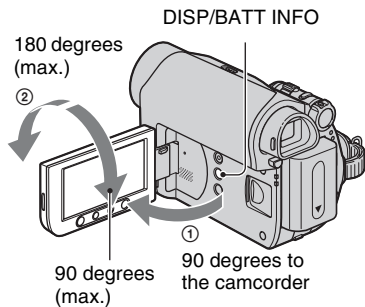

To turn off the LCD backlight to make the battery last longer

Press and hold DISP/BATT INFO for a few seconds until **⏻** appears.

This setting is practical when you use your camcorder in bright conditions or where you want to save battery power. The recorded picture will not be affected by the setting. To turn on the LCD backlight, press and hold DISP/BATT INFO for a few seconds until **⏻** disappears.

Notes

- Do not press the buttons on the LCD frame accidentally when you open or adjust the LCD panel.

Tips

- If you rotate the LCD panel 180 degrees to the lens side, you can close the LCD panel with the LCD screen facing out. This is convenient during playback operations.
- See [LCD/VF SET] - [LCD BRIGHT] (p. 47) to adjust the brightness of the LCD screen.
- Press DISP/BATT INFO to toggle the screen indicators (such as Battery Info) on or off.

The viewfinder

You can view pictures using the viewfinder to avoid wearing down the battery, or when the picture seen on the LCD screen is poor.

Viewfinder

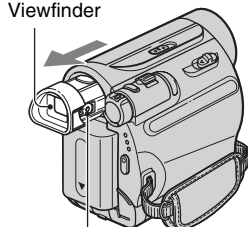

Viewfinder lens adjustment lever
Move it until the picture is clear.

Tips

- You can adjust the brightness of the viewfinder backlight by selecting [LCD/VF SET] - [VF B.LIGHT] (p. 47).

The grip belt

Fasten the grip belt and hold your camcorder correctly.

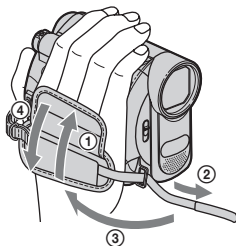

Step 5: Inserting a tape or a “Memory Stick Duo”

Cassette tape

You can use mini DV **Mini DV** cassettes only (p. 73).

- 1 Slide and hold the **OPEN/EJECT** lever in the direction of the arrow and open the lid.

OPEN/EJECT lever

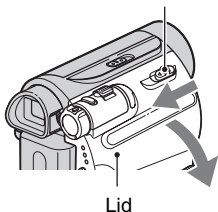

Lid

The cassette compartment automatically comes out and opens up.

- 2 Insert a cassette with its window facing outwards, then press **[PUSH]**.

Push the center of the back of the cassette lightly.

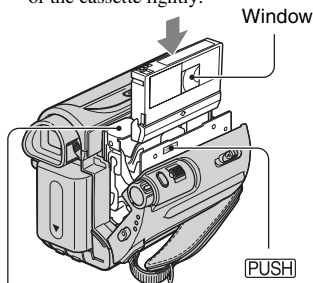

Cassette compartment

The cassette compartment automatically slides back in.

Notes

- Do not force the cassette compartment closed by pressing the portion marked **[DO NOT PUSH]** while it is sliding in. It may cause a malfunction.

- 3 Close the lid.

To eject the cassette

Open the lid following the same procedure as described in step 1 and remove the cassette.

Tips

- The recordable time varies depending on **[REC MODE]** (p. 46).

“Memory Stick Duo”

You can use only a “Memory Stick Duo” marked with **MEMORY STICK DUO** or **MEMORY STICK PRO DUO** (p. 74).

1 Open the LCD panel.

2 Insert the “Memory Stick Duo” into the “Memory Stick Duo” slot in the right direction until it clicks.

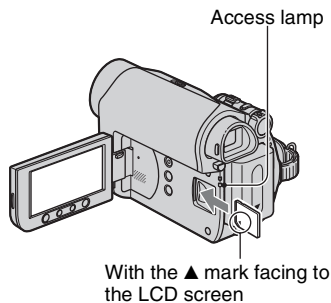

To eject a “Memory Stick Duo”

Lightly push in once and slide out the “Memory Stick Duo” alongside the camcorder body.

⚡ Notes

- When the access lamp is lit or flashing, your camcorder is reading/writing data. Do not shake or knock your camcorder, turn the power off, eject the “Memory Stick Duo,” or remove the battery pack. Otherwise, image data may be damaged.
- If you force the “Memory Stick Duo” into the slot in the wrong direction, the “Memory Stick Duo,” the “Memory Stick Duo” slot, or image data may be damaged.
- Do not remove the “Memory Stick Duo” forcibly with the fingers as it may be damaged.

- When inserting or ejecting the “Memory Stick Duo,” be careful that the “Memory Stick Duo” does not pop out and drop.

💡 Tips

- The number of recordable pictures varies depending on the image quality or the image size. For details, see page 38.



Easy Recording/Playback (Easy Handycam)

With this Easy Handycam operation, most of the camera settings are automatically optimally adjusted, which frees you from detailed adjustments. The screen font size increases for easy viewing.

Open the lens cover (p. 12).

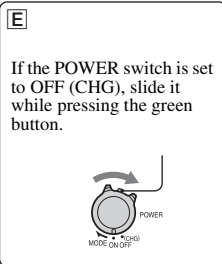
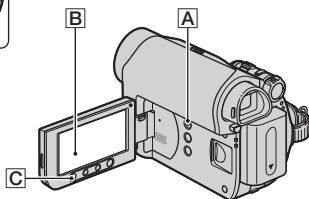
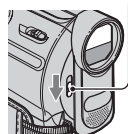

Movies



- 1** Slide the **POWER** switch **E** to turn on the **CAMERA-TAPE** lamp.



- 2** Press **EASY** **A**.



EASY

EASY appears on the screen **B**.

- 3** Press **REC START/STOP** **F** (or **C**) to start recording.*

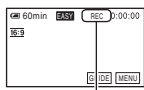

The indicator changes from [STBY] to [REC].

To stop recording, press REC START/STOP again.

Still images (4:3)



- 1** Slide the **POWER** switch **E** to turn on the **CAMERA-MEMORY** lamp.



- 2** Press **EASY** **A**.



EASY

EASY appears on the screen **B**.

- 3** Press **PHOTO** **D** to record.**

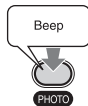

Flashing → Lit



Press and hold lightly to adjust the focus. Press fully to record.

* Movies are recorded in SP (Standard Play) mode on a cassette.

** Still images are recorded in [FINE] quality on a "Memory Stick Duo."

Playing back movies/still images

Slide the **POWER** switch **E** to turn on the **PLAY/EDIT** lamp. Touch the buttons on the screen **B** as follows.



Movies

Touch **◀◀**, then touch **▶▶** to start playback.



- A** GUIDE (p. 24)
- B** Rewind/Fast forward
- C** Stop
- D** Play/Pause toggles

Still images

Touch **MEMORY** → **-** / **+** to select a picture.

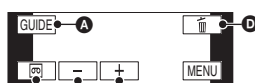

- A** GUIDE (p. 24)
- B** Tape playback
- C** Previous/Next
- D** Delete (p. 55)

■ To cancel Easy Handycam operation

Press **EASY** **A** again. **EASY** disappears from the screen.

■ Adjustable menu settings during Easy Handycam operation

Touch **[MENU]** to display adjustable menu settings. See page 30 for details on settings.

- Almost all the settings return to their defaults automatically (p. 31).
- **[P-MENU]** is not displayed during Easy Handycam operation.
- Cancel Easy Handycam operation if you want to add any effects or settings to the images.

■ Unavailable buttons during Easy Handycam

During Easy Handycam operation, the following buttons are unavailable. [Invalid during Easy Handycam operation.] may appear if operations not available during Easy Handycam are attempted.

- **BACK LIGHT** button (p. 21)
- Pressing and holding **DISP/BATT INFO** button (p. 12)
- **WIDE SELECT** button (in the **CAMERA-MEMORY** mode) (p. 21)
- **PHOTO** button (in the **CAMERA-TAPE** mode) (p. 18)

Recording

Open the lens cover (p. 12).

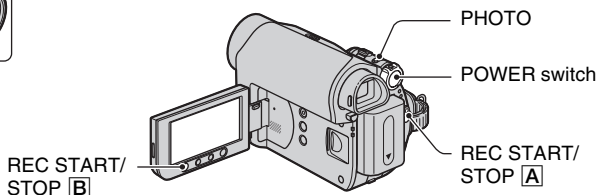
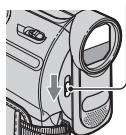

Recording movies



Movies are recorded on a tape.

- 1 Slide the **POWER** switch in the direction of the arrow repeatedly to turn on the **CAMERA-TAPE** lamp.

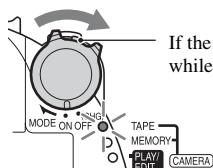

If the **POWER** switch is set to **OFF (CHG)**, slide it while pressing the green button.

- 2 Press **REC START/STOP [A]** (or **[B]**).

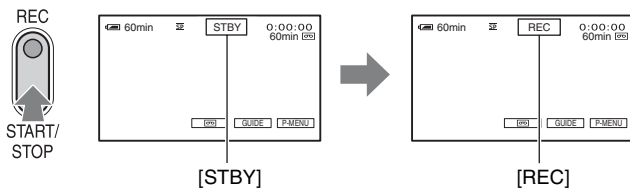

To stop recording, press **REC START/STOP** again.

⚡ Notes

- You cannot record movies onto a “Memory Stick Duo” using your camcorder.

💡 Tips

- While recording movies on a tape, or while in standby mode, you can record a still image on a “Memory Stick Duo” by pressing **PHOTO** fully. Still images will be fixed to image size [0.2M] in 16:9 screen or [VGA (0.3M)] in 4:3 screen (p. 38).

Recording still images



Still images are recorded on the “Memory Stick Duo.”

- 1 Slide the **POWER** switch in the direction of the arrow repeatedly to turn on the **CAMERA-MEMORY** lamp.

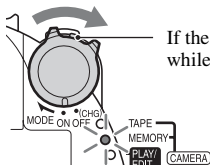

If the **POWER** switch is set to **OFF (CHG)**, slide it while pressing the green button.

- 2 Press and hold **PHOTO** lightly to adjust the focus, then press it fully.

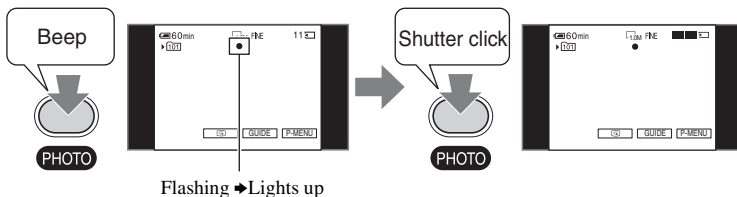

A shutter sound is heard. When **||||** disappears, the image has been recorded.

To check the latest recording on a “Memory Stick Duo”

Touch . To delete the picture, touch → [YES].

Tips

- See page 38 for details on the image quality, the image size or the number of recordable pictures.

Recording (Continued)

Zooming

You can magnify images up to 25 times the original size with the power zoom lever or the zoom buttons on the LCD frame.

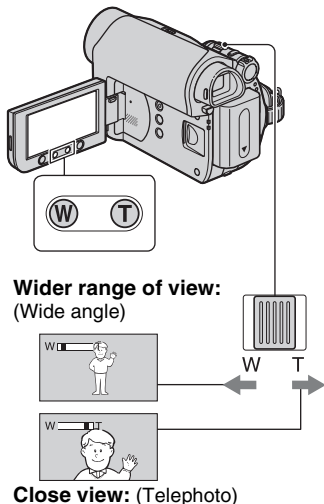

Move the power zoom lever slightly for a slower zoom. Move it further for a faster zoom.

Notes

- [STEADYSHOT] may not reduce image blurring as desired when the power zoom lever is set to the T (Telephoto) side.
- Be sure to keep your finger on the power zoom lever. If you move your finger off the power zoom lever, the operation sound of the power zoom lever may also be recorded.
- You cannot change the zoom speed with the zoom buttons on the LCD frame.
- The minimum possible distance between camcorder and subject while maintaining sharp focus is about 1 cm (about 13/32 in.) for wide angle and about 80 cm (about 2 5/8 feet) for telephoto.

Tips

- You can set [DIGITAL ZOOM] (p. 37) if you want to zoom to a level greater than 25 x.

Recording in dark places (NightShot plus)

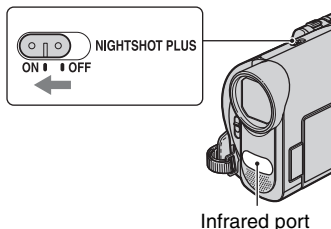

Set the NIGHTSHOT PLUS switch to ON. ([RECORD] and ["NIGHTSHOT PLUS"] appears.)

Notes

- The NightShot plus and Super NightShot plus functions use infrared light. Therefore, do not cover the infrared port with your fingers or other objects. Remove the conversion lens (optional) if it is attached.
- Adjust the focus manually ([FOCUS], p. 35) when it is hard to focus automatically.
- Do not use the NightShot plus and Super NightShot plus functions in bright places. This may cause a malfunction.

Tips

- To record an image brighter, use Super NightShot plus function (p. 36). To record an image more faithfully to the original colors, use Color Slow Shutter function (p. 36).

Adjusting the exposure for backlit subjects

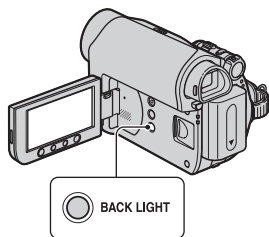

To adjust the exposure for backlit subjects, press BACK LIGHT to display . To cancel the back light function, press BACK LIGHT again.

Recording in mirror mode

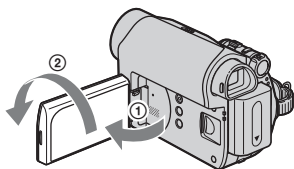

Open the LCD panel 90 degrees to the camcorder (1), then rotate it 180 degrees to the lens side (2).

Tips

- A mirror-image of the subject appears on the LCD screen, but the image will be normal when recorded.

Selecting the aspect ratio (16:9 or 4:3) of the recording picture

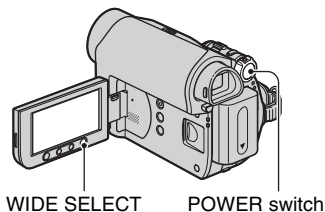

Selecting the aspect ratio for movies

- 1 Set the POWER switch to CAMERA-TAPE.
- 2 Press WIDE SELECT repeatedly to select the desired screen aspect ratio.



Tips

- Differences between 4:3 and 16:9 image views vary depending on the zoom position when recording.
- If you play back a picture on TV, set [TV TYPE] for playback in the aspect ratio of the TV (p. 29).
- When viewing pictures recorded in 16:9 aspect ratio with [TV TYPE] set to [4:3], pictures may appear rough depending on the subject (p. 29).

Selecting the aspect ratio for still images

- 1 Set the POWER switch to CAMERA-MEMORY. The aspect ratio of the picture switches to 4:3.
- 2 Press WIDE SELECT to select the desired screen aspect ratio.

Notes

- Still images will be fixed to image size [0.7M] () in the 16:9 (wide) mode. In the 4:3 mode, you can select up to [1.0M] ().

Tips

- For the number of recordable pictures, see page 38.

Playback

Slide the **POWER** switch in the direction of the arrow repeatedly to turn on the **PLAY/EDIT** lamp.

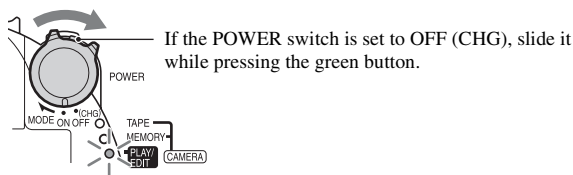

Playing movies





Touch , then touch  to start playback.

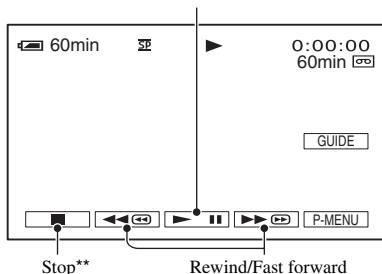

Toggles Play or Pause as you touch*



* Playback automatically stops if pause is engaged for more than 3 minutes.

**  is displayed instead of  when a "Memory Stick Duo" with recorded images is inserted and a tape is not being played.





To adjust the sound volume

Touch  → [VOLUME], then /[] to adjust the volume.

Tips

- If you cannot find [VOLUME] in , touch [MENU] (p. 30).

To search for a scene during playback

Touch and hold / during playback (Picture Search), or / while fast forwarding or rewinding the tape (Skip Scan).

Tips

- You can play back in various modes (, p. 44).



Touch **MEMORY**.

The most recently recorded image is displayed.

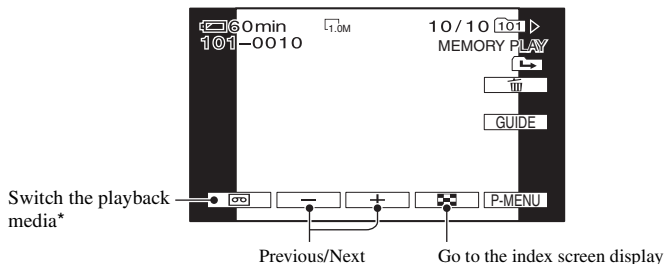

* **MEMORY** is displayed on the tape playback screen.

To display pictures on a “Memory Stick Duo” on the index screen

Touch . Touch one of the pictures to back to the single display mode.

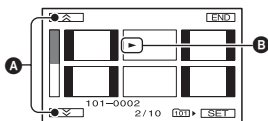

- A** Previous/Next 6 pictures
- B** The picture displayed before switching to the index screen.

To view pictures in other folders, touch → **SET** → **[PB FOLDER]**, select a folder with /, then touch **OK** (p. 40).

Using PB zoom

You can magnify the recorded picture from about 1.1 to 5 times the original size. Magnification can be adjusted with the power zoom lever or the zoom buttons on the LCD frame.

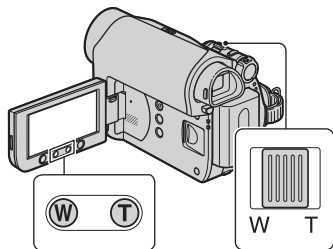

- 1 Play back the picture you want to magnify.
- 2 Magnify the picture with T (Telephoto). The screen is framed.
- 3 Touch the screen at the point you want to display in the center of the displayed frame.
- 4 Adjust the magnification with W (Wide angle)/T (Telephoto).

To cancel, touch [END].

Notes

- You cannot change the zoom speed with the zoom buttons on the LCD frame.

Using the guide functions (USAGE GUIDE)

You can easily select the desired setting screens by using the guide functions (USAGE GUIDE).

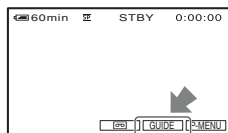



Your camcorder has 3 guide functions as shown below.

SHOOT GUIDE:	Takes you to the setting screens related to recording.
USEFUL GUIDE:	Takes you to the setting screens related to the basic operations.
DISP GUIDE:	Enables you to check the meaning of each indicator that appears on the LCD screen. See page 91 for details.

1 Touch [GUIDE].

2 Select the desired item.

e.g., to record night views

Touch [SHOOT GUIDE] → [SELECT SCENE] → / to display [To keep the mood of a night view].

3 Touch [SET].

The desired setting screen appears.

Adjust the settings according to your purpose.

Searching for the starting point

Unavailable settings during Easy Handycam

During Easy Handycam operation, some items are unavailable. If an attempted setting is not available, but still desired, touch [SET] to display an on-screen instruction. Follow the instruction to cancel Easy Handycam operation and then select the setting.

💡 Tips

- If [SET] is not displayed in step 3, follow the instruction on the screen.

Searching for the last scene of the most recent recording (END SEARCH)

[END SEARCH] will not work once you eject the cassette after you have recorded on the tape.

Make sure that the CAMERA-TAPE lamp lights up (p. 18).

Touch  → .

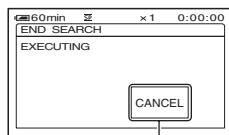

Touch here to cancel the operation.

The last scene of the most recent recording is played back for about 5 seconds, and the camcorder enters the standby mode at the point where the last recording has finished.

🔊 Notes

- [END SEARCH] will not work correctly when there is a blank section between recorded sections on the tape.

💡 Tips

- You can also select [END SEARCH] from the menu. When the PLAY/EDIT lamp lights up, select the [END SEARCH] short-cut in Personal Menu (p. 30).

Searching for the starting point (Continued)



Searching manually (EDIT SEARCH)

You can search for the start point to start the next recording while viewing the pictures on the screen. The sound is not played back during the search.

Make sure that the CAMERA-TAPE lamp lights up (p. 18).

1 Touch .



2 Touch and hold  /  (to go backward) /  (to go forward) and release it at the point where you want the recording to start.

Reviewing the most recently recorded scenes (Rec review)

You can view about 2 seconds of the scene recorded just before you stopped the tape.

Make sure that the CAMERA-TAPE lamp lights up (p. 18).

Touch  → .



The last 2 seconds (approx.) of the most recently recorded scene are played back. Then, your camcorder is set to standby.

Searching quickly for a desired scene (Zero set memory)

Make sure that the PLAY/EDIT lamp lights up (p. 22).

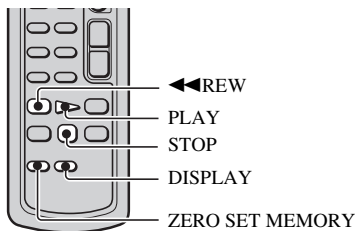

1 During playback, press **ZERO SET MEMORY** on the Remote Commander at a point you want to locate later on.

The tape counter is reset to "0:00:00" and  appears on the screen.

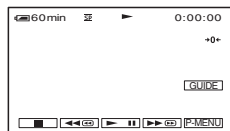

If the tape counter is not displayed, press **DISPLAY**.

2 Press **STOP** when you want to stop playback.

3 Press ◀◀REW.

The tape stops automatically when the tape counter reaches "0:00:00."

The tape counter returns to the time code display, and the zero set memory display disappears.

4 Press PLAY.

Playback starts from the point designated "0:00:00" on the tape counter.

To cancel the operation

Press ZERO SET MEMORY again before rewinding.

⚠ Notes

- There may be a discrepancy of several seconds between the time code and the tape counter.
- Zero set memory will not function correctly if there is a blank section between recorded sections on the tape.

Searching for a scene by date of recording (Date search)

You can locate the point where the recording date changes.

Make sure that the PLAY/EDIT lamp lights up (p. 22).

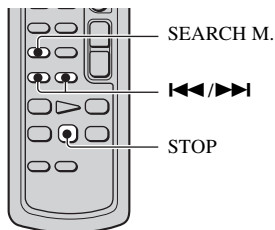

1 Press SEARCH M. on the Remote Commander.

2 Press ◀◀(previous)/▶▶(next) to select a recording date.



To cancel the operation

Press STOP.

⚠ Notes

- The Date search will not function correctly when there is a blank section between recorded sections on the tape.

Playing the picture on a TV

You can connect your camcorder to the input jack of a TV or a VCR using the A/V connecting cable (1) or the A/V connecting cable with S VIDEO (2). Connect your camcorder to the wall socket using the supplied AC Adaptor for this operation (p. 8). Refer also to the instruction manuals supplied with the devices to be connected.

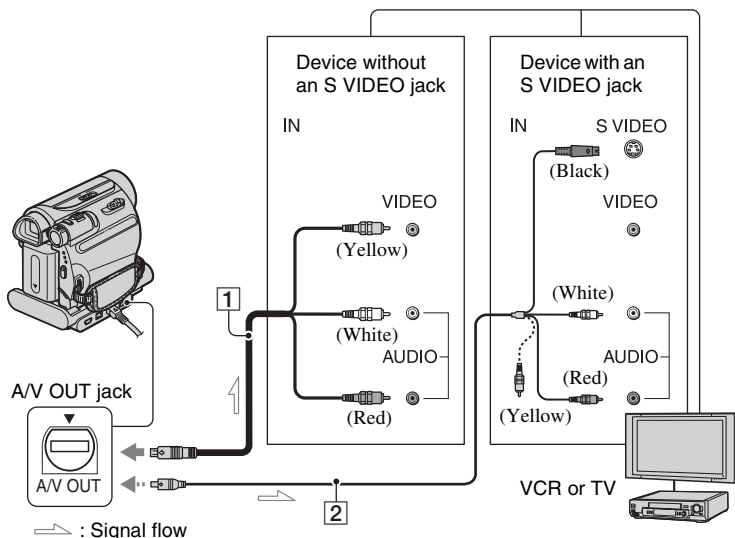

1 A/V connecting cable (supplied)

The Handycam Station and your camcorder are both equipped with A/V OUT jacks (p. 87, 88). Connect the A/V connecting cable either to the Handycam Station or to your camcorder, depending on your setup.

2 A/V connecting cable with S VIDEO (optional)

When connecting to another device via the S VIDEO jack, by using the A/V connecting cable with an S VIDEO cable, pictures can be reproduced more faithfully than with the supplied A/V cable connection.

Connect the white and red plugs (left/right audio) and S VIDEO plug (S VIDEO channel) of an A/V connecting cable. In this case, the yellow (standard video) plug connection is not necessary. S VIDEO connection only will not output audio.

Notes

- Do not connect A/V connecting cables to both the Handycam Station and your camcorder at the same time, as image disturbance may occur.

Tips

- You can display the time code on the TV screen by setting [DISP OUTPUT] to [V-OUT/PANEL] (p. 48).

When connecting your camcorder to a TV through a VCR

Connect your camcorder to the LINE IN input on the VCR. Set the input selector on the VCR to LINE (VIDEO 1, VIDEO 2, etc.), if the VCR has an input selector.

To set the aspect ratio according to the connected TV (16:9/4:3)

Change the aspect ratio of the image according to the screen size of your TV.

- ① Slide the POWER switch repeatedly to turn on the PLAY/EDIT lamp.
- ② Touch **P-MENU** → [MENU] →  (STANDARD SET) → [TV TYPE] → [16:9] or [4:3] → **OK**.

Notes

- When you set [TV TYPE] to [4:3], or when the picture's aspect ratio switches between 16:9 and 4:3, the image may jitter.
- On some 4:3 TVs, the still image recorded in 4:3 aspect ratio may not appear in full screen. This is not a malfunction.



- When you play back a picture recorded in 16:9 aspect ratio on a 4:3 TV not compatible with the 16:9 signal, set [TV TYPE] to [4:3].

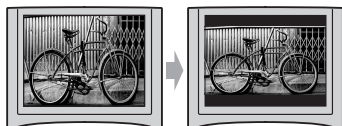

When your TV is monaural (Only one audio input jack)

Connect the yellow plug of the A/V connecting cable to the video input jack and connect the white (left channel) or the red (right channel) plug to the audio input jack of your TV or VCR.

If your TV/VCR has a 21-pin adaptor (EUROCONNECTOR)

You need the 21-pin adaptor to connect your camcorder to a TV for viewing recorded images. This adaptor is designed for output use only.

For the models with the **CE** mark printed on their bottom surfaces only.

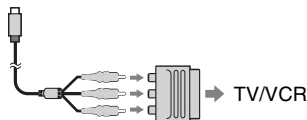

Using the menu items

- 1** Slide the **POWER** switch in the direction of the arrow repeatedly to turn on the respective lamp.

CAMERA-TAPE lamp:  settings on a tape

CAMERA-MEMORY lamp:  settings on a "Memory Stick Duo"

PLAY/EDIT lamp: settings for viewing/editing

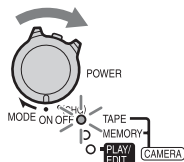

- 2** Touch the LCD screen to select the menu item.

Unavailable items will be grayed out.

■ To use the short-cuts of Personal Menu

On Personal Menu, short-cuts for frequently used menu items are added.



💡 Tips

- You can customize Personal Menu as you like (p. 49).

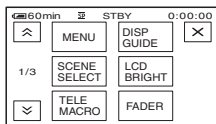
- ① Touch **P-MENU**.



- ② Touch the desired item.

If the desired item is not displayed on the screen, touch / until the item is displayed.



- ③ Select the desired setting, then touch **OK**.

■ To use menu items

You can customize menu items that are not added to Personal Menu.

- ① Touch **P-MENU** → **[MENU]**.

- ② Select the desired menu.

Touch / to select the item, then touch **OK**. (The process in step ③ is the same as that in step ②.)

- ③ Select the desired item.

You can also touch the item directly to select it.

- ④ Customize the item.

After finishing the settings, touch **OK** →  (close) to hide the menu screen.

If you decide not to change the setting, touch  to return to the previous screen.

■ To use menu items during Easy Handycam operation

P-MENU is not displayed during Easy Handycam operation. Touch **[MENU]** to display the menu index screen.

Menu items

Available menu items (●) vary depending on which lamp is lit. During Easy Handycam operation, the following settings are automatically applied (p. 16).

	TAPE	MEMORY	PLAY/EDIT	Easy Handycam
CAMERA SET menu (p. 33)				
SCENE SELECT	●	●	—	AUTO
SPOT METER	●	●	—	—
EXPOSURE	●	●	—	AUTO
WHITE BAL.	●	●	—	AUTO
AUTOSLW SHTR	●	—	—	ON
SPOT FOCUS	●	●	—	—
FOCUS	●	●	—	AUTO
TELE MACRO	●	●	—	OFF
SUPER NSPLUS	●	—	—	OFF
NS LIGHT	●	●	—	ON
COLOR SLOW S	●	—	—	OFF
SELF-TIMER	●*1	●	—	●*2
DIGITAL ZOOM	●	—	—	OFF
STEADYSHOT	●	—	—	ON
MEMORY SET menu (p. 38)				
STILL SET	—	●	●	OFF/FINE/●
ALL ERASE	—	—	●	●
FORMAT	—	●	●	—
FILE NO.	—	●	●	SERIES
NEW FOLDER	—	●	●	—
REC FOLDER	—	●	●	—*3
PB FOLDER	—	—	●	—*3
PICT.APPLI. menu (p. 40)				
FADER	●	—	—	OFF
SLIDE SHOW	—	—	●	—
D.EFFECT	●	—	●	OFF
PICT.EFFECT	●	—	●	OFF
SMTN INT.REC	●	—	—	—
INT.REC-STL	—	●	—	OFF
DEMO MODE	●	—	—	ON
PictBridge PRINT	—	—	●	—
USB SELECT	—	—	●	●

Menu items (Continued)

	TAPE	MEMORY	PLAY/EDIT	Easy Handycam
 EDIT/PLAY menu (p. 44)				
 VAR.SPD PB	—	—	●	—
 REC CTRL*4	—	—	●	—
AUD DUB CTRL	—	—	●	—
END SEARCH	●	—	●	—
 STANDARD SET menu (p. 46)				
 REC MODE	●	—	●*4	SP
AUDIO MODE	●	—	—	12BIT
VOLUME	—	—	●	●
AUDIO MIX	—	—	●	—
LCD/VF SET	●	●	●	—/NORMAL/—/NORMAL
TV TYPE	●	●	●	—*3
USB CAMERA	●	—	—	OFF
DISP GUIDE	●	●	●	●
DATA CODE	—	—	●	●
 REMAINING	●	—	●	AUTO
REMOTE CTRL	●	●	●	ON
BEEP	●	●	●	●
DISP OUTPUT	●	●	●	LCD PANEL
MENU ROTATE	●	●	●	—
A.SHUT OFF	●	●	●	5 min
CALIBRATION	—	—	●	—
 TIME/LANGU. menu (p. 49)				
CLOCK SET	●	●	●	●
WORLD TIME	●	●	●	—*3
LANGUAGE	●	●	●	—*3

*1 This setting is available only when recording a still image.

*2 The setting is displayed only when the POWER switch is set to CAMERA-MEMORY.

*3 The setting value before entering Easy Handycam operation will be retained.

*4 DCR-HC48E

CAMERA SET menu

Settings to adjust your camcorder to the recording conditions

The default settings are marked with ►. The indicators in parentheses appear when the items are selected.

See page 30 for details on selecting menu items.

SCENE SELECT

You can record pictures effectively in various situations with the SCENE SELECT function.

► AUTO

Select to automatically record pictures effectively without the [SCENE SELECT] function.

TWILIGHT* (☾)

Select to maintain the darkening atmosphere of the distant surroundings in twilight scenes.



CANDLE (🕯)

Select to maintain the dim atmosphere of a candlelit scene.



SUNRSE SUNSET* (Sunrise & Sunset) (☀)

Select to maintain the atmosphere of situations such as sunsets and sunrises.



FIREWORKS* (🎆)

Select to record all the splendor of fireworks.



LANDSCAPE* (🏞)

Select to shoot distant subjects clearly. This setting also prevents your camcorder from focusing on glass or metal mesh in windows between the camcorder and the subject.



PORTRAIT (Soft portrait) (👤)

Select to bring out the subject such as people or flowers while creating a soft background.



SPOTLIGHT** (🎤)

Select to prevent people's faces from appearing excessively white when subjects are lit by strong light.



SPORTS** (Sports lesson) (🏃)

Select to minimize shake when shooting fast moving subjects.



BEACH** (🏖)

Select to prevent people's faces from appearing dark in strong light or reflected light, such as at a beach in midsummer.



SNOW** (❄)

Select this when shooting in very bright, white conditions, such as on a ski slope; otherwise picture may appear too dark.



- * Adjusted to focus on subjects farther away only.
- ** Adjusted not to focus on subjects a short distance away.

SPOT METER (Flexible spot meter)

You can adjust and fix the exposure to the subject, so that it is recorded in suitable brightness even when there is strong contrast between the subject and the background, such as subjects in the spotlight on stage.

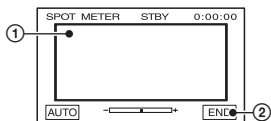

- ① Touch the point where you want to fix and adjust the exposure on the screen.
 ← → appears.
- ② Touch [END].

To return the setting to automatic exposure, touch [AUTO] → [END].

Notes

- If you set [SPOT METER], [EXPOSURE] is automatically set to [MANUAL].

EXPOSURE

You can fix the brightness of a picture manually. Adjust the brightness when the subject is too bright or too dark.

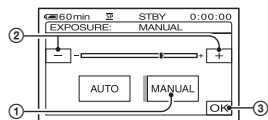

- ① Touch [MANUAL].
 ← → appears.
- ② Adjust the exposure by touching [-] / [+].

- ③ Touch [OK].

To return the setting to automatic exposure, touch [AUTO] → [OK].

Notes

- When you operate the POWER switch or change the [SCENE SELECT] setting, the brightness of a picture may be changed even if you adjusted it in [EXPOSURE].

WHITE BAL. (White balance)

You can adjust the color balance to the brightness of the recording environment.

AUTO

The white balance is adjusted automatically.

OUTDOOR (☀)

The white balance is appropriately adjusted for the following recording conditions:

- Outdoors
- Night views, neon signs and fireworks
- Sunrise or sunset
- Under daylight fluorescent lamps

INDOOR (💡)



The white balance is appropriately adjusted for the following recording conditions:

- Indoors
- At party scenes or studios where the lighting conditions change quickly
- Under video lamps in a studio, or under sodium lamps or incandescent-like color lamps



ONE PUSH (👉)

The white balance will be adjusted according to the ambient light.

- ① Touch [ONE PUSH].
- ② Frame a white object such as a piece of paper, to fill the screen under the same lighting conditions as you will shoot the subject.

- Touch [].
 flashes quickly. When the white balance has been adjusted and stored in the memory, the indicator stops flashing.

Notes

- Set [WHITE BAL.] to [AUTO] or [ONE PUSH] under white or cool white fluorescent lamps.
- When you select [ONE PUSH], keep framing white object while  is flashing quickly.
-  flashes slowly if [ONE PUSH] could not be set.
- When [ONE PUSH] was selected, if  keeps flashing after touching [OK], set [WHITE BAL.] to [AUTO].

Tips

- If you have changed the battery pack while [AUTO] was selected, or taken your camcorder outdoors after inside use with the [EXPOSURE] set (or vice versa), select [AUTO] and aim your camcorder at a nearby white object for about 10 seconds for better color balance adjustment.
- When the white balance has been set with [ONE PUSH], if you change the [SCENE SELECT] settings, or bring your camcorder outdoors from inside the house, or vice versa, you need to redo the [ONE PUSH] procedure to readjust the white balance.

AUTOSLW SHTR (Auto Slow Shutter)

When you set [AUTOSLW SHTR] to [ON], the shutter speed is slowed down automatically to 1/25 in dark places.

SPOT FOCUS

You can select and adjust the focal point to a subject not located in the center of the screen.

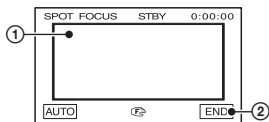

- Touch the subject on the screen.
 appears.
- Touch [END].

To adjust the focus automatically, touch [AUTO] → [END] in step ①.





Notes

- If you set [SPOT FOCUS], [FOCUS] is automatically set to [MANUAL].

FOCUS

You can adjust the focus manually. You can select this function also when you want to focus on a certain subject intentionally.



- Touch [MANUAL].
 appears.
- Touch  (focusing on close subjects)/  (focusing on distant subjects) to sharpen the focus.  appears when the focus cannot be adjusted any closer, and  appears when the focus cannot be adjusted farther away.
- Touch [OK].

To adjust the focus automatically, touch [AUTO] → [OK] in step ①.

Notes

- The minimum possible distance between camcorder and subject while maintaining sharp focus is about 1 cm (about 13/32 in.) for wide angle and about 80 cm (about 2 5/8 feet) for telephoto.

Tips

- It is easier to focus on the subject by moving the power zoom lever towards T (Telephoto) to adjust the focus, then towards W (Wide angle) to adjust the zoom for recording. When you want to record a subject at close range, move the power zoom lever to W (Wide angle), then adjust the focus.

TELE MACRO

This is useful to shoot small subjects, such as flowers or insects. You can blur out backgrounds and the subject stands out clearer.

When you set [TELE MACRO] to [ON] () , the zoom (p. 20) moves to the top of the T (Telephoto) side automatically and allows for recording subjects at a close distance, down to about 38 cm (15 in.).



To cancel, touch [OFF], or zoom to wide-angle (W side).

Notes

- When recording a distant subject, focusing may be difficult and can take some time.
- Adjust the focus manually ([FOCUS], p. 35) when it is hard to focus automatically.

SUPER NSPLUS (Super NightShot plus)

The picture will be recorded at a maximum of 16 times the sensitivity of NightShot plus recording if you set [SUPER NSPLUS] to [ON] while the NIGHTSHOT PLUS switch (p. 20) is also set to ON.

 and ["SUPER NIGHTSHOT PLUS"] appear on the screen.

To cancel the setting, set [SUPER NSPLUS] to [OFF] or set the NIGHTSHOT switch to OFF.

Notes

- Do not use NightShot plus/[SUPER NSPLUS] in bright places. This may cause a malfunction.
- Do not cover the infrared port with your fingers or other objects (p. 85).
- Remove the conversion lens (optional) if it is attached.
- Adjust the focus manually ([FOCUS], p. 35) when it is hard to focus automatically.

- The shutter speed of your camcorder changes depending on the brightness. The motion of the picture may slow down in this case.

NS LIGHT (NightShot Light)

When using either the NightShot plus (p. 20) or [SUPER NSPLUS] (p. 36) function to record, you can record clearer pictures by setting [NS LIGHT], which emits infrared light (invisible), to [ON] (the default setting).

Notes

- Do not cover the infrared port with your fingers or other objects (p. 85).
- Remove the conversion lens (optional) if it is attached.
- The maximum shooting distance using [NS LIGHT] is about 3 m (10 feet).

Tips

- If you record subjects in dark places, such as night scenes or in moonlight, set [NS LIGHT] to [OFF]. You can make the image color deeper this way.

COLOR SLOW S (Color Slow Shutter)

When you set [COLOR SLOW S] to [ON], you can record an image brighter in color even in dark places.

 and [COLOR SLOW SHUTTER] appear on the screen.

To cancel [COLOR SLOW S], touch [OFF].

Notes

- Adjust the focus manually ([FOCUS], p. 35) when it is hard to focus automatically.
- The shutter speed of your camcorder changes depending on the brightness. The motion of the picture may slow down at this time.

SELF-TIMER

When you set [SELF-TIMER] to [ON] (☺), the self-timer starts recording in about 10 seconds after pressing PHOTO to record still images.

To cancel the count down, touch [RESET].

To cancel [SELF-TIMER], touch [OFF].

💡 Tips

- You can also set the self-timer with the PHOTO button of the Remote Commander (p. 88).

DIGITAL ZOOM

You can select the maximum zoom level in case you want to zoom to a level greater than 25 × (the default setting) while recording on a tape. Note that the image quality decreases when you are using the digital zoom.

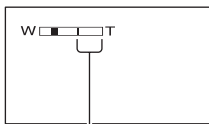

The right side of the bar shows the digital zooming factor. The zooming zone appears when you select the zooming level.

▶ OFF

Up to 25 × zoom is performed optically.

50 ×

Up to 25 × zoom is performed optically, and after that, up to 50 × zoom is performed digitally.

2000 ×

Up to 25 × zoom is performed optically, and after that, up to 2,000 × zoom is performed digitally.

STEADYSHOT

You can compensate for camera shake (the default setting is [ON]).

Set [STEADYSHOT] to [OFF] (☹) when using a tripod (optional) or the conversion lens (optional), then the image becomes natural.

MEMORY SET menu

Settings for the “Memory Stick Duo”

The default settings are marked with ►.
The indicators in parentheses appear when the items are selected.

See page 30 for details on selecting menu items.

STILL SET

■ BURST

You can record several still images one after another by pressing PHOTO.

► OFF

Select this when not recording continuously.

► NORMAL ()

Records still images continuously at about 0.5 second intervals.

The maximum number of images are recorded when you press and hold PHOTO fully.

In 4:3 aspect ratio:

Record up to 4 images (1.0M image size), or 13 images (VGA image size) continuously.

In 16:9 aspect ratio:

Record up to 4 images (0.7M image size) continuously.

► EXP.BRKTG (BRK)

Records 3 images consecutively with different exposures at about 0.5 second intervals. You can compare the 3 images and select an image recorded at the best exposure.

Notes

- [BURST] can be set only when the POWER switch is set to CAMERA-MEMORY.
- [BURST] cannot be set during Easy Handycam operation.
- The maximum number of images will be recorded in the self-timer mode or when you are operating with the Remote Commander.
- [EXP.BRKTG] will not function when there is space of less than 3 images remaining on the “Memory Stick Duo.”

■ QUALITY

► FINE (FINE)

Records still images at the fine image quality level.

► STANDARD (STD)

Records still images at the standard image quality level.

Notes

- Image quality is automatically fixed to [FINE] during Easy Handycam operation.

■ IMAGE SIZE

► 1.0M ()

Allows you to record more still images in relatively clear quality.

► VGA (0.3M) ()



Allows for the maximum number of images to be recorded.

Notes

- [IMAGE SIZE] can be set only when the POWER switch is set to CAMERA-MEMORY.
- If you set a screen ratio of 16:9 (wide), [IMAGE SIZE] is fixed to [0.7M] automatically (p. 21).

Capacity of the “Memory Stick Duo” (MB) and the number of recordable pictures

In 4:3 aspect ratio

	1.0M (1152 × 864) 	VGA (640 × 480) 
64MB	120 300	390 980
128MB	245 600	780 1970
256MB	445 1000	1400 3550
512MB	900 2050	2850 7200
1GB	1800 4200	5900 14500

	1.0M (1152 × 864) [1.0M]	VGA (640 × 480) [VGA]
2GB	3750 8600	12000 30000
4GB	7400 17000	23500 59000

In 16:9 aspect ratio

	0.7M (1152 × 648) [0.7M]	0.2M* (640 × 360) [0.2M]
64MB	160 390	490 980
128MB	325 780	980 1970
256MB	590 1400	1750 3550
512MB	1200 2850	3600 7200
1GB	2450 5900	7300 14500
2GB	5000 12000	15000 30000
4GB	9500 23500	29500 59000

* If you record a still image on a “Memory Stick Duo” with the POWER switch set to CAMERA-TAPE, [IMAGE SIZE] is automatically fixed at [0.2M]. You cannot select [0.2M] for the image size in [STILL SET].

Notes

- All numbers measured at the following settings:
Top: [FINE] is selected for image quality.
Bottom: [STANDARD] is selected for image quality.
- When using the “Memory Stick Duo” made by Sony Corporation.
The number of recordable pictures varies depending on the recording environment.

ALL ERASE

Deletes all the pictures without image protection on a “Memory Stick Duo” or in the selected folder.

- Select [ALL FILES] or [CURRNT FOLDER (Current folder)].

[ALL FILES]: Deletes all the images on the “Memory Stick Duo.”

[CURRNT FOLDER (Current folder)]: Deletes all the images in the selected folder.

- Touch [YES] twice → [X].

Notes

- When using a “Memory Stick Duo” with the write-protect tab engaged, cancel image protection by sliding the tab back beforehand (p. 75).
- The folder will not be deleted even when you delete all the pictures in the folder.
- Do not do any of the following while [Erasing all data...] is displayed:
 - Operate the POWER switch/operation buttons.
 - Eject the “Memory Stick Duo.”

FORMAT

The “Memory Stick Duo” has been formatted at the factory, and does not require formatting at purchase.

To execute formatting, touch [YES] twice → [X].

Formatting is completed, and all the images will be deleted.

Notes

- Do not do any of the following while [Formatting...] is displayed:
 - Operate the POWER switch/operation buttons.
 - Eject the “Memory Stick Duo.”
- Formatting erases everything on the “Memory Stick Duo” including protected image data and newly created folders.

MEMORY SET menu (Continued)

FILE NO.

► SERIES

Assigns file numbers in sequence even if the "Memory Stick Duo" is replaced with another one. The file number is reset when a new folder is created or the recording folder is replaced with another.

RESET

Resets the file number to 0001 each time the "Memory Stick Duo" is changed.

NEW FOLDER

You can create a new folder (102MSDCF to 999MSDCF) on a "Memory Stick Duo." When 9,999 images are stored in the current folder, a new folder is automatically created for storing subsequent images.

Touch [YES] → [X].

⚙ Notes

- You cannot delete the created folders using your camcorder. You will have to format the "Memory Stick Duo" (p. 39), or delete them using your computer.
- The number of recordable pictures on a "Memory Stick Duo" may decrease as the number of folders increases.

REC FOLDER (Recording folder)

Select the folder to be used for recording with [▲]/[▼], then touch [OK].

⚙ Notes

- As the default setting, pictures are saved in the 101MSDCF folder.
- Once you record a picture in a folder, the same folder will be set as the default folder for playback.

PB FOLDER (Playback folder)

Select the playback folder with [▲]/[▼], then touch [OK].

PICT.APPLI. menu

Special effects on pictures or additional functions on recording/playback

The default settings are marked with ►. The indicators in parentheses appear when the items are selected.

See page 30 for details on selecting menu items.

FADER

You can add the following effects to currently recording pictures.

- ① Select the desired effect in standby mode (to fade in) or recording mode (to fade out), then touch [OK].
When [OVERLAP], [WIPE] or [DOT FADER] is selected, the screen turns to blue while storing the image, then the image on a tape is stored as a still image.
- ② Press REC START/STOP.
The fader indicator stops flashing and disappears when the fade is complete.

To cancel [FADER] before starting the operation, touch [OFF] in step ①. If you press REC START/STOP once, the setting is canceled.



WHITE FADER



BLACK FADER



MOSAIC FADER



MONOTONE

When fading in, the picture gradually changes from black and white to color. When fading out, it gradually changes from color to black and white.

OVERLAP (fade in only)**WIPE (fade in only)****DOT FADER (fade in only)****SLIDE SHOW**

Plays back in sequence the images stored on a “Memory Stick Duo,” or in a folder (slide show).

- ① Touch [SET] → [PB FOLDER].
- ② Select [ALL FILES (a)] or [CURRNT FOLDER (T), Current folder], then touch [OK].

If you select [CURRNT FOLDER (T), Current folder], all the images in the current playback folder selected in [PB FOLDER] (p. 40) are played back in sequence.

- ③ Touch [REPEAT].
- ④ Select [ON] or [OFF], then [OK].
To repeat the slide show, select [ON] (C).
To execute the slide show only once, select [OFF].
- ⑤ Touch [END] → [START].

To cancel [SLIDE SHOW], touch [END].
To pause, touch [PAUSE].

💡 Tips

- You can select the first picture for the slide show with [−]/[+] before touching [START].

D.EFFECT (Digital effect)

You can add digital effects to your recordings.

- ① Touch the desired effect.
- ② Adjust the effect with [−]/[+], then touch [OK].

Effect	Items to adjust
STILL	The degree of transparency of the still image you want to superimpose under a movie.
FLASH	The interval of frame-by-frame playback.
LUMI. KEY	The color scheme of the area in the still image which is to be swapped with a movie.
TRAIL	The fade time of the incidental image.
SLOW SHUTTR*	Shutter speed (1 is 1/25, 2 is 1/12, 3 is 1/6, 4 is 1/3).
OLD MOVIE*	No adjustment necessary.

* Available during recording on a tape only.

- ③ Touch [OK].
[D+] appears.

To cancel [D.EFFECT], touch [OFF] in step ①.

▶ OFF

Does not use [D.EFFECT] setting.

STILL

Records a movie while superimposing it on a still image memorized by touching [STILL].



FLASH (flash motion)

Records a movie with a serial-still-image effect (strobe effect).

LUMI. KEY (luminance key)

Replaces a brighter area in a still image memorized at the moment when [LUMI. KEY] was selected, with a movie.



TRAIL

When recording, trailing afterimages are left in the picture.

SLOW SHUTTR (slow shutter)

The shutter speed is slowed down. Suitable for shooting a subject more clearly in a dark place.

OLD MOVIE

Adds an old movie effect with a sepia hue to pictures.

Notes

- Adjust the focus manually using a tripod (optional) since adjusting the focus automatically is hard when [SLOW SHUTTR] is selected. ([FOCUS], p. 35)
- You cannot select 16:9/4:3 as the aspect ratio for [OLD MOVIE].
- Effects added to the playback pictures are not output via the  DV Interface (i.LINK). Only the original pictures can be output.
- For DCR-HC48E:
You cannot add effects to externally input pictures.

Tips

- You can save pictures edited using special effects on a "Memory Stick Duo" (p. 55) or record them on another VCR/DVD device, etc. (p. 51).

PICT.EFFECT (Picture effect)

You can add special effects to a picture during recording or playback.  appears.

▶ OFF

Does not use [PICT.EFFECT] setting.

NEG.ART



The color and brightness are reversed.

SEPIA

Pictures appear in sepia.

B&W

Pictures appear in black and white.

SOLARIZE



Pictures appear as an illustration with strong contrast.

PASTEL*



Pictures appear as a pale pastel drawing.

MOSAIC*



Pictures appear mosaic-patterned.

* Not available during playback.

Notes

- Effects added to the playback pictures are not output via the  DV Interface (i.LINK). Only the original pictures can be output.
- For DCR-HC48E:
You cannot add effects to externally input pictures.

💡 Tips

- You can save pictures edited using special effects on a “Memory Stick Duo” (p. 55) or record them on another VCR/DVD device, etc. (p. 51).

SMTH INT.REC (Smooth interval tape recording)

Your camcorder will shoot 1 frame of the picture at a selected interval and keep them in memory until it has stored several frames. This function is useful to observe the movement of clouds or the changes of daylight. These pictures appear smooth when played back. Connect your camcorder to the wall socket using the supplied AC Adaptor for this operation.

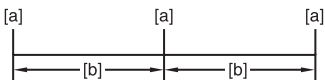

[a]: Recording

[b]: Interval

① Touch [SET] → $\left[\frac{-}{+} \right]$ to select a desired interval time (1 to 120 seconds) → [OK].

② Touch [REC START].

Recording starts and ● changes to red.

To interrupt, touch [REC STOP] in step ②.

To resume, touch [REC START].

To cancel, touch [REC STOP], then [END] in step ②.

🔊 Notes

- During Smooth interval recording, your camcorder may perform the END SEARCH function to locate the end in current recordings on the tape after several frames have been recorded.
- Do not turn off the power or disconnect the power source while a message is displayed on the screen.
- The camcorder will shoot several frames for the first and last shots of the Smooth interval recording.

- Smooth interval recording is released when approximately 12 hours have elapsed after shooting has begun.
- Sounds are not recorded.
- The last few frames may not be recorded if the battery or tape has run out.
- There may be discrepancies in the interval.

💡 Tips

- If you adjust the focus manually, you can record clear pictures even if the light changes ([FOCUS], p. 35).
- You can silence the recording beep by setting of [BEEP] (p. 48).

INT.REC-STL (Interval photo recording)

You can record still images on the “Memory Stick Duo” at a selected interval. This function is useful to observe the movement of clouds or the changes in daylight, etc.

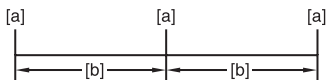

[a]: Recording

[b]: Interval

① Touch [SET] → a desired interval time (1, 5 or 10 minutes) → [OK] → [ON] (🔊) → [OK] → [X].

② Press PHOTO fully.

🔊 stops flashing and the interval still image recording starts.

To cancel [INT.REC-STL], select [OFF] in step ①.

DEMO MODE

The default setting is [ON], allowing you to view the demonstration about 10 minutes after you have removed both a cassette and a “Memory Stick Duo” from your camcorder, and slide the POWER switch repeatedly to turn on the CAMERA-TAPE lamp.

Settings for editing or playing back in various modes

 **Tips**

- The demonstration will be suspended in situations such as those described below.
 - When you touch the screen during the demonstration. (The demonstration starts again after about 10 minutes.)
 - When a cassette or a “Memory Stick Duo” is inserted.
 - When the POWER switch is set to other than CAMERA-TAPE.

PictBridge PRINT

See page 57.

USB SELECT

You can connect the camcorder to a personal computer with a USB cable and view pictures on the computer. You can also connect the camcorder to a PictBridge-compatible printer (p. 57) using this function.

 **Memory Stick**

Select this to view pictures on a “Memory Stick Duo” on the computer or to import them to the computer. Refer to “First Step Guide” on the supplied CD-ROM for details.

PictBridge PRINT

Select this when you connect the camcorder to a PictBridge-compatible printer to print out directly (p. 57).

 **STREAM**

Select this to view movies on a tape on the computer.

 **Notes**









- During Easy Handycam operation,  [STREAM] cannot be set.

See page 30 for details on selecting menu items.

 **VAR.SPD PB**
(Various speed playback)

You can play back in various modes while viewing movies.

- ① Touch the following buttons during playback.

To	Touch
change the playback direction*	 (frame)
play back slowly**	 To reverse direction:  (frame) → 
play back 2 times faster (double speed)	 (double speed) To reverse direction:  (frame) →  (double speed)
play back frame by frame	 (frame) during playback pause. To reverse direction:  (frame) during frame playback.

* Horizontal lines may appear at the top, bottom, or in the center of the screen. This is not a malfunction.

** Pictures output from the  DV Interface (i.LINK) cannot be played back smoothly in slow mode.

- ② Touch  → .

To return to the normal playback mode, touch  (Play/Pause) twice (once from frame playback).

 **Notes**

- You will not hear the recorded sound. You may see mosaic-like images of the previously played picture.

REC CTRL (Movie recording control)

See page 53.

AUD DUB CTRL (Audio dubbing)









Using the internal stereo microphone (p. 85), you can add sound to a tape already recorded in the 12-bit mode (p. 46) without erasing the original sound.

Notes

- You cannot record additional audio:
 - When the tape has been recorded in the 16-bit mode (p. 46).
 - When the tape has been recorded in the LP mode.
 - When your camcorder is connected via an i.LINK cable.
 - When the tape has been recorded in 4CH MIC mode on other camcorders.
 - On blank sections of the tape.
 - When the tape has been recorded in a TV color system other than that of your camcorder (p. 73).
 - When the write-protect tab of the cassette is set to SAVE (p. 73).
 - On sections recorded in HDV format.
- When you add sound, the picture will not be output from the A/V OUT jack. Check the picture on the LCD screen or the viewfinder.
- You can only record additional audio over a tape recorded on your camcorder. The sound may deteriorate when you dub audio on a tape recorded on other camcorders (including other DCR-HC47E/HC48E camcorders).

Recording sound

Insert a recorded cassette into your camcorder beforehand.

- ① Slide the POWER switch repeatedly to turn on the PLAY/EDIT lamp.
- ② Touch  (Play/Pause) to play back the tape, then touch it again at the point where you want to start recording the sound.
- ③ Touch  →  →  (EDIT/PLAY) →  →  →  → .

 appears.

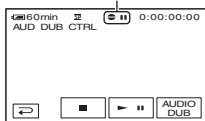

- ④ Touch  (Play).

Your camcorder starts audio recording via the internal stereo microphone.

 appears while recording the new sound in stereo 2 (ST2) during the playback of the tape.

- ⑤ Touch  (Stop) when you want to stop recording.







To dub on other scenes, repeat step ② to select scenes, then touch [AUDIO DUB].

- ⑥ Touch  → .



Tips

- To set the end point for audio dubbing, beforehand, press ZERO SET MEMORY on the Remote Commander at the scene at which you want to stop audio dubbing during playback. After step ② to ④, the recording stops automatically at the selected scene.

To check the recorded sound

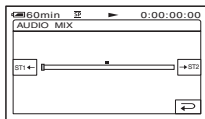
- ① Play back the tape on which you have recorded audio (p. 22).
- ② Touch  →  →  (STANDARD SET) →  →  → .



- ③ Touch  to adjust the balance of the original sound (ST1) and the new sound (ST2), then touch .

Notes

- The original sound (ST1) is output at the default setting.

END SEARCH**EXEC**

The most recently recorded picture is played back for about 5 seconds and then stops automatically.

CANCEL

Stops [END SEARCH].

Notes

- After ejecting the cassette, the END SEARCH function is not available.

Settings while recording on a tape or other basic settings

The default settings are marked with ►. The indicators in parentheses appear when the items are selected.

See page 30 for details on selecting menu items.

REC MODE (Recording mode)► **SP (SP)**

Records in the SP (Standard Play) mode on a cassette.

LP (LP)

Increases the recording time to 1.5 times the SP mode (Long Play).

Notes

- If you record in the LP mode, pictures may appear mosaic-like or sound may be interrupted when you play back the tape on other camcorders or VCRs.
- When you mix recordings in the SP mode and in the LP mode on one tape, the playback picture may be distorted or the time code may not be written properly between the scenes.

AUDIO MODE► **12BIT**

Records in the 12-bit mode (2 stereo sounds).

16BIT (16b)

Records in the 16-bit mode (1 stereo sound with high quality).

VOLUME

See page 22.

AUDIO MIX

See page 45.

LCD/VF SET

The recorded picture will not be affected by this operation.

LCD BRIGHT

You can adjust the brightness of the LCD screen.

- Adjust the brightness with \square / \square .
- Touch \square .

LCD BL LEVEL

You can adjust the brightness of the LCD screen's backlight.

► NORMAL

Standard brightness.

BRIGHT

Brightens the LCD screen.

Notes

- When you connect your camcorder to outside power sources, [BRIGHT] is automatically selected for the setting.
- When you select [BRIGHT], battery life is slightly reduced during recording.

LCD COLOR

You can adjust the color on the LCD screen with \square / \square .



VF B.LIGHT

You can adjust the brightness of the viewfinder.

► NORMAL

Standard brightness.

BRIGHT

Brightens the viewfinder screen.

Notes

- When you connect your camcorder to outside power sources, [BRIGHT] is automatically selected for the setting.
- When you select [BRIGHT], battery life is slightly reduced during recording.

TV TYPE

See page 29.

USB CAMERA

When you set \square [STREAM] and connect your camcorder to your computer via the USB cable, you can view the picture your camcorder is currently seeing on your computer like a live camera.

You can also import the picture to your computer. Refer to the "First Step Guide" on the supplied CD-ROM for details (p. 62).

DISP GUIDE

See page 91.

DATA CODE

During playback, displays information (data code) recorded automatically at the time of recording.

► OFF

Data code is not displayed.

DATE/TIME

Displays the date and time.

CAMERA DATA (below)

Displays camera setting data.

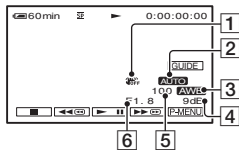

- SteadyShot off
- Exposure
- White balance
- Gain
- Shutter speed
- Aperture value

Notes

- The exposure adjustment value (0EV), a shutter speed, and the aperture value appear when still images on a “Memory Stick Duo” are played back.
- In the [DATE/TIME] data display, the date and time are displayed in the same area. If you record a picture without setting the clock, [-- --] and [--:--:--] will appear.
- During Easy Handycam operation, you can set [DATE/TIME] only.

REMAINING

▶ AUTO

Displays the remaining tape indicator for about 8 seconds in situations such as those described below.

- When you set the POWER switch to PLAY/EDIT or CAMERA-TAPE with a cassette inserted.
- When you touch  (Play/Pause).

ON

Always displays the remaining tape indicator.

REMOTE CTRL (Remote control)

The default setting is [ON], allowing you to use the supplied Remote Commander (p. 88).

Tips

- Set to [OFF] to prevent your camcorder from responding to a command sent by another VCR remote control unit.

BEEP

▶ ON

A beeping sound starts when you start/stop recording, or operate the touch panel.

OFF

Cancels the beeping sound and shutter sound.

DISP OUTPUT

▶ LCD PANEL

Shows displays such as the time code on the LCD screen and in the viewfinder.

V-OUT/PANEL

Shows displays such as the time code on the TV screen, LCD screen, and in the viewfinder.

MENU ROTATE

▶ NORMAL

Scrolls the menu items downwards by touching .

OPPOSITE

Scrolls the menu items upwards by touching .

A.SHUT OFF (Auto shut off)

▶ 5 min

The camcorder is automatically turned off when you do not operate your camcorder for more than approximately 5 minutes.

NEVER

The camcorder is not automatically turned off.

Notes

- When you connect your camcorder to a wall socket, [A.SHUT OFF] is automatically set to [NEVER].

CALIBRATION

See page 79.



TIME/LANGU. menu

See page 30 for details on selecting menu items.

CLOCK SET

See page 11.

WORLD TIME

When using your camcorder abroad, you can set the time difference by touching  / , the clock will be adjusted in accordance with the time difference. If you set the time difference to 0, the clock returns to the originally set time.

LANGUAGE

You can select the language to be used on the LCD screen.

Notes

- Your camcorder offers [ENG[SIMP]] (simplified English) for when you cannot find your native tongue among the options.

Customizing Personal Menu

You can add desired menu items to any Personal Menu allocated to the lamp positions currently lit. This is convenient if you add frequently used menu items to Personal Menu.

Adding a menu item

You can add up to 28 menu items to each Personal Menu. Delete a less important menu item, if you want to add more.

1 Touch → [P-MENU SET UP] → [ADD].

If the desired menu item is not displayed, touch .

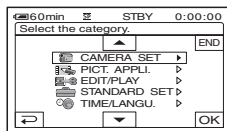

2 Touch to select a menu category, then touch .

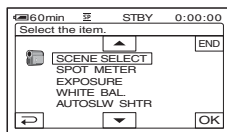

3 Touch to select a menu item, then touch → [YES] → .

The menu item is added to the end of the list.

Deleting a menu item

- 1 Touch [P-MENU] → [P-MENU SET UP] → [DELETE].

If the desired menu item is not displayed, touch \uparrow/\downarrow .

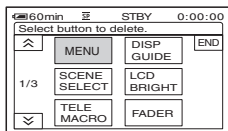

- 2 Touch the menu item that you want to delete.

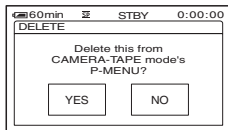

- 3 Touch [YES] → \times .

Notes

- You cannot delete [MENU] and [P-MENU SET UP].

Arranging the order of menu items displayed on Personal Menu

- 1 Touch [P-MENU] → [P-MENU SET UP] → [SORT].

If the desired menu item is not displayed, touch \uparrow/\downarrow .

- 2 Touch the menu item you want to move.

- 3 Touch \uparrow/\downarrow to move the menu item to the desired place.

- 4 Touch [OK].

To sort more items, repeat steps 2 to 4.

- 5 Touch [END] → \times .

Notes

- You cannot move [P-MENU SET UP].

Initializing the Personal Menu settings (Reset)

- Touch [P-MENU] → [P-MENU SET UP] → [RESET] → [YES] → [YES] → \times .

If the desired menu item is not displayed, touch \uparrow/\downarrow .

Dubbing to VCR or DVD/HDD recorders

You can dub images played back on your camcorder to other recording devices, such as VCRs or DVD/HDD recorders.

You can connect your camcorder to VCRs or DVD/HDD recorders, using the A/V connecting cable (1), the A/V connecting cable with S VIDEO (2), or the i.LINK cable (3).

Connect your camcorder to the wall socket using the supplied AC Adaptor for this operation (p. 8). Refer also to the instruction manuals supplied with the devices to be connected.

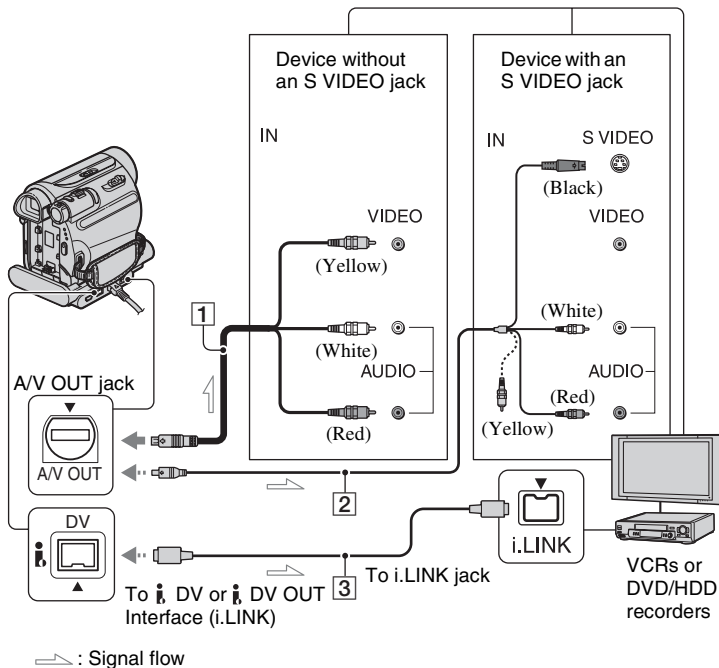

1 A/V connecting cable (supplied)

The Handycam Station and your camcorder are both equipped with A/V OUT jacks (p. 87, 88). Connect the A/V connecting cable either to the Handycam Station or to your camcorder, depending on your setup.

2 A/V connecting cable with S VIDEO (optional)

When connecting to another device via the S VIDEO jack, by using the A/V connecting cable with an S VIDEO cable, pictures can be reproduced more faithfully than with the supplied A/V cable connection. Connect the

white and red plugs (left/right audio) and S VIDEO plug (S VIDEO channel) of an A/V connecting cable. In this case, the yellow (standard video) plug connection is not necessary. S VIDEO connection only will not output audio.

3 i.LINK cable (optional)

Use an i.LINK cable to connect your camcorder to another device equipped with an i.LINK jack. The video and audio signals are transmitted digitally, producing high quality pictures and sound. Note that you cannot output picture and sound separately.

Notes

- When you are connecting your camcorder to a monaural device, connect the yellow plug of the A/V connecting cable to the video input jack, and the red (right channel) or the white (left channel) plug to the audio input jack on the device.
- When you connect a device via an A/V connecting cable, set [DISP OUTPUT] to [LCD PANEL] (the default setting) (p. 48).
- While your camcorder is sending signals to another device via an i.LINK cable, DVOUT  appears on the LCD screen on your camcorder.

1 Prepare your camcorder for playback.

Insert the recorded cassette.

Slide the POWER switch repeatedly to turn on the PLAY/EDIT lamp.

2 Insert the recording media in the recording device.

If your recording device has an input selector, set it to the appropriate input (such as video input1, video input2).

3 Connect your camcorder to the recording device (VCR or DVD/HDD recorder) with the A/V connecting cable (supplied) , an A/V connecting cable with S VIDEO (optional) or an i.LINK cable (optional) .

Connect your camcorder to the input jacks of the recording device.

4 Start playback on the camcorder, and recording on the recording device.

Refer to the operating instructions supplied with your recording device for details.

5 When dubbing is complete, stop your camcorder and the recording device.

Notes

- Set [TV TYPE] according to the playback device (TV, etc.) when connecting with the A/V connecting cable.
- To record the date/time and camera settings data when connected by the A/V connecting cable, display them on the screen (p. 47).
- The following cannot be output via the  DV Interface (i.LINK):
 - Indicators
 - Pictures edited using [PICT.EFFECT] (p. 42), [D.EFFECT] (p. 41) or PB zoom (p. 24).
- When connected using an i.LINK cable, the recorded picture becomes rough when a picture is paused on your camcorder while recording.
- When connected using an i.LINK cable, data code (date/time/camera settings data) may not be displayed or recorded depending on the device or application.

Recording pictures from a VCR, etc. (DCR-HC48E)

You can record pictures from a VCR, etc., onto a tape, you can also record a scene as a still image onto a "Memory Stick Duo" using an optional i.LINK cable.

Be sure to insert a cassette or a "Memory Stick Duo" for recording in your camcorder beforehand.

You can connect your camcorder to a VCR, etc., or an i.LINK-compatible device using the i.LINK cable (optional).

Connect your camcorder to the wall socket using the supplied AC Adaptor for this operation (p. 8). Refer also to the instruction manuals supplied with the devices to be connected.

Notes

- You cannot record pictures on your camcorder from a VCR, etc., that does not have an i.LINK jack.
- Your camcorder can only record from a PAL source. For example, French system video/broadcasts (SECAM) will not be recorded correctly. See page 73 for details on TV color systems.
- If you use a 21-pin adaptor to input a PAL source, you need a dual direction 21-pin adaptor (optional).

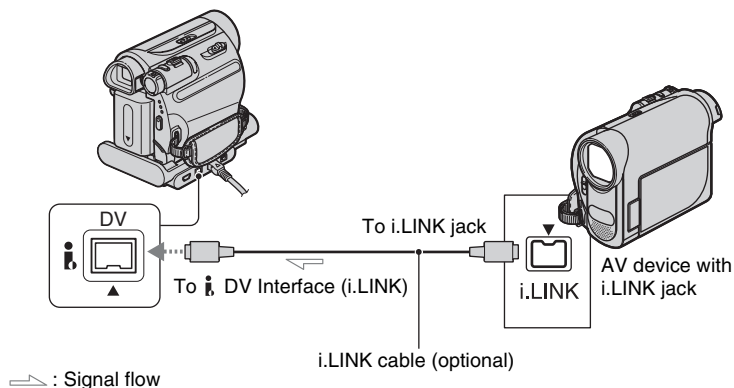

When connecting your camcorder to another device using an i.LINK cable, the video and audio signals are transmitted digitally, producing high quality pictures and sound. Note that you cannot output picture and sound separately.

Recording movies

- 1** Connect your VCR to your camcorder with an i.LINK cable.

- 2** Insert a cassette into the VCR.

- 3** Slide the POWER switch repeatedly to turn on the PLAY/EDIT lamp.

Recording pictures from a VCR, etc. (Continued)

4 Set your camcorder to recording pause mode.

Touch [P-MENU] → [] REC CTRL] → [REC PAUSE].

5 Start playing the cassette on the VCR.

The picture played on the connected device appears on the LCD screen of your camcorder.

6 Touch [REC START] at the point you want to start recording.

7 Stop recording.

Touch [] (Stop) or [REC PAUSE].

8 Touch [] → [X].

Recording still images

1 Perform steps 1 to 3 in “Recording movies.”

2 Start playing the cassette on the VCR.

The pictures on the VCR appear on the screen of your camcorder.

3 Press PHOTO lightly at the scene you want to record. Check the image and press it fully.

Notes

- The DVIN **i.LINK** indicator appears when you connect your camcorder and other devices via an i.LINK cable. (This indicator may also appear on the connected device.)

Dubbing pictures from a tape to a “Memory Stick Duo”

You can record a desired scene onto a “Memory Stick Duo” as a still image, from a movie you recorded on a tape. Make sure you have a recorded tape and a “Memory Stick Duo” inserted into your camcorder.

1 Slide the **POWER** switch repeatedly to turn on the **PLAY/EDIT** lamp.

2 Search and record the scene you want to record.

Touch  (Play) to play back the tape, then press **PHOTO** lightly at the scene you want to record. Check the image and press it fully.

Notes

- The date and time the picture is recorded on the tape and stored on the “Memory Stick Duo” are recorded. On your camcorder, the date and time the picture is recorded on the tape are displayed. Camera setting data recorded on the tape cannot be stored on the “Memory Stick Duo.”
- Still images will be fixed to image size [0.2M] when playing back the 16:9 picture, or [VGA (0.3M)] when playing back the 4:3 picture.

Deleting recorded pictures from the “Memory Stick Duo”

1 Slide the **POWER** switch repeatedly to turn on the **PLAY/EDIT** lamp.

2 Touch .

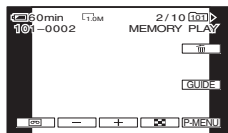





3 Select a picture you want to delete with  / .

4 Touch  → [YES].

Notes

- The pictures cannot be restored once they are deleted.
- Pictures cannot be deleted when a “Memory Stick Duo” with the write-protect tab is set to the write-protect position (p. 75), or when the selected picture is protected (p. 56).

Tips

- To delete all pictures at once, select  ALL ERASE] (p. 39).
- You can delete pictures on the index screen (p. 23). You can easily search for the picture to be deleted by displaying 6 pictures at once. Touch  →  → the picture you want to delete →  → [YES].

Marking images on the “Memory Stick Duo” with specific information (Print mark/Image protection)

When you are using a “Memory Stick Duo” with the write-protect tab, make sure the write-protect tab on the “Memory Stick Duo” is not set to the write-protect position (p. 75).

Selecting still images for printing (Print mark)

The DPOF (Digital Print Order Format) standard is used to select images for printing on your camcorder.

By marking images that you want to print out, you do not need to reselect them when you print them out. (You cannot specify the number of printouts.)

1 Slide the **POWER** switch repeatedly to turn on the **PLAY/EDIT** lamp.

2 Touch **[MEMORY]** →  → **[SET]** → **[PRINT MARK]**.

3 Touch the image that you want to print out later.

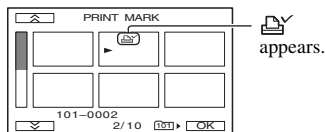

4 Touch **[OK]** → **[END]**.

Notes

- To cancel Print mark, touch the image again to cancel Print mark in step 3.

- Do not mark images on your camcorder if the “Memory Stick Duo” already has some images with the Print mark put on using other devices. This may change the information of the images with the Print mark put on using the other device.

Preventing accidental erasure (Image protection)

You can select and mark images to prevent accidental erasure.

1 Slide the **POWER** switch repeatedly to turn on the **PLAY/EDIT** lamp.

2 Touch **[MEMORY]** →  → **[SET]** → **[PROTECT]**.

3 Touch the image that you want to protect.

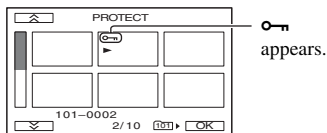

4 Touch **[OK]** → **[END]**.

Notes

- To cancel image protection, touch the image again to cancel image protection in step 3.

Printing recorded images (PictBridge compliant printer)

You can print out pictures using a PictBridge compliant printer without connecting the camcorder to a computer.

PictBridge

Connect the AC Adaptor to obtain power from the wall socket (p. 8). Insert the “Memory Stick Duo” containing still images into your camcorder and turn on the printer.

Connecting your camcorder to the printer

1 Slide the **POWER** switch repeatedly to turn on the **PLAY/EDIT** lamp.

2 Connect the ψ (**USB**) jack (p. 88) of the Handycam Station to the printer using the **USB** cable.
[USB SELECT] appears on the screen automatically.

3 Touch [PictBridge PRINT].

When connection is complete,  (PictBridge connecting) appears on the screen.

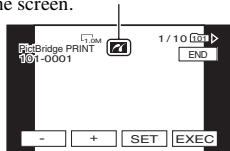



One of the images stored on the “Memory Stick Duo” will be displayed.

Notes

- We cannot guarantee the operation of models that are not PictBridge compatible.



Tips

- You can also operate by selecting in the following orders:
 - Touch [P-MENU] → [MENU] →  (PICT.APPL.) → [USB SELECT] → [PictBridge PRINT]
 - Touch [P-MENU] → [MENU] →  (PICT.APPL.) → [PictBridge PRINT]

Printing

1 Select the image to be printed with  / .

2 Touch [SET] → [COPIES].

3 Select the number of copies to be printed with  / .

A maximum of 20 copies of the image can be printed.

4 Touch [OK] → [END].

To print the date and time on the image, touch [SET] → [DATE/TIME] → [DATE] or [DAY&TIME] → [OK].

5 Touch [EXEC] → [YES].

When printing is finished, [Printing...] disappears and the image selection screen appears again.

Touch [END] when printing is completed.

Notes

- Refer also to the operating instructions for the printer to be used.
- Do not attempt the following operations when  is on the screen. The operations may not be performed properly.
 - Operate the POWER switch.
 - Disconnect the mains lead.
 - Remove your camcorder from the Handycam Station.
 - Disconnect the USB cable from the Handycam Station or the printer.
 - Remove the “Memory Stick Duo” from your camcorder.
- If the printer stops working, disconnect the USB cable, turn the printer off and on again and restart the operation from the beginning.
- On some printer models, the top, bottom, right, and left edges of images may be trimmed. If you print a still image recorded in a 16:9 (wide) ratio, the left and right ends of the image may be trimmed widely.
- Some printer models may not support the date and time printing function. Refer to your printer’s operating instructions for details.
- We cannot guarantee the printing of images recorded with a device other than your camcorder.
- PictBridge is an industry standard established by the Camera & Imaging Products Association (CIPA). You can print still images without using a computer by connecting a printer directly to a digital video camera or digital still camera, regardless of model or manufacturer.

What you can do with Windows computer

When you install the “Picture Motion Browser” on a Windows computer from the supplied CD-ROM, you can enjoy the following operations.

Notes

- You cannot install the supplied software, “Picture Motion Browser,” on a Macintosh computer.

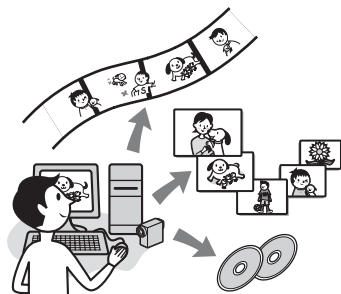

Main functions

■ Importing/Viewing movies taken with your camcorder

You can manage movies and still images by date and time of shooting, and select movies or still images you want to view as thumbnails. These thumbnails can be enlarged and played in a slide show.

■ Editing pictures imported to a computer

You can edit imported movies and still images on a computer.

■ Exporting movies from your computer to your camcorder

You can export movies that have been imported to a computer from your camcorder, back to your camcorder.

About “First Step Guide”

The “First Step Guide” is an instruction manual you can refer to on your computer. This describes basic operations, from initial hookup of your camcorder and computer and making settings, to general operation the first time you use the software “Picture Motion Browser” stored on the CD-ROM (supplied).

Referring to “Installing the “First Step Guide”” (p. 60), start the “First Step Guide”, then follow the instructions.

About the help function of the software

The Help guide explains all the functions of all the software applications. Refer to the Help guide for further detailed operations after reading the “First Step Guide” thoroughly.

To display the Help guide, click the [?] mark on the screen.

System requirements

When using “Picture Motion Browser”

OS: Microsoft Windows 2000 Professional, Windows XP Home Edition, Windows XP Professional or Windows XP Media Center Edition
Standard installation is required.
Operation is not assured if the above OS has been upgraded or in a multi-boot environment.

CPU: Intel Pentium III 800 MHz or faster

Application: DirectX 9.0c or later
(This product is based on DirectX technology. It is necessary to have DirectX installed.)

Sound system: Direct Sound compatible sound card

Memory: 256 MB or more

What you can do with Windows computer (Continued)

Hard disk:

Disc volume required for installation: Approximately 350 MB

Display: DirectX 7 or later-compatible video card, Minimum 1024 × 768 dots, High Color (16 bit color)

Others:  USB port (this must be provided as standard), DV Interface (IEEE1394, i.LINK) (to connect via an i.LINK cable), optical disc drive (CD-ROM drive is necessary for installation)

When playing still images recorded on a “Memory Stick Duo” on a computer

OS: Microsoft Windows 2000 Professional, Windows XP Home Edition, Windows XP Professional or Windows XP Media Center Edition
Standard installation is required.
Operation is not assured if the above OS has been upgraded.

CPU: MMX Pentium 200 MHz or faster

Others:  USB port (this must be provided as standard)

Notes

- Operations are not guaranteed on all the recommended environments.
For example, other open or background applications running on currently may limit product performance.

Tips

- If your computer has a Memory Stick slot, insert the “Memory Stick Duo” on which still images are recorded into the Memory Stick Duo Adaptor (optional), then insert it into the Memory Stick slot on your computer to copy still images to the computer.
- When using a “Memory Stick PRO Duo” and your computer is not compatible with it, connect your camcorder with the USB cable instead of using the Memory Stick slot on the computer.

Installing the “First Step Guide” and software

You need to install the “First Step Guide” and software to your Windows computer **before connecting your camcorder to the computer**. The installation is required only for the first time.
Contents to be installed and procedures may differ depending on your OS.

Tips

- See page 62 when you use a Macintosh computer.

Installing the “First Step Guide”

1 Confirm that your camcorder is not connected to the computer.

2 Turn on the computer.

- Log on as an Administrator for installation.
 - Close all applications running on the computer before installing the software.
-

3 Place the supplied CD-ROM in the disc drive of your computer.

The installation screen appears.



If the screen does not appear

- ① Click [Start], then click [My Computer]. (For Windows 2000, double-click [My Computer].)
- ② Double-click [SONYPICTUTIL (E:)] (CD-ROM) (disc drive).*

* Drive names (such as (E:)) may vary depending on the computer.

4 Click [FirstStepGuide].

-
- 5** Select the desired language and the model name of your camcorder from the pull-down menu.



-
- 6** Click [FirstStepGuide(HTML)].

Installation starts.

When [Save is complete] appears, click [OK] to finish the installation.

To view the “First Step Guide” in PDF

In step 6, click [FirstStepGuide(PDF)].

To install the software “Adobe Reader” to display the PDF file

In step 6, click [Adobe(R) Reader(R)].

Installing the software

-
- 1** Perform steps 1 to 3 in “Installing the “First Step Guide”” (p. 60).
-
- 2** Click [Install].
-
- 3** Select the language for the application to be installed, then click [Next].
-
- 4** Check your country/region, then click [Next].

-
- 5** Read [License Agreement], select [I accept the terms of the license agreement] when you agree, then click [Next].

-
- 6** Follow the on-screen instructions to install the software.

Depending on the computer, you may need to install third party software (shown below). If the installation screen appears, follow the instructions to install the required software.

■ Microsoft DirectX 9.0c

Software required to handle movies

Restart the computer if required to complete the installation.

The short-cut icons, such as [] (Picture Motion Browser), appear on the desktop.



-
- 7** Remove the CD-ROM from the disc drive of your computer.



After you install the software, a shortcut icon for the customers registration website is created on the desktop.

- Once you register on the website, you can get secure and useful customer support.
<http://www.sony.net/registration/di/>

Viewing “First Step Guide”

To view “First Step Guide” on your computer, Microsoft Internet Explorer Ver.6.0 or later is recommended. Double-click the short-cut icon for “First Step Guide” on the desktop.

Tips

- You can also start by selecting [Start] → [Programs] ([All Programs] for Windows XP) → [Sony Picture Utility] → [FirstStepGuide] → Your camcorder’s folder → “First Step Guide” in HTML.
- To view “First Step Guide” in HTML without installing, copy the desired language folder from the [FirstStepGuide] folder on the CD-ROM, and then double-click [Index.html].
- Refer to the “First Step Guide” in PDF in the following cases:
 - When printing the desired topics of “First Step Guide”
 - When “First Step Guide” is not displayed correctly due to the browser setting even in recommended environment.
 - When the HTML version of “First Step Guide” cannot be installed.

Using a Macintosh computer

You can copy the still images from the “Memory Stick Duo” to the Macintosh. Install “First Step Guide” in the supplied CD-ROM.

Notes

- The supplied software “Picture Motion Browser” does not operate on Mac OS.
- Refer to “First Step Guide” for the details on connecting your camcorder to the computer and copying the still images.

System requirements

To copy still images from a “Memory Stick Duo”

OS: Mac OS 9.1/9.2 or Mac OS X (v10.1/v10.2/v10.3/v10.4).

Others:  USB port (this must be provided as standard)

About “First Step Guide”

The “First Step Guide” is an instruction manual you can refer to on your computer. This describes basic operations, from initial hookup of your camcorder and computer and making setting, to general operation the first time you use the software. Referring to “Installing the “First Step Guide””, start the “First Step Guide”, then follow the instructions.

Installing “First Step Guide”

Copy “FirstStepGuide(PDF),” stored in the desired language in the [FirstStepGuide] folder, to your computer.

Viewing “First Step Guide”

Double-click “FirstStepGuide(PDF)”. If software to view PDF files is not installed on your computer, download Adobe Reader from their website, below;
<http://www.adobe.com/>

Troubleshooting

If you run into any problems using your camcorder, use the following table to troubleshoot the problem. If the problem persists, disconnect the power source and contact your Sony dealer.

- Overall operations/Easy Handycam/Remote Commander..... 63
- Batteries/Power sources 64
- LCD screen/viewfinder 64
- Cassette tapes/"Memory Stick Duo" 65
- Recording 66
- Playback 67
- Dubbing/Editing/Connecting to other devices 68
- Connecting to a computer 69
- Functions that cannot be used together 69

Overall operations/Easy Handycam/Remote Commander

The power does not turn on.

- Attach a charged battery pack to the camcorder (p. 8).
- Use the AC Adaptor to connect to a wall socket (p. 8).
- Insert your camcorder into the Handycam Station correctly (p. 8).

The camcorder does not operate even when the power is set to on.

- Disconnect the AC Adaptor from the wall socket or remove the battery pack, then reconnect it after about 1 minute.
- Press the RESET button (p. 86) using a sharp-pointed object. (If you press the RESET button, all settings are reset, except Personal Menu items.)

Buttons do not work.

- During Easy Handycam operation, not all buttons are functional (p. 17).

Settings change during Easy Handycam operation.

- During Easy Handycam operation, the settings of the functions that are not displayed on the screen return to their defaults (p. 16, 31).

The menu item settings have changed unexpectedly.

- The following settings return to the default settings automatically when you set the POWER switch to OFF (CHG) for more than 12 hours.
 - BACK LIGHT
 - [SCENE SELECT]
 - [SPOT METER]
 - [EXPOSURE]
 - [WHITE BAL.]
 - [SPOT FOCUS]
 - [FOCUS]
 - [AUDIO MIX]

The camcorder gets warm.

- The camcorder may get warmer while you use it. This is not a malfunction.

The supplied Remote Commander does not function.

- Set [REMOTE CTRL] to [ON] (p. 48).
- Remove any obstructions between the Remote Commander and the remote sensor.
- Keep strong light sources, such as sunlight or overhead lighting, away from the remote sensor, otherwise the Remote Commander may not function properly.
- Insert a fresh battery in the compartment with its +/- terminals matching those of the compartment (p. 81).

Another VCR malfunctions when you use the supplied Remote Commander.

- Select a commander mode other than VTR 2 for your VCR.

Troubleshooting (Continued)

- Cover the sensor of your VCR with black paper.

Batteries/Power sources

The power abruptly turns off.

- When approximately 5 minutes have elapsed while you do not operate your camcorder, the camcorder is automatically turned off (A.SHUT OFF). Change the setting of [A.SHUT OFF] (p. 48), or turn on the power again (p. 11), or use the AC Adaptor.
- The battery is fully discharged, or almost discharged. Charge the battery pack (p. 8).

The CHG (charge) lamp does not light while the battery pack is being charged.

- Slide the POWER switch to OFF (CHG) (p. 8).
- Attach the battery pack to the camcorder correctly (p. 8).
- Connect the mains lead to the wall socket properly.
- Insert your camcorder into the Handycam Station correctly (p. 8).
- The battery charge is completed (p. 8).

The CHG (charge) lamp flashes while the battery pack is being charged.

- Attach the battery pack to the camcorder correctly (p. 8). If the problem persists, disconnect the AC Adaptor from the wall socket and contact your Sony dealer. The battery pack may be worn-out.

The remaining battery time indicator does not indicate the correct time.

- Ambient temperature is too high or too low, or the battery pack has not been charged enough. This is not a malfunction.
- Fully charge the battery again. If the problem persists, the battery may be worn-out. Replace it with a new one (p. 8, 76).

- The indicated time may not be correct in certain circumstances. For example, when you open or close the LCD panel, it takes about 1 minute to display the correct remaining battery time.

The battery pack discharges too quickly.

- Ambient temperature is too high or too low, or the battery pack has not been charged enough. This is not a malfunction.
- Fully charge the battery again. If the problem persists, the battery may be worn-out. Replace it with a new one (p. 8, 76).

LCD screen/viewfinder



A rippling effect appears on the LCD screen when you touch it.

- This is not a malfunction. Do not press hard on the LCD screen.

You cannot turn the LCD backlight off.

- During Easy Handycam operation (p. 17), you cannot turn the LCD backlight on/off by pressing and holding DISP/BATT INFO.

You cannot turn off the indicator.

- You cannot turn off . Touch  to check the warning messages (p. 72).

The buttons do not appear on the touch panel.

- Touch the LCD screen lightly.
- Press DISP/BATT INFO on your camcorder (or DISPLAY on the Remote Commander) (p. 86, 88).

The buttons on the touch panel do not work correctly or do not work at all.

- Adjust the touch panel ([CALIBRATION]) (p. 79).

Menu items are grayed out.

- You cannot select grayed items in the current recording/playback situation.

[P-MENU] is not displayed.

- During Easy Handycam operation, not all menu items are functional. Cancel Easy Handycam operation (p. 16).

The picture in the viewfinder is not clear.

- Move the viewfinder lens adjustment lever until the picture appears clearly (p. 13).

The picture in the viewfinder has disappeared.

- Close the LCD panel. The picture is not displayed in the viewfinder when the LCD panel is open (p. 12).

Cassette tapes/ "Memory Stick Duo"

The cassette cannot be ejected from the compartment.

- Make sure the power source (battery pack or AC Adaptor) is connected correctly (p. 8).
- Moisture condensation has occurred inside the camcorder (p. 78).

The Cassette Memory indicator or title display does not appear while using a cassette with Cassette Memory.

- This camcorder does not support Cassette Memory, so the indicator does not appear.

The remaining tape indicator is not displayed.

- Set [REMAINING] to [ON] to always display the remaining tape indicator (p. 48).

The cassette is noisier during rewinding or fast-forwarding.

- When using the AC Adaptor, rewind/fast forward speed increases (compared with battery operation) and therefore increases noise. This is not a malfunction.

You cannot delete the recorded picture on the tape.

- You cannot delete a recorded picture on tape; you can only rewind the tape and record again. The new recording overwrites the existing one.

You cannot operate functions using the "Memory Stick Duo."

- Slide the POWER switch repeatedly to turn on the CAMERA-MEMORY or PLAY/EDIT lamp (p. 19, 22).
- If you use a "Memory Stick Duo" formatted on a computer, format it again on your camcorder (p. 39).

You cannot delete pictures or format a "Memory Stick Duo."

- Release the lock on the write-protect tab of the "Memory Stick Duo" if there is one (p. 75).
- Cancel image protection on the picture (p. 56).
- The maximum number of pictures that you can delete on the index screen at one time is 100.

Image protection cannot be applied, or you cannot mark pictures for print.

- Release the lock on the write-protect tab of the "Memory Stick Duo" if there is one (p. 75).
- Perform the operation again on the index screen (p. 23, 56).
- The maximum number of pictures you can mark for print is 999.

The data file name is not indicated correctly, or flashes.

- The file is damaged.
- Use the file format that is compatible with your camcorder (p. 74).

Recording

Refer also to “Cassette tapes/ “Memory Stick Duo”” section (p. 65).

The tape does not start when you press REC START/STOP.

- Slide the POWER switch repeatedly to turn on the CAMERA-TAPE lamp (p. 18).
- The tape has reached the end. Rewind it, or insert a new cassette.
- Set the write-protect tab to REC or insert a new cassette (p. 73).
- The tape is stuck to the drum due to moisture condensation. Remove the cassette and leave your camcorder for at least 1 hour, then re-insert the cassette (p. 78).

You cannot record on the “Memory Stick Duo.”

- The “Memory Stick Duo” is full. Insert another “Memory Stick Duo” or format the “Memory Stick Duo” (p. 39). Or, delete unnecessary pictures recorded on the “Memory Stick Duo” (p. 55).
- When you set [SMTH INT.REC] to [ON], still images cannot be recorded on a “Memory Stick Duo” during tape recording (p. 43).

The recording image view looks different.

- The recording image view may look different depending on the condition of your camcorder. This is not a malfunction.

You cannot record a smooth transition on a tape from the last recorded scene to the next.

- Perform [END SEARCH] (p. 25).
- Do not remove the cassette. (The picture will be recorded continuously without a break even when you turn the power off.)
- Do not record pictures in SP mode and LP mode on the same tape.
- Avoid stopping then recording a movie in the LP mode.

[END SEARCH] does not work.

- Do not eject the cassette after recording (p. 25).
- There is nothing recorded on the cassette.
- There is a blank section between recorded sections of the tape. This is not a malfunction.

Smooth interval recording stops/ [Smooth interval rec discontinued due to error.] appears and recording stops.

- The video head may be dirty. Use a cleaning cassette (optional) (p. 79).
- Try again from the beginning.
- Use a Sony mini DV cassette.

The auto focus does not function.

- Set [FOCUS] to [AUTO] (p. 35).
- The recording conditions are not suitable for auto focus. Adjust the focus manually (p. 35).

[STEADYSHOT] does not function.

- Set [STEADYSHOT] to [ON] (p. 37).

The BACK LIGHT function does not function.

- In the following settings, the BACK LIGHT function is canceled.
 - [MANUAL] of [EXPOSURE]
 - [SPOT METER]
- The BACK LIGHT function does not work during Easy Handycam operation (p. 17).

A vertical band appears when recording candlelight or electric light in the dark.

- This occurs when the contrast between the subject and the background is too high. This is not a malfunction.

A vertical band appears when recording a bright subject.

- This phenomenon is called the smear effect. This is not a malfunction.

Tiny spots in white, red, blue, or green appear on the screen.

- The spots appear when you are recording in [AUTOSLW SHTR], [SLOW SHUTTR], [SUPER NSPLUS], or [COLOR SLOW S]. This is not a malfunction.

The color of the picture is not correctly displayed.

- Deactivate the NightShot plus function (p. 20).

The screen picture is bright, and the subject does not appear on the screen.

- Deactivate the NightShot plus function (p. 20), or cancel the BACK LIGHT function (p. 21).

The screen picture is dark, and the subject does not appear on the screen.

- Press and hold DISP/BATT INFO for a few seconds to turn on the backlight (p. 12).

Undesirable flicker occurs.

- This anomaly may occur when recording pictures under the discharge tube, such as a fluorescent lamp, sodium lamp, or mercury lamp, with [PORTRAIT] or [SPORTS]. This is not a malfunction.

Black bands appear when you record a TV screen or computer screen.

- Set [STEADYSHOT] to [OFF] (p. 37).

[The lens cover might be closed. Check the cover.] appears on the screen when the lens cover is open.

- There is not enough light, or the lens is covered by your finger or other object.

You cannot use [SUPER NSPLUS].

- The NIGHTSHOT PLUS switch is not set to ON (p. 20).

[COLOR SLOW S] does not operate correctly.

- [COLOR SLOW S] may not operate correctly in total darkness. Use NightShot plus or [SUPER NSPLUS].

Playback

Refer also to the “Cassette tapes/ “Memory Stick Duo”” section (p. 65).

You cannot play back a tape.

- Slide the POWER switch repeatedly to turn on the PLAY/EDIT lamp (p. 22).
- Rewind the tape (p. 22).

Image data stored on a “Memory Stick Duo” cannot be played back.

- Image data cannot be played back if you have modified file or folder names, or have edited the data on a computer (In this case, the file name flashes). This is not a malfunction (p. 75).
 - Pictures recorded on other devices may not be played back or may not appear in their actual size (p. 75).
-

Horizontal lines appear on the picture. The displayed pictures are not clear or do not appear.

- Clean the head using the cleaning cassette (optional) (p. 79).
-

No sound or only a low sound is heard.

- Turn up the volume (p. 22).
 - Adjust [AUDIO MIX] until the sound is heard appropriately (p. 45).
 - If you are using an S VIDEO plug, make sure the red and white plugs of the A/V connecting cable are also connected (p. 28).
-

The sound breaks off.

- Clean the head using the cleaning cassette (optional) (p. 79).
-

“----” is displayed on the screen.

- The tape you are playing was recorded without setting the date and time.
 - A blank section on the tape is being played.
 - The data code on a tape with a scratch or noise cannot be read.
-

Noises appear and **NIS** is displayed on the screen.

- The tape was recorded in a TV color system other than that of your camcorder (PAL). This is not a malfunction (p. 73).
-

4ch-12b is displayed on the screen.

- The tape you are playing was recorded on another device with a 4ch microphone (4CH MIC REC). Your camcorder is not compatible with 4ch microphone recording.
-

Date search does not work correctly.

- Be sure to record more than 2 minutes after the date changed. If one day’s recording is too short, your camcorder may not accurately find the point where the recording date changes.
 - There is a blank section in the beginning or between recorded sections of the tape. This is not a malfunction.
-

Dubbing/Editing/Connecting to other devices

Pictures output from the camcorder do not appear on the screen of the connected device.

- When attaching the camcorder to the Handycam Station, close the DC IN jack cover on the camcorder, and then fully insert the camcorder into the Handycam Station in the correct way securely (p. 8).
-

Pictures from connected devices cannot be zoomed (DCR-HC48E).

- You cannot zoom pictures from connected devices on your camcorder (p. 20).
-

Time code and other information appear on the display of the connected device.

- Set [DISP OUTPUT] to [LCD PANEL] while connected with an A/V connecting cable (p. 48).
-

You cannot dub correctly using the A/V connecting cable.

- The A/V connecting cable is not connected properly. Make sure that the A/V connecting cable is connected to the input jack of another device for dubbing a picture from your camcorder (p. 51).

New sound added to a recorded tape is not heard.

- Adjust [AUDIO MIX] until the sound is heard appropriately (p. 45).

Pictures from connected devices are not displayed correctly.

- The input signal is not PAL (p. 73).

Still pictures cannot be dubbed from a tape to a "Memory Stick Duo."

- You cannot record or a distorted picture may be recorded if the tape has been used repeatedly for recording.

The picture gets disturbed or dark, or the sounds get distorted.

- A/V connecting cables are connected to both your camcorder and the Handycam Station. Disconnect one of the A/V connecting cables.

Connecting to a computer

The computer does not recognize your camcorder.

- Install the "Picture Motion Browser" (p. 60).
- The computer may not recognize your camcorder for a few moments after you connect it. Wait for a while.
- Insert your camcorder into the Handycam Station correctly (p. 8).
- Disconnect USB devices other than the keyboard, the mouse, and the camcorder from the Ψ (USB) jack on the computer.

- Disconnect the cable from the computer and camcorder, restart the computer, then connect them again correctly.

You cannot install the supplied software, "Picture Motion Browser," on a Macintosh computer.

- You can install "Picture Motion Browser" only on a Windows computer.

Functions that cannot be used together

Depending on the functions, you may not be able to use them together. The following list shows examples of menu items and functions that cannot be used at the same time.

Not available	If this function is set
BACK LIGHT	[FIREWORKS], [SPOT METER], [EXPOSURE]
[SCENE SELECT]	NightShot plus, [TELE MACRO], [SUPER NSPLUS], [COLOR SLOW S]
[CANDLE], [FIREWORKS], [SPORTS]	When the POWER switch is set to CAMERA-MEMORY
[SPOT METER]	NightShot plus, [SUPER NSPLUS]
[EXPOSURE]	NightShot plus, [SUPER NSPLUS]
[WHITE BAL.]	NightShot plus, [SUPER NSPLUS]
[SPOT FOCUS]	[SCENE SELECT]
[TELE MACRO]	[SCENE SELECT]
[SUPER NSPLUS]	[FADER], [D.EFFECT]

Not available	If this function is set
[COLOR SLOW S]	NightShot plus, [SCENE SELECT], [SUPER NSPLUS], [FADER], [D.EFFECT]
[DIGITAL ZOOM]	[TELE MACRO]
[FADER]	[CANDLE], [FIREWORKS], [SUPER NSPLUS], [COLOR SLOW S], [D.EFFECT]
[D.EFFECT]	[CANDLE], [FIREWORKS], [SUPER NSPLUS], [COLOR SLOW S], [FADER]
[OLD MOVIE]	[PICT.EFFECT]

Warning indicators and messages

Self-diagnosis display/Warning indicators

If indicators appear on the LCD screen or in the viewfinder, check the following. Some symptoms you can fix by yourself. If the problem persists even after you have tried a couple of times, contact your Sony dealer or local authorized Sony service facility.

C:(or E): □□:□□ (Self-diagnosis display)

C:04:□□

- The battery pack is not an "InfoLITHIUM" battery pack (H series). Use an "InfoLITHIUM" battery pack (H series) (p. 76).
- Connect the DC plug of the AC Adaptor to the DC IN jack of your camcorder securely (p. 8).

C:21:□□

- Moisture condensation has occurred. Remove the cassette and leave your camcorder for at least 1 hour, then re-insert the cassette (p. 78).

C:22:□□

- Clean the head using a cleaning cassette (optional) (p. 79).

C:31:□□ / C:32:□□

- Symptoms that are not described above have occurred. Remove and insert the cassette, then operate your camcorder again. Do not perform this procedure if moisture condensation has occurred (p. 78).
- Remove the power source. Reconnect it and operate your camcorder again.
- Change the cassette. Press RESET (p. 86), and operate your camcorder again.

E:61:□□ / **E:62:**□□

- Contact your Sony dealer or local authorized Sony service facility. Inform them of the 5-digit code, which starts from “E.”

101-1001(Warning indicator pertaining to files)

- The file is damaged.
- The file is unreadable (p. 74).

⏻ (Battery level warning)

- The battery pack is nearly used up.
- Depending on the operating, environment, or battery conditions, ⏻ may flash, even if there are approximately 5 to 10 minutes remaining.

⏏ (Moisture condensation warning)*

- Eject the cassette, remove the power source, and then leave it for about 1 hour with the cassette lid open (p. 78).

🗑 (Warning indicator pertaining to “Memory Stick Duo”)

- A “Memory Stick Duo” is not inserted (p. 15).

🗑 (Warning indicators pertaining to “Memory Stick Duo” formatting)*

- The “Memory Stick Duo” is damaged.
- The “Memory Stick Duo” is not formatted correctly (p. 39, 74).

❓ (Warning indicator pertaining to incompatible “Memory Stick Duo”)*

- An incompatible “Memory Stick Duo” is inserted (p. 74).

🔒 (Warning indicators pertaining to the tape)

Slow flashing:

- There is less than 5 minutes remaining on the tape.
- No cassette is inserted.*
- The write-protect tab on the cassette is set to lock (p. 73).*

Fast flashing:

- The tape has run out.*

⚠ (Eject cassette warning)*

Slow flashing:

- The write-protect tab on the cassette is set to lock (p. 73).

Fast flashing:

- Moisture condensation has occurred (p. 78).
- The self-diagnosis display code is displayed (p. 70).

🔒 (Warning indicator pertaining to image deletion)*

- The image is protected (p. 56).

🗑 (Warning indicator pertaining to the write-protect of the “Memory Stick Duo”)*

- The write-protect tab on the “Memory Stick Duo” is set to lock (p. 75).

📷 (Warning indicator pertaining to camera-shake warning)





- The camcorder is unsteady, so camera-shake easily occurs. Hold the camcorder steady with both hands and shoot the image. However, note that the camera-shake warning indicator does not disappear.



* You hear a melody when the warning indicators appear on the screen (p. 48).

Examples of warning messages

If messages appear on the screen, follow the instructions.

Tips

- When  is displayed, the message can be turned into  by touching . Touch  to display the message again.

  **Moisture condensation. Eject the cassette** (p. 78)

 **Moisture condensation. Turn off for 1H.** (p. 78)

 **Reinsert the cassette.** (p. 14)

- Check if the cassette is damaged.

  **The tape is locked - check the tab.** (p. 73)

 **Reinsert the Memory Stick.**
(p. 15, 74)

- Reinsert the “Memory Stick Duo” a few times. If even then the indicator flashes, the “Memory Stick Duo” might be damaged. Try with another “Memory Stick Duo.”

 **This Memory Stick is not formatted correctly.**

- Check the format, then format the “Memory Stick Duo” as necessary (p. 39, 74).

Memory Stick folders are full.

- You cannot create folders exceeding 999MSDCF. You cannot delete created folders using your camcorder.
- You will have to format the “Memory Stick Duo” (p. 39), or delete them using your computer.

Check the connected device.

- Switch off the printer and switch it on again, then disconnect the USB cable and reconnect it.

Cannot print. Check the printer.

- Switch off the printer and switch it on again, then disconnect the USB cable and reconnect it.

Using your camcorder abroad

Power supply

You can use your camcorder in any country/region using the AC Adaptor supplied with your camcorder within the AC 100 V to 240 V, 50/60 Hz range.

On TV color systems

Your camcorder is PAL system, so its picture can only be viewed on a PAL system TV with an AUDIO/VIDEO input jack.

System	Used in
PAL	Australia, Austria, Belgium, China, Czech Republic, Denmark, Finland, Germany, Holland, Hong Kong, Hungary, Italy, Kuwait, Malaysia, New Zealand, Norway, Poland, Portugal, Singapore, Slovak Republic, Spain, Sweden, Switzerland, Thailand, United Kingdom, etc.
PAL - M	Brazil
PAL - N	Argentina, Paraguay, Uruguay.
SECAM	Bulgaria, France, Guiana, Iran, Iraq, Monaco, Russia, Ukraine, etc.
NTSC	Bahama Islands, Bolivia, Canada, Central America, Chile, Colombia, Ecuador, Guyana, Jamaica, Japan, Korea, Mexico, Peru, Surinam, Taiwan, the Philippines, the U.S.A., Venezuela, etc.

Simple setting of the clock by time difference

You can easily set the clock to the local time abroad by entering the time difference between where you live and where you are. Select [WORLD TIME] in the  (TIME/LANGU.) menu, then set the time difference (p. 49).

Maintenance and precautions

Usable cassette tapes

You can use mini DV format cassettes only. Use a cassette with the  mark.

Your camcorder is not compatible with the Cassette Memory function.

To prevent a blank section from being created on the tape

Go to the end of the recorded section using END SEARCH (p. 25) before you begin the next recording in the following cases:

- You have played back the tape.
- You have used EDIT SEARCH.

Copyright signal

■ When you play back

If the cassette you play back on your camcorder contains copyright signals, you cannot copy it to a tape in another video camera connected to your camcorder.

■ When you record (DCR-HC48E)

You cannot record software on your camcorder that contains copyright control signals for copyright protection of software. [Cannot record due to copyright protection.] appears on the LCD screen, or on the viewfinder if you try to record such software. Your camcorder does not record copyright control signals on the tape when it records.

Notes on use

■ When not using your camcorder for a long time

Remove the cassette and store it.

■ To prevent accidental erasure

Slide the write-protect tab on the cassette to set it to SAVE.

Maintenance and precautions (Continued)



REC: The cassette can be recorded.

SAVE: The cassette cannot be recorded (write-protected).



■ When labeling the cassette

Be sure to place the label only on the locations shown in the following illustration so as not to cause a malfunction of your camcorder.

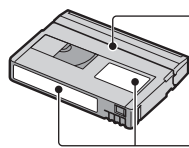

Do not put a label along this border.

Labeling position

■ After using the cassette

Rewind the tape to the beginning to avoid distortion of the picture or the sound. The cassette should then be put in its case, and stored in an upright position.

■ When cleaning the gold-plated connector

Generally, clean the gold-plated connector on a cassette with a cotton-wool swab after every 10 times it has been ejected. If the gold-plated connector on the cassette is dirty or dusty, the remaining tape indicator may not show correctly.

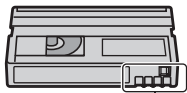

Gold-plated connector

About the “Memory Stick”

A “Memory Stick” is a compact, portable IC recording medium with a large data capacity. You can use only a “Memory Stick Duo,” which is about the half size of a standard “Memory Stick,” with your camcorder.

However, we do not guarantee the operation of all types of “Memory Stick Duo” on your camcorder.

Types of “Memory Stick”	Recording/Playback
“Memory Stick” (without MagicGate)	–
“Memory Stick Duo” (without MagicGate)*1	○
“MagicGate Memory Stick”	–
“Memory Stick Duo” (with MagicGate)*1	○*2*3
“MagicGate Memory Stick Duo” *1	○*3
“Memory Stick PRO”	–
“Memory Stick PRO Duo” *1	○*2*3

*1 A “Memory Stick Duo” is about half the size of a standard “Memory Stick.”

*2 The types of “Memory Stick” that support high speed data transfer. The speed of data transfer varies depending on the device to be used.

*3 “MagicGate” is a Sony-developed copyright protection technology that records and transfers contents in an encrypted format. Note that data that uses “MagicGate” technology cannot be recorded or played on your camcorder.

- Still image format: Your camcorder compresses and records image data in the JPEG (Joint Photographic Experts Group) format. The file extension is “.JPG.”
- File names of still images:
 - 101-0001: This file name appears on the screen of your camcorder.
 - DSC00001.JPG: This file name appears on the display of a computer.
- A “Memory Stick Duo” formatted by a computer (Windows OS/Mac OS) does not have guaranteed compatibility with your camcorder.

- Data read/write speed may vary depending on the combination of the “Memory Stick” and “Memory Stick” compliant product you use.

On a “Memory Stick Duo” with a write-protect tab

You can prevent accidental erasure of images when you slide the write-protect tab on the “Memory Stick Duo” with a small tapered object, to the write-protect position.

Notes on use

Damaged or lost image data will not be compensated for, and may occur in the following cases:

- If you eject the “Memory Stick Duo,” turn the power off on your camcorder, or remove the battery pack for replacement while your camcorder is reading or writing image files on the “Memory Stick Duo” (while the access lamp is lit or flashing).
- If you use the “Memory Stick Duo” near magnets or magnetic fields.

It is recommended you make a back-up of important data on the hard disk of a computer.

■ On handling a “Memory Stick”

Keep the following in mind when handling a “Memory Stick Duo.”

- Be careful not to apply excessive force when writing on a memo area on a “Memory Stick Duo.”
- Do not attach a label or the like on a “Memory Stick Duo” or a Memory Stick Duo adaptor.
- When you carry or store a “Memory Stick Duo,” put it in its case.
- Do not touch, or allow metallic objects to come into contact with the terminals.
- Do not bend, drop or apply strong force to the “Memory Stick Duo.”
- Do not disassemble or modify the “Memory Stick Duo.”
- Do not let the “Memory Stick Duo” get wet.
- Be careful to keep “Memory Stick Duo” media out of the reach of small children. There is danger that a child might swallow it.

- Do not insert anything other than a “Memory Stick Duo” into the “Memory Stick Duo” slot. Doing so may cause a malfunction.

■ On a location for use

Do not use or keep the “Memory Stick Duo” in the following locations.

- Places subject to extremely high temperature, such as a car parked outside in the summer.
- Places under direct sunlight.
- Places with extremely high humidity or subject to corrosive gases.

■ On the Memory Stick Duo adaptor

After inserting a “Memory Stick Duo” into the Memory Stick Duo adaptor, you can use it with a standard “Memory Stick” compliant device.

- When using a “Memory Stick Duo” with a “Memory Stick” compliant device, be sure to insert the “Memory Stick Duo” into a Memory Stick Duo adaptor.
- When inserting a “Memory Stick Duo” into a Memory Stick Duo adaptor, make sure the “Memory Stick Duo” is inserted facing in the correct direction, then insert it all the way in. Note that improper use may cause a malfunction. Also, if you force the “Memory Stick Duo” into the “Memory Stick Duo” slot in the wrong direction, the Memory Stick Duo adaptor may be damaged.
- Do not insert a Memory Stick Duo adaptor without a “Memory Stick Duo” attached. Doing so may result in malfunctions of the unit.

■ On a “Memory Stick PRO Duo”

- The maximum memory capacity of a “Memory Stick PRO Duo” that can be used on your camcorder is 4 GB.
- This unit does not support high speed data transfer.

On image data compatibility

- Image data files recorded on a “Memory Stick Duo” by your camcorder conform to the “Design rule for Camera File system” universal standard established by the JEITA (Japan Electronics and Information Technology Industries Association).
- On your camcorder, you cannot play back still images recorded on other devices (DCR-TRV900E or DSC-D700/D770) that do not

Maintenance and precautions (Continued)

conform to the universal standard. (These models are not sold in some regions.)

- If you cannot use a “Memory Stick Duo” that has been used with another device, format it with your camcorder (p. 39). Note that formatting erases all information on the “Memory Stick Duo.”
- You may not be able to play back images with your camcorder:
 - When playing back image data modified on your computer.
 - When playing back image data recorded with other devices.

About the “InfoLITHIUM” battery pack

This unit is compatible with an “InfoLITHIUM” battery pack (H series). Your camcorder operates only with an “InfoLITHIUM” battery pack. “InfoLITHIUM” H series battery packs have the  mark.

What is an “InfoLITHIUM” battery pack?

An “InfoLITHIUM” battery pack is a lithium-ion battery pack that has functions for communicating information related to operating conditions between your camcorder and an optional AC Adaptor/charger.

The “InfoLITHIUM” battery pack calculates the power consumption according to the operating conditions of your camcorder, and displays the remaining battery time in minutes.

To charge the battery pack

- Be sure to charge the battery pack before you start using your camcorder.
- We recommend charging the battery pack in an ambient temperature of between 10 °C to 30 °C (50 °F to 86 °F) until the CHG (charge) lamp turns off. If you charge the battery pack outside of this temperature range, you may not be able to charge it efficiently.
- When charging the battery pack while the AC Adaptor is connected to your camcorder, after

charging is complete, disconnect the cable from the DC IN jack on your camcorder or remove the battery pack.

To use the battery pack effectively

- Battery pack performance decreases when the surrounding temperature is 10 °C (50 °F) or below, and the length of time you can use the battery pack becomes shorter. In that case, do one of the following to use the battery pack for a longer time.
 - Put the battery pack in a pocket to warm it up, and insert it in your camcorder right before you start taking shots.
 - Use a large capacity battery pack: NP-FH70/FH100 (optional).
- Frequent use of the LCD screen or a frequent playback, fast forward or rewind operation wears out the battery pack faster. We recommend using a large capacity battery pack: NP-FH70/FH100 (optional).
- Be sure to set the POWER switch to OFF (CHG) when not recording or playing back on your camcorder. The battery pack is also consumed when your camcorder is in recording standby or playback pause.
- Have spare battery packs ready for two or three times the expected recording time, and make trial recordings before making the actual recording.
- Do not expose the battery pack to water. The battery pack is not water resistant.

About the remaining battery time indicator

- When the power goes off even though the remaining battery time indicator indicates that the battery pack has enough power to operate, charge the battery pack fully again. Remaining battery time will be indicated correctly. Note, however, that the battery indication will not be restored if it is used in high temperatures for a long time, or if left in a fully charged state, or when the battery pack is frequently used. Use the remaining battery time indication as a rough guide only.
- The  mark that indicates low battery flashes even if there are still 5 to 10 minutes of battery time remaining, depending on the operating conditions or ambient temperature.

About storage of the battery pack

- If the battery pack is not used for a long time, fully charge the battery pack and use it up on your camcorder once a year to maintain proper function. To store the battery pack, remove it from your camcorder and put it in a dry, cool place.
- To discharge the battery pack on your camcorder completely, set [A.SHUT OFF] to [NEVER] on the  (STANDARD SET) menu and leave your camcorder in tape recording standby until the power goes off (p. 48).

About battery life

- Battery capacity decreases over time and through repeated use. If decreased usage time between charges becomes significant, it is probably time to replace it with a new one.
- Each battery's life is governed by storage, operating and environmental conditions.

About i.LINK

The DV Interface on this unit is an i.LINK-compliant DV Interface. This section describes the i.LINK standard and its features.

What is i.LINK?

i.LINK is a digital serial interface for transferring digital video, digital audio, and other data to other i.LINK-compatible devices. You can also control other devices using the i.LINK.

i.LINK-compatible devices can be connected using an i.LINK cable. Possible applications are operations and data transactions with various digital AV devices.

When two or more i.LINK-compatible devices are daisy-chained with the unit, operation becomes possible from any device in the chain. Note that operation method may vary, or data transactions may not be possible, depending on specifications and characteristics of the connected devices.

- Normally, only one device can be connected to this unit with an i.LINK cable. When connecting this unit to an i.LINK-compatible device having two or more DV Interfaces, refer to the operating instructions of the device to be connected.
- i.LINK is a more familiar term for the IEEE 1394 data transport bus proposed by Sony, and is a trademark approved by many corporations.
- IEEE 1394 is an international standard standardized by the Institute of Electrical and Electronics Engineers.

About the i.LINK Baud rate

i.LINK's maximum baud rate varies according to the device. There are 3 types.

S100 (approx. 100Mbps*)

S200 (approx. 200Mbps)

S400 (approx. 400Mbps)

The baud rate is listed under "Specifications" in the operating instructions of each piece of equipment. It is also indicated near the i.LINK interface on some devices.

The baud rate may differ from the indicated value when the unit is connected to a device with a different maximum baud rate.

* What is Mbps?

Mbps stands for "megabits per second," or the amount of data that can be sent or received in one second. For example, a baud rate of 100 Mbps means that 100 megabits of data can be sent in one second.

To use i.LINK functions on this unit

For details on how to dub when this unit is connected to other video devices having a DV Interface, see page 51, 53.

This unit can also be connected to other i.LINK (DV Interface) compatible devices made by Sony (e.g. a VAIO series personal computer) as well as to video devices. Some i.LINK compatible video devices, such as Digital Televisions, DVD, MICROMV or HDV recorders/players are not compatible with DV devices. Before

Maintenance and precautions (Continued)

connecting to other devices, be sure to confirm whether the device is compatible with a DV device or not. For details on precautions and compatible application software, refer also to the operating instructions for the device to be connected.

🔌 Notes

- When connecting your camcorder to another i.LINK-compatible device, be sure to turn off the power of the device and disconnect the AC Adaptor from the wall socket before connecting or disconnecting the i.LINK cable.

About the required i.LINK cable

Use the Sony i.LINK 4-pin-to-4-pin cable (during DV dubbing).

On using your camcorder

On use and care

- Do not use or store the camcorder and accessories in the following locations.
 - Anywhere extremely hot, cold or humid. Never leave them exposed to temperatures above 60 °C (140 °F), such as under direct sunlight, near heaters or in a car parked in the sun. They may malfunction or become deformed.
 - Near strong magnetic fields or mechanical vibration. The camcorder may malfunction.
 - Near strong radio waves or radiation. The camcorder may not be able to record properly.
 - Near AM receivers and video equipment. Noise may occur.
 - On a sandy beach or anywhere dusty. If sand or dust gets in your camcorder, it may malfunction. Sometimes this malfunction cannot be repaired.
 - Near windows or outdoors, where the LCD screen, the viewfinder, or the lens may be exposed to direct sunlight. This damages the inside of the viewfinder or the LCD screen.
- Operate your camcorder on DC 6.8 V/7.2 V (battery pack) or DC 8.4 V (AC Adaptor).
- For DC or AC operation, use the accessories recommended in these operating instructions.
- Do not let your camcorder get wet, for example, from rain or sea water. If your camcorder gets



wet, it may malfunction. Sometimes this malfunction cannot be repaired.

- If any solid object or liquid gets inside the casing, unplug your camcorder and have it checked by a Sony dealer before operating it any further.
- Avoid rough handling, disassembling, modifying, physical shock, or impact such as hammering, dropping or stepping on the product. Be particularly careful of the lens.
- Keep the POWER switch setting to OFF (CHG) when you are not using your camcorder.
- Do not wrap your camcorder with a towel, for example, and operate it. Doing so might cause heat to build up inside.
- When disconnecting the mains lead, pull it by the plug and not the lead.
- Do not damage the mains lead such as by placing anything heavy on it.
- Keep metal contacts clean.
- Keep the Remote Commander and button-type battery out of children's reach. If the battery is accidentally swallowed, consult a doctor immediately.
- If the battery electrolytic liquid has leaked,
 - consult your local authorized Sony service facility.
 - wash off any liquid that may have contacted your skin.
 - if any liquid gets in your eyes, wash with plenty of water and consult a doctor.

■ When not using your camcorder for a long time

- Periodically turn on the camcorder and play a cassette for about 3 minutes.
- Use up the battery pack completely before storing it.



Moisture condensation

If your camcorder is brought directly from a cold place to a warm place, moisture may condense inside your camcorder, on the surface of the tape, or on the lens. In this state, the tape may stick to the head drum and be damaged or your camcorder may not operate correctly. If there is moisture inside your camcorder, []  Moisture condensation. Eject the cassette] or [] Moisture condensation. Turn off for 1H.]

appears. The indicator will not appear when the moisture condenses on the lens.

■ If moisture condensation has occurred

None of the functions except cassette ejection will work. Eject the cassette, turn off your camcorder, and leave it for about one hour with the cassette lid open. Your camcorder can be used again when both of the following conditions are met:

- The warning message does not appear when the power is turned on.
- Neither  or  flash when a cassette is inserted and video operation buttons are touched. If moisture starts to condense, your camcorder sometimes cannot detect condensation. If this happens, the cassette is sometimes not ejected for 10 seconds after the cassette lid is opened. This is not a malfunction. Do not close the cassette lid until the cassette is ejected.

■ Note on moisture condensation

Moisture may condense when you bring your camcorder from a cold place into a warm place (or vice versa) or when you use your camcorder in a humid place as shown below.

- When you bring your camcorder from a ski slope into a place warmed up by a heating device.
- When you bring your camcorder from an air conditioned car or room into a hot place outside.
- When you use your camcorder after a squall or a shower.
- When you use your camcorder in a hot and humid place.



■ How to avoid moisture condensation

When you bring your camcorder from a cold place into a warm place, put your camcorder in a plastic bag and seal it tightly. Remove the bag when the air temperature inside the plastic bag has reached the surrounding temperature (after about one hour).

Video head

- If the video heads are dirty, video or sound distortion may be apparent.
- If the following problem occurs, clean the video heads for 10 seconds with the Sony DVM-12CLD cleaning cassette (optional).
 - Mosaic-pattern noise appears on the playback picture or the screen is displayed in blue.



- Playback pictures do not move.
- Playback pictures do not appear or the sound breaks off.
-   Dirty video head. Use a cleaning cassette.] appears on the screen during recording/playback.
- The video heads will wear after long use. If you cannot obtain a clear image even after using a cleaning cassette (optional), it might be because the video heads are worn. Please contact your Sony dealer or local authorized Sony service facility to have the video heads replaced.

LCD screen

- Do not exert excessive pressure on the LCD screen, as it may cause damage.
- If your camcorder is used in a cold place, a residual image may appear on the LCD screen. This is not a malfunction.
- While using your camcorder, the back of the LCD screen may heat up. This is not a malfunction.

■ To clean the LCD screen

If fingerprints or dust make the LCD screen dirty, it is recommended you use a soft cloth to clean it. When you use the LCD Cleaning Kit (optional), do not apply the cleaning liquid directly to the LCD screen. Use cleaning paper moistened with the liquid.

■ On adjustment of the touch panel (CALIBRATION)

The buttons on the touch panel may not work correctly. If this happens, follow the procedure below.

Maintenance and precautions (Continued)

It is recommended you connect your camcorder to the wall socket using the supplied AC Adaptor during the operation.

- Slide the POWER switch repeatedly to turn on the PLAY/EDIT lamp.
- Touch [P-MENU] → [MENU] →  (STANDARD SET) → [CALIBRATION] → [OK].

The screen changes to 16:9 ratio when using 4:3 ratio.

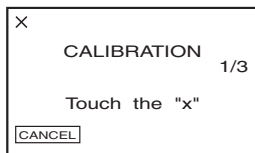

- Touch the “x” displayed on the screen with the corner of the “Memory Stick Duo” or the like.

The position of the “x” changes.

To cancel [CALIBRATION], touch [CANCEL] in step ③.

If you did not press the right spot, start from step ③ again.

Notes

- You cannot calibrate the LCD screen if it is rotated.

On handling the casing

- If the casing is soiled, clean the camcorder body with a soft cloth lightly moistened with water, and then wipe the casing with a dry soft cloth.
- Avoid the following to avoid damage to the finish.
 - Using chemicals such as thinner, benzene, alcohol, chemical cloths, repellent, insecticide and sunscreen.
 - Handling with above substances on your hands.
 - Leaving the casing in contact with rubber or vinyl objects for a long period of time.

About care and storage of the lens

- Wipe the surface of the lens clean with a soft cloth in the following instances:
 - When there are fingerprints on the lens surface.
 - In hot or humid locations
 - When the lens is exposed to salty air such as at the seaside.
- Store in a well-ventilated location subject to little dirt or dust.
- To prevent mold, periodically clean the lens as described above. It is recommended that you operate your camcorder about once a month to keep it in optimum state for a long time.

To remove dust from inside the viewfinder

- Pull out the viewfinder.
- While pushing in the tab on the side with a fine-tipped implement such as a ball point pen, pull the eyecup block in the direction of the arrow to remove.

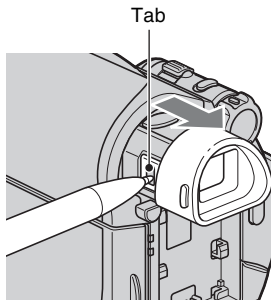

- Remove dust from the eyecup block with a camera blower, etc.

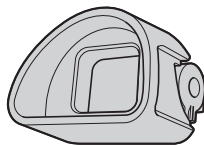

- Press the viewfinder onto the body of the camcorder.

- ⑤ Remove dust from the inside area where the eyecup block was attached with a camera blower, etc.

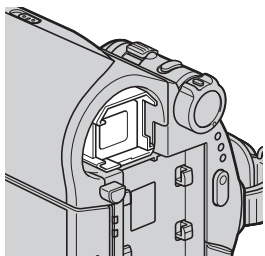

- ⑥ Attach the eyecup block to the viewfinder, pushing it straight on until it clicks.

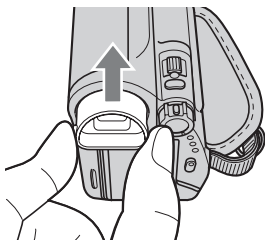

⚡ Notes

- The eyecup block is a precision part. Do not disassemble it further.
- Do not touch the lens of the eyecup block.

On charging the pre-installed rechargeable battery

Your camcorder has a pre-installed rechargeable battery to retain the date, time, and other settings even when the POWER switch is set to OFF (CHG). The pre-installed rechargeable battery is always charged while your camcorder is connected to the wall socket via the AC Adaptor or while the battery pack is attached. The rechargeable battery will be fully discharged in about **3 months** if you do not use your camcorder at all without the

AC Adaptor connected or the battery pack attached. Use your camcorder after charging the pre-installed rechargeable battery.

However, even if the pre-installed rechargeable battery is not charged, the camcorder operation will not be affected as long as you are not recording the date.

■ Procedures

Connect your camcorder to a wall socket using the supplied AC Adaptor, and leave it with the POWER switch set to OFF (CHG) for more than 24 hours.

To change the battery of the Remote Commander

- ① While pressing on the tab, inset your fingernail into the slit to pull out the battery case.
- ② Place a new battery with the + side facing up.
- ③ Insert the battery case back into the Remote Commander until it clicks.

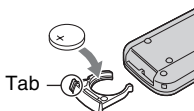

WARNING

Battery may explode if mistreated. Do not recharge, disassemble or dispose of in fire.

⚡ Notes

- When the lithium battery becomes weak, the operating distance of the Remote Commander may shorten, or the Remote Commander may not function properly. In this case, replace the battery with a Sony CR2025 lithium battery. Use of another battery may present a risk of fire or explosion.

Specifications

System

Video recording system

2 rotary heads, Helical scanning system

Still image recording system

Exif Ver. 2.2*

Audio recording system

Rotary heads, PCM system

Quantization: 12 bits (Fs 32 kHz, stereo
1, stereo 2), 16 bits (Fs 48 kHz, stereo)

Video signal

PAL color, CCIR standards

Usable cassette

Mini DV cassette with the **Mini DV** mark
printed

Tape speed

SP: Approx. 18.81 mm/s

LP: Approx. 12.56 mm/s

Recording/playback time

SP: 60 min (using a DVM60 cassette)

LP: 90 min (using a DVM60 cassette)

Fast forward/rewind time

Approx. 2 min 40 s (using a DVM60
cassette and rechargeable battery pack)

Approx. 1 min 45 s (using a DVM60
cassette and AC Adaptor)

Viewfinder

Electric viewfinder (0.27 type, aspect
ratio 16:9, 123 200 dots)

Image device

3 mm (1/6 type) CCD (Charge Coupled
Device)

Gross: Approx. 1 070 000 pixels

Effective (still): 1 000 000 pixels

Effective (movie): 690 000 pixels

Lens

Carl Zeiss Vario-Tessar

25 × (Optical), 2 000 × (Digital)

Focal length

f=2.5 ~ 62.5 mm (1/8 ~ 2 1/2 in.)

When converted to a 35 mm still
camera

In CAMERA-TAPE:

41 ~ 1 189 mm** (1 5/8 ~ 46 7/8 in.)
(16:9)

43 ~ 1 075 mm (1 3/4 ~ 42 3/8 in.) (4:3)

In CAMERA-MEMORY:

36 ~ 900 mm (1 7/16 ~ 35 1/2 in.) (4:3)

39 ~ 975 mm (1 9/16 ~ 38 1/2 in.) (16:9)

F1.8 ~ 3.2

Filter diameter: 30 mm (1 3/16 in.)

Color temperature

[AUTO], [ONE PUSH], [INDOOR]
(3 200 K), [OUTDOOR] (5 800 K)

Minimum illumination

4 lx (lux) (AUTOSLW SHTR ON,
Shutter speed 1/25 s)

0 lx (lux) (during NightShot plus
function)

* "Exif" is a file format for still images,
established by the JEITA (Japan
Electronics and Information Technology
Industries Association). Files in this
format can have additional information
such as your camcorder's setting
information at the time of recording.

**The focal length figures are actual figures
resulting from wide angle pixel read-out.

Output connectors

Audio/Video output

10-pin connector

Video signal: 1 Vp-p, 75 Ω (ohms)

Luminance signal: 1 Vp-p, 75 Ω (ohms)

Chrominance signal: 0.3 Vp-p, 75 Ω
(ohms)

Audio signal: 327 mV (at load
impedance 47 kΩ (kilohms)), Output
impedance with less than 2.2 kΩ
(kilohms)

LCD screen

Picture

6.9 cm (2.7 type, aspect ratio 16:9)

Total dot number

123 200 (560 × 220)

General

Power requirements

- DC 6.8 V/7.2 V (battery pack)
- DC 8.4 V (AC Adaptor)

Average power consumption

- During camera recording using the viewfinder 2.5 W
- During camera recording using the LCD 2.8 W

Operating temperature

- 0 °C to 40 °C (32 °F to 104 °F)

Storage temperature

- 20 °C to + 60 °C (-4 °F to + 140 °F)

Dimensions (approx.)

- 63 × 85 × 114 mm
(2 1/2 × 3 3/8 × 4 1/2 in.) (w/h/d)
including the projecting parts
- 63 × 85 × 115 mm
(2 1/2 × 3 3/8 × 4 5/8 in.) (w/h/d)
including the projecting parts with
supplied battery pack NP-FH40
attached

Mass (approx.)

- 400 g (14 oz) main unit only,
- 465 g (1 lb) including the NP-FH40
rechargeable battery pack and DVM60
cassette

Supplied accessories

- See page 7.

Handycam Station Input/Output connectors

DCRA-C155 (DCR-HC48E)

Audio/Video output

- 10-pin connector
- Video signal: 1 Vp-p, 75 Ω (ohms)
- Luminance signal: 1 Vp-p, 75 Ω (ohms)
- Chrominance signal: 0.3 Vp-p, 75 Ω
(ohms)
- Audio signal: 327 mV (at load
impedance 47 kΩ (kilohms)), Output
impedance with less than 2.2 kΩ
(kilohms)

USB jack

- mini-B

DV input/output

- i.LINK Interface (IEEE1394, 4-pin
connector S100)

DCRA-C156 (DCR-HC47E)

Audio/Video output

- 10-pin connector
- Video signal: 1 Vp-p, 75 Ω (ohms)
- Luminance signal: 1 Vp-p, 75 Ω (ohms)
- Chrominance signal: 0.3 Vp-p, 75 Ω
(ohms)
- Audio signal: 327 mV (at load
impedance 47 kΩ (kilohms)), Output
impedance with less than 2.2 kΩ
(kilohms)

USB jack

- mini-B

DV output

- i.LINK Interface (IEEE1394, 4-pin
connector S100)

AC Adaptor AC-L200/L200B

Power requirements

- AC 100 V - 240 V, 50/60 Hz

Current consumption

- 0.35 - 0.18 A

Power consumption

- 18 W

Output voltage

- DC 8.4 V*

Operating temperature

- 0 °C to 40 °C (32 °F to 104 °F)

Storage temperature

- 20 °C to + 60 °C (-4 °F to + 140 °F)

Dimensions (approx.)

- 48 × 29 × 81 mm
(1 15/16 × 1 3/16 × 3 1/4 in.) (w/h/d)
excluding the projecting parts

Mass (approx.)

- 170 g (6.0 oz) excluding the mains lead

Specifications (Continued)

* See the label on the AC Adaptor for other specifications.

Rechargeable battery pack NP-FH40

Maximum output voltage

DC 8.4 V

Output voltage

DC 7.2 V

Capacity

4.9 Wh (680 mAh)

Dimensions (approx.)

31.8 × 18.5 × 45.0 mm
(1 5/16 × 3/4 × 1 13/16 in.) (w/h/d)

Mass (approx.)

45 g (1.6 oz)

Operating temperature

0 °C to 40 °C (32 °F to 104 °F)

Type

Lithium ion

Design and specifications are subject to change without notice.

On trademarks

- “Handycam” and **HANDYCAM** are registered trademarks of Sony Corporation.
- “Memory Stick,” “,” “Memory Stick Duo,” “**MEMORY STICK DUO**,” “Memory Stick PRO Duo,” “**MEMORY STICK PRO DUO**,” “MagicGate,” “**MAGIC GATE**,” “MagicGate Memory Stick” and “MagicGate Memory Stick Duo” are trademarks of Sony Corporation.
- “InfoLITHIUM” is a trademark of Sony Corporation.
- i.LINK and  are trademarks of Sony Corporation.
- Mini  Digital Video Cassette is a trademark.
- Microsoft, Windows, and Windows Media are trademarks or registered trademarks of U.S. Microsoft Corporation in the U.S. and other countries.
- Macintosh and Mac OS are registered trademarks of Apple Computer, Inc in the U.S. and other countries.
- Pentium is a trademark or registered trademark of Intel Corporation.
- Adobe and Adobe Reader are either registered trademarks or trademarks of Adobe Systems Incorporated in the United States and/or other countries.

All other product names mentioned herein may be the trademarks or registered trademarks of their respective companies. Furthermore, TM and “®” are not mentioned in each case in this manual.

Identifying parts and controls

The numbers in () are reference pages.

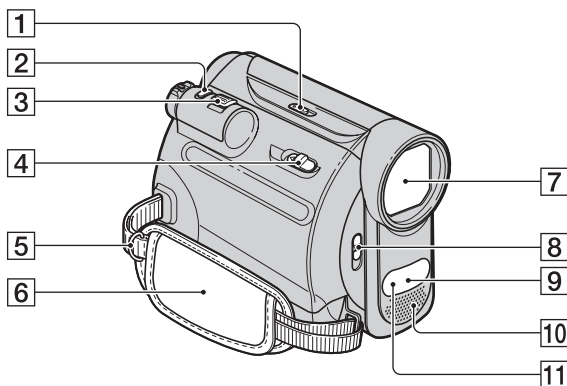

- 1** NIGHTSHOT PLUS switch (20)
- 2** PHOTO button (16, 19)
- 3** Power zoom lever (20, 24)
- 4** OPEN/EJECT lever (14)
- 5** Hooks for a shoulder belt
Attach a shoulder belt (optional).
- 6** Grip belt (13)
- 7** Lens (Carl Zeiss Lens) (4)
- 8** LENS COVER switch (12)
- 9** Remote sensor
Point the Remote Commander (88)
towards the remote sensor to operate
your camcorder.
- 10** Internal stereo microphone (45)
- 11** Infrared port (20)

Identifying parts and controls (Continued)

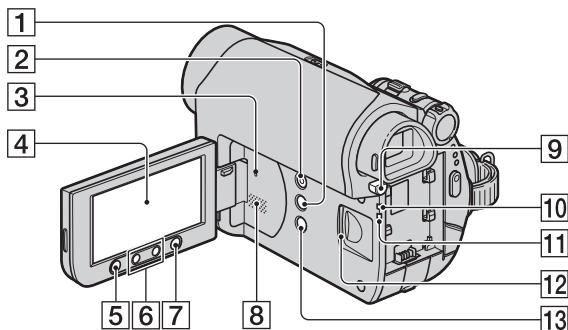

- 1** DISP/BATT INFO button (10, 12)
- 2** EASY button (16)
- 3** RESET button
Initializes all the settings, including the setting of the date and time.
- 4** LCD screen/touch panel (12, 89)
- 5** REC START/STOP button (16, 18)
- 6** Zoom buttons (20, 24)
- 7** WIDE SELECT button (21)
- 8** Speaker
Playback sound comes out from the speaker. For how to adjust the volume, see page 22.
- 9** BATT (battery release) PUSH button (9)
- 10** CHG (charge) lamp (8)
- 11** Access lamp (15)
- 12** "Memory Stick Duo" slot (15)
- 13** BACK LIGHT button (21)

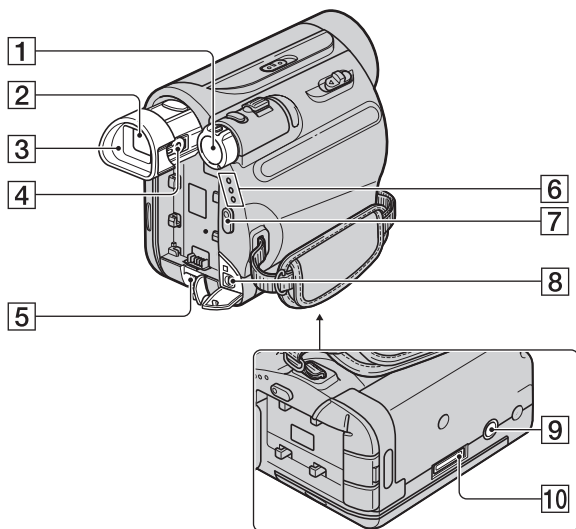

- 1** POWER switch (11)
- 2** Viewfinder (13)
- 3** Eyecup (80)
- 4** Viewfinder lens adjustment lever (13)
- 5** DC IN jack (9)
- 6** CAMERA-TAPE, CAMERA-MEMORY, PLAY/EDIT lamp (11)
- 7** REC START/STOP button (16, 18)
- 8** A/V OUT jack (28, 51)
- 9** Tripod receptacle
Attach the tripod (optional: the length of the screw must be less than 5.5 mm (7/32 in.)) to the tripod receptacle using a tripod screw.
- 10** Interface connector

Identifying parts and controls (Continued)

Handycam Station

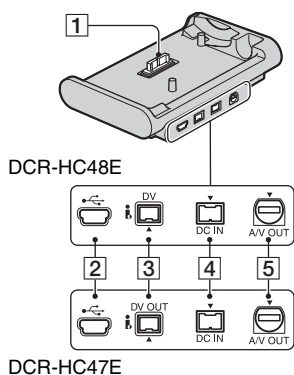

- 1 Interface connector
- 2 USB (USB) jack (57)
- 3 For DCR-HC48E:
DV interface (51, 53)
For DCR-HC47E:
DV OUT interface (51)
- 4 DC IN jack (8)
- 5 A/V OUT jack (28, 51)

Remote Commander

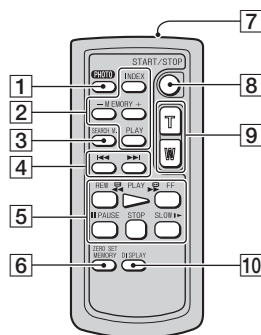

Insulation sheet

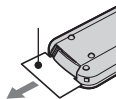

Notes

- Remove the insulation sheet before using the Remote Commander.
- Aim the Remote Commander towards the remote sensor to operate your camcorder (p. 85).
- To change the battery, see page 81.

- 1 PHOTO button* (16, 19)
The on-screen image when you press this button will be recorded onto the "Memory Stick Duo" as a still image.
- 2 Memory control buttons (Index**, -/+, Memory playback) (17, 23)
- 3 SEARCH M. button (27)**
- 4 Previous/Next buttons (27)**
- 5 Video control buttons (Rewind, Playback, Fast-forward, Pause, Stop, Slow) (17, 22)
- 6 ZERO SET MEMORY button (26)**
- 7 Transmitter
- 8 REC START/STOP button (16, 18)
- 9 Power zoom buttons (20, 24)
- 10 DISPLAY button
Toggles the screen indicators (such as Battery Info) on or off.

* Not available during Easy Handycam operation with the POWER switch set to CAMERA-TAPE.

** Not available during Easy Handycam operation.

Indicators displayed during recording/playback

Recording movies

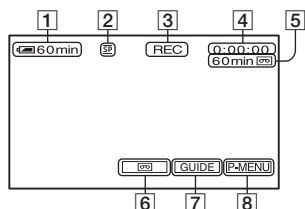

- 1 Remaining battery (approx.)
- 2 Recording mode (SP or LP) (46)
- 3 Recording status ([STBY] (standby) or [REC] (recording))
- 4 Recording: Tape counter (hour: minute: second)
Playback: Tape counter (hour: minute: second)/Time code (hour: minute: second: frame)
- 5 Recording capacity of the tape (approx.) (48)
- 6 END SEARCH/EDIT SEARCH/Rec review display switch button (26)
- 7 GUIDE button (24)
- 8 Personal Menu button (30)

Recording still images

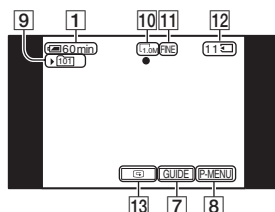

- 9 Recording folder (40)
- 10 Image size (21, 38)
- 11 Quality (FINE or STD) (38)
- 12 "Memory Stick Duo" indicator and the number of images that can be recorded (approx.)
- 13 Review button (19)

Viewing movies

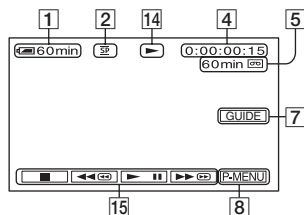

- 14 Tape transport indicator
- 15 Video operation buttons (22)

Viewing still images

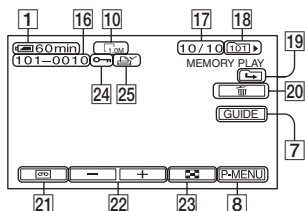

- 16** Data file name
- 17** Picture number/Total number of recorded pictures in the current playback folder
- 18** Playback folder (40)

19 Previous/Next folder icon

The following indicators appear when the first or last picture of the current folder is displayed and when there are multiple folders on the same “Memory Stick Duo.”

- : Touch to move to the previous folder.
- : Touch to move to the next folder.
- : Touch / to move to either the previous or the next folder.

- 20** Image delete button (55)
- 21** Tape playback select button (23)
- 22** Previous/Next image button (23)
- 23** Index screen display button (23)
- 24** Image protection mark (56)
- 25** Print mark (56)

Indicators when you made changes

You can use the [DISP GUIDE] (p. 91) to check the function of each indicator that appears on the LCD screen.

Notes

- Some of the indicators may not appear when you use [DISP GUIDE].

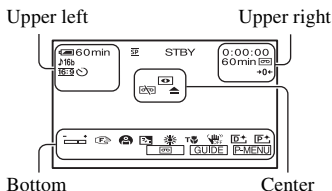

Upper left

Indicator	Meaning
J16b	AUDIO MODE (46)
BRK	Continuous photo recording (38)
	Self-timer recording (37)
16:9	WIDE SELECT (21)
	Interval photo recording (43)

Upper right

Indicator	Meaning
DVIN	DV input (53)
DVOUT	DV output (51)
i.LINK	i.LINK connection (51, 53)
+0+	Zero set memory (26, 88)
	LCD backlight off (12)

Center

Indicator	Meaning
	Slide show (41)
	NightShot plus (20)
	Super NightShot plus (36)
	Color Slow Shutter (36)
	PictBridge connecting (57)
	Warning (70)

Bottom

Indicator	Meaning
	Picture effect (42)
	Digital effect (41)
	Manual focus (35)
	SCENE SELECT (33)
	Backlight (21)
	White balance (34)
	SteadyShot off (37)
	Tele macro (36)
	Flexible spot meter (34)/ EXPOSURE (34)

Other indicator

Indicator	Meaning
	Information (72)

Data code during recording

The date/time during recording and the camera setting data will be recorded automatically. They do not appear on the screen during recording, but you can check them as [DATA CODE] during playback (p. 47).

Checking the screen indicators (Display guide)

You can easily check the meaning of each indicator that appears on the LCD screen.

- ① Touch [GUIDE] → [DISP GUIDE].

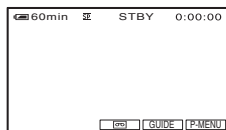

- ② Touch the area including the indicator that you want to check.

The meanings of the indicators in the area are listed on the screen. If you cannot find the indicator you want to check, touch / to toggle.

To finish the operation, touch [END].

Tips

- You can also operate by touching → [DISP GUIDE].

Index

Numeric/Symbol

12BIT.....	46
16BIT.....	46
21-pin adaptor.....	29

A

A.SHUT OFF (Auto shut off).....	48
A/V connecting cable.....	28, 51
AC Adaptor.....	8
ALL ERASE.....	39
Aspect ratio.....	21
AUD DUB CTRL (Audio dubbing).....	45
AUDIO MIX.....	45
AUDIO MODE.....	46
AUTOSLW SHTR (Auto Slow Shutter).....	35

B

B&W.....	42
BACK LIGHT.....	21, 67
Battery.....	8, 76
BEACH.....	33
BEEP.....	48
BLACK FADER.....	40
BURST.....	38

C

CALIBRATION.....	79
CAMERA DATA.....	47
CAMERA SET menu.....	33
CANDLE.....	33
Cassette.....	14, 73
CD-ROM.....	59
Charging time.....	10
Cleaning cassette.....	79
CLOCK SET.....	11
COLOR SLOW S (Color Slow Shutter).....	36, 67
Computer.....	59

D

D.EFFECT (Digital effect).....	41
DATA CODE.....	12, 47, 91
Date search.....	27
DATE/TIME.....	12, 47, 91
Delete pictures.....	55
DEMO MODE.....	43
DIGITAL ZOOM.....	37
DISP GUIDE (Display guide).....	91
DISP OUTPUT.....	48
Display indicators.....	89
DOT FADER.....	41
Dubbing.....	51, 55

E

Easy Handycam.....	16, 30
EDIT SEARCH.....	26
EDIT/PLAY menu.....	44
END SEARCH.....	25, 46
EXP.BRKTG (Exposure bracketing).....	38
EXPOSURE.....	34

F

FADER.....	40
FILE NO. (File number).....	40
FINE.....	38
FIREWORKS.....	33
First Step Guide.....	59, 62
FLASH (Flash motion).....	42
Flexible spot meter.....	34
FOCUS.....	35, 66
FORMAT.....	39, 74
Frame-by-frame Playback.....	44

G

Getting Started.....	7
----------------------	---

H

Handycam Station.....	8, 88
-----------------------	-------

I

i.LINK.....	77
i.LINK cable.....	51, 53
Image protection.....	56
IMAGE SIZE.....	38
INDOOR.....	34
“InfoLITHIUM” battery pack.....	76
Install.....	60
INT.REC-STL (Interval photo recording).....	43

L

LANDSCAPE.....	33
LANGUAGE.....	49
LCD backlight.....	12, 64
LCD BL LEVEL (LCD back light level).....	47
LCD BRIGHT.....	47
LCD COLOR.....	47
LCD PANEL.....	48
LCD screen.....	12
LCD BL LEVEL (LCD back light level).....	47
LCD BRIGHT.....	47
LCD COLOR.....	47
LCD/VF SET.....	47
LP (Long Play).....	46
LUMI. KEY (Luminance key).....	42

M

Macintosh.....	62
Maintenance and precautions.....	73
MEMORY SET menu.....	38
“Memory Stick”.....	74
“Memory Stick Duo”.....	15
Menu.....	30, 31

MENU ROTATE.....	48
Mirror mode.....	21
Moisture condensation.....	78
MONOTONE.....	40
MOSAIC.....	42
MOSAIC FADER.....	40
Movie.....	16, 17, 18, 22

N

NEG.ART.....	42
NEW FOLDER.....	40
NORMAL.....	38
NS LIGHT (NightShot Light).....	36
Number of recordable pictures	38

O

OLD MOVIE.....	42
ONE PUSH.....	34
OUTDOOR.....	34
OVERLAP.....	41

P

P.MENU	See Personal Menu
PAL.....	73
PASTEL.....	42
PB FOLDER (Playback folder).....	40
PB zoom.....	24
Personal Menu.....	30, 49
PICT.APPLI. menu (Picture Application menu)...	40
PICT.EFFECT (Picture effect).....	42
PictBridge PRINT.....	57
Picture Motion Browser.....	59
Playback.....	17, 22
Playing time.....	10
PORTRAIT (Soft portrait)...	33
Print.....	57
Print mark.....	56

Q

QUALITY.....	38
--------------	----

R

REC CTRL (Recording control).....	53
REC FOLDER (Recording folder).....	40
REC MODE (Recording mode).....	46
Rec review.....	26
Recording.....	16, 18
Recording time.....	10
REMAINING.....	48
Remaining battery.....	10, 89
Remote Commander.....	88
REMOTE CTRL (Remote control).....	48
Reversal Playback.....	44

S

S VIDEO cable.....	28, 51
SCENE SELECT.....	33
Searching for the starting point	25
SELF-TIMER.....	37
SEPIA.....	42
SLIDE SHOW.....	41
SLOW SHUTTR (Slow shutter).....	42
SMTH INT.REC (Smooth interval tape recording).....	43
SNOW.....	33
SOLARIZE.....	42
SP (Standard Play).....	46
Specifications.....	82
SPORTS (Sports lesson).....	33
SPOT FOCUS.....	35
SPOT METER	See Flexible spot meter
SPOTLIGHT.....	33
STANDARD.....	38

STANDARD SET menu.....	46
STEADYSHOT.....	37, 66
STILL.....	41
Still image.....	16, 17, 19, 23
STILL SET.....	38
SUNRSE SUNSET.....	33
SUPER NSPLUS (Super NightShot plus) ...	36, 67

T

Tape counter.....	89
TELE MACRO.....	36
Time code.....	89
TIME/LANGU. menu.....	49
TRAIL.....	42
Tripod.....	87
TV.....	28
TV color systems.....	73
TV TYPE.....	29
TWILIGHT.....	33

U

USAGE GUIDE.....	24
USB CAMERA.....	47
USB SELECT.....	44
Using abroad.....	73

V

VAR.SPD PB (Various speed playback).....	44
VF B.LIGHT (Viewfinder brightness).....	47
VOLUME.....	22
V-OUT/PANEL.....	48

W

Warning indicators.....	70
Warning messages.....	70
WHITE BAL. (White balance).....	34
WHITE FADER.....	40
Wide (16:9).....	21

Index (Continued)

Windows.....	59
WIPE	41
WORLD TIME.....	49
Write-protect tab.....	73, 75

Z

Zero set memory.....	26
Zoom	20

Additional information on this product and answers to frequently asked questions can be found at our Customer Support Website.

<http://www.sony.net/>



Printed on 70% recycled paper using
VOC (Volatile Organic Compound)-free
vegetable oil based ink.

Printed in Japan



2319512120