

SONY®

2-584-907-13 (1)

Digital Video Camera Recorder

HANDYCAM

Operating Guide

**DCR-HC32E/HC33E/
HC39E/HC42E/HC43E**

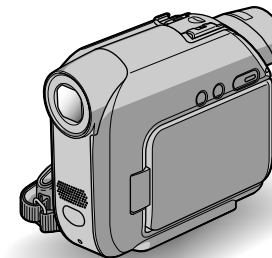

Getting Started **7**

 Recording/
Playback **18**

Using the Menu **34**

Dubbing/Editing **57**

Using a Computer **68**

Troubleshooting **80**

Additional Information **102**

<http://www.sony.net/>



Printed on 100% recycled paper using
VOC (Volatile Organic Compound)-free
vegetable oil based ink.

Printed in Japan



2 584 907 130

Mini DV Digital
Video
Cassette



InfoLITHIUM™ P
SERIES

© 2005 Sony Corporation

Read this first

Before operating the unit, please read this manual thoroughly, and retain it for future reference.



WARNING

To prevent fire or shock hazard, do not expose the unit to rain or moisture.

FOR CUSTOMERS IN THE UNITED KINGDOM

NOTICE ON THE SUPPLIED AC ADAPTOR

A moulded plug complying with BS1363 is fitted to this equipment for your safety and convenience.

Should the fuse in the plug supplied need to be replaced, a fuse of the same rating as the supplied one and approved by ASTA or BSI to BS1362 (i.e., marked with  or  mark) must be used.

If the plug supplied with this equipment has a detachable fuse cover, be sure to attach the fuse cover after you change the fuse. Never use the plug without the fuse cover. If you should lose the fuse cover, please contact your nearest Sony service station.

FOR CUSTOMERS IN EUROPE

ATTENTION

The electromagnetic fields at the specific frequencies may influence the picture and sound of this camcorder.

This product has been tested and found compliant with the limits set out in the EMC Directive for using connection cables shorter than 3 meters (9.8 feet).

Notice

If static electricity or electromagnetism causes data transfer to discontinue midway (fail), restart the application or disconnect and connect the communication cable (USB, etc.) again.



Disposal of Old Electrical & Electronic Equipment (Applicable in the European Union and other European countries with separate collection systems)

This symbol on the product or on its packaging indicates that this product shall not be treated as household waste. Instead it shall be handed over to the applicable collection point for the recycling of electrical and electronic equipment. By ensuring this product is disposed of correctly, you will help prevent potential negative consequences for the environment and human health, which could otherwise be caused by inappropriate waste handling of this product. The recycling of materials will help to conserve natural resources. For more detailed information about recycling of this product, please contact your local city office, your household waste disposal service or the shop where you purchased the product.

Applicable Accessories: “Memory Stick Duo” and Remote Commander

Notes on use

Your camcorder is supplied with two kinds of operations guides.

- “Operating Guide” (This manual)
- “First Step Guide” for using the supplied software (stored on the supplied CD-ROM)

On the types of recording media you can use in your camcorder

- A mini DV cassette marked with  (mini DV cassettes with Cassette Memory are incompatible) (p. 103).
- “Memory Stick Duo” marked with **MEMORY STICK DUO, MEMORY STICK PRO DUO** (p. 104).

On using the camcorder

- Do not hold the camcorder by the following parts.

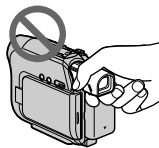

Viewfinder

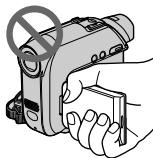

LCD panel

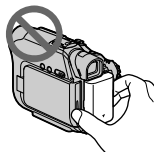

Battery pack

- Before connecting your camcorder to another device with a USB or i.LINK cable, be sure to insert the connector plug in the proper direction. If you insert the connector plug forcibly in the wrong direction, the terminal may be damaged, or this may cause a malfunction of your camcorder.

On the menu items, LCD panel, viewfinder, and lens

- A menu item that is grayed out is not available under the current recording or playback conditions.
- The LCD screen and the viewfinder are manufactured using extremely high-precision technology, so over 99.99% of the pixels are operational for effective use. However, there may be some tiny black points and/or bright points (white, red, blue, or green in color) that appear constantly on the LCD screen and the viewfinder. These points are normal results of the manufacturing process and do not affect the recording in any way.
- Exposing the LCD screen, the viewfinder, or the lens to direct sunlight for long periods of time may cause malfunctions.
- Do not aim at the sun. Doing so might

cause your camcorder to malfunction.

Take pictures of the sun only in low light conditions, such as at dusk.

On recording

- Before starting to record, test the recording function to make sure the picture and sound are recorded without any problems.
- Compensation for the contents of recordings cannot be provided, even if recording or playback is not possible due to a malfunction of the camcorder, storage media, etc.
- TV color systems differ depending on the countries/regions. To view your recordings on a TV, you need a PAL system-based TV.
- Television programs, films, video tapes, and other materials may be copyrighted. Unauthorized recording of such materials may be contrary to the copyright laws.

On this manual

- The images of the LCD screen and the viewfinder used in this manual for illustration purposes are captured using a digital still camera, and therefore may appear different.
- The on-screen displays in each local language are used for illustrating the operating procedures. Change the screen language before using your camcorder if necessary (p. 14).
- The illustrations used on this manual are based on the model DCR-HC42E.

About the Carl Zeiss lens

Your camcorder is equipped with a Carl Zeiss lens, which was developed jointly by Carl Zeiss, in Germany, and Sony Corporation, and produces superior images. It adopts the MTF* measurement system for video cameras and offers a quality typical of a Carl Zeiss lens.

* MTF stands for Modulation Transfer Function.

The number value indicates the amount of light from a subject coming into the lens.

Table of Contents

Getting Started

Step 1: Checking supplied items	7
Step 2: Charging the battery pack	8
Step 3: Turning the power on and holding your camcorder firmly	12
Step 4: Adjusting the LCD panel and viewfinder	13
Step 5: Using the touch panel	14
Changing the language setting	14
Checking the screen indicators (Display guide)	14
Step 6: Setting the date and time	15
Step 7: Inserting a tape or a "Memory Stick Duo"	16
Step 8: Selecting the aspect ratio (16:9 or 4:3) of the recording picture (DCR-HC39E/HC42E/HC43E)	17









Recording/Playback

Recording/Playback with ease (Easy Handycam)	18
Recording	20
Playback	21
Functions used for recording/playback, etc.	22
Recording	
To use zoom	
To record in dark places (NightShot plus)	
To adjust the exposure for backlit subjects	
To adjust the focus for an off center subject (SPOT FOCUS)	
To fix the exposure for the selected subject (Flexible spot meter)	
To record in mirror mode	
To use a tripod	
Playback	
To play back the images in sequence	
To use PB zoom	
Recording/playback	
To check the remaining battery (Battery Info)	
To turn off the operation confirmation beep	
To use special effects	
To initialize the settings	
Other part names and functions	
Indicators displayed during recording/playback	26

Searching for the starting point	29
Searching for the last scene of the most recent recording (END SEARCH)	29
Searching manually (EDIT SEARCH)	29
Reviewing the most recently recorded scenes (Rec review)	29
Remote Commander	30
Searching quickly for a desired scene (Zero set memory)	30
Searching for a scene by date of recording (Date search)	31
Playing the picture on a TV	32

Using the Menu

<i>Using the menu items</i>	34
Menu items	36
 CAMERA SET menu	38
Settings to adjust your camcorder to the recording conditions (EXPOSURE/ WHITE BAL./STEADYSHOT, etc.)	
 MEMORY SET menu	43
Settings for the "Memory Stick Duo" (QUALITY/IMAGE SIZE/BURST/ALL ERASE/NEW FOLDER, etc.)	
 PICT.APPLI. menu	46
Special effects on pictures or additional functions on recording/playback (PICT. EFFECT/SLIDE SHOW/INT.REC-STL, etc.)	
 EDIT/PLAY menu	50
Settings for editing or playing back in various modes (VAR.SPD PB/END SEARCH, etc.)	
 STANDARD SET menu	51
Settings while recording on a tape or other basic settings (REC MODE/ MULTI-SOUND/LCD/VF SET/DISP OUTPUT/USB, etc.)	
 TIME/LANGU. menu	54
(CLOCK SET/WORLD TIME/LANGUAGE)	
Customizing Personal Menu	55

Dubbing/Editing

Connecting to a VCR or TV	57
Dubbing to other recording devices	58
Recording pictures from a VCR or TV (DCR-HC32E/HC33E/HC42E/HC43E)	59
Dubbing pictures from a tape to a "Memory Stick Duo"	60
Dubbing sound to a recorded tape	61
Deleting recorded pictures from the "Memory Stick Duo"	63

Marking images on the “Memory Stick Duo” with specific information (Image protection/Print mark)	64
Printing recorded images (PictBridge compliant printer)	65
Jacks to connect external devices	67

Using a Computer

Before referring to the “First Step Guide” on your computer	68
Installing the software and “First Step Guide” on a computer	70
Viewing “First Step Guide”	74
Creating a DVD (Direct Access to “Click to DVD”)	75
Connecting an analog VCR to the computer via your camcorder (Signal convert function) (DCR-HC32E/HC33E/HC42E/HC43E)	78

Troubleshooting

Troubleshooting	80
Warning indicators and messages	97

Additional Information

Using your camcorder abroad	102
Usable cassette tapes	103
About the “Memory Stick”	104
About the “InfoLITHIUM” battery pack	106
About i.LINK	107
Maintenance and precautions	108
Using the Strap Belt as a wrist strap	112
Attaching the Shoulder Strap	112
Specifications	113
Index	116

Step 1: Checking supplied items

Make sure that you have following items supplied with your camcorder. The number in the parentheses indicates the number of that item supplied.

"Memory Stick Duo" 16MB (1) (p. 16, 104)
(DCR-HC33E/HC43E)

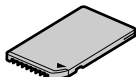

Memory Stick Duo adaptor (1) (p. 105)
(DCR-HC33E/HC43E)

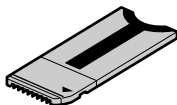

AC Adaptor (1) (p. 8)

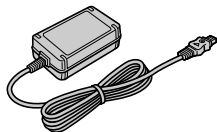

Mains lead (1) (p. 8)



Handycam Station (1) (p. 8)



Wireless Remote Commander (1)
(p. 30)



A button-type lithium battery is already installed.

A/V connecting cable (1) (p. 32, 57)



USB cable (1) (p. 68)



Shoulder Strap (1) (p. 112)

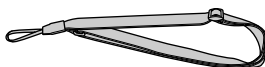

Rechargeable battery pack (1) (p. 8, 106)

NP-FP30 (DCR-HC32E/HC33E)

NP-FP50 (DCR-HC39E/HC42E/HC43E)

CD-ROM "Picture Package Ver.1.5" (1)
(p. 68)

21-pin adaptor (1)

For the models with the  mark printed on their bottom surfaces only.

Shoe cover (1)

Attached to the camcorder.

Operating Guide (This manual) (1)

Step 2: Charging the battery pack

You can charge the “InfoLITHIUM” battery pack (P series) (p. 106) after attaching it to your camcorder.

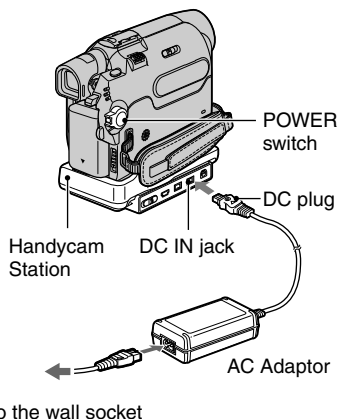

To the wall socket

- 1 Attach the battery pack by sliding it in the direction of the arrow until it clicks.**

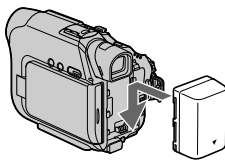

- 2 Slide the POWER switch up to OFF (CHG). (The default setting.)**

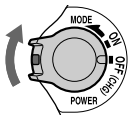

- 3 Connect the AC Adaptor to the DC IN jack on the Handycam Station.**

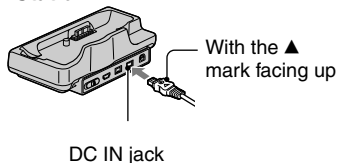

- 4 Connect the mains lead to the AC Adaptor and the wall socket.**

- 5 Insert the camcorder into the Handycam Station securely, all the way to the bottom.**

CHG (charge) lamp

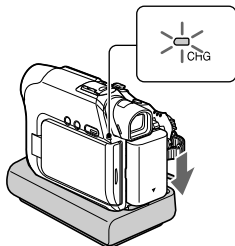

The CHG (charge) lamp lights up and charging starts.

- When inserting the camcorder into the Handycam Station, close the DC IN jack cover.

6 The CHG (charge) lamp turns off when the battery is fully charged. Disconnect the AC Adaptor from the DC IN jack.

Disconnect the AC Adaptor from the DC IN jack holding both the Handycam Station and the DC plug.

To charge the battery pack using only the AC Adaptor

Turn off the power, then connect the AC Adaptor to the DC IN jack on your camcorder.

- You can operate your camcorder connected to a power source such as a wall socket as shown in the illustration. The battery pack will not lose its charge in this case.

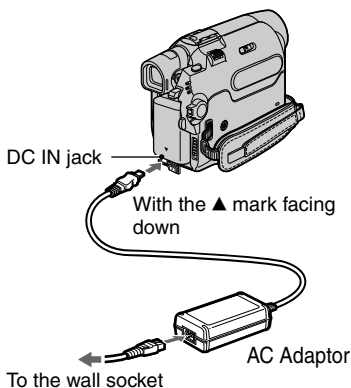

To remove your camcorder from the Handycam Station

Turn off the power, then remove the camcorder from the Handycam Station holding both your camcorder and the Handycam Station.

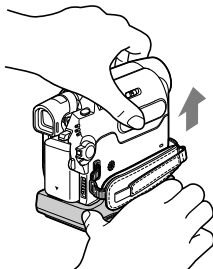

To remove the battery pack

Turn off the power, then slide the battery pack in the direction of the arrow while pressing the PUSH button.

PUSH button POWER switch

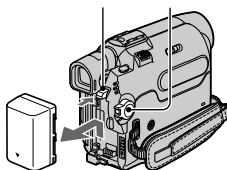

When storing the battery pack

Fully discharge the battery before storing it for an extended period (p. 107).

Step 2: Charging the battery pack (continued)

Charging time

Approximate time (min.) required when you fully charge a fully discharged battery pack.

Battery pack	Charging time
NP-FP30 (supplied with DCR-HC32E/HC33E)	115
NP-FP50 (supplied with DCR-HC39E/HC42E/HC43E)	125
NP-FP70	155
NP-FP90	220

Recording time

Approximate time (min.) available when you use a fully charged battery pack.

For DCR-HC32E/HC33E:

Battery pack	Continuous recording time	Typical recording time*
NP-FP30 (supplied)	80 95	40 45
NP-FP50	110 135	55 65
NP-FP70	235 280	115 140
NP-FP90	415 500	205 250

- All times measured under the following conditions:
Top: Recording with LCD screen.
Bottom: Recording with viewfinder while the LCD panel closed.

For DCR-HC39E/HC42E/HC43E:

Battery pack	Continuous recording time	Typical recording time*
NP-FP50 (supplied)	95 110 110	50 60 60

Battery pack	Continuous recording time	Typical recording time*
NP-FP70	200 235 235	110 130 130
NP-FP90	355 415 415	195 230 230

- All times measured under the following conditions:
Top: When the LCD backlight turns on.
Middle: When the LCD backlight turns off.
Bottom: Recording time when recording with the viewfinder while the LCD panel is closed.
* Typical recording time shows the time when you repeat recording start/stop, turning the power on/off and zooming.

Playing time

Approximate time (min.) available when you use a fully charged battery pack.

For DCR-HC32E/HC33E:

Battery pack	LCD panel opened	LCD panel closed
NP-FP30 (supplied)	85	105
NP-FP50	120	150
NP-FP70	255	310
NP-FP90	455	550

For DCR-HC39E/HC42E/HC43E:

Battery pack	LCD panel opened*	LCD panel closed
NP-FP50 (supplied)	105	135
NP-FP70	225	280
NP-FP90	400	500

- * When the LCD backlight turns on.

On the battery pack

- Before changing the battery pack, slide the POWER switch up to OFF (CHG).
- The CHG (charge) lamp flashes during charging, or the battery information (p. 24) will not be correctly displayed under the following conditions.
 - The battery pack is not attached correctly.
 - The battery pack is damaged.
 - The battery pack is fully discharged. (For Battery Info only.)
- The power will not be supplied from the battery as long as the AC Adaptor is connected to the DC IN jack of your camcorder or the Handycam Station, even when the mains lead is disconnected from the wall socket.

On the charging/recording/playback time

- Times measured with the camcorder at 25 °C (77 °F). (10 to 30 °C (50 °F to 86 °F) is recommended.)
- The recording and playback time will be shorter when you use your camcorder in low temperatures.
- The recording and playback time will be shorter depending on the conditions under which you use your camcorder.

On the AC Adaptor

- Use the nearby wall socket when using the AC Adaptor. Disconnect the AC Adaptor from the wall socket immediately if any malfunction occurs while using your camcorder.
- Do not use the AC Adaptor placed in a narrow space, such as between a wall and furniture.
- Do not short-circuit the DC plug of the AC Adaptor or battery terminal with any metallic objects. This may cause a malfunction.

PRECAUTION

- Even if your camcorder is turned off, AC power (mains) is still supplied to it while connected to the wall socket via the AC Adaptor.

Step 3: Turning the power on and holding your camcorder firmly

To record or play back, slide the POWER switch repeatedly to turn on the respective lamp.

When using it for the first time, the [CLOCK SET] screen appears (p. 15).

LENS COVER switch

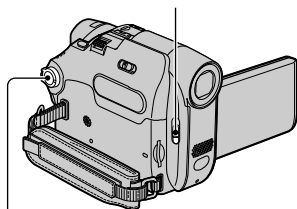

POWER switch

1 Slide the LENS COVER switch to OPEN.



2 Slide the POWER switch repeatedly in the direction of the arrow to turn on the respective lamp.



If the POWER switch is set to OFF, slide it down while pressing the green button.

Lamps that light up

CAMERA-TAPE: To record on a tape.

CAMERA-MEMORY: To record on a "Memory Stick Duo."

PLAY/EDIT: To play or edit pictures.

- When you slide the POWER switch to turn on the CAMERA-TAPE or CAMERA-MEMORY lamp, the current date and time will be displayed on the LCD screen for about 5 seconds.

3 Put your wrist through the Strap Belt.

The length of the Strap Belt is adjustable.

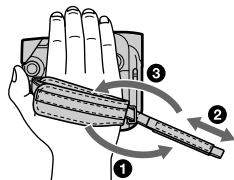

4 Hold the camcorder as illustrated.

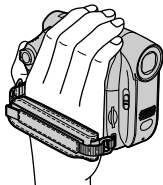

To turn off the power

- ① Slide the POWER switch up to OFF (CHG) while pressing the green button.
- ② Set the LENS COVER switch to CLOSE.

- At the time of purchase, the power will be set to turn off automatically if you leave your camcorder without any operation attempted for approximately 5 minutes, to save battery power. ([A.SHUT OFF], p. 54).

Step 4: Adjusting the LCD panel and viewfinder

The LCD panel

Open the LCD panel 90 degrees to the camcorder (①), then rotate it to the best angle to record or play (②).

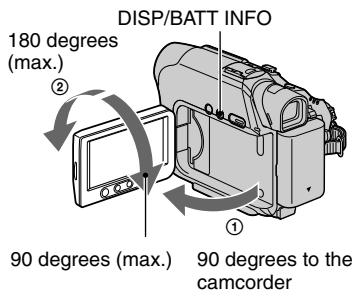

- Do not press the buttons on the LCD frame accidentally when you open or adjust the LCD panel.
- If you rotate the LCD panel 180 degrees to the lens side, you can close the LCD panel with the LCD screen facing out. This is convenient during playback operations.
- If you rotate the LCD panel 180 degrees to the lens side, you can see the image in the viewfinder.

For DCR-HC39E/HC42E/HC43E:

To darken the LCD screen

Press and hold DISP/BATT INFO for a few seconds until  appears.

This setting is practical when you use your camcorder in bright conditions or where you want to save battery power. The recorded picture will not be affected by the setting. To turn on the LCD backlight, press and hold DISP/BATT INFO for a few seconds until  disappears.

- See [LCD BRIGHT] (p. 51) to adjust the brightness of the LCD screen.

The viewfinder

You can view images using the viewfinder when you close the LCD panel to avoid wearing down the battery, etc.

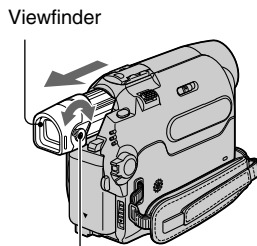

Move it until the picture is clear.

- You can adjust the brightness of the viewfinder backlight by selecting [LCD/VF SET] - [VF B.LIGHT] (p. 52).

Step 5: Using the touch panel

You can play back recorded pictures (p. 21), or change the settings (p. 34) using the touch panel.

Place your hand on the rear side of the LCD panel to support it. Then, touch the buttons displayed on the screen.

DISP/BATT INFO

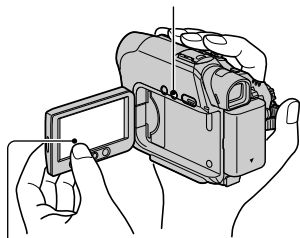

Touch the button on the LCD screen.

- Perform the same actions as explained above when you press the buttons on the LCD frame.
- Be careful not to press buttons on the LCD frame accidentally while using the touch panel.

To hide the screen indicators

Press DISP/BATT INFO to toggle the screen indicators (such as time code, etc.) on or off.

Changing the language setting

You can change the on-screen displays to show messages in a specified language. Select the screen language in [LANGUAGE] on the  (TIME/LANGU.) menu (p. 34, 54).

Checking the screen indicators (Display guide)

You can easily check the meaning of each indicator that appears on the LCD screen.

1 Touch [P-MENU].

Touch [MENU] during Easy Handycam operation.

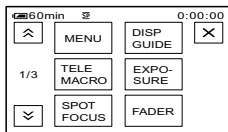

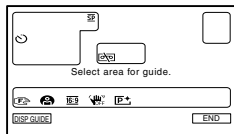

2 Touch [DISP GUIDE].

The indicators vary depending on the settings.



3 Touch the area including the indicator that you want to check.

The meanings of the indicators in the area are listed on the screen. If you cannot find the indicator you want to check, touch / to toggle. When you touch , the screen returns to the area selecting display.

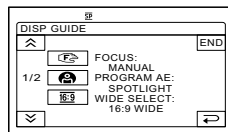

4 Touch [END].

Step 6: Setting the date and time

Set the date and time when using this camcorder for the first time. If you do not set the date and time, the [CLOCK SET] screen appears every time you turn on your camcorder or change the POWER switch position.

- If you do not use your camcorder for **about 3 months**, the built-in rechargeable battery gets discharged and the date and time settings may be cleared from the memory. In that case, charge the rechargeable battery and then set the date and time again (p. 111).

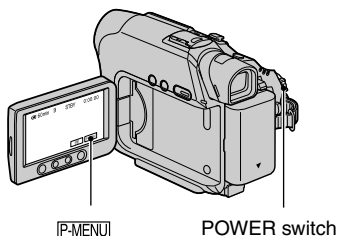

Skip to step 4 when you set the clock for the first time.

- 1 Touch **P-MENU** → **[MENU]**.

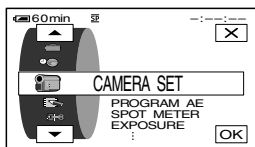

- 2 Select **(TIME/LANGU.)** menu with **▲/▼**, then touch **[OK]**.

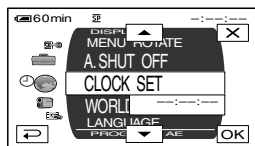

- 3 Select **[CLOCK SET]** with **▲/▼**, then touch **[OK]**.

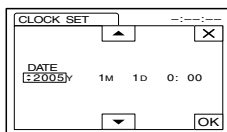

- 4 Set **[Y]** (year) with **▲/▼**, then touch **[OK]**.

You can set any year up to the year 2079.

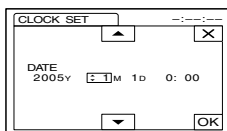

- 5 Set **[M]** (month), **[D]** (day), hour and minute, then touch **[OK]**.

The clock starts.

Step 7: Inserting a tape or a “Memory Stick Duo”

Cassette tape

You can use mini DV ^{Mini DV} cassettes only (p. 103).

- The recordable time varies depending on [REC MODE] (p. 51).

- 1 Slide and hold the **OPEN/EJECT** lever in the direction of the arrow and open the lid.

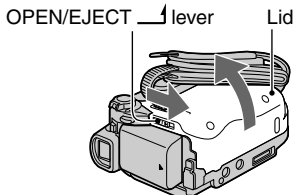

The cassette compartment automatically comes out and opens up.

- 2 Insert a cassette with its window facing up, then press **PUSH**.

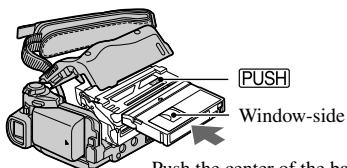

Push the center of the back of the cassette lightly.

The cassette compartment automatically slides back in. Do not force the cassette into the compartment. This may cause a malfunction.

- 3 Close the lid.

To eject the cassette

Proceed with the same steps as you would

when inserting a cassette tape.

“Memory Stick Duo”

You can use only a “Memory Stick Duo” marked with **MEMORY STICK DUO** or **MEMORY STICK PRO DUO** (p. 104).

- The number and time of recordable pictures varies depending on the image quality or the image size. For details, see page 43.

Insert the “Memory Stick Duo” into the “Memory Stick Duo” slot in the right direction until it clicks.

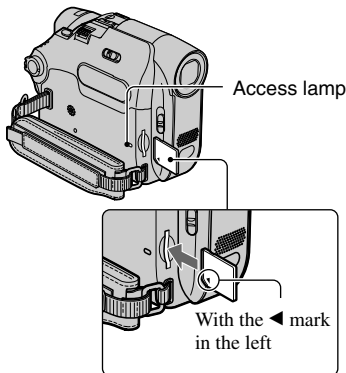

- If you force the “Memory Stick Duo” into the slot in the wrong direction, the “Memory Stick Duo,” the “Memory Stick Duo” slot, or image data may be damaged.

To eject a “Memory Stick Duo”

Lightly push the “Memory Stick Duo” in once.

- When the access lamp is lit or flashing, your camcorder is reading/writing data. Do not shake or knock your camcorder, turn the power off, eject the “Memory Stick Duo,” or remove the battery pack. Otherwise, image data may be damaged.

Step 8: Selecting the aspect ratio (16:9 or 4:3) of the recording picture (DCR-HC39E/HC42E/HC43E)

By recording in the 16:9 (wide) mode, you can enjoy wide-angle, high-resolution pictures.

- If you intend to view pictures on a wide TV, recording in the 16:9 (wide) mode is recommended.

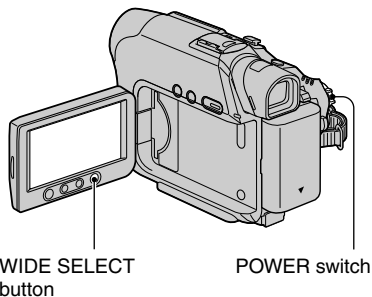

Recording a moving picture or still image on the "Memory Stick Duo"

- ① Set the POWER switch to [CAMERA-MEMORY].
The aspect ratio of the picture switches to 4:3.
 - ② Press WIDE SELECT repeatedly to select the desired screen aspect ratio.
- Still images will be fixed to image size 1152 × 648 (L₁₅₂) in the 16:9 (wide) mode. In the 4:3 mode, you can select up to 1152 × 864 (L₁₅₂).
 - If you record movies (MPEG MOVIE EX) in the 16:9 (wide) mode, black bands appear at the top and bottom of the picture when they are played back.
 - For the number of recordable pictures, see page 43.

Selecting the aspect ratio for recording movies on a tape

Be sure to set the POWER switch to CAMERA-TAPE.

Press WIDE SELECT repeatedly to select the desired screen aspect ratio.

16:9*



4:3*



* When viewing on the LCD screen. It may be different in the viewfinder.

- Differences in the angle of view between 4:3 and 16:9 vary depending on the zoom position.
- If you play back a picture on a TV, set [TV TYPE] for playback in the aspect ratio of the TV (p. 32).
- When viewing pictures recorded in 16:9 aspect ratio with [TV TYPE] set to [4:3], pictures may appear rough depending on the subject (p. 32).



Recording/Playback with ease (Easy Handycam)

With this Easy Handycam operation, most of the camera settings are automatically adjusted optimally, which frees you from detailed adjustment.

Since only basic functions become available and screen font size increases for easy viewing, even first time users can enjoy easy operation.

Go through the procedures described in steps 1 to 8 (p. 7 to 17) before operation.

Open the lens cover.

DCR-HC32E/
HC33E:

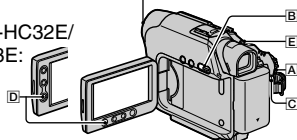

Recording with ease

- Slide the POWER switch **A** in the direction of the arrow repeatedly to turn on the respective lamp to select a recording medium.

Recording movies : Light up the CAMERA-TAPE lamp.

Recording still images : Light up the CAMERA-MEMORY lamp.

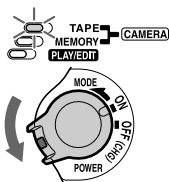

If the POWER switch **A** is set to OFF, slide it down while pressing the green button.

- Press EASY **B**.

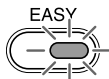

The EASY lights up in blue.

Easy Handycam
operation
ON

- Start recording.

Movies

Press REC START/STOP **C** (or **D**).

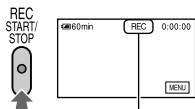

[STBY] → [REC]

To stop recording, press **C** (or **D**) again.

Still images (4:3)

Press PHOTO **E**.

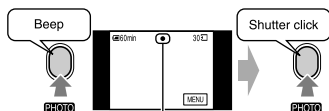

Flashing → Lights up

Press and hold lightly to adjust the focus.

Press fully to record.

Playing back with ease

1 Slide the POWER switch **[A]** in the direction of the arrow repeatedly to turn on the PLAY/EDIT lamp.

2 Press EASY **[B]**.

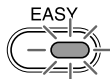



The EASY lights up in blue.

Easy Handycam
operation
ON

3 Start playing back.

Movies

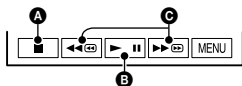

Touch , then touch  to start playback.

Slow playback  is available on the Remote Commander.



- A** Stop
- B** Play/Pause toggles as you touch it
- C** Rewind/Fast forward

Still images

Touch **[MEMORY]** →  /  to select a picture.

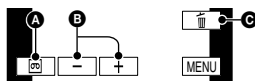

- A** Tape playback
- B** Previous/Next
- C** Delete (p. 63)

To cancel Easy Handycam operation

Press EASY **[B]** again.

The EASY lamp turns off and all the settings are returned to the previous situation.

- The recording mode for tape, and the image size (DCR-HC39E/HC42E/HC43E) and quality for “Memory Stick Duo” return to the default settings.
- What you can do during Easy Handycam operation
 - Adjust some menu settings (p. 36)
If you touch [MENU], adjustable items will be displayed. Items not displayed return to the default settings.
 - Zoom (during recording) (p. 22)

- NightShot plus (p. 22)
- Turn the screen indicators on/off (p. 14)
- “Playing the picture on a TV” (p. 32)
- “Dubbing to other recording devices” (p. 58)
- [Invalid during Easy Handycam operation] appears if operations not available during Easy Handycam are attempted.

Recording

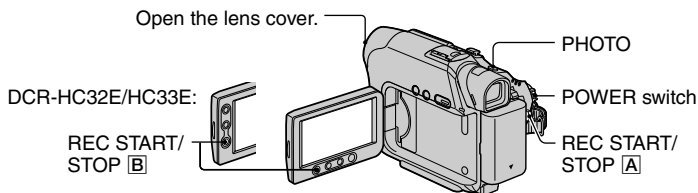

1 Slide the **POWER** switch in the direction of the arrow repeatedly to turn on the respective lamp to select a recording medium.

- On a tape:** Light up the CAMERA-TAPE lamp.
- On a “Memory Stick Duo”:** Light up the CAMERA-MEMORY lamp.

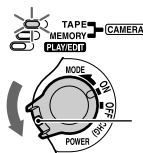

If the **POWER** switch is set to **OFF**, slide it down while pressing the green button.

2 Start recording.

Movies

Press **REC START/STOP [A]** (or **[B]**).

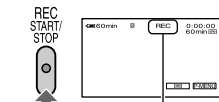

[STBY] (tape only) → [REC]

- The sound of a movie (MPEG MOVIE EX) recorded on a “Memory Stick Duo” will be monaural.

Still images

Press and hold **PHOTO** lightly to adjust the focus (**A**), then press it fully (**B**).

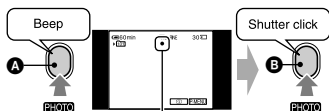

Flashing → Lights up
A shutter sound is heard. When disappears, the image has been recorded.

To stop movie recording

Press **REC START/STOP** again.

- You can record a still image on a “Memory Stick Duo” while recording movies on a tape or in standby mode.

For DCR-HC39E/HC42E/HC43E:

Still images will be fixed to image size [640 × 360] for 16:9 pictures and [640 × 480] for 4:3 pictures during recording in CAMERA-TAPE.

To check the latest recording on a “Memory Stick Duo”

Touch . To delete the picture, touch → [YES]. Touch to return to the standby mode.

Playback

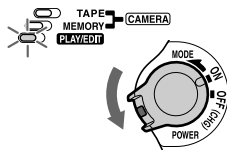

- 1 Slide the **POWER** switch in the direction of the arrow repeatedly to turn on the **PLAY/EDIT** lamp.



- 2 Start playing back.

Movies



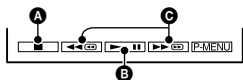

On a Tape:

Touch , then touch  to start playback.



- A Stop
 - B Play/Pause toggles as you touch it
 - C Rewind/Fast forward
- Playback automatically stops if pause is engaged for more than 3 minutes.

On a “Memory Stick Duo” :

Touch  →  to select a picture with , then touch .

Still images



Touch .

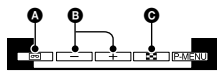

The most recently recorded image is displayed.







- A Tape playback
 - B Previous/Next
 - C Index screen display
- You can delete unnecessary pictures in a “Memory Stick Duo” (p. 63).

To adjust the volume

Touch  → [VOLUME], then  to adjust the volume.

- If you cannot find [VOLUME] in , touch .





To search for a scene during playback

Touch and hold / during playback (Picture Search), or / while fast forwarding or rewinding the tape (Skip Scan).

- You can play back in various modes ([VAR, SPD PB], p. 50).

To display pictures on a “Memory Stick Duo” on the Index screen

Touch . Touch the picture you want to display in the single display mode.

To view pictures in other folders, touch  →  → [PB FOLDER], select a folder with , then touch  (p. 45).

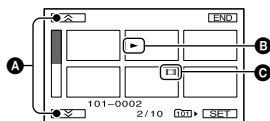

- A Previous/Next 6 pictures
- B The picture displayed before switching to the index screen.
- C Movie icon

Functions used for recording/playback, etc.

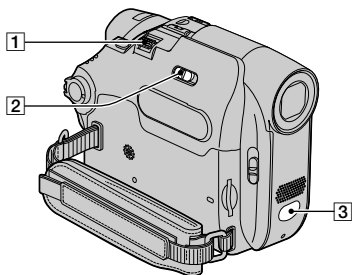

For DCR-HC39E/HC42E/HC43E:

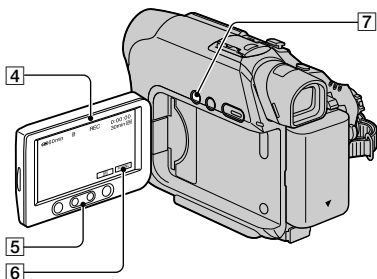

For DCR-HC32E/HC33E:

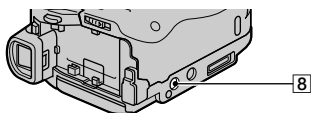
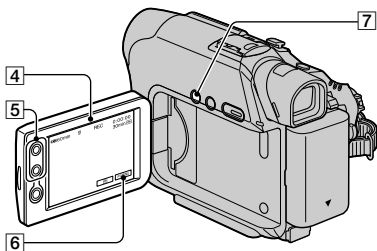

Recording

To use zoom [1] [5]

Move the power zoom lever [1] slightly for a slower zoom. Move it further for a faster zoom.

Wider range of view: (Wide angle)

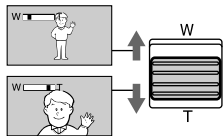

Close view:
(Telephoto)

- You cannot change the zoom speed with the zoom buttons [5] on the LCD frame.
- The minimum distance required between your camcorder and the subject to get a sharp focus is about 1 cm (about 1/2 in.) for wide angle and about 80 cm (about 2 5/8 feet) for telephoto.
- You can set [DIGITAL ZOOM] if you want to zoom to a level greater than the following (p 42):
 - 20 times (DCR-HC32E/HC33E)
 - 12 times (DCR-HC39E/HC42E/HC43E)

To record in dark places (NightShot plus) [2]

Set the NIGHTSHOT PLUS switch [2] to ON. ([ON] and ["NIGHTSHOT PLUS"] appear.)

- To record an image brighter, use Super NightShot plus function (p. 41).
To record an image more faithful to the original colors, use Color Slow Shutter function (p. 41).
- The NightShot plus and Super NightShot plus function use infrared light. Therefore, do not cover the infrared port [3] with your fingers or other objects.
- Adjust the focus manually ([FOCUS], p. 40) when it is hard to focus automatically.
- Do not use these functions in bright places. This may cause a malfunction.

To adjust the exposure for backlit subjects 7

To adjust the exposure for backlit subjects, press BACK LIGHT [7] to display . To cancel the back light function, press BACK LIGHT again.

To adjust the focus for an off center subject (SPOT FOCUS) 6

See [SPOT FOCUS] on page 40.

To fix the exposure for the selected subject (Flexible spot meter) 6

See [SPOT METER] on page 38.

To record in mirror mode 4

Open the LCD panel [4] 90 degrees to the camcorder (1), then rotate it 180 degrees to the lens side (2).

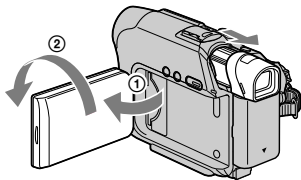

- A mirror-image of the subject appears on the LCD screen, but the picture will be normal when recorded.

To use a tripod 8

Attach the tripod (optional: the length of the screw must be less than 5.5 mm (7/32 inches)) to the tripod receptacle [8] using a tripod screw.

Playback

To play back the images in sequence 6

See [SLIDE SHOW] on page 47.

To use PB zoom 1 5

You can magnify pictures from about 1.1 to 5 times the original size.

- 1 Play back the picture you want to magnify.
- 2 Magnify the picture with T (Telephoto).
- 3 Touch the screen at the point you want to magnify within the displayed frame.
- 4 Adjust the magnification with W (Wide angle)/T (Telephoto).

To cancel, touch [END].

- You cannot change the zoom speed with the zoom buttons [5] on the LCD frame.

Functions used for recording/playback, etc. (continued)

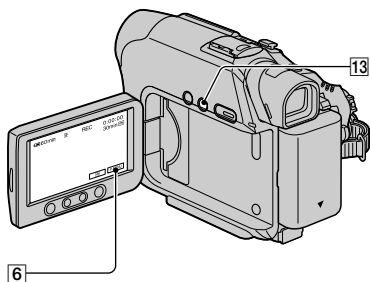
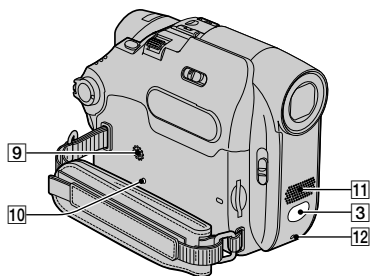

Recording/playback

To check the remaining battery (Battery Info) 13

Set the POWER switch up to OFF (CHG), then press DISP/BATT INFO 13. The battery information appears for about 7 seconds. Keep the button pressed to view it for about 20 seconds.

Remaining battery (approx.)

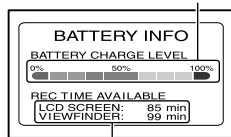

Recording capacity (approx.)

To turn off the operation confirmation beep 6

See [BEEP] (p. 54) to set the operation beep.

To use special effects 6

See [P] (PICT.APPL.) menu (p. 46).

To initialize the settings 10

Press RESET 10 to initialize all the settings, including the setting of the date and time.

(Menu items customized on Personal Menu are not initialized.)

Other part names and functions

- 9 Speaker
Sounds come out from the speaker.
 - For how to adjust the volume, see page 21.
- 12 REC lamp
The REC lamp lights up in red during recording (p. 53).
- 3 Remote sensor
Point the Remote Commander (p. 30) towards the remote sensor to operate your camcorder.
- 11 Internal stereo microphone
For DCR-HC39E/HC42E/HC43E:
When an external microphone is connected, the audio input from the external microphone takes precedence over others.

Indicators displayed during recording/playback

Recording movies

On a tape

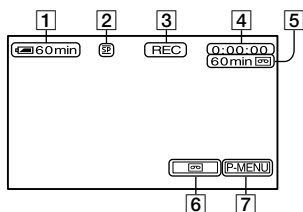

- 1 Remaining battery (approx.)
- 2 Recording mode (SP or LP) (51)
- 3 Recording status ([STBY] (standby) or [REC] (recording))
- 4 Time code (hour: minute: second: frame)/Tape counter (hour: minute: second)
- 5 Recording capacity of the tape (approx.) (53)
- 6 END SEARCH/EDIT SEARCH/Rec review display switch button (29)
- 7 Personal Menu button (34)

On a "Memory Stick Duo"

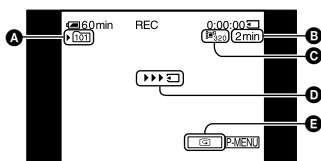

- A Recording folder (45)
- B Recording capacity (approx.)
- C Movie size (44)
- D Recording start indicator (appears for about 5 seconds)
- E Review button (20)

Recording still images

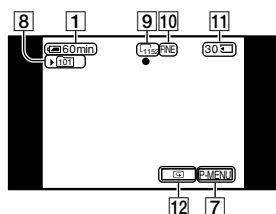

- 8 Recording folder (45)
- 9 Image size (20, 43)
- 10 Quality ([FINE] or [STD]) (43)
- 11 "Memory Stick Duo" indicator and the number of images that can be recorded (approx.)
- 12 Review button (20)

Data code during playback

The date/time data and the camera setting data will be recorded automatically. They do not appear on the screen during recording, but you can check them as [DATA CODE] during playback (p. 53).

() is a reference page.

The indicators during recording will not be recorded.

Viewing movies

On a tape

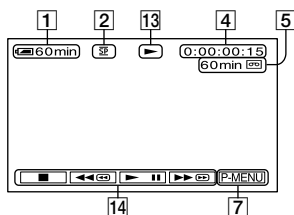

13 Tape transport indicator

14 Video operation buttons (21)

When there is a “Memory Stick Duo” inserted in the camcorder, (STOP) changes to (“Memory Stick Duo” playback) if a tape is not used for playback.

On a “Memory Stick Duo”

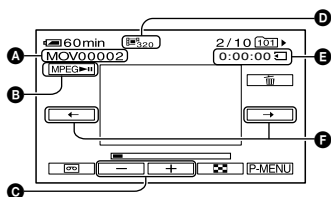

A Data file name

B Play/Pause button (21)

C Previous/Next image button (21)

D Image size (44)

E Playing time

F Previous/Next scene button

A movie file will be divided into a maximum of 60 scenes. The number of scenes divided depends on the length of the movie. After selecting a scene from which to start the playback, touch to play back.

Viewing still images

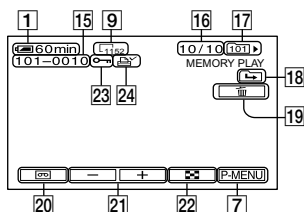

15 Data file name

16 Picture number/Total number of recorded pictures in the current playback folder

17 Playback folder (45)

18 Previous/Next folder icon

The following indicators appear when the first or last picture of the current folder is displayed and when there are multiple folders on the same “Memory Stick Duo.”

: Touch to move to the previous folder.

: Touch to move to the next folder.

: Touch / to move to either the previous or the next folder.

19 Image delete button (63)

20 Tape playback select button (21)

21 Previous/Next image button (21)

22 Index screen display button (21)

23 Image protection mark (64)

24 Print mark (64)

Indicators when you made changes

You can use [DISP GUIDE] (p. 14) to check the function of each indicator that appears on the LCD screen.

Upper left Upper right

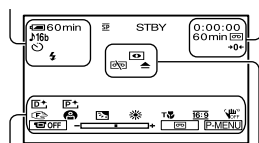

Bottom Center

Upper left

Indicator	Meaning
	EXT SUR MIC (51)
	AUDIO MODE (51)
	Continuous photo recording (43)
	Self-timer recording (41)
	Interval photo recording (49)
	This indicator appears when you use video flash light (optional). (40)

Upper right

Indicator	Meaning
	A/V→DV OUT (52)
	DV input (59)
	Zero set memory (30)
	Slide show (47)
	LCD backlight off (13)

Center

Indicator	Meaning
	NightShot plus (22)
	Super NightShot plus (41)
	Color Slow Shutter (41)
	PictBridge connecting (65)
	Warning (97)

Bottom

Indicator	Meaning
	Picture effect (48)
	Digital effect (47)
	Manual focus (40)
	PROGRAM AE (38)
	Backlight (23)
	White balance (39)
	WIDE select (17)
	SteadyShot off (42)
	Tele macro (40)
	Flexible spot meter (38)/ EXPOSURE (39)

Searching for the starting point

Make sure that the CAMERA-TAPE lamp lights up.

Searching for the last scene of the most recent recording (END SEARCH)

[END SEARCH] will not work once you eject the cassette after you have recorded on the tape.

Touch  → .

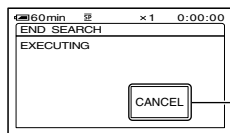

Touch here to cancel the operation.

The last scene of the most recent recording is played back for about 5 seconds, and the camcorder enters the standby mode at the point where the last recording has finished.

- [END SEARCH] will not work correctly when there is a blank section between recorded sections on the tape.
- You can also select [END SEARCH] from the menu. When the PLAY/EDIT lamp lights up, select the [END SEARCH] shortcut in Personal Menu (p. 34).

Searching manually (EDIT SEARCH)

You can search for the start point to start the next recording while viewing the pictures on the screen. The sound is not played back during the search.

1 Touch .

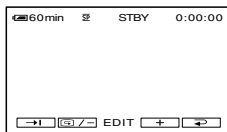

2 Touch and hold / - (to go backward) / + (to go forward) and release it at the point where you want the recording to start.

Reviewing the most recently recorded scenes (Rec review)

You can view about 2 seconds of the scene recorded just before you stopped the tape.

Touch  →  / -.

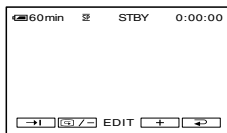

The last 2 seconds (approx.) of the most recently recorded scene are played back. Then, your camcorder is set to the standby.

Remote Commander

Remove the insulation sheet before using the Remote Commander.

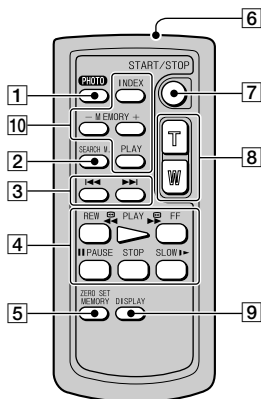
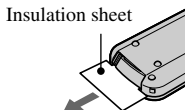

1 PHOTO (p. 20)

The on-screen image when you press this button will be recorded as a still image.

2 SEARCH M.* (p. 29)

3 ◀▶*

4 Video control buttons (Rewind, Playback, Fast-forward, Pause, Stop, Slow) (p. 21)

5 ZERO SET MEMORY*

6 Transmitter

7 REC START/STOP (p. 20)

8 Power zoom (p. 23)

9 DISPLAY (p. 14)

10 Memory control buttons (Index*, +/-, Memory playback) (p. 21)

* These buttons are not available during Easy Handycam operation.

• Aim the Remote Commander towards the remote sensor to operate your camcorder (p. 24).

• To change the battery, see page 111.

Searching quickly for a desired scene (Zero set memory)

1 During playback, press ZERO SET MEMORY [5] at a point you want to locate later on.

The tape counter is reset to “0:00:00” and +0+ appears on the screen.

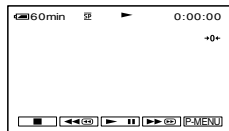

If the tape counter is not displayed, press DISPLAY [9].

2 Press STOP [4] when you want to stop playback.

3 Press ◀REW [4].

The tape stops automatically when the tape counter reaches “0:00:00.”

4 Press PLAY [4].

Playback starts from the point designated “0:00:00” on the tape counter.

• There may be a discrepancy of several seconds between the time code and the tape counter.

• Zero set memory will not function correctly if there is a blank section between recorded sections on the tape.

To cancel the operation

Press ZERO SET MEMORY [5] again.

Searching for a scene by date of recording (Date search)

You can locate the point where the recording date changes.

1 Slide the **POWER** switch down to turn on the **PLAY/EDIT** lamp.

2 Press **SEARCH M.** [2].

3 Press **◀◀(previous)/▶▶(next)** [3] to select a recording date.

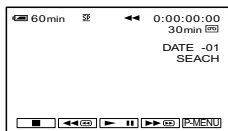

To cancel the operation

Press **STOP** [4].

- The Date search will not function correctly when there is a blank section between recorded sections on the tape.

Playing the picture on a TV

Connect your camcorder to the wall socket using the supplied AC Adaptor for this operation (p. 8). Refer also to the instruction manuals supplied with the devices to be connected.

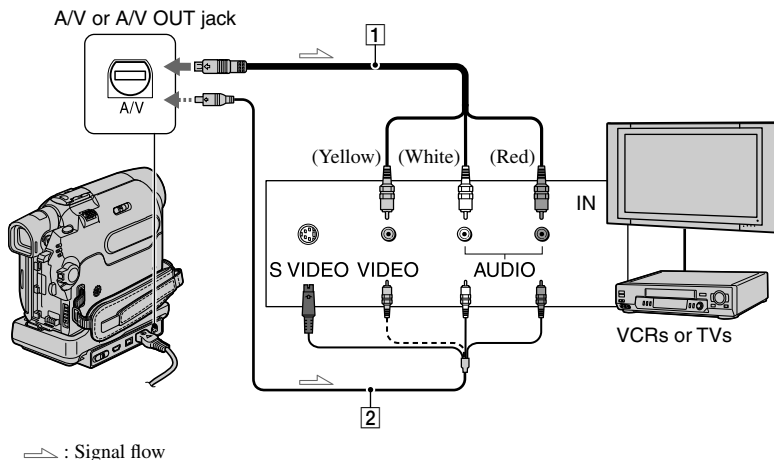

1 A/V connecting cable (supplied)

Connect to the input jack of the other device.

2 A/V connecting cable with S VIDEO (optional)

When connecting to another device via the S VIDEO jack, by using the A/V connecting cable with an S VIDEO cable (optional), pictures can be reproduced more faithfully than with the supplied A/V cable connection.

Connect the white and red plugs (left/right audio) and S VIDEO plug (S VIDEO channel) of an A/V connecting cable (optional). In this case, the yellow (standard video) plug connection is not necessary. S VIDEO connection only will not output audio.

When your TV is connected to a VCR

Connect your camcorder to the LINE IN input on the VCR. Set the input selector on the VCR to LINE.

For DCR-HC39E/HC42E/HC43E:

To set the aspect ratio according to the connected TV (16:9/4:3)

Change the setting according to the screen size of the TV you will view pictures on.

- 1 Slide the POWER switch down to turn on the PLAY/EDIT lamp.
- 2 Touch → **P-MENU** → [MENU] →  (STANDARD SET) → [TV TYPE] → [16:9] or [4:3] → **OK**.

- When you set [TV TYPE] to [4:3], or when the picture's aspect ratio switches between 16:9 and 4:3, the image may jitter.
- On some 4:3 TVs, the still image recorded in 4:3 aspect ratio may not appear in full screen. This is not a malfunction.



- When you play back a picture recorded in 16:9 aspect ratio on a 4:3 TV not compatible with the 16:9 signal, set [TV TYPE] to [4:3].

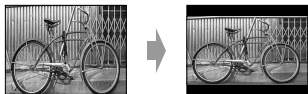

When your TV is monaural (When your TV has only one audio input jack)

Connect the yellow plug of the A/V connecting cable to the video input jack and connect the white (left channel) or the red (right channel) plug to the audio input jack of your TV or VCR.

- Do not connect A/V connecting cables to both your camcorder and the Handycam Station at the same time. The image and the sound might be distorted.
- You can display the time code on the TV screen by setting [DISP OUTPUT] to [V-OUT/PANEL] (p. 54).

If your TV/VCR has a 21-pin adaptor (EUROCONNECTOR)

Use the 21-pin adaptor supplied with your camcorder (For models with the **CE** mark printed on their bottom surfaces only). This adaptor is designed for output use only.

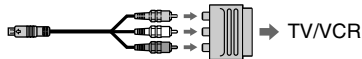

Using the menu items

Follow the instructions below to use each of the menu items listed after this page.

1 Slide the POWER switch down to turn on the respective lamp.

[CAMERA-TAPE] lamp:  settings on a tape

[CAMERA-MEMORY] lamp:  settings on a “Memory Stick Duo”

[PLAY/EDIT] lamp: settings for viewing/editing

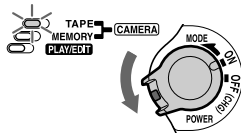

2 Touch the LCD screen to select the menu item.

Unavailable items will be grayed out.

■ To use the short-cuts of Personal Menu



On Personal Menu, short-cuts for frequently used menu items are added.

- You can customize Personal Menu as you like (p. 55).

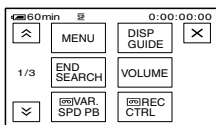
- ① Touch .



- ② Touch the desired item.

If the desired item is not displayed on the screen, touch / until the item is displayed.

- ③ Select the desired setting, then touch .

■ To use menu items

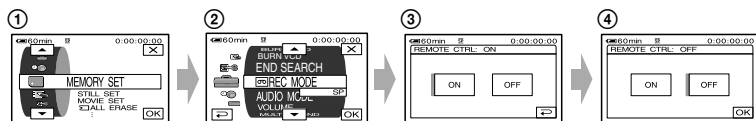

You can customize menu items that are not added to Personal Menu.



- ① Touch  → [MENU].

The menu index screen appears.



- ② Select the desired menu.

Touch / to select the item, then touch . (The process in step ③ is the same as that in step ②.)

- ③ Select the desired item.

- You can also touch the item directly to select it.

- ④ Customize the item.

After finishing the settings, touch  →  (close) to hide the menu screen.
If you decide not to change the setting, touch  to return to the previous screen.

Menu items

*1 DCR-HC32E/HC33E

*2 DCR-HC39E/HC42E/HC43E

*3 DCR-HC32E/HC33E/HC42E/HC43E

*4 DCR-HC39E

Position of lamp:

TAPE



MEMORY

PLAY/EDIT

CAMERA SET menu (p. 38)

PROGRAM AE	●	●	×
SPOT METER	●	●	×
EXPOSURE	●	●	×
WHITE BAL.	●	●	×
AUTO SHUTTER	●	×	×
SPOT FOCUS	●	●	×
FOCUS	●	●	×
TELE MACRO	●	●	×
FLASH SET	●	●	×
SUPER NSPLUS	●	×	×
NS LIGHT	●	●	×
COLOR SLOW S	●	×	×
SELF-TIMER	●	●*	×
DIGITAL ZOOM	●	×	×
WIDE SELECT*1	●	×	×
STEADYSHOT	●	×	×

MEMORY SET menu (p. 43)

STILL SET	×	●	●
MOVIE SET	×	●	●
 ALL ERASE*	×	×	●
 FORMAT	×	●	●
FILE NO.	×	●	●
NEW FOLDER	×	●	●
REC FOLDER	×	●	●
PB FOLDER	×	×	●

PICT.APPLI. menu (p. 46)

FADER	●	×	×
SLIDE SHOW	×	×	●
D. EFFECT	●	×	●
PICT. EFFECT	●	×	●
SMTH INT. REC*2	●	×	×
INT.REC-STL	×	●	×
DEMO MODE	●	×	×
PRINT	×	×	●

Available menu items (●) vary depending on the position of the lamp.



*These functions are available during Easy Handycam operation.

Position of lamp: TAPE MEMORY PLAY/EDIT

EDIT/PLAY menu (p. 50)

	TAPE	MEMORY	PLAY/EDIT
 VAR. SPD PB	×	×	●
 REC CTRL	×	×	●
AUD DUB CTRL	×	×	●
 REC MOVIE	×	×	●
BURN DVD	×	×	●
BURN VCD	×	×	●
END SEARCH	●	×	●

STANDARD SET menu (p. 51)

 REC MODE* ³	●	×	●
 REC MODE* ⁴	●	×	×
AUDIO MODE	●	×	●
VOLUME*	×	×	●
MULTI-SOUND	×	×	●
AUDIO MIX	×	×	●
EXT SUR MIC* ²	●	×	×
LCD/VF SET	●	●	●
A/V → DV OUT* ³	×	×	●
VIDEO INPUT* ³	×	×	●
TV TYPE* ²	●	●	●
USB-CAMERA	●	×	×
USB-PLY/EDT	×	×	●
DISP GUIDE*	●	●	●
DATA CODE*	×	×	●
 REMAINING	●	×	●
REMOTE CTRL	●	●	●
REC LAMP	●	●	×
BEEP*	●	●	●
DISP OUTPUT	●	●	●
MENU ROTATE	●	●	●
A.SHUT OFF	●	●	●
CALIBRATION	×	×	●

TIME/LANGU. menu (p. 54)

CLOCK SET*	●	●	●
WORLD TIME	●	●	●
LANGUAGE	●	●	●

CAMERA SET menu

Settings to adjust your camcorder to the recording conditions (EXPOSURE/WHITE BAL./STEADYSHOT, etc.)

The default settings are marked with ►. The indicators in parentheses appear when the items are selected.

See page 34 for details on selecting menu items.

PROGRAM AE

You can record pictures effectively in various situations with the PROGRAM AE function.

► AUTO

Select to automatically record pictures effectively without the [PROGRAM AE] function.

SPOTLIGHT* (☹)



Select to prevent people's faces from appearing excessively white when subjects are lit by strong light.

PORTRAIT (Soft portrait) (☺)



Select to bring out the subject such as people or flowers while creating a soft background.

SPORTS* (Sports lesson) (⚡)



Select to minimize shake when shooting fast moving subjects.

BEACH&SKI* (🏖)



Select to prevent people's faces from appearing dark in strong light or reflected light, such as at a beach in midsummer or

on a ski slope.

SUNSET&MOON** (☾)



Select to maintain the atmosphere of situations such as sunsets, general night views or fireworks.

LANDSCAPE** (🏞)



Select to shoot distant subjects clearly. This setting also prevents your camcorder from focusing on glass or metal mesh in windows that comes in between the camcorder and the subject.

- Items with one asterisk (*) can be adjusted to focus on subjects only a short distance away. Items with two asterisks (**) can be adjusted to focus on subjects farther away.

SPOT METER (Flexible spot meter)

You can adjust and fix the exposure to the subject, so that it is recorded in suitable brightness even when there is strong contrast between the subject and the background, such as subjects in the spotlight on stage.

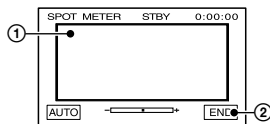

- ① Touch the point where you want to fix and adjust the exposure on the screen.
—————>
- ② Touch [END].

To return the setting to automatic exposure, touch [AUTO] → [END].

- If you set [SPOT METER], [EXPOSURE] is automatically set to [MANUAL].

EXPOSURE

You can fix the brightness of a picture manually. When recording indoors on a clear day, for instance, you can avoid backlight shadows on people next to the window by fixing the exposure to that of the wall side of the room.

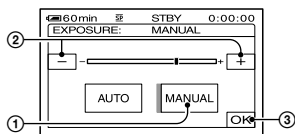

- 1 Touch [MANUAL].
- 2 Adjust the exposure by touching / .
- 3 Touch [OK].
 appears.

To return the setting to automatic exposure, touch [AUTO] → [OK].

- You can adjust [EXPOSURE] and [FADER] while using the viewfinder by having the LCD panel rotated 180 degrees and closed with the screen facing out (p. 46).

WHITE BAL. (White balance)

You can adjust the color balance to the brightness of the recording environment.

► AUTO

The white balance is adjusted automatically.

OUTDOOR (☀)

The white balance is set to be appropriate for shooting outdoors or under daylight fluorescent light.

INDOOR (💡)

The white balance is set to the brightness of warm white fluorescent lamps.

ONE PUSH (📄)

The white balance will be adjusted according to the ambient light.

- 1 Touch [ONE PUSH].

- 2 Frame a white object such as a piece of paper, to fill the screen under the same lighting conditions as you will shoot the subject.

- 3 Touch [].

flashes quickly. When the white balance has been adjusted and stored in the memory, the indicator stops flashing.

- Do not shake your camcorder while is flashing quickly.
- flashes slowly if white balance could not be set.
- If keeps flashing even after you have touched [OK], set [WHITE BAL.] to [AUTO].

- When you have changed the battery pack while [AUTO] is selected, or you bring your camcorder outdoors from inside the house while using fixed exposure, select [AUTO] and aim your camcorder at a nearby white object for about 10 seconds for better color balance adjustment.
- Redo the [ONE PUSH] procedure if you change the [PROGRAM AE] settings, or bring your camcorder outdoors from inside the house, or vice versa.
- Set [WHITE BAL.] to [AUTO] or [ONE PUSH] under white or cool white fluorescent lamps.
- The setting returns to [AUTO] when you have the power source disconnected from your camcorder for more than 5 minutes.

AUTO SHUTTER

Automatically activates the electronic shutter to adjust the shutter speed when recording in bright conditions if you set it to [ON] (the default setting).

SPOT FOCUS

You can select and adjust the focal point to aim it at a subject not located in the center of the screen.

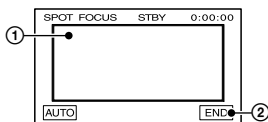

① Touch the subject on the screen.

appears.

② Touch [END].

To adjust the focus automatically, touch [AUTO] → [END].

- If you set [SPOT FOCUS], [FOCUS] is automatically set to [MANUAL].

FOCUS

You can adjust the focus manually. Select this when you want to focus on a certain subject intentionally.

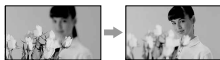

① Touch [MANUAL].

appears.

② Touch (focusing on close subjects)/ (focusing on distant subjects) to sharpen the focus. appears when the focus cannot be adjusted any closer, and appears when the focus cannot be adjusted farther away.

③ Touch [OK].

To adjust the focus automatically, touch [AUTO] → [OK] in step ①.

- It is easier to focus on the subject by moving the power zoom lever towards T (telephoto) to adjust the focus, then towards W (wide angle) to adjust the zoom for recording. When you want to record a close-up image of a subject, move the power zoom lever towards W (wide angle) to fully magnify the image, then adjust the focus.

- The minimum distance required between your camcorder and the subject to get a sharp focus is about 1 cm (about 1/2 in.) for wide angle and about 80 cm (about 2 5/8 feet) for telephoto.

TELE MACRO

This is useful to shoot small subjects, such as flowers or insects. As you can take close-ups from a distance, your shadow does not disturb the picture and the subject stands out clearer.

When you set [TELE MACRO] to [ON]

the zoom (p. 22) moves to the top of the T (Telephoto) side automatically and allows for recording subjects at a close distance as follows:

For DCR-HC32E/HC33E: down to about 39 cm (15 3/8 in.).

For DCR-HC39E/HC42E/HC43E: down to about 35 cm (13 7/8 in.).

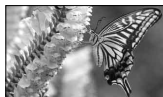

To cancel, touch [OFF], or zoom to wide-angle (W side).

- When recording a distant subject, it may difficult to focus on and take time for focusing.
- Adjust the focus manually ([FOCUS], p. 40) when it is hard to focus automatically.

FLASH SET

Note that these settings will not function with unsupported flashes.

FLASH MODE

▶ ON

Flashes every time.

ON (DCR-HC39E/HC42E/HC43E)

Flashes to reduce the red-eye phenomenon.

AUTO

Flashes automatically.

AUTO  (DCR-HC39E/HC42E/HC43E)

Flashes automatically to reduce the red-eye phenomenon.

- If the flash is not capable of preventing the red-eye phenomenon, you can select only [ON] or [AUTO].

FLASH LEVEL**HIGH(++)**

Makes the flash level higher.

► NORMAL(±)**LOW(+-)**

Makes the flash level lower.

- The setting returns to [NORMAL] when you disconnect the power source from your camcorder for more than 5 minutes.

SUPER NSPLUS (Super NightShot plus)

The picture will be recorded at a maximum of 16 times the sensitivity of NightShot plus recording if you set [SUPER NSPLUS] to [ON] while the NIGHTSHOT PLUS switch (p. 22) is also set to ON. S and ["SUPER NIGHTSHOT PLUS"] appear on the screen.

To return to the normal setting, set the NIGHTSHOT PLUS switch to OFF.

- Do not use NightShot plus/[SUPER NSPLUS] in bright places. This may cause a malfunction.
- Do not cover the infrared port with your fingers or other objects.
- Adjust the focus manually ([FOCUS], p. 40) when it is hard to focus automatically.
- The shutter speed of your camcorder changes depending on the brightness. The motion of the picture may slow down at this time.

NS LIGHT (NightShot Light)

When using either the NightShot plus (p. 22) or [SUPER NSPLUS] (p. 41) function to record, you can record clearer pictures by setting [NS LIGHT], which emits infrared light (invisible), to [ON] (the default setting).

- Do not cover the infrared port with your fingers or other objects.
- The maximum shooting distance using [NS LIGHT] is about 3 m (10 feet). If you record subjects in dark places, such as night scenes or in moonlight, set [NS LIGHT] to [OFF]. You can make the image color deeper this way.

COLOR SLOW S (Color Slow Shutter)

When you set [COLOR SLOW S] to [ON], you can record an image more faithful to the original colors.

 and [COLOR SLOW SHUTTER] appear on the screen.

To cancel [COLOR SLOW S], touch [OFF].

- The shutter speed of your camcorder changes depending on the brightness. The motion of the picture may slow down at this time.
- Adjust the focus manually ([FOCUS], p. 40) when it is hard to focus automatically.

SELF-TIMER

The self-timer starts recording after about 10 seconds.

- ① Touch **P-MENU** → [SELF-TIMER] → [ON] → **OK**.
 appears.
- ② Press REC START/STOP to record movies, or PHOTO to record still images.
To cancel the count down, touch [RESET].

To cancel the self-timer, select [OFF] in step ①.

- You can also use the self-timer with the Remote Commander (p. 30).

DIGITAL ZOOM

You can select the maximum zoom level in case you want to zoom to a level greater than 20 × (DCR-HC32E/HC33E) or 12 × (DCR-HC39E/HC42E/HC43E) while recording on a tape. Note that the image quality decreases when you are using the digital zoom.

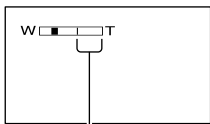

The right side of the bar shows the digital zooming factor. The zooming zone appears when you select the zooming level.

For DCR-HC32E/HC33E:

▶ OFF

Up to 20 × zoom is performed optically.

40 ×

Up to 20 × zoom is performed optically, and after that, up to 40 × zoom is performed digitally.

800 ×

Up to 20 × zoom is performed optically, and after that, up to 800 × zoom is performed digitally.

For DCR-HC39E/HC42E/HC43E:

▶ OFF

Up to 12 × zoom is performed optically.

24 ×

Up to 12 × zoom is performed optically, and after that, up to 24 × zoom is performed digitally.

480 ×

Up to 12 × zoom is performed optically, and after that, up to 480 × zoom is performed digitally.

WIDE SELECT (DCR-HC32E/HC33E)

You can record a picture in a ratio suitable for the screen on which it will be displayed.

▶ 4:3

Standard setting (to record pictures to be played back on a 4:3 TV).

16:9 WIDE (16:9)

Records pictures to be played back on a 16:9 wide TV in full screen mode.

When viewed on the LCD screen/viewfinder with [16:9 WIDE (16:9)] selected.

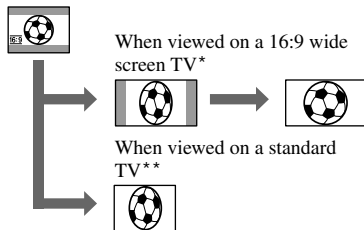

*Picture appears in full screen mode when the wide-screen TV switches to full mode.

**Played in 4:3 mode. When you play a picture in the wide mode, it appears as you have seen on the LCD screen or in the viewfinder.

STEADYSHOT

You can compensate for camera shake (the default setting is [ON]). Set [STEADYSHOT] to [OFF] (OFF) when using a tripod (optional) or the conversion lens (optional).

MEMORY SET menu

Settings for the “Memory Stick Duo” (QUALITY/IMAGE SIZE/BURST/ALL ERASE/ NEW FOLDER, etc.)

The default settings are marked with ▶.
The indicators in parentheses appear when
the items are selected.

See page 34 for details on selecting
menu items.

STILL SET

For DCR-HC39E/HC42E/HC43E: BURST

You can record several still images one
after another by pressing PHOTO.

▶ OFF

Select this when not recording
continuously.

NORMAL ()

Records from 4 (1152 × 864 image size)
to 13 (640 × 480 image size) images
continuously at about 0.5 second intervals.
The maximum number of images are
recorded when you press and hold PHOTO
fully.

EXP. BRKTG (BRK)

Records 3 images consecutively with
different exposures at about 0.5 second
intervals. You can compare the 3 images
and select an image recorded at the best
exposure.

- The flash (optional) will not function during [BURST].
- The maximum number of images will be recorded in the self-timer mode or when you are operating with the Remote Commander.
- [EXP. BRKTG] will not function when you have space for fewer than 3 images remaining on the “Memory Stick Duo.”

QUALITY

▶ FINE (FINE)

Records still images at the fine image
quality level.

STANDARD (STD)

Records still images at the standard image
quality level.

For DCR-HC39E/HC42E/HC43E: IMAGE SIZE

▶ 1152 × 864 ()

Records still images clearly.

640 × 480 ()

Allows for the maximum number of
images to be recorded.

- If you set 16:9 (wide) ratio of the screen, [IMAGE SIZE] is set to [1152 × 648] automatically (p. 17).



Capacity of the “Memory Stick Duo” (MB) and the number of recordable pictures

In 4:3 aspect ratio

	1152 × 864 () [*]	640 × 480 () ₆₄₀
8MB	15 37	50 120
16MB		
(supplied with DCR-HC33E/ HC43E)	30 74	96 240
32MB	61 150	190 485
64MB	120 300	390 980
128MB	245 600	780 1970
256MB	445 1000	1400 3550
512MB	900 2050	2850 7200
1GB	1800 4200	5900 14500

^{*} The image size of 1152 × 864 is available for DCR-HC39E/HC42E/HC43E only.

In 16:9 aspect ratio (DCR-HC39E/HC42E/HC43E)

	1152 × 648 	640 × 360 
8MB	20 48	60 120
16MB (supplied with DCR-HC43E)	40 96	115 240
32MB	81 190	240 485
64MB	160 390	490 980
128MB	320 780	980 1970
256MB	590 1400	1750 3550
512MB	1200 2850	3600 7200
1GB	2450 5900	7300 14500

- All numbers measured at the following setting.
Top: [FINE] is selected for image quality.
Bottom: [STANDARD] is selected for image quality.
- When using the “Memory Stick Duo” made by Sony Corporation. The number of recordable pictures varies depending on the recording environment.
- The image size of a 4:3 picture is as follows.
 - [FINE] is selected for an image size of [1152 × 864] - approx. 500kB.
 - [FINE] is selected for an image size of [640 × 480] - approx. 150kB.
 - [STANDARD] is selected for an image size of [1152 × 864] - approx. 200kB.
 - [STANDARD] is selected for an image size of [640 × 480] - approx. 60kB.
- The image size of a 16:9 picture is as follows.
 - [FINE] is selected for an image size of [1152 × 648] - approx. 380kB.
 - [FINE] is selected for an image size of [640 × 360] - approx. 120kB.
 - [STANDARD] is selected for an image size of [1152 × 648] - approx. 160kB.

– [STANDARD] is selected for an image size of [640 × 360] - approx. 60kB.

MOVIE SET

IMAGE SIZE



▶ 320 × 240 ()

Records movies in high resolution.

160 × 112 ()

Allows for more movie recording time.

Capacity of the “Memory Stick Duo” (MB) and the recordable time (hour: minute: second)

	320 × 240 	160 × 112 
8MB	00:01:20	00:05:20
16MB (supplied with DCR- HC33E/HC43E)	00:02:40	00:10:40
32MB	00:05:20	00:21:20
64MB	00:10:40	00:42:40
128MB	00:21:20	01:25:20
256MB	00:42:40	02:50:40
512MB	01:25:20	05:41:20
1GB	02:50:40	11:22:40

- When using the “Memory Stick Duo” made by Sony Corporation. The recordable time varies depending on the recording environment.

ALL ERASE

Deletes all the pictures on a “Memory Stick Duo” without image protection, or in the selected folder.

- ① Select [ALL FILES] or [CURRENT FOLDER].
[ALL FILES]: Deletes all the images on the “Memory Stick Duo.”
[CURRENT FOLDER]: Deletes all the images in the selected folder.
 - ② Touch [YES] twice → [X].
- Cancel image protection on the “Memory Stick Duo” beforehand when using the “Memory Stick Duo” with the write-protect tab (p. 104).
 - The folder will not be deleted even when you delete all the pictures in the folder.
 - Do not do any of the following while Erasing all data... is displayed:
 - Operate the POWER switch/operation buttons.
 - Eject the “Memory Stick Duo.”

FORMAT

A new “Memory Stick Duo” is formatted at the factory and does not require formatting.

- Touch [YES] twice → [X].
Formatting is completed, and all the images will be deleted.
- Do not do any of the following while Formatting... is displayed:
 - Operate the POWER switch/operation buttons.
 - Eject the “Memory Stick Duo.”
 - Formatting erases everything on the “Memory Stick Duo” including protected image data and newly created folders.

FILE NO.**► SERIES**

Assigns file numbers in sequence even if the “Memory Stick Duo” is replaced with another one. The file number is reset when a new folder is created or the recording folder is replaced with another.

RESET

Resets the file number to 0001 each time the “Memory Stick Duo” is changed.

NEW FOLDER

You can create a new folder (102MSDCF to 999MSDCF) on a “Memory Stick Duo.” When a folder is full (a maximum of 9999 images are stored) a new folder is automatically created.

Touch [YES] → [X].

- You cannot delete the created folders using your camcorder. You will have to format the “Memory Stick Duo” (p. 45), or delete them using your computer.
- The number of recordable pictures on a “Memory Stick Duo” may decrease as the number of folders increases.

REC FOLDER (Recording folder)

Select the folder to be used for recording with [▲]/[▼], then touch [OK].

- As the default setting, pictures are saved in the 101MSDCF folder.
- Once you record a picture in a folder, the same folder will be set as the default folder for playback.

PB FOLDER (Playback folder)

Select the playback folder with [▲]/[▼], then touch [OK].

PICT.APPLI. menu

Special effects on pictures or additional functions on recording/playback (PICT. EFFECT/SLIDE SHOW/INT.REC-STL, etc.)

The default settings are marked with ►. The indicators in parentheses appear when the items are selected.

See page 34 for details on selecting menu items.

FADER

You can add the following effects to currently recording pictures.

- ① Select the desired effect, then touch **[OK]**.
When you select [OVERLAP], [WIPE] or [DOT FADER], the image on a tape is stored as a still image. (While storing the image, the screen turns to blue.)
- ② Press REC START/STOP.
The fader indicator stops flashing and disappears when the fade is complete.

To cancel the operation, touch [OFF] in step ①.



WHITE FADER



BLACK FADER



MOSAIC FADER



MONOTONE

When fading in, the picture gradually changes from black-and-white to color.
When fading out, it gradually changes from color to black-and-white.

OVERLAP (fade in only)



WIPE (fade in only)



DOT FADER (fade in only)



Using the viewfinder

You can adjust [EXPOSURE] and [FADER] while using the viewfinder by having the LCD panel rotated 180 degrees and closed with the screen facing out.

- ① Make sure that the CAMERA-TAPE or the CAMERA-MEMORY lamp lights up.
- ② Close the LCD panel with the screen facing out.
[OFF] appears.
- ③ Touch **[OFF]**.
[Set LCD off?] appears on the screen.
- ④ Touch [YES].
The LCD screen is turned off.
- ⑤ Touch the LCD screen while checking the display in the viewfinder.
[EXPOSURE], etc. are displayed.
- ⑥ Touch the button you want to set.
[EXPOSURE]: Adjust with **[-]/[+]**, and touch **[OK]**.
[FADER]: Touch it repeatedly to select a desired effect (only while the CAMERA-TAPE lamp lights up).
[ON]: The LCD screen lights up.

To hide the buttons, touch **[OK]**.

SLIDE SHOW

Plays back the images stored on a "Memory Stick Duo," or in a folder in sequence (slide show).

- ① Touch [SET] → [PB FOLDER].
- ② Select [ALL FILES (all)] or [CURRENT FOLDER (T)], then touch [OK].
If you select [CURRENT FOLDER (T)], all the images in the current playback folder selected in [PB FOLDER] (p. 45) are played back in sequence.
- ③ Touch [REPEAT].
- ④ Select [ON] or [OFF], then [OK].
To repeat the slide show, select [ON (C)].
To execute the slide show only once, select [OFF].
- ⑤ Touch [END] → [START].

To cancel [SLIDE SHOW], touch [END].
To pause, touch [PAUSE].

- You can select the first picture for the slide show with [-]/[+] before touching [START].
- If movies are played in the slide show, you can adjust the volume with [Q-]/[Q+].

D. EFFECT (Digital effect)

You can add digital effects to your recordings.

- ① Touch the desired effect.
- ② Adjust the effect with [-]/[+], then touch [OK].
When you select [STILL] or [LUMI. KEY], the image when you touch [OK] is saved as a still image.

Effect	Items to adjust
STILL	The degree of transparency of the still image you want to superimpose on a movie.

Effect	Items to adjust
FLASH	The interval of frame-by-frame playback.
LUMI. KEY	The color scheme of the area in the still image which is to be swapped with a movie.
TRAIL	The fade time of the incidental image.
SLOW SHUTTR*	Shutter speed (1 is 1/25, 2 is 1/12, 3 is 1/6, 4 is 1/3).
OLD MOVIE*	No adjustment necessary.

* Available during recording only.

- ③ Touch [OK].
[D+] appears.

To cancel [D. EFFECT], touch [OFF] in step ①.

STILL

Records a movie while superimposing it on a previously recorded still image.



FLASH (flash motion)

Records a movie with a serial-still-image effect (strobe effect).

LUMI. KEY (luminance key)

Replaces a brighter area in a previously recorded still image (e.g. background of a person) with a movie.



TRAIL

Records a picture so that an incidental image like a trail is left.

SLOW SHUTTR (slow shutter)

The shutter speed is slowed down. Suitable for shooting a subject more clearly in a dark place.

- Adjust the focus manually using a tripod since adjusting the focus automatically is hard when [SLOW SHUTTR] is selected. ([FOCUS], p. 40)

OLD MOVIE

Adds an old movie effect with a sepia hue to pictures.

- For DCR-HC39E/HC42E/HC43E:
You cannot select 16:9/4:3 as the aspect ratio for [OLD MOVIE].
- You cannot record pictures edited using special effects on the tape in your camcorder.
- You cannot add effects to externally input pictures. Also, you cannot output playback pictures edited with digital effects via the  DV Interface.
- You can save pictures edited using special effects on a "Memory Stick Duo" (p. 60) or record them on another tape (p. 58).

PICT. EFFECT (Picture effect)

You can add special effects to a picture during recording or playback.  appears.

▶ OFF

Does not use [PICT. EFFECT] setting.

NEG.ART



The color and brightness are reversed.

SEPIA

Pictures appear in sepia.

B&W

Pictures appear in black and white.

SOLARIZE



Pictures appear as an illustration with strong contrast.

PASTEL



Pictures appear as a pale pastel drawing.*

MOSAIC



Pictures appear mosaic-patterned.*

* Not available during playback.

- You cannot add effects to externally input pictures. Also, you cannot output playback pictures edited with picture effects via the  DV Interface.
- You can save pictures edited using special effects on a "Memory Stick Duo" (p. 60) or record them on another tape (p. 58).

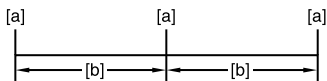

SMTH INT. REC (Smooth interval tape recording) (DCR-HC39E/HC42E/HC43E)

Your camcorder will shoot 1 frame of the picture at a selected interval and keep them in memory until it has stored several frames. This function is useful to observe the movement of clouds or the changes of daylight. These pictures appear smooth when played back. Connect your camcorder to the wall socket using the supplied AC Adaptor for this operation.



[a]: Recording

[b]: Interval

- ① Touch [SET] →  /  to select a desired interval time (1 to 120 seconds) → .
- ② Touch [REC START].
Recording starts and ● changes to red.

To interrupt, touch [REC STOP] in step ②.
To resume, touch [REC START].

To cancel, touch [REC STOP], then [END].

- When your camcorder has shot several frames, it records them on the tape, after performing the END SEARCH function depending on the interval length.
- Do not turn off the power or disconnect the power source while a message is displayed on the screen.
- The camcorder will shoot several frames for the first and last shots of the Smooth interval recording.
- Smooth interval recording is released when approximately 12 hours have elapsed after shooting has begun.
- Sounds are not recorded.
- The last few frames may not be recorded if the battery or tape has run out.
- There may be discrepancies in the interval.
- If you adjust the focus manually, you can record clear pictures even if the light changes ([FOCUS], p. 40).
- You can silence the beeps during recording.

INT.REC-STL (Interval photo recording)

You can record still images on the "Memory Stick Duo" at a selected interval. This function is useful to observe the movement of clouds or the changes in daylight, etc.

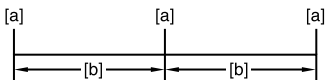

[a]: Recording

[b]: Interval

- ① Touch [SET] → a desired interval time (1, 5 or 10 minutes) → [OK] → [ON] → [OK] → [X].
- ② Press PHOTO fully.

☺ stops flashing and the interval still image recording starts.

To cancel [INT.REC-STL], select [OFF] in step ①.

DEMO MODE

The default setting is [ON], allowing you to view the demonstration in about 10 minutes, after you have removed both a cassette and a "Memory Stick Duo" from your camcorder, and slide the POWER switch down to turn on the CAMERA-TAPE lamp.

- The demonstration will be suspended in situations such as those described below.
 - When you touch the screen during the demonstration. (The demonstration starts again in about 10 minutes.)
 - When a cassette or a "Memory Stick Duo" is inserted.
 - When the POWER switch is set to other than CAMERA-TAPE.
 - When NIGHTSHOT PLUS switch is set to ON.

PRINT

See page 65.

EDIT/PLAY menu

Settings for editing or playing back in various modes (VAR.SPD PB/END SEARCH, etc.)









The default settings are marked with ►.
The indicators in parentheses appear when the items are selected.

See page 34 for details on selecting menu items.

VAR.SPD PB (Various speed playback)



You can play back in various modes while viewing movies.

- ① Touch the following buttons during playback.

To	Touch
change the playback direction*	 (frame)
play back slowly**	 To reverse direction :  (frame) → 
play back 2 times faster (double speed)	 (double speed) To reverse direction:  (frame) →  (double speed)
play back frame by frame	 (frame) during playback pause. To reverse direction:  (frame) during frame playback.

* Horizontal lines may appear at the top, bottom, or in the center of the screen. This is not a malfunction.

** Pictures output from the  DV Interface cannot be played back smoothly in slow mode.

- ② Touch  → .

To return to the normal playback mode, touch  (Play/Pause) twice (once from frame playback).

- You will not hear the recorded sound. You may see mosaic-like images of the previously played picture.

REC CTRL (Movie recording control)

See page 59.

AUD DUB CTRL (Audio dubbing)

See page 62.

REC MOVIE (Recording control)

See page 60.

BURN DVD

When your camcorder is connected to a Sony VAIO series personal computer, you can easily burn the picture recorded on the tape on a DVD (Direct Access to “Click to DVD”) using this command. See “Creating a DVD (Direct Access to “Click to DVD”)” (p. 75) for details.

BURN VCD

When your camcorder is connected to a personal computer, you can easily burn the picture recorded on the tape on a CD-R (Direct Access to Video CD Burn) using this command. See “First Step Guide” in the supplied CD-ROM for details.

END SEARCH

EXEC

The most recently recorded picture is played back for about 5 seconds and then stops automatically.

CANCEL

Stops [END SEARCH].



STANDARD SET menu

Settings while recording on a tape or other basic settings (REC MODE/MULTI-SOUND/LCD/VF SET/DISP OUTPUT/USB, etc.)

The default settings are marked with ►. The indicators in parentheses appear when the items are selected.

See page 34 for details on selecting menu items.

REC MODE (Recording mode)

► SP (SP)

Records in the SP (Standard Play) mode on a cassette.

LP (LP)

Increases the recording time to 1.5 times the SP mode (Long Play).

- If you record in the LP mode, a mosaic-like noise may appear or sound may be interrupted when you play back the tape on other camcorders or VCRs.
- When you mix recordings in the SP mode and in the LP mode on one tape, the playback picture may be distorted or the time code may not be written properly between the scenes.

AUDIO MODE

► 12BIT

Records in the 12-bit mode (2 stereo sounds).

16BIT (16b)

Records in the 16-bit mode (1 stereo sound with high quality).

VOLUME

See page 21.

MULTI-SOUND

You can select whether to play back audio recorded using other devices with dual sound or stereo sound.

► STEREO

Plays back with main and sub sound (or stereo sound).

1

Plays back with main sound or the left channel sound.

2

Plays back with sub sound or the right channel sound.

- You can play back, but cannot record a dual sound track cassette on your camcorder.
- The setting returns to [STEREO] when you have the power source disconnected from your camcorder for more than 5 minutes.

AUDIO MIX

See page 63.

EXT SUR MIC (External surround microphone) (DCR-HC39E/HC42E/HC43E)

► WIDE STEREO (◀▶)

Records 2 channel sound with more presence by connecting a microphone (optional).

STEREO

Records the stereo sound normally.

- You need a compatible accessory such as the ECM-HQP1 microphone (optional) to record the sound in the [WIDE STEREO] setting.
- Sound is recorded in the [STEREO] setting if the microphone is not connected, even if another setting is selected.

LCD/VF SET

The recorded picture will not be affected by this operation.

■ LCD BRIGHT

You can adjust the brightness of the LCD screen.

- ① Adjust the brightness with / .

STANDARD SET menu (continued)

② Touch .

■ LCD BL LEVEL

You can adjust the brightness of the LCD screen's backlight.

▶ NORMAL



Standard brightness.

BRIGHT

Brightens the LCD screen.

- When you connect your camcorder to outside power sources, [BRIGHT] is automatically selected for the setting.
- When you select [BRIGHT], battery life is reduced by about 10 percent during recording.

■ LCD COLOR

You can adjust the color on the LCD screen with  / .



■ VF B.LIGHT

You can adjust the brightness of the viewfinder.

▶ NORMAL

Standard brightness.

BRIGHT

Brightens the viewfinder screen.

- When you connect your camcorder to outside power sources, [BRIGHT] is automatically selected for the setting.
- When you select [BRIGHT], battery life is reduced by about 10 percent during recording.

■ For DCR-HC32E/HC33E: WIDE DISP

You can select how a picture appears on the viewfinder and LCD screen when [WIDE SELECT] is set to [16:9 WIDE].

▶ LETTER BOX

Normal setting (standard type of display)

SQUEEZE (Squeeze)

Expands the picture vertically when black bands appear at the top and bottom of the

screen in 16:9 aspect ratio.

■ For DCR-HC39E/HC42E/HC43E: VF WIDE DISP

You can select how a 16:9 aspect ratio picture appears in the viewfinder.

▶ LETTER BOX

Normal setting (standard type of display)

SQUEEZE (Squeeze)

Expands the picture vertically when black bands appear at the top and bottom of the screen in 16:9 aspect ratio.

A/V→DV OUT (DCR-HC32E/HC33E/HC42E/HC43E)

When you set [A/V→DV OUT] () to [ON], you can convert the signal to the appropriate one by connecting a digital device and an analog device to your camcorder. See page 78 for details.

VIDEO INPUT (DCR-HC32E/HC33E/HC42E/HC43E)

Selects the video plug to connect when you input the picture from the other device via A/V connecting cable.

▶ VIDEO

Connects via video plug of the A/V connecting cable (supplied).

S VIDEO

Connects via S VIDEO plug of the A/V connecting cable with S VIDEO cable (optional).

TV TYPE (DCR-HC39E/HC42E/HC43E)

See page 32.

USB-CAMERA

You can view the pictures displayed on the screen of your camcorder on your computer (USB Streaming) via the USB cable. See

“First Step Guide” stored on the supplied CD-ROM (p. 68).

USB-PLY/EDT (USB-Play/Edit)

Select this when you view pictures stored in your camcorder on your computer (p. 68), or when you connect your camcorder to a PictBridge compliant printer via a USB cable (supplied) (p. 65).

► STD-USB

Displays pictures saved on the “Memory Stick Duo.”

PictBridge

See page 65.

USB STREAM

Displays pictures saved on the tape.

DISP GUIDE

See page 14.

DATA CODE

Displays information recorded automatically (data code) during recording.

► OFF

Data code is not displayed.

DATE/TIME

Displays the date and time.

CAMERA DATA (below)

Displays camera setting data.

This cannot be selected during Easy Handycam operation.

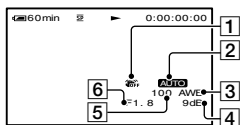

- 1 SteadyShot off*
- 2 Exposure*
- 3 White balance*
- 4 Gain*

5 Shutter speed

6 Aperture value

* Appears only during tape playback.

- Camera setting data does not appear when movies on a “Memory Stick Duo” are played back.
- The exposure adjustment value (0EV), a shutter speed, and the aperture value appear when still images on a “Memory Stick Duo” are played back.
- appears for a picture recorded using a flash (optional).
- In the DATE/TIME data display, the date and time are displayed in the same area. If you record a picture without setting the clock, [-- --] and [--:--:--] will appear.

REMAINING

► AUTO

Displays the remaining tape indicator for about 8 seconds in situations such as those described below.

- When you set the POWER switch to PLAY/EDIT or CAMERA-TAPE with a cassette inserted.
- When you touch (Play/Pause).

ON

Always displays the remaining tape indicator.

REMOTE CTRL (Remote control)

The default setting is [ON], allowing you to use the Remote Commander (p. 30).

- Set to [OFF] to prevent your camcorder from responding to a command sent by another VCR remote control unit.
- The setting returns to [ON] when you have the power source disconnected from your camcorder for more than 5 minutes.

REC LAMP (Recording lamp)

The camera recording lamp will not light up during recording when you set this to [OFF]. (The default setting is [ON].)

STANDARD SET menu (continued)

BEEP

▶ ON

A melody sounds when you start/stop recording, or operate the touch panel.

OFF

Cancels the melody.

DISP OUTPUT

▶ LCD PANEL

Shows displays such as the time code on the LCD screen and in the viewfinder.

V-OUT/PANEL

Shows displays such as the time code on the TV screen, LCD screen, and in the viewfinder.

MENU ROTATE

▶ NORMAL

Scrolls the menu items downwards by touching .

OPPOSITE

Scrolls the menu items upwards by touching .

A.SHUT OFF (Auto shut off)

▶ 5 min

The camcorder is automatically turned off when you do not operate your camcorder for more than approximately 5 minutes.

NEVER

The camcorder is not automatically turned off.

- When you connect your camcorder to a wall socket, [A.SHUT OFF] is automatically set to [NEVER].

CALIBRATION

See page 110.

TIME/LANGU. menu



(CLOCK SET/WORLD TIME/LANGUAGE)

See page 34 for details on selecting menu items.

CLOCK SET

See page 15.

WORLD TIME

When using your camcorder abroad, you can set the time difference by touching /, the clock will be adjusted in accordance with the time difference.

If you set the time difference to 0, the clock returns to the originally set time.

LANGUAGE

You can select the language to be used on the LCD screen.

You can select from English, Simplified English, Traditional-Chinese, Simplified-Chinese, French, Spanish, Portuguese, German, Dutch, Italian, Greek, Russian, Arabic, Persian, or Thai.

- Your camcorder offers [ENG[SIMP]] (simplified English) for when you cannot find your native tongue among the options.

Customizing Personal Menu

You can add desired menu items to Personal Menu, and customize Personal Menu settings for each POWER switch position. This is convenient if you add frequently used menu items to Personal Menu.

Adding a menu item

You can add up to 28 menu items for each POWER switch position. Delete a less important menu item, if you want to add more.

- 1 Touch [P-MENU] → [P-MENU SET UP] → [ADD].

If the desired menu item is not displayed, touch \uparrow/\downarrow .

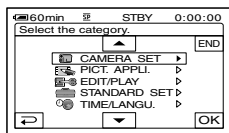

- 2 Touch \uparrow/\downarrow to select a menu category, then touch [OK].

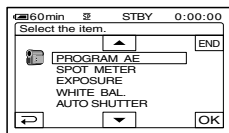

- 3 Touch \uparrow/\downarrow to select a menu item, then touch [OK] → [YES] → [X].

The menu item is added to the end of list.

Deleting a menu item

- 1 Touch [P-MENU] → [P-MENU SET UP] → [DELETE].

If the desired menu item is not displayed, touch \uparrow/\downarrow .

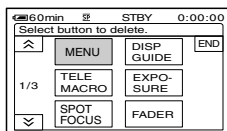

- 2 Touch the menu item that you want to delete.

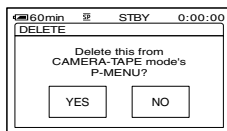

- 3 Touch [YES] → [X].

- You cannot delete [MENU] and [P-MENU SET UP].

Customizing Personal Menu (continued)

Arranging the order of menu items displayed on Personal Menu

- 1 Touch **[P-MENU]** → **[P-MENU SET UP]**
→ **[SORT]**.

If the desired menu item is not displayed, touch **[↕]**/**[↕]**.

- 2 Touch the menu item you want to move.

- 3 Touch **[▲]**/**[▼]** to move the menu item to the desired place.

- 4 Touch **[OK]**.

To sort more items, repeat steps 2 to 4.

- 5 Touch **[END]** → **[X]**.

• You cannot move [P-MENU SET UP].

Initializing the Personal Menu settings (Reset)

- Touch **[P-MENU]** → **[P-MENU SET UP]** → **[RESET]** → **[YES]** → **[YES]** → **[X]**.

If the desired menu item is not displayed, touch **[↕]**/**[↕]**.

Connecting to a VCR or TV

Connect your camcorder to the wall socket using the supplied AC Adaptor for this operation (p. 8). Refer also to the instruction manuals supplied with the devices to be connected.

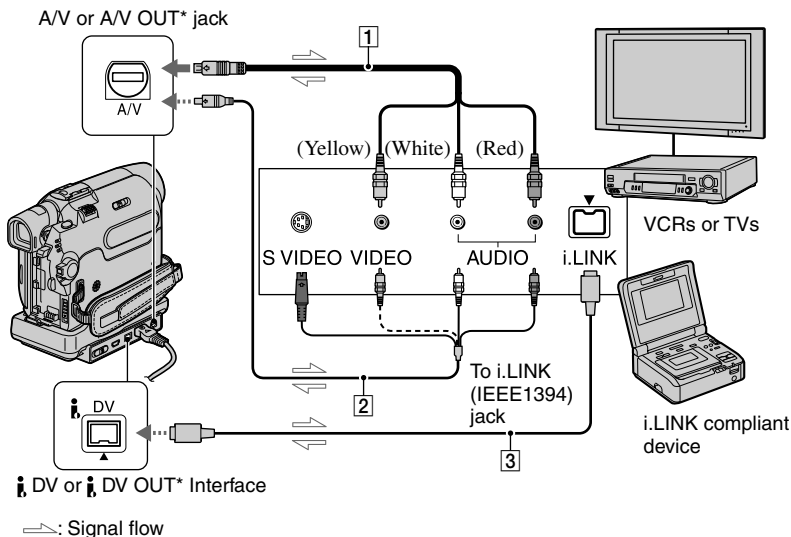

* For DCR-HC39E:
The jack works as an output only.

1 A/V connecting cable (supplied)

Connect the A/V connecting cable to your camcorder or the Handycam Station.

For DCR-HC32E/HC33E/HC42E/HC43E:
The A/V jack works as an input as well as an output, switching automatically depending on the operational status.

2 A/V connecting cable with S VIDEO (optional)

When connecting to another device via the S VIDEO jack, by using the A/V connecting cable with an S VIDEO cable (optional), pictures can be reproduced more faithfully than with the supplied A/V cable connection. Connect the white and red plugs (left/right audio) and S VIDEO plug (S VIDEO channel) of an A/V connecting cable (optional). In this case, the yellow (standard video) plug connection is not necessary. S

VIDEO connection only will not output audio.

3 i.LINK cable (optional)

Use an i.LINK cable (optional) to connect your camcorder to another device. The video and audio signals are transmitted digitally, producing high quality pictures. Note that you cannot output the picture and sound separately.

- Connect the A/V connecting cable to the output jack of a device you are dubbing a picture from (for DCR-HC32E/HC33E/HC42E/HC43E), or to the input jack of another device for dubbing a picture from your camcorder.
- When you are connecting your camcorder to a monaural device, connect the yellow plug of the A/V connecting cable to the video jack, and the red (right channel) or the white (left channel) plug to the audio jack on the VCR or the TV.
- When you connect a device via an A/V connecting cable (supplied), set [DISP OUTPUT] to [LCD PANEL] (the default setting) (p. 54) to prevent the screen display

Connecting to a VCR or TV (continued)

dubbed with pictures.

- Do not connect A/V connecting cables to both your camcorder and the Handycam Station at the same time. The image and the sound might be distorted.

Dubbing to other recording devices

You can copy the picture played back on your camcorder to other recording devices (such as VCRs).

1 Connect your VCR to your camcorder as a recording device.

See page 57 for connection details.

2 Prepare your VCR for recording.

When dubbing to the VCR, insert a cassette for recording.

When dubbing to the DVD recorder, insert a DVD for recording.

If your recording device has an input selector, set it to the input mode.

3 Prepare your camcorder for playback.

Insert the recorded cassette.

For DCR-HC39E/HC42E/HC43E:
Set [TV TYPE] (p. 32) according to the playback device (TV, etc.).

4 Start the playback on your camcorder, and record it on the VCR.

Refer to the operating instructions supplied with your recording device for details.

5 When the dubbing is finished, stop your camcorder and the VCR.

- The following cannot be output via the iDV interface:
 - Indicators
 - [PICT. EFFECT] (p. 48), [D. EFFECT] (p. 47) or PB zoom (p. 23).
 - Titles that are recorded on other camcorder.
- To record the date/time and camera settings data, display them on the screen (p. 53).
- When connected using an i.LINK cable (optional), the recorded picture becomes rough when a picture is paused on your camcorder while recording to a VCR.

Recording pictures from a VCR or TV (DCR-HC32E/HC33E/HC42E/HC43E)

You can record pictures or TV programs from a VCR or TV on a tape or a “Memory Stick Duo.” You can also record a scene as a still image on a “Memory Stick Duo.” Be sure to insert a cassette or a “Memory Stick Duo” for recording in your camcorder beforehand.

- Your camcorder can only record from a PAL source. For example, French video or TV programs (SECAM) cannot be recorded correctly. See page 102 for details on TV color systems.
- If you use a 21-pin adaptor to input PAL source, you need a dual direction 21-pin adaptor (optional).

Recording movies

1 Connect your TV or VCR to your camcorder.

See page 57 for details of connecting.

- The DV_{IN} indicator appears when you connect your camcorder and other devices via an i.LINK cable. (This indicator may also appear on your TV.)

2 If you are recording from a VCR, insert a cassette.

3 Slide the POWER switch down to turn on the PLAY/EDIT lamp.

4 Operate your camcorder to record movies.

When recording on a tape, touch **[P-MENU]**
→ **[REC CTRL]** → **[REC PAUSE]**.

Recording pictures from a VCR or TV (continued)

When recording on a “Memory Stick Duo,” touch **[P-MENU]** → **[MENU]** →  (EDIT/PLAY) → **[REC MOVIE]**.

5 Start playing the cassette on your VCR, or select a TV program.

The picture played on the connected device appears on the LCD screen of your camcorder.

6 Touch **[REC START]** at the point you want to start recording.

7 Stop recording.

When recording on a tape, touch  (STOP) or **[REC PAUSE]**.

When recording on a “Memory Stick Duo,” touch **[REC STOP]**.

8 Touch → .

Recording still images

1 Perform steps 1 to 3 in “Recording movies.”

2 Play the video, or receive the TV program you want to record.

The pictures on the VCR or TV appear on the screen of your camcorder.

3 Press **PHOTO** lightly at the scene you want to record. Check the image and press it fully.

Dubbing pictures from a tape to a “Memory Stick Duo”

You can record movies or still images on a “Memory Stick Duo.” Make sure you have a recorded tape and a “Memory Stick Duo” inserted into your camcorder.



1 Slide the **POWER** switch down to turn on the **PLAY/EDIT** lamp.



2 Search and record the scene you want to record.

When you dub pictures as a still image

Touch  (PLAY) to play back the tape, then press **PHOTO** lightly at the scene you want to record. Check the image and press it fully.

When you dub pictures as a movie

Touch **[P-MENU]** → **[MENU]** →  (EDIT/PLAY) → **[REC MOVIE]** →  (PLAY) to play back the tape, then touch **[REC START]** at the point you want to start recording.

At the point you want to stop recording, touch **[REC STOP]** →  (STOP) →  → .

- The data code recorded on the tape cannot be recorded on the “Memory Stick Duo.” The time and date the picture is recorded on the “Memory Stick Duo” will be recorded.
- The sound is recorded in 32kHz monaural.
- For the recording time of movies, see page 44.
- For DCR-HC39E/HC42E/HC43E: Still images will be fixed to image size [640 × 360] when playing back the 16:9 picture, or [640 × 480] when playing back the 4:3 picture.

Dubbing sound to a recorded tape

You can add sound to a tape already recorded in the 12-bit mode (p. 51) without erasing the original sound.

Connecting

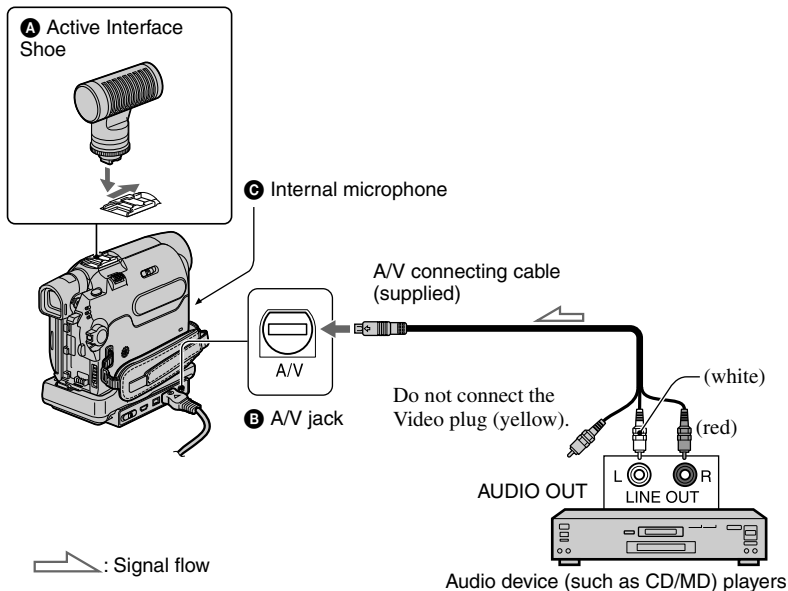

You can record audio by connecting in one of the following ways.

A For DCR-HC39E/HC42E/HC43E:

An external microphone (optional) to the Active Interface Shoe.

B For DCR-HC32E/HC33E/HC42E/HC43E:

An audio device to the Handycam Station or your camcorder using the A/V connecting cable.

C Using the internal microphone (no connection required).

The audio input to be recorded takes precedence over others in the order of **A** → **B** → **C**.

You cannot record additional audio:

- When the tape has been recorded in the 16-bit mode (p. 51).
- When the tape has been recorded in the LP mode.
- When your camcorder is connected via an i.LINK cable.
- When the tape has been recorded in 4CH MIC REC mode on another device.
- When the tape has been recorded in a TV color system other than that of your camcorder.
- On blank sections of the tape.
- When the write-protect tab of the cassette is set to SAVE.
- The picture will not be output from the A/V jack when dubbing audio:
 - with the A/V jack of these models: DCR-HC32E/HC33E/HC42E/HC43E.

Dubbing sound to a recorded tape (continued)

– with the internal microphone.

Check the picture on the LCD screen or the viewfinder.

- For DCR-HC39E/HC42E/HC43E:
When you attach an external microphone (optional) to the Active Interface Shoe, you can check the picture and the sound by connecting your camcorder to a TV using the A/V connecting cable. However, sound you are recording afterwards is not output from your camcorder. Check the sound using a TV or other device.
- Do not connect A/V connecting cables to both your camcorder and the Handycam Station at the same time. The sound may be distorted.

Recording sound

Insert a recorded cassette into your camcorder beforehand.

1 Slide the **POWER** switch down to turn on the **PLAY/EDIT** lamp.

2 Touch **▶||** (**Play/Pause**) to play back the tape, then touch it again at the point where you want to start recording the sound.

3 Touch **P-MENU** → **[MENU]** →  (**EDIT/PLAY**) → **[AUD DUB CTRL]** → **[OK]** → **[AUDIO DUB]**.

 appears

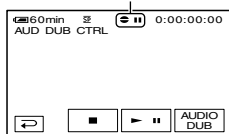

4 Touch **▶||** (**play**) and start playing back the audio you want to record at the same time.

 appears while recording the new sound in stereo 2 (ST2) during the playback of the tape.

5 Touch **■** (**stop**) when you want to stop recording.

To dub on other scenes, repeat step 2 to select scenes, then touch **[AUDIO DUB]**.

6 Touch  → **[X]**.

- To set the end point for audio dubbing, beforehand, press ZERO SET MEMORY on the Remote Commander at the scene at which you want to stop audio dubbing during playback. After step 2 to 4, the recording stops automatically at the selected scene.
- You can only record additional audio over a tape recorded on your camcorder. The sound may deteriorate when you dub audio on a tape recorded on other camcorders (including other DCR-HC32E/HC33E/HC39E/HC42E/HC43E camcorders).

To check the recorded sound

- 1 Play back the tape on which you have recorded audio (p. 21).
- 2 Touch **[P-MENU]** → **[MENU]** →  (STANDARD SET) → **[OK]** → **[AUDIO MIX]** → **[OK]**.

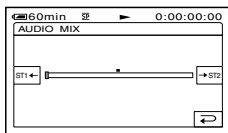

- 3 Touch **[ST1←]/[→ST2]** to adjust the balance of the original sound (ST1) and the sound recorded afterwards (ST2), then touch **[OK]**.
- The original sound (ST1) is output at the default setting.
 - The adjusted audio balance returns to the default setting in about 5 minutes after the battery pack or other power sources have been disconnected.

Deleting recorded pictures from the “Memory Stick Duo”

- 1 Slide the **POWER** switch down to turn on the **PLAY/EDIT** lamp.

- 2 Touch **[MEMORY]**.

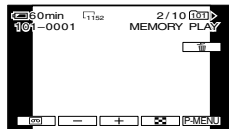

- 3 Select a picture you want to delete with **[-]/[+]**.

- To delete all pictures at once, select **[ALL ERASE]** (p. 45).

- 4 Touch  → **[YES]**.

- The pictures cannot be restored once they are deleted.

- You can delete pictures on the index screen (p. 21). You can easily search for the picture to be deleted by displaying 6 pictures at once. Touch **[SET]** →  **DELETE** → the picture you want to delete → **[OK]** → **[YES]**.
- Pictures cannot be deleted when a “Memory Stick Duo” with the write-protect tab is set to the write-protect position (p. 104), or when the selected picture is protected (p. 64).

Marking images on the “Memory Stick Duo” with specific information (Image protection/Print mark)

When you are using a “Memory Stick Duo” with the write-protect tab, make sure the write-protect tab on the “Memory Stick Duo” is not set to the write-protect position (p. 104).

Preventing accidental erasure (Image protection)

You can select and mark images to prevent accidental erasure.

1 Slide the POWER switch down to turn on the PLAY/EDIT lamp.

2 Touch [MEMORY] →  → [SET] → [PROTECT].

3 Touch the image that you want to protect.

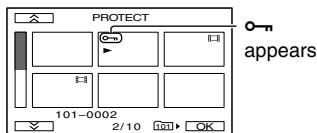

4 Touch [OK] → [END].

- To cancel image protection, touch the image again to cancel image protection in step 3.

Selecting still images for printing (Print mark)

The DPOF (Digital Print Order Format) standard is used to select images for printing on your camcorder.

By marking images that you want to print out, you do not need to reselect them when you print them out. (You cannot specify the number of printouts.)

1 Slide the POWER switch down to turn on the PLAY/EDIT lamp.

2 Touch [MEMORY] →  → [SET] → [PRINT MARK].

3 Touch the image that you want to print out later.

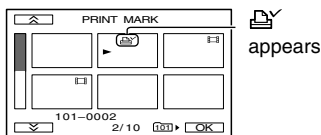

4 Touch [OK] → [END].

- To cancel Print mark, touch the image again to cancel Print mark in step 3.
- Do not mark images on your camcorder if the “Memory Stick Duo” already has some images with the Print mark put on using other devices. This may change the information of the images with the Print mark put on using the other device.

Printing recorded images

(PictBridge compliant printer)

You can print out pictures using a PictBridge compliant printer without connecting the camcorder to a computer.



PictBridge

Connect the supplied AC Adaptor to a wall socket for power.

Insert the “Memory Stick Duo” on which still images are stored into your camcorder beforehand.

Connect your camcorder to the printer

1 Slide the POWER switch down to turn on the PLAY/EDIT lamp.

2 Touch **P-MENU** → **[MENU]** →  (STANDARD SET) → **[USB-PLY/EDT]** → **[PictBridge]** → **[OK]** → .

3 Connect the USB jack (p. 67) of the Handycam Station to a printer using the USB cable.

4 Set the  (USB) ON/OFF switch on the Handycam Station to ON (p. 67)

5 Touch  (PICT. APPL.) → **[PRINT]**.

When connection is complete,  (PictBridge connecting) appears on the screen.

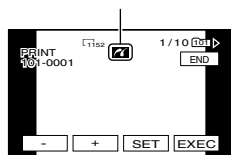



One of the images stored on the “Memory Stick Duo” will be displayed.

- We cannot guarantee the operation of models that are not PictBridge compatible.

Printing

1 Select the image to be printed with /.

2 Touch **[SET]** → **[COPIES]**.

3 Select the number of copies to be printed with /.

You can set a maximum of 20 copies of one image to be printed.

4 Touch **[OK]** → **[END]**.

To print the date on the image, touch **[SET]** → **[DATE/TIME]** → **[DATE]** or **[DAY & TIME]** → **[OK]**.

5 Touch **[EXEC]** → **[YES]**.

When printing is finished, **[Printing...]** disappears and the image selection screen appears again.

Touch **[END]** when printing is completed.

- Refer also to the operating instructions for the printer to be used.
- Do not attempt the following operations when  is on the screen. The operations may not be performed properly.
 - Operating the POWER switch.
 - Disconnecting the USB cable from the Handycam Station or the printer.

Printing recorded images (PictBridge compliant printer) (continued)

- Removing the “Memory Stick Duo” from your camcorder.
- If the printer stops working, disconnect the USB cable and restart the operation from the beginning.
- For DCR-HC39E/HC42E/HC43E:
If you print a still image recorded with a 16:9 ratio, left and right ends of the image may be cut off.
- Some printer models may not support the date printing function. Refer to your printer’s operating instructions for details.
- We cannot guarantee the printing of images recorded with a device other than your camcorder.
- PictBridge is an industry standard established by the Camera & Imaging Products Association (CIPA). You can print still images without using a computer by connecting a printer directly to a digital video camera or digital still camera, regardless of model or manufacturer.

Jacks to connect external devices

Camcorder

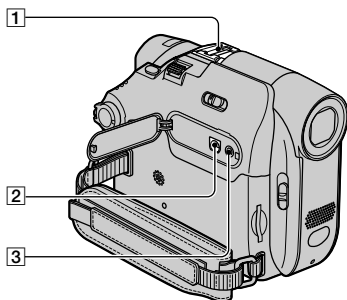

Bottom

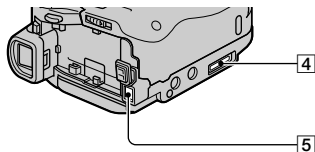

Handycam Station

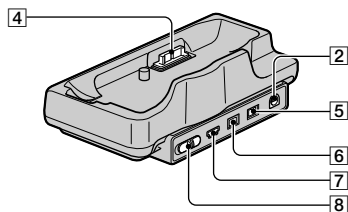

- 1 For DCR-HC39E/HC42E/HC43E:**
Active Interface Shoe  (p. 61)
The Active Interface Shoe supplies power to optional accessories such as a video light, a flash, or a microphone. The accessory can be turned on or off as you operate the POWER switch on your camcorder. Refer to the operating instructions supplied with your accessory for details.

For DCR-HC32E/HC33E:

Accessory shoe

- Remove the shoe cover when you use an accessory.
- The Active Interface Shoe and the accessory shoe have a safety device for fixing the installed accessory securely. To connect an accessory, press down and push it to the end, and then tighten the screw. To remove an accessory, loosen the screw, and then press down and pull out the accessory.
- When you are recording on a “Memory Stick Duo” with an external flash (optional) connected to the accessory shoe, turn off the power of the external flash to prevent charging noise being recorded.

- 2 For DCR-HC32E/HC33E/HC42E/HC43E:**

A/V (audio/video) jack (p. 32, 57, 78)

For DCR-HC39E:

A/V (audio/video) OUT jack (p. 32, 57, 78)

- 3**  LANC jack (blue)

- The LANC control jack is used for controlling the tape transport of video devices and peripherals connected to it.

- 4** Interface connector

- 5** DC IN jack (p. 8)

- 6 For DCR-HC32E/HC33E/HC42E/HC43E:**

 DV Interface jack (p. 57, 75, 78)

For DCR-HC39E:

 DV OUT Interface jack (p. 57, 75)

- 7**  (USB) jack (p. 68)

- 8**  (USB) ON/OFF switch

- Set this to ON to use the USB connection.

Before referring to the “First Step Guide” on your computer

When you install the Picture Package software on a Windows computer from the supplied CD-ROM, you can enjoy the following operations by connecting your camcorder to your computer.

- Software and features available for Macintosh computers differ from those available for Windows computers. For details, refer to chapter 6 of “First Step Guide” on CD-ROM. For “First Step Guide”, see the next section.
- There are 2 ways to connect your camcorder to a computer.
 - USB cable
This method is good for copying video and sound recorded on a tape to the computer, copying files from a “Memory Stick Duo” to a computer, and copying files to a “Memory Stick Duo.”
 - i.LINK cable
This method is good for copying video and sound recorded on a tape. Image data is transferred in more clarity than with a USB cable.

For details on connection, see “First Step Guide”.

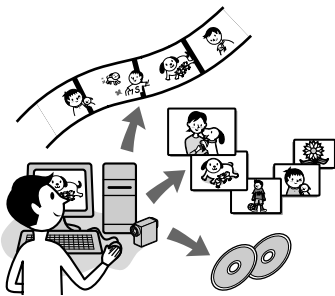

Viewing video and pictures on a computer

You can view the pictures copied from your camcorder by selecting from thumbnails. Still images and movies are saved in folders by date.

Music Video/Slideshow Producer

You can select your favorite movies and

still images from pictures saved on your computer and easily create a short original video or slide show with added music and visual styles.

Automatic Music Video Producer

You can easily create a short original video with added music and visual styles using pictures recorded on a tape.

Copying tape to Video CD

You can import the contents of a tape to create a video CD.

Save the images on CD-R

You can save pictures copied onto a computer to a CD-R as a backup.

Burning Video CD

You can compose a video CD with a menu of videos and slide shows. ImageMixer VCD2 is compatible with high resolution still pictures.

USB Streaming Tool

You can view the picture your camcorder is playing back on tape or is currently seeing on a computer.

Video Capturing Tool

You can import the entire contents of a tape to a computer.

- The CD-ROM (supplied) includes the following software.
 - USB Driver
 - Picture Package Ver.1.5
 - ImageMixer VCD2
 - “First Step Guide”

About “First Step Guide”

“First Step Guide” is an instruction manual you can refer to on your computer. This “First Step Guide” describes basic operations, from initial hookup of your camcorder and computer and making settings, to general operation the first time you use the software stored on the CD-ROM (supplied). After installing the CD-ROM, reading “Installing the software and “First Step Guide” on a computer” (p. 70), start the “First Step Guide”, then follow the instructions.

About the help function of the software

The Help guide explains all the functions of all the software applications. Refer to the Help guide for further detailed operations after reading the “First Step Guide” thoroughly. To display the Help guide, click the [?] mark on the screen.

System requirements

■ For Windows users

When using Picture Package

OS: Microsoft Windows 98, Windows 98SE, Windows 2000 Professional, Windows Millennium Edition, Windows XP Home Edition or Windows XP Professional Standard installation is required. Operation is not assured if the above OS has been upgraded.
 In Windows 98, USB Streaming is not supported.
 In Windows 98 and Windows 98SE, DV capturing is not supported.

CPU: Intel Pentium III 500 MHz or faster (800 MHz or faster recommended) (For using ImageMixer VCD2, Intel Pentium III 800 MHz or faster recommended)

Application: DirectX 9.0c or later (This product is based on DirectX technology. It is necessary to have DirectX installed.)

Windows Media Player 7.0 or later
 Macromedia Flash Player 6.0 or later

Sound system: 16 bit stereo sound card and stereo speakers

Memory: 64 MB or more

Hard disk: Available memory required for installation: 500 MB or more
 Available free hard disk space recommended: 6 GB or more (depending on the size of the image files edited)

Display: 4 MB VRAM video card, Minimum 800 × 600 dots, High color (16 bit color, 65 000 colors), DirectDraw display driver capability (This product will not operate correctly at less than 800 × 600 dots, or less than 256 colors.)

Others: USB port (This must be provided as standard), DV Interface (IEEE1394, i.LINK) (to connect via an i.LINK cable), disc drive (You need a CD-R drive to create a video CD.

For the compatible drive, visit the following
 URL: <http://www.ppackage.com/>)

When playing pictures recorded on a “Memory Stick Duo” on a computer

OS: Microsoft Windows 98, Windows 98SE, Windows 2000 Professional, Windows Millennium Edition, Windows XP Home Edition or Windows XP Professional Standard installation is required. Operation is not assured if the above OS has been upgraded.

CPU: MMX Pentium 200MHz or faster

Application: Windows Media Player (This must be installed to play back movies.)

Before referring to the “First Step Guide” on your computer (continued)

Others: USB port (This must be provided as standard), disc drive

■ For Macintosh users

When using ImageMixer VCD2

OS: Mac OS X (v10.1.5 or later)

CPU: iMac, eMac, iBook, PowerBook, PowerMac G3/G4/G5 series

Memory: 128 MB or more

Hard disk: Available memory required for installation: 250 MB or more
Available free hard disk space recommended: 4 GB or more (depending on the size of the image files edited)

Display: Minimum 1 024 × 768 dots, 32 000 colors (This product will not operate correctly at less than 1 024 × 768 dots or 256 colors.)

Application: QuickTime 4 or later (QuickTime 5 recommended)

Other: Disc drive

When only copying pictures recorded on a “Memory Stick Duo” on a computer

OS: Mac OS 9.1/9.2 or Mac OS X (v 10.0/v 10.1/v 10.2/v 10.3)

Application: QuickTime 3.0 or later (This must be installed to play back movies.)

Others: USB port (This must be provided as standard)

- When you connect your camcorder to a Macintosh computer using a USB cable, you cannot copy pictures recorded on a tape to the computer. To copy recordings from a tape, connect your camcorder to the computer with an i.LINK cable and use the standard software in the OS.

Installing the software and “First Step Guide” on a computer

You need to install the software etc., with the supplied CD-ROM on your computer **before connecting your camcorder** and your computer. Once you install it, the installation is not required thereafter. The software to be used varies depending on the OS system you are using.
Windows computer: Picture Package (including ImageMixer VCD2)
Macintosh computer: ImageMixer VCD2
For the details on the software, refer to “First Step Guide”.

Installing on a Windows computer

Log on as Administrators for installation for Windows 2000/Windows XP.

1 Confirm that your camcorder is not connected to the computer.

2 Turn on the computer.

Close all applications running on the computer before installing the software.

3 Place the CD-ROM in the disc drive of your computer.

The installation screen appears.



If the screen does not appear

- ① Double-click [My Computer].

- ② Double-click [PICTUREPACKAGE] (Disc drive).*

* Drive names (such as (E:)) may vary depending on the computer.

4 Click [Install].



Depending on the OS on the computer, a message appears notifying you that “First Step Guide” cannot be installed automatically with the InstallShield Wizard. In such a case, manually copy “First Step Guide” to your computer according to the message instructions.

5 Select the language for the application to be installed, then click [Next].



6 Click [Next].



7 Read [License Agreement], check [I accept the terms of the license agreement] when you agree, then click [Next].



8 Select where to save the software, then click [Next].



9 Click [Install] on the [Ready to Install the Program] screen.

The installation of Picture Package starts.



Installing the software and “First Step Guide” on a computer (continued)

- 10** Select the language for “First Step Guide” to be installed, then click [Next].

Depending on the computer, this screen may not be displayed. In such a case, skip to step 12.



- 11** Click [Next] to install the “First Step Guide”.



- 12** Click [Next], then follow the on-screen instructions to install ImageMixer VCD2.



- 13** If the [Installing Microsoft (R) DirectX(R)] screen is displayed, follow the steps below to install DirectX 9.0c. If not, skip to step 14.

- ① Read [License Agreement], then click [Next].



- ② Click [Next].



- ③ Click [Finish].



- 14** Make sure [Yes, I want to restart my computer now.] is checked, then click [Finish].



The computer turns off once, then starts up again automatically (Restart). The short-cut icons for [Picture Package Menu] and [Picture Package Menu destination Folder] (and “First Step Guide”, if installed by steps 11-12) appear on the desktop.



15 Remove the CD-ROM from the disc drive of your computer.

- If you have any questions about Picture Package, contact information is listed on page 74.

Installing on a Macintosh computer

1 Confirm that your camcorder is not connected to the computer.

2 Turn on the computer.

Close all applications running on the computer before installing the software.

3 Place the CD-ROM in the disc drive of your computer.

4 Double-click CD-ROM icon.

5 Copy [FirstStepGuide.pdf], stored in the desired language in the [FirstStepGuide] folder, to your computer.

6 Then, install ImageMixer VCD2.

7 Copy [IMXINST.SIT] in the [MAC] folder of the CD-ROM to a folder of your choice.

8 Double-click [IMXINST.SIT] in the folder it was copied to.

9 Double-click the unzipped [ImageMixerVCD2_Install].

10 When the user acceptance screen is displayed, enter your name and password.

The installation of ImageMixer VCD2 starts.

- For details on how to use ImageMixer VCD2, refer to software's on-line help.

Viewing “First Step Guide”

Displaying “First Step Guide”

Starting up on a Windows computer

Viewing with Microsoft Internet Explorer Ver.6.0 or later is recommended.

Double-click the  icon on the desktop.



You can also start by selecting [Start], [Programs] ([All Programs] for Windows XP), [Picture Package], and [FirstStepGuide], then start up [FirstStepGuide].

- To view “First Step Guide” in HTML without using automatic installation, copy the desired language folder from the [FirstStepGuide] folder on the CD-ROM, and then double-click “index.html”.
- Refer to “FirstStepGuide.pdf” in the following cases:
 - When printing “First Step Guide”
 - When “First Step Guide” is not displayed correctly due to the browser setting even in recommended environment.
 - When the HTML version of “First Step Guide” is not installed automatically.

Starting up on a Macintosh computer

Double-click “FirstStepGuide.pdf”.

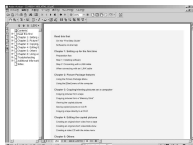

To view the PDF, Adobe Reader is needed. If it is not installed on your computer, you can download it from the Adobe Systems web page:
<http://www.adobe.com/>

For inquires about this software

Pixela User Support Center

Pixela Home Page

Windows: <http://www.ppackage.com/>

Macintosh: <http://www.ImageMixer.com/>

– North America (Los Angeles) Telephone:

+1-213-341-0163

– Europe (U.K.) Telephone:

+44-1489-564-764

– Asia (Philippines) Telephone:

+63-2-438-0090

On Copyrights

Music works, sound recording or other third party musical contents you may acquire from CDs, the Internet or other sources (the “Music Contents”) are the copyrighted work of the respective owners thereof and are protected by copyright laws and other applicable laws of each country/region. Except to the extent expressly permitted by applicable laws, you are not permitted to use (including, without limitation, copying, modifying, reproducing, uploading, transmitting or placing to the external network accessible to the public, transferring, distributing, lending, licensing, selling and publishing) any of the Music Contents without obtaining authorization or approval of the respective owners thereof. License of Picture Package by Sony Corporation would not be construed as conferring to you by implication, estoppel or otherwise, any license or right to use the Music Contents.

Creating a DVD (Direct Access to “Click to DVD”)

You can create DVDs when you connect your camcorder to a Sony VAIO series computer* that supports “Click to DVD” via an i.LINK cable (optional). The picture is automatically copied and written to a DVD.

The following procedures describe how to create a DVD from a picture recorded on a tape. For system and operation requirements, visit the following URL:

- Europe
<http://www.vaio-link.com/>
- USA
<http://www.ita.sel.sony.com/support/dvimag/>
- Asia Pacific Regional
<http://www.css.ap.sony.com/>
- Korea
<http://scs.sony.co.kr/>
- Taiwan
<http://vaio-online.sony.com/tw/vaio/>
- China
<http://www.sonystyle.com.cn/vaio/>
- Thailand
<http://www.sony.co.th/vaio/index.html>
- Latin America
<http://vaio-online.sony.com/>

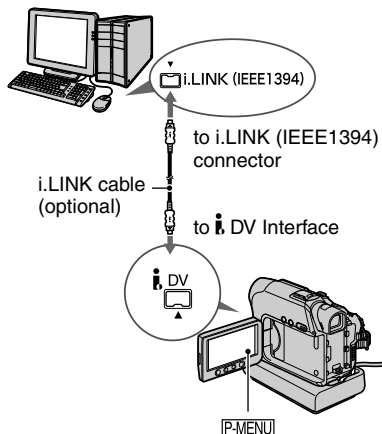

- You can only use an i.LINK cable for this operation. You cannot use a USB cable.
- * Note that you need a Sony VAIO computer equipped with a DVD drive that can be used to write DVDs. You also need the computer with “Click to DVD Ver.1.2” (Sony original software) or later installed.

Using the Direct Access to “Click to DVD” function for the first time

The Direct Access to “Click to DVD” function enables you to copy pictures recorded on a tape to a DVD easily if your camcorder is connected to a computer. Before operating the Direct Access to “Click to DVD” function, follow the steps below to start “Click to DVD Automatic Mode Launcher.”

- ① Turn on the computer.
- ② Click the start menu, then select [All Programs].
- ③ Select [Click to DVD] from the programs displayed, then click [Click to DVD Automatic Mode Launcher].
[Click to DVD Automatic Mode Launcher] starts up.

- After you start up [Click to DVD Automatic Mode Launcher] once, from then on it starts up automatically when you turn on your computer.
- [Click to DVD Automatic Mode Launcher] is set up for each Windows XP user.

Creating a DVD (Direct Access to “Click to DVD”) (continued)

1 Turn on the computer.

Quit all applications running with an i.LINK.

2 Prepare the power source for your camcorder, then slide the POWER switch down to turn on the PLAY/ EDIT lamp.

Use the supplied AC Adaptor as the power source since it takes a few hours to create a DVD.

3 Insert a recorded cassette into your camcorder.

4 Connect your camcorder to a computer via an i.LINK cable (optional) (p. 75).

- When you connect your camcorder to a computer, make sure you insert the connector in the correct direction. If you insert the connector forcibly, it may be damaged, and causes a malfunction of your camcorder.
- For details, see “First Step Guide”.

5 Touch [P-MENU] → [MENU] → (EDIT/PLAY) → [BURN DVD] → [OK].

“Click to DVD” starts up and the on-screen instructions appear on your computer.

6 Place a writable DVD in the disc drive of the computer.

7 Touch [EXEC] on the screen of your camcorder.

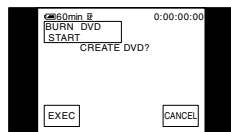

The status of the operation on your computer is displayed on the LCD screen of your camcorder.

CAPTURING: The picture recorded on the tape is being copied to the computer.

CONVERTING: The picture is being converted to the MPEG2 format.

WRITING: The picture is being written onto the DVD.

- If you use a DVD-RW/+RW which has other data stored on it, the message [This is a recorded disc. Delete and overwrite?] appears on the LCD screen of your camcorder. When you touch [EXEC], the existing data is erased and new data is written.

8 Touch [NO] to finish creating a DVD.

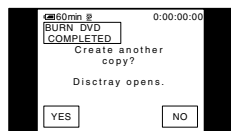

The disc tray comes out automatically. To create another DVD with the same content, touch [YES].

The disc tray comes out. Place a new writable DVD in the disc drive. Then, repeat step 7 and 8.

To cancel the operation

Touch [CANCEL] on the LCD screen on your camcorder.

- You cannot cancel the operation after [Finalizing DVD.] is displayed on the LCD screen of your camcorder.
- Do not disconnect the i.LINK cable or set the POWER switch to another mode on your camcorder until the picture is completely copied to the computer.
- When [CONVERTING] or [WRITING] is displayed on the screen, capturing of pictures has already finished. Even if you disconnect the i.LINK cable or turn off the camcorder at this stage, DVD creation will continue on your computer.
- When any of the following occurs, copying of the picture is canceled. A DVD containing the data up to the point the operation was canceled is created. Refer to the help files of “Click to DVD Automatic Mode Launcher” for details.
 - When there is a blank portion of 10 seconds or longer on the tape.
 - When the data of the tape contains a date before the recording date of the later images.
 - When normal and wide size pictures are recorded on the same tape.
- You cannot operate your camcorder in the following situations:
 - While playing back a tape
 - While recording images onto a “Memory Stick Duo”
 - When “Click to DVD” is started up from the computer
 - For DCR-HC32E/HC33E/HC42E/HC43E: When [A/V→DV OUT] in the menu setting of your camcorder is set to [ON].

Connecting an analog VCR to the computer via your camcorder (Signal convert function)

(DCR-HC32E/HC33E/HC42E/HC43E)

Using the A/V connecting cable and an i.LINK cable (optional), you can convert an analog signal output from an analog device such as a VCR to a digital signal and transfer it to a digital device, such as a computer, via your camcorder.

Software that can record the video signal must be installed on your computer beforehand.

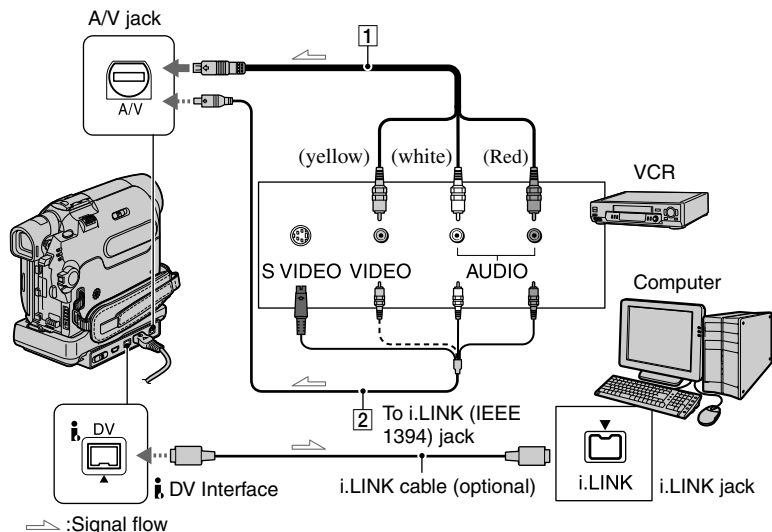

1 A/V connecting cable (supplied)

Connect the A/V connecting cable to your camcorder or the Handycam Station. The A/V jack accepts analog signals.

2 A/V connecting cable with S VIDEO (optional)

When connecting to another device via the S VIDEO jack, by using the A/V connecting cable with an S VIDEO cable (optional), pictures can be reproduced more faithfully than with the supplied A/V cable connection.

Connect the white and red plugs (left/right audio) and S VIDEO plug (S VIDEO channel) of an A/V connecting cable (optional). In this case, the yellow (standard video) plug connection is not necessary. S VIDEO connection only will not output audio.

Set [DISP OUTPUT] to [LCD PANEL] on the menu (p. 54) beforehand. (The default setting is [LCD PANEL].)

1 Turn on the analog video unit.

2 Slide the POWER switch of your camcorder down to turn on the PLAY/EDIT lamp.

Use the supplied AC Adaptor as the power source.

3 On the LCD screen, touch **[P-MENU]**
→ **[MENU]** →  **(STANDARD SET)** → **[A/V→DV OUT]** → **[ON]** → **[OK]**.

4 Start playback on the analog video unit.

5 Start capturing procedures on your computer.

Regarding operation, refer to the operating instructions supplied with the software or the on-line help.

After capturing images and sound, stop capturing procedures on your computer, and stop playback on the analog video unit.

- The bundled software Picture Package or ImageMixer VCD2 does not support the signal convert function.
- You may not be able to output the pictures correctly depending on the condition of the analog video signal input to your camcorder.
- You cannot transfer pictures with copyright protection signals to a computer.
- You can use a USB cable instead of an i.LINK cable (optional) to transfer pictures to a computer. Note, however, that the picture displayed may lack the same smoothness.
- When you are using a USB cable or an i.LINK cable to connect your camcorder to a computer, make sure you insert the connectors in the correct direction. If you insert the connectors forcibly, they may be damaged, and cause a malfunction of your camcorder.

Troubleshooting

If you run into any problems using your camcorder, use the following table to troubleshoot the problem. If the problem persists, remove the power source and contact your Sony dealer.

Overall operations/Easy Handycam

The power does not turn on.

- The battery pack is discharged, running low, or not attached to the camcorder.
 - Attach a charged battery pack to the camcorder (p. 8).
 - Use the AC Adaptor to connect to a wall socket (p. 8).
 - Insert your camcorder into the Handycam Station correctly (p. 8).
-

The camcorder does not operate even when the power is set to on.

- Disconnect the AC Adaptor from the wall socket or remove the battery pack, then reconnect it after about 1 minute. If the functions still do not work, press the RESET button (p. 24) using a sharp-pointed object. (If you press the RESET button, all settings, including the clock setting, are reset, except the Personal Menu items.)
-

Buttons do not work.

- During Easy Handycam operation, the available buttons are limited (p. 18).
-

You cannot turn Easy Handycam operation on or off.

- During recording or communicating with another device via USB cable, you cannot turn Easy Handycam operation on or off.
-

Settings change during Easy Handycam operation.

- During Easy Handycam operation, the settings of the functions that are not displayed on the screen return to their defaults. Previously made settings are restored when you cancel the Easy Handycam operation.
-

[DEMO MODE] does not start.

- You cannot view the demonstration when the NIGHTSHOT PLUS switch is set to ON.
 - Eject the cassette and “Memory Stick Duo” from your camcorder (p. 16).
-

The camcorder gets warm.

- This is because the power has been turned on for a long time. This is not a malfunction.

Batteries/Power sources

The power abruptly turns off.

- When approximately 5 minutes have elapsed while you do not operate your camcorder, the camcorder is automatically turned off (A.SHUT OFF). Change the setting of [A.SHUT OFF] (p. 54), or turn on the power again (p. 12), or use the AC Adaptor.
- Charge the battery pack (p. 8).

The CHG (charge) lamp does not light while the battery pack is being charged.

- Slide the POWER switch up to OFF (CHG) (p. 8).
- Attach the battery pack to the camcorder correctly (p. 8).
- No power is supplied from the wall socket (p. 8).
- Insert your camcorder into the Handycam Station correctly (p. 8).
- The battery charge is completed (p. 8).

The CHG (charge) lamp flashes while the battery pack is being charged.

- Attach the battery pack to the camcorder correctly. If the problem persists, disconnect the AC Adaptor from the wall socket and contact your Sony dealer. The battery pack may be damaged.

The power turns off frequently although the remaining battery time indicator indicates that the battery pack has enough power to operate.

- A problem has occurred in the remaining battery time indicator, or the battery pack has not been charged enough. Fully charge the battery again to correct the indication (p. 8).

The remaining battery time indicator does not indicate the correct time.

- The temperature of the environment is too high or too low, or the battery pack has not been charged enough. This is not a malfunction.
- Fully charge the battery again. If the problem persists, replace the battery pack with a new one. It may be damaged (p. 8, 106).
- The indicated time may not be correct depending on the environment of use. When you open or close the LCD panel, it takes about 1 minute to display the correct remaining battery time.

The battery pack is quickly discharged.

- The temperature of the environment is too high or low, or the battery pack has not been charged enough. This is not a malfunction.
- Fully charge the battery again. If the problem persists, replace the battery pack with a new one. It may be damaged (p. 8, 106).

A problem occurs when the camcorder is connected to the AC Adaptor.

- Turn off the power, and disconnect the AC Adaptor from the wall socket. Then, connect it again.

LCD screen/viewfinder

A rippling effect appears on the LCD screen when you touch it.

- This is not a malfunction. Do not press hard on the LCD screen.
-

An unknown picture appears on the LCD screen or viewfinder.

- The camcorder is in [DEMO MODE] (p. 49). Touch the LCD screen or insert a cassette or a “Memory Stick Duo” to cancel [DEMO MODE].
-

An unknown indicator appears on the screen.

- Refer to the indicator list (p. 97).
-

The picture remains on the LCD screen.

- This occurs if you disconnect the AC Adaptor from the wall socket or remove the battery pack without turning off the power first. This is not a malfunction.
-

You cannot turn the LCD backlight off. (DCR-HC39E/HC42E/HC43E)

- During Easy Handycam operation (p. 18), you cannot turn the LCD backlight on/off using the DISP/BATT INFO.
-

The buttons do not appear on the touch panel.

- Touch the LCD screen lightly.
 - Press DISP/BATT INFO on your camcorder (or DISPLAY on the Remote Commander) (p. 14).
-

The buttons on the touch panel do not work correctly or do not work at all.

- Adjust the screen ([CALIBRATION]) (p. 110).
-

The picture in the viewfinder is not clear.

- Use the viewfinder lens adjustment lever to adjust the lens (p. 13).
-

The picture in the viewfinder has disappeared.

- Close the LCD panel. The picture is not displayed in the viewfinder when the LCD panel is open (p. 13).

Cassette tapes

The cassette cannot be ejected from the compartment.

- Make sure the power source (battery pack or AC Adaptor) is connected correctly (p. 8).
- Remove the battery pack from the camcorder, then attach it again (p. 9).
- Attach a charged battery pack to the camcorder (p. 8).

The cassette is not ejected even when the cassette lid is open.

- Moisture condensation is starting in your camcorder (p. 109).

The Cassette Memory indicator or title display does not appear while using a cassette with Cassette Memory.

- This camcorder does not support Cassette Memory, so the indicator does not appear.

The remaining tape indicator is not displayed.

- Set  REMAINING] to [ON] to always display the remaining tape indicator (p. 53).

“Memory Stick Duo”

You cannot operate functions using the “Memory Stick Duo.”

- Slide the POWER switch down to turn on the CAMERA-MEMORY or PLAY/EDIT lamp (p. 12).
- Insert a “Memory Stick Duo” into your camcorder (p. 16).
- If you use a “Memory Stick Duo” formatted on a computer, format it on your camcorder (p. 104).

Pictures cannot be deleted.

- Release the lock on the write-protect tab of the “Memory Stick Duo” (p. 104).
- Cancel image protection on the picture (p. 64).
- The maximum number of pictures that you can delete at one time is 100.

You cannot delete all pictures at once.

- Release the lock on the write-protect tab of the “Memory Stick Duo” (p. 104).
- Cancel image protection on the pictures (p. 64).

You cannot format the “Memory Stick Duo.”

- Release the lock on the write-protect tab of the “Memory Stick Duo” (p. 104).

Image protection cannot be applied.

- Release the lock on the write-protect tab of the “Memory Stick Duo” (p. 104).
 - Perform the operation again on the index screen (p. 64).
-

You cannot mark pictures for print.

- Release the lock on the write-protect tab of the “Memory Stick Duo” (p. 104).
 - Perform the operation again on the index screen (p. 64).
 - The maximum number of pictures you can mark for print is 999.
 - Movies cannot be marked for print.
-

The data file name is not indicated correctly.

- Only the file name is displayed if the directory structure does not conform to the universal standard.
 - The file is damaged.
 - The file format is not supported on your camcorder (p. 104).
-

The data file name flashes.

- The file is damaged.
 - The file format is not supported on your camcorder (p. 104).
-

Recording

Refer also to “Adjusting the image during recording” (p. 86) and “Memory Stick Duo” section (p. 83).

The tape does not start when you press REC START/STOP.

- Slide the POWER switch down to turn on the CAMERA-TAPE lamp (p. 20).
 - The tape has reached the end. Rewind it, or insert a new cassette.
 - Set the write-protect tab to REC or insert a new cassette (p. 103).
 - The tape is stuck to the drum due to moisture condensation. Remove the cassette and leave your camcorder for at least 1 hour, then re-insert the cassette (p. 109).
-

You cannot record on the “Memory Stick Duo.”

- Release the lock on the write-protect tab of the “Memory Stick Duo” (p. 104).
- The capacity is full. Delete unnecessary pictures recorded on the “Memory Stick Duo” (p. 63).
- Format the “Memory Stick Duo” on your camcorder or insert another “Memory Stick Duo” (p. 45).

- For DCR-HC32E/HC33E:
You cannot record still images on the “Memory Stick Duo” using [WIDE SELECT] mode (p. 42).
- For DCR-HC39E/HC42E/HC43E:
When [SMTH INT.REC] is activated, still images cannot be recorded on a “Memory Stick Duo” during tape recording.

The recording angle differs depending on the POWER switch setting position.

- The recording angle when the POWER switch is set to CAMERA-MEMORY is wider than when it is set to CAMERA-TAPE.

You cannot record a smooth transition on a tape from the last recorded scene to the next.

- Note the following.
 - Perform END SEARCH (p. 29).
 - Do not remove the cassette. (The picture will be recorded continuously without a break even when you turn the power off.)
 - Do not record pictures in SP mode and LP mode on the same tape.
 - Avoid stopping then recording a movie in the LP mode.

The shutter sound is not heard when you record a still image.

- Set [BEEP] to [ON] (p. 54).

The external flash (optional) does not work.

- The power of the flash is not turned on, or the flash is not attached correctly.

[END SEARCH] does not work.

- The cassette was ejected after recording (p. 29).
- The cassette is new and has nothing recorded.

[END SEARCH] does not work correctly.

- There is a blank section in the beginning or middle of the tape. This is not a malfunction.

Smooth interval recording stops/[Smooth interval rec discontinued due to error.] appears and recording stops. (DCR-HC39E/HC42E/HC43E)

- The video head may be dirty. Use a cleaning cassette (optional).
- Try again from the beginning.
- Use a Sony mini DV cassette.

Adjusting the image during recording

Refer also to “Menu” (p. 89).

The auto focus does not function.

- Set [FOCUS] to [AUTO] (p. 40).
- The recording conditions are not suitable for auto focus. Adjust the focus manually (p. 40).

[STEADYSHOT] does not function.

- Set [STEADYSHOT] to [ON] (p. 42).

The BACK LIGHT function does not function.

- The BACK LIGHT function is canceled when you set [EXPOSURE] to [MANUAL] (p. 39) or select [SPOT METER] (p. 38).
- The BACK LIGHT function does not work during Easy Handycam operation.

[DIGITAL ZOOM] does not function.

- [DIGITAL ZOOM] does not function when you set [TELE MACRO] to [ON].

A vertical band appears when recording candlelight or electric light in the dark.

- This occurs when the contrast between the subject and the background is too high. This is not a malfunction.

A vertical band appears when recording a bright subject.

- This phenomenon is called the smear effect. This is not a malfunction.

Tiny spots in white, red, blue, or green appear on the screen.

- The spots appear when you are recording in [SLOW SHUTTR], [SUPER NSPLUS], or [COLOR SLOW S]. This is not a malfunction.

The color of the picture is not correctly displayed.

- Deactivate the NightShot plus function (p. 22).

The picture appears too bright on the screen, and the subject does not appear on the screen.

- Deactivate the NightShot plus function (p. 22).
- Cancel the BACK LIGHT function (p. 23).

The picture appears too dark on the screen, and the subject does not appear on the screen. (DCR-HC39E/HC42E/HC43E)

- The LCD backlight is turned off. Press and hold DISP/BATT INFO for a few seconds to turn on the backlight (p. 13).

Flickering or changes in color occurs.

- This occurs when recording pictures under a fluorescent lamp, sodium lamp, or mercury lamp with [PORTRAIT] or [SPORTS]. Cancel [PROGRAM AE] in this case (p. 38).

Black bands appear when you record a TV screen or computer screen.

- Set [STEADYSHOT] to [OFF] (p. 42).

Playback

If you are playing back the pictures stored on a “Memory Stick Duo,” refer also to the “Memory Stick Duo” section (p. 83).

You cannot play back the tape.

- Slide the POWER switch down to turn on the PLAY/EDIT lamp.
- Rewind the tape (p. 21).

The pictures stored on a “Memory Stick Duo” are not played back in the actual size or aspect ratio.

- Pictures recorded on other devices may not appear in the actual size. This is not a malfunction.
- If you play back a movie recorded on the “Memory Stick Duo” with a 16:9 ratio, the black bands will appear at the top and bottom of the screen. This is not a malfunction.

Image data stored on a “Memory Stick Duo” cannot be played back.

- Deactivate the USB Streaming function on your camcorder and set the Ψ (USB) ON/OFF switch (p. 67) on the Handycam Station to OFF.
- Image data cannot be played back if you have modified files or folders, or have edited the data on a computer. (The file name flashes in that case.) This is not a malfunction (p. 105).
- Pictures recorded on other devices may not be played back. This is not a malfunction (p. 105).
- Pictures edited on a computer or recorded on other devices may not be played back.

Horizontal lines appear on the picture. The displayed pictures are not clear or do not appear.

- Clean the head using the cleaning cassette (optional) (p. 109).

No sound or only a low sound is heard.

- Set [MULTI-SOUND] to [STEREO] (p. 51).
 - Turn up the volume (p. 21).
 - Adjust [AUDIO MIX] from the [ST2] (additional sound) side until the sound is heard appropriately (p. 63).
 - When you are using an S VIDEO plug, make sure the red and white plugs of the A/V connecting cable are connected as well (p. 32).
-

The sound breaks off.

- Clean the head using the cleaning cassette (optional) (p. 109).
-

“---” is displayed on the screen.

- The tape you are playing was recorded without setting the date and time.
 - A blank section on the tape is being played.
 - The data code on a tape with a scratch or noise cannot be read.
-

Noises appear and **NTSC** is displayed on the screen.

- The tape was recorded in a TV color system other than that of your camcorder (PAL). This is not a malfunction (p. 102).
-

4ch-12b is displayed on the screen.

- The tape you are playing was recorded on another device with a 4ch microphone (4CH MIC REC). Your camcorder is not compatible with 4ch microphone recording.
-

Date Search does not work correctly.

- If one day's recording is less than 2 minutes, your camcorder may not accurately find the point where the recording date changes.
 - There is a blank section in the beginning or middle of the tape. This is not a malfunction.
-

Remote Commander

The supplied Remote Commander does not function.

- Set [REMOTE CTRL] to [ON] (p. 53).
- Remove any obstructions between the Remote Commander and the remote sensor.
- Point the remote sensor away from strong light sources such as direct sunlight or overhead lighting. Otherwise, the Remote Commander may not function properly.
- Insert a new battery. Insert a battery into the battery holder with the +/- polarities correctly matching the +/- marks (p. 111).

Another VCR malfunctions when you use the supplied Remote Commander.

- Select a commander mode other than VTR 2 for your VCR, or cover the sensor of your VCR with black paper.

Menu

Menu items are grayed out.

- You cannot select grayed items in the current recording/playback situation.

You cannot use [PROGRAM AE].

- You cannot use [PROGRAM AE] together with:
 - NightShot plus
 - [SUPER NSPLUS]
 - [COLOR SLOW S]
 - [TELE MACRO]
- [SPORTS] will not work when the POWER switch is set to CAMERA-MEMORY.

You cannot use [SPOT METER].

- You cannot use [SPOT METER] together with:
 - NightShot plus
 - [SUPER NSPLUS]
 - [COLOR SLOW S]
- If you set [PROGRAM AE], [SPOT METER] is automatically set to [AUTO].

You cannot use [EXPOSURE].

- You cannot use [EXPOSURE] together with:
 - NightShot plus
 - [SUPER NSPLUS]
 - [COLOR SLOW S]
- If you set [PROGRAM AE], [EXPOSURE] is automatically set to [AUTO].

You cannot use [WHITE BAL.].

- You cannot use [WHITE BAL.] when you use NightShot plus or [SUPER NSPLUS].

You cannot use [SPOT FOCUS].

- You cannot use [SPOT FOCUS] together with [PROGRAM AE].

You cannot use [TELE MACRO]

- You cannot use [TELE MACRO] together with:
 - [PROGRAM AE]
 - Recording a movie on a tape or “Memory Stick Duo.”

You cannot use [SUPER NSPLUS].

- You cannot use [SUPER NS PLUS] together with:
 - [FADER]
 - [D. EFFECT]
 - [PROGRAM AE]
-

[COLOR SLOW S] does not operate correctly.

- [COLOR SLOW S] may not operate correctly in total darkness. Use NightShot plus or [SUPER NSPLUS].
 - You cannot use [COLOR SLOW S] together with:
 - [FADER]
 - [D. EFFECT]
 - [PROGRAM AE]
 - [EXPOSURE]
 - [SPOT METER]
-

You cannot use [FADER].

- You cannot use [FADER] together with:
 - [SELF-TIMER]
 - [SUPER NSPLUS]
 - [COLOR SLOW S]
 - [D. EFFECT]
 - [SMTH INT. REC] (DCR-HC39E/HC42E/HC43E)
-

You cannot use [D. EFFECT].

- You cannot use [D. EFFECT] together with:
 - [SUPER NSPLUS]
 - [COLOR SLOW S]
 - [FADER]
 - You cannot use [SLOW SHUTTR], and [OLD MOVIE] together with [PROGRAM AE] (except [AUTO]).
 - You cannot use [OLD MOVIE] together with:
 - [WIDE SELECT] (DCR-HC32E/HC33E)
 - [PICT. EFFECT]
-

Dubbing/Editing/Connecting to other devices

Pictures output from the camcorder do not appear on the screen of the connected device.

- When attaching the camcorder to the Handycam Station, close the DC IN jack cover, and then fully insert the camcorder into the Handycam Station in the correct direction securely (p. 8).

Pictures from connected devices are not displayed on the LCD screen or the viewfinder.

- Set [DISP OUTPUT] to [LCD PANEL] (p. 54).
- You cannot input a signal to your camcorder if you press DISP/BATT INFO while [DISP OUTPUT] is set to [V-OUT/PANEL] (p. 54).

Pictures from connected devices cannot be zoomed.

- You cannot zoom the pictures from connected devices on your camcorder (p. 23).

Time code and other information appears in the display of the connected device.

- Set [DISP OUTPUT] to [LCD PANEL] while connected with an A/V connecting cable (p. 54).

You cannot dub correctly using the A/V connecting cable.

- Set [DISP OUTPUT] to [LCD PANEL] (p. 54).
- The A/V connecting cable is not connected properly. Make sure that the A/V connecting cable is connected to the proper jack, i.e. to the output jack of a device you are dubbing a picture from (for DCR-HC32E/HC33E/HC42E/HC43E), or to the input jack of another device for dubbing a picture from your camcorder.

New sound added to a recorded tape is not heard.

- Adjust [AUDIO MIX] from the [ST1] (original sound) side until the sound is heard appropriately (p. 63).

Still pictures cannot be dubbed from a tape to a “Memory Stick Duo.”

- You cannot record or a distorted picture may be recorded if the tape has been used repeatedly for recording.

Movies cannot be dubbed from a tape to a “Memory Stick Duo.”

- You cannot record or a distorted picture may be recorded in the following situations:
 - The tape has a blank section.
 - The tape has been used repeatedly for recording.
 - The input signal has been interrupted or cut.

You cannot input pictures. (DCR-HC32E/HC33E/HC42E/HC43E)

- You cannot input pictures while [DISP OUTPUT] is set to [V-OUT/PANEL] (p. 54).
- You cannot input pictures if you press the DISP/BATT INFO button.

The picture appears distorted or dark.

- A/V connecting cables are connected to both your camcorder and the Handycam Station. Disconnect one of the A/V connecting cables.

Connecting to a computer

The computer does not recognize your camcorder.

USB [i.LINK](#)

- Disconnect the cable from the computer and camcorder, then connect it again securely.
- Set the (USB) ON/OFF switch on the Handycam Station to ON.
- Connect the Handycam Station to the camcorder securely.
- Disconnect USB devices other than the keyboard, the mouse, and the camcorder from the computer.
- Disconnect the cable from the computer and camcorder, restart the computer, then connect them again correctly.

An error message appears when you place the supplied CD-ROM in your computer.

- Set the computer display as follows:
 - Windows: 800 × 600 dots or more, High Color (16 bits, 65 000 colors or more)
 - Macintosh: 1 024 × 768 dots or more, 32 000 colors or more

You cannot view the pictures the camcorder is seeing on the computer.

USB [i.LINK](#)

- Slide the POWER switch down to turn on the CAMERA-TAPE lamp on your camcorder, and set [USB-CAMERA] to [USB STREAM] (p. 52). (Only when connecting to the Windows computer with a USB cable)
- Disconnect the cable from the computer, turn on the camcorder, then connect it again.

You cannot view the pictures recorded on a tape on the computer. **USB** [i.LINK](#)

- Slide the POWER switch down to turn on the PLAY/EDIT lamp on your camcorder, and set [USB-PLY/EDT] to [USB STREAM] (p. 52). (Only when connecting to the Windows computer with a USB cable)
- Disconnect the cable from the computer, then connect it again.

You cannot view the pictures recorded on a tape on a Macintosh computer.

USB

- When you connect your camcorder to a Macintosh computer using a USB cable, you cannot copy pictures recorded on a tape to the computer. To copy recordings from a tape, connect your camcorder to the computer with an i.LINK cable (optional) and use the standard software in the OS.

You cannot view the pictures recorded on a “Memory Stick Duo” on the computer. **USB**

- Insert a “Memory Stick Duo” in the correct direction, then push it all the way in.
- You cannot use an i.LINK cable. Connect the camcorder and the computer using the USB cable.
- Slide the POWER switch down to turn on the PLAY/EDIT lamp on your camcorder, set [USB-PLY/EDT] to [STD-USB] (p. 53).

- The computer does not recognize the “Memory Stick Duo” during camcorder operations such as tape playback or editing. Finish any camcorder operations before connecting the camcorder to the computer.

The “Memory Stick Duo” icon ([Removable Disk] or [Sony Memory Stick]) does not appear on the computer screen. **[USB]**

- Insert a “Memory Stick Duo” into your camcorder.
- Disconnect the USB device other than the keyboard, the mouse, and the camcorder from the computer.
- Slide the POWER switch down to turn on the PLAY/EDIT lamp on your camcorder, set [USB-PLY/EDT] to [STD-USB] (p. 53).
- The computer does not recognize the “Memory Stick Duo” during camcorder operations such as tape playback or editing. Finish camcorder operations before connecting the camcorder to the computer.

The image does not appear on the screen of the Windows computer when using the USB cable. **[USB]**

- The USB driver has been registered incorrectly as the computer was connected to your camcorder before the installation of the USB driver was completed. Follow the procedure below to install the USB driver correctly.

■ For Windows 98/Windows 98SE/Windows Me

When copying or playing the pictures on a tape using a computer, the operation is not guaranteed on Windows 98.

- 1 Check that your camcorder is connected to a computer.
- 2 Right-click [My Computer], then click [Properties].
The [System Properties] screen appears.
- 3 Click the [Device Manager] tab.
- 4 If the devices below are already installed, right-click them, then click [Remove] to delete them.

For copying and viewing pictures recorded on a tape

- [USB Audio Device] in the [Sound, video and game controllers] folder
- [USB Device] in the [Other devices] folder
- [USB Composite Device] in the [Universal Serial Bus Controller] folder

For copying and viewing pictures recorded on a “Memory Stick Duo”

- [? Sony Handycam] or [? Sony DSC] with a “?” mark in the [Other devices] folder

- 5 When the [Confirm Device Removal] screen appears, click [OK].
- 6 Turn off the power of your camcorder, disconnect the USB cable, then restart the computer.
- 7 Place the supplied CD-ROM in the disc drive of your computer.
- 8 Follow the steps below and try to install the USB driver again.
 - 1 Double-click [My Computer].
 - 2 Right-click [PICTUREPACKAGE] [Disc drive]*.

* Drive names (such as (E:)) may vary depending on the computer.

- 3 Click [Open].
 - 4 Double-click [Driver].
 - 5 Double-click [Setup.exe].
- Deleting anything other than [USB Audio Device], [USB Device], [USB Composite Device], [? Sony Handycam] and [? Sony DSC] may cause a malfunction of your computer.

■ For Windows 2000

Log on as Administrator.

- 1 Check that your camcorder is connected to a computer.
- 2 Right-click [My Computer], then click [Properties].
The [System Properties] screen appears.
- 3 Click the [Hardware] tab → [Device Manager] → [View] → [Devices by type].
- 4 If the devices below are already installed, right-click them, then click [Uninstall] to delete them.

For copying and viewing pictures recorded on a tape

- [USB Composite Device] in the [Universal Serial Bus Controller] folder
- [USB Audio Device] in the [Sound, video and game controller] folder
- [Composite USB Device] in the [Other devices] folder

For copying and viewing pictures recorded on a “Memory Stick Duo”

- [? Sony Handycam] or [? Sony DSC] with a “?” mark in the [Other devices] folder

- 5 When the [Confirm Device Removal] screen appears, click [OK].
- 6 Turn off the power of your camcorder, disconnect the USB cable, then restart the computer.
- 7 Place the supplied CD-ROM in the disc drive.
- 8 Follow the steps below and try to install the USB driver again.
 - 1 Double-click [My Computer].
 - 2 Right-click [PICTUREPACKAGE] (Disc drive)*.
* Drive names (such as (E:)) may vary depending on the computer.
 - 3 Click [Open].
 - 4 Double-click [Driver].
 - 5 Double-click [Setup.exe].
 - Deleting anything other than [USB Composite Device], [USB Audio Device], [Composite USB Device], [? Sony Handycam] and [? Sony DSC] may cause a malfunction of your computer.

■ For Windows XP

Log on as Administrator.

- 1 Check that your camcorder is connected to a computer.
- 2 Click [Start].
- 3 Right-click [My Computer], then click [Properties].
The [System Properties] screen appears.
- 4 Click and choose the [Hardware] tab → [Device Manager] → [View] → [Devices by type].

- 5 If the devices below are already installed, right-click them, then click [Uninstall] to delete them.

For copying and viewing pictures recorded on a tape

- [USB Composite Device] in the [Universal Serial Bus Controller] folder
- [USB Audio Device] in the [Sound, video and game controller] folder
- [USB Device] in the [Other devices] folder

For copying and viewing pictures recorded on a “Memory Stick Duo”

- [? Sony Handycam] or [? Sony DSC] with a “?” mark in the [Other devices] folder

- 6 When the [Confirm Device Removal] screen appears, click [OK].
- 7 Turn off the power of your camcorder, disconnect the USB cable, then restart the computer.
- 8 Place the supplied CD-ROM in the disc drive of your computer.
- 9 Follow the steps below and try to install the USB driver again.
- 1 Double-click [My Computer].
 - 2 Right-click [PICTUREPACKAGE] (Disc drive)*.
- * Drive names (such as (E:)) may vary depending on the computer.
- 3 Click [Open].
 - 4 Double-click [Driver].
 - 5 Double-click [Setup.exe].
- Deleting anything other than [USB Composite Device], [USB Audio Device], [USB Device], [? Sony Handycam] and [? Sony DSC] may cause a malfunction of your computer.

You cannot copy pictures to the Windows computer. [USB](#)

- Display pictures recorded on a “Memory Stick Duo” with the following procedures.
 - 1 Double-click [My Computer].
 - 2 Double-click the icon for the newly recognized drive [Removable Disk (F:)] (For Windows XP, [Sony Memory Stick]). It may take some time until the drive is recognized. If the computer does not recognize it, the USB driver may be installed incorrectly.
 - 3 Double-click the desired image file.

[Cannot start Easy Handycam with USB connected] or [Cannot cancel Easy Handycam with USB connected] appears on the screen of your camcorder.

[USB](#)

- You cannot start or cancel the Easy Handycam settings while the USB cable is connected. Disconnect the USB cable from your camcorder first.

There is no sound when the camcorder is connected to the Windows computer via a USB cable. [USB](#)

- Change the settings for your computer environment as described in the following procedures:
 - 1 Select [Start] → [Programs] ([All Programs] for Windows XP) → [Picture Package] → [Handycam Tools] → [USB Streaming Tool].

- 2 Select another device on the [Select audio device] screen.
 - 3 Follow the on-screen instructions, click [Next], then click [Done].
- Sound is not supported on Windows 98.
-

The movie is not smooth during USB streaming. **[USB]**

- Change the settings as described in the following procedures:
 - 1 Select [Start] → [Programs] ([All Programs] for Windows XP) → [Picture Package] → [Handycam Tools] → [USB Streaming Tool].
 - 2 Adjust the slider in the (-) direction on [Select video quality].
 - 3 Follow the on-screen instructions, click [Next], then click [Done].
-

Picture Package does not function correctly.

- Close Picture Package, then restart the computer.
-

An error message appears while operating Picture Package.

- Close Picture Package first, then slide the POWER switch on your camcorder to turn on another lamp.
-

The CD-R drive is not recognized or data cannot be written on the CD-R in Picture Package Auto Video, Producer, CD Backup, or VCD Maker.

- For compatible drives, visit the following URL:
<http://www.ppackage.com/>
-

[USB streaming... This function is not available.] appears on the screen of your camcorder. **[USB]**

- Start recording or playing back pictures recorded on a “Memory Stick Duo” after USB Streaming is finished.
-

“First Step Guide” is not displayed correctly.

- Follow the procedure below and refer to “First Step Guide” (FirstStepGuide.pdf).
 - 1 Place the supplied CD-ROM in the disc drive of your computer.
 - 2 Double-click [My Computer].
 - 3 Right-click [PICTUREPACKAGE] (Disc drive)*.
 - * Drive names (such as (E:)) may vary depending on the computer.
 - 4 Click [Explorer].
 - 5 Double-click [FirstStepGuide].
 - 6 Double-click the desired language folder.
 - 7 Double-click “FirstStepGuide.pdf.”

Warning indicators and messages

Self-diagnosis display/Warning indicators

If indicators appear on the LCD screen or in the viewfinder, check the following. Some symptoms you can fix by yourself. If the problem persists even after you have tried a couple of times, contact your Sony dealer or local authorized Sony service facility.

C: (or E:) □□:□□ (Self-diagnosis display)

C:04:□□

- The battery pack is not an “InfoLITHIUM” battery pack. Use an “InfoLITHIUM” battery pack (p. 106).

C:21:□□

- Moisture condensation has occurred. Remove the cassette and leave your camcorder for at least 1 hour, then reinsert the cassette (p. 109).

C:22:□□

- Clean the head using a cleaning cassette (optional) (p. 109).

C:31:□□ / C:32:□□

- Symptoms that are not described above have occurred. Remove and insert the cassette, then operate your camcorder again. Do not perform this procedure if moisture starts to condense (p. 109).
- Remove the power source. Reconnect it again and operate your camcorder again.
- Change the cassette. Press RESET (p. 24), and operate your camcorder again.

E:61:□□ / E:62:□□

- Contact your Sony dealer or local authorized Sony service facility. Inform them of the 5-digit code, which starts from “E.”

101-1001 (Warning indicator pertaining to files)

- The file is damaged.
- The file is unreadable (p. 105).

(Battery level warning)

- The battery pack is nearly used up.
- Depending on the operating, environment, or battery conditions,  may flash, even if there are approximately 5 to 10 minutes remaining.

(Moisture condensation warning)*

- Eject the cassette, remove the power source, and then leave it for about 1 hour with the cassette lid open (p. 109).

(Warning indicator pertaining to “Memory Stick Duo”)

- “Memory Stick Duo” is not inserted (p. 16).

(Warning indicators pertaining to “Memory Stick Duo” formatting)*

- The “Memory Stick Duo” is damaged.
- The “Memory Stick Duo” is not formatted correctly (p. 45).

(Warning indicator pertaining to incompatible “Memory Stick Duo”)*

- An incompatible “Memory Stick Duo” is inserted (p. 104).

Warning indicators and messages (continued)

(Warning indicators pertaining to the tape)

Slow flashing:

- There is less than 5 minutes remaining on the tape.
- No cassette is inserted.*
- The write-protect tab on the cassette is set to lock (p. 103).*

Fast flashing:

- The tape has run out.*

(Eject cassette warning)*

Slow flashing:

- The write-protect tab on the cassette is set to lock (p. 103).

Fast flashing:

- Moisture condensation has occurred (p. 109).
- The self-diagnosis display code is displayed (p. 97).

(Warning indicator pertaining to image deletion)*

- The image is protected (p. 64).

(Warning indicator pertaining to the write-protect of the “Memory Stick Duo”)*

- The write-protect tab on the “Memory Stick Duo” is set to lock (p. 104).

(Warning indicator pertaining to the external flash)

Slow flashing:

- Still charging

Fast flashing:

- There is something wrong with the flash.

(Warning indicator pertaining to camera-shake warning)

- The amount of lights is not sufficient, so camera-shake easily occurs. Use the flash.
- The camcorder is unsteady, so camera-shake easily occurs. Hold the camcorder steady with both hands and shoot the image. However, note that the camera-shake warning indicator does not disappear.

* You hear a melody when the warning indicators appear on the screen (p. 54).

Description of warning messages

If messages appear on the screen, follow the instructions.

Battery

Use the “InfoLITHIUM” battery pack (p. 106).

Battery level is low.

- Change the battery (p. 8, 106)

Old battery. Use a new one (p. 106).

 **Re-attach the power source** (p. 8).

Moisture condensation

  **Moisture condensation. Eject the cassette** (p. 109)

  **Moisture condensation. Turn off for 1H** (p. 109).

■ Cassette/Tape

 **Insert a cassette** (p. 16).

 **Reinsert the cassette.**

- Check if the cassette is damaged.

 **The tape is locked - check the tab** (p. 103).

 **The tape has reached the end.**

- Rewind or change the tape.

■ “Memory Stick Duo”

 **Insert a Memory Stick** (p. 16).

 **Reinsert the Memory Stick.**

- Reinsert the “Memory Stick Duo” a few times. If even then the indicator flashes, the “Memory Stick Duo” might be damaged. Try with another “Memory Stick Duo.”

This is a read-only Memory Stick.

- Insert a writable “Memory Stick Duo.”

 **Incompatible type of Memory Stick.**

- A type of “Memory Stick Duo” incompatible with your camcorder is inserted (p. 104).

 **This Memory Stick is not formatted correctly.**

- Check the format, then format the “Memory Stick Duo” as necessary (p. 45, 104).

Cannot record. The Memory Stick is full.

- Delete unnecessary images (p. 63).

 **The Memory Stick is locked. Check the tab** (p. 104).

Cannot playback. Reinsert the Memory Stick (p. 16).

Cannot record. Reinsert the Memory Stick (p. 16).

No file.

- No file is recorded or there is no readable file on the “Memory Stick Duo.”

USB streaming... This function is not available.

- You tried to play back or record on a “Memory Stick Duo” during USB Streaming.

Memory Stick folders are full.

- You cannot create folders exceeding 999MSDCF. You cannot delete created folders using your camcorder.
- You will have to format the “Memory Stick Duo” (p. 45), or delete them using your computer.

Cannot record still images on Memory Stick (p. 104).

Cannot record movies on Memory Stick (p. 104).

Warning indicators and messages (continued)

■ PictBridge compliant printer

Check the connected device.

- Switch off the printer and switch it on again, then disconnect the USB cable and reconnect it.
-

Connect the camcorder to a PictBridge compatible printer.

- Switch off the printer and switch it on again, then disconnect the USB cable and reconnect it.
-

Error-Cancel the task.

- Check the printer.
-

Cannot print. Check the printer.

- Switch off the printer and switch it on again, then disconnect the USB cable and reconnect it.
-

■ Flash

Charging... Cannot record still images.

- You are trying to record a still image while charging the flash (optional).
-

■ Others

Cannot record due to copyright protection (p. 103).

Cannot add audio. Disconnect the i.LINK cable (p. 61).

Not recorded in SP mode. Cannot add audio (p. 61).

Not recorded in 12-bit audio. Cannot add audio (p. 61).

Cannot add audio on the blank portion of a tape (p. 61).

Cannot add audio (p. 61).

Dirty video head. Use a cleaning cassette (p. 109).

Cannot start Easy Handycam Cannot cancel Easy Handycam (p. 18).

USB is invalid in this mode during Easy Handycam

- You can select [STD-USB] when you set the POWER switch to PLAY/EDIT during Easy Handycam operation, but you cannot select [PictBridge] or [USB STREAM]. (The message disappears when you touch **[OK]**.)
-

HDV recorded tape. Cannot playback.

- Your camcorder cannot play back this format. Play back the tape with the equipment that recorded it.
-

HDV recorded tape. Cannot add audio.

- Your camcorder does not allow you to add audio on a section of a tape recorded in HDV format.
-

Disconnect one AV cable.

- A/V connecting cables are connected to both the camcorder and the Handycam Station. Disconnect one of them.
- When the A/V connecting cable is connected only to your camcorder, your camcorder is not attached to the Handycam Station correctly. Attach the Handycam Station correctly.

Using your camcorder abroad

Power supply

You can use your camcorder in any countries/regions using the AC Adaptor supplied with your camcorder within the AC 100 V to 240 V, 50/60 Hz range.

On TV color systems

Your camcorder is a PAL system-based camcorder. If you want to view the playback picture on a TV, it must be a PAL system based TV (see the following list) with an AUDIO/VIDEO input jack.

System	Used in
NTSC	Bahama Islands, Bolivia, Canada, Central America, Chile, Colombia, Ecuador, Guyana, Jamaica, Japan, Korea, Mexico, Peru, Surinam, Taiwan, the Philippines, the U.S.A., Venezuela, etc.
PAL	Australia, Austria, Belgium, China, Czech Republic, Denmark, Finland, Germany, Holland, Hong Kong, Hungary, Italy, Kuwait, Malaysia, New Zealand, Norway, Poland, Portugal, Singapore, Slovak Republic, Spain, Sweden, Switzerland, Thailand, United Kingdom, etc.
PAL - M	Brazil
PAL - N	Argentina, Paraguay, Uruguay.
SECAM	Bulgaria, France, Guiana, Iran, Iraq, Monaco, Russia, Ukraine, etc.

Simple setting of the clock by time difference

You can easily set the clock to the local time by setting a time difference when using your camcorder abroad. Select [WORLD TIME] in the  (TIME/LANGU.) menu, then set the time difference (p. 54).

Usable cassette tapes

You can use mini DV format cassettes only. Use a cassette with the ^{Mini} DV mark.

Mini DV ^{Digital Video Cassette} is a trademark.

Your camcorder is not compatible with cassettes with Cassette Memory.

To prevent a blank section from being made on the tape

Go to the end of the recorded section using [END SEARCH] (p. 29) before you begin the next recording in the following cases:

- You have played back the tape.
- You have used [EDIT SEARCH].

Copyright signal

■ When you play back

If the cassette you play back on your camcorder contains copyright signals, you cannot copy it to a tape in another video camera connected to your camcorder.

■ When you record (for DCR-HC32E/HC33E/HC42E/HC43E)

You cannot record software on your camcorder that contains copyright control signals for copyright protection of software. [Cannot record due to copyright protection.] appears on the LCD screen, or on the viewfinder if you try to record such software. Your camcorder does not record copyright control signals on the tape when it records.

Notes on use

■ When not using your camcorder for a long time

Remove the cassette and store it.

■ To prevent accidental erasure

Slide the write-protect tab on the cassette to set it to SAVE.

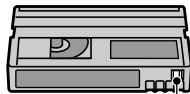

REC: The cassette can be recorded.

SAVE: The cassette cannot be recorded (write-protected).

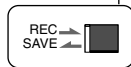

■ When labeling the cassette

Be sure to place the label only on the locations shown in the following illustration so as not to cause a malfunction of your camcorder.

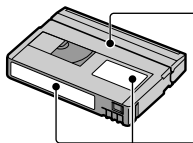

Do not put a label along this border.

Labeling position

■ After using the cassette

Rewind the tape to the beginning to avoid distortion of the picture or the sound. The cassette should then be put in its case, and stored in an upright position.

■ When cleaning the gold-plated connector

Generally, clean the gold-plated connector on a cassette with a cotton-wool swab after every 10 times it has been ejected.

If the gold-plated connector on the cassette is dirty or dusty, the remaining tape indicator may not be indicated correctly.

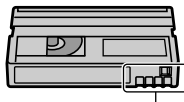

Gold-plated connector

About the “Memory Stick”

A “Memory Stick” is a compact, portable IC recording medium with a data capacity that exceeds the capacity of a floppy disk. You can use only a “Memory Stick Duo,” which is about the half size of a standard “Memory Stick” in your camcorder. However, appearance on the list below does not guarantee the operation of all types of “Memory Stick Duo” in your camcorder.

Types of “Memory Stick”	Recording/ Playback
“Memory Stick”	–
“Memory Stick Duo” ¹	○
“MagicGate Memory Stick”	–
“Memory Stick Duo” (MagicGate/Parallel Transfer) ¹	○ ^{2,3}
“MagicGate Memory Stick Duo” ¹	○ ³
“Memory Stick PRO”	–
“Memory Stick PRO Duo” ¹	○ ^{2,3}

¹A “Memory Stick Duo” is about half the size of a standard “Memory Stick.”

²The types of “Memory Stick” that support high speed data transfer. The speed of data transfer varies depending on the device to be used.

³“MagicGate” is a copyright protection technology that records and transfers the contents in an encrypted format. Note that data that uses “MagicGate” technology cannot be recorded or played on your camcorder.

- Still image format: Your camcorder compresses and records image data in the JPEG (Joint Photographic Experts Group) format. The file extension is “.JPG.”
- Movie format: Your camcorder compresses and records picture data in the MPEG (Moving Picture Experts Group) format. The file extension is “.MPG.”
- File names of still images:
 - 101- 0001: This file name appears on the screen of your camcorder.
 - DSC00001.JPG: This file name appears on the display of a computer.

- File names of movies:
 - MOV00001: This file name appears on the screen on your camcorder.
 - MOV00001.MPG: This file name appears on the display of a computer.
- A “Memory Stick Duo” formatted by a computer (Windows OS/Mac OS) does not have guaranteed compatibility with your camcorder.
- Data read/write speed may vary depending on the combination of the “Memory Stick” and “Memory Stick” compliant product you use.

On a “Memory Stick Duo” with a write-protect tab

You can prevent accidental erasure of images when you slide the write-protect tab on the “Memory Stick Duo” with a small tapered object, to the write-protect position. The “Memory Stick Duo” supplied with DCR-HC33E/HC43E is not equipped with a write-protect tab.

Notes on use

Image data may be damaged in the following cases. Compensation for damaged image data will not be made.

- If you eject the “Memory Stick Duo,” turn the power off on your camcorder, or remove the battery pack for replacement while your camcorder is reading or writing image files on the “Memory Stick Duo” (while the access lamp is lit or flashing).
- If you use the “Memory Stick Duo” near magnets or magnetic fields.

It is recommended you make a back-up of important data on the hard disk of a computer.

■ On handling a “Memory Stick”

Keep the following in mind when handling a “Memory Stick Duo.”

- Be careful not to apply excessive force when writing on a memo area on a “Memory Stick Duo.”
- Do not attach a label or the like on a “Memory Stick Duo” or a Memory Stick Duo adaptor.
- When you carry or store a “Memory Stick Duo,” put it in its case.
- Do not touch, or allow metallic objects to come into contact with the terminals.

- Do not bend, drop or apply strong force to the “Memory Stick Duo.”
- Do not disassemble or modify the “Memory Stick Duo.”
- Do not let the “Memory Stick Duo” get wet.
- Be careful to keep “Memory Stick Duo” media out of the reach of small children. There is danger that a child might swallow it.
- Do not insert anything other than a “Memory Stick Duo” into the “Memory Stick Duo” slot. Doing so may cause a malfunction.

■ On a location for use

Do not use or keep the “Memory Stick Duo” in the following locations.

- Places subject to extremely high temperature, such as a car parked outside in the summer.
- Places under direct sunlight.
- Places with extremely high humidity or subject to corrosive gases.

■ On the Memory Stick Duo adaptor (supplied with DCR-HC33E/HC43E)

After inserting a “Memory Stick Duo” into the Memory Stick Duo adaptor, you can use it with a standard “Memory Stick” compliant device.

- When using a “Memory Stick Duo” with a “Memory Stick” compliant device, be sure to insert the “Memory Stick Duo” into a Memory Stick Duo adaptor.
- When inserting a “Memory Stick Duo” into a Memory Stick Duo adaptor, make sure the “Memory Stick Duo” is inserted facing in the correct direction, then insert it all the way in. Note that improper use may damage the device. Also, if you force the “Memory Stick Duo” into the “Memory Stick Duo” slot in the wrong direction, the “Memory Stick Duo” slot may be damaged.
- Do not insert a Memory Stick Duo adaptor without a “Memory Stick Duo” attached. Doing so may result in malfunctions of the unit.

■ On a “Memory Stick PRO Duo”

- The maximum memory capacity of a “Memory Stick PRO Duo” that can be used on your camcorder is 1 GB.
- This unit does not support high speed data transfer.

On image data compatibility

- Image data files recorded on a “Memory Stick Duo” by your camcorder conform to the Design Rule for Camera File Systems universal standard established by the JEITA (Japan Electronics and Information Technology Industries Association).
- On your camcorder, you cannot play back still images recorded on other devices (DCR-TRV900E or DSC-D700/D770) that do not conform to the universal standard. (These models are not sold in some regions.)
- If you cannot use a “Memory Stick Duo” that has been used with another device, format it with your camcorder (p. 45). Note that formatting erases all information on the “Memory Stick Duo.”
- You may not be able to play back images with your camcorder:
 - When playing back image data modified on your computer.
 - When playing back image data recorded with other devices.

About the “InfoLITHIUM” battery pack

This unit is compatible with an “InfoLITHIUM” battery pack (P series). Your camcorder operates only with an “InfoLITHIUM” battery pack. “InfoLITHIUM” P series battery packs have the  mark.

What is an “InfoLITHIUM” battery pack?

An “InfoLITHIUM” battery pack is a lithium-ion battery pack that has functions for communicating information related to operating conditions between your camcorder and an optional AC Adaptor/charger.

The “InfoLITHIUM” battery pack calculates the power consumption according to the operating conditions of your camcorder, and displays the remaining battery time in minutes.

With an AC Adaptor/charger (optional), the remaining battery time and charging time appear.

To charge the battery pack

- Be sure to charge the battery pack before you start using your camcorder.
- We recommend charging the battery pack in an ambient temperature of between 10 °C to 30 °C (50 °F to 86 °F) until the CHG (charge) lamp turns off. If you charge the battery pack outside of this temperature range, you may not be able to charge it efficiently.
- After charging is complete, disconnect the cable from the DC IN jack on your camcorder, remove your camcorder from the Handycam Station, or remove the battery pack.

To use the battery pack effectively

- Battery pack performance decreases when the surrounding temperature is 10 °C (50 °F) or below, and the length of time you can use the battery pack becomes shorter. In that case, do one of the following to use the battery pack for a longer time.
 - Put the battery pack in a pocket to warm it up, and insert it in your camcorder right before you start taking shots.
 - Use a large capacity battery pack: NP-FP70/FP90 (optional).
- Frequent use of the LCD screen or a frequent playback, fast forward or rewind operation wears out the battery pack faster. We recommend using a large capacity battery pack: NP-FP70/FP90 (optional).
- Be sure to set the POWER switch to OFF (CHG) when not recording or playing back on your camcorder. The battery pack is also consumed when your camcorder is in recording standby or playback pause.
- Have spare battery packs ready for two or three times the expected recording time, and make trial recordings before making the actual recording.
- Do not expose the battery pack to water. The battery pack is not water resistant.

About the remaining battery time indicator

- When the power goes off even though the remaining battery time indicator indicates that the battery pack has enough power to operate, charge the battery pack fully again. The indication on the remaining battery time will be indicated correctly. Note, however, that the battery indication will not be restored if it is used in high temperatures for a long time, or if left in a fully charged state, or when the battery pack is frequently used. Use the remaining battery time indication as a guide to the approximate shooting time.
- The  mark that indicates low battery flashes even if there are still 5 to 10 minutes of battery time remaining, depending on the operating conditions or ambient temperature and environment.

About i.LINK

About storage of the battery pack

- If the battery pack is not used for a long time, fully charge the battery pack and use it up on your camcorder once a year to maintain proper function. To store the battery pack, remove it from your camcorder and put it in a dry, cool place.
- To discharge the battery pack on your camcorder completely, set [A.SHUT OFF] to [NEVER] on the  (STANDARD SET) menu and leave your camcorder in tape recording standby until the power goes off (p. 54).

About battery life

- The battery life is limited. Battery capacity drops little by little as you use it more and more, and as time passes. When the available battery time is shortened considerably, a probable cause is that the battery pack has reached the end of its life. Please buy a new battery pack.
- The battery life varies depending on how it is stored and the operating conditions and environment for each battery pack.

The DV Interface on this unit is an i.LINK-compliant DV Interface. This section describes the i.LINK standard and its features.

What is i.LINK?

i.LINK is a digital serial interface for transferring digital video, digital audio, and other data to other i.LINK-compatible devices. You can also control other devices using the i.LINK.

i.LINK-compatible devices can be connected using an i.LINK cable.

Possible applications are operations and data transactions with various digital AV devices.

When two or more i.LINK-compatible devices are connected to this unit in a daisy chain, operations and data transactions are possible with not only the device that this unit is connected to but also with other devices via the directly connected device. Note, however, that the method of operation sometimes varies according to the characteristics and specifications of the device to be connected. Also, operations and data transactions may not be possible on some connected devices.

- Normally, only one device can be connected to this unit with the i.LINK cable. When connecting this unit to an i.LINK-compatible device having two or more DV Interfaces, refer to the operating instructions of the device to be connected.
- i.LINK is a more familiar term for the IEEE 1394 data transport bus proposed by Sony, and is a trademark approved by many corporations.
- IEEE 1394 is an international standard standardized by the Institute of Electrical and Electronics Engineers.

About the i.LINK Baud rate

i.LINK's maximum baud rate varies according to the device. There are three types.

S100 (approx. 100Mbps*)

S200 (approx. 200Mbps)

S400 (approx. 400Mbps)

The baud rate is listed under “Specifications” in the operating instructions of each piece of equipment. It is also indicated near the i.LINK interface on some devices.

The maximum baud rate for a device that does not have any indication (such as this unit) is “S100.”

The baud rate may differ from the indicated value when the unit is connected to a device with a different maximum baud rate.

* What is Mbps?

Mbps stands for “megabits per second,” or the amount of data that can be sent or received in one second. For example, a baud rate of 100 Mbps means that 100 megabits of data can be sent in one second.

To use i.LINK functions on this unit

For details on how to dub when this unit is connected to other video devices having a DV Interface, see page 57.

This unit can also be connected to other i.LINK (DV Interface) compatible devices made by Sony (e.g. a VAI0 series personal computer) as well as to video devices.

Before connecting this unit to your computer, make sure that application software supported by this unit is already installed on your computer.

Some i.LINK compatible video devices, such as Digital Televisions, DVD, MICROMV or HDV recorders/players are not compatible with DV devices. Before connecting to other devices, be sure to confirm whether the device is compatible with a DV device or not. For details on precautions and compatible application software, refer also to the operating instructions for the device to be connected.

About the required i.LINK cable

Use the Sony i.LINK 4-pin-to-4-pin cable (during DV dubbing).

Maintenance and precautions

On use and care

- Do not use or store the camcorder and accessories in the following locations.
 - Anywhere extremely hot or cold. Never leave them exposed to temperatures above 60 °C (140 °F), such as under direct sunlight, near heaters or in a car parked in the sun. They may malfunction or become deformed.
 - Near strong magnetic fields or mechanical vibration. The camcorder may malfunction.
 - Near strong radio waves or radiation. The camcorder may not be able to record properly.
 - Near AM receivers and video equipment. Noise may occur.
 - On a sandy beach or anywhere dusty. If sand or dust gets in your camcorder, it may malfunction. Sometimes this malfunction cannot be repaired.
 - Near windows or outdoors, where the LCD screen, the viewfinder, or the lens may be exposed to direct sunlight. This damages the inside of the viewfinder or the LCD screen.
 - Anywhere very humid.
- Operate your camcorder on DC 7.2 V (battery pack) or DC 8.4 V (AC Adaptor).
- For DC or AC operation, use the accessories recommended in these operating instructions.
- Do not let your camcorder get wet, for example, from rain or sea water. If your camcorder gets wet, it may malfunction. Sometimes this malfunction cannot be repaired.
- If any solid object or liquid gets inside the casing, unplug your camcorder and have it checked by a Sony dealer before operating it any further.
- Avoid rough handling, disassembling, modifying, physical shock, or impact such as hammering, dropping or stepping on the product. Be particularly careful of the lens.
- Keep the POWER switch setting to OFF (CHG) when you are not using your camcorder.
- Do not wrap your camcorder with a towel, for example, and operate it. Doing so might cause heat to build up inside.
- When disconnecting the mains lead, pull it by the plug and not the lead.
- Do not damage the power cord such as by placing anything heavy on it.
- Keep metal contacts clean.

- Keep the Remote Commander and button-type battery out of children's reach. If the battery is accidentally swallowed, consult a doctor immediately.
- If the battery electrolytic liquid has leaked,
 - consult your local authorized Sony service facility.
 - wash off any liquid that may have contacted your skin
 - if any liquid gets in your eyes, wash with plenty of water and consult a doctor.

■ When not using your camcorder for a long time

- Occasionally turn it on and let it run such as by playing back tapes for about 3 minutes.
- Use up the battery pack completely before storing it.

Moisture condensation

If your camcorder is brought directly from a cold place to a warm place, moisture may condense inside your camcorder, on the surface of the tape, or on the lens. In this state, the tape may stick to the head drum and be damaged or your camcorder may not operate correctly. If there is moisture inside your camcorder, [] or [] Moisture condensation. Eject the cassette,] or [] Moisture condensation. Turn off for 1H.] appears. The indicator will not appear when the moisture condenses on the lens.

■ If moisture condensation has occurred

None of the functions except cassette ejection will work. Eject the cassette, turn off your camcorder, and leave it for about one hour with the cassette lid open. Your camcorder can be used again if [] or [] does not appear when the power is turned on again.

If moisture starts to condense, your camcorder sometimes cannot detect condensation. If this happens, the cassette is sometimes not ejected for 10 seconds after the cassette lid is opened. This is not a malfunction. Do not close the cassette lid until the cassette is ejected.

■ Note on moisture condensation

Moisture may condense when you bring your camcorder from a cold place into a warm place (or vice versa) or when you use your camcorder in a humid place as shown below.

- When you bring your camcorder from a ski slope into a place warmed up by a heating device.
- When you bring your camcorder from an air conditioned car or room into a hot place outside.
- When you use your camcorder after a squall or a shower.
- When you use your camcorder in a hot and humid place.

■ How to prevent moisture condensation

When you bring your camcorder from a cold place into a warm place, put your camcorder in a plastic bag and seal it tightly. Remove the bag when the air temperature inside the plastic bag has reached the surrounding temperature (after about one hour).

Video head

- When the video head becomes dirty, you cannot record pictures normally, or distorted picture or sound is played back.
- If the following problem occurs, clean the video heads for 10 seconds with the Sony DVM-12CLD cleaning cassette (optional).
 - Mosaic-pattern noise appears on the playback picture or the screen is displayed in blue.



- Playback pictures do not move.
- Playback pictures do not appear or the sound breaks off.
- [] Dirty video head. Use a cleaning cassette.] appears on the screen during recording.
- [] Dirty video head. Use a cleaning cassette.] appears on the screen during playback.

Maintenance and precautions (continued)

- The video head suffers from wear after long use. If you cannot obtain a clear image even after using a cleaning cassette, it might be because the video head is worn. Please contact your Sony dealer or local authorized Sony service facility to have the video head replaced.

LCD screen

- Do not exert excessive pressure on the LCD screen, as it may cause damage.
- If your camcorder is used in a cold place, a residual image may appear on the LCD screen. This is not a malfunction.
- While using your camcorder, the back of the LCD screen may heat up. This is not a malfunction.

■ To clean the LCD screen

If fingerprints or dust make the LCD screen dirty, it is recommended you use a soft cloth to clean it. When you use the LCD Cleaning Kit (optional), do not apply the cleaning liquid directly to the LCD screen. Use cleaning paper moistened with the liquid.

■ On adjustment of the LCD screen (CALIBRATION)

The buttons on the touch panel may not work correctly. If this happens, follow the procedure below. It is recommended you connect your camcorder or the Handycam Station to the wall socket using the supplied AC Adaptor during the operation.

- ① Slide the POWER switch down to turn on the PLAY/EDIT lamp.
- ② Disconnect cables other than that of the AC Adaptor from your camcorder or the Handycam Station, then eject the cassette and "Memory Stick Duo" from your camcorder.
- ③ Touch **[P.MENU]** → **[MENU]** →  (STANDARD SET) → **[CALIBRATION]** → **[OK]**.

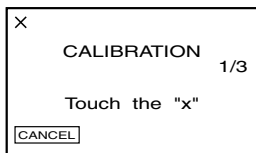

- ④ Touch the "x" displayed on the screen with the corner of the "Memory Stick Duo" or the like.
The position of the "x" changes.
Touch **[CANCEL]** to cancel.

If you did not press the right spot, start from step ④ again.

- You cannot calibrate the LCD screen if it is rotated.
- You also can calibrate the screen with the following procedure.
 - 1 Slide the POWER switch up to OFF (CHG).
 - 2 Perform step ②.
 - 3 Slide the POWER switch repeatedly to select the PLAY/EDIT mode while pressing DISP/BATT INFO on your camcorder, then press and hold DISP/BATT INFO for about 5 seconds.
 - 4 Perform step ④.

On handling the casing

- If the casing is soiled, clean the camcorder body with a soft cloth lightly moistened with water, and then wipe the casing with a dry soft cloth.
- Avoid the following to avoid damage to the finish.
 - Using chemicals such as thinner, benzine, alcohol, chemical cloths, repellent and insecticide.
 - Handling with above substances on your hands.
 - Leaving the casing in contact with rubber or vinyl objects for a long period of time.

About care and storage of the lens

- Wipe the surface of the lens clean with a soft cloth in the following instances:
 - When there are fingerprints on the lens surface.

- In hot or humid locations
- When the lens is exposed to salty air such as at the seaside.
- Store in a well-ventilated location subject to little dirt or dust.
- To prevent mold, periodically clean the lens as described above. It is recommended that you operate your camcorder about once a month to keep it in optimum state for a long time.

To charge the pre-installed rechargeable battery

Your camcorder has a pre-installed rechargeable battery to retain the date, time, and other settings even when the POWER switch is set to OFF (CHG). The pre-installed rechargeable battery is always charged while you are using your camcorder but it will get discharged gradually if you do not use your camcorder. The rechargeable battery will be fully discharged in about **3 months** if you do not use your camcorder at all. However, even if the pre-installed rechargeable battery is not charged, the camcorder operation will not be affected as long as you are not recording the date.

■ Procedures

Connect your camcorder to a wall socket using the supplied AC Adaptor or the Handycam Station, and leave it with the POWER switch set to OFF (CHG) for more than 24 hours.

To change the battery of the Remote Commander

- ① While pressing on the tab, inset your fingernail into the slit to pull out the battery case.

- ② Place a new battery with the + side facing up.
- ③ Insert the battery case back into the Remote Commander until it clicks.

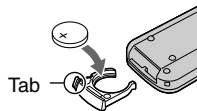

WARNING

Battery may explode if mistreated. Do not recharge, disassemble or dispose of in fire.

Caution

Danger of explosion if battery is incorrectly replaced. Replace only with the same or equivalent type recommended by the manufacturer. Discard used batteries according to the manufacturer's instructions.

- A button-type lithium battery (CR2025) is used in the Remote Commander. Do not use batteries other than the CR2025.
- When the lithium battery becomes weak, the operating distance of the Remote Commander may shorten, or the Remote Commander may not function properly. In this case, replace the battery with a Sony CR2025 lithium battery. Use of another battery may present a risk of fire or explosion.

Using the Strap Belt as a wrist strap

This is useful for carrying your camcorder.

- 1 Open the hook and loop fastener of the hand pad ① and remove it from the ring ②.

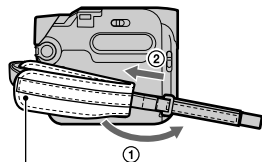

Hand pad

- 2 Move the hand pad fully to the right ①, then close the hook and loop fastener again ②.

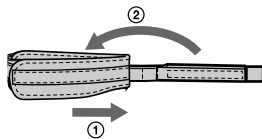

- 3 Use the Strap Belt as a wrist strap as illustrated.

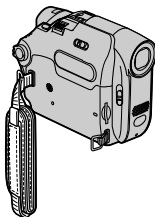

Attaching the Shoulder Strap

You can attach the Shoulder Strap to the hook for the Shoulder Strap.

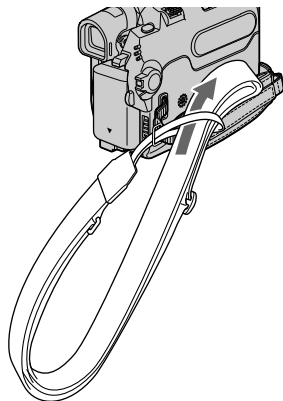

Specifications

System

Video recording system	2 rotary heads, Helical scanning system
Still image recording system	Exif Ver. 2.2*1
Audio recording system	Rotary heads, PCM system Quantization: 12 bits (Fs 32 kHz, stereo 1, stereo 2), 16 bits (Fs 48 kHz, stereo)
Video signal	PAL color, CCIR standards
Usable cassette	Mini DV cassette with the Mini DV mark printed
Tape speed	SP: Approx. 18.81 mm/s LP: Approx. 12.56 mm/s
Recording/playback time	SP: 60 min LP: 90 min (using a DVM60 cassette)
Fast forward/rewind time	Approx. 2 min 40 s (using a DVM60 cassette)
Viewfinder	Electric viewfinder DCR-HC32E/HC33E/HC39E: black and white DCR-HC42E/HC43E: color
Image device	DCR-HC32E/HC33E: 3 mm (1/6 type) CCD (Charge Coupled Device) Gross: Approx. 800 000 pixels Effective (still): Approx. 400 000 pixels Effective (movie): Approx. 400 000 pixels DCR-HC39E/HC42E/HC43E: 3.27 mm (1/5.5 type) CCD (Charge Coupled Device) Gross: Approx. 1 070 000 pixels Effective (still): Approx. 1 000 000 pixels Effective (movie): Approx. 690 000 pixels
Lens	Carl Zeiss Vario-Tessar Combined power zoom lens Filter diameter: 25 mm (1 in.) DCR-HC32E/HC33E: 20 × (Optical), 800 × (Digital) F=1.8 - 3.1 DCR-HC39E/HC42E/HC43E: 12 × (Optical), 480 × (Digital) F=1.8 - 2.5

Focal length	DCR-HC32E/HC33E: f=2.3 - 46 mm (3/32 - 1 13/16 in.) When converted to a 35 mm still camera In CAMERA-TAPE: 44 ~ 880 mm (1 3/4 - 34 1/32 in.) In CAMERA-MEMORY: 44 ~ 880 mm (1 3/4 - 34 1/32 in.) DCR-HC39E/HC42E/HC43E: f=3.0 - 36 mm (1/8 - 1 7/16 in.) When converted to a 35 mm still camera: In CAMERA-TAPE: 16:9 mode*2: 46 ~ 628.5 mm (1 13/16 - 24 3/4 in.) 4:3 mode: 40 ~ 480 mm (1 5/8 - 19 in.) In CAMERA-MEMORY: 4:3 mode: 48 ~ 576 mm (1 15/16 - 22 3/4 in.) 16:9 mode: 43.6 ~ 523.2 mm (1 3/4 - 20 5/8 in.)
Color temperature	[AUTO], [ONE PUSH], [INDOOR] (3 200 K), [OUTDOOR] (5 800 K)
Minimum illumination	DCR-HC32E/HC33E: 5 lx (lux) (F 1.8) 0 lx (lux) (during NightShot plus function)*3 DCR-HC39E/HC42E/HC43E: 7 lx (lux) (F 1.8) 0 lx (lux) (during NightShot plus function)*3

*1“Exif” is a file format for still images, established by the JEITA (Japan Electronics and Information Technology Industries Association). Files in this format can have additional information such as your camcorder’s setting information at the time of recording.

*2In 16:9 mode, the focal length figures are actual figures resulting from wide angle pixel read-out.

*3 Objects unable to be seen due to the dark can be shot with infrared lighting.

Specifications (continued)

Input/Output connectors

DCR-HC32E/HC33E/HC42E/HC43E:	
Audio/Video input/output	10-pin connector Input/output auto switch Video signal: 1 Vp-p, 75 Ω (ohms), unbalanced Luminance signal: 1 Vp-p, 75 Ω (ohms), unbalanced Chrominance signal: 0.3 Vp-p, 75 Ω (ohms), unbalanced Audio signal: 327 mV (at output impedance more than 47 k Ω (kilohms)), Input impedance more than 47 k Ω (kilohms), Output impedance with less than 2.2 k Ω (kilohms)
LANC jack	Stereo mini-minijack (\varnothing 2.5 mm)
DCR-HC39E:	
Audio/Video output	10-pin connector Video signal: 1 Vp-p, 75 Ω (ohms), unbalanced Luminance signal: 1 Vp-p, 75 Ω (ohms), unbalanced Chrominance signal: 0.3 Vp-p, 75 Ω (ohms), unbalanced Audio signal: 327 mV (at output impedance more than 47 k Ω (kilohms)), Output impedance with less than 2.2 k Ω (kilohms)
LANC jack	Stereo mini-minijack (\varnothing 2.5 mm)

LCD screen

Picture	DCR-HC32E/HC33E: 6.2 cm (2.5 type)
	DCR-HC39E/HC42E/HC43E: 6.9 cm (2.7 type, aspect ratio 16:9)
Total dot number	123 200 (560 \times 220)

General

Power requirements	DC 7.2 V (battery pack) DC 8.4 V (AC Adaptor)
Average power consumption	DCR-HC32E/HC33E: During camera recording using the viewfinder 2.1 W During camera recording using the LCD 2.5 W DCR-HC39E/HC42E/HC43E: During camera recording using the viewfinder 2.5 W During camera recording using the LCD 2.9 W During camera recording using the viewfinder and the LCD 3.1 W
Operating temperature	0 $^{\circ}$ C to 40 $^{\circ}$ C (32 $^{\circ}$ F to 104 $^{\circ}$ F)
Storage temperature	-20 $^{\circ}$ C to +60 $^{\circ}$ C (-4 $^{\circ}$ F to +140 $^{\circ}$ F)
Dimensions (approx.)	54.7 \times 90 \times 111.7 mm (2 1/4 \times 3 5/8 \times 4 1/2 in.) (w/h/d)
Mass (approx.)	DCR-HC32E/HC33E: 400 g (14 oz) main unit only 460 g (1 lb) including the NP-FP30 rechargeable battery pack and DVM60 cassette. DCR-HC39E/HC42E/HC43E: 410 g (14 oz) main unit only 470 g (1 lb) including the NP-FP50 rechargeable battery pack and DVM60 cassette.
Supplied accessories	See page 7.

Handycam Station

DCRA-C121 (DCR-HC32E/HC33E/HC42E/HC43E)

Audio/Video input/output	10-pin connector Input/output auto switch Video signal: 1 Vp-p, 75 Ω (ohms), unbalanced Luminance signal: 1 Vp-p, 75 Ω (ohms), unbalanced Chrominance signal: 0.3 Vp-p, 75 Ω (ohms), unbalanced Audio signal: 327 mV (at output impedance more than 47 kΩ (kilohms)), Input impedance more than 47 kΩ (kilohms), Output impedance with less than 2.2 kΩ (kilohms)
USB jack	mini-B
DV input/output	4-pin connector

DCRA-C123 (DCR-HC39E)

Audio/Video output	10-pin connector Video signal: 1 Vp-p, 75 Ω (ohms), unbalanced Luminance signal: 1 Vp-p, 75 Ω (ohms), unbalanced Chrominance signal: 0.3 Vp-p, 75 Ω (ohms), unbalanced Audio signal: 327 mV (at output impedance more than 47 kΩ (kilohms)), Output impedance with less than 2.2 kΩ (kilohms)
USB jack	mini-B
DV output	4-pin connector

AC Adaptor AC-L25A/L25B

Power requirements	AC 100 - 240 V, 50/60 Hz
Current consumption	0.35 - 0.18 A
Power consumption	18 W
Output voltage	DC 8.4 V*
Operating temperature	0 °C to 40 °C (32 °F to 104 °F)
Storage temperature	-20 °C to + 60 °C (-4 °F to + 140 °F)

Dimensions 56 × 31 × 100 mm (2 1/4 × 1 1/4 × 4 in.) (w/h/d) excluding the projecting parts

Mass (approx.) 190 g (6.7 oz) excluding the mains lead

* See the label on the AC Adaptor for other specifications.

Rechargeable battery pack

NP-FP30 (DCR-HC32E/HC33E)

Maximum output voltage	DC 8.4 V
Output voltage	DC 7.2 V
Capacity	3.6 wh (500 mAh)
Dimensions (approx.)	31.8 × 18.5 × 45.0 mm (1 5/16 × 3/4 × 1 13/16 in.) (w/h/d)
Mass (approx.)	40 g (1.5 oz)
Operating temperature	0 °C to 40 °C (32 °F to 104 °F)
Type	Lithium ion

NP-FP50 (DCR-HC39E/HC42E/HC43E)

Maximum output voltage	DC 8.4 V
Output voltage	DC 7.2 V
Capacity	4.9 wh (680 mAh)
Dimensions (approx.)	31.8 × 18.5 × 45.0 mm (1 5/16 × 3/4 × 1 13/16 in.) (w/h/d)
Mass (approx.)	40 g (1.5 oz)
Operating temperature	0 °C to 40 °C (32 °F to 104 °F)
Type	Lithium ion

Design and specifications are subject to change without notice.

Types of differences

DCR-HC	32E/33E/42E/43E	39E
A/V jack	IN/OUT	OUT
DV Interface	IN/OUT	OUT

Index

A

A/V connecting cable 32, 57, 61, 78
A/V DV OUT 52
A/V jack 32, 57, 61, 78
Access lamp 16
Active Interface Shoe 67
AC Adaptor 7
Adjusting exposure for back light 86
ALL ERASE 45
Aspect ratio 17
AUDIO MIX 51, 63
AUDIO MODE 51
AUD DUB CTRL (Audio dubbing) 50
AUTO SHUTTER 39
A.SHUT OFF (Auto shut off) 54

B

BACK LIGHT 23, 86
Battery
 Battery pack 7
 BATT INFO (Battery info) 24
 Remaining battery 24
BEACH&SKI 38
BEEP 54
BLACK FADER 46
BURN DVD 50
BURN VCD 50
BURST 43
Button-type lithium battery 111
B&W 48

C

Calibration 110
CAMERA DATA 53
CAMERA SET menu 38

Cassette 16, 103
 Insert/Eject 16
CD-ROM 68
Charging the battery 8
 Battery pack 8
 Pre-installed rechargeable battery 111
Charging time 10
CHG (charge) lamp 9
Click to DVD 75
CLOCK SET 15, 54
COLOR SLOW S (Color Slow Shutter) 41, 90
Compression format 104
Computer 70
Connect
 Computer 68
 TV 32, 57
 VCR 32, 57
Copyright 74

D

DATA CODE 53
Date search 31
DATE/TIME 53
DC IN jack 8
DC plug 8
Delete picture 63
DEMO MODE 49, 80
DIGITAL ZOOM 42, 86
Direct Access to "Click to DVD" See Click to DVD
Display guide 14
Display indicators 26
DISP/BATT INFO button 24
DISP OUTPUT 54
DOT FADER 46
Double speed Playback 50
Dubbing 58
DV Interface 57, 75

D. EFFECT (Digital effect) 47, 90

E

EASY button 18
Easy Handycam 18
EDIT SEARCH 29
END SEARCH 29, 50
END SEARCH/EDIT SEARCH/Rec review display switch button 26
ERASE
 ALL ERASE 45
 Pictures 63
EXPOSURE 39, 89
EXP. BRKTG (Exposure bracketing) 43
EXT SUR MIC (External surround microphone) 51
EDIT/PLAY menu 50

F

FADER 46, 90
FILE NO. (File number) 45
FINE 43
First Step Guide 68, 74
Fixing the exposure 23
FLASH LEVEL 41
FLASH MODE 40
FLASH (Flash motion) 47
FLASH SET 40
FOCUS 40, 86
Folder
 NEW FOLDER 45
 PB FOLDER (Playback folder) 45
 REC FOLDER (Recording folder) 45
FORMAT 45, 104
Frame-by-frame playback 50
Full charge 9

- G**
- Getting started 7, 70, 74
- H**
- Handycam Station 7
 - Hand pad 112
 - Help 69
 - Holding the camcorder 12
- I**
- Icon See Display indicators
 - Image delete button 27
 - Image protection 64
 - Image quality (QUALITY) 43
 - Image size (IMAGE SIZE) 43
 - Movie 44
 - Still image 43
 - Index screen 21
 - Index screen display button 27
 - INDOOR 39
 - “InfoLITHIUM” battery pack 106
 - Infrared port 22
 - Initialize (Reset) 24
 - Install 70
 - Insulation sheet 30
 - Interface connector 67
 - Internal microphone 24
 - INT.REC-STL (Interval photo recording) 49
 - i.LINK 107
 - i.LINK cable 57, 75, 78
- J**
- Jack 67
 - JPEG 104
- L**
- Label 103
 - LANC jack 67
 - LANDSCAPE 38
 - LANGUAGE 54
 - LCD/VF SET 51
 - LCD backlight 82
 - LCD BL LEVEL (LCD back light) 52
 - LCD BRIGHT 51
 - LCD COLOR 52
 - LCD panel 13
 - LCD BL LEVEL 52
 - LCD BRIGHT 51
 - LCD COLOR 52
 - LCD screen 13
 - LENS COVER switch 12
 - Lid 16
 - LP (Long Play) 51
 - LUMI. KEY (Luminance key) 47
- M**
- Macintosh 70, 73
 - Mains lead 7
 - Maintenance 108
 - Main sound 51
 - MEMORY SET menu 43
 - “Memory Stick” 104
 - “Memory Stick Duo” 16
 - FORMAT 45
 - Insert/Eject 16
 - Number of recordable pictures 43
 - Recordable time 44
 - Write-protect tab 104
 - Memory Stick Duo adaptor 105
 - “Memory Stick Duo” slot ... 16
 - Menu 34
 - CAMERA SET menu ... 38
 - EDIT/PLAY menu 50
 - MEMORY SET menu 43
 - Menu items 36
 - Personal Menu 55
 - PICT.APPLI. menu 46
 - STANDARD SET menu 51
 - TIME/LANGU. menu 54
 - Using the menu 34
 - MENU ROTATE 54
 - Mirror mode 23
 - Moisture condensation 109
 - MONOTONE 46
 - MOSAIC 48
 - MOSAIC FADER 46
 - Movie
 - Movie format 104
 - REC MODE (Recording mode) 51
 - MOVIE SET 44
 - MPEG 104
 - MPEG MOVIE EX 20
 - MULTI-SOUND 51
- N**
- NEG.ART 48
 - NEW FOLDER 45
 - NightShot plus 22
 - NIGHTSHOT PLUS switch 22
 - NORMAL 43
 - NS LIGHT (NightShot Light) 41
 - NTSC 102
 - Number of recordable pictures 43

O

OLD MOVIE	48, 90
ONE PUSH	39
OPEN/EJECT lever.....	16
Operation confirmation beep	See BEEP
OUTDOOR	39
OVERLAP	46

P

PAL	88, 102
PASTEL	48
PB FOLDER (Playback folder)	45
PB zoom.....	23
Personal Menu	34, 55
Add	55
Arrange the order.....	56
Customize	55
Delete.....	55
Reset	56
Personal Menu button	26
PHOTO button	20, 30
PictBridge	65
Picture Package	70
Picture Search	21
PICT.APPLI. menu (Picture Application menu)	46
PICT. EFFECT (Picture effect)	48
Pixela user support center	74
Playback.....	21
Double speed	50
Frame	50
Reverse	50
Slow	50
Playing time	10
PORTRAIT (Soft portrait) ...	38
POWER switch	12
Previous/Next image button	27

Print.....	65
Print mark.....	64
PROGRAM AE.....	38, 89
P.MENU	See Personal Menu

R

Rechargeable battery pack	See Battery
Recording.....	20
Recording capacity.....	26
Cassette.....	26
Memory Stick	26
Recording time.....	10, 44
REC CTRL (Recording control).....	59
REC FOLDER (Recording folder).....	45
REC LAMP.....	53
REC lamp (Recording lamp)	24
REC MODE (Recording mode)	51
Rec review.....	29
REC START/STOP	20
REMAINING.....	53
Remaining battery	26
Remote Commander	30
REMOTE CTRL (Remote control).....	53
Remote sensor.....	24
RESET button	24
Reversal Playback.....	50
Review button	26

S

Searching for the starting point	29
Self-diagnosis display	97
SELF-TIMER	41
SEPIA	48
Setting the date and time.....	15
Shoulder Strap.....	112

Signal convert function	78
Skip Scan	21
SLIDE SHOW.....	47
Slow Playback.....	50
SLOW SHUTTR (Slow shutter)	47
SMTH INT.REC (Smooth interval tape recording)	48
Software	70
SOLARIZE	48
SP (Standard Play).....	51
Speaker.....	24
Specifications	113
SPORTS (Sports lesson)	38
SPOTLIGHT	38
SPOT FOCUS.....	40, 89
SPOT METER (Flexible spot meter)	38, 89
STANDARD	43
STANDARD SET menu	51
STD-USB.....	53
STEADYSHOT.....	42, 86
STILL.....	47
Still image	
Image size	43
Quality	43
Still image format	104
STILL SET.....	43
Strap Belt	112
Sub sound.....	51
SUNSET&MOON	38
SUPER NSPLUS (Super Nightshot plus).....	41, 90
System requirement	69
S VIDEO cable.....	32, 57
S VIDEO jack	32, 57

T

Tape	See Cassette
Tape counter	26
Tape playback select button	27
Telephoto	22
TELE MACRO	40
TIME/LANGU. menu	54
Time code	26
Touch panel	14
Trademark	123
TRAIL	47
Transmitter	30
Tripod	23
TV	32, 57
TV color systems	102
TV TYPE	32

U

USB-CAMERA	52
USB jack	67
USB ON/OFF switch	67
USB-PLY/EDT (USB-Play/ Edit)	53
USB Streaming	52
Using abroad	102

V

VAR.SPD PB (Various speed playback)	50
VF B.LIGHT (Viewfinder brightness)	52
VF WIDE DISP (Viewfinder wide display)	52
Video head	109
VIDEO INPUT	52
Video operation buttons	27
Viewfinder	13
Brightness	52
Viewfinder lens adjustment lever	13
Volume	21

W

Wall socket	8
Warning indicators	97
Warning messages	97
WHITE BAL. (White balance)	39, 89
WHITE FADER	46
Wide angle	22
WIDE DISP (wide display)	52
WIDE SELECT	17, 42
Windows	69, 70
WIPE	46
WORLD TIME	54
Wrist strap	112
Write-protect tab	103, 104

Z

Zero set memory	30
ZERO SET MEMORY button	30
Zoom	22
Zoom lever	22

On trademarks

- “Memory Stick,”  “MEMORY STICK PRO Duo,” “MEMORY STICK PRO DUO,” “Memory Stick PRO Duo,” “MAGICGATE,” “MAGICGATE,” “MagicGate Memory Stick” and “MagicGate Memory Stick Duo” are trademarks or registered trademarks of Sony Corporation.
- “InfoLITHIUM” is a trademark of Sony Corporation.
- i.LINK and  are trademarks of Sony Corporation.
- Picture Package is a trademark of Sony Corporation.
- Mini  is a trademark.
- Microsoft, Windows, and Windows Media are trademarks or registered trademarks of U.S. Microsoft Corporation in the U.S. and other countries.
- iMac, iBook, Macintosh, Mac OS, PowerBook and PowerMac are trademarks of Apple Computer, Inc., registered in the U.S. and other countries.
- eMac is trademark of Apple Computer, Inc.

- QuickTime and the QuickTime logo are trademarks of Apple Computer, Inc.
- Roxio is a registered trademark of Roxio, Inc.
- Toast is a trademark of Roxio, Inc.
- Windows Media Player is a trademark of Microsoft Corporation.
- Macromedia and Macromedia Flash Player are trademarks or registered trademarks of Macromedia, Inc. in the United States and/or other countries.
- Pentium is a trademark or registered trademark of Intel Corporation.

All other product names mentioned herein may be the trademarks or registered trademarks of their respective companies. Furthermore, TM and [®] are not mentioned in each case in this manual.