

SONY®

2-661-364-11(2)

Digital Video Camera Recorder

HANDYCAM® Operating Guide

DCR-DVD404E/DVD405E/DVD805E

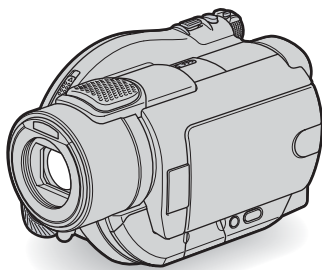

 Enjoying with your
DVD Handycam 12

Getting Started 18

 Easy
Handycam 31

 Recording
/Playback 38

Playback on DVD devices 52

Using the Recorded disc 59

Using the Setup items 62

Editing on DVD Handycam 82

Dubbing, Printing 90

Using a Computer 97

Troubleshooting 103

Additional Information 126

Glossary, Index 139



Read this first

Before operating the unit, please read this manual thoroughly, and retain it for future reference.

WARNING

To reduce fire or shock hazard, do not expose the unit to rain or moisture.

CAUTION



The use of optical instruments with this product will increase eye hazard. Use of controls or adjustments or performance of procedures other than those specified herein may result in hazardous radiation exposure.

Replace the battery with the specified type only. Otherwise, fire or injury may result.

FOR CUSTOMERS IN THE UNITED KINGDOM

NOTICE ON THE SUPPLIED AC ADAPTOR

A moulded plug complying with BS1363 is fitted to this equipment for your safety and convenience.

Should the fuse in the plug supplied need to be replaced, a fuse of the same rating as the supplied one and approved by ASTA or BSI to BS1362 (i.e., marked with  or  mark) must be used. If the plug supplied with this equipment has a detachable fuse cover, be sure to attach the fuse cover after you change the fuse. Never use the plug without the fuse cover.

If you should lose the fuse cover, please contact your nearest Sony service station.

For the customers in Europe

CLASS 1 LASER PRODUCT
LASER KLASSE 1
LUOKAN 1 LASERLAITE
KLASS 1 LASERAPPARAT

ATTENTION

The electromagnetic fields at the specific frequencies may influence the picture and sound of this camcorder.

This product has been tested and found compliant with the limits set out in the EMC Directive for using connection cables shorter than 3 meters. (9.8 feet)

Notice

If static electricity or electromagnetism causes data transfer to discontinue midway (fail), restart the application or disconnect and connect the communication cable (USB, etc.) again.



Disposal of Old Electrical & Electronic Equipment (Applicable in the European Union and other European countries with separate collection systems)

This symbol on the product or on its packaging indicates that this product shall not be treated as household waste. Instead it shall be handed over to the applicable collection point for the recycling of electrical and electronic equipment.

By ensuring this product is disposed of correctly, you will help prevent potential negative consequences for the environment and human health, which could otherwise be caused by inappropriate waste handling of this product. The recycling of materials will help to conserve natural resources.

For more detailed information about recycling of this product, please contact your local Civic Office, your household waste disposal service or the shop where you purchased the product.

Applicable Accessories: Remote Commander

For customers in the U.S.A.

If you have any questions about this product, you may call:

Sony Customer Information Center
1-800-222-SONY (7669).

The number below is for the FCC related matters only.

Regulatory Information

Declaration of Conformity

Trade Name: SONY

Model No.: DCR-DVD805E

Responsible Party: Sony Electronics Inc.

Address: 16450 W. Bernardo Dr, San Diego, CA 92127 U.S.A.

Telephone No.: 858-942-2230

This device complies with Part 15 of the FCC Rules.

Operation is subject to the following two conditions:

(1) This device may not cause harmful interference, and (2) this device must accept any interference received, including interference that may cause undesired operation.

CAUTION

You are cautioned that any changes or modifications not expressly approved in this manual could void your authority to operate this equipment.

Note

This equipment has been tested and found to comply with the limits for a Class B digital device, pursuant to Part 15 of the FCC Rules.

These limits are designed to provide reasonable protection against harmful interference in a residential installation.

This equipment generates, uses, and can radiate radio frequency energy and, if not installed and used in accordance with the instructions, may cause harmful interference

to radio communications. However, there is no guarantee that interference will not occur in a particular installation. If this equipment does cause harmful interference to radio or television reception, which can be determined by turning the equipment off and on, the user is encouraged to try to correct the interference by one or more of the following measures:

- Reorient or relocate the receiving antenna.
- Increase the separation between the equipment and receiver.
- Connect the equipment into an outlet on a circuit different from that to which the receiver is connected.
- Consult the dealer or an experienced radio/TV technician for help.

The supplied interface cable must be used with the equipment in order to comply with the limits for a digital device pursuant to Subpart B of Part 15 of FCC Rules.

“Battery pack”

THIS DEVICE COMPLIES WITH PART 15 OF THE FCC RULES. OPERATION IS SUBJECT TO THE FOLLOWING TWO CONDITIONS: (1) THIS DEVICE MAY NOT CAUSE HARMFUL INTERFERENCE, AND (2) THIS DEVICE MUST ACCEPT ANY INTERFERENCE RECEIVED, INCLUDING INTERFERENCE THAT MAY CAUSE UNDESIRE OPERATION.

Notes on use

Your camcorder is supplied with two kinds of operations guides.

- "Operating Guide" (This manual)
- "First Step Guide" for using your camcorder with the computer connected (stored on the supplied CD-ROM)*

* The DCR-DVD404E does not include "First Step Guide" because it does not support a computer connection.

On the discs you can use in your camcorder

You can use 8cm DVD-Rs, 8cm DVD-RWs and 8cm DVD+RWs only. Use the discs with marks listed below. See page 14 for details.



On the types of "Memory Stick" you can use in your camcorder

There are two sizes of "Memory Stick." You can use "Memory Stick Duo" marked with MEMORY STICK DUO or MEMORY STICK PRO DUO (p.129).

"Memory Stick Duo" (This size can be used with your camcorder)



"Memory Stick" (You cannot use it in your camcorder.)



- You cannot use any type of memory card except "Memory Stick Duo."
- "Memory Stick PRO" and "Memory Stick PRO Duo" can be used only with "Memory Stick PRO" compatible equipment.

When using a "Memory Stick Duo" with "Memory Stick" compatible equipment

Be sure to insert the "Memory Stick Duo" into the Memory Stick Duo Adaptor.

Memory Stick Duo Adaptor



On using the camcorder

- Do not hold the camcorder by the following parts.

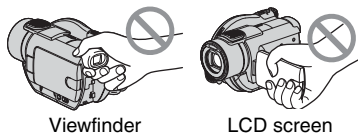

Viewfinder

LCD screen

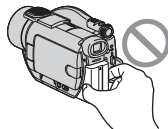

Battery

- The camcorder is not dustproofed, dripproofed or waterproofed. See "Maintenance and precautions" (p.133).
- To prevent discs from being broken or recorded pictures from being lost, do not do the following when either of the respective lamps of the POWER switch (p.22) or the ACCESS lamp (p.26) is on:
 - to remove the battery pack or AC Adaptor from the camcorder.
 - to apply mechanical shock or vibration to the camcorder.
- Before connecting your camcorder to another device with a USB cable etc., be sure to insert the connector plug in the proper direction. If you insert the connector plug forcibly in the wrong direction, the terminal may be damaged, or this may cause a malfunction of your camcorder.

Notes on the Setup items, LCD screen, viewfinder, and lens

- A setup item that is grayed out is not available under the current recording or playback conditions.
- The LCD screen and the viewfinder are manufactured using extremely high-precision technology, so over 99.99% of the pixels are operational for effective use. However, there may be some tiny black points and/or bright points (white, red, blue, or green in color) that appear constantly on the LCD screen and the viewfinder. These points are normal.

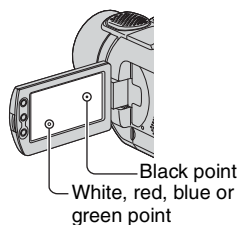

- Exposing the LCD screen, the viewfinder, or the lens to direct sunlight for long periods of time may cause malfunctions. Be careful when placing the camera near a window or outdoors.
- Do not aim at the sun. Doing so might cause your camcorder to malfunction. Take pictures of the sun only in low light conditions, such as at dusk.

On recording

- Before starting to record, test the recording function to make sure the picture and sound are recorded without any problems. You cannot delete images once you record them on a DVD-R. Use a DVD-RW/DVD+RW for trial recording (p.14).
- Compensation for the contents of recordings cannot be provided, even if recording or playback is not possible due to a malfunction of the camcorder, storage media, etc.
- TV color systems differ depending on the countries/regions. To view your recordings on a TV, you need a PAL system-based TV.
- Television programs, films, video tapes, and other materials may be copyrighted. Unauthorized recording of such materials may be contrary to the copyright laws. You cannot dub copyright protected software on your camcorder.

On this manual

- The images of the LCD screen and the viewfinder used on this manual are captured using a digital still camera, and thus may appear different from what you see.
- Design and specifications of recording media and accessories are subject to change without notice.
- The illustrations used on this manual are based on the model DCR-DVD405E.
- Disc in this Operating Guide refers to 8cm DVD discs.
- Available operations depend on the disc used. The following marks are used for the different DVD formats.



- The on-screen displays in each local language are used for illustrating the operating procedures. Change the screen language before using your camcorder if necessary (p.79).

Read this first (continued)

About the Carl Zeiss lens

Your camcorder is equipped with a Carl Zeiss lens, which was developed jointly by Carl Zeiss, in Germany, and Sony Corporation, and produces superior images.

It adopts the MTF* measurement system for video cameras and offers a quality typical of a Carl Zeiss lens.

Also, the lens for your camcorder is T*-coated to suppress unwanted reflections and faithfully reproduce colors.

* MTF stands for Modulation Transfer Function. The number value indicates the amount of light from a subject coming into the lens.

Table of Contents



Enjoying with your DVD Handycam

What you can do with your DVD Handycam.....	12
Choosing a disc	14
Using your DVD Handycam.....	16

Getting Started

Step 1: Checking supplied items.....	18
Step 2: Charging the battery pack	19
Step 3: Turning the power on, and holding your camcorder	22
Step 4: Adjusting the LCD screen and viewfinder.....	23
Step 5: Using the touch panel.....	24
Step 6: Setting the date and time.....	25
Step 7: Inserting a disc or a "Memory Stick Duo"	26
Step 8: Selecting the aspect ratio (16:9 or 4:3) of the recording picture	29



Easy Handycam - using your camcorder with automatic settings

Using Easy Handycam operation.....	31
Recording with ease	32
Playing back with ease	34
Preparation for playing back on a DVD player (Finalizing)	36



Recording/Playback

Recording.....	38
Playback	40
Functions used for recording/playback, etc.	42

Recording

- To use zoom
- To record sound with more presence (5.1ch surround recording)
- To use the flash
- To record in dark places (NightShot)
- To adjust the exposure for backlit subjects (BACK LIGHT)

- To adjust the focus for an off center subject
- To fix the exposure for the selected subject
- To record in mirror mode
- To add special effects
- To use a tripod
- To attach the shoulder belt

Playback

- To use Playback zoom
- To play back a series of still images (Slide show)

Recording/playback

- To check the remaining battery
- To turn off the operation confirmation beep
- To initialize the settings (RESET)
- Other part names and functions

Checking/Deleting the last scene (Review/Review deleting)	46
Indicators displayed during recording/playback	47
Remote Commander	49
Playing the picture on a TV	50

Playback on DVD devices

Making the disc compatible with playback on DVD devices or DVD drives (Finalizing).....	52
Playing back a disc on DVD devices, etc.	56
Playing back a disc on a computer with a DVD drive installed.....	57

Using the Recorded disc (DVD-RW/DVD+RW)

Recording additional scenes after finalizing	59
Deleting all of the scenes on the disc (Formatting)	60

Using the Setup items







Using the Setup items	62
Setup items	64
 CAMERA SET	66
Settings to adjust your camcorder to the recording conditions (EXPOSURE/WHITE BAL./STEADYSHOT, etc.)	
 STILL SET	70
Settings for still images (BURST/QUALITY/IMAGE SIZE, etc.)	

Table of Contents (continued)

 PICT.APPLI.....	72
Special effects on pictures or additional functions on recording/playback (PICT.EFFECT/D.EFFECT, etc.)	
 MEDIA SET.....	74
Settings for discs and "Memory Stick Duo" (FORMAT/FINALIZE/UNFINALIZE, etc.)	
 STANDARD SET.....	75
Settings while recording on a disc or other basic settings (REC MODE/LCD/VF SET/USB SPEED, etc.)	
 TIME/LANGU.....	79
(CLOCK SET/AREA SET/LANGUAGE, etc.)	
Customizing Personal Menu.....	80

Editing on DVD Handycam

Copying the still images.....	82
Deleting still images from the "Memory Stick Duo".....	84
Editing the original data.....	85
Creating the Playlist.....	86
Playing the Playlist.....	89

Dubbing, Printing

Dubbing to VCR/DVD devices.....	90
Recording images from a TV or VCR/DVD device (DCR-DVD405E/DVD805E).....	92
Printing recorded still images (PictBridge compliant printer) (DCR-DVD405E/DVD805E).....	94
Jacks to connect external devices.....	96

Using a Computer (DCR-DVD405E/DVD805E)

Before referring to the "First Step Guide" on your computer.....	97
Installing software and "First Step Guide".....	99
Viewing "First Step Guide".....	102

Troubleshooting

Troubleshooting.....	103
Warning indicators and messages	121

Additional Information

Using your camcorder abroad	126
About the disc.....	128
About the “Memory Stick”	129
About the “InfoLITHIUM” battery pack.....	131
Maintenance and precautions	133
Specifications	137

Glossary, Index

Glossary	139
Index.....	141



What you can do with your DVD Handycam

Your DVD Handycam records image data on 8cm DVD*. It is more convenient than video tape and far more versatile.

Taking beautiful shots easily

No rewinding to start recording (p.32, 38)

Recorded images are stored in empty areas on the disc so there is no risk that valuable recordings are accidentally overwritten.

Since no rewinding is necessary prior to recording, you can start shooting any time you desire.

A disc can store both movie and still images.

- Still images can be recorded on the disc or “Memory Stick Duo.”

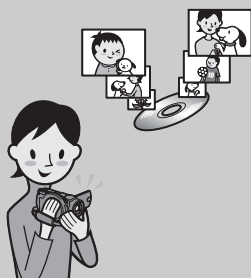

You can find a scene quickly using a VISUAL INDEX screen. (p.34, 40)

The VISUAL INDEX screen allows you to check disc content at a glance. All you have to do is touch the scene you want to view.

The disc does not wear out no matter how many times you play it back. The precious moments you have captured on disc last forever.

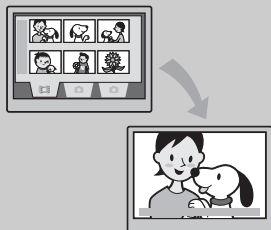

Records widescreen format and 5.1ch surround sound (p.29, 42)

You can record high quality widescreen images on a wide LCD screen that shows the same 16:9 angle of view as a wide TV. Realistic 5.1ch surround sound can also be directly recorded onto the disc.



* DVD (Digital Versatile Disc) is a high-capacity optical disc.

A recorded disc can be played back on a variety of devices

Playback on a DVD device or DVD drive (p.36, 52)

You can play back recorded and finalized** discs on a home DVD device, DVD recorder or DVD drive of a computer that supports 8cm disc.

When finalizing the disc, you can create still image slide shows and DVD menus to enable quick access to scenes you want to view.



Playback on widescreen TV and home theater (p.42, 50)

Images recorded in widescreen format can be played back on a wide TV with complete panoramic effect. Discs are also recorded with 5.1ch surround sound to provide full sound on a home theater.



Connecting DVD Handycam to a computer

- Some models may not support a computer connection.

High-speed image transfer (p.97)

Image data can be quickly transferred to a computer without requiring playback. Computers with Hi-Speed USB (USB 2.0) provide even faster image transfer.

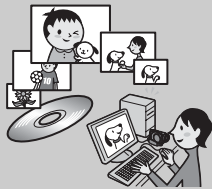

Using the supplied software to edit and copy (p.97)

Picture Package, the software supplied with your DVD Handycam allows you to add music and effects to create your original DVD. Copying discs could not be easier enabling you to share your precious moments with family and friends.

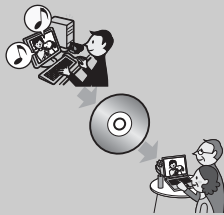



** Finalizing: a process to make it possible to play back recorded DVD on other DVD devices (see page 36 and 52).

Choosing a disc

Your DVD Handycam is compatible with 8cm DVD-R, DVD-RW and DVD+RW. It does not support 12cm discs.

Recording format for DVD-RW









When you use a DVD-RW, you can choose the recording format from VIDEO mode or VR mode. In this manual, VIDEO mode is indicated as  and VR mode as .

	A recording format that is compatible with most DVD devices, especially after finalizing. In VIDEO mode, only the most recent image can be erased.
	A recording format that enables editing with your DVD Handycam (deleting and rearranging the order of images). A finalized disc can be played back in DVD devices that support VR mode*1.

Disc and recording formats  Glossary (p.139, 140)

Disc format features

Figures in parentheses () indicate page numbers.

Disc types and symbols	DVD-R	DVD-RW		DVD+RW
				
Symbols used in this manual				
				
Both 16:9 (wide) and 4:3 movie can be recorded on the same disc*2 (29)	●	●	●	—
Deleting the last recording immediately (46)	—	●	●	●
Deleting recordings freely (85)	—	—	●	—
Editing recordings on your camcorder (85)	—	—	●	—
Using a disc repeatedly even if the disc becomes full by formatting*3 (60)	—	●	●	●
Playing back recordings on other DVD devices if you finalize the disc (36, 52)	●	●	●*1	●
Playing back recordings on other DVD devices even if you do not finalize the disc (52)	—	—	—	●*4
Creating the DVD menu when you finalize the disc (55)	●	●	—	●

*1 Refer to the instruction manual of your DVD device to see whether it supports the VR mode of DVD-RW.

*2 For still images, you can record them on the all types of discs.

*3 Formatting deletes all recordings and returns the recording medium to its original empty state. (p.60) Even when using a new disc, format it with your DVD Handycam (p.26).

*4 Do not use a DVD+RW before finalizing in a computer as this may result in a malfunction.

Recording time

Recording time per disc side

The minimum recording time is given in parentheses.

unit: min.

Recording mode	Recording time
HQ (High Quality)	approx. 20 (18)
SP (Standard Play)	approx. 30 (18)
LP (Long Play)	approx. 60 (44)

Your DVD Handycam uses the VBR (Variable Bit Rate) format to automatically adjust image quality to suit the recording scene. This technology causes fluctuations in the recording time of a disc. Movie containing quickly moving and complex images is recorded at a higher bit rate and this reduces the overall recording time.
VBR  Glossary (p.140)

- The recording time for the movie drops when the disc also contains still images.

Disc use

For reliability durability of recording /playback, we recommend that you use Sony discs or discs with an  (for VIDEO CAMERA) * (for VIDEO CAMERA) mark for your DVD Handycam.

- Using a disc other than above may cause the unsatisfactory recording/playback or you may not be able to remove the disc from your DVD Handycam.

* Depending on the place you bought, the disc has a  (for VIDEO CAMERA) pour CAMESCOPE™ mark.

Use of double-sided discs

Double-sided discs allow you to record both sides of a disc.

Recording on the A side

Place the disc in your DVD Handycam with the side with the **A** symbol at the center facing outwards until it clicks.

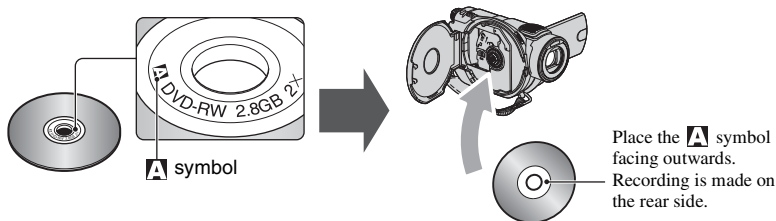

- When using a double-sided disc, take care not to smudge the surface with fingerprints.
- When a double-sided disc is used in your DVD Handycam, recording/playback are performed on that side only. You cannot switch to record on or play back the other side with the disc set to the DVD Handycam. When recording/playback of one side is complete, remove the disc and turn it over to access the other side.
- The following operations are performed for each side of a double-sided disc.
 - Finalizing (p.52)
 - Unfinalizing (DVD-RW: VIDEO mode) (p.59)
 - Formatting (p.60)

Using your DVD Handycam

① Preparing

(See page 18 to 29.)

Select the disc that best suits your needs.



Repeated use of a disc

To save recorded images

To use one disc repeatedly

What would you like to do after recording?

Deleting and editing images in your DVD Handycam

Playing back disc on a various DVD devices

The disc can be played back on various DVD devices

The disc can be played back even without finalizing

* Select the mode on your DVD Handycam and format (p.26).

DVD
-R

DVD
-RW

VR*

VIDEO*

DVD
+RW

② Shooting, deleting and editing

(See pages 32, 38, 46 and 85.)

You cannot delete a recorded image.

You can delete or edit a recorded image anytime (p.85).

You can only delete the images you have just recorded (p.46).

③ Viewing on your DVD Handycam

(See pages 34 and 40)

You can also connect it to a TV for viewing (p.50).



Continued on the right page

④ Viewing on another DVD device

(See pages 52 and 56.)

To view a disc recorded on your DVD Handycam on other DVD devices, you need to finalize it first.



- The less the recording volume of the disc is, the more it takes time to finalize the disc.

The features of a finalized disc depend on disc type.

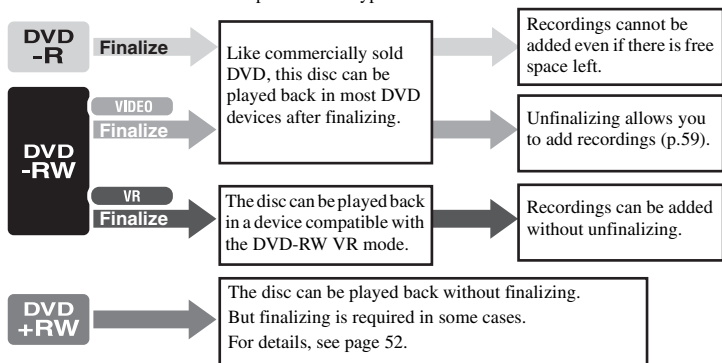

Playback compatibility

Playback compatibility with any DVD device is not guaranteed. Refer to the instruction manual supplied with your DVD device or consult your dealer.

Step 1: Checking supplied items

Make sure that you have following items supplied with your camcorder.
The number in the parentheses indicates the number of that item supplied.

- Discs and “Memory Stick Duo” are not supplied.

AC Adaptor (1) (p.19)

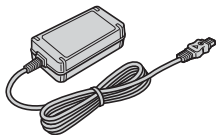

Mains lead (1) (p.19)

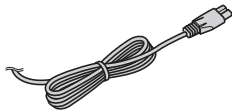

A/V connecting cable (1) (p.50, 90, 92, 96)



USB cable (1) (p.94, 96)
(For DCR-DVD405E/DVD805E)

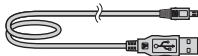

Wireless Remote Commander (1) (p.49)

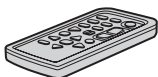

A button-type lithium battery is already installed.

Rechargeable battery pack
NP-FP60 (1) (p.20)

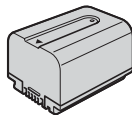

Cleaning cloth (1)

CD-ROM “Picture Package Ver.1.8.1” (1)
(p.97) (For DCR-DVD405E/DVD805E)

CD-ROM “Nero Express 6” (1)
(p.97) (For DCR-DVD404E)
Use when copying a disc recorded with your camcorder onto a 12cm DVD.

Operating Guide (This manual) (1)

Step 2: Charging the battery pack

You can charge the battery after attaching the "InfoLITHIUM" battery pack (P series) (p.131) to your camcorder.

- You cannot use an NP-FP30 battery pack with your camcorder. (See the reverse side of the battery pack for the model number.)
Installing the battery pack with excess force may lead to camcorder malfunction such as deterioration in battery pack performance or difficulty in removing the battery pack.

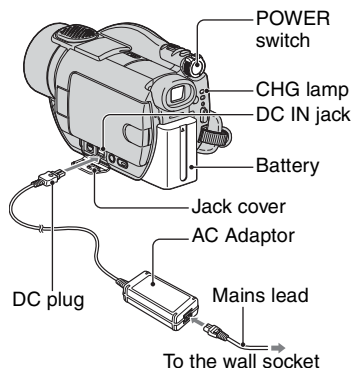

- 1** Slide the battery pack in the direction of the arrow until it clicks.

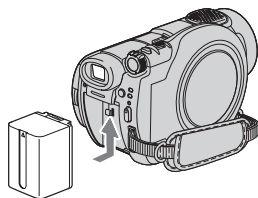

- 2** Slide the POWER switch in the direction of the arrow to set it to OFF (CHG) (The default setting).

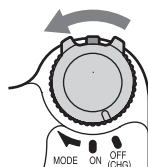

- 3** Connect the AC Adaptor to the DC IN jack on your camcorder.

Open the jack cover to connect the AC Adaptor.

Match the ▲ mark on the DC plug with ▲ mark on your camcorder.

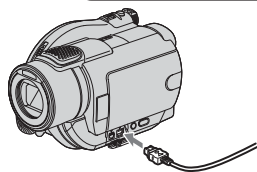
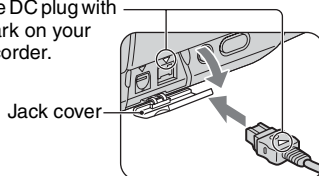

- 4** Connect the mains lead to the AC Adaptor and the wall socket.

The CHG (charge) lamp lights up and charging starts.

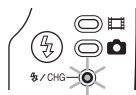

Step 2: Charging the battery pack (continued)

5 The CHG (charge) lamp turns off when the battery is fully charged. Disconnect the AC Adaptor from the DC IN jack on your camcorder.

- Disconnect the AC Adaptor holding both your camcorder and the DC plug.

To remove the battery pack

Slide the POWER switch to OFF (CHG). Slide the BATT (battery) release lever and remove the battery pack.

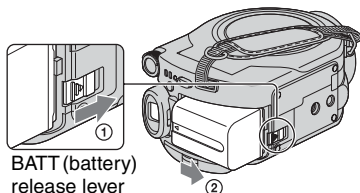

- When you remove the battery pack, make sure that none of the respective lamps of the POWER switch (p.22) is on.

When storing the battery pack

Use up the battery pack completely if you do not intend to use it for a long time (p.131).

To use an outside power source

Make the same connections as you do when charging the battery pack. The battery pack will not lose its charge in this case.

Charging time (full charge)

Approximate time (min.) required when you fully charge a fully discharged battery pack.

Battery pack	Charging time
NP-FP50	125
NP-FP60 (supplied)	135
NP-FP70	155
NP-FP71	170
NP-FP90	220

Recording time

Approximate time (min.) available when you use a fully charged battery pack.

Battery pack	Continuous recording time	Typical recording time*
NP-FP50	55	25
	60	30
	60	30
NP-FP60 (supplied)	85	40
	90	45
	95	45
NP-FP70	125	60
	135	65
	140	70
NP-FP71	145	70
	155	75
	160	80
NP-FP90	230	115
	250	125
	255	125

* Typical recording time shows the time when you repeat recording start/stop, turning the power on/off and zooming.

- Times shown vary according to the following conditions.
 - Top: When the LCD backlight turns on.
 - Middle: When the LCD backlight turns off.
 - Bottom: Recording time when recording with the viewfinder while the LCD panel is closed.

Playback time

Approximate time (min.) available when you use a fully charged battery pack.

Battery pack	LCD screen opened*	LCD screen closed
NP-FP50	90	110
NP-FP60 (supplied)	110	120
NP-FP70	200	235
NP-FP71	235	280
NP-FP90	345	415

* When the LCD backlight turns on.

On the battery pack

- Before changing the battery pack, slide the POWER switch to OFF (CHG).
- The CHG (charge) lamp flashes during charging, or BATTERY INFO (p.45) will not be correctly displayed under the following conditions.
 - The battery pack is not attached correctly.
 - The battery pack is damaged.
 - The battery pack is fully discharged.
(For BATTERY INFO only.)
- The power will not be supplied from the battery as long as the AC Adaptor is connected to the DC IN jack of your camcorder, even when the mains lead is disconnected from the wall socket.
- We recommend that you use an NP-FP70, NP-FP71 or NP-FP90 battery pack when a video light (optional) is attached.

On the charging/recording/playback time

- Times measured with the camcorder at 25 °C (77°F). (10-30°C (50-86°F) is recommended.)
- Available recording and playback time will be shorter when you use your camcorder in low temperatures.
- The available recording and playback time will be shorter depending on the conditions under which you use your camcorder.

On the AC Adaptor

- Connect the AC Adaptor to an easily accessible wall socket close by. If any trouble occurs while using the adaptor, immediately shut off the power by disconnecting the plug from the wall socket.
- Do not use the AC Adaptor placed in a narrow space, such as between a wall and furniture.
- Do not short-circuit the DC plug of the AC Adaptor or battery terminal with any metallic objects. This may cause a malfunction.

PRECAUTION

- The set is not disconnected from the AC power source (mains) as long as it is connected to the wall socket, even if the set itself has been turned off.

Step 3: Turning the power on, and holding your camcorder

To record, slide the POWER switch to turn on the respective lamp.

When using it for the first time, the [CLOCK SET] screen appears (p.25).

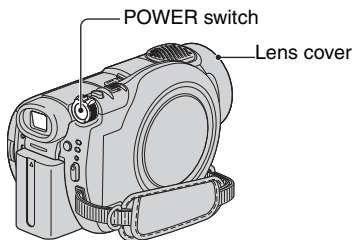

1 Turn on the power by sliding the POWER switch in the direction of the arrow while pressing the green button in the center.

When you record, switch the power mode by sliding the POWER switch in the direction of the arrow until the respective lamp lights up.

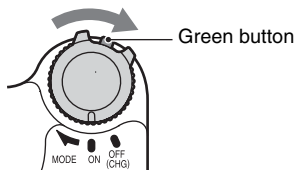

 **(Movie):** To record movies

 **(Still):** To record still images.



- When you turn on your camcorder, the lens cover opens up automatically.
- After you have set the date and time ([CLOCK SET], p.25), the next time you turn on the power of your camcorder, the current date and time will be displayed on the LCD screen for a few seconds.

2 Hold your camcorder correctly.

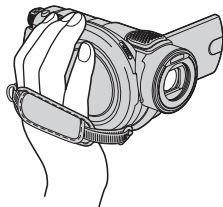

3 Ensure a good grip, then fasten the belt.

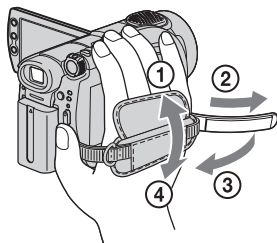

To turn off the power

Slide the POWER switch to OFF (CHG).

- At the time of purchase, the power will be set to turn off automatically if you leave your camcorder without any operation attempted for approximately 5 minutes, to save battery power. ([A.SHUT OFF], p.78).

Step 4: Adjusting the LCD screen and viewfinder

The LCD screen

Open the LCD screen 90 degrees to the camcorder (①), then rotate it to the best angle to record or play (②).

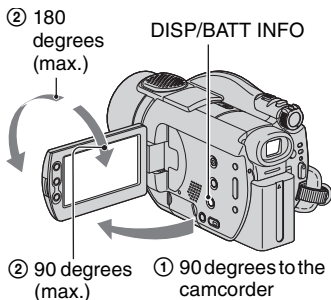

- Be careful not to press the buttons on the LCD frame accidentally when you open or adjust the LCD screen.
- If you open the LCD screen 90 degrees to the camcorder, then rotate it 180 degrees to the lens side, you can close it with the LCD screen side facing out. This is convenient during playback operations.

To turn off the LCD backlight to make the battery last longer

Press and hold DISP/BATT INFO for a few seconds until LCD_{OFF} appears.

This setting is practical when you use your camcorder in bright conditions or you want to save battery power. The recorded picture will not be affected by the setting. To cancel, press and hold DISP/BATT INFO until LCD_{OFF} disappears.

- See [LCD/VF SET] - [LCD BRIGHT] (p.76) to adjust the brightness of the LCD screen.

The viewfinder

You can view pictures using the viewfinder with the LCD panel closed to avoid wearing down the battery, or when the picture seen on the LCD screen is poor.

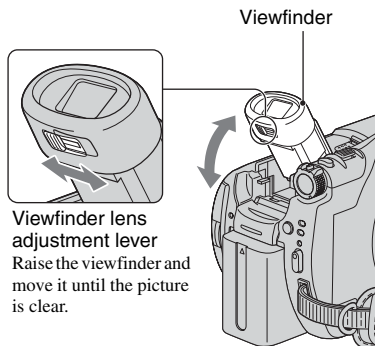

- You can adjust the brightness of the viewfinder backlight by selecting [LCD/VF SET] - [VF B.LIGHT] (p.76). The recorded picture will not be affected by the setting.
- You can adjust [FADER] and [EXPOSURE] while looking through the viewfinder (p.67, 73).

Step 5: Using the touch panel

You can play back recorded pictures (p.34, 40), or change the settings (p.62) using the touch panel.

Touch the buttons displayed on the screen.

Support the rear of the LCD panel with the palm of your left hand. Then, touch the buttons displayed on the screen.

Touch the button on the LCD screen.

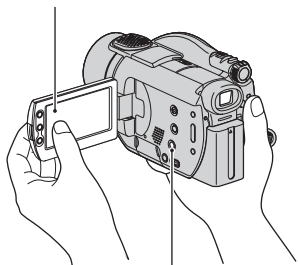

DISP/BATT INFO

- Perform the same actions as explained above when you press the buttons on the LCD frame.
- Be careful not to press buttons on the LCD frame accidentally while using the touch panel.
- If the buttons on the touch panel do not work correctly, adjust the LCD screen. (CALIBRATION) (p.134)

To hide the screen indicators

Press DISP/BATT INFO to hide or show the screen indicators (counter, etc.).

Changing the language setting

You can change the on-screen displays to show messages in a specified language. Select the screen language in [LANGUAGE] on the  TIME/LANGU. (p.79).

Step 6: Setting the date and time

Set the date and time when using this camcorder for the first time. If you do not set the date and time, the [CLOCK SET] screen appears every time you turn on your camcorder or slide the POWER switch.

- If you do not use your camcorder for about **3 months**, the built-in rechargeable battery gets discharged and the date and time settings may be cleared from the memory. In that case, charge the rechargeable battery and then set the date and time again (p.135).

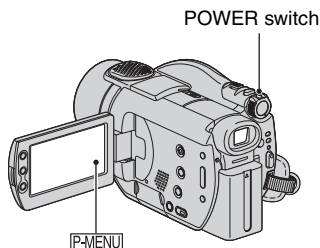

Skip to step 4 when you set the clock for the first time.

1 Touch [P-MENU] → [SETUP].

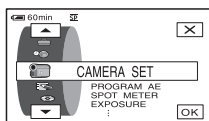

2 Select (TIME/LANGU.) with , then touch [OK].

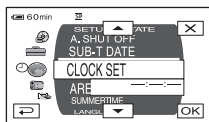

3 Select [CLOCK SET] with , then touch [OK].

4 Select the desired geographical area with , then touch [OK].

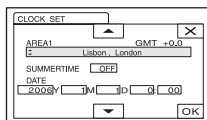

5 Set [SUMMERTIME] to [ON] with , if necessary, then touch [OK].

6 Set [Y] (year) with , then touch [OK].

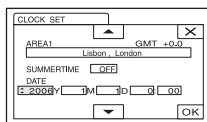

- You can set any year up to the year 2079.

7 Set [M] (month), [D] (day), hour and minute, then touch [OK].

The clock starts.

- Refer to page 127 for information concerning "World time difference."
- The recording date and time are not displayed during recording, but are automatically recorded onto the disc and you can check them during playback ([DATA CODE], p.76).

Step 7: Inserting a disc or a “Memory Stick Duo”

Inserting a disc

A new 8cm DVD-R, DVD-RW, or DVD+RW is required for recording (p.14).

- Remove dust or fingerprints from the disc beforehand, using the cleaning cloth supplied with your camcorder (p.128).

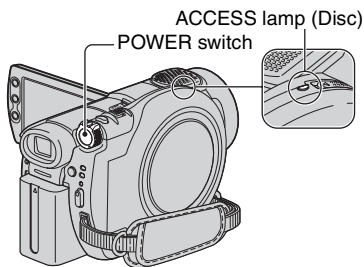

1 Check that the power of your camcorder is on.

- You can remove the disc when a power source is connected to your camcorder even when your camcorder is turned off. However, the disc recognition process (step 4) does not start.

2 Slide the disc cover OPEN switch in the direction of the arrow (OPEN ►).

[PREPARING TO OPEN] appears on the LCD screen. Then the opening melody sounds once, and the camcorder beeps. After the beeps stop, the disc cover opens slightly automatically.

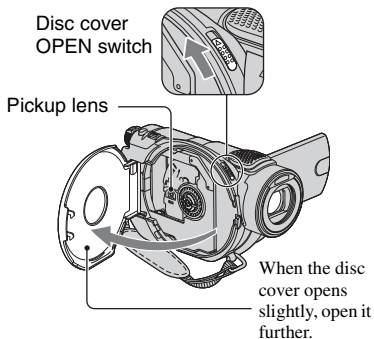

- Be careful not to obstruct the operation with your hand or other objects, etc., when opening or closing the disc cover. Move the belt to the bottom of the camcorder, then open or close the disc cover.
- If you catch the belt when closing the disc cover, it may cause your camcorder to malfunction.

3 Set the disc with the recording side facing your camcorder, then press the center of the disc until it clicks.

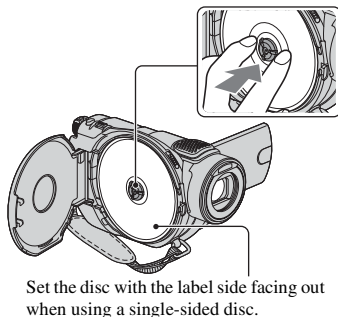

- Do not touch the disc with the recording side or pickup lens (p.135). When using a double-sided disc, take care not to smudge the surface with fingerprints.
- If you close the disc cover with the disc set incorrectly, it may cause your camcorder to malfunction.

4 Close the disc cover.

The [DISC ACCESS] screen appears. It may take some time to recognize the disc depending on the disc type and condition.

■DVD-R

You can start recording immediately after [DISC ACCESS] disappears from the LCD screen. You do not need to proceed to steps after step 5.

■DVD-RW

Select the recording format, then format the disc. Proceed to step 5.

■DVD+RW

Select the aspect ratio of the recording picture, then format the disc. Proceed to step 6.

- During Easy Handycam operation (p.31), [Format the disc? If not, remove the disc.] appears. Touch [OK], then proceed to step 8.

5 Select the recording format for a DVD-RW, and touch [OK], then proceed to step 7.

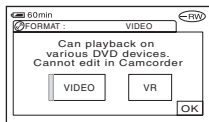

■VIDEO mode

You can play back the disc on most of DVD devices if you finalize it.

■VR mode

You can edit, delete pictures, or divide movies on your camcorder (p.85). However, the disc can be played back only on DVD devices that support VR mode when you finalize it.

6 Select the aspect ratio of the recording picture ([16:9 WIDE] or [4:3]) for DVD+RW, then touch [OK].

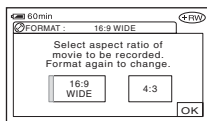

■16:9 WIDE

You can record wide-angle high-resolution pictures. If you intend to view pictures on a wide TV, selecting [16:9 WIDE] is recommended.

■4:3

You can record to play back pictures on a 4:3 TV.

7 Touch [YES] → [YES].

8 Touch [OK] when [Completed.] appears.

When the formatting is completed, you can start recording on the DVD-RW/DVD+RW.

- Do not remove the battery pack or disconnect the AC Adaptor while formatting.

To remove the disc

Perform step 1 and 2 to open the disc cover, then remove the disc.

- Do not apply shock or vibration to your camcorder while the ACCESS lamp lights up or flashes, or [DISC ACCESS] or [PREPARING TO OPEN] is displayed on the LCD screen.
- It may take some time to remove the disc depending on the disc condition or recorded materials.
- It may take up to 10 minutes to remove a disc if it is damaged or is dirty with fingerprints, etc. In that case, the disc might be damaged.

Step 7: Inserting a disc or a “Memory Stick Duo” (continued)

- After your camcorder recognizes the disc, disc information such as the date you started to use it and information on previously recorded areas appears for about 8 seconds. The information on previously recorded areas may not be displayed correctly depending on the condition of the disc.
- To delete all of the previously recorded pictures from a DVD-RW/DVD+RW, then to use it again to record new pictures, see “Deleting all of the scenes on the disc (Formatting)” on page 60.

Inserting a “Memory Stick Duo”

You can use only a “Memory Stick Duo” marked with **MEMORY STICK DUO** or **MEMORY STICK PRO DUO** (p.129).

- The number of recordable pictures varies depending on the image quality or the image size. For details, see page 71.

1 Raise the viewfinder.

2 Open the Memory Stick Duo cover.

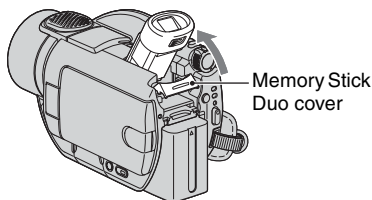

3 Insert the “Memory Stick Duo” into the Memory Stick Duo slot in the right direction until it clicks.

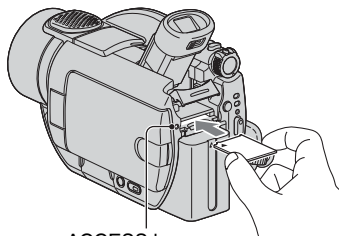

ACCESS lamp
 (“Memory Stick Duo”)

- If you force the “Memory Stick Duo” into the slot in the wrong direction, the Memory Stick Duo slot, or image data may be damaged.

4 Close the Memory Stick Duo cover and lower the viewfinder.

To eject a “Memory Stick Duo”

Lightly push the “Memory Stick Duo” after following step 1 and 2.

- When the ACCESS lamp is lit or flashing, your camcorder is reading/writing data. Do not shake or knock your camcorder, turn the power off, eject the “Memory Stick Duo,” or remove the battery pack. Otherwise, image data may be damaged.
- Make sure that the “Memory Stick Duo” does not pop up and drop off when inserting and removing it from your camcorder.

Step 8: Selecting the aspect ratio (16:9 or 4:3) of the recording picture

By recording in the 16:9 (wide) mode, you can enjoy wide-angle, high-resolution pictures.

- If you intend to view pictures on a wide TV, recording in the 16:9 (wide) mode is recommended.

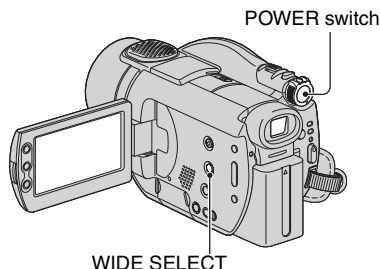

Movies

DVD
-RDVD
-RWDVD
-RW

VIDEO

VR

- 1 Slide the POWER switch in the direction of the arrow to light up the  (Movie) lamp.

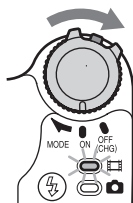

- 2 Press WIDE SELECT repeatedly to select the desired screen aspect ratio.

16:9 (wide)*



4:3*



- * When viewing on the LCD screen. It may be different in the viewfinder.
- You cannot change the aspect ratio in the following cases:
 - when using a DVD+RW
 - while recording movies
 - when [D.EFFECT] is set to [OLD MOVIE] (p.73)
- Differences in the angle of view between 16:9(wide) and 4:3 vary depending on the zoom position.
- Available recording time may be shorter in the following situations.
 - when you toggle between 16:9 (wide) and 4:3 while recording on a DVD-R/DVD-RW (VIDEO mode).
 - when you change [REC MODE] (p.75)/ with a DVD-R/DVD-RW (VIDEO mode)/ DVD+RW inserted while 4:3 is set.

To play back pictures after connecting your camcorder to a TV

Set [TV TYPE] to [16:9] or [4:3] according to your TV (16:9/4:3) (p.50).

- When viewing 16:9 (wide) pictures with [TV TYPE] set to [4:3], pictures may appear rough depending on subjects.

To play back images on a DVD device or a DVD recorder

The way you see pictures on the TV screen may differ depending on your device. For details, refer to the instruction manuals supplied with the devices you use.

Step 8: Selecting the aspect ratio (16:9 or 4:3) of the recording picture (continued)

Still images

1 Slide the POWER switch to light up the (Still) lamp.

The image size ratio changes to 4:3.



2 Select the recording media for still images.

① Touch [P-MENU] → [STILL MEDIA].

② Select the recording media for still images and touch [OK].

- The default setting is [MEMORY STICK].
-

3 Press WIDE SELECT repeatedly to select the desired setting.

- Still image size is [ 2.3M] ( $2.3M$) when 16:9 (wide) is set and maximum [3.0M] ( $3.0M$) when 4:3 is set.
- The number of recordable still images varies depending on image quality and image size. For details, see p.71.



Using Easy Handycam operation

Easy Handycam operation is a function for making nearly all settings automatic with just one press of the EASY button. Your camcorder automatically carries out the various adjustments required for shooting, so no detailed settings are required. Since only basic functions become available and screen font size increases for easy viewing, even first time users can enjoy easy operation.

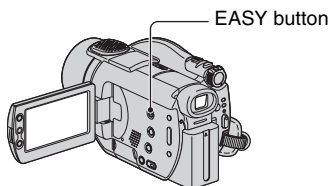

The settings of your camcorder during Easy Handycam operation

Touch [SETUP] to display the available setup items.

For details on setup, See page 62.



- Nearly all setup items are automatically fixed to the setting of Easy Handycam operation.
- [P-MENU] is not displayed during Easy Handycam operation.
- To perform settings such as focusing manually and adding special effects, cancel Easy Handycam operation.

Invalid buttons during Easy Handycam operation

You cannot use following buttons or functions since they are automatically set. If you set an invalid operation, [Invalid during Easy Handycam operation] appears.

- BACK LIGHT (p.43)
- Press and hold DISP BATT/INFO (p.45)
- Review/Review deleting (p.46)

To cancel Easy Handycam

Press EASY again. **EASY** disappears on the screen.

- If you turn off the power without canceling Easy Handycam operation, your camcorder turns on in Easy Handycam operation automatically when you turn on the power.



Now try recording → page 32

Complete the preparations described in steps 1 to 8 (p.18 to 29) before operation.

- When inserting a new DVD-RW, it is formatted with VIDEO mode.
- When using a DVD-RW disc formatted in VR mode, you cannot use the editing function on your camcorder (p.85).

If you do not intend to use Easy Handycam operation, go to page 38.



Recording with ease

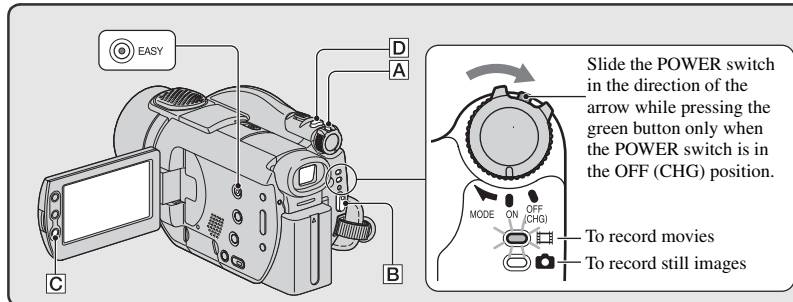

Movies

1 Slide the POWER switch **A** in the direction of the arrow to light up the (Movie) lamp.

2 Press START/STOP **B** (or **C**).

- The default settings is [SP] (p.75).

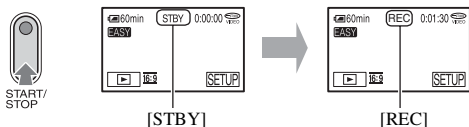

To stop recording, press START/STOP again.

To record the next images

Perform step **2**.

- You can continue recording if you have not finalized the disc (p.52) and there is remaining space to record on the disc when:
 - you turn off the power, then turn it on again.
 - you remove a disc from your camcorder, then insert it again.

Before Easy Handycam operation

Turn on your camcorder and press **EASY** to set to Easy Handycam operation (p.31).

[Easy Handycam operation ON.] appears, then **EASY** appears on the LCD screen.



Still images

1 Slide the **POWER** switch **A** in the direction of the arrow to light up the (Still) lamp.

2 Select the recording destination for still images.

① Touch [SETUP] → [STILL MEDIA].

② Select the media for recording still images, then touch [OK].

The recording screen returns with the selected recording media displayed at the top right.

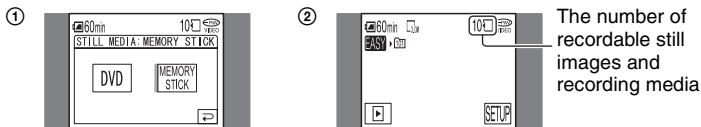

• The default setting is [MEMORY STICK].

3 Press **PHOTO** **D** lightly to adjust the focus **A**, then press it fully **B**.

• The default setting is [FINE] (p.71).

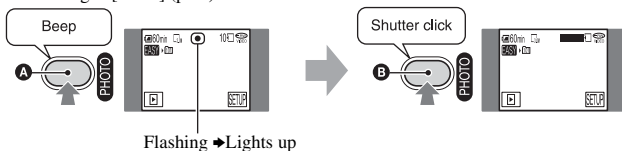

A shutter sound is heard. When disappears, the image has been recorded.



Playing back with ease

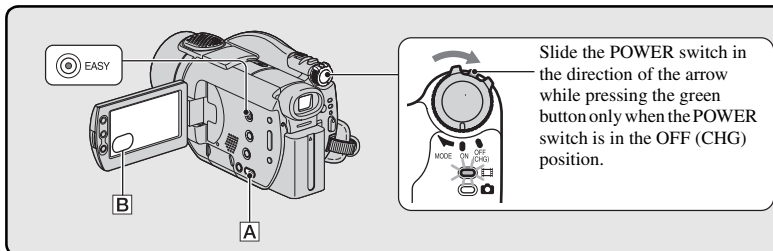

1 Press PLAY/EDIT (or)

The VISUAL INDEX screen appears on the LCD screen.

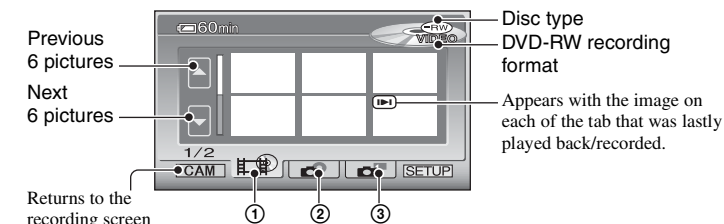

- ① tab: Displays the movies.
- ② tab: Displays the still images on the disc.
- ③ tab: Displays the still images on the "Memory Stick Duo."

- It may take some time to display the VISUAL INDEX screen.
- Select tab to play back the first 5 seconds of each movie clip in the VISUAL INDEX screen.

2 Start playing back.

Movies

Touch tab, then the movie to be played back.

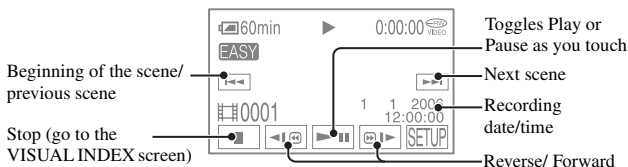

Before Easy Handycam operation

Turn on your camcorder and press **EASY** to set to Easy Handycam operation (p.31).

[Easy Handycam operation ON.] appears, then **EASY** appears on the LCD screen.



- When playback of the selected movie reaches the end, the screen returns to the VISUAL INDEX screen.
- Touch during pause to play back movie slowly.
- When you touch a movie marked with , you can play it back from the point you have stopped previously.
- Touch [SETUP] → [VOLUME], then adjust the volume with / .

Still Images

Disc:

Touch tab and the still image to be played back.

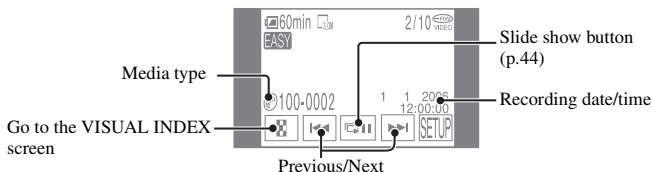

“Memory Stick Duo”:

Touch tab and the still image to be played back.

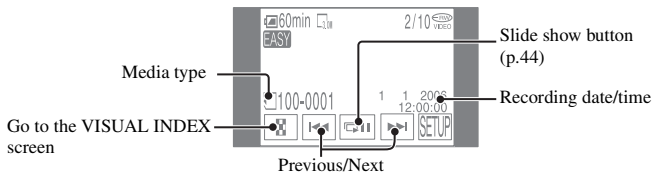

- Touch to play back a series of still images (p.44).

- When you playback during Easy Handycam operation, you cannot use following functions:
 - Playback zoom (p.44)
 - Turning off the backlight of the LCD screen (p.23)

Preparation for playing back on a DVD player (Finalizing)

Finalizing makes the recorded DVD compatible for playback with DVD devices and DVD drives of computers.

With Easy Handycam operation, your DVD Handycam sets up the following options automatically. Therefore, you can finalize a disc easily.

- creating a DVD menu to display images as thumbnails on a DVD player, etc.
- creating a Photomovie to play back still images on a DVD player, etc.

DVD menu, Photomovie  Glossary (p.139, 140)

- A DVD-R cannot be overwritten once you finalize it even when there is space to be recorded.
- If you finalize a DVD-RW (VIDEO mode)/DVD+RW, you cannot record additional material on the disc during Easy Handycam operation. Cancel Easy Handycam operation, then follow the steps shown on page 59.

Preparation for finalizing a disc

- 1 Place your camcorder in a stable position. Connect the AC Adaptor to the DC IN jack on your camcorder.**

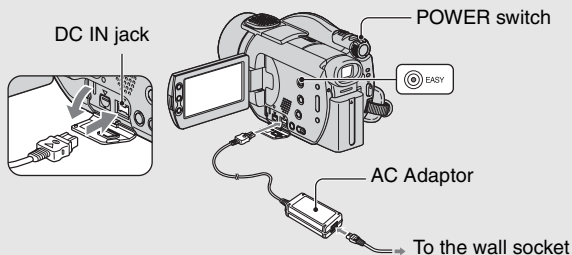

- Be sure to use the AC adaptor to prevent your camcorder from running out of power during finalizing.

- 2 Turn on your camcorder and press EASY to set to Easy Handycam (p.31).**

[Easy Handycam operation ON.] and **EASY** appears on the screen.



- 3 Insert the disc to be finalized.**

Finalizing a disc

Touch the LCD screen in the following steps.

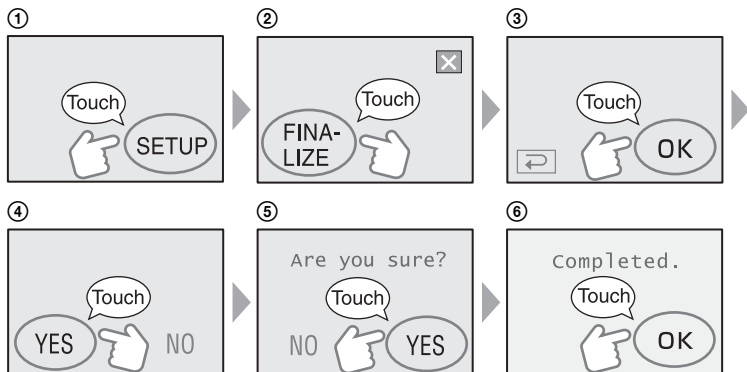

- Do not apply shock or vibration to your camcorder, and do not disconnect the AC adaptor during finalizing.
- The shorter the amount of material recorded, the longer it takes for finalizing.

Completed a disc

Remove the disc from your camcorder.

Enjoy watching images on the DVD device or DVD drive, etc.

Refer also to the instruction manuals supplied with the DVD device, etc.

Deleting all the scenes after playback (Formatting)



If you format the disc, the disc recovers recording used capacity and is reusable for recording thereafter.

If you want to reuse a DVD-RW to record in VR mode, format the disc after canceling Easy Handycam operation (p.60).

- **Note that you cannot recover a scene once you delete it.**

Touch the LCD screen in the following steps.

- ① [SETUP]
- ② [FORMAT]
- ③ [YES]
- ④ [YES]
- ⑤ [OK]



Recording

Lens cover
Opens in accordance
with the setting of the
POWER switch.

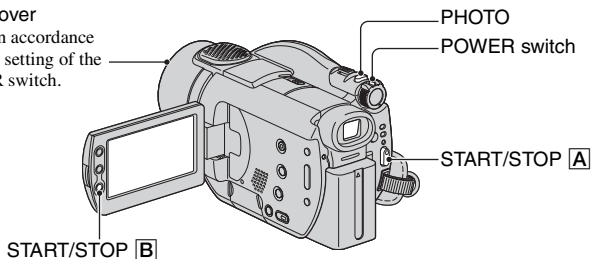

Movies

- 1** Slide the **POWER** switch in the direction of the arrow to light up the  (Movie) lamp.

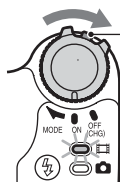

Slide the **POWER** switch in the direction of the arrow while pressing the green button only when the **POWER** switch is in the **OFF (CHG)** position.

- 2** Press **START/STOP [A]** (or **[B]**).

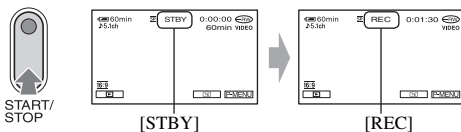

To stop recording, press **START/STOP** again.

Still Images

1 Slide the **POWER** switch to light up the  (Still) lamp.

2 Select the recording media for still images.

- ① Touch **[P-MENU]** → **[STILL MEDIA]**.
- ② Select the media for recording still images, then touch **[OK]**.
The recording screen returns with the selected recording media displayed at the top right.
 - The default setting is **[MEMORY STICK]**.
 - Select **[STILL MEDIA]** from **[SETUP]** when you do not find it in **[P-MENU]** (p.62).

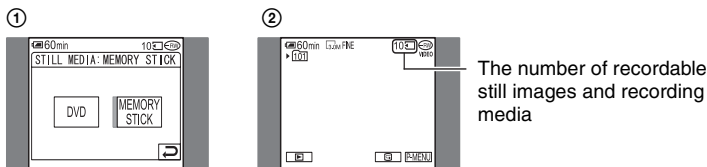

3 Press **PHOTO** lightly to adjust the focus **A**, then press it fully **B**.

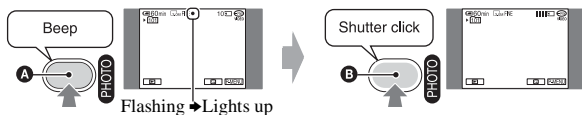

A shutter sound is heard. When  disappears, the image has been recorded.

To check or delete the last recording (Review/Review deleting)

See page 46.

- If the **ACCESS** lamp is on after recording is finished, it means data is still being written onto the disc or “Memory Stick Duo.” Do not apply shock or vibration to your camcorder, and do not disconnect the battery or AC Adaptor.

Playback

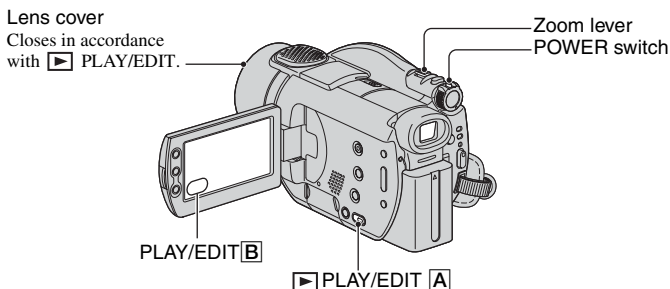

1 Slide the **POWER** switch to turn on your camcorder.

2 Press **PLAY/EDIT A** (or **B**).

The **VISUAL INDEX** screen appears on the LCD screen.

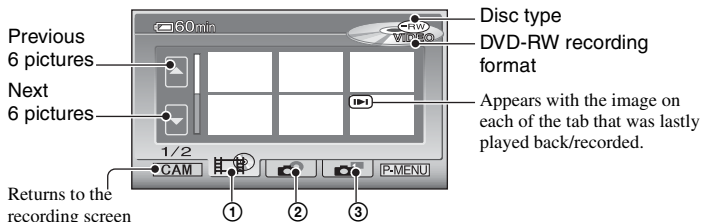

- ① tab: Displays the movies.
- ② tab: Displays the still images on the disc.
- ③ tab: Displays the still images on the "Memory Stick Duo."

• It may take some time to display the **VISUAL INDEX** screen.

Useful functions on **VISUAL INDEX** screen

- Moving the zoom lever changes the **VISUAL INDEX** screen indication from 6 to 12 and more images can be displayed at the same time. Touch **DISPLAY**] in **STANDARD SET** to set the number of thumbnails that appear in the **VISUAL INDEX** screen (p.77).
- Select to play back the first 5 seconds of each movie clip in the **VISUAL INDEX** screen in sequence, so you can check the movie. Set **MOVIE PB**] to [OFF] in **STANDARD SET** not to play back the movie and make the battery last longer (p.77).

3 Start playing back.

Movies



Touch tab and the movie to be played back.

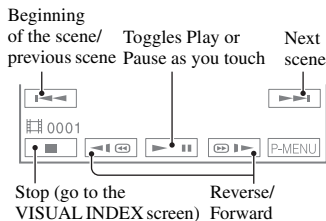

- When playback of the selected movie reaches the end, the screen returns to the VISUAL INDEX screen.
- Touch / during pause to play back movie slowly.
- One touch makes the reverse/fast forward approximately 5 times faster, two touches makes it approximately 10 times* faster.
- * Approximately 8 times faster using a DVD+RW
- When you touch a movie marked with , you can play it back from the point you have stopped previously.

Still Images



Disc:

Touch tab and the still image to be played back.

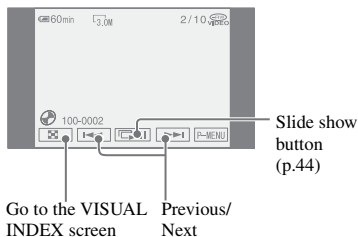

“Memory Stick Duo”:

Touch tab and the still image to be played back.

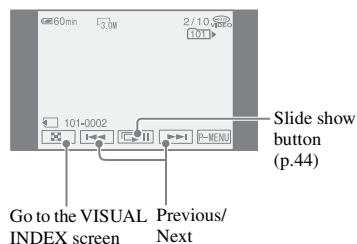

To adjust the volume

Touch → [VOLUME], then adjust it with / .

- If you cannot find [VOLUME] in , touch [SETUP] (p.62).

To playback the disc on other DVD devices

See page 52.

Functions used for recording/playback, etc.

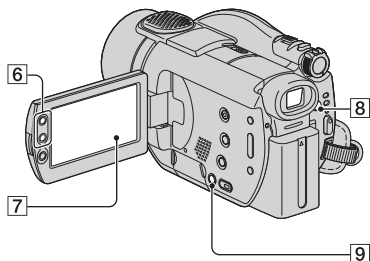
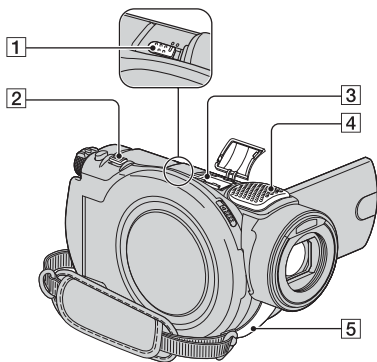

- Be careful not to remove your finger suddenly from the power zoom lever [2]. If you do so, the sound of the lever moving may be recorded.
- You cannot change the zoom speed with the zoom buttons [6] on the LCD frame.
- The minimum distance required between your camcorder and the subject to get a sharp focus is about 1 cm (about 1/2 inch) for wide angle and about 80 cm (about 2 5/8 feet) for telephoto.
- You can set [DIGITAL ZOOM] (p.70) if you want to zoom to a level greater than 10 x.

To record sound with more presence (5.1ch surround recording) [3] [4]



Your camcorder has Dolby Digital 5.1 Creator installed for recording 5.1ch surround sound. Enjoy realistic sound when playing the disc on devices that support 5.1ch surround sound.

- 5.1ch is displayed on the screen during 5.1ch recording/playback. 5.1ch sound is converted to 2ch when played back on your camcorder.

Dolby Digital 5.1 Creator, 5.1ch surround sound [Glossary] (p.139)

Sound picked up by the built-in 4ch microphone [4] is converted to 5.1ch surround sound and recorded.

Recording

To use zoom [2] [6]

Move the power zoom lever [2] slightly for a slower zoom. Move it further for a faster zoom.

Wider range of view: (Wide)

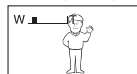

Close view: (Telephoto)

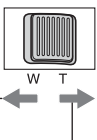

To record with a wireless microphone

You can use a wireless microphone (optional)* to record distant sound wirelessly.

The sound it picks up is allotted to the front center part of the 5.1ch surround sound, mixed with the sound picked up by the internal microphone, and recorded. You can enjoy more realistic sound by playing the disc on the device that supports 5.1ch surround sound. Attach the wireless microphone to the Active Interface Shoe [3] (p.96). For details, refer to the instruction manual of your wireless microphone.

* Optional wireless microphone is not available in all countries/regions.

To use the flash [8]

Press  (flash) [8] repeatedly to select the setting.

No indicator displayed: Automatically flashes when there is insufficient ambient light.



 (Forced flash): Always uses the flash regardless of the surrounding brightness.



 (No flash): Records without flash.

- The recommended distance to the subject when using the built-in flash is 0.3 to 2.5 m (1 to 8 feet).
- Remove any dust from the surface of the flash lamp before using it. Flash effect may be impaired if heat discoloration or dust obscures the lamp.
- The flash charge lamp flickers when charging the flash, and remains lit when the battery charge is complete.
- If you use the flash in bright places such as when shooting a backlit subject, the flash may not be effective.
- The flash does not work when attaching the conversion lens (optional) or filter (optional).
- You can change the brightness of the flash by setting [FLASH LEVEL], or you can prevent the redeye by setting [REDEYE REDUC] (p.68).

To record in dark places (NightShot) [1]

Set the NIGHTSHOT switch [1] to ON. ( and ["NIGHTSHOT"] appear.)

- To record an image brighter, use Super NightShot function (p.69). To record an image brighter in dim light, use Color Slow Shutter function (p.69).
- The NightShot and Super NightShot use infrared light. Therefore, do not cover the infrared port [5] with your fingers or other objects.
- Remove the conversion lens (optional).
- Adjust the focus manually ([FOCUS], p.68) when it is hard to focus automatically.
- Do not use these functions in bright places. This may cause a malfunction.

To adjust the exposure for backlit subjects (BACK LIGHT) [9]

To adjust the exposure for backlit subjects, press BACK LIGHT [9] to display . To cancel the back light function, press BACK LIGHT again.

To adjust the focus for an off center subject [7]

See [SPOT FOCUS] on page 68.

To fix the exposure for the selected subject [7]

See [SPOT METER] on page 66.

Functions used for recording/playback, etc. (continued)

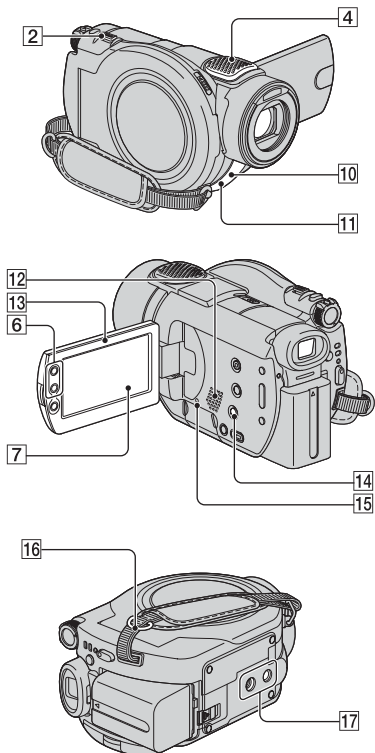

To record in mirror mode 13

Open the LCD screen 13 90 degrees to the camcorder (1), then rotate it 180 degrees to the lens side (2).

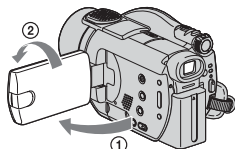

- A mirror-image of the subject appears on the LCD screen, but the picture will be normal when recorded.

To add special effects 7

See PICT. APPLI. on page 72.

To use a tripod 17

Attach the tripod (optional: the length of the screw must be less than 5.5 mm) to the tripod receptacle 17 using a tripod screw.

To attach the shoulder belt 16

Attach the shoulder belt (optional) with your camcorder to the hook for the shoulder belt.

Playback

To use Playback zoom 2 6

You can magnify pictures from about 1.1 to 5 times the original size.

Magnification can be adjusted with the power zoom lever 2 or the zoom buttons 6 on the LCD frame.

- 1 Play back the picture you want to magnify.
- 2 Magnify the picture with T (Telephoto). A frame appears on the LCD screen.
- 3 Touch the portion that you want to display in the center of the LCD screen.
- 4 Adjust the magnification with W (Wide angle)/T (Telephoto).

To cancel, touch [END].

- You cannot change the zoom speed with the zoom buttons 6 on the LCD frame.

To play back a series of still images (Slide show) 7

Touch on the still image playback screen.

The slide show begins from the selected image.

Touch to stop the slide show. To restart, touch again.

- You can touch to set continuous slide show playback. The default setting is [ON] (continuous playback).
- You cannot operate playback zoom during slide show.

Recording/playback

To check the remaining battery 14

Set the POWER switch to OFF (CHG), then press DISP/BATT INFO 14. If you press this button once, BATTERY INFO appears on the screen for about 7 seconds. Press the button while BATTERY INFO appears on the screen to extend the indication to the 20-second maximum.

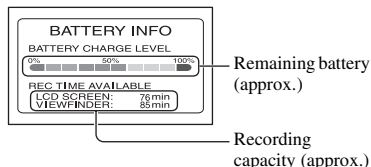

To turn off the operation confirmation beep 7

See [BEEP] on page 78.

To initialize the settings (RESET) .. 15

Press RESET 15 to initialize all the settings, including settings for date and time. (Setup items customized on Personal Menu are not initialized.)

Other part names and functions

4 Built-in 4ch microphone

When an external microphone (optional) is connected, it takes precedence over the internal microphone (p.96).

10 Remote sensor

Point the Remote Commander (p.49) towards the remote sensor to operate your camcorder.

11 Recording lamp

The recording lamp lights up in red during recording (p.78).

The lamp flashes when the remaining capacity for the battery or disc is running low.

12 Speaker

Sounds come out from the speaker while playing back.

- For how to adjust the volume, see page 41.



Checking/Deleting the last scene (Review/Review deleting)

You can check or delete the last recorded scene.

You cannot delete it if:

- you have removed the disc.
- you have recorded the new movies or still images.

Checking the last scene (Review)

- 1 Slide the **POWER** switch to light up the  (Movie) or  (Still) lamp, then touch .

The playback of the latest scene starts.

Movie

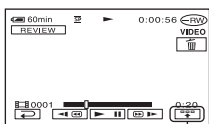

Touch to display below function buttons.

: Return to the beginning of the viewing movie.

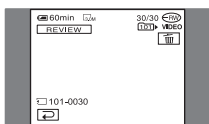

 / : Adjust the volume

Still image



To return to recording

Touch .

- Camera data (recording date, conditions etc.) is not displayed.
- When reviewing still images recorded continuously (p.70), you can forward/backward the images with  / .

Deleting the last scene (Review deleting)



If the checked scene is unnecessary, you can delete it on the spot.

Use the same procedure to delete still images recorded on the “Memory Stick Duo” until turning off the power after finishing recording.

Data once recorded on DVD-Rs cannot be deleted.

- 1 Press  during the review.

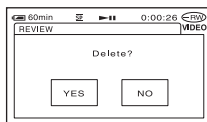

2 Touch [YES].

- You cannot recover a scene once you delete it.
- You can only delete the last recorded scene. When  is grayed out, you cannot delete the scene due to the following reasons.
 - The last recorded scene has been already deleted.
 - There is a movie or still image that has been recorded just after the scene being played back.
- When you delete still images that were recorded continuously (p.70), all the images are deleted at same time.

You can delete a specific still image when you record images in a DVD-RW (VR mode) and “Memory Stick Duo” (p.84, 85).

Indicators displayed during recording/playback

() is a reference page.

The indicators during recording will not be recorded.

Recording movies

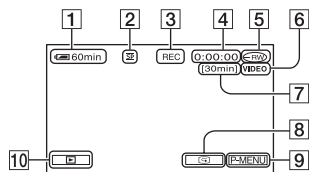

- 1 Remaining battery (approx.) (45)
- 2 Recording mode (HQ / SP / LP) (75)
- 3 Recording status ([STBY] (standby) / [REC] (recording))
- 4 Counter (hour: minute: second)
- 5 Disc type (14)
- 6 Recording format of a DVD-RW (14)
- 7 Remaining recordable time of the movie (approx.) (77)
- 8 Review button (46)
- 9 Personal Menu button (62)

Viewing movies

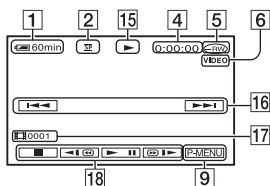

- 15 Playback mode
- 16 Previous/Next button (34, 41)
- 17 Scene number
- 18 Video operation buttons (34, 41)

Recording still images

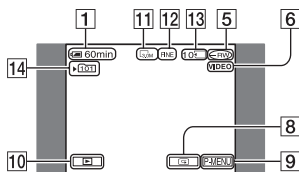

- 10 PLAY/EDIT button
- 11 Image size (71)
- 12 Quality ([FINE] / [STD]) (71)
- 13 The number of recordable still images and recording media
- 14 Recording folder (only for "Memory Stick Duo")*

* As the number of still images recorded in "Memory Stick Duo" increases, new folders are automatically created to store them.

Viewing still images

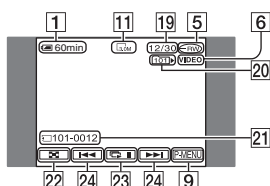

- 19 Number of played back still images/Total number of recorded still images
- 20 Playback folder (only for "Memory Stick Duo")
- 21 Data file name
- 22 VISUAL INDEX button (35, 41)
- 23 Slide show button (44)
- 24 Previous/Next button (35, 41)

Indicators displayed during recording/playback (continued)

() is a reference page.

Indicators on the LCD screen and viewfinder

When you can change the setup items, or during recording or playback, following indicators displayed.

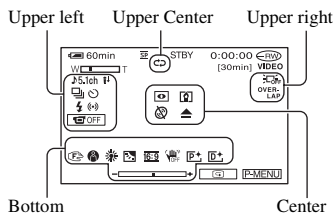

Upper left

Indicator	Meaning
	5.1ch surround recording/playback (42)
	Self-timer recording (69)
BRK	Continuous photo recording /Bracket recording (70)
	Flash light (68)
	MICREF LEVEL low (75)
	LCD panel off (73)

Upper center

Indicator	Meaning
	Repeat of Slide show (44)

Upper right

Indicator	Meaning
	Fader (72)
	LCD backlight off (23)

Center

Indicator	Meaning
	NightShot (43)
	Super NightShot (69)
	Color Slow Shutter (69)
	PictBridge connecting (94)
	Warning (121)

Bottom

Indicator	Meaning
	Picture effect (73)
	Digital effect (73)
	Manual focus (68)
	PROGRAM AE (66)
	Backlight (43)
	White balance (67)
	WIDE SELECT (29)
	SteadyShot off (70)
	Flexible spot meter (66)/ Exposure (67)

DATA CODE while recording

The recording date and time is recorded automatically on the disc and “Memory Stick Duo.” They are not displayed while recording. However, you can check them as [DATA CODE] during playback (p.76). You can view the recording date and time on a DVD device, etc. (p.56, [SUB-T DATE], p.78).

Remote Commander

Remove the insulation sheet before using the Remote Commander.

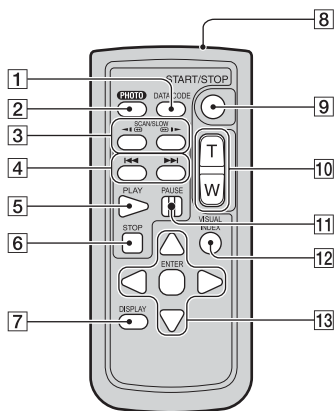
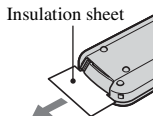

1 DATA CODE (p.76)

Displays the date and time or camera setting data of the recorded images (p.76) when you press this while playing back.

2 PHOTO (p.33, 38)

The on-screen image when you press this button will be recorded as a still image.

3 SCAN/SLOW (p.34, 41)

4 ◀◀ ▶▶ (Previous/Next) (p.34, 35, 41)

5 PLAY (p.34, 41)

6 STOP (p.34, 41)

7 DISPLAY (p.24)

8 Transmitter

9 START/STOP (p.32, 38)

10 Power zoom (p.42, 44)

11 PAUSE (p.34, 41)

12 VISUAL INDEX (p.34, 41)

Displays a VISUAL INDEX screen when you press this while playing back.

13 ◀ / ▶ / ▲ / ▼ / ENTER

When you press any button, the orange frame appears on the LCD screen. Select a desired button or an item with ◀ / ▶ / ▲ / ▼, then press ENTER to enter.

- Point the Remote Commander towards the remote sensor to operate your camcorder (p.45).
- When no commands have been sent from the Remote Commander in a certain period, the orange frame disappears. When you press any of ◀ / ▶ / ▲ / ▼, or ENTER again, the frame appears at the position where it was displayed last.
- To change the battery, see page 135.

Playing the picture on a TV

Connect your camcorder to the input jack of TV or VCR using A/V connecting cable **1** or A/V connecting cable with S VIDEO **2**. Connect your camcorder to the wall socket using the supplied AC Adaptor for this operation (p.19). Refer also to the instruction manuals supplied with the devices to be connected.

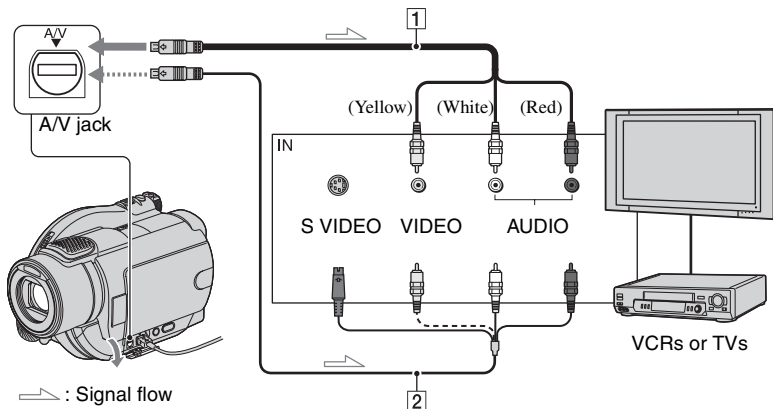

1 A/V connecting cable (supplied)

Connect to the input jack of the other device.

2 A/V connecting cable with S VIDEO (optional)

When connecting to another device via the S VIDEO jack, by using an A/V connecting cable with an S VIDEO cable (optional), higher quality pictures can be produced than with an A/V connecting cable. Connect the white and red plug (left/right audio) and the S VIDEO plug (S VIDEO channel) of the A/V connecting cable with an S VIDEO cable (optional). The yellow plug connection is not necessary. S VIDEO connection only will not output audio.

When your TV is connected to a VCR

Connect your camcorder to the LINE IN input on the VCR. Set the input selector on the VCR to LINE (VIDEO 1, VIDEO 2, etc.), if the VCR has an input selector.

To set the aspect ratio according to the connected TV (16:9/4:3)

Change the setting according to the screen aspect ratio of the TV you will view pictures on.

- 1 Slide the POWER switch to turn on your camcorder and press **▶** PLAY/EDIT.
 - 2 Touch **[P-MENU]** → **[SETUP]** → **[STANDARD SET]** → **[TV TYPE]** → **[16:9]** or **[4:3]** → **[OK]**.
- When you set [TV TYPE] to [4:3], the image quality may deteriorate. Also, when the recorded picture's aspect ratio switches between 16:9 (wide) and 4:3, the image may jitter.
 - When you play back a picture recorded in 16:9 (wide) aspect ratio on a 4:3 TV not compatible with the 16:9 (wide) signal, set [TV TYPE] to [4:3].

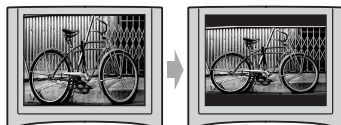

When your TV is monaural (When your TV has only one audio input jack)

Connect the yellow plug of the A/V connecting cable to the video input jack and connect the white (left channel) or the red (right channel) plug to the audio input jack of your TV or VCR.

- You can display the counter on the TV screen by setting [DISP OUTPUT] to [V-OUT/PANEL] (p.78).

If your TV/VCR has a 21-pin adaptor (EUROCONNECTOR)

Use a 21-pin adaptor (optional) to view playback picture.

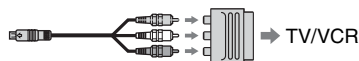

Making the disc compatible with playback on DVD devices or DVD drives (Finalizing)

Finalizing makes the recorded DVD compatible for playback with DVD devices and DVD drives of computers.

• **Playback compatibility with any DVD device is not guaranteed.**

The following settings are available before finalizing.

- Select the type of DVD menu to view disc content (see page 55)*
- Create a Photomovie to view still images (see page 55)*
- Change the disc titles (see page 55)

The DVD type determines finalizing characteristics.

Discs that must be finalized...



Discs that do not require finalizing...



Disc type **DVD+RW** has to be finalized in the following cases:

- ① To create the DVD menus or Photomovie
- ② To enable playback in DVD drives of computers.
- ③ When only little material is recorded
5 minutes or less in HQ mode, 8 minutes or less in SP mode and 15 minutes or less in LP mode.

Operation flow

To play back a disc in a DVD device for the first time (p.54)

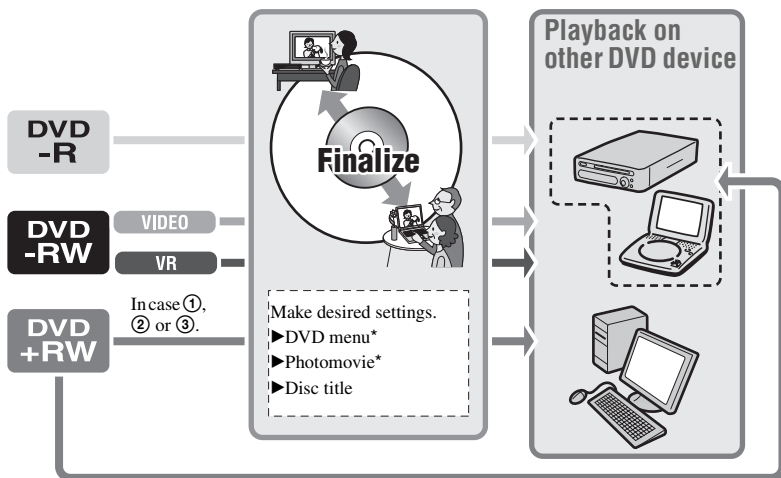

 **To add recordings to a finalized disc (p.59)**

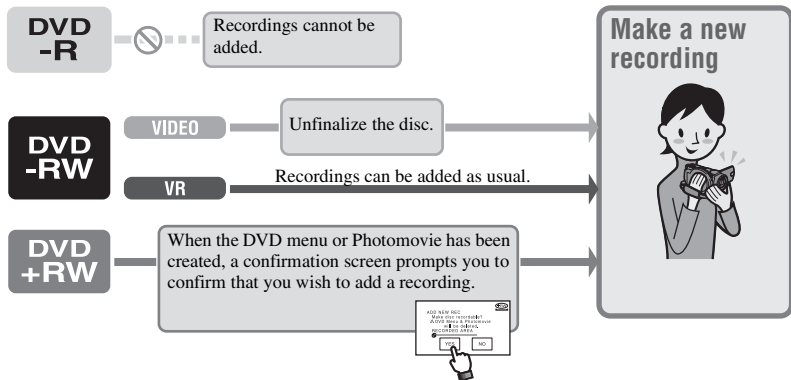

 **To play back a disc in a DVD device after adding a recording (p.54)**

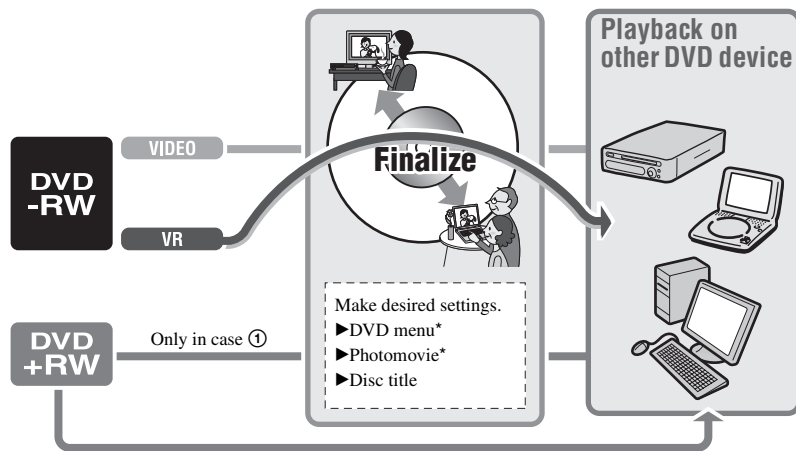

* Not possible for  (p.55).

Making the disc compatible with playback on DVD devices or DVD drives (Finalizing) (continued)

Finalizing a disc

- It takes from a minute to a few hours for finalizing. The shorter the amount of material recorded on the disc, the longer it takes for finalizing.
- Use the AC Adaptor as the power source to prevent your camcorder from running out of power during finalizing.
- When you finalize a double-sided disc, you must finalize each side of the disc.

1 Place your camcorder in a stable position. Connect the AC Adaptor to the DC IN jack on your camcorder.

2 Turn on the power by sliding the POWER switch.

3 Insert the disc to be finalized.

4 Touch **[P-MENU]** → **[FINALIZE]**.

Touching **[SET]** allows you to perform the following operations.

- To select a DVD menu style (p.55)
- To change Photomovie setting (p.55)
- To change the disc title (p.55)

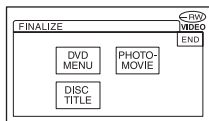

Go to step **5** if you want to finalize the disc using the following default settings.

- DVD menu: Style 1
- Photomovie: Create Photomovie
- Disc title: The date when the disc was first used

DVD menu, Photomovie, Disc title Glossary (p.139, 140)

5 Touch **[OK]** → **[YES]** → **[YES]**.

Finalizing starts.

- Do not apply shock or vibration to your camcorder, and do not disconnect the AC Adaptor during finalizing.
When you need to disconnect the AC Adaptor, make sure that the power of your camcorder is set to off and disconnect the adaptor after the CHG (charge) lamp goes off. Finalizing restarts when you connect the AC Adaptor and turn on your camcorder again. You cannot remove the disc until the finalizing operation is completed.

6 Touch **[OK]**, when **[Completed.]** appears.

- When using a DVD-R/DVD-RW (VIDEO mode)/DVD+RW, flashes after finalizing is completed on the recording standby screen of your camcorder. Remove the disc from your camcorder.
- When you made the setting to enable a creation of a DVD menu on DVD-R/DVD-RW (VIDEO mode)/DVD+RW, then finalize the disc, the DVD menu appears for a few seconds while finalizing the disc.
- You cannot view a Photomovie with the DVD-R/DVD-RW (VIDEO mode) discs in your camcorder.
- After finalizing a disc, the disc indicator and the recording format are displayed as shown below:

DVD-R	
DVD-RW (VIDEO mode)	
DVD-RW (VR mode)	
DVD+RW	

To select a DVD menu style



- ① Touch [DVD MENU].
- ② Select the desired style from 4 types of pattern with \blacktriangle / \blacktriangledown .

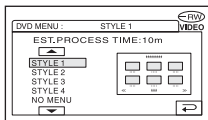

Select [NO MENU] if you do not create a DVD menu.

- ③ Touch [OK] \rightarrow [END].

To change a Photomovie setting



- ① Touch [PHOTOMOVIE].
 - ② Touch [YES].
Select [NO] if you do not create a Photomovie.
 - ③ Touch [OK] \rightarrow [END].
- It may take more time for finalizing when you create a Photomovie since the more still images recorded on the disc, the more time it takes to create a Photomovie.
 - You can view still images in the JPEG format using a DVD drive on your computer without creating a Photomovie (p.57).
 - You cannot create a Photomovie on a DVD-RW (VR mode) in this step. Customize it on the EDIT screen (p.88).

To change the disc title

- ① Touch [DISC TITLE].
- ② Delete unnecessary characters by touching \leftarrow .
The yellow cursor moves and characters are deleted from the end.
- ③ Select the type of a character, then touch the desired character.

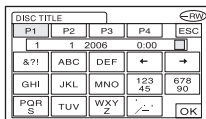

To erase a character: Touch \leftarrow .

To insert a space: Touch \rightarrow .

- ④ Touch \rightarrow as you register a character to move to the next entry point.
 - Up to 20 characters can be registered.
 - ⑤ When you have finished entering characters, touch [OK].
The disc title changes to the one you entered.
 - ⑥ Touch [END].
- You can enter the title up to 20 characters.
 - When you change a disc title already set by other devices, the 21st and subsequent characters are deleted.

Playing back a disc on DVD devices, etc.

A finalized disc recorded with your camcorder can be played back on a DVD device, etc. (p.52). DVD+RW discs can be played back without finalizing.

- Do not use the 8cm CD adaptor with an 8cm DVD as it may cause a malfunction.
- Make sure that a vertically installed DVD device is placed in the position where a disc can be placed horizontally.

Playback compatibility

Playback compatibility with any DVD device is not guaranteed. Refer to the instruction manual supplied with your DVD device or consult your dealer.

1 Insert a disc into a DVD device.

2 Play back the disc.

The playback procedure varies depending on the DVD device. For details, refer to the instruction manual supplied with your DVD device.

If you have created a DVD menu



You can select the desired scene in the menu. A Photomovie is listed after all the movies in the menu.

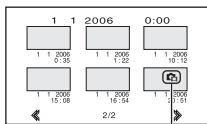

Photomovie

- The disc cannot be played back, freezes for an instant between the scenes, or some functions may be disabled on some DVD devices.
- Still images are played back as a Photomovie swapping images in every 3 seconds.
- DVD devices that support subtitles can display the recording date and time where the subtitles normally appear (p.78). Also refer to the instruction manual of your DVD device.

Playing back a disc on a computer with a DVD drive installed

- Do not use the 8cm CD adaptor with an 8cm DVD as it may cause a malfunction.
- Even when you use a DVD+RW, you must finalize the disc (p.52). Otherwise, it may cause a malfunction.

Playing back movies

Use a DVD drive that supports 8cm discs, and a DVD playback application must have been installed on your computer.

1 Insert the finalized disc into the DVD drive of your computer.

2 Play back the disc using a DVD playback application.

- The disc may not be played back on some computers. For details, refer to the instruction manuals of your computer.
- You cannot play back or edit movies that have been copied from the disc to the hard disk of your computer. For details on how to import movies, refer to the “First Step Guide” in the supplied CD-ROM (For DCR-DVD405E/DVD805E).

Playing back still images

Still images stored on the disc are displayed in the JPEG format.

Note that erasing or changing the original data may occur accidentally in this operation since you use the original data on the disc.

1 Insert the finalized disc into a DVD drive of your computer.

2 Click [Start] → [My Computer].

Or, double-click the [My Computer] icon on the desktop.

3 Right-click the DVD drive with the disc inserted, then click [Open].

4 Double-click [DCIM] → [100MSDCF].

5 Double-click the file to be displayed.

The selected still image appears on the screen.

The date the disc was first used is recorded on the volume label of the disc.

<e.g.>

When the disc was first used at 6:00 pm on January 1st 2006:

2006_01_01_06H00M_PM

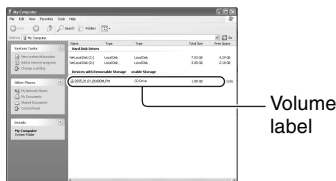

Images are stored in the following folders on the disc.

■ Movies

DVD-R/DVD-RW(VIDEO mode)/DVD+RW:

VIDEO_TS folder

DVD-RW (VR mode):

DVD_RTAV folder

■ Still images

DCIM\100MSDCF folder

<e.g.>

The folder for data for DVD-Rs/DVD-RWs (VIDEO mode)/DVD+RWs when using Windows XP:



Recording additional scenes after finalizing



You can record additional material on the finalized DVD-RWs (VIDEO mode)/DVD+RWs by following the steps below if there is space to record on the disc.

When using the finalized DVD-RW (VR mode) disc, you can record additional material on the disc without any additional steps.

- Use the AC Adaptor as power source to prevent your camcorder from running out of power during operation.
- Do not apply shock or vibration to your camcorder, and do not disconnect the AC Adaptor during operation.
- A DVD menu and a Photomovie created during finalizing are deleted.
- When you use a double-sided disc, following procedures are required on each side.

When using a DVD-RW (VIDEO mode) disc (Unfinalizing)

1 Connect the AC Adaptor to the DC IN jack on your camcorder, then connect the mains lead to the wall socket.

2 Slide the POWER switch to turn on your camcorder.

3 Insert the finalized disc into your camcorder.

4 Touch **P-MENU** → **[SETUP]**.

5 Touch  **MEDIA SET** → **[UNFINALIZE]**.

6 Touch **[YES]** → **[YES]**, then touch **[OK]** when **[Completed.]** appears.

When using a DVD+RW

If you have created a Photomovie or a DVD menu in finalizing (p.55), the following steps are required.

1 Connect the AC Adaptor to the DC IN jack on your camcorder, then connect the mains lead to the wall socket.

2 Slide the POWER switch to turn on your camcorder.

3 Insert the finalized disc into your camcorder.

A confirmation dialog asking if you record additional scenes appears.

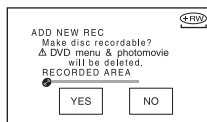

4 Touch **[YES]** → **[YES]**.

[Completed.] appears, then the screen returns to the recording screen.

Deleting all of the scenes on the disc (Formatting)



Formatting makes the recorded disc new and reusable by deleting all the data recorded on the disc. The recording capacity of the disc is recovered by formatting it.

- A DVD-R cannot be formatted. Replace it with a new disc.

Formatting a finalized disc

	The disc is unfinalized and it has to be finalized again to enable playback in a DVD device.
	Formatting deletes all images on a finalized disc. The icon or appears in the screen, but there is no need to finalize the disc before viewing it in a DVD device.*

* To use a DVD menu or a Photomovie on a DVD+RW, the disc must be finalized (p.52).

- Use the AC Adaptor as power source to prevent your camcorder from running out of power during formatting.
- Do not apply shock or vibration to your camcorder, and do not disconnect the AC Adaptor during formatting.
- When you use a double-sided disc, formatting is required on each side.

1 Connect the AC Adaptor to the DC IN jack on your camcorder, then connect the mains lead to the wall socket.

2 Slide the POWER switch to turn on your camcorder.

3 Insert the disc to be formatted into your camcorder.

4 Touch **[P-MENU]** → **[FORMAT]**.

■ DVD-RW

Select the recording format, then format the disc. Proceed to step 5.

■ DVD+RW

Select the aspect ratio of the recording picture, then format the disc. Proceed to step 6.

5 Select the recording format for a DVD-RW, touch **[OK]**, then proceed to step 7.



- For details on a recording format, see page 14.

6 Select the aspect ratio ([16:9 WIDE] or [4:3]) of the recording picture for DVD+RW, then touch **[OK]**.

- For details on the movie aspect ratio, see page 27.

7 Touch **[YES]** → **[YES]**, then touch **[OK]** when **[Completed.]** appears.

- You cannot change the movie aspect ratio which you set in step 6 for the DVD+RW. Format the disc again to change the aspect ratio.

- During the Easy Handycam operation (p.31), the screen in step **5** does not appear even if you insert a DVD-RW in your camcorder. Proceed to step **7**.
- You cannot format a disc that has been protected on other devices. Cancel the protection with the original devices, and then format it.

Using the Setup items

- 1 Slide the **POWER** switch in the direction of the arrow to light up the respective lamp.

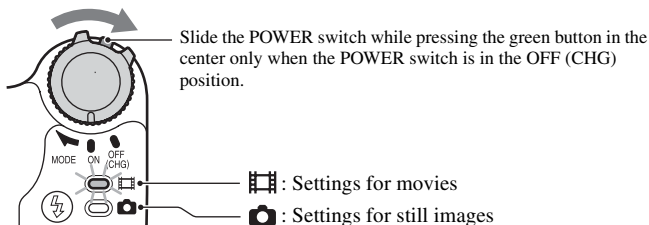

When carrying out the playback settings, press **PLAY/EDIT** to go to the playback screen.

- 2 Touch the **LCD** screen to select the setup item.

Unavailable items will be grayed out.

■ To use the short-cuts of Personal Menu

On Personal Menu, short-cuts for frequently used setup items are added.

- You can customize Personal Menu as you like (p.80).

- 1 Touch .

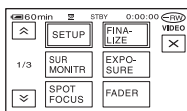

- 2 Touch the desired setup item.

If the desired setup item is not displayed on the screen, touch / until it is displayed.

- 3 Select the desired setting, then touch .

■ To change the setup items

You can customize setup items that are not added to Personal Menu.

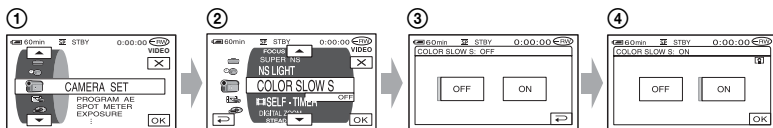

- ① Touch **P-MENU** → [SETUP].
- ② Select the desired setup item.
Touch **▲**/**▼** to select the item, then touch **OK**. (The process in step ③ is the same as that in step ②.)
- ③ Select the desired item.
 - You can also touch the item directly to select it.
- ④ Customize the item.
After finishing the settings, touch **OK** → **X** (close) to hide the setup screen.
If you decide not to change the setting, touch **↶** to return to the previous screen.

■ To change the setup items during Easy Handycam operation

P-MENU does not appear during Easy Handycam operation (p.31).

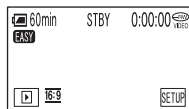

- ① Touch → [SETUP].
Available setup items appear.
- ② Select the desired item.
- ③ Customize the item.
Touch **OK** after finishing the setting.
Touch **↶** not to change the item without changing the setting.
 - Cancel the Easy Handycam operation (p.31) to change the setup items for the standard operation.

Setup items

Available setup items (●) vary depending on the operating mode. The following settings are made automatically during Easy Handycam operation (p.31).



CAMERA SET (p.66)

PROGRAM AE	●	●	–	AUTO
SPOT METER	●	●	–	AUTO
EXPOSURE	●	●	–	AUTO
WHITE BAL.	●	●	–	AUTO
AUTO SHUTTER	●	–	–	ON
SPOT FOCUS	●	●	–	AUTO
FOCUS	●	●	–	AUTO
FLASH SET	–	●	–	⚡ *1/OFF
SUPER NS	●	–	–	OFF
NS LIGHT	●	●	–	ON
COLOR SLOW S	●	–	–	OFF
SELF-TIMER	●	–	–	OFF
SELF-TIMER	–	●	–	OFF
DIGITAL ZOOM	●	–	–	OFF
STEADYSHOT	●	–	–	ON

STILL SET (p.70)

BURST	–	●	–	OFF
QUALITY	–	●	–	FINE
IMAGE SIZE	–	●	–	●
FILE NO.	–	●	–	_ *1

PICT.APPLI. (p.72)

FADER	●	–	–	OFF
D. EFFECT	●	–	–	OFF
PICT. EFFECT	●	–	–	OFF
REC CTRL *2	–	–	●	–
USB SELECT *2	–	–	●	_ *3
DEMO MODE	●	–	–	ON

MEDIA SET (p.74)

FORMAT	●	●	●	●
FINALIZE	●	●	●	●
UNFINALIZE	●	●	●	–
DISC TITLE	●	●	●	–
FORMAT	–	●	●	●

STANDARD SET (p.75)

REC MODE	●	–	–	SP
STILL MEDIA	–	●	–	●*1
VOLUME	–	–	●	●*1
MULTI-SOUND	–	–	●	OFF
MICREF LEVEL	●	–	–	NORMAL
SUR MONITOR	●	–	–	–
LCD/VF SET	●	●	●	–/NORMAL/–/ NORMAL/–*1
TV TYPE	●	●	●	_*1
USB SPEED *2	–	–	●	AUTO
DATA CODE	–	–	●	DATE/TIME
DISPLAY	–	–	●	_*1
MOVIE PB	–	–	●	_*1
REMAINING	●	–	–	AUTO
REMOTE CTRL	●	●	●	ON
REC LAMP	●	●	–	ON
BEEP	●	●	●	●*1
DISP OUTPUT	●	●	●	LCD PANEL
SETUP ROTATE	●	●	●	_*1
A.SHUT OFF	●	●	●	5 min
SUB-T DATE	●	–	–	_*1
CALIBRATION	–	–	●	–

TIME/LANGU. (p.79)

CLOCK SET	●	●	●	●*1
AREA SET	●	●	●	_*1
SUMMERTIME	●	●	●	_*1
LANGUAGE	●	●	●	_*1

*1 The setting values before Easy Handycam operation are maintained.

*2 DCR-DVD405E/DVD805E

*3 [USB SELECT] appears automatically when your camcorder is connected to a computer or other device with a USB cable.

CAMERA SET

Settings to adjust your camcorder to the recording conditions (EXPOSURE/WHITE BAL./STEADYSHOT, etc.)

The default settings are marked with ►.
The indicators in parentheses appear when the items are selected.
See page 62 for details on selecting setup items.

PROGRAM AE

You can record pictures effectively in various situations with the PROGRAM AE function.

► AUTO

Select to automatically record pictures effectively without the [PROGRAM AE] function.

SPOTLIGHT* (☹)



Select to prevent people's faces from appearing excessively white when subjects are lit by strong light.

PORTRAIT (Soft portrait) (👤)



Select to bring out the subject such as people or flowers while creating a soft background.

SPORTS* (Sports lesson) (🏃)



Select to minimize shake when shooting fast moving subjects.

BEACH&SKI* (🏖)



Select to prevent people's faces from appearing dark in strong light or reflected light, such as at a beach in midsummer or on a ski slope.

SUNSET&MOON** (🌅)



Select to maintain the atmosphere of situations such as sunsets, general night views or fireworks.

LANDSCAPE** (🏞)



Select to shoot distant subjects clearly. This setting also prevents your camcorder from focusing on glass or metal mesh in windows that comes in between the camcorder and the subject.

- Items with one asterisk (*) can be adjusted so as not to focus on subjects only a short distance away. Items with two asterisks (**) can be adjusted to focus on subjects farther away.
- The setting returns to [AUTO] when you set the POWER switch to OFF (CHG) for more than 12 hours.

SPOT METER (Flexible spot meter)

You can adjust and fix the exposure to the subject, so that it is recorded in suitable brightness even when there is strong contrast between the subject and the background, such as subjects in the spotlight on stage.

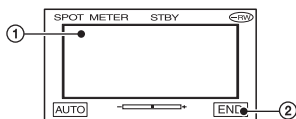

- ① Touch the point where you want to fix and adjust the exposure on the screen.
←→ appears.
- ② Touch [END].

To return the setting to automatic exposure, touch [AUTO]→[END].

- If you set [SPOT METER], [EXPOSURE] is automatically set to [MANUAL].
- The setting returns to [AUTO] when you set the POWER switch to OFF (CHG) for more than 12 hours.

EXPOSURE

You can fix the brightness of a picture manually. When recording indoors on a clear day, for instance, you can avoid backlight shadows on people next to the window by fixing the exposure to that of the wall side of the room.

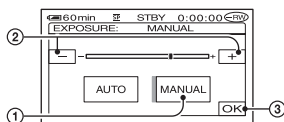

- 1 Touch [MANUAL].
→ appears.
- 2 Adjust the exposure by touching / .
- 3 Touch .

To return the setting to automatic exposure, touch [AUTO] → .

- If you rotate the LCD panel 180 degrees and close the LCD panel with the screen facing outwards, you can adjust [FADER] and [EXPOSURE] while looking through the viewfinder (p.73).
- The setting returns to [AUTO] when you set the POWER switch to OFF (CHG) for more than 12 hours.

WHITE BAL. (White balance)

You can adjust the color balance to the brightness of the recording environment.

► AUTO

The white balance is adjusted automatically.

OUTDOOR (☀)

The white balance is adjusted to be appropriate for the following recording conditions:

- Outdoors
- Night views, neon signs and fireworks
- Sunrise or sunset
- Under daylight fluorescent lamps

INDOOR (☀)

The white balance is adjusted to be appropriate for the following recording conditions:

- Indoors
- At party scenes or studios where the lighting conditions change quickly
- Under the video lamps of those at a studio, or under sodium lamps or incandescent-like color lamps

ONE PUSH (📺)

The white balance will be adjusted according to the ambient light.

- 1 Touch [ONE PUSH].
- 2 Frame a white object such as a piece of paper, to fill the screen under the same lighting conditions as you will shoot the subject.
- 3 Touch .
 flashes quickly. When the white balance has been adjusted and stored in the memory, the indicator stops flashing.
 - Keep framing white object while is flashing quickly.
 - flashes slowly if white balance could not be set.
 - keeps flashing even after you have touched , set [WHITE BAL.] to [AUTO].

- When you have changed the battery pack while [AUTO] is selected, or you bring your camcorder outdoors from inside the house while using fixed exposure, select [AUTO] and aim your camcorder at a nearby white object for about 10 seconds for better color balance adjustment.
- Redo the [ONE PUSH] procedure if you change the [PROGRAM AE] settings, or bring your camcorder outdoors from inside the house, or vice versa during the [ONE PUSH] is set to on.
- Set [WHITE BAL.] to [AUTO] or [ONE PUSH] under white or cool white fluorescent lamps.
- The setting returns to [AUTO] when you set the POWER switch to OFF (CHG) for more than 12 hours.

AUTO SHUTTER

Automatically activates the electronic shutter to adjust the shutter speed when recording in bright conditions if you set it to [ON] (the default setting).

SPOT FOCUS

You can select and adjust the focal point to aim it at a subject not located in the center of the screen.

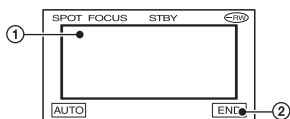

① Touch the subject on the screen.
 F appears.

② Touch [END].

To adjust the focus automatically, touch [AUTO]→[END] in step ①.

- If you set [SPOT FOCUS], [FOCUS] is automatically set to [MANUAL].
- The setting returns to [AUTO] when you set the POWER switch to OFF (CHG) for more than 12 hours.

FOCUS

You can adjust the focus manually. Select this when you want to focus on a certain subject intentionally.



① Touch [MANUAL].
 F appears.

② Touch + (focusing on close subjects)/ - (focusing on distant subjects) to sharpen the focus.

appears when the focus cannot be adjusted any closer, and appears when the focus cannot be adjusted farther away.

③ Touch [OK].

To adjust the focus automatically, touch [AUTO]→[OK] in step ①.

- It is easier to focus on the subject by moving the power zoom lever towards T (telephoto) to adjust the focus, then towards W (wide angle) to adjust the zoom for recording. When you want to record a subject at close range, move the power zoom lever to W (wide angle), then adjust the focus.
- The minimum distance required between your camcorder and the subject to get a sharp focus is about 1 cm (about 1/2 inch) for wide angle and about 80 cm (about 2 5/8 feet) for telephoto.
- The setting returns to [AUTO] when you set the POWER switch to OFF (CHG) for more than 12 hours.

FLASH SET

You can set this function when you use the built-in flash or an external flash (optional) that is compatible with your camcorder.

■ FLASH LEVEL

HIGH (⚡+)

Makes the flash level higher.

▶ NORMAL (⚡)

LOW (⚡-)

Makes the flash level lower.

- The setting returns to [NORMAL] when you set the POWER switch to OFF (CHG) for more than 12 hours.

■ REDEYE REDUC

You can prevent redevye by activating the flash before recording.

Set [REDEYE REDUC] to [ON], then press ⚡ (flash) (p.43) repeatedly to select a setting.

⊙ (Auto redevye reduction): Pre-flashes to reduce redevye before the flash automatically flashes when there is insufficient ambient light.

⚡ (Forced redevye reduction): Always uses the flash and the redevye reducing pre-flash.

⊙ (No flash): Records without flash.

- The redest reduction may not produce the desired effect due to individual differences and other conditions.
- The setting returns to [OFF] when you set the POWER switch to OFF (CHG) for more than 12 hours.

SUPER NS (Super NightShot)

You can record pictures at a maximum of 16 times the sensitivity of NightShot in dark places.

Set [SUPER NS] to [ON] while the NIGHTSHOT switch is set to ON.  and ["SUPER NS"] flash on the screen.

To cancel the setting, set [SUPER NS] to [OFF].

- Do not use NightShot and [SUPER NS] in bright places. This may cause a malfunction.
- Do not cover the infrared port with your fingers or other objects (p.43).
- Remove the conversion lens (optional).
- Adjust the focus manually ([FOCUS], p.68) when it is hard to focus automatically.
- The shutter speed of your camcorder changes depending on the brightness. The motion of the picture may slow down at this time.

NS LIGHT (NightShot Light)

You can record clearer pictures with the light which emits infrared light while using NightShot. The default setting is [ON].

- Do not cover the infrared port with your fingers or other objects (p.43).
- Remove the conversion lens (optional).
- The maximum shooting distance using [NS LIGHT] is about 3 m (10 feet).

COLOR SLOW S (Color Slow Shutter)

You can record an image brighter in color even in dark places.

Set [COLOR SLOW S] to [ON].  and [COLOR SLOW SHUTTER] flash on the screen.

To cancel [COLOR SLOW S], touch [OFF].

- Adjust the focus manually ([FOCUS], p.68) when it is hard to focus automatically.
- The shutter speed of your camcorder changes depending on the brightness. The motion of the picture may slow down at this time.

SELF-TIMER

The self-timer starts recording a movie after about 10 seconds.

Press START/STOP when [ SELF-TIMER] is set to [ON] ().



To cancel the count down, touch [RESET].

To cancel the self-timer, select [OFF].

- You can also use the self-timer with START/STOP on the Remote Commander (p.49).

SELF-TIMER

The self-timer starts recording a still image after about 10 seconds.

Press PHOTO when [ SELF-TIMER] is set to [ON] ().

To cancel the count down, touch [RESET].

To cancel the self-timer, select [OFF].

- You can also use the self-timer with PHOTO on the Remote Commander (p.49).

DIGITAL ZOOM

You can select the maximum zoom level in case you want to zoom to a level greater than 10×(the default setting) while recording on a disc or “Memory Stick Duo.” Note that the image quality decreases when you are using the digital zoom.

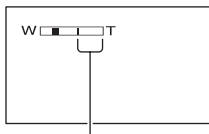

The right side of the bar shows the digital zooming factor. The zooming zone appears when you select the zooming level.

▶ OFF

Up to 10 × zoom is performed optically.

20 ×

Up to 10 × zoom is performed optically, and after that up to 20 × zoom is performed digitally.

120 ×

Up to 10 × zoom is performed optically, and after that, up to 120 × zoom is performed digitally.

STEADYSHOT

You can record pictures using [STEADYSHOT] (the default setting is [ON]). Set [STEADYSHOT] to [OFF] () when using a tripod or the conversion lens (optional).

STILL SET

Settings for still images
(BURST/QUALITY/IMAGE SIZE, etc.)

The default settings are marked with ▶. The indicators in parentheses appear when the items are selected.

See page 62 for details on selecting setup items.

BURST

You can record several still images one after another by pressing PHOTO.

▶ OFF

Select this when not recording continuously.

NORMAL ()

Records still images continuously at approximately 0.5 seconds intervals. The numbers of the maximum recordable images are as follows:

3.0M () : 3 images

1.9M () : 4 images

VGA (0.3M) () : 21 images

 2.3M () : 3 images

EXP. BRKTG ()

Records 3 images consecutively with different exposures at approximately 0.5 second intervals. You can compare the 3 images and select an image recorded at the best exposure.

- The flash will not function during continuous recording.
- The maximum number of images will be recorded in the self-timer mode or when you are operating with the Remote Commander.
- You may not be able to record continuous images up to the maximum number depending on the image size and the remaining capacity of the disc or “Memory Stick Duo.”
- [EXP.BRKTG] will not function when there is space remaining on the disc or “Memory Stick Duo” for less than 3 images.
- It takes longer to record continuous images to the disc compared to normal recording. Record the next still image after the scroll bar indicator () and the ACCESS lamp turns off.

QUALITY

► FINE (FINE)

Records still images at the fine image quality level.

STANDARD (STD)

Records still images at the standard image quality level.

The size of still images (Approx. kB)





	3.0M 	2.3M 	1.9M 	VGA (0.3M) 
FINE (FINE)	1540	1150	960	150
STANDARD (STD)	640	480	420	60

IMAGE SIZE

► 3.0M ()



Records still images clearly.

1.9M ()





Allows you to record more still images in relatively clear quality.

VGA (0.3M) ()

Allows for the maximum number of images to be recorded.

- When the picture ratio is changed to 16:9 (wide), the image size is changed to  2.3M ( 2.3M) (p.30).
- The number of pixels for each image size is as follows:
3.0M : 2016×1512
1.9M : 1600×1200
VGA (0.3M) : 640×480
 2.3M : 2016×1134









Number of still images recordable on a “Memory Stick Duo” (approx.)

	3.0M 	2.3M 	1.9M 	VGA (0.3M) 
16MB	10 24	13 32	16 37	96 240
32MB	20 48	27 65	32 75	190 485
64MB	40 98	54 130	65 150	390 980
128MB	82 195	105 260	130 300	780 1970
256MB	145 355	195 470	235 540	1400 3550
512MB	300 720	400 960	480 1100	2850 7200
1GB	610 1450	820 1950	980 2250	5900 14500
2GB	1250 3000	1650 4000	2000 4650	12000 30000

Top:[FINE] / Bottom:[STANDARD]

- When using the “Memory Stick Duo” made by Sony Corporation. The number of recordable still images varies depending on the recording environment.

Number of still images recordable on a disc (approx.)

	3.0M 	2.3M 	1.9M 	VGA (0.3M) 
 DVD-R	810 1750	1050 2250	1250 2550	5100 8100
 DVD-RW	850 1850	1100 2400	1300 2700	5400 8600
 DVD-RW	850 1850	1100 2400	1300 2700	5400 8600
 DVD+RW	740 1450	930 1750	1050 1850	2950 3800

Top:[FINE] / Bottom:[STANDARD]

- The table shows approximate recordable number and the above numbers apply to a single-sided disc, and it will be doubled for a double-sided disc.

FILE NO.

► **SERIES**

Assigns numbers to files in sequence even if the disc or “Memory Stick Duo” is changed.

RESET

Resets the file numbering to 0001 each time the disc or “Memory Stick Duo” is changed.

 **PICT.APPLI.**

Special effects on pictures or additional functions on recording/playback

(PICT.EFFECT/D.EFFECT, etc.)

The default settings are marked with ►. The indicators in parentheses appear when the items are selected.

See page 62 for details on selecting setup items.

FADER

You can add the following effects to currently recording pictures.

- ① Select the desired effect during standby (fade in) or recording (fade out), then touch **[OK]**. When you select **[OVERLAP]** or **[WIPE]**, the image is stored as a still image. (While storing the image, the screen turns to blue.)
- ② Press **START/STOP**.
The fader indicator stops flashing and disappears when the fade is complete.

To cancel before starting the operation, touch **[OFF]** in step ①.

- The setting will be canceled by pressing **START/STOP** again.



WHITE FADER



BLACK FADER



OVERLAP (fade in only)









WIPE (fade in only)



Using the viewfinder







You can adjust [EXPOSURE] and [FADER] while using the viewfinder by having the LCD screen rotated 180 degrees and closed with the screen facing out.

- Make sure the  (Movie) lamp lights up.
- Close the LCD screen with the screen facing out.
 appears.
- Touch .
[Set LCD off?] appears on the screen.
- Touch [YES].
The LCD screen is turned off.
- Touch the LCD screen while checking the display in the viewfinder.
[EXPOSURE], etc. are displayed.
- Touch the button you want to set.
[EXPOSURE] : Adjust with  / , and touch .
[FADER] : Touch it repeatedly to select a desired effect.
 : The LCD screen lights up.

To hide the buttons, touch .

D. EFFECT (Digital effect)

You can add digital effects to your recordings.  appears.

- Touch the desired effect.
- When you select [LUMI. KEY], adjust the effect with  / , then touch .
The image displayed when you touch  is saved as a still image.
- Touch .
 appears.

To cancel [D. EFFECT], touch [OFF] in step ①.

LUMI. KEY (luminance key)

Replaces a brighter area in a previously recorded still image (e.g. a person) with a movie.



OLD MOVIE

Adds an old movie effect to pictures.

The scene is recorded in the 16:9 (wide) mode.

- The aspect ratio cannot be changed when [OLD MOVIE] is selected.

PICT. EFFECT (Picture effect)

You can add special effects to a picture during recording.  appears.

▶ OFF

Does not use [PICT. EFFECT] setting.

SEPIA

Picture appears in sepia.

B&W

Picture appears in black and white.

PASTEL



Picture appears like a pale pastel drawing.

MOSAIC



Picture appears mosaic-patterned.

REC CTRL (DCR-DVD405E/ DVD805E)

See page 92.

USB SELECT (DCR-DVD405E/ DVD805E)

You can view pictures on a computer when connecting your camcorder to your computer with the USB cable or connect to the PictBridge compliant printer (p.94).

COMPUTER

Select this when viewing pictures in the disc on a Windows computer and copying to the computer with the supplied software.

 **COMPUTER**

Copies still images in the “Memory Stick Duo.”

 **PRINT**

Prints still images in the disc using the PictBridge compliant printer.

 **PRINT**

Prints still images in the “Memory Stick Duo” using the PictBridge compliant printer.

- [USB SELECT] automatically appears on the screen in the following:
 - when  PLAY/EDIT is pressed while connecting your camcorder to another device with the USB cable.
 - when connecting your camcorder to another device with the USB cable on the playback screen.
- For the detail of a computer connection, see “First Step Guide” in the supplied CD-ROM.

DEMO MODE

The default setting is [ON] so that you can view the demonstration in about 10 minutes, after you have set the POWER switch to  (Movie) without inserting a disc or “Memory Stick Duo.”

- The demonstration will be suspended in situations such as those described below.
 - when you touch the screen during the demonstration. (The demonstration starts again in about 10 minutes.)
 - when you slide the disc cover OPEN switch.
 - when the “Memory Stick Duo” is inserted.
 - when the POWER switch is set to  (Still).
 - when you set the NIGHTSHOT switch to ON (p.43).

 **MEDIA SET**

**Settings for discs and “Memory Stick Duo”
(FORMAT/FINALIZE/UNFINALIZE, etc.)**

See page 62 for details on selecting setup items.

 **FORMAT**

See page 60.

FINALIZE

See page 52.

UNFINALIZE

See page 59.

DISC TITLE

You can make a title on each disc. As the default setting, the date when the disc was first used is added as a disc title. Enter the disc title by following step **2** to **5** in “To change the disc title” of the “Making the disc compatible with playback on DVD devices or DVD drives (Finalizing)” (p.55). To cancel editing the title, touch [CANCEL].

 **FORMAT**

When the “Memory Stick Duo” is formatted, all the data will be deleted.

- ① Format the “Memory Stick Duo” by touching [YES] → [YES].
 - ② Touch  when [Completed.] appears.
- Even still images protected with another equipment against accidental deletion are deleted.
 - Do not attempt the following operations when [Executing...] is on the screen.
 - Operate the POWER switch or buttons
 - Remove the “Memory Stick Duo”



STANDARD SET

Settings while recording on a disc or other basic settings
(REC MODE/LCD/VF SET/USB SPEED, etc.)

The default settings are marked with ►.
The indicators in parentheses appear when the item is selected.
See page 62 for details on selecting setup items.

REC MODE (Recording mode)

You can select an image quality of the movie from three levels.

HQ (HQ)

Record in high quality mode
(approx. recordable time is up to 20 min).

► SP (SP)

Records in standard quality mode
(approx. recordable time is up to 30 min).

LP (LP)

Increases the recording time (Long Play)
(approx. recordable time is up to 60 min).

- The time in parenthesis indicates the approximate recordable time when recording only a movie on a single-sided disc. When recording on a double-sided disc, this value is applied for both sides.
- Your camcorder has a VBR encoding system (p.15) so when you record an object that moves fast, the time available for recording may shorten. VBR Glossary (p.140)
- If you record in the LP mode, the quality of scenes may be degraded, or scenes with quick movements may appear with a block noise when you play back the disc.

STILL MEDIA

See page 33, 39.

VOLUME

See page 41.

MULTI-SOUND

You can select whether to play back audio recorded using other devices with dual sound or stereo sound.

► STEREO

Plays back with main and sub sound (or stereo sound).

1

Plays back with main sound or the left channel sound.

2

Plays back with sub sound or the right channel sound.

- The setting returns to [STEREO] when you set the POWER switch to OFF (CHG) for more than 12 hours.

MICREF LEVEL

You can select the microphone level for recording sound.
Select [LOW] when you want to record exciting and powerful sound in a concert hall, etc.

► NORMAL

Records various surround sounds, converting them into the same level.

LOW (↓)

Records surround sound faithfully. This setting is not suitable for recording conversations.

- The setting returns to [NORMAL] when you set the POWER switch to OFF (CHG) for more than 12 hours.

SUR MONITOR

You can display the direction from which the recording sound comes when recording in 5.1ch mode.

LCD/VF SET

The recorded picture will not be affected even when you change the setting.

LCD BRIGHT

You can adjust the brightness of the LCD screen.

- Adjust the brightness with \square / \square .
- Touch \square .

LCD BL LEVEL

You can adjust the brightness of the LCD screen's backlight.

► NORMAL

Standard brightness.

BRIGHT

Brightens the LCD screen.

- When you use the AC Adaptor as the power source, [BRIGHT] is automatically selected for the setting.
- When you select [BRIGHT], battery life is slightly reduced during recording.

LCD COLOR

You can adjust the color on the LCD screen with \square / \square .



VF B.LIGHT

You can adjust the brightness of the viewfinder.

► NORMAL

Standard brightness.

BRIGHT

Brightens the viewfinder screen.

- When you connect your camcorder to AC Adaptor, [BRIGHT] is automatically selected for the setting.
- When you select [BRIGHT], battery life is slightly reduced during recording.

VF WIDE DISP

You can select how a 16:9 (wide) aspect ratio picture appears in the viewfinder.

► LETTER BOX

Normal setting (standard type of screen)

SQUEEZE (Squeeze)

Expands the picture vertically if black bands at the top and bottom in 16:9 (wide) aspect ratio are undesirable.

- When you can set the POWER switch to \square (Still), [VF WIDE DISP] does not appear.

TV TYPE

See page 50.

USB SPEED (DCR-DVD405E/ DVD805E)

You can select data transfer speed used to transfer data to your computer.

► AUTO

Sends data by switching automatically between the Hi-Speed USB (USB 2.0) and the speed corresponding to USB 1.1 (full speed transfer).

FULL SPEED

Sends data corresponding to USB 1.1 (full speed transfer).

DATA CODE

You can check the information recorded automatically (data code) during playback.

► OFF

Data code is not displayed.

DATE/TIME

Displays the date and time of recorded images.

CAMERA DATA

Displays the camera setting data of recorded images.

DATE/TIME



- 1 Date
- 2 Time

CAMERA DATA

Movie

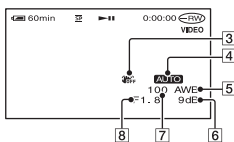

Still image

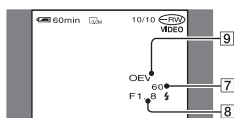

- 3 SteadyShot off
- 4 Exposure
- 5 White balance
- 6 Gain
- 7 Shutter speed
- 8 Aperture value
- 9 Exposure value

- appears for an image recorded using a flash.
- The data code is displayed on the TV screen if you connect your camcorder to a TV.
- The indicator toggles through the following sequences as you press DATA CODE on the Remote Commander: DATE/TIME → CAMERA DATA → OFF (no indication).
- Depending on the disc condition, bars [---:--:--] appear.
- The setting returns to [OFF] when you set the POWER switch to OFF (CHG) for more than 12 hours.

DISPLAY

You can select the number of thumbnails that appear on the VISUAL INDEX screen.

Thumbnail Glossary (p.140)

► ZOOM LINK

Change the number of thumbnails (6 or 12) with the zoom lever on your camcorder.*

6IMAGES

Displays thumbnails of 6 images.

12IMAGES

Displays thumbnails of 12 images.

* You can operate with the zoom buttons on the LCD frame or on the Remote Commander.

MOVIE PB

Because the default setting is [ON], when you select tab on the VISUAL INDEX screen the first 5 seconds of each movie displayed on the screen are played back in sequence.

- Set to [OFF] to conserve battery power.
- Playback for the movie stops after repeating 5 times.

REMAINING

► AUTO

Displays the remaining disc indicator for about 8 seconds in situations such as those described below.

- When your camcorder recognizes the remaining disc capacity with the POWER switch set to (Movie).
- When you press DISP/BATT INFO to switch the indicator from off to on with the POWER switch to (Movie).
- When the recordable time for movies is less than 5 minutes.
- When you start recording from the line input (For DCR-DVD405E/DVD805E).

ON

Always displays the remaining disc indicator.

REMOTE CTRL (Remote control)

The default setting is [ON] so that you can use the supplied Remote Commander (p.49).

- Set to [OFF] to prevent your camcorder from responding to a command sent by other device's remote control.
- The setting returns to [ON] when you set the POWER switch to OFF (CHG) for more than 12 hours.

REC LAMP (Recording lamp)

The camera recording lamp will not light up during recording when you set this to [OFF]. (The default setting is [ON].)

BEEP

▶ ON

A melody sounds when you start/stop recording, or operate the touch panel.

OFF

Cancels the melody.

DISP OUTPUT

▶ LCD PANEL

Shows displays such as the counter on the LCD screen and in the viewfinder.

V-OUT/PANEL

Shows the display also on the TV screen.

SETUP ROTATE

▶ NORMAL

Scrolls the setup items downwards by touching .

OPPOSITE

Scrolls the setup items upwards by touching .

A.SHUT OFF (Auto shut off)

▶ 5min

The camcorder is automatically turned off when you do not operate your camcorder for more than approximately 5 minutes.

NEVER

The camcorder is not automatically turned off.

- When you connect your camcorder to a wall socket, [A.SHUT OFF] is automatically set to [NEVER].

SUB-T DATE

Set to [ON] (the default setting) to display the recording date and time when you play back a disc on a DVD device with a subtitle display function. Also refer to the instruction manual of your DVD device.

CALIBRATION

See page 134.



TIME/LANGU.

(CLOCK SET/AREA SET/LANGUAGE,
etc.)

See page 62 for details on selecting
setup items.

CLOCK SET

See page 25.

AREA SET

You can adjust a time difference without
stopping the clock.

Set your local area using ▲/▼ when using
your camcorder overseas.

Refer to the World time difference on page
127.

SUMMERTIME

You can change this setting without stopping
the clock.

Set to [ON] to move the time forward one
hour.

LANGUAGE



You can select the language to be used on the
LCD screen.

- Your camcorder offers [ENG[SIMP]]
(simplified English) for when you cannot
find your native tongue among the options.

Customizing Personal Menu

You can add desired setup items to Personal Menu, and customize Personal Menu settings. This is convenient if you add frequently used setup items to Personal Menu.

Adding a setup item

You can add up to 27 setup items for  (Movie),  (Still) or  PLAY/EDIT. Delete a less important setup item, if you want to add more.

- 1 Touch **[P-MENU]** → **[P-MENU SET UP]** → **[ADD]**.

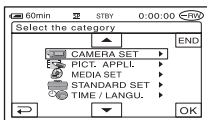

- 2 Touch **▲/▼** to select a setup category, then touch **[OK]**.

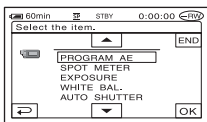

- 3 Touch **▲/▼** to select a setup item, then touch **[OK]** → **[YES]** → **[X]**.

The setup item is added to the end of list.

Deleting a setup item

- 1 Touch **[P-MENU]** → **[P-MENU SET UP]** → **[DELETE]**.

If the desired setup item is not displayed, touch **▲/▼**.

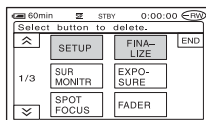

- 2 Touch the setup item that you want to delete.

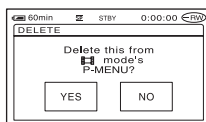

- 3 Touch **[YES]** → **[X]**.

- You cannot delete **[SETUP]**, **[FINALIZE]** and **[P-MENU SET UP]**.

Arranging the order of setup items displayed on Personal Menu

- 1 Touch **[P-MENU]** → **[P-MENU SET UP]** → **[SORT]**.

If the desired setup item is not displayed touch **[▲]** / **[▼]**.

- 2 Touch the setup item you want to move.

- 3 Touch **[▲]** / **[▼]** to move the setup item to the desired place.

- 4 Touch **[OK]**.

To sort more items, repeat step 2 to 4.

- 5 Touch **[END]** → **[X]**.

- You cannot move [P-MENU SET UP].

Initializing the Personal Menu settings (Reset)

Touch **[P-MENU]** → **[P-MENU SET UP]** → **[RESET]** → **[YES]** → **[YES]** → **[X]**.

Copying the still images

You can dub recorded still images from a “Memory Stick Duo” to a disc or from a disc to a “Memory Stick Duo.”

- Use the AC Adaptor as power source to prevent your camcorder from running out of power during operation during copying.
- Do not apply shock or vibration to your camcorder, and do not disconnect the AC Adaptor during copying.

Copying the still images from the “Memory Stick Duo” to DVD

Make sure to insert the recorded “Memory Stick Duo” and a disc into your camcorder.

- 1 Slide the **POWER** switch to turn on your camcorder and press **▶**.

- 2 Touch **☰** tab, then touch **[EDIT]**.

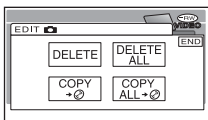

- 3 Touch **[COPY →]**.

- 4 Touch the still image to be copied.

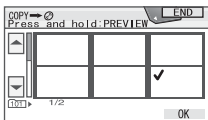

The selected scene is marked with ✓. Press and hold the image on the LCD screen to confirm the image. Touch **◀** to return to the previous screen.

- You can select up to 100 images at once.

- 5 Touch **[OK]** → **[YES]**.

Image copying starts.

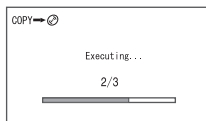

- 6 Touch **[OK]** when **[Completed.]** appears.

☰ tab appears in the VISUAL INDEX screen.

To copy all the still images on the “Memory Stick Duo”

Touch **[COPY ALL →]** in step 3.

- The still images cannot be copied to the finalized DVD-R/DVD-RW (VIDEO mode)/DVD+RW.
- Copying a large number of still images may take time.
- When **[Not enough memory space.]** appears, delete unnecessary images (p.85) in the disc before operating your camcorder again.
- Some still images cannot be copied in the following cases:
 - Images taken with another camcorder
 - Images edited with the computer

Copying the still images on the DVD to “Memory Stick Duo”

Make sure to insert the recorded DVD and “Memory Stick Duo” into your camcorder.

- 1 Slide the **POWER** switch to turn on your camcorder and press **▶** **PLAY/EDIT**.

- 2 Touch **Video** tab, then **[EDIT]**.

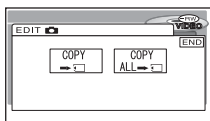

- 3 Touch **[COPY →]**.

- 4 Touch the still image to be copied.

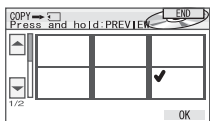

The selected scene is marked with ✓. Press and hold the image on the LCD screen to confirm the image. Touch **[←]** to return to the previous screen.

- You can select up to 100 images at once.

- 5 Touch **[OK]** → **[YES]**.

Image copying starts.



- 6 Touch **[OK]** when **[Completed.]** appears.

Video tab appears in the **VISUAL INDEX** screen.

To copy all the still images on the DVD

Touch **[COPY ALL →]** in step 3.

- It sometimes takes time when copying a number of still images.
- When **[Not enough memory space.]** appears, delete unnecessary images (p.84) in the “Memory Stick Duo” before operating your camcorder again.
- Some still images cannot be copied in the following cases:
 - Images taken with another camcorder
 - Images edited with the computer

Deleting still images from the “Memory Stick Duo”

Make sure to insert the recorded “Memory Stick Duo” into your camcorder.

1 Slide the **POWER** switch to turn on your camcorder and press **▶** **PLAY/EDIT**.

2 Touch **☰** tab.

3 Touch **[EDIT]**.

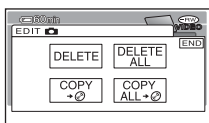

4 Touch **[DELETE]**.

5 Touch the still image to be deleted.

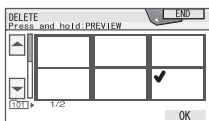

The selected scene is marked with **✓**. Press and hold the image on the LCD screen to confirm the image. Touch **◀** to return to the previous screen.

- You can select up to 100 images at once.

6 Touch **OK** → **[YES]**.

- You cannot recover an image once you delete it.
-

To delete all the still images in the “Memory Stick Duo”

Touch **[DELETE ALL]** in step **4**.

- You cannot delete in the following:
 - when the write-protect tab of the “Memory Stick Duo” is set to the write-protect position (p.129)
 - when the still image has been protected on other devices
- To delete all the still images in the “Memory Stick Duo,” format it (p.74).

Editing the original data



Using DVD-RWs recorded in VR mode, you can delete pictures or divide movies on the disc with your camcorder.

Make sure to insert the recorded disc into your camcorder.

Original Glossary (p.140)

Deleting images

1 Slide the **POWER** switch to turn on your camcorder and press **PLAY/EDIT**.

2 Select tab or tab that includes the image you want to delete, then touch **[EDIT]**.

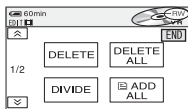

3 Touch **[DELETE]**.

4 Select the image to be deleted.

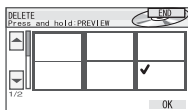

The selected scene is marked with . Press and hold the image on the LCD screen to confirm the image. Touch to return to the previous screen.

5 Touch → **[YES]**.

- You cannot recover an image once you delete it.

To delete all movies or still images on the disc at the same time

Touch **[DELETE ALL]** in step **3**.

- If you delete an original movie that is listed in a Playlist (p.86), it is also deleted from the Playlist.
- Deleting scenes may not provide enough space to record movies or still images additionally.
- To delete all the images on the disc and restore original recording capacity, format the disc (p.60).

Dividing a movie

1 Slide the **POWER** switch to turn on your camcorder and press **PLAY/EDIT**.

2 Touch tab → **[EDIT]**.

3 Touch **[DIVIDE]**.

4 Touch the scene to be divided.

The playback of the selected movie starts.

5 Touch at the point where you want to divide the movie into scenes.

The movie pauses.

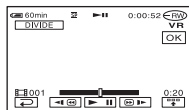

Editing the original data (continued)

When you touch , it changes to , and the operational buttons below appear.

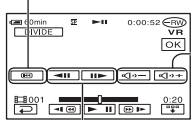

Returns to the beginning of the selected movie.



Adjust the volume

Adjusts the dividing point with more precision after the dividing point has been selected with .

To hide the buttons, touch .

- Play and pause toggles as you press .
- A slight difference may occur from the point where you touch  and the actual dividing point, as your camcorder selects the dividing point based on half-second increments.

6 Touch → [YES].

- Once you divide a movie, you cannot return it to the state it was in before you divided it.
- If the movie is added in the Playlist, dividing the original movie does not affect the movie in the Playlist.

Creating the Playlist

DVD
-RW

VR

A Playlist is a list showing thumbnails of the still images and movies that you have selected. The original scenes are not changed even though you edit or delete the scenes in the Playlist.

Playlist  Glossary (p.140)

Make sure to insert the recorded disc into your camcorder.



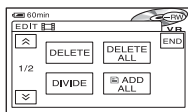

- Do not remove the battery pack or the AC Adaptor from your camcorder while editing the Playlist. It may damage the disc.
- You can add up to 999 scenes in the Playlist.

1 Slide the POWER switch to turn on your camcorder and press PLAY/EDIT.

2 Select tab or tab that includes the scene you want to add to the Playlist, then touch [EDIT].



3 Touch [ADD].

- Touch  /  to display [ ADD] when [ ADD] is not displayed.

4 Select the scene to be added to the Playlist.

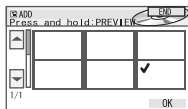

The selected scene is marked with ✓. Press and hold the image on the LCD screen to confirm the image. Touch  to return to the previous screen.

5 Touch [OK] → [YES].

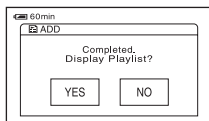

6 Touch [YES] to see the Playlist or [NO] to return to [RECORD] or [CAMERA] tab.

To add all the movies on the disc at the same time

Touch [ADD ALL] in step 3.

To add all the still images on the disc in a Playlist

It is recommended that you create a Photomovie (p.88) beforehand, then add it in a Playlist.

- When you add still images in a Playlist, they are converted automatically to a movie and added to [RECORD] tab. A movie converted from still images is shown with [M]. The original still images remain on the disc. The resolution of the converted movie may be lower than that of the original still images.

Erasing unnecessary scenes from the Playlist

1 Slide the POWER switch to turn on your camcorder and press [PLAY/EDIT].

2 Touch [EDIT] → [EDIT].

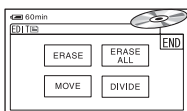

3 Touch [ERASE].

4 Select the scene to be deleted from the list.

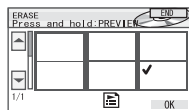

The selected scene is marked with ✓. Press and hold the image on the LCD screen to confirm the image. Touch [RETURN] to return to the previous screen.

5 Touch [OK] → [YES].

To erase all the scenes at the same time

Touch [ERASE ALL] in step 3 → [YES].

- The original scenes are not changed even though you erase the scenes from the Playlist.

Changing the order within the Playlist

1 Slide the POWER switch to turn on your camcorder and press [PLAY/EDIT].

2 Touch [EDIT] → [EDIT].

3 Touch [MOVE].

4 Select the scene to be moved.

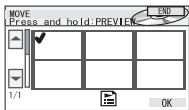

The selected scene is marked with ✓. Press and hold the image on the LCD screen to confirm the image. Touch  to return to the previous screen.

5 Touch .

6 Select the designated position with /.

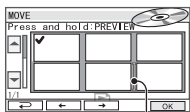

Move destination bar

7 Touch → **[YES]**.

- When you have selected multiple scenes, the scenes are moved following the order appeared in the Playlist.

Dividing a movie within the Playlist

1 Slide the **POWER** switch to turn on your camcorder and press .

2 Touch → **[EDIT]**.

3 Touch **[DIVIDE]**.

4 Select the scene to be divided.



The playback of the selected scene starts.

5 Touch at the point where you want to divide the movie into scenes.

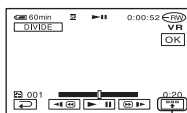
The movie pauses.



Touch to display functional buttons.
See page 85 for details.

- Play and pause toggles as you press .
- A slight difference may occur from the point where you touch  and the actual dividing point, as your camcorder selects the dividing point based on half-second increments.

6 Touch → **[YES]**.

- The original scenes are not changed even though you divide scenes within the Playlist.

Converting all the still images on a disc to a movie file (Photomovie)



Photomovie categorizes still images as a movie, you can add more images in the Playlist.

Photomovie  Glossary (p.140)

1 Slide the **POWER** switch to turn on your camcorder and press .

2 Touch  tab → [EDIT] → [PHOTOMOVIE].

3 Touch [YES].

All of the still images on the disc are converted to a single movie file, and added to  tab. A movie converted from still images is shown with  on the upper right.

- It may take more time to create a Photomovie as more still images are recorded on the disc.
- Still images which are not compatible with your camcorder, such as ones shot with a digital still camera and then copied to a computer can not be converted from still images to a Photomovie.

Playing the Playlist

DVD
-RW

VR

Make sure to insert the disc on which the Playlist is added into your camcorder.

1 Slide the **POWER** switch to turn on your camcorder and press  **PLAY/EDIT**.

2 Touch .

A list of the scenes added in the Playlist appears.

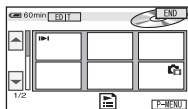

3 Touch the image from which you want to playback.

The screen returns to the VISUAL INDEX screen when the Playlist is played back from the selected scene to the end.

Dubbing to VCR/DVD devices

You can copy pictures played back on your camcorder to other recording devices, such as VCRs or DVD recorders.

After dubbing them to an HDD (hard disc drive) video recorder, you can enjoy images stored on the hard disk of the recorder.

Connect your camcorder to the wall socket using the supplied AC Adaptor for this operation (p.19). Refer also to the instruction manuals supplied with the devices to be connected.

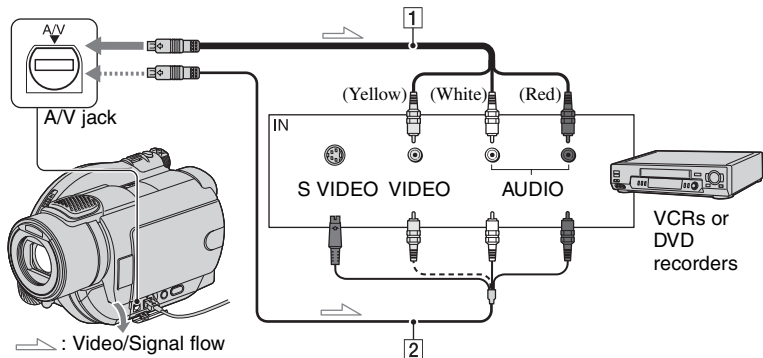

1 A/V connecting cable (supplied)

Connect to the input jack of the other device.

2 A/V connecting cable with S VIDEO (optional)

When connecting to another device via the S VIDEO jack, by using an A/V connecting cable with an S VIDEO cable (optional), higher quality pictures can be produced than with an A/V connecting cable. Connect the white and red plug (left/right audio) and the S VIDEO plug (S VIDEO channel) of the A/V connecting cable with an S VIDEO cable (optional). The yellow plug connection is not necessary. S VIDEO connection only will not output audio.

- To hide the screen indicators (such as a counter, etc.) on the screen of the monitor device connected, set [DISP OUTPUT] to [LCD PANEL] (the default setting, p.78).
- To record the date/time and camera settings data, display them on the screen (p.76).
- When you are connecting your camcorder to a monaural device, connect the yellow plug of the A/V connecting cable to the video input jack, and the red (right channel) or the white (left channel) plug to the audio input jack on the VCR or the TV.



1 Insert the recorded disc into your camcorder.

2 Slide the POWER switch to turn on your camcorder and press  PLAY/EDIT.

Set [TV TYPE] according to the playback device (p.50).

3 Insert the recording media for your VCR or DVD recorder.

If your recording device has an input selector, set it to the input mode.

4 Connect your camcorder to the VCR/DVD device with the A/V connecting cable (supplied)  or the A/V connecting cable with S VIDEO (optional) .

- Connect your camcorder to the input jacks of a VCR or DVD device.
-

5 Start the playback on your camcorder, and record it on the recording device.

Refer to the instruction manuals supplied with your recording device for details.

6 When dubbing is finished, stop your camcorder and the recording device.

Recording images from a TV or VCR/DVD device (DCR-DVD405E/DVD805E)

You can record pictures or TV programs from a VCR, TV or DVD device onto a disc using your camcorder.

Connect your camcorder to the wall socket using the supplied AC Adaptor for this operation (p.19). Refer also to the instruction manuals supplied with the devices to be connected.

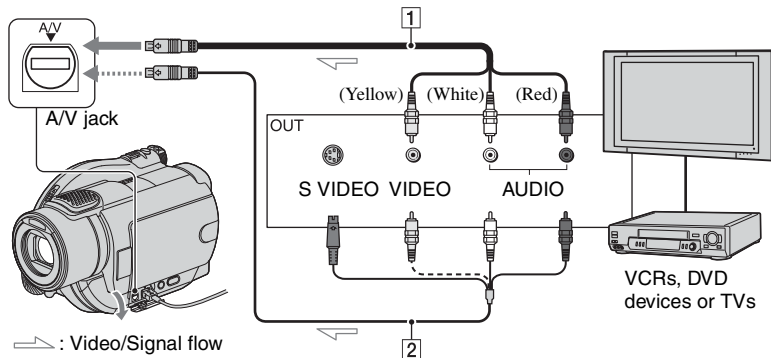

1 A/V connecting cable (supplied)

Connect to the output jack of the other device.

2 A/V connecting cable with S VIDEO (optional)

When connecting to another device via the S VIDEO jack, by using an A/V connecting cable with an S VIDEO cable (optional), higher quality pictures can be produced than with an A/V connecting cable. Connect the white and red plug (left/right audio) and the S VIDEO plug (S VIDEO channel) of the A/V connecting cable with an S VIDEO cable (optional). The yellow plug connection is not necessary. S VIDEO connection only will not output audio.

- You cannot record images from a TV with no output jacks.
- You cannot record TV programs which allow you to record once, or have copy control technology.
- When you are connecting your camcorder to a monaural device, connect the yellow plug of the A/V connecting cable to the video output jack, and the red (right channel) or the white (left channel) plug to the audio output jack on the VCR or the TV.
- Your camcorder can only record from a PAL source. For example, French video or TV programs (SECAM) cannot be recorded correctly. See page 126 for details on TV color systems.
- If you use a 21-pin adaptor to input PAL source, you need a dual direction 21-pin adaptor (optional).

1 Connect your camcorder to the TV or VCR/DVD device with the A/V connecting cable (supplied) **1** or the A/V connecting cable with S VIDEO (optional) **2**.

- Connect your camcorder to the output jacks of a TV or VCR/DVD device.

2 If you are recording from a VCR/DVD device, insert the cassette or disc into the playback device.

3 Slide the POWER switch to turn on your camcorder and press  PLAY/EDIT.

4 Touch  → [REC CTRL].

If you connected your camcorder to the device which has the S VIDEO jack, touch [SET] → [VIDEO INPUT] → [S VIDEO] → .

- Touch [SET] to change the recording mode or adjust the volume.
- Touch [SET] →  REMAIN → [ON] to display the remaining disc indicator all the time.

5 Insert a blank disc into your camcorder.

Format the disc if you use a new DVD-RW/DVD+RW (p.60).

6 Start playing the cassette or the disc on the playback device, or select a TV program.

The picture played on the connected device appears on the LCD screen of your camcorder.

7 Touch [REC] at the point you want to start recording.

8 Touch  at the point you want to stop recording.

9 Touch [END].

- There may be a time difference between the point where you press [REC] and the actual point that the recording starts/stops.
- You cannot record a picture as a still image even if you press PHOTO during recording.

Printing recorded still images

(PictBridge compliant printer) (DCR-DVD405E/DVD805E)

You can print out still images using a PictBridge compliant printer without connecting the camcorder to a computer.

PictBridge

Connect your camcorder to the wall socket using the supplied AC Adaptor for this operation.

Insert the disc or “Memory Stick Duo” on which still images are stored into your camcorder and turn on the power of the printer.

Connect your camcorder to the printer

1 Slide the **POWER** switch to turn on your camcorder and press  **PLAY/EDIT**.

2 Connect the  (**USB**) jack of your camcorder to the printer using the **USB cable (supplied)**.



The [USB SELECT] screen appears on the LCD screen.

3 Touch  **PRINT**] to print still images from a disc or  **PRINT**] to print images from a “Memory Stick Duo.”

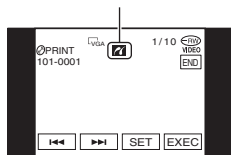

When connection is complete,  (PictBridge connecting) appears on the screen.





The still image appears.

- You can also display the [USB SELECT] screen by touching  → [SETUP] →  PICT.APPLI. → [USB SELECT].
- We cannot guarantee the operation of models that are not PictBridge compatible.

Printing



1 Select the image to be printed with  /  .

2 Touch  → [COPIES].

3 Select the number of copies to be printed with  /  .

You can set a maximum of 20 copies of one image to be printed.

4 Touch  → [END].

To print the date on the image, touch  → [DATE/TIME] → [DATE] or [DAY&TIME] → .

5 Touch  → [YES].

When printing is finished, [Printing...] disappears and the image selection screen appears again. You can continue printing another still image.

6 When printing is finished, touch  → [END].

- To print an image from a different media, touch [FUNC. SELECT] and start from step **3** in “Connect your camcorder to the printer.”

- Refer also to the instruction manual for the printer to be used.
- Do not attempt the following operations when  is on the screen. The operations may not be performed properly.
 - Operate the POWER switch.
 - Disconnect the USB cable (supplied) from the printer.
 - Slide the disc cover OPEN switch.
 - Remove the “Memory Stick Duo” from your camcorder.
- If the printer stops working, disconnect the USB cable (supplied), turn the printer off and on again and restart the operation from the beginning.
- If you print a still image recorded with a 16:9 (wide) ratio, left and right ends of the image may be cut off.
- Some printer models may not support the date printing function. Refer to your printer’s instruction manual for details.
- We cannot guarantee the printing of images recorded with a device other than your camcorder.
- Still images recorded by other devices that have a file size of 2MB or more, or are larger than 2304 × 1728 pixels cannot be printed.
- PictBridge is an industry standard established by the Camera & Imaging Products Association (CIPA). You can print still images without using a computer by connecting a printer directly to a digital video camera or digital still camera, regardless of model or manufacturer.

Jacks to connect external devices

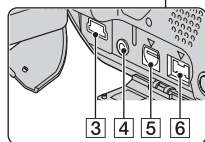
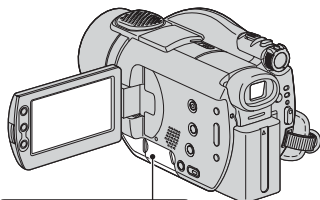
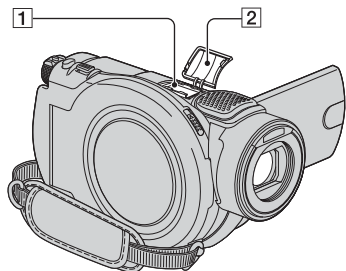

DCR-DVD405E/
DVD805E

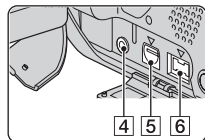

DCR-DVD404E

1...Open the shoe cover.

3 4 5 6...Open the jack cover.

1 Active Interface Shoe

The Active Interface Shoe supplies power to optional accessories such as a video light, a flash, or a microphone. The accessory can be turned on or off as you operate the POWER switch on your camcorder. Refer also to the instruction manual supplied with your accessory for details.

- The Active Interface Shoe has a safety device for fixing the installed accessory securely. To connect an accessory, press down and push it to the end, and then tighten the screw. To remove an accessory, loosen the screw, and then press down and pull out the accessory.
- When you are recording with the external flash (optional), turn off the power of the external flash to prevent charging noise being recorded.
- You cannot use an external flash (optional) and the built-in flash at the same time.
- When an external microphone (optional) is connected, it takes precedence over the internal microphone (p.42).

2 Shoe cover

3 ψ (USB) jack (p.94, 97)
(For DCR-DVD405E/DVD805E)

4 REMOTE jack

- Connect other optional accessories.

5 A/V (audio/video) jack (p.50, 90, 92)

6 DC IN jack (p.19)

Before referring to the “First Step Guide” on your computer

When you install the Picture Package or Nero Express 6 software on a Windows computer from the supplied CD-ROM, you can enjoy the following operations by connecting your camcorder to your computer.

- The Macintosh computer does not support the supplied Picture Package and Nero Express 6 software.
- The DCR-DVD404E does not support a computer connection. See “Playing back a disc on a computer with a DVD drive installed” (p.57) to play back images on your computer.
- You can copy the still images when connecting your camcorder to the Macintosh computer with the USB cable. Refer to “First Step Guide” in the supplied CD-ROM (p.102).

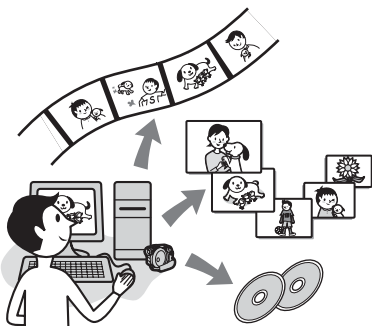

- The CD-ROM (supplied) includes the following software.
 - USB Driver
 - Picture Package Ver.1.8.1
 - Nero Express 6
 - “First Step Guide”

What you can do with Picture Package

■ Viewing and Handling Pictures → Picture Package DVD Viewer

You can view the movie and still images by selecting from thumbnails. Movies and still images are saved in folders by date.

You can delete unnecessary scenes of movies, or create 8cm DVDs with menus.

■ Music Video/Slideshow Producer → Picture Package Producer2

You can select your favorite movie and still images and easily create an original movie with added music and visual styles.

■ Duplicating to an 8cm DVD → Picture Package Duplicator

You can copy the disc you recorded with your camcorder to an 8cm DVD.

What you can do with Nero Express 6

■ When copying a disc to the 12cm DVD

You can copy the disc recorded with your camcorder to the 12cm DVD.

About “First Step Guide”

The “First Step Guide” is an instruction manual you can refer to on your computer. This describes basic operations, from initial hookup of your camcorder and computer and making settings, to general operation the first time you use the software, Picture Package, stored on the CD-ROM (supplied). After inserting the CD-ROM, referring to “Installing software and “First Step Guide”” (p.99), start the “First Step Guide”, then follow the instructions.

- Refer to the supplied instruction manual for details about Nero Express 6.

About the help function of the software

The Help guide explains all the functions of all the software applications. Refer to the Help guide for further detailed operations after reading the “First Step Guide” thoroughly. To display the Help guide, click the [?] mark on the screen.

System requirements

■ When using Windows computer

When using Picture Package on a computer

OS: Microsoft Windows 2000 Professional / Windows XP Home Edition / Windows XP Professional

Standard installation is required. Operation is not assured if the above OS has been upgraded.

CPU: Intel Pentium III 600MHz or faster (Pentium III 1GHz or faster recommended)

Application: DirectX 9.0c or later (This product is based on DirectX technology. It is necessary to have DirectX installed.)/ Windows Media Player 7.0 or later/ Macromedia Flash Player 6.0 or later

Sound system: 16 bit stereo sound card and stereo speakers

Memory: 128 MB or more (256 MB or more recommended)

Hard disk:

Available memory required for installation: 250 MB or more (2GB or more when using Picture Package Duplicator.)/

Available free hard disk space recommended: 6 GB or more (depending on the size of the image files edited)

Display: 4 MB VRAM video card, Minimum 800 × 600 dots, High color (16 bit color, 65 000 colors), DirectDraw display driver capability (this product will not operate correctly at 800 × 600 dots or less, and 256 colors or less.)

Others: Ψ (USB) port (this must be provided as standard)

When playing still images recorded on a “Memory Stick Duo” on a computer

OS: Microsoft Windows 2000 Professional/ Windows XP Home Edition/Windows XP Professional

Standard installation is required. Operation is not assured if the above OS has been upgraded.

CPU: MMX Pentium 200MHz or faster

Others: Ψ (USB) port (This must be provided as standard)

■ When using Macintosh computer

• You can only copy still images from the “Memory Stick Duo.”

OS: Mac OS 9.1/9.2 or Mac OS X (v10.1/v10.2/v10.3/v10.4)

Others: Ψ (USB) port (This must be provided as standard)

- Your camcorder is compatible with Hi-Speed USB (USB 2.0). You can transfer data at a faster rate using a computer compatible with Hi-Speed USB. When you connect a USB interface not compatible with Hi-Speed USB, the data transfer ratio will be that of USB 1.1 (USB full speed).
- Operations are not guaranteed on all the recommended environments.
- If your computer has a Memory Stick slot, insert the “Memory Stick Duo” on which still images are recorded into the Memory Stick Duo Adaptor (optional), then insert it into the Memory Stick slot on your computer to copy still images to the computer.
- When using a “Memory Stick PRO Duo” and your computer is not compatible with it, connect your camcorder with the USB cable instead of using the Memory Stick slot on the computer.

Installing software and “First Step Guide”

You need to install the software to your Windows computer **before connecting your camcorder to the computer**. The installation is required only for the first time. Contents to be installed and procedures may differ depending on your OS.

Using a Windows computer

1 Confirm that your camcorder is not connected to the computer.

2 Turn on the computer.

- Log on as Administrators for installation.
- Close all applications running on the computer before installing the software.

3 Place the supplied CD-ROM in the disc drive of your computer.

The installation screen appears.



- If the screen does not appear, follow the procedure below.
 - ① Double-click [My Computer] (If you are using Windows XP, click [Start], then [My Computer].)
 - ② Double-click [PICTUREPACKAGE] (Disc drive).*

* Drive names (such as (E:)) may vary depending on the computer.

4 Click [Install].



- Depending on the operating system on the computer, a message appears notifying you that “First Step Guide”TM cannot be installed automatically with the InstallShield Wizard. In such a case, manually copy “First Step Guide” to your computer according to the message’s instructions.

5 Select the language for the application to be installed, then click [Next].



6 Click [Next].



- 7** Read [License Agreement], check [I accept the terms of the license agreement] when you agree, then click [Next].



- 8** Select where to save the software, then click [Next].

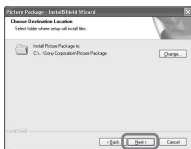

- 9** Select [PAL], then click [Install].

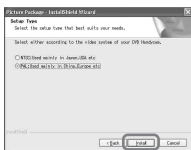

- 10** Click [Install] on the [Ready to Install the Program] screen.

The installation of Picture Package starts.



- 11** Click [Next], then follow the on-screen instructions to install the “First Step Guide.”

Depending on the computer, this screen may not be displayed. In such a case, skip to step 12.



- 12** Click [Next], then follow the on-screen instructions to install “ImageMixer EasyStepDVD.”



- 13** If the [Installing Microsoft (R) DirectX (R)] screen is displayed, follow the steps below to install DirectX 9.0c. If not, skip to step 14.

- ① Read [License Agreement], then click [Next].



- ② Click [Next].

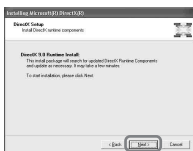

- ③ Click [Finish].



14 Make sure [Yes, I want to restart my computer now.] is checked, then click [Finish].



The computer turns off once, then starts up again automatically (Restart). The short-cut icons for [Picture Package Menu], [Picture Package Menu destination Folder] (and “First Step Guide,” if installed by step 11) appear on the desktop.

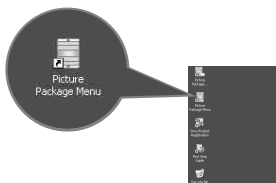

15 Remove the CD-ROM from the disc drive of your computer.

- For connecting your camcorder to the computer, see “First Step Guide” in the supplied CD-ROM.
- If you have any questions about PicturePackage, see “For inquiries about this software” (p.102).

Using a Macintosh computer

You can copy the still images from the “Memory Stick Duo” to the Macintosh computer. Install “First Step Guide” in the supplied CD-ROM.

- Refer to “First Step Guide” for the details on connecting your camcorder to the computer and copying the still images.

1 Confirm that your camcorder is not connected to the computer.

2 Turn on the computer.

Close all applications running on the computer before installing the software.

3 Place the supplied CD-ROM in the disc drive of your computer.

4 Double-click CD-ROM icon.

5 Copy “FirstStepGuide.pdf,” stored in the desired language in the [FirstStepGuide] folder, to your computer.

Viewing “First Step Guide”

Displaying “First Step Guide”

To view “First Step Guide” on your computer, Microsoft Internet Explorer Ver.6.0 or later is recommended. Double-click the  icon on the desktop.

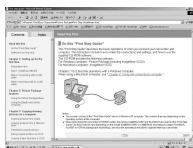

- You can also start by selecting [Start], [Programs] ([All Programs] for Windows XP), [Picture Package], and [First Step Guide], then start up [First Step Guide].
- To view “First Step Guide” in HTML without using automatic installation, copy the desired language folder from the [FirstStepGuide] folder on the CD-ROM, and then double-click [Index.html].
- Refer to “FirstStepGuide.pdf” in the following cases:
 - When printing “First Step Guide”
 - When “First Step Guide” is not displayed correctly due to the browser setting even in recommended environment.
 - When the HTML version of “First Step Guide” is not installed automatically.

To start up on a Macintosh computer

Double-click “FirstStepGuide.pdf”.



To view the PDF, Adobe Reader is needed. If it is not installed on your computer, you can download it from the Adobe Systems web page:
<http://www.adobe.com/>

For inquires about this software

Pixela User Support Center

Pixela Home Page
<http://www.ppackage.com/>

- North America (Los Angeles) Telephone:
(Toll-Free) +1-800-458-4029
+1-213-341-0163
- Europe (U.K.) Telephone:
(Toll-Free) U.K., Germany, France and Spain:
+800-1532-4865
Other countries:
+44-1489-564-764
- Asia (Philippines) Telephone:
+63-2-438-0090

On Copyrights

Music works, sound recording or other third party musical contents you may acquire from CDs, the Internet or other sources (the “Music Contents”) are the copyrighted work of the respective owners thereof and are protected by copyright laws and other applicable laws of each country/region. Except to the extent expressly permitted by applicable laws, you are not permitted to use (including, without limitation, copying, modifying, reproducing, uploading, transmitting or placing to the external network accessible to the public, transferring, distributing, lending, licensing, selling and publishing) any of the Music Contents without obtaining authorization or approval of the respective owners thereof. License of Picture Package by Sony Corporation would not be construed as conferring to you by implication, estoppel or otherwise, any license or right to use the Music Contents.

Troubleshooting

If you run into any problems using your camcorder, use the following table to troubleshoot the problem. If the problem persists, remove the power source and contact your Sony dealer.

Overall operations/Easy Handycam

The camcorder does not operate even when the power is set to on.

- Disconnect the AC Adaptor from the wall socket or remove the battery pack, then reconnect it after about 1 minute. If the functions still do not work, press the RESET button (p.45) using a sharp-pointed object. (If you press the RESET button, all settings, including the clock setting, are reset, except the Personal Menu items.)
- The temperature of your camcorder is extremely high. Turn off your camcorder and leave it for a while in a cool place.

Buttons do not work.

- During Easy Handycam operation, the available buttons are limited. Cancel Easy Handycam operation (p.31).

You cannot turn Easy Handycam operation on or off.

- You cannot turn Easy Handycam operation on or off while recording or communicating with another device via USB cable (For DCR-DVD405E/DVD805E). Cancel Easy Handycam operation (p.31).

Settings change during Easy Handycam operation.

- Some of the settings of your camcorder are restored to the default setting when you set Easy Handycam operation (p.31).

[DEMO MODE] does not start.

- You cannot view the demonstration when the NIGHTSHOT switch is set to ON. Set the NIGHTSHOT switch to OFF (p.43).
- Remove the disc and “Memory Stick Duo” from your camcorder (p.27, 28).
- Set the POWER switch to  (Movie).

Your camcorder vibrates.

- Vibration occurs depending on the condition of the disc. This is not a malfunction.

A vibration is felt in your hand or a faint sound is heard during operation.

- This is not a malfunction.

A motor sound is heard from your camcorder periodically.

- This is not a malfunction.

A motor sound is heard in the camcorder when the disc cover is closed without a disc.

- Your camcorder recognizes the disc. This is not a malfunction.

Your camcorder gets warm.

- This is because the power has been turned on for a long time. This is not a malfunction. Turn off your camcorder and leave it for a while in a cool place.

Batteries/Power sources

The power does not turn on.

- The battery pack is not attached to the camcorder. Attach a charged battery pack to the camcorder (p.19).
- The battery pack is discharged or running low. Charge the battery pack (p.19).
- The plug of the AC Adaptor has been disconnected from the wall socket. Connect it to the wall socket (p.19).

The power abruptly turns off.

- When approximately 5 minutes have elapsed while you do not operate your camcorder, the camcorder is automatically turned off (A.SHUT OFF). Change the setting of [A.SHUT OFF] (p.78), or turn on the power again, or use the AC Adaptor.
- The battery pack is discharged or running low. Charge the battery pack (p.19).

The CHG (charge) lamp does not light while the battery pack is being charged.

- Slide the POWER switch to OFF (CHG) (p.19).
- Attach the battery pack to the camcorder correctly (p.19).
- Connect the mains lead to the wall socket properly.
- The battery charge is completed (p.19).

The CHG (charge) lamp flashes while the battery pack is being charged.

- Attach the battery pack to the camcorder correctly (p.19). If the problem persists, disconnect the AC Adaptor from the wall socket and contact your Sony dealer. The battery pack may be damaged.

The power turns off frequently although the remaining battery indicator indicates that the battery pack has enough power to operate.

- A problem has occurred in the remaining battery time indicator, or the battery pack has not been charged enough. Fully charge the battery again to correct the indication (p.19).

The remaining battery time indicator does not indicate the correct time.

- The temperature of the environment is too high or too low. This is not a malfunction.
- The battery pack has not been charged enough. Fully charge the battery again. If the problem persists, replace the battery pack with a new one (p.19).
- The indicated time may not be correct depending on the environment of use. When you open or close the LCD screen, it takes about 1 minute to display the correct remaining battery time.

The battery pack is quickly discharged.

- The temperature of the environment is too high or low. This is not a malfunction.
- The battery pack has not been charged enough. Fully charge the battery again. If the problem persists, replace the battery pack with a new one (p.19).

A problem occurs when the camcorder is connected to the AC Adaptor.

- Turn off the power, and disconnect the AC Adaptor from the wall socket. Then, connect it again.

LCD screen/viewfinder

An unknown picture appears on the screen.

- The camcorder is in [DEMO MODE] (p.74). Touch the LCD screen or insert a disc or “Memory Stick Duo” to cancel [DEMO MODE].

An unknown indicator appears on the screen.

- They may be warning indicators or messages (p.121).

The picture remains on the LCD screen.

- This occurs if you disconnect the AC Adaptor from the wall socket or remove the battery pack without turning off the power first. This is not a malfunction.

You cannot turn the LCD backlight off.

- During Easy Handycam operation (p.31), you cannot turn the LCD backlight on/off pressing and holding DISP/BATT INFO.

The buttons do not appear on the touch panel.

- Touch the LCD screen lightly.
- Press DISP/BATT INFO on your camcorder (or DISPLAY on the Remote Commander) (p.24, 49).

The buttons on the touch panel do not work correctly or do not work at all.

- Adjust the screen ([CALIBRATION]) (p.134).

The picture in the viewfinder is not clear.

- Use the viewfinder lens adjustment lever to adjust the lens (p.23).

The picture in the viewfinder has disappeared.

- The picture is not displayed in the viewfinder when the LCD screen is open. Close the LCD screen (p.23).

Disc

The disc cannot be removed.

- Make sure the power source (battery pack or AC Adaptor) is connected correctly (p.19).
- Remove the battery pack from the camcorder, then attach it again (p.20).
- Attach a charged battery pack to the camcorder (p.19).
- The disc is damaged or is dirty with fingerprints, etc. In this case, it may take up to 10 minutes to remove the disc.
- The temperature of your camcorder is extremely high. Turn off your camcorder and leave it for a while in a cool place.
- Moisture condensation has occurred with the disc. Turn off your camcorder and leave it for about 1 hour (p.133).
- Finalizing is interrupted by turning off your camcorder. Turn on your camcorder and remove the disc after finalizing is completed (p.52).

Remaining disc space indicator is not displayed.



- Set [REMAINING] to [ON] to always display the remaining disc space indicator (p.77).

The indicators of the disc type and the recording format on the LCD screen are grayed out.

- The disc may be created other than your camcorder. You can play back with your camcorder, but you cannot record additional scenes.

“Memory Stick Duo”

You cannot operate functions using the “Memory Stick Duo.”

- Slide the POWER switch to light up the  (Still) lamp or press  PLAY/EDIT with your camcorder switched on (p.22).
- Insert a “Memory Stick Duo” into your camcorder (p.28).
- If you use a “Memory Stick Duo” formatted on a computer, format it on your camcorder (p.74).

Still images cannot be deleted.

- Release the lock on the write-protect tab of the “Memory Stick Duo.” (p.129)
- On the Review screen only the most recently recorded image can be deleted (p.46).
- On the Edit screen only up to 100 images to be deleted can be selected at once.
- Images protected by another device cannot be deleted. Use the original device to cancel the protection.

You cannot delete all still images at once.

- Release the lock on the write-protect tab of the “Memory Stick Duo” (p.129).

You cannot format the “Memory Stick Duo.”

- Release the lock on the write-protect tab of the “Memory Stick Duo” (p.129).

The data file name is not indicated correctly.

- Only the file name is displayed if the directory structure does not conform to the universal standard.
- The file is damaged.
- The file format is not supported on your camcorder (p.129).



The data file name flashes.

- The file is damaged.
- The file format is not supported on your camcorder (p.129).

Recording

Refer also to “Adjusting the image during recording” (p.109).

Pressing START/STOP or PHOTO does not record movies/still images on the disc.

- The playback screen appears. Press  PLAY/EDIT or touch  on the LCD screen to display the recording screen (p.34, 40).
- Your camcorder is recording the scene you have just shot on the disc. You cannot press PHOTO while [CAPTURE] or  appears on the LCD screen (p.33, 39).
- The disc has run out of space. Use a new disc or format the disc (DVD-RW/DVD+RW only, p.60). Or delete the unnecessary images (p.85).
- The DVD-RW (VIDEO mode)/DVD+RW has been finalized. Make a disc to be able to record additional scenes (p.59).
- The temperature of your camcorder is extremely high. Turn off your camcorder and leave it for a while in a cool place.
- Moisture condensation has occurred with the disc. Turn off your camcorder and leave it for about 1 hour (p.133).

You cannot record on the “Memory Stick Duo.”

- Release the lock on the write-protect tab of the “Memory Stick Duo” (p.129).
- The “Memory Stick Duo” has run out of space. Use a new “Memory Stick Duo” or format the “Memory Stick Duo” (p.74). Or delete the unnecessary images (p.84).

The ACCESS lamp lights up even when you stop recording.

- Your camcorder is recording the scene you have just shot on the disc.



The recording angle differs depending on the POWER switch setting position.

- The recording angle for the still image is wider than the one for the movie.

The shutter sound is not heard when you record a still image.

- Set [BEEP] to [ON] (p.78).

The flash does not work.

- You cannot record with the flash with:
 - During recording movies
 - [SUPER NS]
 - [COLOR SLOW S]
 - [D. EFFECT]
 - [ BURST]
 - The conversion lens (optional) attached
 - Even if auto flash or  (Auto redeye reduction) is selected, you cannot use the internal flash with:
 - NightShot
 - [SPOTLIGHT], [SUNSET&MOON] or [LANDSCAPE] in [PROGRAM AE]
 - [EXPOSURE]
 - [SPOT METER]
-

The external flash (optional) does not work.

- The power of the flash is not turned on, or the flash is not attached correctly.
-

The actual recording time for movie is less than the expected approximate recording time.

- When you record an object that moves fast, the time available for recording may shorten (p.15, 75).
-

The recording stops.

- The temperature of your camcorder is extremely high. Turn off your camcorder and leave it for a while in a cool place.
 - Moisture condensation has occurred with the disc. Turn off your camcorder and leave it about 1 hour in a cool place (p.133).
-

There is a time difference between the point where you press START/STOP and the point that the recorded movie starts/stops.

- On your camcorder, there may be a slight time difference between the point where you press START/STOP and the actual point that recording movie starts/stops. This is not a malfunction.
-

The movie aspect ratio cannot be changed.

- The aspect ratio of a DVD+RW disc cannot be changed. Format the disc again to change the movie aspect ratio.

Adjusting the image during recording

Refer also to “Setup items” (p.111).

The auto focus does not function.

- Set [FOCUS] to [AUTO] (p.68).
- The recording conditions are not suitable for auto focus. Adjust the focus manually (p.68).

[STEADYSHOT] does not function.

- Set [STEADYSHOT] to [ON] (p.70).
- [STEADYSHOT] may not work for an excessive camera shake even if [STEADYSHOT] is set to [ON].

The back light function does not function.

- The back light function is canceled when you set [EXPOSURE] to [MANUAL] (p.67) or select [SPOT METER] (p.66).
- The back light function does not work during Easy Handycam operation. Cancel Easy Handycam operation (p.31).

A vertical band appears when recording candlelight or electric light in the dark.

- This occurs when the contrast between the subject and the background is too high. This is not a malfunction.

A vertical band appears when recording a bright subject.

- This phenomenon is called the smear effect. This is not a malfunction.

Tiny spots in white, red, blue, or green appear on the screen.

- The spots appear when you are recording in [SUPER NS] or [COLOR SLOW S]. This is not a malfunction.

The color of the picture is not correctly displayed.

- Set the NIGHTSHOT switch to OFF (p.43).

The picture appears too bright on the screen, and the subject does not appear on the screen.

- Set the NIGHTSHOT switch to OFF (p.43).

The picture appears too dark on the screen, and the subject does not appear on the screen.

- The LCD screen backlight is switched off. Turn on the LCD backlight by pressing and holding DISP/BATT INFO (p.23).

Flickering or changes in color occurs.

- This occurs when recording pictures under a fluorescent lamp, sodium lamp, or mercury lamp with [PORTRAIT] or [SPORTS]. Cancel [PROGRAM AE] in this case (p.66).

Black bands appear when you record a TV screen or computer screen.

- Set [STEADYSHOT] to [OFF] (p.70).

Remote Commander

The supplied Remote Commander does not function.

- Set [REMOTE CTRL] to [ON] (p.78).
- Insert a battery into the battery holder with the +/- polarities correctly matching the +/- marks (p.135).
- Remove any obstructions between the Remote Commander and the remote sensor.
- Point the remote sensor away from strong light sources such as direct sunlight or overhead lighting. Otherwise, the Remote Commander may not function properly.
- Remove the conversion lens (optional) as the remote sensor may be obstructed by it.

Another DVD device malfunctions when you use the supplied Remote Commander.

- Select a commander mode other than DVD 2 for your DVD device, or cover the sensor of your DVD device with black paper.

Playing back a disc on your camcorder

You cannot play back a disc.

- Slide the POWER switch to turn on your camcorder and press  PLAY/EDIT.
- Check out the disc compatibility (p.14).
- Insert a disc with the recording side facing your camcorder (p.26).
- The disc recorded in other devices may not be played back on your camcorder.

The playback picture is distorted.

- Clean the disc using the cleaning cloth (supplied, p.128).

Still images stored on a “Memory Stick Duo” are not played back in the actual size.

- Still images recorded on other devices may not appear in the actual size. This is not a malfunction.

Still images stored on a “Memory Stick Duo” cannot be played back.

- Still images cannot be played back if you have modified files or folders, or have edited the data on a computer. (The file name flashes in that case.) This is not a malfunction (p.130).
- Still images recorded on other devices may not be played back. This is not a malfunction (p.130).

“?” is indicated on an image in the VISUAL INDEX screen.

- Clean the disc using the cleaning cloth (supplied, p.128).
- Loading of the data may have failed. It may be indicated correctly when you turn off the power and then turn it on again, or remove the disc once and set it again.
- This may appear on still images taken with other devices, edited on a computer, etc.

No sound or only a low sound is heard when playing back a disc.

- Set [MULTI-SOUND] to [STEREO] (p.75).
- Turn up the volume (p.41).
- Sound is not output when the LCD screen is closed. Open the LCD screen.
- When you record sound with [MICREF LEVEL] (p.75) set to [LOW], the recorded sound may be difficult to hear.

Playing back a disc on other devices**You cannot play back the disc or a disc cannot be recognized.**

- Clean the disc using the cleaning cloth (supplied, p.128).
- Finalize the disc (p.52).
- A disc recorded in VR mode cannot be played back on a device that does not support VR mode. Check the compatibility in the instruction manual of the playback device.

The playback picture is distorted.

- Clean the disc using the cleaning cloth (supplied, p.128).

“?” is indicated on an image in the DVD menu.

- Loading of the data may have failed when the disc was finalized. For DVD-RW (VIDEO mode)/DVD+RW, make the disc capable of additional recording (p.59), then remake the DVD menu by finalizing the disc again (p.55). The DVD menu may be displayed correctly.

Playback freezes for an instant between the scenes.

- The image may freeze for an instant between scenes depending on the DVD device being used. This is not a malfunction.

Playback does not move to the previous scene when you press I◀◀.

- If playback crosses 2 titles made automatically by your camcorder when I◀◀ is pressed, playback may not move to the previous scene. Select the desired scene from the menu screen. Refer to the instruction manual of the playback device for further information.

Setup items**Setup items are grayed out.**

- You cannot select grayed items in the current situation.

[P-MENU] is not displayed.

- You can operate limited operations during Easy Handycam operation. Cancel Easy Handycam operation (p.31).

You cannot use [PROGRAM AE].

- You cannot use [PROGRAM AE] together with:
 - NightShot
 - [SUPER NS]
 - [COLOR SLOW S]
 - [OLD MOVIE]
 - [SPORTS] will not work when the POWER switch is set to  (Still).
-

You cannot use [SPOT METER].

- You cannot use [SPOT METER] together with:
 - NightShot
 - [SUPER NS]
 - [COLOR SLOW S]
 - If you set [PROGRAM AE], [SPOT METER] is automatically set to [AUTO].
-

You cannot use [EXPOSURE].

- You cannot use [EXPOSURE] together with:
 - NightShot
 - [SUPER NS]
 - [COLOR SLOW S]
 - If you set [PROGRAM AE], [EXPOSURE] is automatically set to [AUTO].
-

You cannot use [WHITE BAL.].

- You cannot use [WHITE BAL.] together with:
 - NightShot
 - [SUPER NS]
-

You cannot use [SPOT FOCUS].

- You cannot use [SPOT FOCUS] together with [PROGRAM AE].
-

You cannot use [SUPER NS].

- The NIGHTSHOT switch is not set to ON.
- You cannot use [SUPER NS] together with:
 - [FADER]
 - [D. EFFECT]

[COLOR SLOW S] does not operate correctly.

- [COLOR SLOW S] may not operate correctly in total darkness. Use NightShot or [SUPER NS].
- You cannot use [COLOR SLOW S] together with:
 - [FADER]
 - [D. EFFECT]
 - [PROGRAM AE]
 - [EXPOSURE]
 - [SPOT METER]

You cannot use [SELF-TIMER].

- You cannot use [SELF-TIMER] together with [FADER].

You cannot use [FADER].

- You cannot use [FADER] together with:
 - [SUPER NS]
 - [COLOR SLOW S]
 - [D. EFFECT]

You cannot use [D. EFFECT].

- You cannot use [D. EFFECT] together with:
 - [SUPER NS]
 - [COLOR SLOW S]
 - [FADER]
- You cannot use [OLD MOVIE] together with:
 - [PROGRAM AE]
 - [PICT. EFFECT]



You cannot use [PICT.EFFECT].

- You cannot use [PICT.EFFECT] together with [OLD MOVIE].

You cannot view [SUR MONITOR].

- You cannot view the [SUR MONITOR] either you are not recording in 5.1ch surround recording or together with [FADER].

You cannot adjust [LCD BL LEVEL].

- You cannot adjust [LCD BL LEVEL] when power is supplied from the AC Adaptor, or when you turn the LCD panel facing out on your camcorder when the POWER switch is set to  (movie) or  (Still).

Editing for movies and still images on the disc (DVD-RW:VR mode)

You cannot edit a DVD-R/DVD-RW (VIDEO mode)/DVD+RW with your camcorder.

Unable to edit.

- There are no images recorded on the disc.
- Unable to edit because of the condition of the image.
- You cannot edit an image protected on another device.

Scenes cannot be added in the Playlist.

- The disc is full, or the added scenes exceed 999. Delete unnecessary scenes or add all the still images by converting them to a movie (Photomovie, p.88).

A movie cannot be divided.

- A movie that is too short cannot be divided.
- A movie with a  mark cannot be divided (p.85, 88).
- A movie protected on another device cannot be divided.

A scene cannot be deleted.

- A scene protected on another device cannot be deleted.

Dubbing/Connecting to other devices

The aspect ratio of the playback is not correct when connecting your camcorder to the TV.

- Set [TV TYPE] depending on your TV (p.50).

Pictures from connected devices are not displayed on the LCD screen or the viewfinder (For DCR-DVD405E/DVD805E).

- Touch  → [REC CTRL] (p.92).

Pictures from connected devices cannot be zoomed (For DCR-DVD405E/DVD805E).

- You cannot zoom scenes input from the other device on your camcorder.

No sound is heard when playing back a disc.

- The audio will not be output when you connect a device via the S VIDEO plug only. Connect the white and red plugs of the A/V connecting cable, too (p.92).

You cannot dub correctly using the A/V connecting cable.

- The A/V connecting cable is not connected properly. Make sure that the A/V connecting cable is connected to the proper jack, i.e. to the output jack of a device you are dubbing a picture from, or to the input jack of another device for dubbing a picture from your camcorder (p.90, 92).

You cannot copy the disc to the 12cm DVD.

- Use the supplied software, Nero Express 6. Refer to the instruction manual supplied with Nero Express 6 for details.

Prints cannot be made using a PictBridge printer (For DCR-DVD405E/DVD805E).

- Your printer may not print images recorded using other devices. This is not a malfunction.

Others

You cannot delete an image.

- You cannot delete images from a DVD-R.
- With a DVD-RW (VIDEO mode)/DVD+RW, you can only delete the most recently recorded image (p.46).
- You cannot delete images from a “Memory Stick Duo” that has been protected with another device.

Unable to copy still images.

- You cannot copy still images to a DVD-R/DVD-RW (VIDEO mode)/DVD+RW that has been finalized. Follow the required procedure to record additional material on the DVD-RW (VIDEO mode)/DVD+RW (p.59).
- There is not enough capacity for the disc or “Memory Stick Duo” to be copied. Delete unwanted images (p.84, 85).
- When the destination is “Memory Stick Duo” with the lock on the write-protect tab, release the lock on the write-protect tab of the “Memory Stick Duo” (p.129).
- You may not copy still images recorded/edited using other devices.

Unable to finalize.

- Battery is running out during finalizing. Use the AC Adaptor.
- The disc has already been finalized. If you are using a DVD-RW (VIDEO mode)/DVD+RW, follow the required procedure to record additional material on the disc (p.59).

You cannot edit or record additional material on a disc using other devices.

- You may not be able to edit a disc recorded on your camcorder using other devices.

The disc title cannot be changed.

- You cannot record a disc title on a finalized DVD-R.
- The disc has already been finalized. If you are using a DVD-RW (VIDEO mode)/DVD+RW, follow the required procedure to record additional material on the disc (p.59).
- The disc title may not be changed on your camcorder if the disc title has been made by another device.

A Photomovie cannot be created.

- There are no still images.
- There may be a lot of still images on a disc and the remaining disc capacity is low. Delete unnecessary images from the disc (p.85).

The beep sounds for 5 seconds.

- The temperature of your camcorder is extremely high. Turn off your camcorder and leave it for a while in a cool place.
 - Moisture condensation has occurred with the disc. Turn off your camcorder and leave it for about 1 hour, then turn on your camcorder again (p.133).
 - Some problems have occurred in your camcorder. Remove the disc and insert it again, then operate your camcorder again.
-

Unable to unfinalize.

- You cannot unfinalize a DVD-R/DVD-RW (VR mode)/DVD+RW (p.59).
 - Your camcorder is in Easy Handycam operation. Cancel Easy Handycam operation (p.31) to unfinalize a disc (p.59).
-

Connecting to a computer (DCR-DVD405E/DVD805E)

The computer does not recognize your camcorder.

- Disconnect the cable from the computer and camcorder, then connect it again firmly.
 - Disconnect USB device other than the keyboard, the mouse, and the camcorder from the computer.
 - Disconnect the cable from the computer and camcorder, restart the computer, then connect them again correctly.
-

When editing the images in the disc, the computer does not recognize your camcorder.

- Install the Picture Package software (p.99).
- Confirm the USB driver is correctly installed with the following procedures.

For Windows XP

- 1 Click [Start], then [Control Panel].
- 2 Click [Performance and Maintenance], then [System].
The [System Properties] window appears.
- 3 Click [Hardware] tab.
- 4 Click [Device Manager].
The [Device Manager] window appears.
- 5 Make sure that [SONY DDX-C1002 USB Device] appears in [DVD/CD-ROM drives], [Generic volume] in [Storage volumes], and [USB Mass Storage Device] in [Universal Serial Bus controllers] respectively.

When all the devices appear, the USB driver is installed correctly. If any of these devices are not shown, install USB driver.

- ① Place the supplied CD-ROM in the disc drive on your computer.
- ② Double-click [My Computer].
- ③ Right-click [PICTUREPACKAGE] icon (Disc drive)*, then click [Open].

*Drive names (such as (E:)) may vary depending on the computer.

- ④ Double-click [Driver] → [Setup.exe].

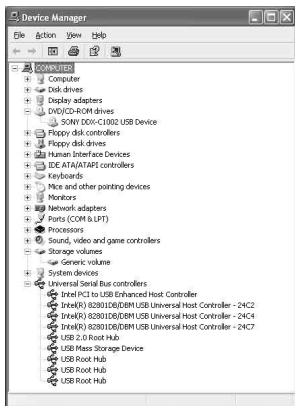

For Windows 2000

- 1 Click [Start], [Settings], then [Control Panel].

- 2 Click [System].

The [System Properties] window appears.

- 3 Click [Hardware] tab.

- 4 Click [Device Manager].

The [Device Manager] window appears.

- 5 Make sure that [SONY DDX-C1002 USB Device] appears in [DVD/CD-ROM drives], [Generic volume] in [Storage volumes], and [USB Mass Storage Device] in [Universal Serial Bus controllers] respectively.

When all the devices appear, the USB driver is installed correctly. If any of these devices are not shown, install USB driver.

- ① Place the supplied CD-ROM in the disc drive on your computer.

- ② Double-click [My Computer].

- ③ Right-click [PICTUREPACKAGE] icon (Disc drive)*, then click [Open].

*Drive names (such as (E:)) may vary depending on the computer.

- ④ Double-click [Driver] → [Setup.exe].

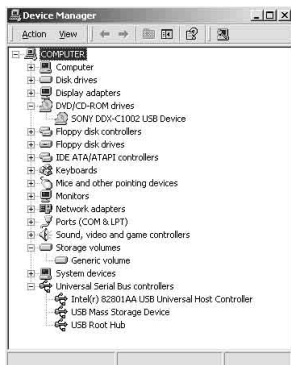



An error message appears when you place the supplied CD-ROM in your computer.

- Set the computer display as follows:
 - 800 × 600 dots or more, High Color (16 bits, 65 000 colors) or more

You cannot use the supplied CD-ROM on a Macintosh computer.

- The supplied software Picture Package is not compatible with a Macintosh computer.



You cannot view images recorded on your camcorder.

- Make sure to insert the connector in the correct direction, then connect the USB cable to the ψ (USB) jack on your camcorder firmly.
- Turn on your camcorder and press  PLAY/EDIT.
- Select [USB SELECT] →  COMPUTER in the menu settings of your camcorder (p.73).
- Disconnect the USB device other than the keyboard, mouse, and camcorder from the computer.

You cannot view the still images recorded on a “Memory Stick Duo” on the computer.

- Insert the “Memory Stick Duo” in the correct direction firmly.
- Select [USB SELECT] →  COMPUTER in the menu settings of your camcorder (p.73).
- The computer does not recognize the “Memory Stick Duo” during camcorder operation such as disc playback or editing. Finish camcorder operation before connecting the camcorder to the computer again.

The “Memory Stick” icon ([Removable Disk]) does not appear on the computer.

- Turn on your camcorder and press  PLAY/EDIT.
- Insert a “Memory Stick Duo” into your camcorder.
- Disconnect the USB device other than the keyboard, mouse, and camcorder from the computer.
- Select [USB SELECT] →  COMPUTER in the menu settings of your camcorder (p.73).

- The computer does not recognize the “Memory Stick Duo” during camcorder operation such as disc playback or editing. Finish camcorder operation before connecting the camcorder to the computer again.

[Cannot start Easy Handycam with USB connected] or [Cannot cancel Easy Handycam with USB connected] appears on the screen of your camcorder.

- You cannot start or cancel Easy Handycam operation while the USB cable is connected. Disconnect the USB cable from your camcorder first.

You cannot transfer image data from your camcorder to a computer.

- Set [USB SPEED] to [FULL SPEED] in setup item (p.76).

The images or sound of your camcorder cannot be played back correctly.

- When you connect your camcorder to a computer not compatible with Hi-Speed USB (USB 2.0), it may not be able to be played back correctly. However, it does not effect to the images or sounds transferred to your computer.
- When you set [USB SPEED] to [FULL SPEED] (p.76), it may not be able to be played back correctly. However, it does not effect to the images or sounds transferred to your computer.
- Depending on the computer you use, the played back image or sound may stop temporarily, but this does not effect the images or sound transferred to your computer.

You cannot write data from your computer on a disc in your camcorder using the USB cable.

- The disc is not compatible with your camcorder. Use a disc compatible with your camcorder (p.14).
- You cannot write data from other than the Picture Package on a disc in your camcorder.

The file transferred from the computer is not written to the “Memory Stick Duo” in your camcorder.

- The USB cable is not removed with the right procedure. Connect your camcorder to the computer again and transfer the data.

Picture Package does not function correctly.

- Close Picture Package, then restart the computer.
- Confirm the OS that supports Picture Package (p.98).

An error message appears while operating Picture Package.

- Close Picture Package first, then slide the POWER switch on your camcorder to turn on another lamp.

You cannot copy the disc to the 12cm DVD using Picture Package.

- Use the supplied software, Nero Express 6. Refer to the instruction manual supplied with Nero Express 6 for details.

The “First Step Guide” is not displayed correctly.

- Follow the procedure below and refer to “First Step Guide” (FirstStepGuide.pdf).
 - 1** Place the supplied CD-ROM in the disc drive of your computer.
 - 2** Double-click [My Computer].
 - 3** Right-click [PICTUREPACKAGE] (Disc drive)*.
*Drive names (such as (E:)) may vary depending on the computer.
 - 4** Click [Explorer].
 - 5** Double-click [FirstStepGuide].
 - 6** Double-click the desired language folder.
 - 7** Double-click “FirstStepGuide.pdf.”

Warning indicators and messages

Self-diagnosis display/Warning indicators

If indicators appear on the LCD screen or in the viewfinder, check the following. Some symptoms you can fix by yourself. If the problem persists even after you have tried a couple of times, contact your Sony dealer or local authorized Sony service facility.

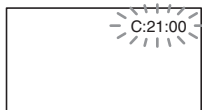

C:(or E:) □□:□□ (Self-diagnosis display)

C:04:□□

- The battery pack is not an “InfoLITHIUM” battery pack. Use an “InfoLITHIUM” battery pack. Use an “InfoLITHIUM” battery pack (p.131).
- Connect the DC plug of the AC Adaptor to the DC IN jack of your camcorder securely (p.19).

C:13:□□

- The disc is faulty. Use a compatible disc with your camcorder (p.14).
- The disc is dirty or has scratches on it. Clean the disc with the supplied cleaning cloth (p.128).

C:21:□□

- Moisture condensation has occurred with the disc. Turn off your camcorder and leave it for about 1 hour (p.133).

C:32:□□

- Symptoms that are not described above have occurred. Remove the disc and insert it again, then operate your camcorder again.
- Remove the power source. Reconnect it again and operate your camcorder again.

E:20:□□ / E:31:□□ / E:40:□□ /
E:61:□□ / E:62:□□ / E:91:□□ /
E:94:□□

- A malfunction that you cannot service has occurred. Contact your Sony dealer or local authorized Sony service facility. Inform them of the 5-digit code, which starts from “E.”

100-0001 (Warning indicator pertaining to files)

Slow flashing



- The file is damaged.
- The file is unreadable.

(Warning indicator pertaining to discs)

Slow flashing

- A disc is not inserted.*
- Less than 5 minutes remains for recording movies.
- Fewer than 30 images can be accommodated in the remaining space.

Fast flashing

- An unrecognizable disc is inserted.*
- A finalized DVD-RW (VIDEO mode)/DVD+RW is inserted into your camcorder when you slide the POWER switch to light up  (Movie) or  (Still).*
- The disc is fully recorded.*
- A disc that cannot be read or written is inserted, such as the single-sided disc inserted inside out.
- The disc recorded in the different TV color system from your camcorder is inserted when  (Movie) is selected.*

You need to remove the disc*

Fast flashing

- An unrecognizable disc is inserted.
- The disc is fully recorded.
- An error might have occurred with the disc drive in your camcorder.

(Battery level warning)

Slow flashing

- The battery pack is nearly used up.
- Depending on the operating environment or battery conditions,  may flash, even if there are approximately 20 minutes remaining.

(Moisture condensation warning)*

Fast flashing

- Moisture condensation has occurred with the disc. Turn off your camcorder and leave it for about 1 hour (p.133).

(High temperature warning)

Slow flashing

- The temperature of your camcorder is getting higher.

Fast flashing

- The temperature of your camcorder is extremely high.* Turn off your camcorder and leave it for a while in a cool place.

(Warning indicator pertaining to “Memory Stick Duo”)

- “Memory Stick Duo” is not inserted (p.28).

(Warning indicators pertaining to “Memory Stick Duo”)*

- The “Memory Stick Duo” is damaged.
- The “Memory Stick Duo” is not formatted correctly (p.75, 129).

(Warning indicator pertaining to incompatible “Memory Stick Duo”)*

- An incompatible “Memory Stick Duo” is inserted (p.129).

(Warning indicator pertaining to the write-protect of the “Memory Stick Duo”)*

- The write-protect tab on the “Memory Stick Duo” is set to lock (p.129).

(Warning indicator pertaining to the flash)*

Slow flashing

- Still charging.

Fast flashing

- There is something wrong with the flash.

(Warning indicator pertaining to camera-shake warning)

- The amount of lights is not sufficient, so camera-shake easily occurs. Use the flash.
- The camcorder is unsteady, so camera-shake easily occurs. Hold the camcorder steady with both hands and shoot the image. However, note that the camera-shake warning indicator does not disappear.

* You hear a melody when the warning indicators appear on the screen (p.78).

Description of warning messages

If messages appear on the screen, follow the instructions.

■ Battery

Use the “InfoLITHIUM” battery pack. (p.131)

Battery level is low. (p.19, 131)

Old Battery. Use a new one. (p.131)

■ Drive

▲ Drive error. Turn on power again.

- A problem may have occurred with the disc drive. Turn off and then on again.

■ Moisture condensation

 **Moisture condensation. Turn off for 1H.** (p.133)

 **Condensation. Cannot open. Remove disc later.** (p.133)

■ Disc

 **Overheated. Recording on disc disabled.**

 **Overheated. Cannot open. Try later.**

 **Recording on disc disabled.**

- A malfunction has occurred with the disc and it cannot be used.

 **Disc movie area full. Cannot record movies.**

- Delete unnecessary scenes (p.85).

 **Scene number on disc is full.**

- Delete unnecessary scenes (p.85).

 **Disc full. Cannot record.**

- Delete unnecessary scenes (p.85).

 **Movie recording disabled.**

- Movies cannot be recorded due to some limitations of the disc. However, you might be able to record still images.

 **Still recording on disc disabled.**

- Still images cannot be recorded due to some limitations of the disc. However, you might be able to record movies.

Playback prohibited.

- You are trying to play back an incompatible disc with your camcorder.
-

 **Disc finalized. Cannot record on disc.**

- A finalized DVD-R cannot be recorded. Use a new disc.
-

 **Need to unfinalize disc.**

- To record on the finalized DVD-RW (VIDEO mode), unfinalize it (p.59).
-

Cannot change movie aspect ratio on DVD+RW. (p.60)

Records movies in 16:9. Format to set. (p.60)

Records movies in 4:3. Format to set. (p.60)

 **Insert a disc or change STILL MEDIA to Memory Stick.** (p.26, 33, 39)

Unknown disc. Cannot record.

Cannot recover data. Please format disc.

 **Disc error. Remove disc.**

- The incompatible disc with your camcorder is inserted. Your camcorder cannot recognize the disc because of malfunctions such as scratches, or the disc situation is not set correctly.
-

 **Disc error. Unsupported format.**

- The disc recorded in the different format code from your camcorder. Formatting the disc may enable you to use the disc on your camcorder (DVD-RW/ DVD+RW only) (p.60).
-

Data error.

- An error occurred during reading or writing the disc.
-

Access error.

- An error occurred during reading or writing the disc.
-

■ “Memory Stick Duo”

Reinsert the Memory Stick.

- Reinsert the “Memory Stick Duo” a few times. If even then the indicator flashes, the “Memory Stick Duo” can be damaged. Try with another “Memory Stick Duo.”

This is a read-only Memory Stick.

- Insert a writable “Memory Stick Duo.”

Incompatible type of Memory Stick.

- A type of “Memory Stick Duo” incompatible with your camcorder is inserted (p.129).

This Memory Stick is not formatted correctly.

- Check the format, then format the “Memory Stick Duo” with your camcorder if necessary (p.74, 129).

Cannot record. The Memory Stick is full.

- Delete unnecessary images (p.84).

Cannot record still images on Memory Stick. (p.129)

The Memory Stick is locked. Check the tab. (p.129)

Cannot playback. Reinsert the Memory Stick. (p.28)

Cannot record. Reinsert the Memory Stick. (p.28)

Memory Stick has been removed. Process canceled.

Memory Stick folders are full.

- You cannot create folders exceeding 999MSDCF. You cannot create or delete created folders using your camcorder.

- You will have to format the “Memory Stick Duo” (p.74), or delete them using your computer.

Do not eject the Memory Stick during writing.

Insert a Memory Stick or change STILL MEDIA to DVD. (p.28, 33, 39)

■ PictBridge compliant printer

Check the connected device.

- Switch off the printer and switch it on again, then disconnect the USB cable (supplied) and reconnect it.

Not connected to PictBridge compatible printer.

- Switch off the printer and switch it on again, then disconnect the USB cable (supplied) and reconnect it.

Error. Cancel the task.

- Check the printer.

Cannot print. Check the printer.

- Switch off the printer and switch it on again, then disconnect the USB cable (supplied) and reconnect it.

■ Flash

Charging... Cannot record still images.

- You are trying to record a still image while the flash is charging.

Flash cannot charge. Not available.

- A malfunction has occurred with the strobe and disable charging.

Lens accessory attached. Cannot use flash.

■ Lens cover

Lens cover not fully open. Turn power off then on. (p.22)

Lens cover is not closed. Turn the power off once. (p.22)

■ Easy Handycam

Cannot start Easy Handycam. (p.31)

Cannot cancel Easy Handycam. (p.31)

Cannot start Easy Handycam with USB connected. (p.31)

Cannot cancel Easy Handycam with USB connected. (p.31)

Invalid during Easy Handycam operation. (p.31)

No recording in Easy Handycam operation. (p.31)

- The DVD+RW has been finalized. Make a disc to be able to record additional scenes (p.59).

■ Other

☒ **Please connect AC adaptor.**

- You are trying to finalize or format a disc, or making a disc available for additional recording after finalizing with the battery capacity low. Use the AC Adaptor as the power source to prevent the battery from wearing out in the middle of those operations.
-

Use new AC adapter or reinsert. (p.19)

Playlist full.

- You cannot create the playlist exceeding 999 scenes.
- There is not enough available space on the disc or "Memory Stick Duo."

Cannot divide.

- You cannot divide still images converted to a movie with .
 - You cannot divided a movie that is extremely short.
-

Data protected.

- The disc has been protected with another device.
-

Copy inhibit.

- You cannot copy scenes with the copy protection signal.
-

Not enough memory space. (p.82, 83)

This file cannot be copied. (p.82, 83)

Cannot select any more files. (p.82, 83)

Disc cover open, accidentally. Turn on power again.

Recovering data  **Avoid any vibration.**

- Your camcorder tries to recover data automatically if the data writing was not performed properly.
-

Cannot recover data on disc.

- Writing data to the disc has failed. Attempts were made to recover the data, but they were unsuccessful.
-

Please wait.

- This is displayed if the disc removal process takes time. Leave the camcorder alone for about 10 minutes so that it does not apply vibration to your camcorder.
-

Possibility of problem with disc.

- The disc removal process has failed. There may be something wrong with the disc.

Using your camcorder abroad

Power supply

You can use your camcorder in any countries/regions using the AC Adaptor supplied with your camcorder within the AC 100 V to 240 V, 50/60 Hz range.

On TV color systems

Your camcorder is a PAL system-based camcorder. If you want to view the playback picture on a TV, it must be a PAL system based TV with an AUDIO/VIDEO input jack.

System	Used in
PAL	Australia, Austria, Belgium, China, Czech Republic, Denmark, Finland, Germany, Holland, Hong Kong, Hungary, Italy, Kuwait, Malaysia, New Zealand, Norway, Poland, Portugal, Singapore, Slovak Republic, Spain, Sweden, Switzerland, Thailand, United Kingdom, etc.
PAL - M	Brazil
PAL - N	Argentina, Paraguay, Uruguay.
NTSC	Bahama Islands, Bolivia, Canada, Central America, Chile, Colombia, Ecuador, Guyana, Jamaica, Japan, Korea, Mexico, Peru, Surinam, Taiwan, the Philippines, the U.S.A., Venezuela, etc.
SECAM	Bulgaria, France, Guiana, Iran, Iraq, Monaco, Russia, Ukraine, etc.

Setting to the local time

You can easily set the clock to the local time by setting a time difference when using your camcorder abroad. Set [AREA SET] and [SUMMERTIME] in the  TIME/LANGU. (p.25).

World time difference

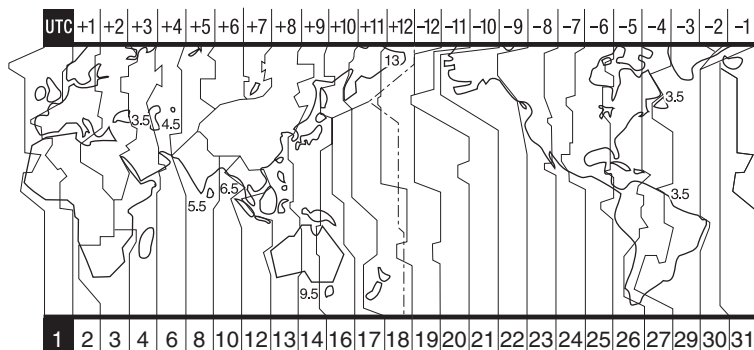

Area code	Time-zone differences	Area setting
1	GMT	Lisbon, London
2	+01:00	Berlin, Paris
3	+02:00	Helsinki, Cairo
4	+03:00	Moscow, Nairobi
5	+03:30	Tehran
6	+04:00	Abu Dhabi, Baku
7	+04:30	Kabul
8	+05:00	Karachi, Islamabad
9	+05:30	Calcutta, New Delhi
10	+06:00	Almaty, Dhaka
11	+06:30	Rangoon
12	+07:00	Bangkok, Jakarta
13	+08:00	HongKong, Singapore
14	+09:00	Seoul, Tokyo
15	+09:30	Adelaide, Darwin
16	+10:00	Melbourne, Sydney

Area code	Time-zone differences	Area setting
17	+11:00	Solomon Is.
18	+12:00	Fiji, Wellington
19	-12:00	Eniwetok, Kwajalein
20	-11:00	Midway Is., Samoa
21	-10:00	Hawaii
22	-09:00	Alaska
23	-08:00	Los Angeles, Tijuana
24	-07:00	Denver, Arizona
25	-06:00	Chicago, Mexico City
26	-05:00	New York, Bogota
27	-04:00	Santiago
28	-03:30	St. John's
29	-03:00	Brasilia, Montevideo
30	-02:00	Fernando de Noronha
31	-01:00	Azores

About the disc

See page 14 for the details of discs which you can use with your camcorder.

Notes on use

- Hold the disc by its edge while supporting the center hole lightly. Do not touch the recording side (the opposite of the printed side when using a single-sided disc).



- Before shooting, be sure to remove dust and fingerprints from the disc with the cleaning cloth supplied with your camcorder. Otherwise you may not be able to record or play normally in some situations using that disc.
- When you set the disc in your camcorder, press firmly until it clicks. When the message [C:13:□□] appears on the LCD screen, open the disc cover and set the disc again.
- Do not attach any adhesive material such as a sticker on the surface of a disc. If you do so, the disc may become unbalanced, and this may cause a malfunction of the disc or your camcorder.



Care and storage of the discs

- Keep the disc clean, or the quality of the audio and video output may deteriorate.
- Clean the disc with the supplied cleaning cloth.

Wipe the disc from the center out. For dirt, clean the disc with a soft cloth slightly moistened in water, then remove the moisture with a soft, dry cloth. Do not use solvents such as benzine, cleaners intended for vinyl LPs or antistatic spray, as they may cause a malfunction to the disc.



- Do not expose the disc to direct sunlight or leave it in a humid place.
- When you carry or store the disc, put it in its case.
- When you want to write letters or marks, etc. on a single-sided disc, write only on the printed side using an oil-based marker with a felt-tip, and do not touch the ink until it dries. Do not heat the disc or use a sharp-pointed tool, such as ball point pen. Do not dry the surface by heating. You cannot write on, or mark, on the double-sided discs.

About the “Memory Stick”

A “Memory Stick” is a compact, portable IC recording medium with a data capacity that exceeds the capacity of a floppy disk.

You can use only a “Memory Stick Duo,” which is about the half size of a standard “Memory Stick” in your camcorder.

However, appearance on the list below does not guarantee the operation of all types of “Memory Stick Duo” in your camcorder.

Types of “Memory Stick”	Recording/ Playback
“Memory Stick” (without MagicGate)	–
“Memory Stick Duo” ^{*1} (without MagicGate)	○
“MagicGate Memory Stick”	–
“Memory Stick Duo” ^{*1} (with MagicGate)	○ ^{*2} 3
“MagicGate Memory Stick Duo” ^{*1}	○ ^{*3}
“Memory Stick PRO”	–
“Memory Stick PRO Duo” ^{*1}	○ ^{*2} 3

^{*1} A “Memory Stick Duo” is about half the size of a standard “Memory Stick.”

^{*2} The types of “Memory Stick” that support high speed data transfer. The speed of data transfer varies depending on the device to be used.

^{*3} “MagicGate” is a copyright protection technology that records and transfers the contents in an encrypted format. Note that data that uses “MagicGate” technology cannot be recorded or played on your camcorder.

- Still image format: Your camcorder compresses and records image data in the JPEG (Joint Photographic Experts Group) format. The file extension is “.JPG.”
- File names of still images:
 - 101-0001: This file name appears on the screen of your camcorder.
 - DSC00001.JPG: This file name appears on the display of a computer.
- A “Memory Stick Duo” formatted by a computer (Windows OS/Mac OS) does not have guaranteed compatibility with your camcorder.

- Data read/write speed may vary depending on the combination of the “Memory Stick” and “Memory Stick” compliant product you use.

On a “Memory Stick Duo” with a write-protect tab

You can prevent accidental erasure of images when you slide the write-protect tab on the “Memory Stick Duo” with a small tapered object, to the write-protect position.

Notes on use

Image data may be damaged in the following cases. Compensation for damaged image data will not be made.

- If you eject the “Memory Stick Duo,” turn the power off on your camcorder, or remove the battery pack for replacement while your camcorder is reading or writing image files on the “Memory Stick Duo” (while the ACCESS lamp is lit or flashing).
- If you use the “Memory Stick Duo” near magnets or magnetic fields.

It is recommended you make a back-up of important data on the hard disk of a computer.

■ On handling a “Memory Stick”

Keep the following in mind when handling a “Memory Stick Duo.”

- Be careful not to apply excessive force when writing on a memo area on a “Memory Stick Duo.”
- Do not attach a label or the like on a “Memory Stick Duo” or a Memory Stick Duo Adaptor.
- When you carry or store a “Memory Stick Duo,” put it in its case.
- Do not touch, or allow metallic objects to come into contact with the terminals.
- Do not bend, drop or apply strong force to the “Memory Stick Duo.”
- Do not disassemble or modify the “Memory Stick Duo.”
- Do not let the “Memory Stick Duo” get wet.
- Be careful to keep “Memory Stick Duo” media out of the reach of small children. There is danger that a child might swallow it.
- Do not insert anything other than a “Memory Stick Duo” into the Memory Stick Duo slot. Doing so may cause a malfunction.

About the “Memory Stick” (continued)

■ On a location for use

Do not use or keep the “Memory Stick Duo” in the following locations.

- Places subject to extremely high temperature, such as a car parked outside in the summer.
- Places under direct sunlight.
- Places with extremely high humidity or subject to corrosive gases.

■ On the Memory Stick Duo Adaptor

After inserting a “Memory Stick Duo” into the Memory Stick Duo Adaptor, you can use it with a standard “Memory Stick” compliant device.

- When using a “Memory Stick Duo” with a “Memory Stick” compliant device, be sure to insert the “Memory Stick Duo” into a Memory Stick Duo Adaptor.
- When inserting a “Memory Stick Duo” into a Memory Stick Duo Adaptor, make sure the “Memory Stick Duo” is inserted facing in the correct direction, then insert it all the way in. Note that improper use may damage the device. Also, if you force the “Memory Stick Duo” into the Memory Stick Duo slot in the wrong direction, the Memory Stick Duo slot may be damaged.
- Do not insert a Memory Stick Duo Adaptor without a “Memory Stick Duo” attached. Doing so may result in malfunctions of the unit.

■ On a “Memory Stick PRO Duo”

- The maximum memory capacity of a “Memory Stick PRO Duo” that can be used on your camcorder is 2 GB.

On image data compatibility

- Image data files recorded on a “Memory Stick Duo” by your camcorder conform to the Design rule for Camera File system universal standard established by the JEITA (Japan Electronics and Information Technology Industries Association).
- On your camcorder, you cannot play back still images recorded on other devices (DCR-TRV900E or DSC-D700/D770) that do not conform to the universal standard. (These models are not sold in some regions.)
- If you cannot use a “Memory Stick Duo” that has been used with another device, format it with your camcorder (p.75). Note that formatting erases all information on the “Memory Stick Duo.”
- You may not be able to play back images with your camcorder:

- When playing back image data modified on your computer.
- When playing back image data recorded with other devices.

About the “InfoLITHIUM” battery pack

This unit is compatible with an “InfoLITHIUM” battery pack (P series). Your camcorder operates only with an “InfoLITHIUM” battery pack. “InfoLITHIUM” P series battery packs have the  mark.

What is an “InfoLITHIUM” battery pack?

An “InfoLITHIUM” battery pack is a lithium-ion battery pack that has functions for communicating information related to operating conditions between your camcorder and an optional AC Adaptor/charger (optional).

The “InfoLITHIUM” battery pack calculates the power consumption according to the operating conditions of your camcorder, and displays the remaining battery time in minutes.

Charging the battery pack

- Be sure to charge the battery pack before you start using your camcorder.
- It is recommended that you charge the battery pack in an ambient temperature of between 10°C to 30°C (50°F to 86°F) until CHG (Charge) lamp turns off. If you charge the battery pack outside of this temperature range, you may not be able to charge the battery pack efficiently.
- After charging is complete, either disconnect the cable from the DC IN jack on your camcorder or remove the battery pack.

Effective use of the battery pack

- Battery pack performance decreases when the surrounding temperature is 10°C (50°F) or below, and the length of time you can use the battery pack becomes shorter. In that case, do one of the following to use the battery pack for a longer time.
 - Put the battery pack in a pocket to warm it up, and insert it in your camcorder right before you start taking shots.
 - Use a large capacity battery pack: NP-FP71/ NP-FP90.
- Frequent use of the LCD screen or a frequent playback, fast forward or reverse operation wears out the battery pack faster. It is recommended that you use a large capacity battery pack: NP-FP71/ NP-FP90.

- Be sure to slide the POWER switch to OFF (CHG) when not shooting or playing back on your camcorder. The battery pack is also consumed when your camcorder is in the standby mode or playback is paused.
- Have spare battery packs ready for two or three times the expected recording time, and make trial recordings on a DVD-RW/DVD+RW before making the actual recording.
- Do not expose the battery pack to water. The battery pack is not water-resistant.

Remaining battery time indicator

- If the power goes off even though the remaining battery time indicator indicates that the battery pack has enough power to operate, charge the battery pack fully again so that the indication on the remaining battery time indicator is correct. Note, however, that the correct battery indication sometimes will not be restored if the battery is used in high temperatures for a long time or left in a fully charged state, or the battery pack is used frequently. Regard the remaining battery time indication as the approximate shooting time.
- The  mark indicating that there is little remaining battery time sometimes flashes depending on the operating conditions or ambient temperature and environment even if the remaining battery time is approximately 20 minutes.

How to store the battery pack

- If the battery pack is not used for a long time, fully charge the battery pack and discharge it on your camcorder once a year to maintain the proper function. To store the battery pack, remove it from your camcorder and put it in a dry, cool place.
- To use the battery pack up on your camcorder, leave your camcorder in the recording standby without a disc inserted with the [A. SHUT OFF] to [NEVER] in the  STANDARD SET in the SETUP screen until the power goes off (p.78).

Battery life

- The battery life is limited. Battery capacity drops little by little as you use it more and more, and as time passes. When the available battery time is shortened considerably, a probable cause is that the battery pack has reached the end of its life. Please buy a new battery pack.
- The battery life varies according to how it is stored, the operating conditions, and environment in which each battery pack is used.

Maintenance and precautions

On use and care

- Do not use or store the camcorder and accessories in the following locations.
 - Anywhere extremely hot or cold. Never leave them exposed to temperatures above 60°C (140°F), such as under direct sunlight, near heaters or in a car parked in the sun. They may malfunction or become deformed.
 - Near strong magnetic fields or mechanical vibration. The camcorder may malfunction.
 - Near strong radio waves or radiation. The camcorder may not be able to record properly.
 - Near AM receivers and video equipment. Noise may occur.
 - On a sandy beach or anywhere dusty. If sand or dust gets in your camcorder, it may malfunction. Sometimes this malfunction cannot be repaired.
 - Near windows or outdoors, where the LCD screen, the viewfinder, or the lens may be exposed to direct sunlight. This damages the inside of the viewfinder or the LCD screen.
 - Anywhere very humid.
- Operate your camcorder on DC 7.2 V (battery pack) or DC 8.4 V (AC Adaptor).
- For DC or AC operation, use the accessories recommended in these instruction manual.
- Do not let your camcorder get wet, for example, from rain or sea water. If your camcorder gets wet, it may malfunction. Sometimes this malfunction cannot be repaired.
- If any solid object or liquid gets inside the casing, unplug your camcorder and have it checked by a Sony dealer before operating it any further.
- Avoid rough handling, disassembling, modifying, physical shock, or impact such as hammering, dropping or stepping on the product. Be particularly careful of the lens.
- Keep the POWER switch setting to OFF (CHG) when you are not using your camcorder.
- Do not wrap your camcorder with a towel, for example, and operate it. Doing so might cause heat to build up inside.
- When disconnecting the mains lead, pull it by the plug and not the cord.
- Do not damage the mains lead such as by placing anything heavy on it.
- Keep metal contacts clean.
- Keep the Remote Commander and button-type battery out of children's reach. If the battery is



accidentally swallowed, consult a doctor immediately.

- If the battery electrolytic liquid has leaked,
 - consult your local authorized Sony service facility.
 - wash off any liquid that may have contacted your skin
 - if any liquid gets in your eyes, wash with plenty of water and consult a doctor.

■ When not using your camcorder for a long time

- Occasionally turn it on and let it run such as by playing back discs or recording for about 3 minutes.
- Remove a disc from your camcorder.
- Use up the battery pack completely before storing it.

Moisture condensation

If your camcorder is brought directly from a cold place to a warm place, moisture may condense inside your camcorder, on the surface of the disc, or on the pickup lens. This may cause a malfunction to your camcorder. If there is moisture inside your camcorder, [ Moisture condensation. Turn off for 1H.] or [ Condensation. Cannot open. Try later.] appears.

The indication will not appear when the moisture condenses on the camera lens.

■ If moisture condensation has occurred

Turn off your camcorder, and leave it for about an hour.

■ Note on moisture condensation

Moisture may condense when you bring your camcorder from a cold place into a warm place (or vice versa) or when you use your camcorder in a humid place as follows:

- You bring your camcorder from a ski slope into a place warmed up by a heating device.
- You bring your camcorder from an air conditioned car or room into a hot place outside.
- You use your camcorder after a squall or a shower.
- You use your camcorder in a hot and humid place.

Maintenance and precautions (continued)

■ How to prevent moisture condensation

When you bring your camcorder from a cold place into a warm place, put your camcorder in a plastic bag and seal it tightly. Remove the bag when the air temperature inside the plastic bag has reached the surrounding temperature (after about one hour).

On the LCD screen

- Do not exert excessive pressure on the LCD screen. Blurs appear and it may cause a malfunction of your camcorder.
- If your camcorder is used in a cold place, a residual image may appear on the LCD screen. This is not a malfunction.
- While you are using your camcorder, the back of the LCD screen may heat up. This is not a malfunction.

■ To clean the LCD screen



If fingerprints or dust make the LCD screen dirty, use the cleaning cloth (supplied) to clean the LCD screen.

When you use the LCD Cleaning Kit (optional), do not apply the cleaning liquid directly to the LCD screen. Use cleaning paper moistened with the liquid.

■ On adjustment of the LCD screen (CALIBRATION)

The buttons on the touch panel may not work correctly. If this happens, follow the procedure below. It is recommended you connect your camcorder to the wall socket using the supplied AC Adaptor during the operation.

- ① Slide the POWER switch to turn on your camcorder and press  PLAY/EDIT.
- ② Disconnect cables other than that of the AC Adaptor from your camcorder, then remove the disc and “Memory Stick Duo” from your camcorder.

- ③ Touch  → [SETUP] →  STANDARD SET → [CALIBRATION].

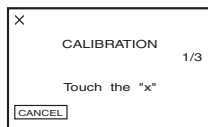

- ④ Touch the “x” displayed on the screen with a thin object such as a corner of “Memory Stick Duo”.
The position of the “x” changes.
Touch [CANCEL] to cancel.

If you did not press the right spot, try the calibration again.

- Do not use a sharp-pointed tool to calibrate the LCD screen. Doing so may damage the surface of the screen.
- You cannot calibrate the LCD screen if you have rotated it, or if you have set it with the LCD screen side facing out.

On handling the casing

- If the casing is soiled, clean the camcorder body with a soft cloth lightly moistened with water, and then wipe the casing with a dry soft cloth.
- Avoid the following to avoid damage to the finish.
 - Using chemicals such as thinner, benzene, alcohol, chemical cloths, repellent and insecticide.
 - Handling with above substances on your hands.
 - Leaving the casing in contact with rubber or vinyl objects for a long period of time.

On the pickup lens

- Do not touch the lens inside the disc cover. Keep the disc cover closed except when inserting and removing the disc, to keep dust out.
- When your camcorder does not work because the pickup lens is dirty, clean it with a blower (not supplied). Do not touch the pickup lens directly during cleaning because this may cause the camcorder to malfunction.

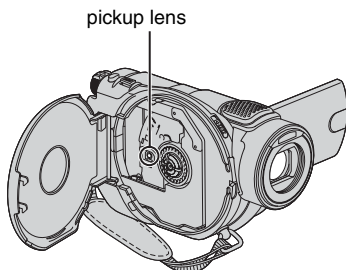

Pickup lens  Glossary (p.140)

Care and storage of the camera lens

- Wipe the surface of the lens clean with a soft cloth in the following instances:
 - when there are fingerprints on the lens surface.
 - in hot or humid locations
 - when the lens is exposed to salty air such as at the seaside.
- Store the lens in a well-ventilated location subject to little dirt or dust.
- To prevent mold, periodically clean the lens as described above. It is recommended that you operate your camcorder about once a month to keep it in optimum state for a long time.

To charge the pre-installed rechargeable battery

Your camcorder has a pre-installed rechargeable battery to retain the date, time, and other settings even when the POWER switch is set to OFF (CHG). The pre-installed rechargeable battery is always charged while you are using your camcorder but it will get discharged gradually if you do not use your camcorder. The rechargeable battery will be fully discharged in **about 3 months** if you do not use your camcorder at all. However, even if the pre-installed rechargeable battery is not charged, the camcorder operation will not be affected as long as you are not recording the date.

■ Procedures

Connect your camcorder to a wall socket using the AC Adaptor supplied with your camcorder, and leave your camcorder with the POWER switch turned off for more than 24 hours.

To change the battery of the Remote Commander

- ① While pressing on the tab, inset your fingernail into the slit to pull out the battery case.
- ② Place a new battery with the + side facing up.
- ③ Insert the battery case back into the Remote Commander until it clicks.

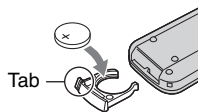

WARNING

Battery may explode if mistreated. Do not recharge, disassemble or dispose of in fire.

- A button-type lithium battery (CR2025) is used in the Remote Commander. Do not use batteries other than the CR2025.
- When the lithium battery becomes weak, the operating distance of the Remote Commander may shorten, or the Remote Commander may not function properly. In this case, replace the battery with a Sony CR2025 lithium battery. Use of another battery may present a risk of fire or explosion.

Specifications

System

Video compression format

MPEG2/JPEG (Still images)

Audio compression format

Dolby Digital 2/5.1ch
Dolby Digital 5.1 Creator

Video signal

PAL color, CCIR standards

Usable discs

8cm DVD-R/DVD-RW/DVD+RW

Recording format

Movie

DVD-R: DVD-VIDEO

DVD-RW: DVD-VIDEO (VIDEO mode),
DVD-Video Recording
(VR mode)

DVD+RW: DVD+RW Video

Still image

Exif¹ Ver.2.2

Recording/playback time

HQ: Approx. 20 min

SP: Approx. 30 min

LP: Approx. 60 min

Viewfinder

Electric viewfinder
color

Image device

5.9 mm (1/3 type) CCD (Charge Coupled
Device)

Gross:

Approx. 3 310 000 pixels

Effective (Movie, 4:3):

Approx. 2 050 000 pixels

Effective (Movie, 16:9):

Approx. 2 060 000 pixels

Effective (Still, 4:3):

Approx. 3 050 000 pixels

Effective (Still, 16:9):

Approx. 2 290 000 pixels

Lens

Carl Zeiss Vario-Sonnar T*

Filter diameter: 30mm (1 3/16 in.)

Optical: 10x, Digital: 20x, 120x
F=1.8-2.9

Focal length

f=5.1 - 51mm (7/32 - 2 1/8 in.)

When converted to a 35 mm still camera

For movies:

42.8 - 495mm (1 11/16 - 19 1/2 in.) (16:9)²

45 - 450mm (1 13/16 - 17 3/4 in.) (4:3)

For still images:

37 - 370mm (1 1/2 - 14 5/8 in.) (4:3)

40.6 - 406mm (1 5/8 - 16 in.) (16:9)

Color temperature

[AUTO], [ONE PUSH], [INDOOR] (3 200 K),
[OUTDOOR] (5 800 K)

Minimum illumination

5 lx (lux) (F1.8)

0 lx (lux) (in the NightShot function)³

¹ "Exif" is a file format for still images, established by the JEITA (Japan Electronics and Information Technology Industries Association). Files in this format can have additional information such as your camcorder's setting information at the time of recording.

² In 16:9 mode, the focal length figures are actual figures resulting from wide angle pixel readout.

³ Objects unable to be seen due to the dark can be shot with infrared lighting.

- Manufactured under license from Dolby Laboratories.

Input/Output connectors DCR-DVD404E

Audio/Video output

10 pin connector

Video signal: 1 Vp-p, 75 Ω (ohms), unbalanced

Luminance signal: 1 Vp-p, 75 Ω (ohms),
unbalanced

Chrominance signal: 0.3 Vp-p, 75 Ω (ohms),
unbalanced

Audio signal: 327 mV (at Load impedance
47 kΩ (kilohms)), Output impedance less than
2.2 kΩ (kilohms)

REMOTE jack

Stereo mini-minijack (Ø 2.5 mm)

DCR-DVD405E/DVD805E

Audio/Video input/output

10 pin connector

Input/Output auto switch

Video signal: 1 Vp-p, 75 Ω (ohms), unbalanced

Luminance signal: 1 Vp-p, 75 Ω (ohms),
unbalanced

Chrominance signal: 0.3 Vp-p, 75 Ω (ohms),
unbalanced

Audio signal: 327 mV (at Load impedance
47 kΩ (kilohms)), Input impedance more than
47 kΩ (kilohms), Output impedance less than
2.2 kΩ (kilohms)

USB jack

mini-B

REMOTE jack

Stereo mini-minijack (Ø 2.5 mm)

Specifications (continued)

LCD screen

Picture

6.9 cm (2.7 type, aspect ratio 16:9)

Total number of pixels

123 200 (560 × 220)

General

Power requirements

7.2 V (battery pack)

8.4 V (AC Adaptor)

Average power consumption

During camera recording using LCD

4.4W

Viewfinder

4.0W

Operating temperature

0°C to + 40°C (32°F to 104°F)

Storage temperature

-20°C to + 60°C (-4°F to + 140°F)

Dimensions (Approx.)

66 × 90 × 143mm (2 5/8 × 3 5/8 × 5 3/4 in.)
(w×h×d)

Mass (Approx.)

510 g (1 lb 1 oz) main unit only

590 g (1 lb 4 oz) including the NP-FP60
rechargeable battery pack and disc

Supplied accessories

See page 18.

AC Adaptor AC-L200

Power requirements

AC 100 - 240 V, 50/60 Hz

Current consumption

0.35 - 0.18 A

Power consumption

18W

Output voltage

DC 8.4V*

Operating temperature

0°C to + 40°C (32°F to 104°F)

Storage temperature

-20°C to + 60°C (-4°F to + 140°F)

Dimensions (Approx.)

48 × 29 × 81 mm (1 15/16 × 1 3/16 × 3 1/4 in.)
(w×h×d)

excluding the projecting parts

Mass (Approx.)

170 g (6 oz) excluding the mains lead

* See at the label of AC Adaptor for other specifications.

Rechargeable battery pack NP-FP60

Maximum output voltage

DC8.4V

Output voltage

DC7.2V

Capacity

7.2 wh (1 000 mAh)

Dimensions (Approx.)

31.8 × 33.3 × 45.0 mm

(1 5/16 × 1 5/16 × 1 13/16 in.) (w×h×d)

Mass (Approx.)

80 g (2.9 oz)

Operating temperature

0°C to + 40°C (32°F to 104°F)

Type

Li-ion

Design and specifications are subject to change without notice.

Glossary

■ 12cm disc

A disc with a diameter of 12cm. You cannot use 12cm discs with this DVD Handycam.

■ 5.1ch surround sound

A system that plays back sound on 6 speakers, 3 at the front (left, right and center) and 2 at the rear (right and left) with an additional low-pass subwoofer counted as a 0.1 channel for frequencies of 120Hz or lower. The subwoofer is only counted as 0.1 channel because its playback band is narrow. The all-round audio reproduction is more realistic than stereo, which only reproduces movement of sound from side to side.

■ 8cm disc

A disc with a diameter of 8cm. You can use 8cm discs with DVD Handycam.

■ Disc title

The title (name) given to a recorded disc.

■ Dolby Digital

An audio encoding (compression) system developed by Dolby Laboratories Inc. Sound can be recorded in various formats, from 5.1ch surround to 2ch stereo or monaural audio.

■ Dolby Digital 5.1 Creator

Sound compression technology developed by Dolby Laboratories Inc. which compresses audio efficiently while preserving high sound quality. It enables recording of 5.1ch surround sound while using disc space more efficiently. Discs created by Dolby Digital 5.1 Creator can be played back on a DVD recorder or device compatible with the disc on DVD Handycam. If you own a 5.1ch system (such as a home theater system) you can enjoy a powerful sound.

■ Double-sided disc

Disc that can be recorded on both sides.

■ DVD menu

A menu screen that enables you to select a particular scene from a disc being played

back on a DVD device or other device. You can create a DVD menu with DVD Handycam showing the beginning of each scene with date.

■ DVD-R

A DVD format that does not enable re-recording. It is mostly used for saving data that does not need to be edited. It is characterized by excellent playback compatibility with other DVD devices. Before finalizing, you can additionally record onto the disc's free space. Once the disc is finalized, however, you cannot record onto it even if it has some free space left.

■ DVD-RW

A re-recordable DVD format. You can choose from two kinds of recording mode: VIDEO mode, which stresses high playback compatibility with other DVD devices, and VR mode, which enables various editing with DVD Handycam after recording.

■ DVD+RW

A re-recordable DVD format providing high playback compatibility with other DVD devices. Discs do not require finalizing so they can be re-recorded anytime.

■ Finalizing

The process of making discs recorded on DVD Handycam compatible for playback on other DVD devices. DVD-R/DVD-RW discs must be finalized before being played on another DVD device.

■ Formatting

The process of deleting all recorded movies from a disc and restoring its original storage capacity so that it can be rerecorded onto.

■ JPEG

JPEG stands for Joint Photographic Experts Group, a still image data compression (data capacity reduction) standard. DVD Handycam records still images in JPEG format.

■ MPEG2

MPEG stands for Moving Picture Experts Group, the group of standards for the coding (image compression) of video (movie) and audio. There are MPEG1 (standard definition) and MPEG2 (high definition) formats. DVD Handycam records movies in MPEG2 format.

■ Original

A movie or still photo recorded by DVD Handycam onto a disc is called an “original.”

■ Photomovie

A series of still images (JPEG format) converted and resaved as a movie (MPEG format) on the same disc, which can be played back on another DVD device or computer. Create a Photomovie to view still images on a DVD device that does not support JPEG playback. Still images converted to a Photomovie are played back continuously like a slide show. Resolution is slightly reduced.

■ Pickup lens

The component that optically reads signals from a recorded disc.

■ Playlist

A list of your favorite selected original movies and still images. It enables simple editing of original recorded data such as deleting images, dividing videos, and changing playback order.

■ Recording mode

By setting the recording mode before recording, you can select the image quality. There are 3 modes: HQ (high quality), SP (standard play) and LP (long play). The higher the recording quality, the shorter the recording time.

■ Thumbnail

Reduced-size images which enable you to view many images at the same time. DVD Handycam “VISUAL INDEX” and “DVD menu” use a thumbnail display system.

■ Unfinalizing

The process of treating a finalized disc that has some unused recording capacity so that it can be recorded on again.

■ VBR

VBR stands for Variable Bit Rate, the recording format for automatically controlling the bit rate (the volume of recording data in a given time segment) according to the scene being recorded. For fast-moving video, a lot of disc space is used to produce a clear image so the recording time is short.

■ VIDEO mode

One of the recording formats you can select when using a DVD-RW. VIDEO mode provides excellent compatibility with other DVD devices.

■ VISUAL INDEX

This function displays images of movies and still images you have recorded so that you can select those scenes you want to play back.

■ VR mode

One of the recording formats you can select when using a DVD-RW. VR mode enables editing (deleting or sequence rearrangement) with DVD Handycam. Finalizing the disc lets you play it back on a VR mode compatible DVD device.

Index

Numerics

- 16:9 WIDE.....29, 60
- 21-pin adaptor.....51
- 4:3.....29, 60
- 4ch microphone.....42
- 5.1ch surround recording.....42
- 5.1-channel surround sound.....42
- 8cm DVD.....12

A

- A/V connecting cable.....18, 50, 90, 92
- A/V jack.....50, 90, 92, 96
- AC Adaptor.....18, 19
- ACCESS lamp
 - Disc.....26
 - “Memory Stick Duo”.....28
- Active Interface Shoe.....96
- Additional recording.....59
- Adjusting exposure for back light.....43
- Aspect ratio.....29
- AUTO SHUTTER.....68
- A.SHUT OFF (Auto shutter off).....78

B

- Back light.....43
- Battery
 - BATTERY INFO.....24, 45
 - Battery pack.....19
 - Remaining battery.....45
- BATT (battery) release lever.....20
- BEACH&SKI.....66
- BEEP.....78
- BLACK FADER.....72
- Build-in 4ch microphone.....45
- BURST
 - EXP. BRKTG.....70

- NORMAL.....70
- Button-type lithium battery.....136
- B&W.....73

C

- CALIBRATION.....134
- CAMERA DATA.....77
- CAMERA SET.....66
- CD-ROM.....18, 97
- Charging the battery.....19
 - Battery pack.....20
- Charging time.....20
- CHG (charge) lamp.....19
- Cleaning cloth.....18
- CLOCK SET.....25
- COLOR SLOW S (Color Slow Shutter).....69, 113
- Computer.....97
- Connect
 - TV.....50
 - VCR/DVD device.....90, 92
- Copyright.....6, 102, 125
- Counter.....47

D

- DATA CODE.....25, 48, 76
- DATE/TIME.....25, 77
- DC IN jack.....19, 96
- DC plug.....19
- Delete
 - Disc.....46, 85
 - “Memory Stick Duo”.....46, 84
- DEMO MODE.....74
- DIGITAL ZOOM.....70
- Disc cover OPEN switch.....26
- Disc title.....55, 74
- DISP OUTPUT.....78
- DISP/BATT INFO.....23, 24, 45
- Display indicators.....47, 48
- Dolby Digital 5.1 Creator.....42

- Double-sided disc.....15
- Dual sound.....*See MULTI-SOUND*
- Dubbing.....90
- DVD device.....56
- DVD menu.....55
- DVD+RW.....14
- DVD-R.....14
- DVD-RW.....14
- D.EFFECT (Digital effect).....73

E

- EASY button.....31
- Easy Handycam operation.....31
- EasyStepDVD.....100
- Edit.....85
- EXPOSURE.....67, 112

F

- FADER.....72, 113
- FILE NO. (File number).....72
- Finalize.....52
- FINE.....71
- Fireworks.....*See PROGRAM AE*
- First Step Guide.....97, 102
- Fixing the exposure.....43
- Flash.....43
- FLASH LEVEL.....68
- FLASH SET.....68
- FOCUS.....68, 109
- Format
 - Disc.....60
 - “Memory Stick Duo”.....74
- Full charge.....20
- FULL SPEED.....76

G

- Grip belt.....22

Index (continued)

H

Help 97
High-speed transfer 13, 98
Holding the camcorder 22
HQ 75

I

Icon *See Display indicators*
IMAGE SIZE 71
Index
 DISPLAY 77
 MOVIE PB 77
Index screen display
button 47
INDOOR 67
“InfoLITHIUM” battery pack
..... 131
Initialize (Reset) 45
Install 99
Insulation sheet 49

J

Jack 96
JPEG 139

L

LANDSCAPE 66
LANGUAGE 79
LCD/VF SET 76
LCD backlight 23
LCD BL LEVEL 76
LCD BRIGHT 76
LCD COLOR 76
LCD screen 23
Lens cover 22, 38
LETTER BOX 76
LP (Long Play) 75
LUMI. KEY
(luminance key) 73

M

Macintosh 97
Main sound 75
Mains lead 19
Maintenance 133
MEDIA SET 74
“Memory Stick” 4, 129
“Memory Stick Duo”
..... 4, 28, 129
 FORMAT 74
 Insert/Eject 28
 Number of recordable
 pictures 71
 Write-protect tab 129
Memory Stick Duo Adaptor
..... 4, 129
Memory Stick Duo slot 28
“Memory Stick PRO Duo”
..... 130
MICREF LEVEL 75
Mirror mode 44
Moisture condensation 133
MOSAIC 73
Movie
 REC MODE
 (Recording mode) 75
 Recording 32, 38
MPEG2 140
MULTI-SOUND 75

N

Nero Express 6 18, 97
NightShot 43
NIGHTSHOT switch 43
NORMAL 70
NS LIGHT
(NightShot Light) 69
NTSC 126
Number of still images
recordable on a disc 71

O

OLD MOVIE 73
ONE PUSH 67
Operation confirmation
beep *See BEEP*
Original data 85
 Delete 85
 Divide 85
OUTDOOR 67
OVERLAP 72

P

PAL 126
PASTEL 73
PB zoom 44
Personal Menu 62, 80
 Add 80
 Arrange the order 81
 Delete 80
 Reset 81
Personal Menu button 47
PHOTO button 33, 39, 49
Photomovie 55, 88
Pickup lens 135
PictBridge 94
Picture Package 18, 97
PICT.APPLI.
(Picture Application) 72
PICT. EFFECT
(Picture effect) 73
Pixela User Support Center
..... 102
Playback 34, 40
Playlist
 ADD 86
 DIVIDE 88
 ERASE 87
 MOVE 87
PORTRAIT (Soft portrait) ... 66
POWER switch 19
Pre-installed rechargeable
battery 135

Preparation	
Camcorder	18
Computer	97
Previous/next button	
.....	34, 35, 41
Print	94
PROGRAM AE	66, 112
Protect	60, 125
P.MENU ... <i>See Personal Menu</i>	

Q

QUALITY	71
---------------	----

R

Rechargeable battery pack	<i>See Battery</i>
Recordable still images	71
Recording	32, 38
Recording format	14, 27
Recording lamp (REC LAMP)	45, 78
Recording time	20
REC MODE	75
REDEYE REDUC	68
REMAINING	77
Remaining battery	47
Remaining display	
Battery	45
Disc	47
“Memory Stick Duo”	45
Remote Commander	49
Remote sensor	45
RESET	45
Review	46
Review deleting	46

S

Self-diagnosis display	121
SELF-TIMER	69
SEPIA	73
Setup	62
CAMERA SET	66

MEDIA SET	74
Personal Menu	62, 80
PICT.APPLI	72
Setup items	64
STANDARD SET	75
STILL SET	70
TIME/LANGU	79
Using the Setup items ...	62
SETUP ROTATE	78
Shoulder belt	44
Slide show	44
Slide show button	35, 41, 46
Software	99
SP	75
Speaker	45
Specifications	137
SPORTS (Sports lesson)	66
SPOTLIGHT	66
SPOT FOCUS	68
SPOT METER	
(Flexible spot meter) ...	66, 112
STANDARD	71
STANDARD SET	75
START/STOP	32, 38
STEADYSHOT	70, 109
Still image	
IMAGE SIZE	33, 71
QUALITY	71
Recording	33, 39
STILL MEDIA	33, 39
STILL SET	70
Sub sound	75
SUB-T DATE	77
SUMMERTIME	25, 79
SUNSET&MOON	66
SUPER NS	
(Super NightShot)	69, 112
SUR MONITOR	75
System requirements	98
S VIDEO cable	50, 90, 92
S VIDEO jack	50, 90, 92

T

Telephoto	42
Thumbnail	77
TIME/LANGU.	
(Language)	79
Touch panel	24
Transmitter	49
Tripod	44
TV	50
TV color system	126
TV TYPE	50

U

Unfinalizing	59
USB1.1	76, 98
USB2.0	76, 98
USB cable	18
USB driver	97
USB jack	96
USB SELECT	73
USB SPEED	76
Using abroad	126

V

VBR	15, 75
VF B.LIGHT	
(Viewfinder back light)	76
VF WIDE DISP	
(View finder wide display)	
.....	76
VIDEO mode	14
Video operation buttons	47
Viewfinder	23
Brightness	76
Viewfinder lens adjustment	
.....	23
VISUAL INDEX screen	
.....	34, 40
Volume	41
VR mode	14

Index (continued)

W

Wall socket	19
Warning indicators	121
Warning messages	121
WHITE BAL. (White balance)	67, 112
WHITE FADER	72
Wide angle.....	42
WIDE SELECT	29
Windows.....	98
WIPE	72
World time difference	127
Write-protect tab.....	129

Z

Zoom	42
Zoom lever	42

On trademarks

- “Handycam” and **HANDYCAM** are registered trademarks of Sony Corporation.
- “Memory Stick,” , “Memory Stick Duo,” **MEMORY STICK DUO**, “Memory Stick PRO Duo,” **MEMORY STICK PRO DUO**, “MagicGate,” **MAGIC GATE**, “MagicGate Memory Stick” and “MagicGate Memory Stick Duo” are trademarks of Sony Corporation.
- “InfoLITHIUM” is a trademark of Sony Corporation.
- Picture Package is a trademark of Sony Corporation.
- DVD-R, DVD-RW, and DVD+RW logo are trademarks.
- Dolby and the double-D symbol are trademarks of Dolby Laboratories.
- Dolby Digital 5.1 Creator is a trademark of Dolby Laboratories.
- Microsoft, Windows, and Windows Media are either registered trademarks or trademarks of Microsoft Corporation in the United States and/or other countries.
- Windows Media Player is a trademark of Microsoft Corporation.
- iMac, iBook, Macintosh, Mac OS, PowerBook and PowerMac are trademarks of Apple Computer, Inc in the U.S. and other countries.
- Macromedia and Macromedia Flash Player are trademarks or registered trademarks of Macromedia, Inc. in the United States and / or other countries.
- Pentium is a trademark or registered trademark of Intel Corporation.
- Nero 6 and other software products developed by Nero AG are registered trademarks of Nero AG and its subsidiaries and affiliates. Copyright © Nero AG and its licensors 1996-2005

All other product names mentioned herein may be the trademarks or registered trademarks of their respective companies. Furthermore, TM and [®] are not mentioned in each case in this manual.

Notes on the License

ANY USE OF THIS PRODUCT OTHER THAN CONSUMER PERSONAL USE IN ANY MANNER THAT COMPLIES WITH THE MPEG-2 STANDARD FOR ENCODING VIDEO INFORMATION FOR PACKAGED MEDIA IS EXPRESSLY PROHIBITED WITHOUT A LICENSE UNDER APPLICABLE PATENTS IN THE MPEG-2 PATENT PORTFOLIO, WHICH LICENSE IS AVAILABLE FROM MPEG LA, L.L.C., 250 STEELE STREET, SUITE 300, DENVER, COLORADO 80206.

Additional information on this product and answers to frequently asked questions can be found at our Customer Support Website.

<http://www.sony.net/>



Printed on 100% recycled paper using
VOC (Volatile Organic Compound)-free
vegetable oil based ink.

Printed in Japan

GB



2661364110