

Getting Started

GB

Operating Instructions

GB

**KL-37W1U**  
**KL-50W1U**

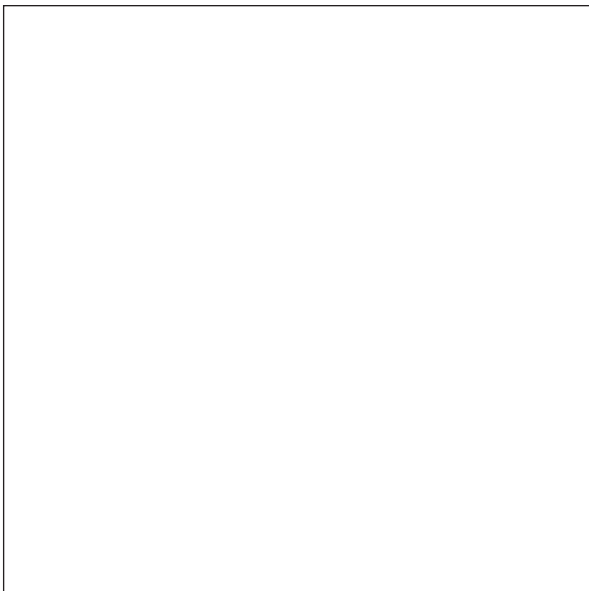

***LCD Projection TV***

## WARNING

To prevent fire or shock hazard, do not expose the unit to rain or moisture. Dangerously high voltages are present inside the set. Do not open the cabinet. Refer servicing to qualified personnel only.

## Safety Information

All TVs operate on extremely high voltages. To prevent fire or electric shock, please follow the safety procedures below. For your protection, refer all servicing to qualified personnel only.

### For general safety:

- Do not expose the TV to rain or moisture.
- Do not open the rear cover.

### For safe operations:

- Do not operate the TV on any other voltages, but 220–240 V AC.
- Do not operate the TV if any liquid or solid object falls in it - have it checked immediately.
- Do not keep the set plugged in if you are not going to use it for several days.
- Do not pull on the power cord to disconnect the TV. Pull it out by the plug.
- Do not place anything on the surface of the front panel cover when you open it.

## Important Information

Please read the following information on using and maintaining the TV, for optimum viewing quality.

### Picture Quality

- Avoid touching the screen, and take care not to scratch the surface with hard objects.

### Illumination

To obtain a clear picture, do not expose the screen to direct illumination or direct sunlight. If possible, use spot lighting directed down from the ceiling.

### Installation

- To prevent over heating of the set, do not block the ventilation openings.
- Do not install the TV in a hot or humid place, or in a place subject to direct sunlight, excessive dust or mechanical vibration.
- After transporting the TV directly from a cold to a warm location, or if the room temperature has changed suddenly, pictures may be blurred or show poor colour over portions of the picture. This is because moisture has condensed on the mirrors or lenses inside the TV. Let the moisture evaporate before using the TV.

### Maintenance

- Save the original shipping carton and packing material to use if you ever have to ship your TV. For maximum protection, repack your TV as it was originally packed at the factory.
- To keep the cabinet looking brand-new, periodically clean it with a soft cloth. Stubborn stains may be removed with a cloth slightly dampened with a mild detergent solution. Never use strong solvents such as thinner or benzene, or abrasive cleaners since these will damage the cabinet. As a safety precaution, unplug the TV before cleaning it.

- To remove dust from the front of the screen, unplug the TV and wipe gently with a soft cloth lightly dampened with water or a mild detergent solution, using vertical strokes only. Then wipe it with a dry, soft cloth. Never use solvents or thinners for cleaning purposes.
- If the picture turns dark after the TV has been in use for a long period of time, it may be necessary to clean the inside of the TV. Consult qualified service personnel for this.

## NOTICE FOR CUSTOMERS IN THE UNITED KINGDOM

A moulded plug complying with BS1363 is fitted to this equipment for your safety and convenience.

Should the fuse in the plug supplied need to be replaced, a 5 AMP fuse approved by ASTA or BSI to BS 1362 (i.e. marked with ⚡ or ⚡ must be used.

When an alternative type of plug is used it should be fitted with a 5 AMP FUSE, otherwise the circuit should be protected by a 5 AMP FUSE at the distribution board.

If the plug supplied with this equipment has a detachable fuse cover, be sure to attach the fuse cover after you change the fuse. Never use the plug without the fuse cover. If you should lose the fuse cover, please contact your nearest Sony service station.

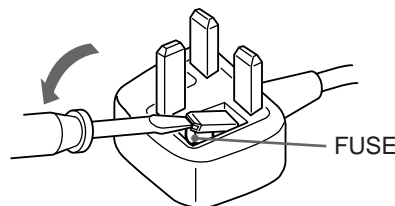

### IMPORTANT

If the plug supplied is not suitable for the socket outlets in your home, it should be cut off and an appropriate plug fitted in accordance with the following instructions:

The wires in this mains lead are coloured in accordance with the following code:

Blue	Neutral
Brown	Live

As the colours of the wires in the mains lead of this apparatus may not correspond with the coloured markings identifying the terminals in your plug, proceed as follows:

The wire which is coloured blue must be connected to the terminal which is marked with the letter N or coloured black. The wire which is coloured brown must be connected to the terminal which is marked with the letter L or coloured red. Do not connect either wire to the earth terminal in the plug which is marked by the letter E or by the safety earth symbol Y or coloured green or green and yellow.

### WARNING

To prevent shock hazard, do not insert the plug cut off from the mains lead into a socket outlet. This plug cannot be used and should be destroyed.

- To prevent fire or shock hazard, do not expose the unit to rain or moisture.
- Dangerously high voltages are present inside the set. Do not open the cabinet. Refer servicing to qualified personnel only. How to replace the fuse Open the fuse compartment with a blade screwdriver, and replace the fuse.

# Contents

Overview .....	4
Getting Started .....	6
Step 1 Preparation .....	6
Check the supplied accessories .....	6
Insert the battery into the Remote Commander .....	6
Connect the aerial .....	6
Step 2 Tuning in to TV Stations .....	7
Choose a language .....	7
Display the menu .....	7
Preset Channels automatically .....	8
Preset Channels manually .....	9
Additional Presetting Functions .....	10
Sorting Programme Positions .....	10
Using "Further Programme Preset" .....	11
Skipping Programme Positions .....	12
Captioning a Station Name .....	12
Parental Lock .....	13
Tuning in a Channel Temporarily .....	13
Operating Instructions .....	14
Watching the TV .....	14
Switching the TV on and off .....	14
Selecting TV Programmes .....	14
Adjusting the Volume .....	14
Operating the TV Using the Buttons on the TV .....	14
Watching Teletext or Video Input .....	15
More Convenient Functions .....	15
Adjusting and Setting the TV Using the Menu .....	16
Adjusting the Picture and Sound .....	16
Graphic Equalizer .....	17
Using the Sleep Timer .....	17
PAP (Picture and Picture) .....	18
Operating Screen Mode/PAP Using the Menu .....	19
Auto Format .....	19
Teletext .....	20
Direct Access Functions .....	20
Using the Teletext Menu .....	21
User Page Bank System .....	22
Connecting and Operating Optional Equipment .....	23
Connecting Optional Equipment .....	23
Selecting Input and Output .....	24
Using AV Preset .....	25
Remote Control of Other Sony Equipment .....	26
For Your Information .....	27
Optimum Viewing Area .....	27
Cleaning of the Air Filter .....	28
Replacing the Lamp .....	29
Troubleshooting .....	30
Specifications .....	30
Warning Indicators .....	31
Stabilizing the Projection TV .....	31
Television Channel Number Guide .....	back cover

Getting Started	GB
Operating Instructions	GB

# Overview

This section briefly describes the buttons and controls on the TV set and on the Remote Commander. For more information, refer to the pages given next to each description.

## TV set-front

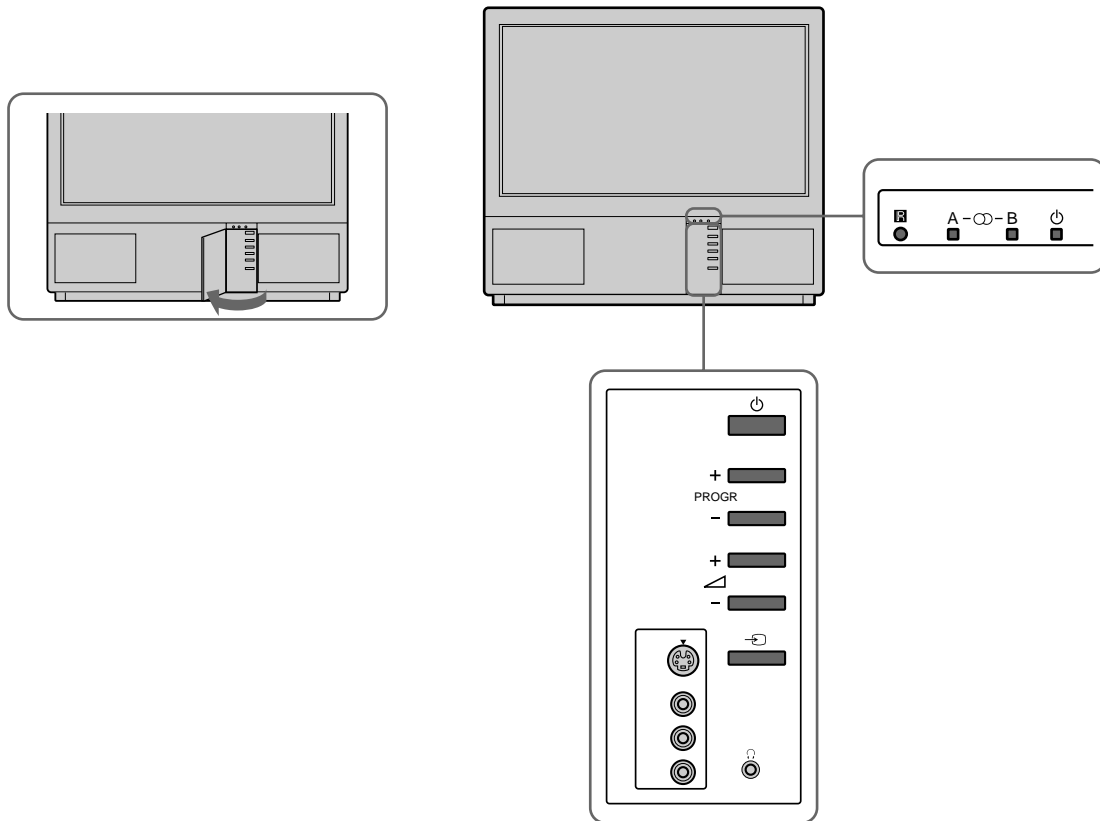

Symbol	Name	Refer to page
⏻	Main power switch	14
⏻	Standby indicator	14
A - μ - B	Stereo A/B indicators	16
PROGR +/-	Programme	14
Δ +/-	Volume buttons	14
↺ ↻ ↻	Input select buttons	15
λ	Headphones jack	23
Ⓜ 3, Ⓜ 3, Ⓜ 3	Input jacks (S video/video/audio)	24

### Remote commander

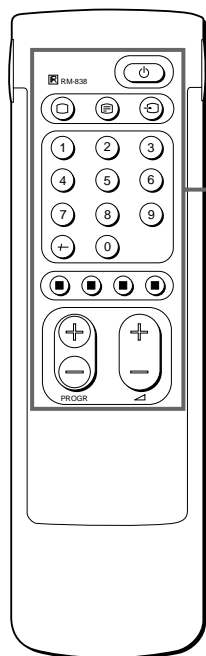

Simple side

TV/Teletext operation

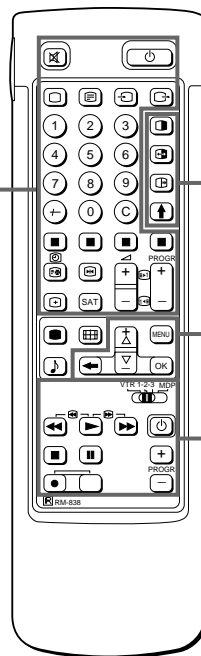

Full-Function side

PAP operation

Menu operation

Video operation

Note  
The SAT button does not operate with this TV.

#### TV/Teletext operation

Symbol	Name	Refer to page
o	Mute on/off button	15
φ	Standby button	14
O	TV power on/TV mode selector button	14
-	Teletext button	15
↶	Input mode selector	15
↷	Output mode selector	24
1,2,3,4,5,6,7,8,9 and 0	Number buttons	14
-/-	Double-digit entering button	14
C	Direct channel entering button	10
Δ+/-	Volume control button	14
PROGR +/-	Programme selectors	14
Ⓜ 1 1 3	Teletext page access buttons	20
●	Picture adjustment button	16
♪	Sound adjustment button	16
☰	On-screen display button	15
[	Teletext hold button	20
#	Time display button	15
ΛΛΛΛ	Fastext buttons	20
⏸	"Freeze" button	15
⏏	Button to change Screen Format	15

#### PAP (Picture-and-picture) operation

Symbol	Name	Refer to page
⏸	PAP on/off button	18
X	PAP source selector	18
↔	Swap button	18
⏸	PAP freeze button	18

#### Menu operation

Symbol	Name	Refer to page
MENU	Menu on/off button	7
>+/?-	Select buttons	7
OK	OK(confirming)button	7
≡	Back button	7

#### Video operation

Symbol	Name	Refer to page
VTR1/2/3, MDP	Video equipment selector	26
:: - :: Δ	Video equipment operation buttons	26
∅ α φ	buttons	
PROGR +/-		

# Getting Started

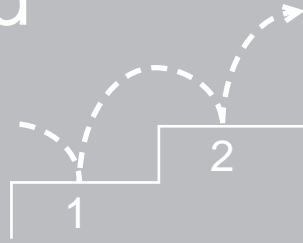

## Step 1 Preparation

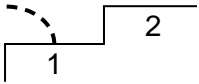

### 1 Check the supplied accessories

When you've taken everything out of the carton, check that you have these items:

- RM-838 Remote Commander
- One IEC designation R6 battery
- Lamp (1)
- Wrench (1)
- Bracket (2)

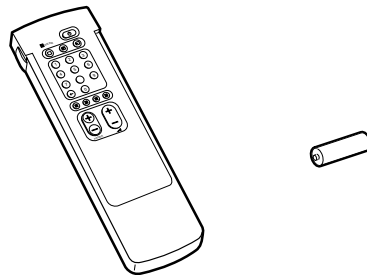

### 2 Insert the battery into the Remote Commander

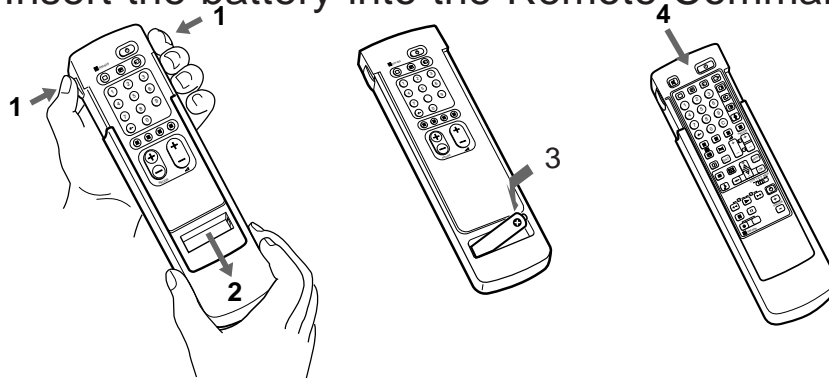

Remove the cover.

Check the correct polarities.

Refit the outside cover making sure that the Full-Function side is visible to use the menu in step 2.

Note: Always remember to dispose of used batteries in an environmental friendly way.

### 3 Connect the aerial

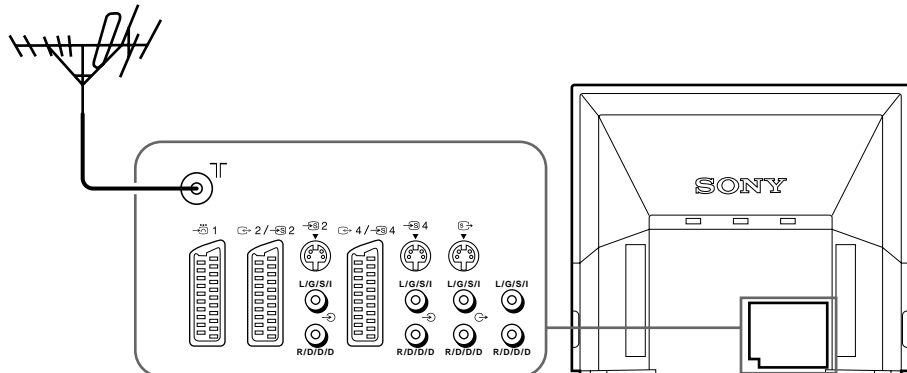

Fit an IEC aerial connector attached to 75-ohm coaxial cable (not supplied) to the ) socket at the rear of the TV.

# Step 2 Tuning in to TV Stations

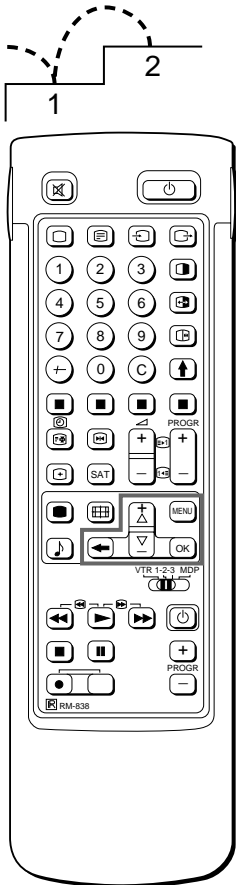

Once you have set up the TV, you can choose the language of the menu. Then, you should preset the channels (up to 100 channels) by choosing either the automatic or manual method. The automatic method is easier if you want to preset all receivable channels at once. Use the manual method if you only have a few channels and want to preset channels one by one.

## Before you begin

- Check that the Full-Function side of the Remote Commander is visible.
- Locate Menu operation buttons on the Remote Commander. They are shaded in the illustration at the left.

## 1 Choose a language

- 1 Press  $\phi$  on the TV.  
The TV will switch on. If the standby indicator on the TV is lit, press O or a number button on the Remote Commander.
- 2 Press the MENU button.  
The LANGUAGE menu appears. (See Fig. 1.)



- 3 Select the language you want with > + or ? – and press OK.

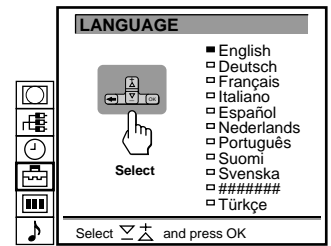

Fig. 1

## 2 Display the menu

Press MENU.

The main menu appears. (See Fig. 2.)

Using > + or ? – select the symbol and press OK.

Now, choose one of the methods described overleaf:

“Preset Channels Automatically”

or

“Preset Channels Manually”

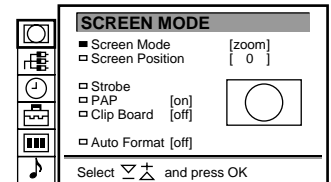



Fig. 2

To go back to main menu  
Keep pressing  $\equiv$ .

To go back to the normal TV picture  
Press MENU. Normal TV picture will be restored after one minute if menu functions are not selected.

Note on the Demo function  
If you choose Demo in the Installation menu, you can see a sequential demonstration of the menu functions. Press MENU to stop the function.

### 3 Preset channels automatically

- 1 Select the symbol  for "Preset" with >+ or ?- and press OK. The PRESET menu appears. (See Fig. 3.)
- 2 Select "Auto Programme" with >+ or ?- and press OK. The AUTO PROGRAMME menu appears. (See Fig. 4.)
- 3 Press OK.  
Select if necessary the TV broadcast system (B/G for Western European or D/K for Eastern European countries) with >+ or ?- and press OK. The first element of the "PROG" number will be highlighted.
- 4 Select the programme (number button) from which you want to start presetting. Select the first element of the double-digit number with >+ or ?- or the number buttons (e.g., For "04," select "0" here) and press OK.  
The second element of "PROG" will be highlighted.
- 5 Select the second element of the double-digit number with >+ or ?- or the number buttons (e.g., For "04," select "4" here) (See Fig. 5) and press OK.
- 6 Select "C" or "S" with >+ or ?- and press OK.  
The automatic channel presetting starts.  
When presetting is finished, the preset menu reappears. All available channels are now stored on successive number buttons. Press menu to restore normal TV picture.

To go back to the main menu  
Keep pressing ≡.

To stop automatic channel presetting  
Press ≡ on the Remote Commander.

**Notes**

- After presetting the channels automatically, you can check which channels are stored on which programme positions. For details, see "Displaying the Programme Table" on page 15.
- You can sort the programme positions to have them appear on screen in the order you like. For details, see "Sorting Programme Positions" on page 10.

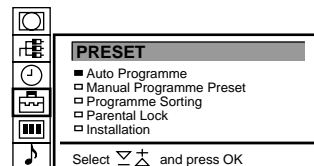

Fig. 3

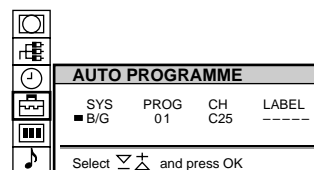

Fig. 4



Fig. 5



Use this method if there are only a few channels in your area to preset or if you want to preset channels one by one. You may also allocate programme numbers to various video input sources.

If you have made a mistake Press  $\equiv$  to go back to the previous position.

To return to the main menu Keep pressing  $\equiv$ .

To go back to the normal TV picture Press MENU.

### 3 Preset channels manually

- 1 Select the symbol  for "Preset" with  $\triangleright+$  or  $\triangleright-$  and press OK. The PRESET menu appears. (See Fig. 6.)
- 2 Select "Manual Programme Preset" with  $\triangleright+$  or  $\triangleright-$  and press OK. The MANUAL PROGRAMME PRESET menu appears. (See Fig. 7.)
- 3 Using  $\triangleright+$  or  $\triangleright-$ , select the programme position (number button) to which you want to preset a channel, and press OK.
- 4 Select, if necessary the TV broadcast system or a video input source (EXT) with  $\triangleright+$  or  $\triangleright-$ .
- 5 Then press OK. The CH position will be highlighted. (See Fig. 8.)
- 6 Using  $\triangleright+$  or  $\triangleright-$ , select C (to preset a regular channel), S (cable channel) or F (to tune in by frequency) and press OK. The first element of the "CH" number will be highlighted. If you have selected EXT in step 5, select the video input source with  $\triangleright+$  or  $\triangleright-$ . (See Fig. 9.)

There are two ways to preset channels, If you know the channel number, go to step "7-Manual,"

or  
If you don't know the channel number, go to step "7-Search."

#### 7 Manual

- a Select the first element of the "CH" number with  $\triangleright+$  or  $\triangleright-$  or the number buttons and press OK. The second element of the "CH" number will be highlighted.
- b Select the second element of the number with  $\triangleright+$  or  $\triangleright-$  or the number buttons. The selected number appears. (See Fig. 10.)
- c Press OK The "SEARCH" position is highlighted and the selected channel is now stored. (See Fig. 11.)
- d Press OK until the cursor appears by the next programme position.
- e Repeat steps 3 to 7 to preset other channels.

#### 7 Search

- a Press OK repeatedly until the colour of the SEARCH position changes.
- b Start searching for the channel with  $\triangleright+$  (up) or  $\triangleright-$  (down). The CH position changes colour. (See Fig. 12.) The CH number starts counting up or downwards. When a channel is found, it stops. (See Fig. 13.)
- c Press OK if you want to store this channel. If not, press  $\triangleright+$  or  $\triangleright-$  to continue channel searching.
- d Press OK until the cursor appears by the next programme position.
- e Repeat steps 3 to 7 to preset other channels.

To tune in a channel by frequency After selecting F in step 6, enter three digits using the number buttons.

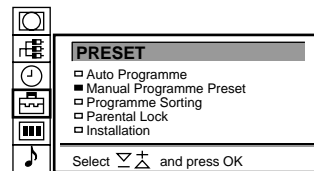

Fig. 6

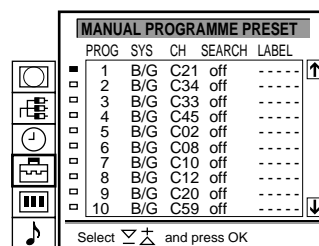

Fig. 7

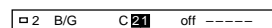

Fig. 8

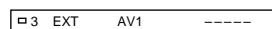

Fig. 9

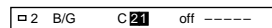

Fig. 10

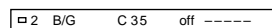

Fig. 11

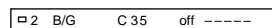

Fig. 12

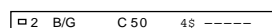
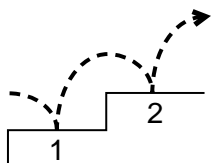

Fig. 13

# Additional Presetting Functions



This section shows you additional presetting functions such as sorting or skipping programme positions, captioning a station name, manual fine-tuning, and using the parental lock.

## Before you begin

- Check that the Full Function side of the Remote Commander is visible.
- Locate the Menu operation buttons.

## Sorting Programme Positions

With this function, you can sort the programme positions to a preferable order.

- 1 Press MENU to display the main menu.
- 2 Select the symbol  for "Preset" with >+ or ?- and press OK. The PRESET menu appears.
- 3 Select "Programme Sorting" with >+ or ?- and press OK. The PROGRAMME SORTING menu appears. (See Fig. 14.)
- 4 Using >+ or ?-, select the programme position you want to move to another and press OK. The colour of the selected position changes. (See Fig. 15.)
- 5 Using >+ or ?-, select the programme position to which you want to move the channel of the programme position selected in step 4 and press OK. Now the programme positions have been sorted. (See Fig. 16.)
- 6 Repeat steps 4 and 5 to sort other programme positions.

### PROGRAMME SORTING

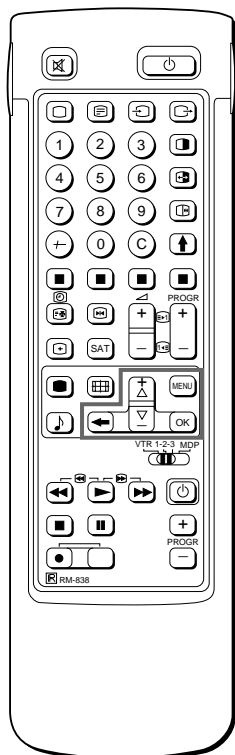

PROGRAMME SORTING		
PROG	CH	LABEL
1	C03	BBC 2
2	C04	ITV
3	C07	MBC
4	C09	----
5	C12	----
6	C13	----
7	C14	----
8	C15	BBC 1

Move PR 8 to PR --



Select   and press OK

Fig. 14

8	C15	BBC1
---	-----	------

Fig. 15

PROGRAMME SORTING		
PROG	CH	LABEL
1	C15	BBC 1
2	C03	BBC 2
3	C04	ITV
4	C07	MBC
5	C09	----
6	C12	----
7	C13	----
8	C14	----

Move PR 1 to PR --





Select   and press OK

Fig. 16

For higher programme positions  
The display scrolls automatically.

If you have made a mistake  
Press  to go back to the previous position

To go back to main menu  
Keep pressing .

To go back to the normal TV picture  
Press MENU.

## Using “Further Programme Preset”

Using the menu “further Programme Preset” you can

- a) in case of a strong local aerial signal (striped picture) attenuate the signal individually for each programme position (RF attenuator).
- b) individually adjust and store the volume level of each channel (Volume offset).
- c) in case of a strong sound signal (distorted sound), attenuate the sound signal for each programme position.
- d) use the manual fine tuning to obtain a better picture reception, if the picture is distorted. Normally the AFT (automatic fine tuning) is operating.

- 1 Press MENU to display the main menu.
- 2 Select the symbol  for “Preset” with >+ or ?- and press OK. The PRESET menu appears.
- 3 Select “Installation” with >+ or ?- and press OK. The INSTALLATION menu appears.
- 4 Select “Further Programme Preset” with >+ or ?- and press OK. The FURTHER PROGRAMME PRESET menu appears (See Fig. 17).
- 5 Using >+ or ?- select the desired programme position and press OK once to select a) “ATT” (RF Attenuator), twice to select b) “VOL” (Volume offset), three times to select c) “IN-AMP” (Input Amplifier) or four times to select d) AFT (Automatic Fine Tuning). The selected item changes colour.

To adjust or change:

- a) RF attenuator (ATT)
 

Using >+ or ?- select “On” for the selected programme position. Press OK to confirm the selection. Repeat step 5 to attenuate other programme positions.
  - b) Volume offset (VOL)
 

Using >+ or ?- you can adjust the volume level for the selected programme position within a range form -7 to +7. Press OK to store the volume level. Repeat step 5 to set the volume level for other programme positions.
  - c) IN-AMP (input amplifier)
 

Using >+ or ?- select “Off” for the selected programme position. Press OK to confirm the selection. Repeat step 5 to switch off the input amplifier for other programme positions.
  - d) AFT
 

Using >+ or ?- you can fine-tune the channel within a range from -15 to +15. Press OK to store the fine-tuned level. Repeat step 5 to fine-tune the other channels.
- 6 Press MENU to return to the normal TV mode.

To reactivate AFT (Automatic Fine Tuning)  
Repeat from the beginning and select “ON” in step 5.

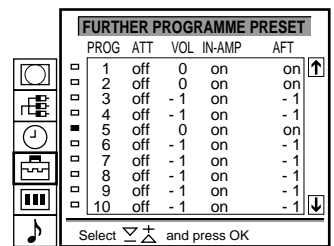



Fig. 17

**MANUAL PROGRAMME PRESET**

## Skipping Programme Positions

You can skip unused programme positions when selecting programmes with PROGR +/- buttons. However, the skipped programmes may still be called up when you use the number buttons.

- 1 Press MENU to display the main menu.
- 2 Select the symbol  for "Preset" with >+ or ?- and press OK. The PRESET menu appears.
- 3 Select "Manual Programme Preset" with >+ or ?- and press OK. The MANUAL PROGRAMME PRESET menu appears. (See Fig. 18.)
- 4 Using >+ or ?-, select the programme position which you want to skip and press OK. The "SYS" position changes colour.
- 5 Press >+ or ?- until "--" appears in the SYSTEM position. (See Fig. 19.)
- 6 Press OK. (See Fig. 20.)  
When you select programmes using the PROGR +/- buttons, the programme position will be skipped.
- 7 Repeat steps 4 to 6 to skip other programme positions.

If you have made a mistake  
Press ≡ to go back to the previous position.

To go back to main menu  
Keep pressing ≡.

To go back to the normal TV picture  
Press MENU.

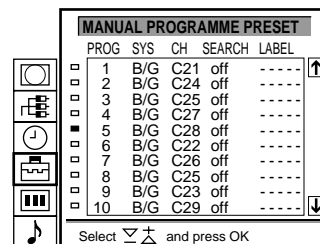

Fig. 18

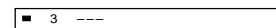



Fig. 19



Fig. 20

## Captioning a Station Name

Programme names are usually automatically taken from Teletext if available, You can also "name" a channel or an input video source using up to five characters (letters or numbers) to be displayed on the TV screen (e.g. BBC1). Using this function, you can easily identify which channel or video source you are watching.

- 1 Press MENU to display the main menu.
- 2 Select the symbol  for "Preset" with >+ or ?- and press OK. The PRESET menu appears.
- 3 Select "Manual Programme Preset" with >+ or ?- and press OK. The MANUAL PROGRAMME PRESET menu appears. (See Fig. 21.)
- 4 Using >+ or ?-, select the programme position you want to caption and press OK repeatedly until the first element of the LABEL position is highlighted.
- 5 Select a letter or number with >+ or ?- and press OK. The next element will be highlighted.  
Select other characters in the same way. If you want to leave an element blank, select - and press OK. (See Fig. 22.)
- 6 After selecting all the characters, press OK repeatedly until the cursor appears by the next programme position (at the left margin). Now the caption you chose is stored. (See Fig. 23.)
- 7 Repeat steps 5 and 6 to caption names for other channels.

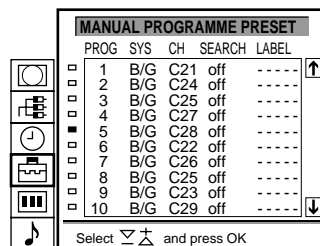

Fig. 21

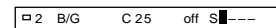

Fig. 22

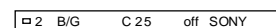

Fig. 23



**MANUAL PROGRAMME PRESET**

PARENTAL LOCK

# Parental Lock

You can prevent undesirable broadcasts from appearing on the screen. We suggest you use this function to prevent children from watching programmes which you consider unsuitable.

If you try to select a programme that has been blocked  
The message "LOCKED" appears on the blank TV screen.

- 1 Press MENU to display the main menu.
- 2 Select the symbol  for "Preset" with >+ or ?- and press OK. The PRESET menu appears.
- 3 Select "Parental Lock" with >+ or ?- and press OK. The PARENTAL LOCK menu appears. (See Fig. 24.)
- 4 Using >+ or ?-, select the programme position you want to block and press OK. The symbol  appears in front of the programme number indicating that this programme is now blocked. (See Fig. 25.)
- 5 Repeat step 4 to block other programme positions.

## Cancelling blocking

- 1 On the PARENTAL LOCK menu, select the programme position you want to unblock with >+ or ?-.
- 2 Press OK. The symbol  disappears indicating that the blocking has been cancelled.

# Tuning in a Channel Temporarily

You can tune in to a channel temporarily, even when it has not been preset. Use the buttons on the Full-Function side of the Remote Commander.

- 1 Press C on the Remote Commander. For cable channels, press C twice. The indication "C" ("S" for cable channels) appears on the screen. (See Fig. 26.)
- 2 Enter the double-digit channel number using the number buttons (e.g. for channel 4, first press 0, then 4). The channel appears. However, the channel will not be stored.

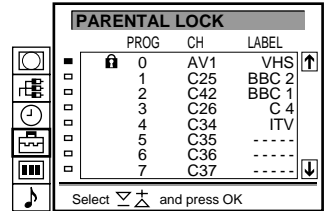

Fig. 24

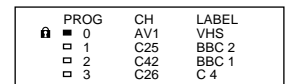
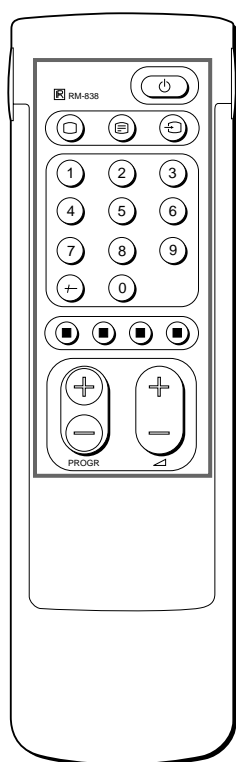

Fig. 25



Fig. 26

## Watching the TV



**If no picture appears when you depress  $\phi$  on the TV and if the standby indicator on the TV is lit, the TV is in standby mode.**

Press O or one of the number buttons to switch it on.

This section explains the basic functions you use while watching TV. Most of the operations can be done using the simple side of the Remote Commander.

### Switching the TV on and off

#### Switching on

Depress  $\phi$  on the TV.

#### Switching off temporarily

Press  $\phi$  on the Remote Commander.

The TV enters standby mode and the standby indicator on the front of the TV lights up in red.

#### To switch on again

Press O, PROGR +/-, or one of the number buttons on the Remote Commander.

#### Switching off completely

Depress  $\phi$  on the TV and indicator on the front of the TV lights up in amber.

### Selecting TV Programmes

Press PROGR +/- or press the number buttons.

#### To select a double-digit number

Press -/-, then the numbers.

For example, If you want to choose 23, press -/-, 2 and 3.

### Adjusting the Volume

Press  $\Delta$  +/-.

### Operating the TV Using the Buttons on the TV

To select the programme number, press the PROGR +/- buttons.

To adjust the volume, press the  $\Delta$  +/- buttons.

To select the video input picture, press the  $\rightarrow$  button.

To reset picture and sound controls to the factory preset level (RESET function), press PROGR +/- buttons simultaneously.

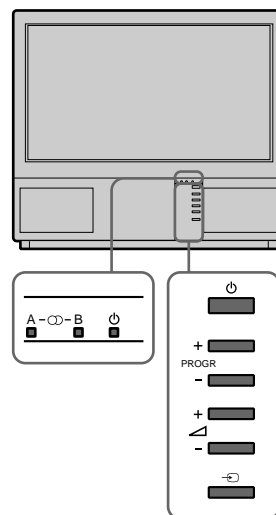

## Watching Teletext or Video Input

### Watching teletext

- 1 Press **\_** to view the teletext.
- 2 For teletext operation, enter a 3-digit page number with the number buttons to select a page.  
For fastext operation, press one of the coloured buttons.  
For both operations, press **ç** (PAGE +) for the next page or **Y** (PAGE -) for the preceding page.
- 3 To go back to the normal TV picture, press **O**.

### Watching a video input picture

- 1 Press **↺** repeatedly until the desired video input appears.
- 2 To go back to the normal TV picture, press **O**.

## More Convenient Functions

Use the Full-Function side of the Remote Commander.

### Displaying the on screen indications

- Press **≡** once to display all the indications. They will disappear after a few seconds.
- Press **≡** twice to have the programme number and label stay on screen. Press twice again to make the indications disappear.

### Muting the sound

Press **o**.

To resume normal sound, press **o** again.

### Displaying the time

Press **#**. This function is available only when teletext is broadcast.

To make the time display disappear, press **#** again.

### Displaying the Programme Table

Press **OK**. A Programme Table will be displayed on the left side of the TV screen. (See Fig. 27.)

### Selecting TV programmes

Press **PROGR +/-** or select the desired programme position using **>+** or **?-** and press **OK**.

To make the Programme Table disappear, press **MENU**.

### Freezing the Picture

When watching the TV you have the possibility to “freeze” the picture. Press **⏸**. Press the button again to return to the normal TV picture.

### Changing the Screen format

Press **⏏** repeatedly to change the Screen mode as follows:

4:3 (4:3 picture)

- A Smart (imitation of 16:9 for 4:3 broadcast)
- A Zoom (imitation of 16:9 for movies broadcast in cinemascopic format)

or

- A Wide (for 16:9 broadcast).
- See also page 19 for more information.

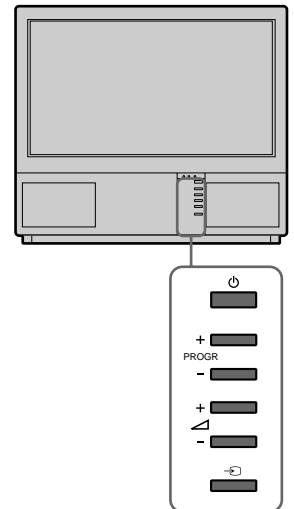

For details of the teletext operation, refer to page 20.

For details of the video input picture, refer to page 24.

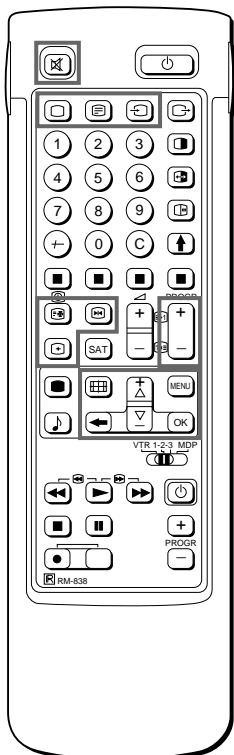

1	BBC	↑
2	SAT	
3	TV5	
4	C02	
5	C15	
6	RTL	
7	SKY	
8	S34	
9	AV1	
10	MTV	↓

Fig. 27

# Adjusting and Setting the TV Using the Menu

**PICTURE CONTROL**

**SOUND CONTROL**

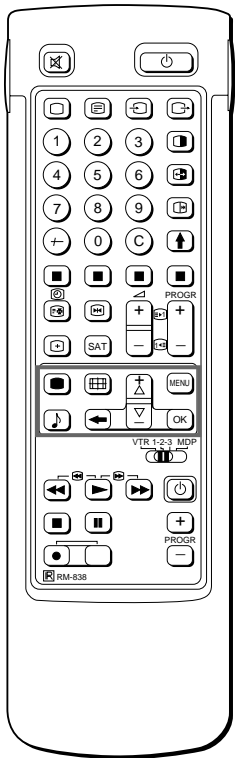

## Adjusting the Picture and Sound

Although the picture and sound are adjusted at the factory, you can adjust them to suit your own taste. You can also select dual sound (bilingual) programmes when available or adjust the sound for listening with the headphones. Also you have the possibility to adjust the sound to your individual taste using the Graphic Equalizer and special Sound effects.

- 1 Press (for picture) or (for sound) on the Remote Commander.  
or  
Press MENU and select the symbol for Picture Control or Sound Control, then press OK.  
The PICTURE CONTROL or SOUND CONTROL menu appears. (See Fig. 28 or Fig. 29.)
- 2 Using >+ or ?-, select the item you want to adjust and press OK. The selected item changes colour. (See Fig. 30.)
- 3 Adjust the setting with >+ or ?- and press OK. The cursor appears beside the next item (at the left margin). (See Fig. 31.)  
For the effect of each control, see the table below.
- 4 Repeat steps 2 and 3 to adjust other items.
- 5 Press MENU to return to TV picture.

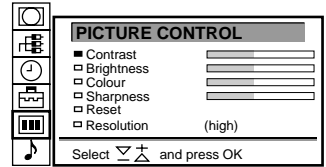

Fig. 28

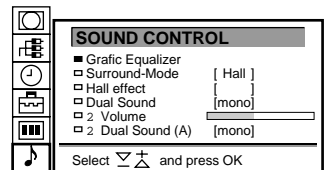

Fig. 29



Fig. 30

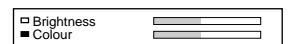

Fig. 31

### Effect of each control

PICTURE CONTROL	Effect
Contrast	Less  More
Brightness	Darker  Brighter
Colour	Less  More
Hue	Greenish  Reddish
Sharpness	Softer  Sharper
RESET	Resets picture to the factory preset levels.
Resolution	Normal high: obtain a high quality picture

**If you have made a mistake**  
Press to go back to the previous position.  
**To go back to the main menu**  
Keep pressing .

- Notes**
- HUE is only available for NTSC colour systems.
  - Hall Surround is not available via headphones.

**Note on LINE OUT**  
The audio level and the dual sound mode output from the > jack on the rear correspond to the HEADPHONES VOLUME and DUAL SOUND settings.

**When watching a video input source with stereo sound**  
You can select DUAL SOUND to change the sound.

SOUND CONTROL	Effect
Graphic Equalizer	(See page 17 for more information)
Surround Mode	Off: Normal n Dolby n Hall 
Hall Effect (only if "Hall" is on)	Choice between different hall effects Room n Dome n Arena 
Dual Sound	A: left channel B: right channel Stereo Mono The selected mode of the A-μ-B indicator on the TV lights up.
Headphones: 2 Volume	Less  More
2 Dual Sound	A: channel 1 n B: channel 2 n PAP (if PAP is switched on you can select the PAP sound for the headphones) Stereo n Mono



## Graphic Equalizer

Using this function you can individually adjust the sound by cutting and boosting selected frequencies. You can also select between the following modes:

Flat n Pop n Rock n Jazz n Vocal n User

- 1 Select "Sound Control" in the main menu, then select "Graphic Equalizer" using >+ or ?- and press OK. The GRAPHIC EQUALIZER menu appears (See Fig. 32).
- 2 Press OK. The colour of "Mode" changes. Select the desired mode with >+ or ?- and press OK.
- 3 If you want to modify a mode, select the desired bar of a frequency band using >+ or ?- and press OK. The selected frequency changes colour. Using >+ or ?- adjust the level of frequency and press OK. In this way you can adjust all 5 graphic bars.
- 4 Press MENU to return to the normal TV mode.

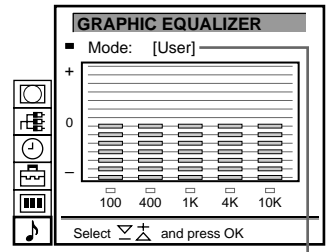

Fig. 32

Flat  
Pop  
Rock  
Jazz  
Vocal  
User

Note: The modifications made in "USER" mode will be stored. All other settings are reset to factory-set level when you change to another mode.

## TIMER

To switch off the timer  
Select "OFF" in step 3.

To check the remaining time  
Press  $\boxtimes$ .

To go back to the normal TV picture  
Press MENU.

## Using the Sleep Timer

You can select a time period after which the TV automatically switches into standby mode.

- 1 Using >+ or ?- select the symbol t for "Timer" and press OK. The TIMER menu appears (see Fig. 33).
- 2 Press OK.  
The time period option changes colour.
- 3 Select the time period with >+ or ?-.  
The time period (in minutes) changes as follows:  
10 n 20 n 30 n 40 n 50 n 60 n 70 n 80 n 90
- 4 After selecting the time period, press OK.  
The cursor moves back to the left margin and the timer starts counting.  
One minute before the TV switches into standby mode, a message is displayed on the screen.

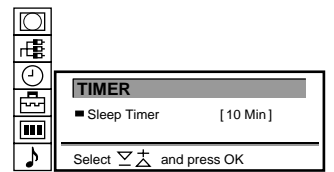
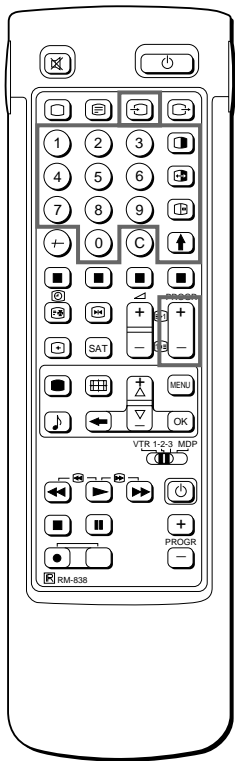

Fig. 33

# PAP (Picture and Picture)



With this function you can display two screens at the same time. In this way you can watch two TV programmes at the same time. Also you can watch or monitor the video output from any connected equipment (for example from a VCR) while watching TV or vice versa. For information about connection of other equipment, refer to page 23.



## Switching PAP on and off

Press to display the screens in 8:9 format.

Press twice to display the screens in 4:3 format.

The PAP screen will be displayed next to the main TV screen.

The PAP screen will come from the source chosen when the TV was last used.

To switch PAP off

Press repeatedly.

## Selecting PAP source

Press >.

The symbol > will be displayed at the bottom, left-hand corner of the screen.

Press PROGR +/-, the number buttons or ... to select the desired source for the PAP screen.

## Notes

- RGB input source cannot be displayed in PAP.
- PAP is not available in the Zoom mode.
- The sound of the right screen is only available via the headphones.
- The picture quality of the TV screen and PAP may differ.

## Swapping screens

Press .

The main screen will switch the picture with the PAP screen.

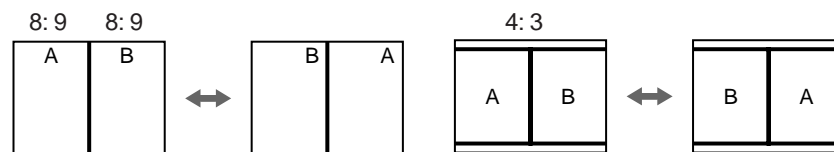

## Freezing the picture

You have the possibility to "freeze" the picture of the PAP screen.

Press once to freeze and twice to return to the normal screen.

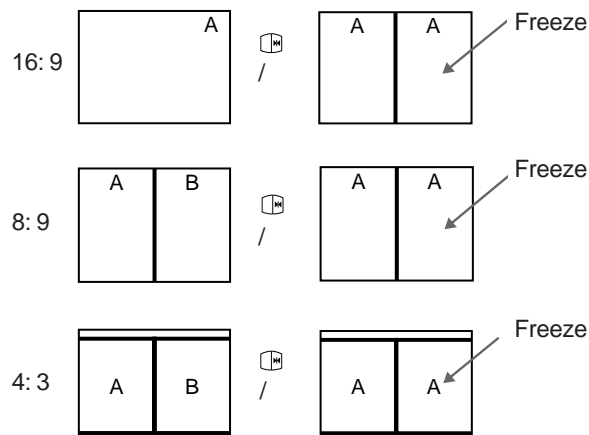

## Operating Screen Mode/PAP using the Menu

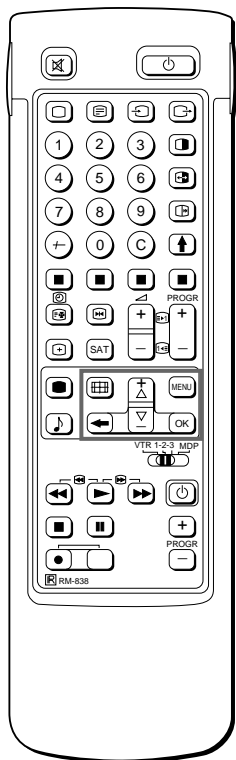

When you want to select the screen mode  
You can also select the screen mode by pressing the  button on the Remote Commander.

Using the Screen Mode menu you have the possibility to change the aspect ratio for the TV display for wide screen effects, operate the PAP Mode or reproduce the main picture image by image (Strobe function).

- 1 Press MENU to display the main menu.
- 2 Select the symbol  for "Screen Mode" with >+ or ?- and press OK. The SCREEN MODE menu appears (See Fig. 34).

You have the choice among the following modes:

4:3 for normal ratio 4:3 (See Fig. 35).

Smart: imitation of wide screen effect (16:9) for 4:3 broadcasts (See Fig. 36).

Zoom imitation of wide screen effect (16:9) for movies broadcast in cinemascopic format (See Fig. 37).

or

Wide: for 16:9 broadcasts (See Fig. 38).

- a) Changing the Screen position (only for Zoom mode)  
When using the Zoom mode part of the picture at the top and bottom will be cut off. With the help of the function "Screen position" you can move the screen up- or downwards in order to see the cut-off part of the screen (e.g., to read the subtitles).

Using >+ or ?- select "Screen position" and press OK. The selected item changes colour. Using >+ or ?- adjust the screen position and press OK.

- b) Strobe Mode  
Using >+ or ?- select "Strobe" and press OK. Now the TV picture is displayed image by image, creating a slow motion effect (See Fig. 39). Using >+ or ?- select the speed of the motion (3 different speeds are available). Press OK to return to the normal TV mode.
- c) Switching PAP on and off  
Using >+ or ?- select "PAP" and press OK. Using >+ or ?- select "1" to display the PAP screen in 8:9 format, "2" for 4:3 format and "OFF" to switch it off and press OK.
- d) Freezing the PAP screen  
Using >+ or ?- select "Clip Board" and press OK. Using >+ or ?- select "On" to freeze the PAP screen and "Off" to restore the normal picture.

## Auto Format

If you preset Auto Format to ON and the 16 : 9 format signal is being transmitted, the screen mode automatically changes from any mode to the 16 : 9 mode. When the 16 : 9 format programme is finished, the screen mode automatically returns to the previous mode.

- 1 Press MENU to display the main menu.
- 2 Select the symbol  for "Screen Mode" with >+ or ?- and press OK. The SCREEN MODE menu appears.
- 3 Select "Auto Format" with >+ or ?- and press OK.
- 4 Select ON or OFF with >+ or ?- and press OK.

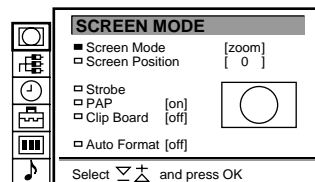

Fig. 34

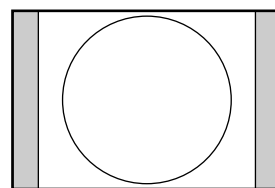

Fig. 35

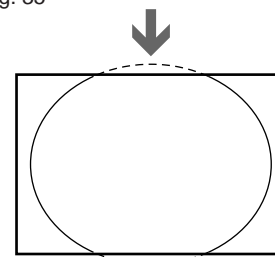

Fig. 36

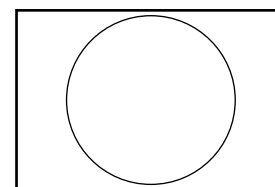

Fig. 37

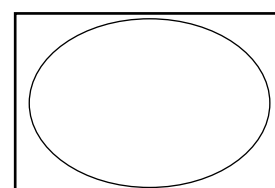

Fig. 38

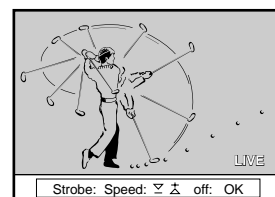
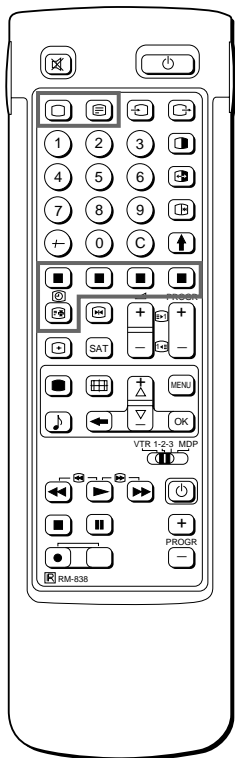

Fig. 39

# Teletext



**Note**  
Teletext errors may occur if the broadcasting signals are weak.

With the simple side of the Remote Commander you can switch teletext on and off, operate Fasttext, and directly select page numbers.

**Note**  
Fasttext operation is only possible, if the TV station broadcasts Fasttext signals.

TV stations broadcast an information service called Teletext via the TV channels. Teletext service allows you to receive various information pages such as weather reports or news at any time you want. For advanced teletext operation, use the buttons on the Full-Function side of the Remote Commander.

## Direct Access Functions

### Switching Teletext on and off

- 1 Select the TV channel which carries the teletext broadcast you want to watch.
- 2 Press **\_** to switch on teletext.  
A teletext page will be displayed (usually the index page).  
If there is no teletext broadcast, "No text available" is displayed on the information line at the top of the screen.

To switch teletext off  
Press **O**.

### Selecting a teletext page

With direct page selection

Use the number buttons to input the three digits of the chosen page number.

If you have made a mistake, type in any three digits. Then re-enter the correct page number.

With page-catching

- 1 Select a teletext page with a page overview (e.g. index page).
- 2 Press **OK**. Using **>+** or **?-**, select the desired page. "Page Catching" will be displayed on the information line. Press **OK**. The requested page will appear in a few seconds.  
Press **\_** to resume normal teletext reception.

Accessing next or preceding page

Press **g** (PAGE+) or **G** (PAGE-).

The next or preceding page appears.

Superimposing the teletext display on the TV programme

- Press **\_** once in teletext mode or twice in TV mode.
- Press **\_** again to resume normal teletext reception.

Preventing a teletext page from being updated

- Press **[** (HOLD). The HOLD symbol "[ ]" is displayed on the information line.
- Press **\_** to resume normal teletext reception.

### Using Fasttext

With Fasttext you can access pages with one key stroke.

When a Fasttext page is broadcast, a colour-coded menu will appear at the bottom of the screen. The colours of this menu correspond to the red, green, yellow and blue buttons on the Remote Commander.

Press the corresponding coloured button on the Remote Commander which corresponds to the colour-coded menu. The page will be displayed after a few seconds.

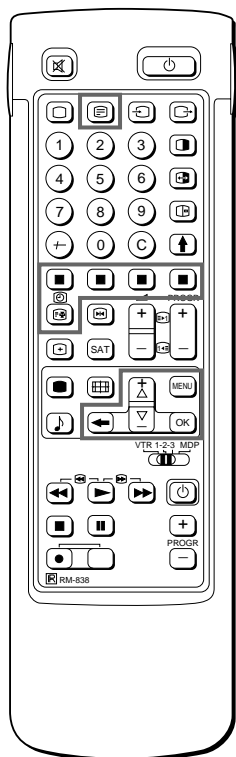

## Using the Teletext Menu

This TV is provided with a menu-guided teletext system. When teletext is switched on, you can use the menu buttons to operate the teletext menu. Select the teletext menu functions in the following way:

- 1 Press MENU. The menu will be superimposed on the teletext display. (See Fig. 40.)
- 2 Using >+ or ?-, select the teletext function you want and press OK. (See Fig. 41.)

### USER PAGES/PRESET USER PAGES

See page 22 for information about presetting and operating the user pages.

### INDEX

The index will give you an overview of the contents of the teletext and the page numbers.

### TOP/BOTTOM/FULL

For convenient reading of a teletext page, you can enlarge the teletext display with the ability to scroll up and down. After having selected the function, an information line Top/Bottom/Full will be displayed. (See Fig. 42.)

Press >+ for "Top" to enlarge the upper half. For "Bottom" keep pressing ?-, to enlarge the lower half. Press OK for "Full" to resume the normal size.

Press \_ to resume normal teletext reception.

### TEXT CLEAR

After selecting the function, you can watch a TV programme while waiting for a teletext page to be captured. (The symbol changes colour.) (See Fig. 43.)

Press \_ to resume normal teletext reception.

### SUBTITLES

Your teletext service will inform you if a TV programme is subtitled. After having selected the function the subtitles will be displayed.

### REVEAL

Sometimes pages contain concealed information, such as answers to a quiz. The reveal option lets you disclose the information. After having selected the function, an information line "REVEAL ON/OFF" will be displayed. (See Fig.44.)

Using >+ or ?-, select ON to reveal the information or OFF to conceal it again.

Press \_ to resume normal teletext reception.

### TIME PAGE

Your teletext service will inform you, if a time coded page is available. You may have a page (e.g., an alarm page) displayed at a certain time.

- 1 An information window will be displayed at the bottom of the page. Using >+ or ?- select "ON" and press OK.
- 2 To select the desired page, enter three digits for the page number (e.g., 452) using the number buttons.
- 3 To select the desired time, enter four digits for the desired time (e.g., 1800) using the number buttons. Press MENU. The selected time is displayed at the top in the left-hand corner. At the requested time, the page will be displayed. Press \_ to resume normal teletext mode.

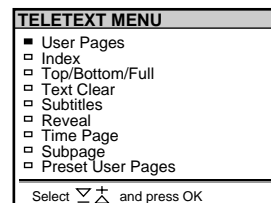

Fig. 40

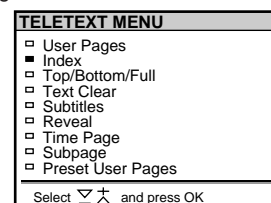

Fig. 41

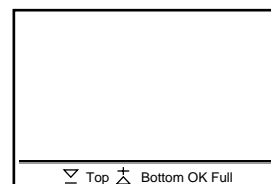

Fig. 42

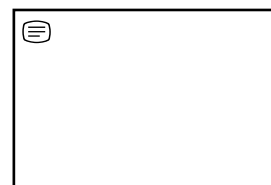

Fig. 43

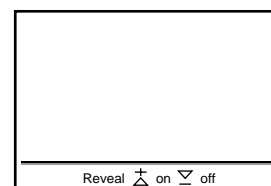

Fig. 44

**Note**

Some of the features may not be available depending on the teletext service.

Press OK to select "OFF" for the TIME PAGE setting to cancel the request.

To cancel the request  
Select Subpage and  
press OK.

If two broadcasting  
stations use the same  
Teletext  
You can preset one  
bank to 2 different  
programme positions.

## SUBPAGE

You may want to select a particular teletext page from several subpages which are rotated automatically. After having selected the function, an information line will be displayed.

To select the desired subpage, enter four digits using **PROGR +/-** or the number buttons (e.g., enter 0002 for the second page of a sequence).

## User Page Bank System

You can store up to 30 pages in the "Teletext page band system". In this way you have quick access to the pages you watch frequently.

### Storing pages

There are 5 "banks" (A to E) for 5 teletext stations. In each bank you can store 6 preferred pages (P1 to P6).

- 1 Press **\_** (if Teletext is not on already) and **MENU** to show the **TELETEXT MENU** display.
- 2 Select **PRESET USER PAGES** with **>+** or **?-** and press **OK**.
- 3 Select the desired bank with **>+** or **?-** and press **OK**. The cursor will go to the first position (P1) of the preferred pages.
- 4 Input the three digits of your first preferred page with the number buttons and press **OK**.  
The cursor will go to the second position.
- 5 Repeat step 4 for the other 5 page numbers you want to preset. If you do not want to preset all 6 page numbers available, press **OK** without inserting any number. After having finished the presetting press **OK** repeatedly until the cursor appears besides the next bank at the left margin.
- 6 Select **Allocate Bank** with **>+** or **?-** and press **OK**.
- 7 Select the programme position for which you have preset pages with **>+** or **?-** and press **OK**. (See Fig. 45.)
- 8 Select the desired bank with **>+** or **?-** (Banks A to E are available) and press **OK**.
- 9 Repeat steps 3 to 8 for the other 4 banks available.

### Displaying User Pages

- 1 Select **MENU**.
- 2 Select **User Pages** with **>+** or **?-** and press **OK**.  
A table of the stored preferred pages will be displayed. (See Fig. 46)
- 3 Select the desired page with **>+** or **?-** and press **OK**. The page will be displayed after some seconds.

or

You can use the coloured buttons on the Remote Commander to have quick access to the first four User pages. Page 1 corresponds to the red button, P2 to the green one, P3 to the yellow one and P4 to the blue button.

To select the desired page press the respective coloured button while you are in TV mode. Now the Page number of this teletext page will appear in white at the top in the left-handed corner of the TV screen. When the page number changes colour, the page is available. Press the coloured button again to display the page.

PRESET USER PAGES						
BANK	P1	P2	P3	P4	P5	P6
A	300	255	456	234	200	179
B	200	120	301	303	550	345
C	100	220	300	444		
D	128	321	255			
E	400	238	240	118	127	

Allocate Bank  
 PROG LABEL BANK PROG LABEL BANK  
 00 VHS - 04 MTV D  
 01 BBC1 A 05 SKY B  
 02 BBC2 C 06 ITV C

Select **⏏** and press **OK**

Fig. 45

USER PAGES - BANK B	
<input checked="" type="checkbox"/>	PAGE 300
<input type="checkbox"/>	PAGE 200
<input type="checkbox"/>	PAGE 203
<input type="checkbox"/>	PAGE 500
<input type="checkbox"/>	PAGE 234
<input type="checkbox"/>	PAGE 159

Select **⏏** and press **OK**

Fig. 46

# Connecting and Operating Optional Equipment

## Connecting Optional Equipment

You can connect optional audio-video equipment to this TV such as a VCR, video disc player, and stereo system.

GB

**To connect a VCR using the ) terminal**  
Connect the aerial output of the VCR to the aerial terminal ) of the TV. We recommend that you tune in the video signal to programme number "0." For details see "Preset channels manually" on page 9.

**If the picture or the sound is distorted**  
Move the VCR away from the TV.

**S/video Input (Y/C input)**  
Video signals may be separated into Y (luminance or brightness) and C (chrominance) signals. Separating the Y and C signals prevents them from interfering with one another, and therefore improves picture quality (especially luminance). This TV is equipped with 3 S Video input jacks through which these separated signals can be input directly.

**When connecting a monaural VCR**  
Connect only the white jack to both the TV and VCR.

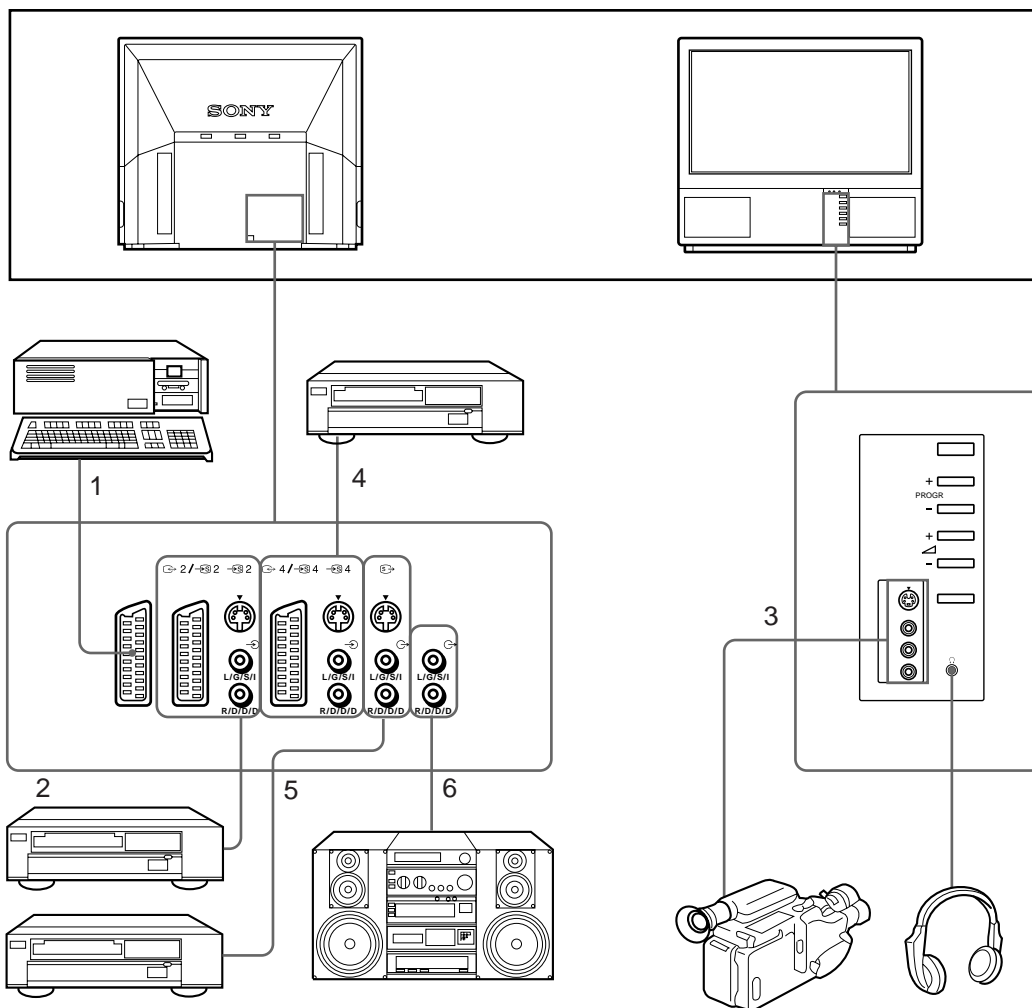

Acceptable input signal	Available output signal
1 Normal audio/video and RGB signal	Video/audio from TV tuner
2 Normal audio/video and S video signal	Video/audio from selected source
3 Normal audio/video and S video signal	No outputs
4 Normal audio/video and S video signal	Video/audio displayed on TV screen (monitor out)
5 No inputs	S/video/audio signal displayed on TV screen (monitor out)
6 No inputs	Audio signal (variable)



**Selecting input with PROGR +/- or number buttons**

You can preset video input sources to the programme positions so that you can select them with PROGR +/- or number buttons. For details, see "Preset channels manually" on page 9.

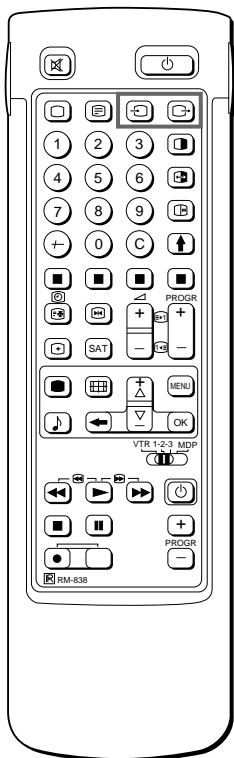

## Selecting Input and Output

This section explains how to view the video input picture (of the video source connected to your TV), and how to select the output signal using direct access buttons or the menu system.

### Selecting input

Press repeatedly to select the input source. The symbol of the selected input source will appear.

To go back to the normal TV picture  
Press 0.

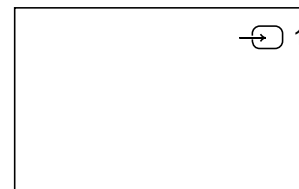

### Input modes

Symbol	Input signal
	Audio/video input through the  1 connector
	Audio/RGB input through the  1 connector
	Audio/video input through the  2/  2 connector
	Audio/S video input through the  2/  2 or  2 connector (4-pin connector)
	Audio/video input through  3 and  3 connector on the front
	S video input through the  3 connector (4-pin connector) at the front
	Audio/video input through the  4/  4 connector
	S video input through the  4/  4 or  4 connector(4-pin connector)

You can also select the input mode using the button on the TV.

### Selecting the output

The 2/ 2 connector outputs the source input from the other connectors.

Press repeatedly to select the output. The symbol of the selected output source appears.

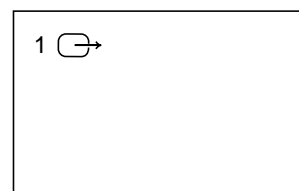

### Output modes

Symbol	2/  2 connector outputs
1	Audio/video signal from the  1 connector
2	Audio/video signal from the  2/  2 connector
2	Audio/S video signal from the  2/  2 or  2 connector (4 pin)
3	Audio/video signal from the  3,  3 connectors
3	Audio/S video signal from the  3,  3 connectors
4	Audio/video signal from the  4/  4 connector
4	Audio/S video signal from the  4/  4 or  4 connector (4 pin)
TV	Audio/video signal from the ) aerial terminal



## Using AV Preset

Using this function you can preset the desired input source (e.g. 1, RGB signal) to the respective AV input (AV 1). In this way a connected VTR will automatically switch to the RGB signal.

- 1 Select the symbol for "Preset" with >+ or ?- and press OK.
- 2 Select first "Installation", then "AV Preset" with >+ or ?- and press OK.

The AV PRESET menu appears (See Fig. 47).

- 3 Select the desired AV input with >+ or ?- and press OK.
- 4 Select the desired source with >+ or ?- and press OK.  
For the respective AV inputs you have the following possibilities:

AV1	RGB or AV	AV3	YC3 or AV
AV2	YC2 or AV	AV4	YC4 or AV

- 5 If you want to name the AV input select "Label" using >+ or ?- and press OK. Select a letter or a number with >+ or ?- and press OK. The next element will be highlighted. Select other characters in the same way. If you want to leave an element blank, select - and press OK.

After having selected all the characters, press OK repeatedly until the cursor appears by the next AV input at the left margin.

- 6 Repeat steps 3 to 6 for the other AV inputs.

### Checking and selecting the input and output sources using the menu

You can display the menu to see which input sources are selected for the TV screen and PAP screen, and which output source is selected. You can also select them on the menu display.

- 1 Select the symbol for "Video Connection" with >+ or ?- and press OK. The VIDEO CONNECTION menu appears. (See Fig. 48)

You can see which source is selected for the TV and PAP input, and for the output. If you want to select the input and output on this menu, go on to the next step.

- 2 Select TV Screen (input source for the TV screen), PAP (input source for the PAP screen), or output (output source) with >+ or ?- and press OK. One of the source items changes colour.
- 3 Select the desired source with >+ or ?-.  
For details about each source, see the table on page 24.
- 4 Press OK.  
The selected source is confirmed, and the cursor appears.
- 5 Repeat steps 2 to 4 to select the source for other inputs or outputs.

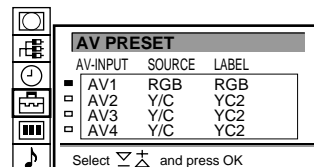

Fig.47

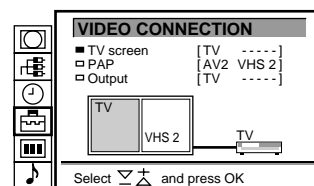
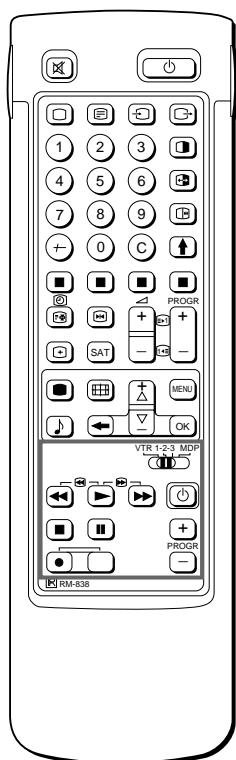

Fig. 48



When recording when you use the  $\alpha$  (record) button, make sure to press this button and the one to the right of it simultaneously.

## Remote Control of Other Sony Equipment

You can use the TV Remote Commander to control most of Sony remote-controlled video equipment such as: beta, 8 mm and VHS VCRs and video disc players.

Tuning the Remote Commander to the equipment

- 1 Set the VTR 1/2/3 MDP selector according to the equipment you want to control:
  - VTR1: Beta VCR
  - VTR2: 8 mm VCR
  - VTR3: VHS VCR
  - MDP: Video disc player
- 2 Use the buttons indicated in the illustration to operate the additional equipment.
 

If your video equipment is furnished with a COMMAND MODE selector, set this selector to the same position as the VTR 1/2/3 MDP selector on the TV Remote Commander.

If the equipment does not have a certain function, the corresponding button on the Remote Commander will not operate.

# For Your Information

## Optimum Viewing Area

For the best picture quality, try to position the projection TV so that you can view the screen from within the areas shown below.

GB

### Horizontal viewing area

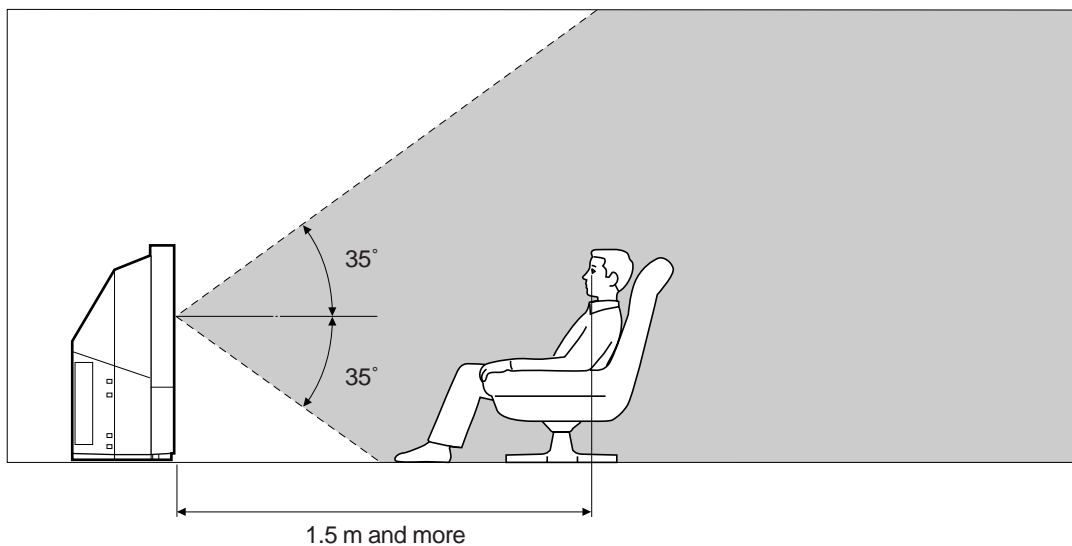

### Vertical viewing area

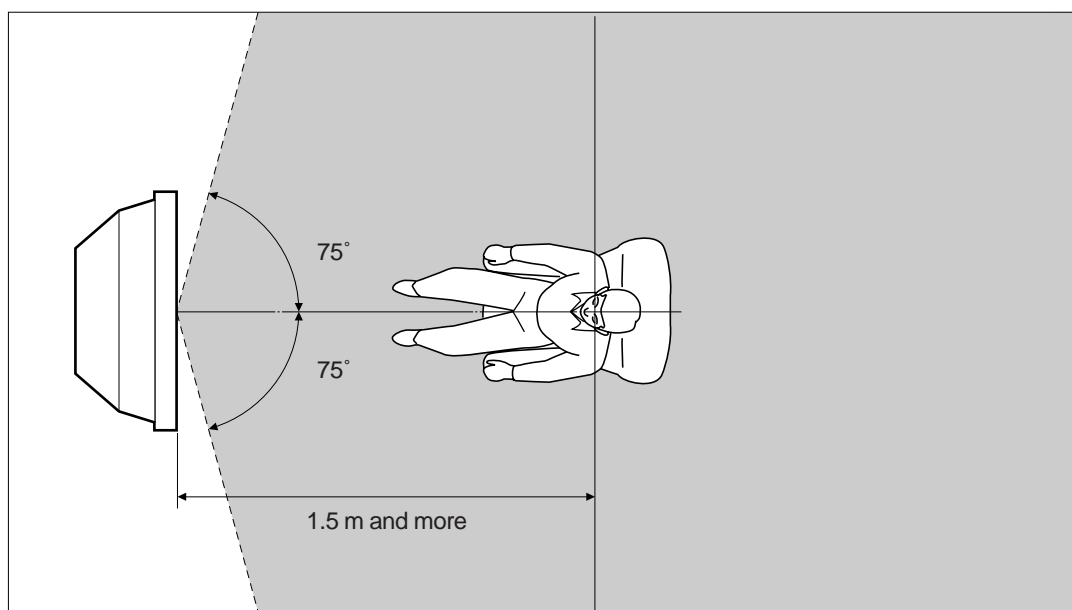

## Cleaning of the Air Filter

Periodic cleaning of the air filter is necessary. Clean the air filter once a month. When the filter becomes old and dust remains on the filter even after cleaning, replace it with a new one.

If you do not take the following precautions, you may get hurt or household belongings may be damaged.

- Clean the air filter periodically. If you don't clean, it may cause internal heat build-up.
- Never use an air filter which is torn or has holes. Attach the filter firmly with six tabs. If dust enters the TV, the picture may become dark or it may cause fire.

**1** Turn off the power and disconnect the power cord.

**2** Remove the front panel.

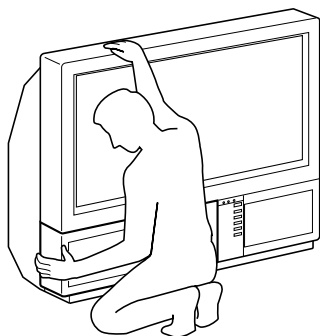

Remove the front panel without moving the TV.

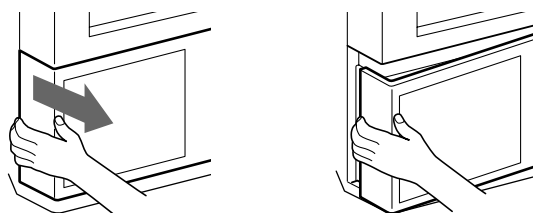

Grasping the side of the front panel with your fingers, pull it forward. Be careful not to catch your fingernails.

**3** Pull the filter upward and remove it.

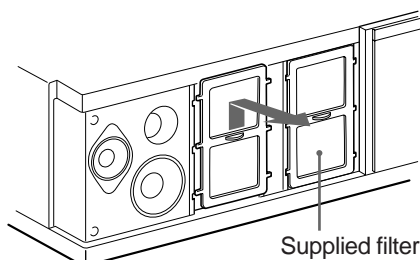

**4** Clean the dust with a vacuum cleaner.

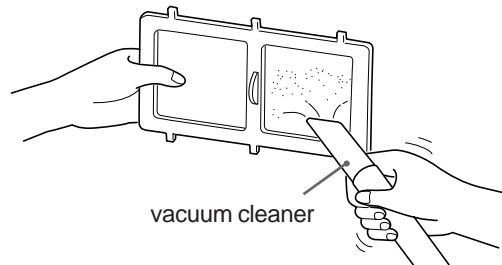

**5** Attach the filter.  
Attach the six tabs securely.

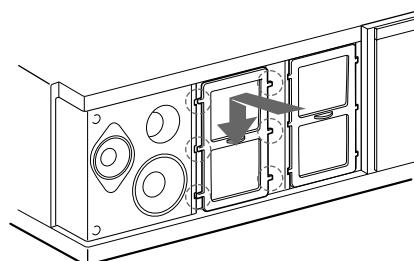

**6** Attach the front panel.  
Be careful not to damage the speaker.

### Notes

- Attach the filter firmly. If it is not firmly attached, the power will not turn on.
- Remove the supplied filter in the same way as the attached filter.
- Consult your nearest Sony service center to obtain a new filter.

## Replacing the Lamp

The lamp life is about 6000 hours. When the lamp become dark or the picture colour is not normal, replace with a new lamp (supplied).

If you do not take the following precautions, you may get hurt or household belongings may be damaged.

- Use the supplied new lamp for replacement. If you use another lamp, it may cause damage to the TV.
- Do not remove the lamp except when replacing it. This may cause heat damage or fire.
- Before replacing the lamp, turn off the power and disconnect the power cord.
- Replace the lamp after it becomes cool. The front glass of the lamp remains 100 °C (212 °F) and more even 30 minutes after the power is turned off.
- Do not place the removed lamp in proximity to children or flammable material.
- Do not get the removed lamp wet, or insert objects inside the lamp. It may cause the lamp to explode.
- Do not place near metal or easily flammable objects, as this may cause fire. Also, do not put your hand inside the lamp compartment, as you may be burned.
- Attach the new lamp firmly. If it is not firmly attached, the picture may become dark or fire may result.

### 1 Turn off the power and disconnect the power cord.

Replace the lamp 30 minutes or more after the power is turned off.  
Prepare the new lamp.

### 2 Remove the front panel.

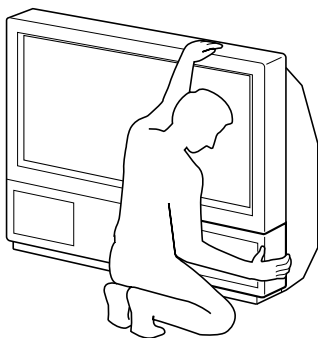

Remove the front panel without moving the TV.

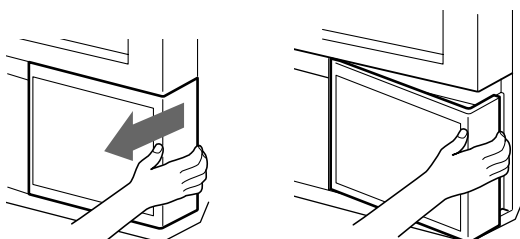

Grasping the side of the front panel with your fingers, pull it forward. Be careful not to catch your fingernails.

### 3 Loosen the screw with the object such as a coin and remove the lamp cover.

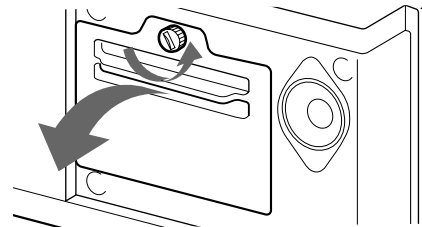

### 4 Loosen two screws and pull out the lamp.

The lamp is still too hot just after the power is turned off. Be careful that you don't touch the front glass or surrounding area of the lamp or the glass of the lamp compartment.

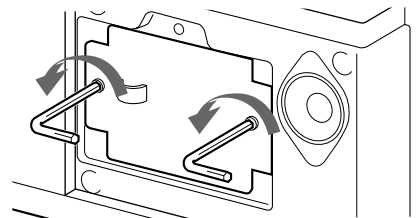

Loosen two screws with the supplied wrench.

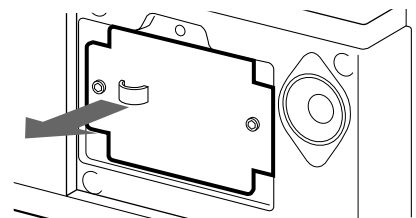

Pull out the lamp by the handle.

### 5 Attach the new lamp.

Fasten two screws tightly.

### 6 Attach the lamp cover.

Fasten the screws tightly.

### 7 Attach the front panel.

Be careful not to damage the speaker.

#### Notes

- Do not touch or stain the front glass of the new lamp or the glass of the lamp compartment. If the glass become dirty, the picture quality may deteriorate or the lamp life may shorten.
- Attach the lamp cover firmly. If it is not firmly attached, the power will not turn on.
- When the lamp burns out, a noise is audible. This does not represent a damage.
- Consult your nearest Sony service center to obtain a new lamp.

# Troubleshooting

Here are some simple solutions to some problems which may affect the picture and sound.

Problem	Solution
No picture (screen is dark), no sound	<ul style="list-style-type: none"> <li>• Plug in the TV in.</li> <li>• Press <math>\phi</math> on the TV (if <math>\phi</math> indicator is on, press O or a programme number on the Remote Commander).</li> <li>• Check the aerial connection.</li> <li>• Check if the selected video source is on.</li> </ul>
Poor or no picture (screen is dark), but sound is OK	<ul style="list-style-type: none"> <li>• Press <math>\bullet</math> to enter the PICTURE CONTROL menu and adjust the brightness, contrast and colour.</li> </ul>
Poor picture quality when watching an RGB video source	<ul style="list-style-type: none"> <li>• Press Z repeatedly to select <math>\rightarrow</math>.</li> </ul>
Poor picture quality of PAP screen	<ul style="list-style-type: none"> <li>• Press <math>\rightarrow</math>.</li> </ul>
Good picture but no sound	<ul style="list-style-type: none"> <li>• Press <math>\Delta</math> +.</li> <li>• Check loudspeakers connection.</li> <li>• If o is displayed on the screen, press o.</li> </ul>
No colour for colour programmes	<ul style="list-style-type: none"> <li>• Press <math>\bullet</math> to enter the PICTURE CONTROL menu, select RESET, then press OK.</li> </ul>
Remote Commander does not function	<ul style="list-style-type: none"> <li>• The batteries are weak.</li> </ul>

If you continue to have problems, have your TV serviced by qualified personnel. Never open the casing yourself.

## Specifications

This product complies with the EU Directive 89/336/EEC.

Television system	I, B/G/H, D/K, L	Sound output	2 x 5 W (music power) Centre 1 x 20 W
Colour system	PAL/SECAM	Power consumption	182 W
Channel coverage	NTSC 3.58/4.43 (VIDEO IN)	Dimensions (W x H x D)	920 x 825 x 390 mm (36 <sup>1</sup> / <sub>4</sub> x 32 <sup>1</sup> / <sub>2</sub> x 15 <sup>3</sup> / <sub>8</sub> inches)
Projected picture size	See "Receivable channels and channel displays" at the bottom.		(KL-37W1U) 1,230 x 1,055 x 550 mm (48 <sup>1</sup> / <sub>2</sub> x 41 <sup>5</sup> / <sub>8</sub> x 21 <sup>3</sup> / <sub>4</sub> inches) (KL-50W1U)
Terminals		Mass	29 kg (63 lbs 15 oz) (KL-37W1U) 43 kg (94 lbs 13 oz) (KL-50W1U)
Rear	<ul style="list-style-type: none"> <li>- <math>\rightarrow</math> 1 21-pin Euro connector (CENELEC standard) inputs for audio and video signals</li> <li>- inputs for RGB</li> <li>- outputs of TV video and audio signals</li> <li>- <math>\rightarrow</math> 2/ <math>\rightarrow</math> 2 21-pin Euro connector</li> <li>- inputs for audio and video signals</li> <li>- inputs for S video</li> <li>- outputs for audio and video signals (selectable)</li> <li>- <math>\rightarrow</math> 4/ <math>\rightarrow</math> 4 21-pin Euro connector</li> <li>- inputs for audio and video signals</li> <li>- inputs for S video</li> <li>- outputs for audio and video signals (monitor out)</li> <li>- <math>\rightarrow</math> 2, <math>\rightarrow</math> 4 S video inputs</li> <li>- 4 pin DIN</li> <li>- <math>\rightarrow</math> Audio inputs (L, R) - phono jacks</li> <li>- <math>\rightarrow</math> S video output 4-pin DIN</li> <li>- <math>\rightarrow</math> Audio outputs - phono jacks</li> <li>- <math>\rightarrow</math> Audio outputs (variable)-phono jacks</li> </ul>	Supplied accessories	See page 6.
Front	<ul style="list-style-type: none"> <li>- <math>\rightarrow</math> 3 video input - phono jack</li> <li>- <math>\rightarrow</math> Audio inputs - phono jacks</li> <li>- <math>\rightarrow</math> 3 S video input - 4-pin DIN</li> <li>2 Headphone jack: stereo minijack</li> </ul>	Other features	Digital comb filter (High resolution) PAP (Picture-and-picture) FASTEXT 100 Hz Digital Plus Graphic Equalizer

Design and specifications are subject to change without notice.

### Receivable Channels and Channel Displays

	Receivable channels	Indication on the screen
I	B21..B68	C21..C68
B/G/H	E2..12 21..69	C02 C03 C04..C12 C21..C69
CABLE TV (1)	S1..41	S01 S02..S41
CABLE TV (2)	S01..S05 M1..M10 U1..U10	S42..S46 S01..S10 S11..S20
ITALY	A B C D E F G H H1 H2 21..69	C11..C69
D/K	R01..R12 R21..R69	C02..C12 C21..C69
CABLE TV (1)		S01 S02..S41
CABLE TV (2)		S42 S43..S46
CABLE TV	B..Q, S21..41	S02, S03..S17, S21..S41
L	F2..F10 F21..F69	C01..C12 C21..C69

# Warning Indicators

When a problem occurs, the indicator flashes as follows.  
Attempt the solution recommended for the given problem.

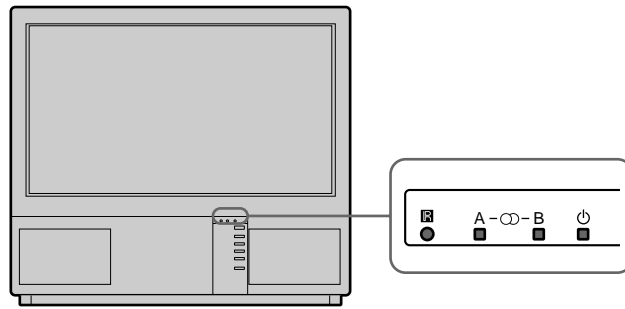

GB

Cause	Indicator flashing patterns
The lamp burns out or the quality of the lamp is deficient.	The B indicator flashes twice then A flashes once. Flashing continues in this manner.
The cover of the filter or the lamp is removed.	The B indicator flashes three times then A flashes once. Flashing continues in this manner.
The fan for cooling stops.	The B indicator flashes four times then A flashes once. Flashing continues in this manner.
Internal heat builds up.	The B indicator flashes five times then A flashes once. Flashing continues in this manner.

If the lamp flashes in a way not described above, consult your nearest Sony service center.

## Stabilizing the Projection TV

After setting up, secure the projection TV to a wall, etc., with the supplied brackets, for safety purposes.

- 1 Mount the two supplied brackets with the screws to the upper rear side of the projection TV.

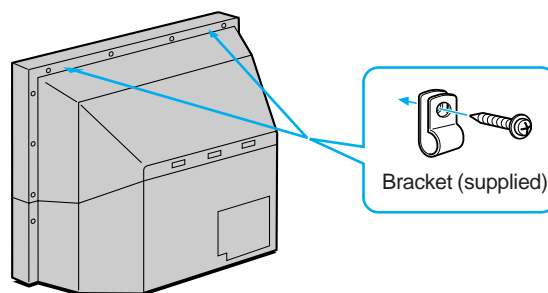

- 2 Pass a strong cord or a chain through each bracket mounted in 1, and then secure to a wall or a pillar, etc.

# Television Channel Number Guide

Only the main transmitters are listed. Information regarding the regional sub-relay channel numbers can be obtained by contacting The BBC Engineering Information Dept. (0181) 752 5040.

MAIN TRANSMITTERS	BBC1	BBC2	ITV	CH4
<b>London &amp; South East</b>				
1 Bluebell Hill	40	46	43	65
2 Crystal Palace	26	33	23	30
3 Dover	50	56	66	53
4 Heathfield	49	52	64	67
5 Oxford	57	63	60	53
<b>South-West</b>				
6 Beacon Hill	57	63	60	53
7 Caradon Hill	22	28	25	32
8 Huntshaw Cross	55	62	59	65
9 Redruth	51	44	41	47
! ° Stockland Hill	33	26	23	29
<b>Channel Islands</b>				
! j Fremont Point	51	44	41	47
<b>South</b>				
! M Hannington	39	45	42	66
! £ Midhurst	61	55	58	68
! ¢ Rowridge	31	24	27	21
<b>West</b>				
! Mendip	58	64	61	54
<b>East</b>				
! § Sandy Heath	31	27	24	21
! ¶ Sudbury	51	44	41	47
! • Tacolneston	62	55	59	65
<b>Midlands (West)</b>				
! a Ridge Hill	22	28	25	32
@ Sutton Coldfield	46	40	43	50
@ The Wrekin	26	33	23	29
<b>Midlands (East)</b>				
@ Waltham	58	64	61	54
<b>Northern Ireland</b>				
@ Brougher Mountain	22	28	25	32
@ Divis	31	27	24	21
@ Limavady	55	62	59	65
<b>North</b>				
@ Belmont	22	28	25	32
@ Emley Moor	44	51	47	41
<b>North-West</b>				
@ Winter Hill	55	62	59	65
<b>North-East</b>				
@ Bilsdale West Moor	33	26	29	23
# ° Caldbeck	30	34	28	32
# j Chatton	39	45	49	42
# M Pontop Pike	56	64	61	54
<b>Scotland</b>				
# £ Angus	57	63	60	53
# ¢ Black Hill	40	46	43	50
# Sandale	22	67	—	—
# § Caldbeck	—	—	28	32
# ¶ Craigkelly	31	27	24	21
# • Darvel	33	26	23	29
# a Durris	22	28	25	32
\$ ° Eitshal (Lewis)	33	26	23	29
\$ j Keelylang Hill	40	46	43	50
\$ M Knock More	33	26	23	29
\$ £ Rosemalkie	39	45	49	42
\$ ¢ Rumster Forest	31	27	24	21
\$ Selkirk	55	62	59	65
<b>Wales</b>				
\$ § Blaenplwyf	31	27	24	21
\$ ¶ Carmel	57	63	60	53
\$ • Llanddona	57	63	60	53
\$ a Moel-y-Parc	52	45	49	42
% ¢ Presely	46	40	43	50
% j Wenvoe	44	51	41	47

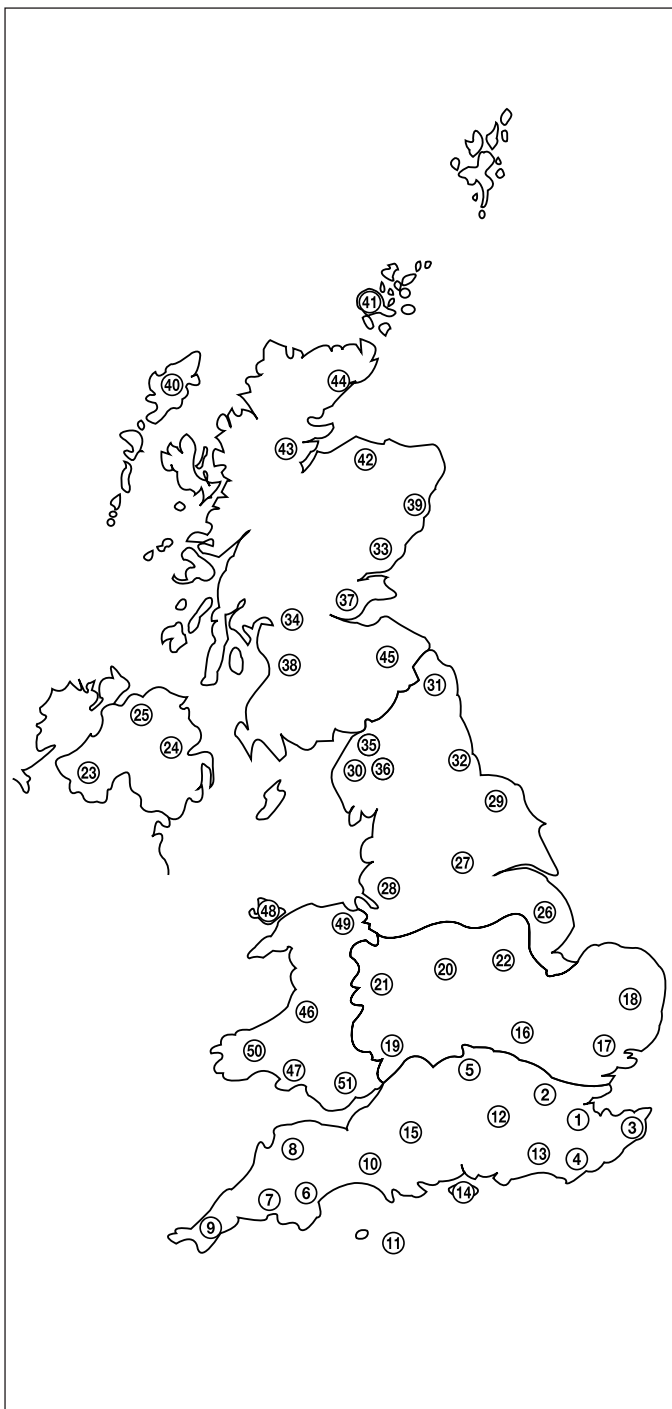

GB