

SAMSUNG

User Guide





Chapter 1. Getting Started

- 3 Before You Start
- 6 Safety Precautions
- 21 Proper Posture During Computer Use
- 24 Overview
- 30 Turning the Computer On and Off



Chapter 2. Using Windows 8

- 33 What is Microsoft Windows 8?
- 34 Screen At a Glance
- 36 Using the Charms
- 38 Using Apps
- 42 Windows Hot Key Function



Chapter 3. Using the computer

- 44 Using the Touch Screen
- 52 Micro SD Card Slot (Optional)
- 54 Connecting an External Display Device
- 57 Adjusting the Volume
- 59 LCD Brightness Control
- 60 Wireless Network (Optional)
- 62 Mobile broadband (Wireless WAN, Optional)
- 63 NFC (Near Field Communication) (Optional)

- 65 Using the Keyboard Dock (Optional)
- 71 Using the S Note app (S Note, Optional)
- 75 Samsung Software Update
- 76 Diagnosing the Computer Status and Troubleshooting
- 77 Battery
- 80 BIOS Setup



Chapter 4. Troubleshooting

- 83 Recovering the Computer (Optional)
- 86 Q&A



Chapter 5. Appendix

- 91 Important Safety Information
- 93 Replacement Parts and Accessories
- 95 Regulatory Compliance Statements
- 110 WEEE Symbol Information
- 111 Samsung Packaging Take-Back Program
- 112 TCO Certified (for corresponding models only)
- 113 Product Specifications
- 115 Glossary
- 119 Index



Chapter 1. Getting Started

Before You Start	3
Safety Precautions	6
Proper Posture During Computer Use	21
Overview	24
Turning the Computer On and Off	30

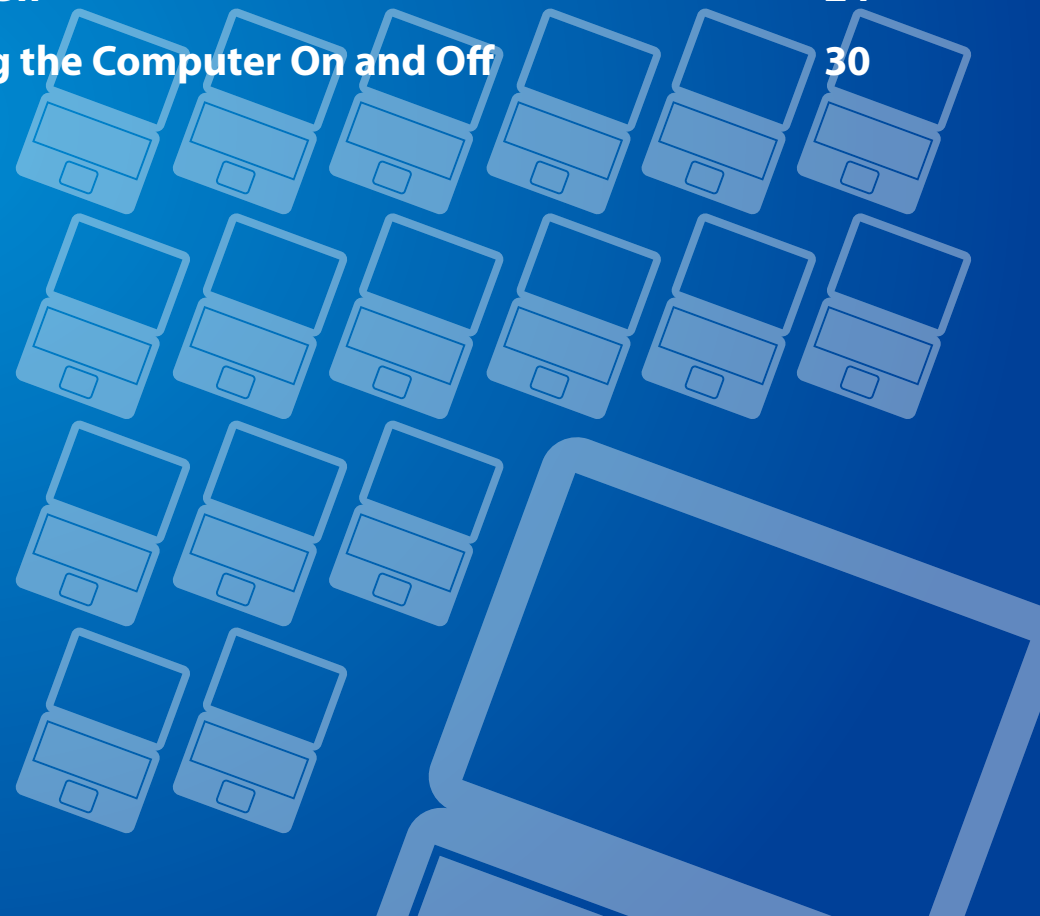

Before reading the User Guide, first check the following information.



- Optional items, some devices and software referred to in the User Guide may not be provided and/or changed by upgrade.
Note that the computer environment referred in the User Guide may not be the same as your own environment.
- The pictures used for the cover and the main body in the User Manual are those of the representative model of each series and may differ from the actual appearance of the product.
- This guide describes procedures for using both the mouse and the S Pen.
In this manual 'click' means 'one press with the S Pen'.
- The User Guide describes information on the basis of the touch screen.
- This manual has been written for the Windows 8 operating system. The descriptions and figures may differ depending on the installed operating system.
- The User guide supplied with this computer may vary depending on your model.





Software Usage Instructions



- In the **Start screen**, slightly drag the top edge of the screen toward the center.

Click the corresponding program in the **All Apps**  menu item.
Alternatively, start the program from **Quick Starter**.
- You can install **Quick Starter** through the **SW Update**.

Safety Precaution Notations

Icon	Notation	Description
	Warning	Failure to follow instructions marked with this symbol, may cause personal injury and or fatality.
	Caution	Failure to follow instructions marked with this symbol, may cause slight injury to yourself or damage your property.

Text Notations

Icon	Notation	Description
	Caution	Content included in this section includes information required about the function.
	Note	Content included in this section includes helpful information to use the function.

Copyright

© 2013 Samsung Electronics Co., Ltd.

Samsung Electronics Co., Ltd. owns the copyright of this manual.

No part of this manual may be reproduced or transmitted in any form or by any means, electronic or mechanical, without the consent of Samsung Electronics Co., Ltd.

The information in this document is subject to change without notice due to improving the performance of the product.

Samsung Electronics shall not be liable for any data loss. Please take care to avoid losing any important data and backup your data to prevent any such data loss.

OS and Software Support

If you change the product's factory OS (Operating System) to another OS or if you install software which is not supported by the product's original factory OS, you will not receive any technical support, product exchange or refund. And a fee will be charged when requesting a service.

Please use your computer with the original factory OS. If you install an OS other than the factory OS, data may be deleted or the computer may not start.

Performance Information and Restriction

- Online games and some games(3D,2D) may not be supported and Full HD video and some high bit rate HD video playback may be slow and stutter on this computer.
- If the main board goes out of order, the data saved on the storage device cannot be used due to the characteristics of this product.

Make sure that you always back up all your important data.

About the Product Capacity Representation Standard

About the capacity representation of the storage

The capacity of the storage device (HDD, SSD) of the manufacturer is calculated assuming that 1KB=1,000 Bytes.

The operating system (Windows) calculates the capacity of the storage device assuming that 1KB=1,024 Bytes, and therefore the representation of the storage device capacity in Windows is smaller than the actual capacity due to the difference in the capacity calculation.

(E.g. For an 80GB storage device, the capacity is represented as 74.5GB by the operating system. $80 \times 1,000 \times 1,000 \times 1,000 \text{ byte} / (1,024 \times 1,024 \times 1,024) \text{ byte} = 74.505 \text{ GB}$)

Windows may also display a smaller hard disk capacity due to some hidden functions or software programs such as the Recovery program.

About Memory Capacity Representation

The memory capacity reported in Windows is less than the actual capacity of memory.

This is because BIOS or a video adapter uses a portion of memory or claims it for further use.

(E.g. For 1GB(=1,024MB) memory installed, Windows may report the capacity as 1,022MB or less)

Safety Precautions

For your security and to prevent damage, please read the following safety instructions carefully.

 Since this is commonly applied to Samsung computers, some pictures may differ from actual products.

Warning

Failure to follow instructions marked with this symbol may cause personal injury and even fatality.

Installation Related



Do not install the product in places exposed to humidity such as bathrooms.

There is a danger of electric shock. Use the product within the operating conditions specified in the Manufacturers User Guide.



Keep the plastic bags out of the reach of children.

There is a danger of suffocation.

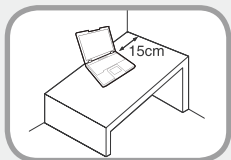

Keep a distance of 15cm or more between the computer and the wall and do not place any objects between them.

This may increase the internal temperature of the computer and may cause an injury.

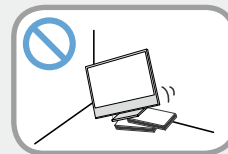

Do not install the computer on a slant or a place prone to vibrations, or avoid using the computer in that location for a long time.

This increases the risk that a malfunction or damage to the product will occur.

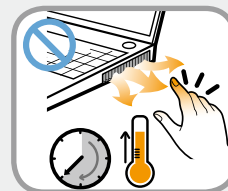

Be careful that people are not exposed to the computer's ventilator, adapter, etc., as they generate heat over a long period of time when your PC is powered on.

Exposing a part of your body close to the heat from the vent or AC adapter for long periods of time may cause a burn.

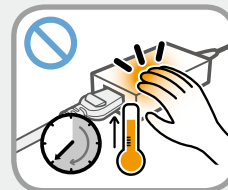

Avoid blocking the vent at the bottom or side of the computer when using it on a bed or cushion.

If the vent is blocked, there is a danger of damaging the computer or overheating the inside of the computer.



Warning

Failure to follow instructions marked with this symbol may cause personal injury and even fatality.

Power Related

The power plug and wall outlet figures may differ depending on the country specifications and the product model.

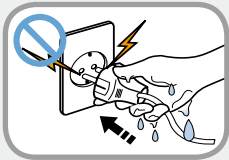

Do not touch the main plug or power cord with wet hands.

There is a danger of electric shock.

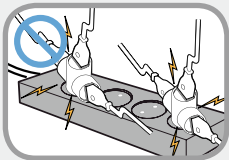

Do not exceed the standard capacity (voltage/current) of a multiplug or power outlet extension when using it for the product.

There is a danger of electric shock or fire hazard.

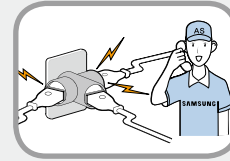

If the power cord or power outlet makes a noise, disconnect the power cord from the wall outlet and contact a service center.

There is a danger of electric shock or fire hazard.

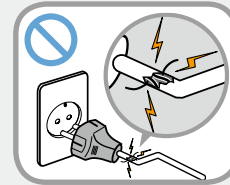

Do not use a damaged or loose main plug or power cord or power outlet.

There is a danger of electric shock or fire hazard.

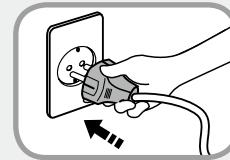

Plug the power cord firmly into the power outlet and AC adapter.

Failure to do so may cause fire hazard.

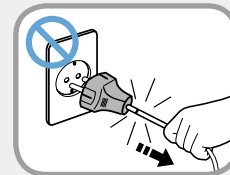

Do not unplug the power cord by pulling the cable only.

If the cord is damaged, it may cause electric shock.

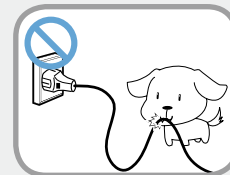

Do not bend the power cord excessively or do not place a heavy object over the power cord. It is especially important to keep the power cord out of reach of infants and pets.

If the cord is damaged, it may cause electric shock or fire.

Safety Precautions



Warning

Failure to follow instructions marked with this symbol may cause personal injury and even fatality.

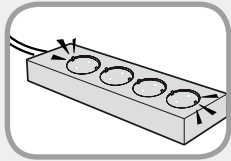

Connect the power cord to an outlet or multiple power plug (extended cable) with a ground terminal.

Failure to do so may result in electric shock. When the power supply is ungrounded, the current may leak resulting in electric shock.

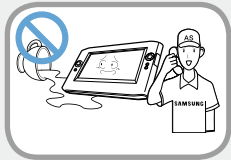

If water or another substance enters the power input jack, AC adapter or the computer, disconnect the power cord and contact the service center.

If the notebook computer has an external type (removable) battery, separate the battery also.

Damage to the device within the computer may cause electric shock or fire hazard.

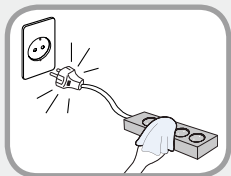

Keep the power cord or outlet clean so that they are not covered with dust.

Failure to do so may result in fire.

AC Adapter Usage Precautions

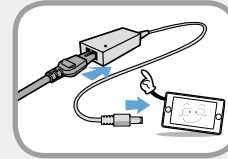

Connect the power cord to the AC adapter firmly.

Otherwise, there is a danger of fire due to an incomplete contact.

Use only the AC adapter supplied with the product.

Using another adapter may cause the screen to flicker.

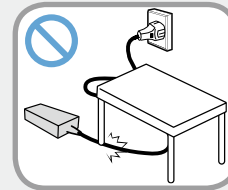

Do not place heavy objects on top of or step onto the power cord or AC adapter to avoid damaging the power cord or AC adapter.

If the cord is damaged, there is a danger of electric shock or fire.

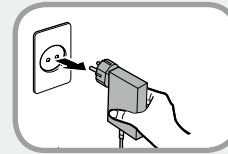

Unplug the wall-mount AC adapter (adapter and plug intergrated type) from the wall outlet while holding the body and pulling it in the direction of the arrow.

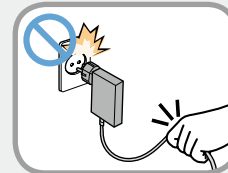

If you unplug the adapter by holding and pulling the cable, the adapter may be damaged and an electric shock, explosive sound or spark may occur as a result.



Warning

Failure to follow instructions marked with this symbol may cause personal injury and even fatality.

Battery Usage Related



Please charge the battery fully before using the computer for the first time.



Keep the battery out of the reach of infants and pets, as they could put the battery into their mouths.

There is a danger of electric shock or choking.

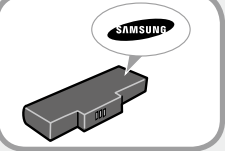

Use an authorized battery and AC adapter only.

Please use an authorized battery and adapter approved by Samsung Electronics.

Unauthorized batteries and adapters may not meet the proper safety requirements and may cause problems or malfunctions and result in an explosion or fire.



Do not use the computer in a badly ventilated location such as on bedding, on a pillow or cushion, etc, and do not use it in a location such as a room with floor heating as it may cause the computer to overheat.

Take care that the computer vents (on the side or the bottom) are not blocked especially in these environments. If the vents are blocked, the computer may overheat and it may cause a computer problem, or even an explosion.



Do not use the computer in a humid location such as a bathroom or sauna.

Please use the computer within the recommended temperature and humidity ranges (10 - 32°C (50 - 90°F), 20 - 80% RH)

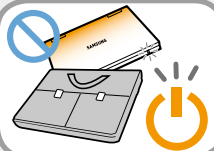
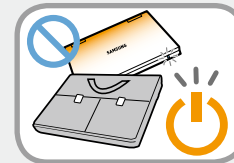

Do not close the LCD panel and put the computer into your bag to move it when it is still turned on.

If you put the computer into your bag without turning it off, the computer may overheat and there is a danger of fire. Shut the computer down properly before moving it.



Warning

Failure to follow instructions marked with this symbol may cause personal injury and even fatality.

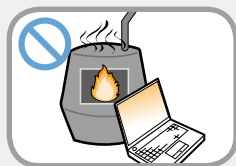

Never heat the product (or battery) or put the product (or battery) into a fire. Do not put or use the product (or battery) in a hot location such as a sauna, inside a vehicle exposed to the heat, and so on.

There is a danger of an explosion or fire.

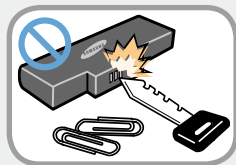

Take care not to allow metal objects such as a key or clip to touch the battery terminal (metal parts).

If a metal object touches the battery terminals, it may cause excessive current flow and it may damage the battery, or result in a fire.



If liquid leaks out of the product (or battery) or there is a funny smell coming from the product (or battery), remove the the product (or battery) the computer and contact a service center.

There is a danger of an explosion or fire.

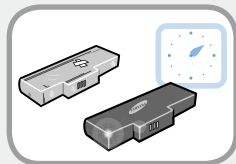

To use the computer safely, replace a dead battery with a new, authorized battery.

Cutting the Power to the Internal Battery (for corresponding models only)

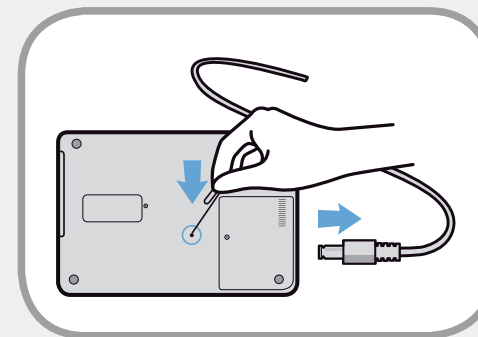

- For products with built-in batteries, customers cannot remove the battery.
- In the case of flooding, lightning or explosions, you can cut the battery power by inserting an object such as a paper clip into the [Emergency Hole] at the bottom of the computer.
- Disconnect the AC adapter and insert an object such as a paper clip into the hole at the bottom of the computer to cut the battery power.



In the case of flooding, lightning or explosions, cut the battery power, do not reconnect the AC adapter, and immediately contact Samsung Electronics so that the appropriate countermeasures can be taken.

Warning

Failure to follow instructions marked with this symbol may cause personal injury and even fatality.

- Thereafter, if you connect the AC adapter, the battery power will be supplied again.

- **Do not cut the battery power under normal conditions.**
- **This may result in data loss or a product malfunction.**

 The location of the Emergency Hole may differ depending on the model.

Usage Related

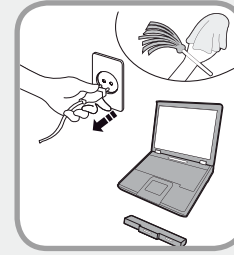

Disconnect all cables connected to the computer before cleaning it. If your notebook is an external & removable battery type, remove the external battery.

There is a danger of electric shock or damage to the product.

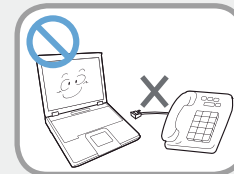

Do not connect a phone line connected to a digital phone to the modem.

There is a danger of a electric shock, fire or damage to the product.



Do not place any container filled with water or chemicals over or near the computer.

If water or chemicals enter the computer, this may cause fire or electric shock.



If the computer is broken or dropped, disconnect the power cord and contact a service center for a safety check.

If the notebook computer has an external type (removable) battery, separate the battery also.

Using a broken computer may cause electric shock or fire hazard.



Warning

Failure to follow instructions marked with this symbol may cause personal injury and even fatality.

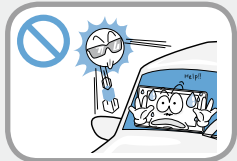

Avoid direct sunlight when the computer is in an air-tight location such as inside a vehicle.

There is a danger of a fire hazard. The computer may overheat and also present opportunity to thieves.

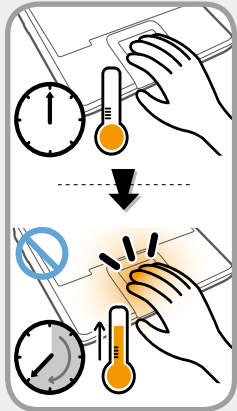

Do not use your computer for long periods of time while any part of your body is making direct contact with it. The temperature of the product may increase during normal operation.

This may result in harming or burning your skin.

Upgrade Related



Be sure to upgrade the computer by yourself only if you have sufficient knowledge and ability.

If this is not the case, ask for assistance from the service center or an authorized engineer for the upgrade.



Be sure to upgrade only the parts specified in the user manual according to the procedures described in the user manual.

Do not disassemble any other parts or devices by yourself. There is a danger of a electric shock, fire or damage to the product.

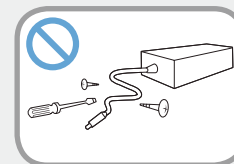

Never disassemble the power supply or AC adapter.

There is a danger of electric shock.



When removing the RTC (Real Time Clock) battery, keep it out of the reach of children as they could touch and/or swallow it.

There is a danger of choking. If a child has swallowed it, contact a doctor immediately.



Warning

Failure to follow instructions marked with this symbol may cause personal injury and even fatality.

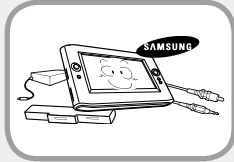

Before upgrading the computer, be sure to shutdown the computer first and then separate all connected cables. If the notebook computer has an external type (removable) battery, separate the battery, too.

Failure to do so may cause electric shock.

Security and Movement Related



Follow the instructions for the relevant location (e.g., airplane, hospital, etc.) when using a wireless communication device (wireless LAN, Bluetooth, etc.).



Avoid exposing a drive to magnetic fields. Security devices with magnetic fields include airport walk-through devices and security wands.

The airport security devices that check carry-on luggage, such as conveyor belts, use x-rays instead of magnetism and will not damage a drive.



When carrying the notebook computer with other items, such as the adapter, mouse, books, etc, take care not to press anything against the notebook computer.

If a heavy object is pressed against the notebook computer, a white spot or stain may appear on the LCD. Therefore, take care not to apply any pressure to the notebook.

In this case, place the notebook computer in a separate compartment away from other objects.



Caution

Failure to follow instructions marked with this symbol may cause slight injury or damage to the product.

Installation Related

Do not block the ports (holes), vents, etc. of the product and do not insert objects.

Damage to a component within the computer may cause electric shock or fire.

When using the computer with it lying on its side, place it so that the vents face upwards.

Failure to do so may cause the internal temperature of the computer to rise and the computer to malfunction or halt.

Do not place a heavy object over the product.

This may cause a problem with the computer. In addition, the object may fall and cause injury, or damage the computer.

Battery Usage Related

Dispose of worn-out batteries properly.

- There is a danger of fire or explosion.
- The battery disposal method may differ depending on your country and region. Dispose of the used battery in an appropriate way.

Do not throw or disassemble the battery and do not put it into water.

This may cause an injury, fire or explosion.

Use only a battery authorized by Samsung Electronics.

Failure to do so may cause an explosion.

Avoid contact with metal objects such as car keys or clips when keeping or carrying a battery.

Contact with a metal may cause excessive current and a high temperature and may damage the battery or cause a fire.

Charge the battery according to the instructions in the manual.

Failure to do so may cause an explosion or fire from damage to the product.

Do not heat the product (or battery) or expose it to heat (e.g., inside a vehicle during the summer).

There is a danger of explosion or fire.



Caution

Failure to follow instructions marked with this symbol may cause slight injury or damage to the product.

Usage Related

Do not place a candle, light a cigar, etc. over or on the product.

There is a danger of fire.

Use a wall outlet or multi-plug with a grounding part.

Failure to do so may cause electric shock hazard.

Make sure to have the product tested by a safety service engineer after repairing the product.

Authorized Samsung Repair Centers will carry out safety checks after a repair. Using a repaired product without testing it for safety may cause an electric shock or fire.

In case of lightning, immediately turn the system off, disconnect the power cord from the wall outlet and phone line from the modem. Do not use a modem or phone.

There is a danger of electric shock or fire.

Do not use your computer and AC-Adapter on your lap or soft surfaces.

If the computer temperature increases, there is a danger of burning yourself.

Connect only permitted devices to the connectors or ports of the computer.

Failure to do so may cause electric shock and fire.

Close the LCD panel only after checking if the notebook computer is turned off.

The temperature may rise and cause overheating and deformation of the product.

Do not press the Eject Button while the CD-ROM drive is in operation.

You might lose data and the disk might be suddenly ejected and could cause an injury.

Do not drop or knock the product.

This may result in injury or damage to the data.

Do not touch the antenna with an electricity facility such as the power outlet.

There is a danger of electric shock.

When handling computer parts, follow the instructions on the manual supplied with the parts.

Failure to do so may cause damage to the product.

Safety Precautions



Caution

Failure to follow instructions marked with this symbol may cause slight injury or damage to the product.

If the computer emits smoke, or there is a burning smell, disconnect the power plug from the wall outlet and contact a service center immediately. If your notebook is an external & removable battery type, remove the external battery.

There is a danger of fire.

Do not use a damaged or modified CD.

There is a danger of damaging the product or personal injury.

Do not insert your fingers into the PC Card Slot.

There is a danger of injury or electric shock.

Use recommended computer cleansing solution when cleaning the product and only use the computer when it is completely dried.

Failure to do so may cause electric shock or fire.

Emergency disk eject method using paperclip should not be used while the disk is in motion. Make sure to use the emergency disk eject method only when the Optical Disk Drive has stopped.

There is a danger of injury.

Do not place your face close to the Optical Disk Drive tray when it is operating.

There is a danger of injury due to an abrupt ejection.

Check CDs for cracks and damage prior to use.

It may damage the disc and cause problems with the device and injury to the user.

Do not leave the product in a location exposed to magnetic fields.

- A magnetic field may cause the product to work abnormally or the battery to discharge.
- The information saved on the magnetic tape of a credit card, phone card, bankbook, transportation tickets and so on can be damaged by a computer's electromagnetic field.

Use the pen only for the original purpose. Do not poke in the eye or ear with the pen, and do not put the pen in the mouth.

There is a danger of injury.



Caution

Failure to follow instructions marked with this symbol may cause slight injury or damage to the product.

Upgrade Related

Carefully touch a part or device of the product.

Failing to do so may result in damage to the product or injury.

Take care not to throw or drop a computer part or device.

Failing to do so may result in damage to the product or injury.

After the disassembly, be sure to close the cover and then connect the power.

Failing to do so may result in an electric shock from the exposed circuit.

Use parts authorized by Samsung Electronics only.

It may damage the product or result in fire.

Never disassemble or repair the product by yourself.

If the product is modified, disassembled or repaired by the user, the warranty is expired, a service fee will be charged and there is a danger of an accident.

Be sure to use an authorized Samsung Electronics service center.

To connect a device that is not manufactured or authorized by Samsung Electronics, inquire at your service center before connecting the device.

There is a danger of damaging the product.

Security and Movement Related

When moving the product, turn the power off and separate all connected cables first.

The product might be damaged or users may trip over the cables.

For long periods of not using the notebook computer, discharge the battery and separate the battery from the computer (for external & removable battery type).

The battery will be preserved at its best condition.

Do not operate or watch the computer while driving a vehicle.

There is a danger of a traffic accident. Please concentrate on driving.



Caution

Failure to follow instructions marked with this symbol may cause slight injury or damage to the product.

Cautions on Preventing Data Loss (Hard Disk Management)

Take care not to damage the data on a hard disk drive.

- A hard disk drive is so sensitive to external impact that an external impact may cause loss of data on the surface of the disk.
- Take extra care, because moving the computer or an impact on the computer when it is turned on may damage the data of the hard disk drive.
- The company is not liable for any loss of data on the hard disk drive.

Causes that may damage the data of a hard disk drive and the hard disk drive itself.

- The data may be lost when an external impact is applied to the disk while disassembling or assembling the computer.
- The data may be lost when the computer is turned off or reset by a power failure while the hard disk drive is operating.
- The data may be lost and irrecoverable due to a computer virus infection.
- The data may be lost if the power is turned off while running a program.
- Sudden impact or movement to the computer while the hard disk drive is operating may cause files to be corrupted or bad sectors on the hard disk.

To prevent data loss due to damage to the hard disk drive, please backup your data frequently.

Using the Power Supply in an Airplane

Since the power outlet type differs depending on the type of airplane, connect the power appropriately.



Since the representative figures of the power plug and the auto adapter are used, they may differ from the actual parts.

When Using the AC Power Plug

Connect the power plug pins perpendicular into the center of the power outlet.

- If the plug pins are not inserted into the center of the holes, the plug pins are only inserted up to half their length. In this case, reconnect the power plug.
- You have to insert the power plug into the outlet when the power indicator (LED) of the power outlet is lit green. If the power is connected properly, the power indicator (LED) remains green.

Otherwise, the power indicator (LED) is turned off. In this case, unplug the power, check if the power indicator (LED) is green, and then reconnect the power plug.

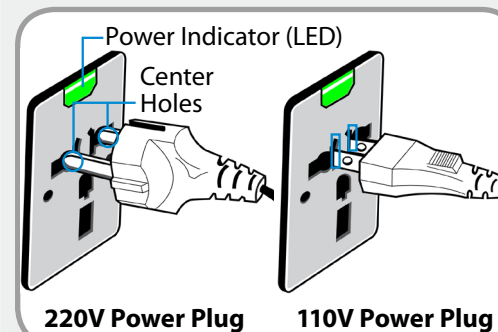

Good Example ○

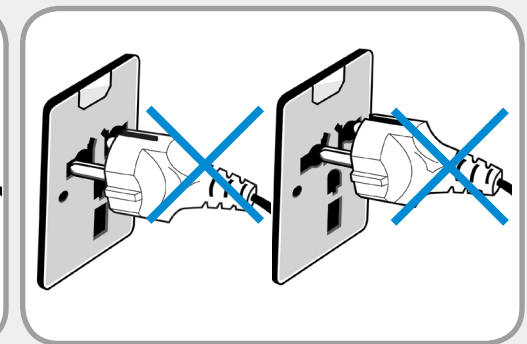

Wrong Example ✕

Safety Precautions

When Using the Auto Adapter

When a cigar socket is provided, you have to use the auto adapter (optional). Insert the cigar plug of the auto adapter into the cigar socket and connect the DC plug of the auto adapter to the power input port of the computer.

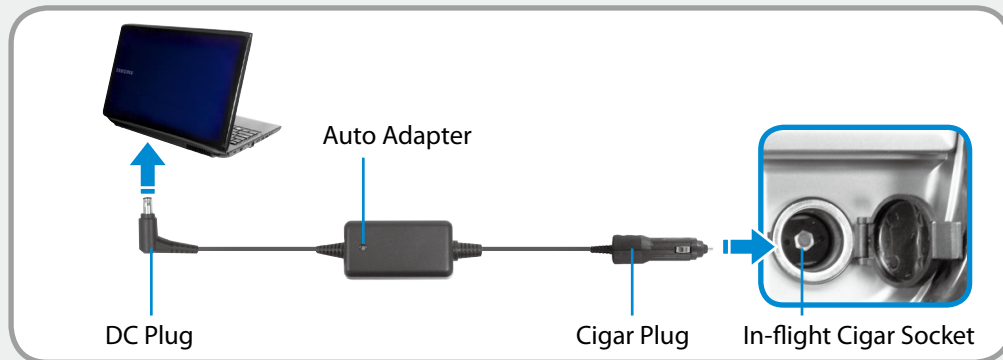

When Using the Airplane Charging Converter

Depending on the airplane, you have to use the auto adapter and charging converter. Connect the airplane charging converter (optional) to the auto adapter (optional) and then insert the airplane power input jack into the power outlet.

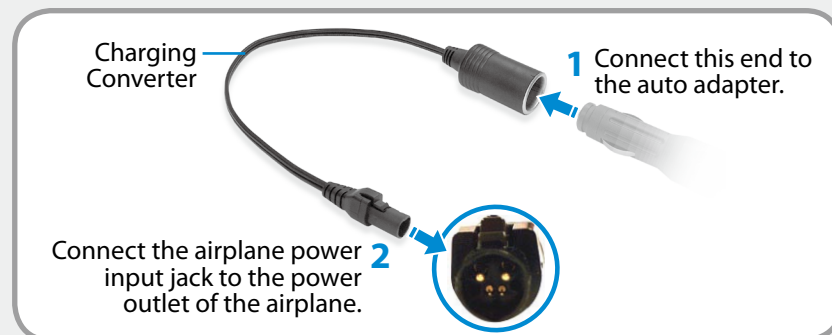

Proper Posture During Computer Use

Maintaining a proper posture during computer use is very important to prevent physical harm.

The following instructions are about maintaining a proper posture during computer use developed through human engineering. Please read and follow them carefully when using the computer.

Otherwise, the probability of (RSI: Repetitive Strain Injury) from repeated operations may increase and serious physical harm may be caused.



- The instructions in this manual have been prepared so that they can be applied within the coverage of general users.
- If the user is not included in the coverage, the recommendation is to be applied according to the user's needs.

Proper Posture

Adjust the heights of desks and chairs appropriate to your height.

The heights are to be adjusted so that your arm forms a right angle when you place your hand over the keyboard while sitting down on a chair.

Adjust the height of chair so that your heel is comfortably placed on the floor.

- Do not use the computer while you are lying down, but only while you are sitting down.
- Do not use the computer on your lap. If the computer temperature increases, there is a danger of burning yourself.
- Work while keeping your waist straight.
- Use a chair with a comfortable back.
- Keep the center of your leg weight not on the chair but on your feet when you are sitting on a chair.
- To use the computer while talking over the telephone, use a headset. Using the computer with the phone on your shoulder is bad for posture.
- Keep frequently used items within a comfortable work range (where you can reach them with your hands).



Eye Position

Keep the monitor or LCD away from your eyes by at least 50cm.



- Adjust the height of the monitor and the LCD screen so that its top height is equal to or lower than your eyes.
- Avoid setting the monitor and LCD excessively bright.
- Keep the monitor and LCD screen clean.
- If you wear glasses, clean them before using the computer.
- When entering contents printed on a paper into the computer, use a static paper holder so that the height of the paper is almost equal to that of the monitor.

Hand Position

Keep your arm at a right angle as shown by the figure.



- Keep the line from your elbow to your hand straight.
- Do not place your palm over the keyboard while typing.
- Do not hold the mouse with excessive force.
- Do not press the touch screen with excessive force.
- It is recommended connecting an external keyboard and mouse when using the computer for long periods of time.

Proper Posture During Computer Use

Volume Control (Headphones and Speakers)

Check your volume first to listen to music.



- Check if the volume is too loud before using headphones.
- It is not recommended using headphones for long periods of time.
- Any deviation from the equalizer default setting could cause hearing impairment.
- The default setting can be changed through software and driver updates without your intervention. Please check the equalizer default setting before first usage.

To prevent possible hearing damage, do not listen at high volume levels for long periods.



Use Time (Break Time)

- Take a break for 10 minutes or more after a 50-minute period when working for more than one hour.

Illumination

- Do not use the computer in dark locations. The illumination level for computer use must be as bright so for reading a book.
- Indirect illumination is recommended. Use a curtain to prevent reflection on the LCD screen.



Operation Condition

- Do not use the computer in hot and humid locations.
- Use the computer within the allowed temperature and humidity range specified in the User Guide.

Front View

 The pictures used for the cover and the main body in the User Manual are those of the representative model of each series. Therefore the colors and appearance of the pictures may differ from the actual appearance of the product depending on the model.



1 Illumination Sensor	Using the illumination sensor, the LCD screen brightness is automatically adjusted depending on the ambient illumination. If you cover the illumination sensor with your hand, the LCD screen will become dimmer. Therefore, please take care that you do not cover the sensor when you use the computer.
2 Camera operating indicator (Optional)	This indicates the camera operating status.
3 Camera (Optional)	Using this camera, you can take still pictures and record video. You can take a picture or make a movie using the Charms > Start > Camera .
4 Speaker	A device used to generate sound.
5 Touch Screen	This is a touch screen that shows the output from the computer.
6 Home button 	Switches the screen between the Start screen and the currently running app/program .  If no app/software is currently running, the Desktop is displayed.

Right View

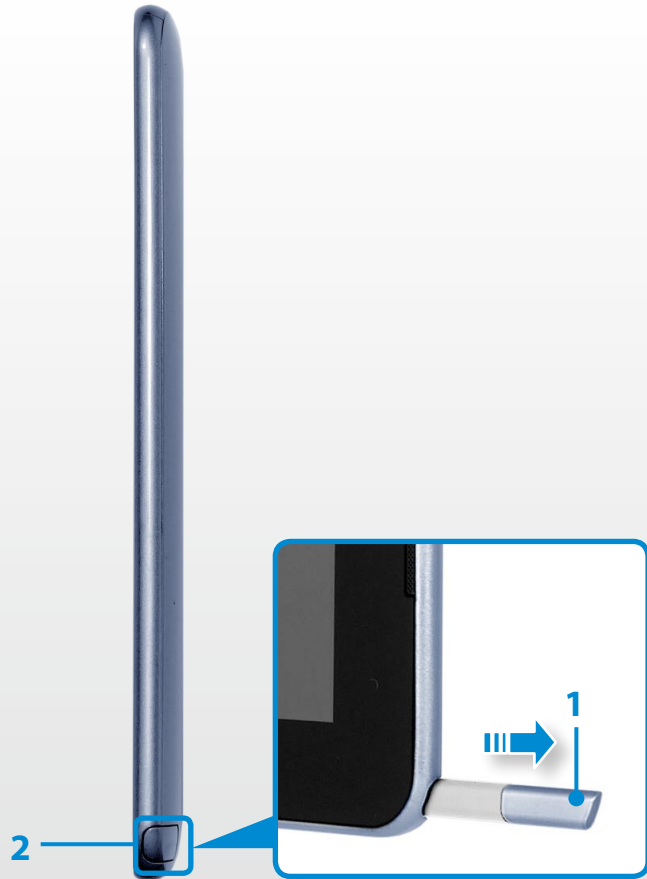

- | | | |
|---|------------------------------|--|
| 1 | S Pen (Optional) | A pen used to enter information on the touch screen. |
| 2 | S Pen Slot (Optional) | You can keep the S Pen in the S Pen slot. |







Left View

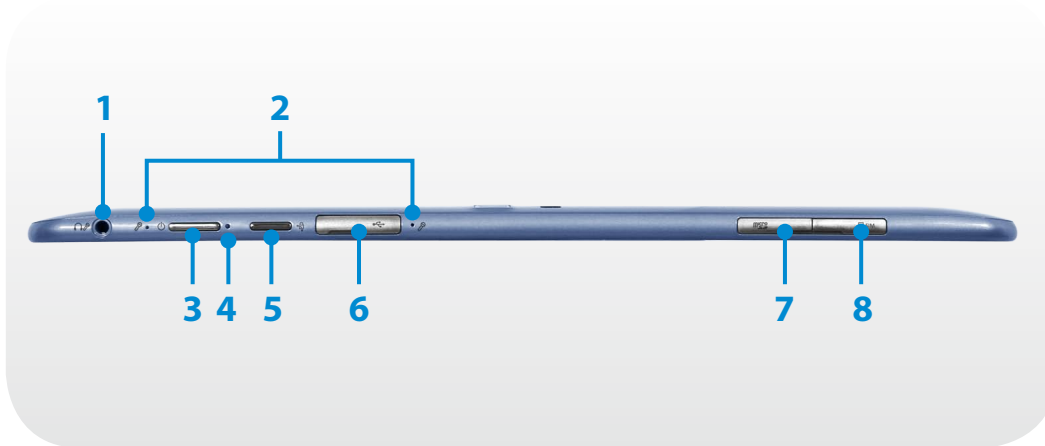

1	Volume Control Button	Controls the volume.
2	Micro HDMI Port HDMI (Optional)	This is the port for a micro HDMI. You can enjoy digital video and audio by connecting the computer to a TV.  You can connect a VGA adapter (optional).

Top View



1	Ear-set / headset Jack 	This is the jack for connecting an ear-set or headset.
2	Microphone 	You can use the built-in microphone.
3	Power Button 	Turns the computer on and off.
4	Power Button LED	When the computer is on, the power button LED is lit.
5	Rotation Lock 	Locks the screen rotation so that the screen does not automatically rotate according to the orientation function of the product.
6	USB 2.0 Port 	You can connect USB devices to the USB port such as a keyboard/mouse, digital camera, etc.
7	Micro SD Card Slot 	This slot is for micro SD cards.
8	SIM Card Slot (Optional)  SIM	This slot is for SIM cards.

Bottom View

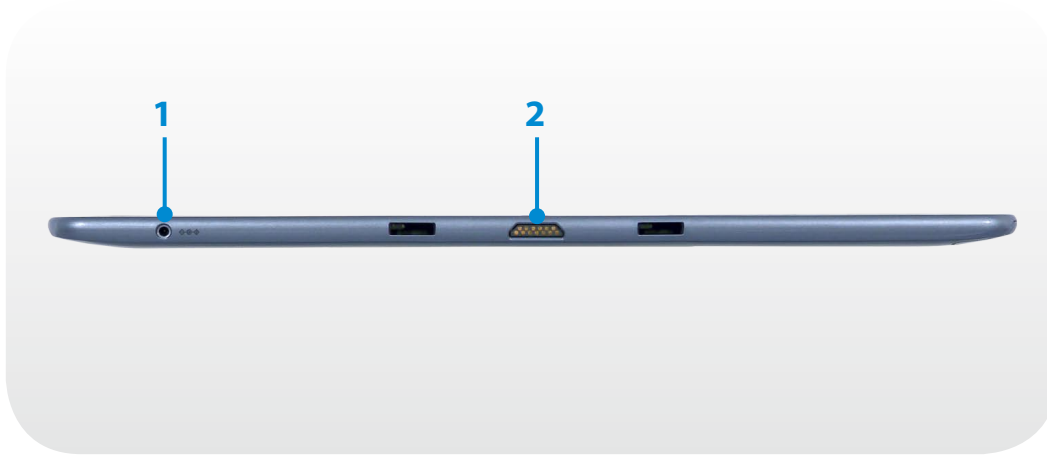

1 DC Jack 

A jack to connect the AC adapter that supplies power to the computer.

2 Dock Connector (Optional)

A connector to the keyboard dock (optional).

Rear View



1	Camera Flash (Optional)	Used when taking photos.
2	Camera (Optional)	Using this camera, you can take still pictures and record video. You can take a picture or make a movie using the Charms > Start > Camera .
3	NFC Antenna (Optional) 	Provides NFC features for near field communication for various application services.

 If you replace the bottom of the product, the model name, serial number and some logos etched into the bottom of the product will no longer be there. For more information, please ask for assistance from the service center.

Turning the Computer On and Off

Turning the computer on

- 1 Connect the **AC adapter**.
- 2 Press and hold the **Power button**  for a moment to turn the computer on.



- 3 **Power button LED** is lit while the computer is turned on.





About Windows Activation

When you turn the computer on for the first time, the Windows activation screen appears.

Follow the activation procedures according to the instructions on the screen to use the computer.

Adjusting the screen brightness

When the computer runs on battery power, the LCD brightness is automatically set to low.



- 1 Slightly drag from the right edge of the screen toward the center to display the **Charms menu**.
- 2 Increase the bar by pressing the **Settings**  > **Screen** .

Turning the Computer On and Off

Turning the computer off



- Since the procedures to turn the computer off may differ depending on the installed operating system, please turn the computer off according to the procedures for the purchased operating system.
- Save all your data before clicking on **Shut down**.

- 1 Slightly drag from the right edge of the screen toward the center to display the **Charms menu**.
- 2 Click **Settings**  > **Power**  > **Shut down**.

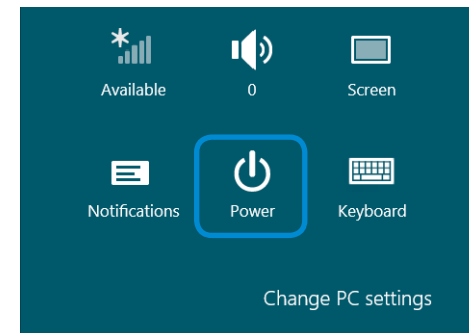

If you want to power off your computer when you are logged out, unlock the screen and click **Power**  > **Shut down**.



Chapter 2.

Using Windows 8

What is Microsoft Windows 8?	33
Screen At a Glance	34
Using the Charms	36
Using Apps	38
Windows Hot Key Function	42

What is Microsoft Windows 8?

Microsoft Windows 8 (hereafter referred to as Windows) is an operating system that is required for operating a computer.

To use your computer optimally, you need to know how to use it properly. Therefore, It is better to learn how to use Windows by utilizing **Windows Help and Support**.

- The screen may appear somewhat different depending on the model and the operating system.
- Since this guide has been prepared based on Windows 8, some of the instructions may differ depending on the version. It may also be modified without prior notice.

Displaying Help

Move the pointer on the screen to the top or bottom right edge of the screen to view the **Charm menu**.

Alternatively, slightly drag the right edge inward with your finger to view the **Charm menu**.

Select **Charm menu** > **Settings**  > **Help**.

- If you are connected to the internet, you can access the most recent online Help.

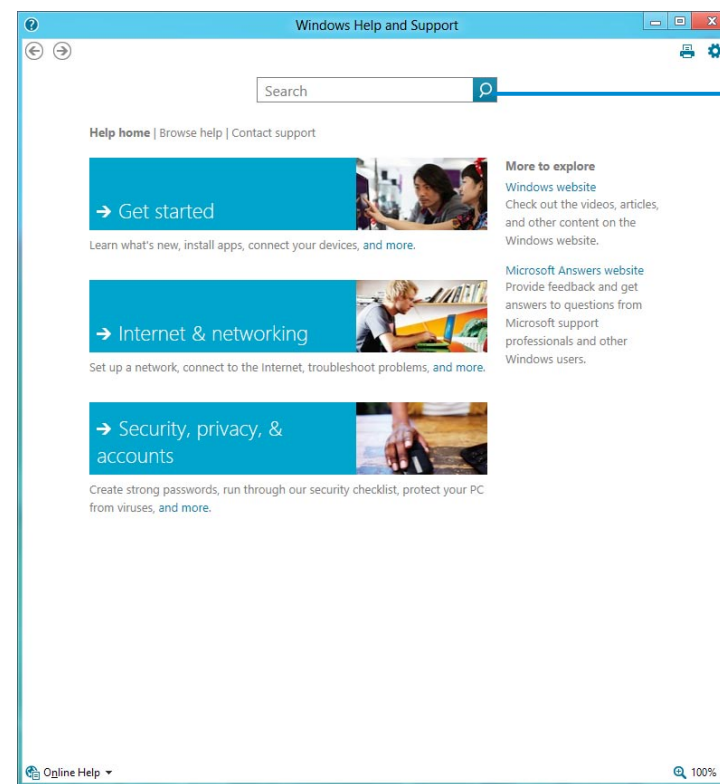

Searching for Help

Get Started

You can view basic instructions on how to use your computer including new function(s) for the Windows OS.

Internet & networking

After connecting to the network, you can check the Help section required to use the internet.

Security, privacy, & accounts

You can check the Help information required to protect your computer and personal information.

Windows 8 provides both the new **Start screen** mode and the **Desktop** mode of the existing OS.

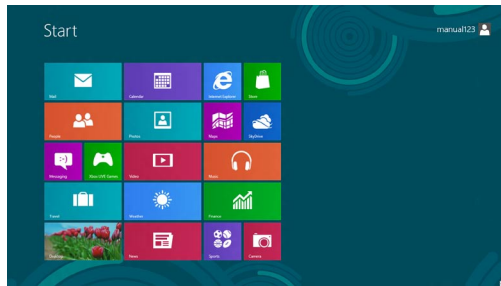

Start Screen



Desktop

Start Screen

When you turn on the computer, the **Start screen** is displayed, which allows you to use the applications (Application, App, hereafter referred to as an **App**) at the same location.

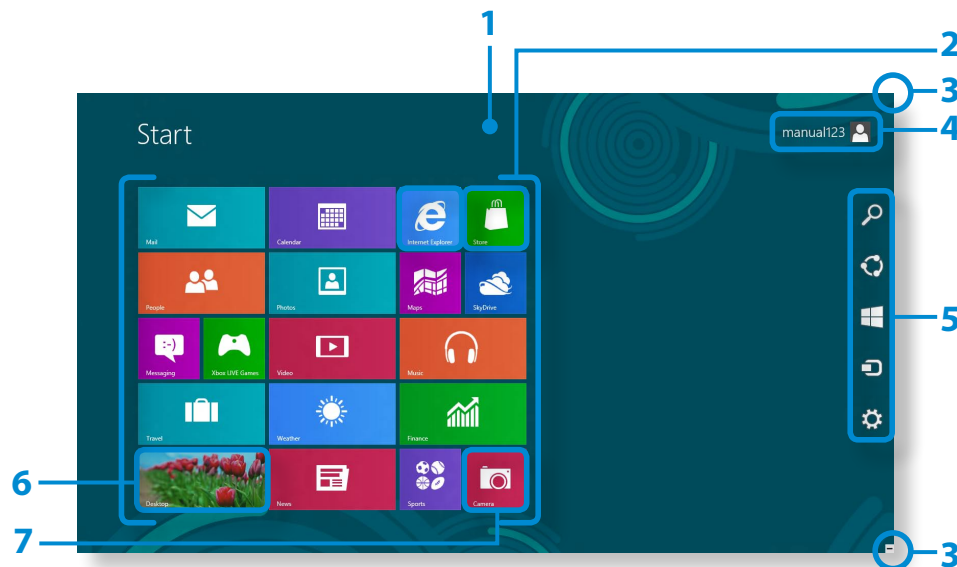

1	Start Screen	Refers to the default Start screen of Windows 8.
2	App	Refers to the apps that are currently installed.
3	Displaying the Charms	The Charms is hidden at the right of the screen. Place your mouse pointer at the edge of the top or bottom right of the screen to display the Charms. Alternatively, slightly drag the right edge inward with your finger to view the Charm menu.
4	User Account	This refers to the currently used user account.
5	Charms	This refers to the menu that allows you to use functions such as Search, Share, Start, Device and Settings.
6	Desktop	Switches to Desktop mode.
7	Camera	Allows you to take pictures or make a movie.

Desktop

This provides similar functions to those provided by the Desktop in prior Windows versions.



1 Desktop Refers to the Desktop.

2 Displaying the Charms

The Charms is hidden at the right of the screen. Place your mouse pointer at the edge of the top or bottom right of the screen to display the Charms.

Alternatively, slightly drag the right edge inward with your finger to view the Charm menu.

3 Charms

This refers to the menu that allows you to use functions such as Search, Share, Start, Device and Settings.

4 Switching to the Start Screen

Click the corner of the bottom left of the screen to switch to the Start screen.

Displaying Documents and Files

Click Windows Explorer in the taskbar on the Desktop  to search for documents and files.

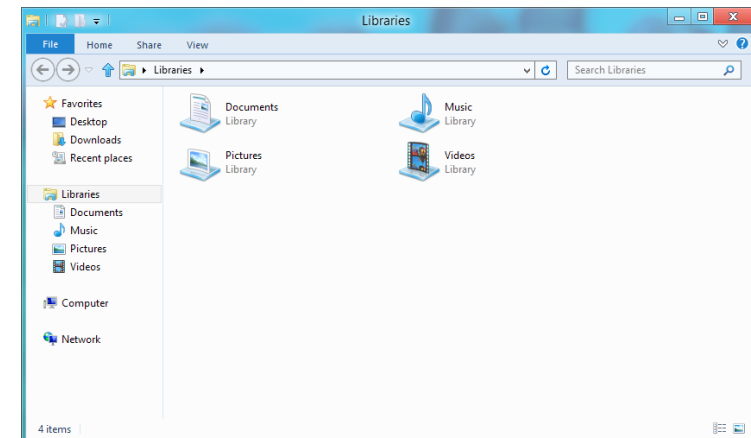

Using the Charms

The Charms is a new type of menu that combines the Start menu with the Control Panel of existing Windows.

The Charms allows you to quickly configure the device(s) connected to your computer, search for App(s)/file(s), and use the sharing function, etc.

Activating the Charms

Slightly drag the right edge inward with your finger to view the **Charm menu**.

Alternatively, tap the top or bottom right edge of the screen to view the **Charm menu**.

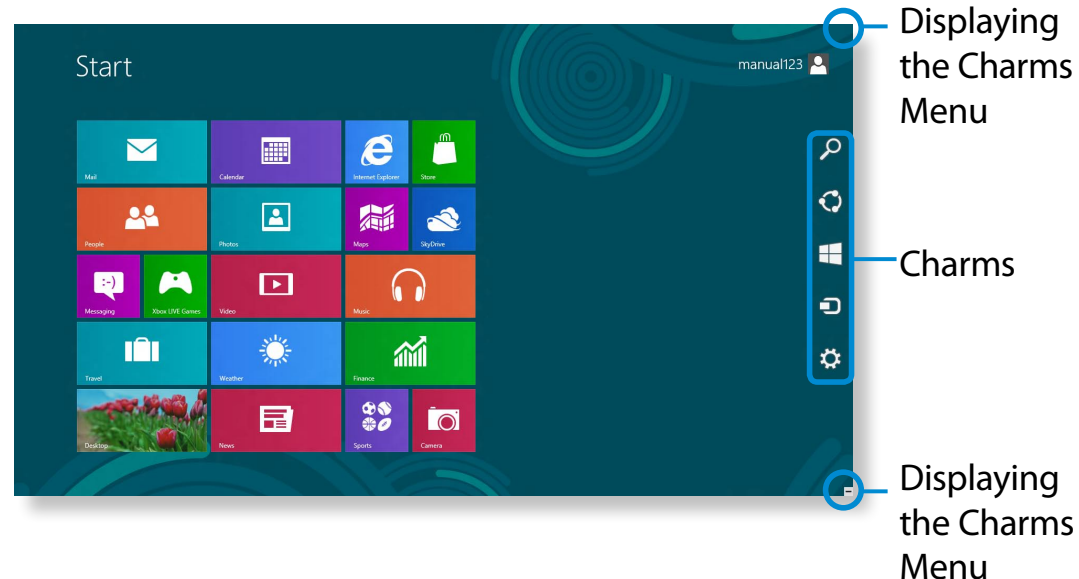

Search

If you want to search for a program or file in the App(s)/ Settings/File(s), simply enter a keyword in the Search charm and start Search.

You can also search within an App or on the Web.



Share

You can use this menu to transfer a picture or file to another user. You can easily share pictures or files with other users simply by associating multiple Apps with the Share charm.



Start

You can move to the Start screen.



Device

As this allows you to move directly to a desired device, you can handle tasks such as importing pictures from a digital camera, streaming a video to your TV or transferring files to a device on the current screen.



Settings





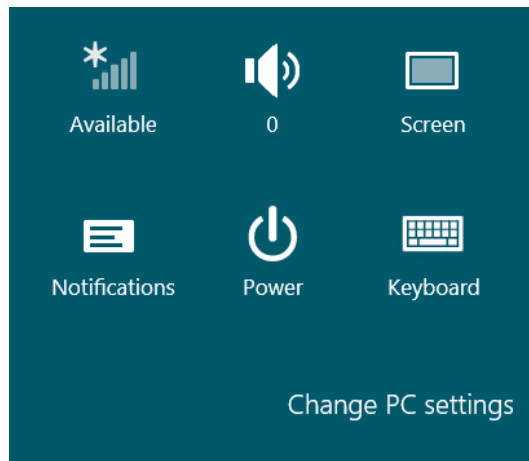

The Settings charm allows you to perform basic tasks such as adjusting the volume, turning off the PC, etc. If you select the Settings charm while a specific App is running, the settings for the currently running App are displayed.

Changing the Settings

Frequently used Windows menus are collected.

Click the **Charms > Settings**.



Icon	Name	Function Description
	Wireless Network	You can connect to a wireless network. Select a wireless network to connect to.
	Adjusting the Volume	You can adjust the volume or mute the sound.
	Screen	You can adjust the screen brightness.
	Notice	You can set the interval at which an App sends notices.
	Power	You can turn off your computer or select the Power Options.
	Keyboard	You can set the Language or launch Touch keyboard.

Change PC settings

You can change more settings.

An App refers to an application program (hereafter referred to as an **App**). In a larger sense, it refers to all the software programs installed on the operating system.

Windows 8 provides basic Apps for frequently performed tasks.

Starting/Exiting an App

Click on an App in the Start screen to activate it.

To exit the App

- 1 Move your mouse pointer to the top of the screen. Your mouse pointer changes to a **hand shape**.
- 2 Click and hold your mouse button and then drag it to the bottom of the screen. The App moves downward and disappears and exits.

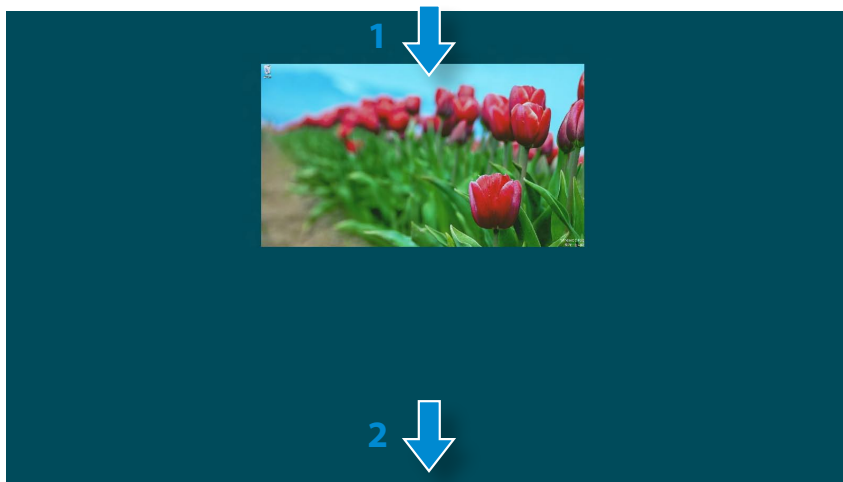

Using Apps



You can use the following function with the mouse.

Displaying Currently Running App(s)

- 1 Move your mouse pointer to the top left corner of the screen to display the last run App.
- 2 Then, move your mouse pointer down to display a list of the currently running Apps in order.

- 3 Click on an App in that list or drag it to the center of the screen. Now, you can check the selected App which is currently running.

 Right-click over the App in the list and click **Close** to exit the App.

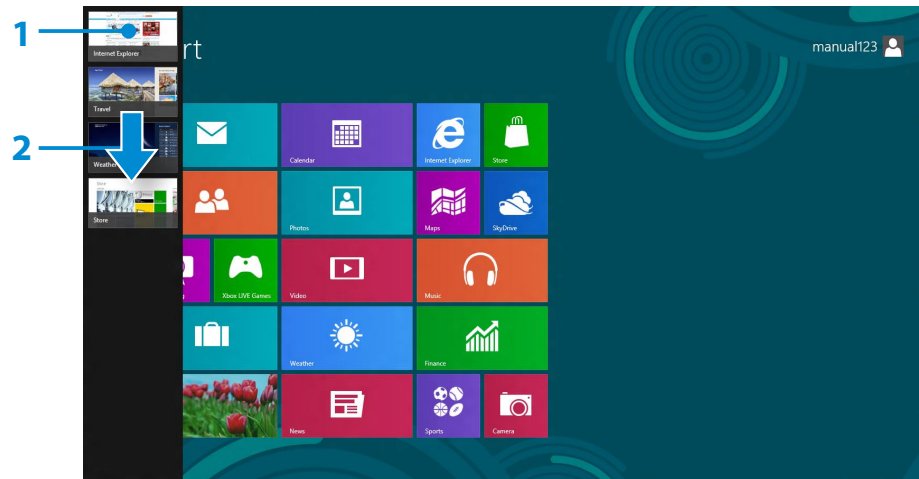

Running Two Apps at the Same Time

- 1 Select the **Apps** in the **Start screen**.
- 2 Move your mouse pointer to the top of the screen. Your mouse pointer changes to a **hand shape**.
- 3 If you click and hold your mouse button and move left or right, you can split the screen to display multiple Apps.
- 4 Move the **Screen Split Bar** to change the screen split ratio. Supported screen split ratios are 3:7 or 7:3.

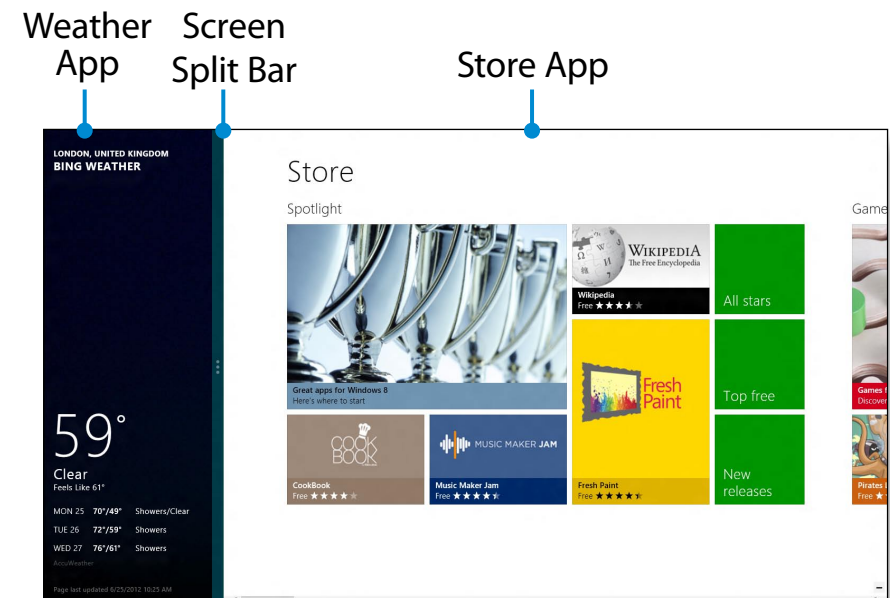

Ex) If you run the **Weather App** and **Store App** at the same time

Adding/Removing an App to/from the Start Screen

In the **Start screen**, slightly drag the top edge of the screen inward.

Click **All Apps**  at the bottom of the screen to display all the Apps that are currently installed.

1 If you right-click over the App to be added, the relevant menu is activated at the bottom of your screen.

2 Click **Pin to start**  or **Unpin from Start** .

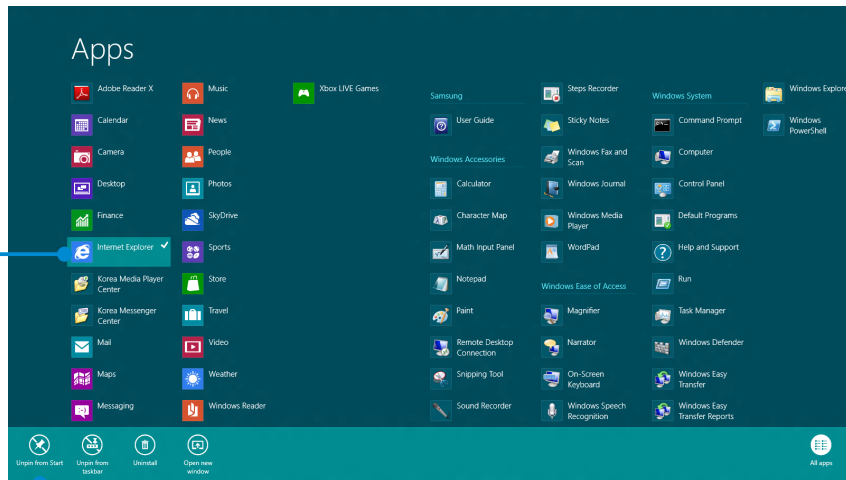

Ex) When removing an App in the Start screen

Using the Windows Store

If you run the App Store in the Start screen, the Apps in the Windows Store are displayed.

However, a Microsoft account is required to purchase App(s) in the Windows Store.

Continue after registering your Microsoft Account in the Charms.

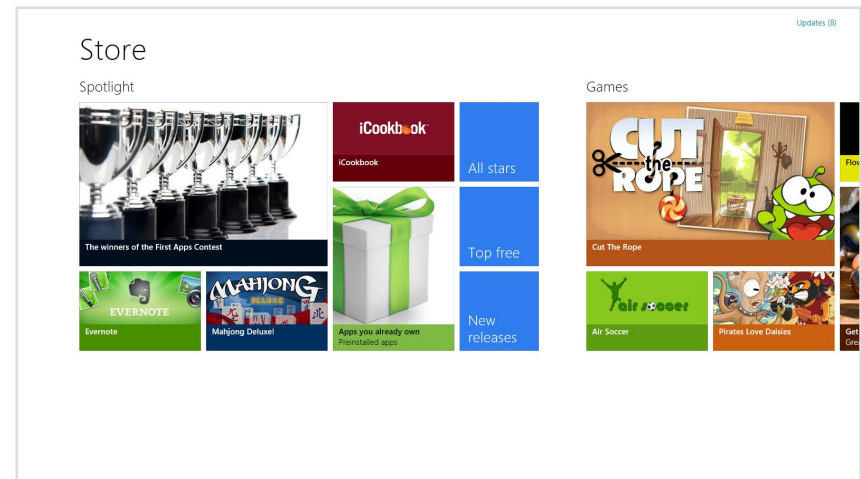

Samsung cannot solve errors occurring with other apps installed from the Windows Store. Contact customer support for the app directly.

Configuring your Microsoft Account

A Microsoft Account allows you to synchronize your settings with other device(s) running Windows 8 online allowing you to share file(s) or settings.

You should register a Microsoft Account to download or purchase App(s) from the Store.

- 1 Run the **Charms** and click **Settings > Change PC Settings**.
- 2 Click **Users > Your account > Switch to a Microsoft account**.
- 3 Register your account through the following relevant procedures.

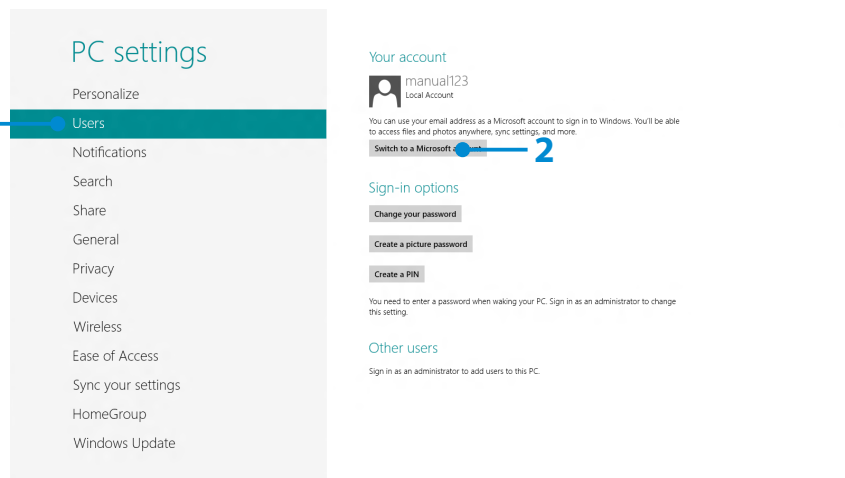

Windows Hot Key Function

You can use the following convenient hot keys in Windows 8.



You can use the following function when an external-type keyboard is connected.

Function	Hot Keys	Function Description
Displaying the Start Screen	Windows Key	Switches to Start mode.
Displaying the Desktop	Windows Key + D	Switches to Desktop mode.
Running the Charms	Windows Key + C	Activates the Charms.
Locking the Screen	Windows Key + L	Locks the screen.
Opening the Ease of Access Center	Windows Key + U	Opens the Ease of Access Center configuration.
Opening the Second Screen Settings	Windows Key + P	Opens the External Monitor Settings menu.

Function	Hot Keys	Function Description
Opening the Advanced Management Tool	Windows Key + X	Opens the Advanced Management Tool.
Exit App	Alt + F4	Exits the currently running App.



Chapter 3. Using the computer

Using the Touch Screen	44
Micro SD Card Slot (Optional)	52
Connecting an External Display Device	54
Adjusting the Volume	57
LCD Brightness Control	59
Wireless Network (Optional)	60
Mobile broadband (Wireless WAN, Optional)	62
NFC (Near Field Communication) (Optional)	63
Using the Keyboard Dock (Optional)	65
Using the S Note app (S Note, Optional)	71
Samsung Software Update	75
Diagnosing the Computer Status and Troubleshooting	76
Battery	77
BIOS Setup	80

Using the Touch Screen

You can use the computer using the touch screen only, without using the keyboard and mouse. The touch screen function is only supported for models which have the function installed at the factory.



- Operate the touch screen using your finger or the S Pen. Other tools such as a ballpoint pen are not recognized and using sharp objects may damage or scratch the surface of the LCD.
- If a S Pen (optional) is provided, you can use the S Pen instead.
- Since touching the touch screen with a conductive material such as a metallic object may cause a malfunction, take care not to touch the screen with this kind of object.

Using the Touch Screen





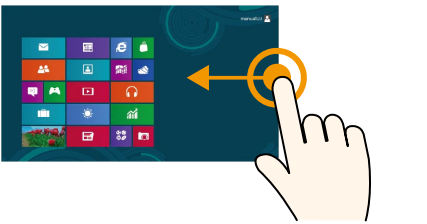

- This function is provided by touch screen models running Windows 8 and will only work for some applications.
- In addition, note that the supported functions are dependant on the application.
- You can use the S Pen (optional) as you use your fingers. The descriptions here are for using your fingers.

Learning basic touch screen operations

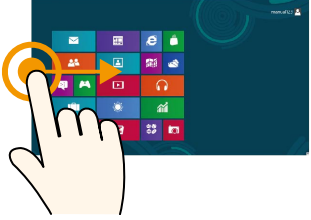
You can easily learn how to use the touch screen conveniently.

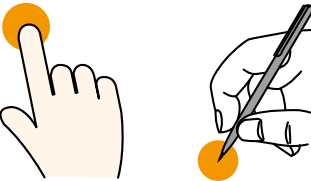
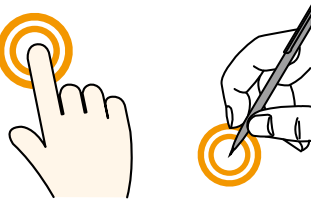
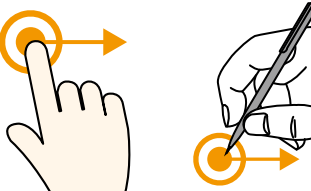
Touch Operation	Function Description
 <p data-bbox="577 1369 1057 1455">Dragging from the right edge toward the center</p>	<p data-bbox="1120 1396 2172 1436">Displays the Charms menu which is hidden at the right of the screen.</p>

Touch Operation	Function Description
	<p>Dragging from the left edge toward the center</p> <p>Displays the last run App.</p>
	<p>Dragging from the bottom edge upward or from the top edge downward</p> <p>Displays the options for the currently running application.</p>
	<p>Touching slightly (Clicking)</p> <p>Slightly press with your finger to select an item. (If you slightly touch a specific menu, option, application icon, etc. on the screen, the corresponding capability is activated.)</p>
	<p>Touching twice (Double-clicking)</p> <p>Slightly press twice with your finger to select an item.</p>
	<p>Touching and dragging</p> <p>Moves the selected target or moves to the next page. You can draw a picture or write some letters with this operation.</p>

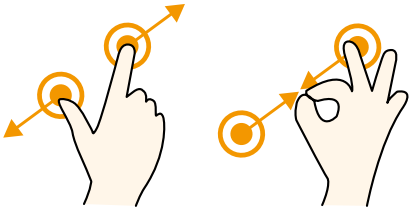
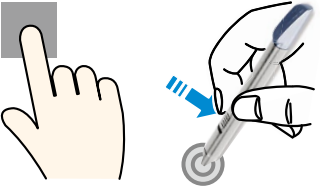
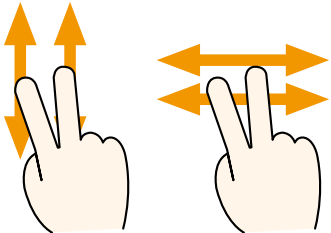
Touch Operation	Function Description
	<p>Rotating with more than 2 fingers</p> <p>Rotates the selected target.</p>
	<p>Spreading 2 fingers widely or bringing them towards each other</p> <p>Zooms in or out of the target.</p>
	<p>Touching and holding for a while (Right-clicking your mouse)</p> <p>Provides the same function as right-clicking your mouse button. Displays the additional options which can be set for the selected target or more detailed information.</p>
	<p>Touching and dragging 2 fingers up/down, left/right (Scrolling)</p> <p>Moves up/down, left/right. Provides the same function as scrolling your mouse.</p>

Using the S Pen (optional)

If a S Pen is supplied with the product, you can operate the computer with the pen instead of your fingers.

You can use the S Pen as you would use your fingers.

Taking Out the S Pen

Take out your S Pen toward the right.

After using the S Pen, keep it in the S Pen slot.



S Pen structure and functions

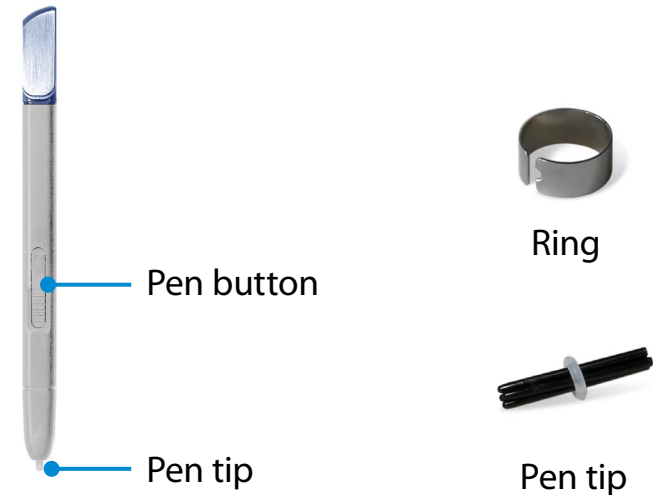

Pen tip
(Use this to perform the role of the left mouse button)

This performs the function of your finger tip when you touch the screen.

Pen button
(Use this to perform the role of the right mouse button.)

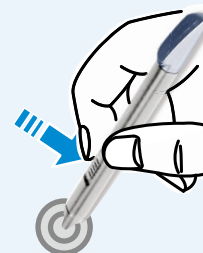

If you press the pen button when the S Pen tip is on the screen, circles appear around the pointer on the screen. Touch the screen with the S Pen while holding down the pen button. This performs the right-click function.

Using the Touch Screen

Replacing the pen tip

If the pen tip is damaged, you can replace the pen tip as follows:

- 1 Hold the pen tip by inserting it into the hole of the ring and remove the tip by pulling it out.



- 2 Insert the new pen tip into the S Pen.



Take care so that the pen tip does not spring out when taking it out.

Screen Calibration

When the pointer on the screen does not precisely match the points you touch, calibrate the touch screen using the **Tablet PC Settings** menu.

The calibration process for the touch screen may differ depending on the operating system and may not be available in some operating systems. The following descriptions assume the Windows 8 operating system.

- 1 Click **Charms menu** on the Desktop > **Settings** > **Control Panel** > **Hardware and Sound** > **Tablet PC Settings** > **Calibrate**.

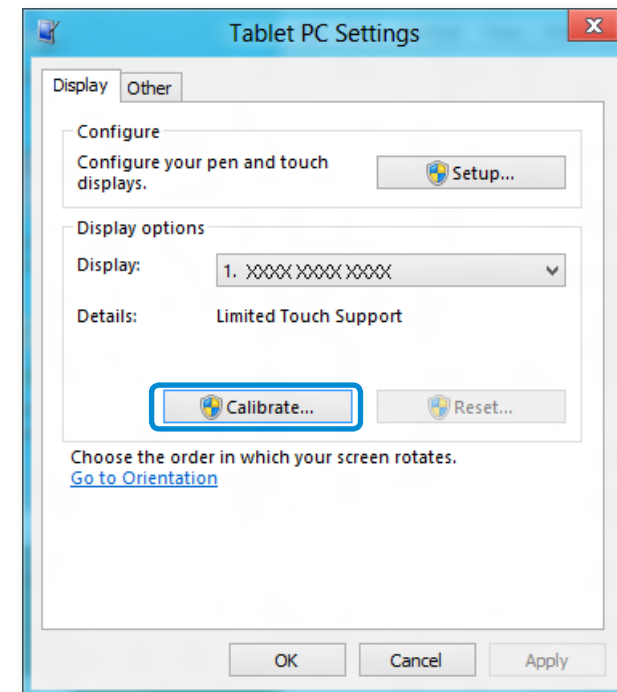

Using the Touch Screen

- 2 Select the screen type to calibrate. If the **Calibration** screen appears, touch the point represented by the “+” mark and then remove your finger.

The “+” mark appears sequentially from the top left to the bottom right of the screen.



- 3 When the **Do you want to save the calibration data?** window appears, click **Yes**.

The touch screen input points are calibrated.

Entering Characters

You can enter characters using the **keyboard** and the **Tablet PC Input Panel**.

Entering characters may differ depending on the operating system and is not supported by some operating systems.

If you are using your computer for a long period of time, it is recommended using the keyboard.

Entering characters is explained using an example with notepad.

Using the Tablet PC Input Panel

The **Tablet PC Input Panel** is an onscreen keyboard provided by **Windows**.

Follow the descriptions and illustrations on how to use the **touch keyboard** and **handwriting mode**.

- 1 In the **Start screen**, slightly drag the top edge of the screen toward the center.

Press **All Apps**  > **Notepad**.

- 2 Put your hand on the Notepad screen to display the cursor.

- 3 On the Desktop, press the  at the right of the taskbar to display the **Tablet PC Input Panel**.

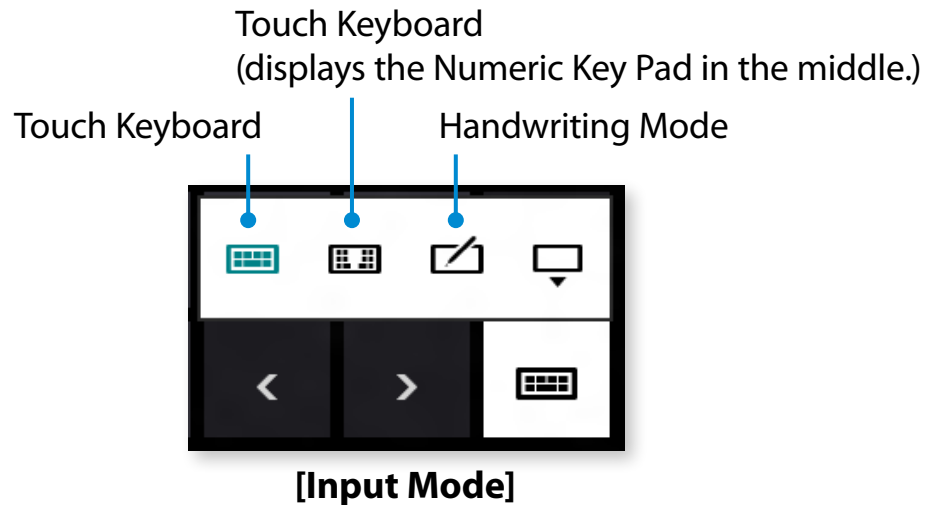
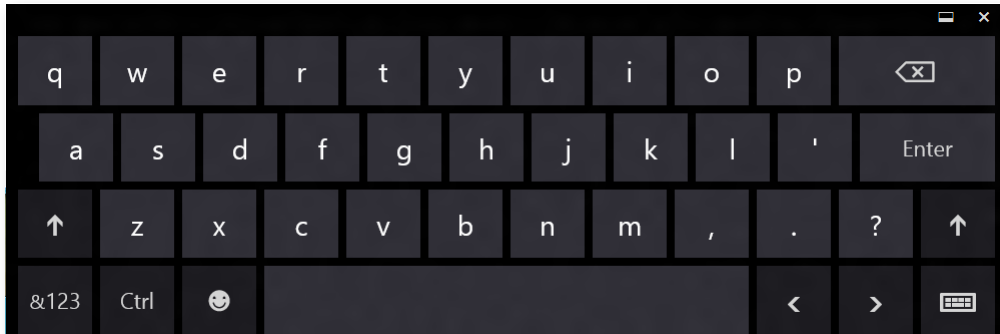

Entering characters using the Touch Keyboard

The **Touch keyboard** has the standard keyboard layout which allows you to select keys to enter characters.

- 1 Press the **Touch Keyboard** icon  in the Tablet PC Input Panel.
- 2 Press the keys to enter your characters.

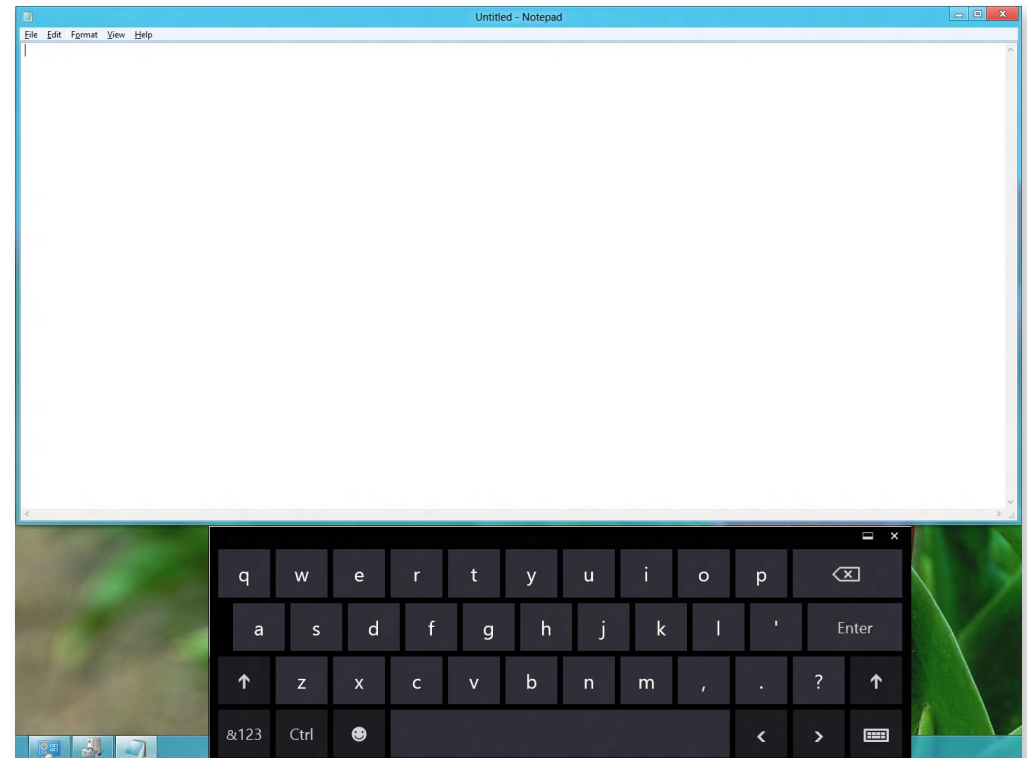

Entering characters in Handwriting Mode

You can enter characters by writing them in the Handwriting Mode Input Panel on the touch screen.

 Handwriting Mode may not be available in some languages.

- 1 Press the **Handwriting Mode** icon  in Tablet PC Input Panel.
- 2 Write characters in the input area of the **Handwriting Mode Input Panel** on the touch screen.

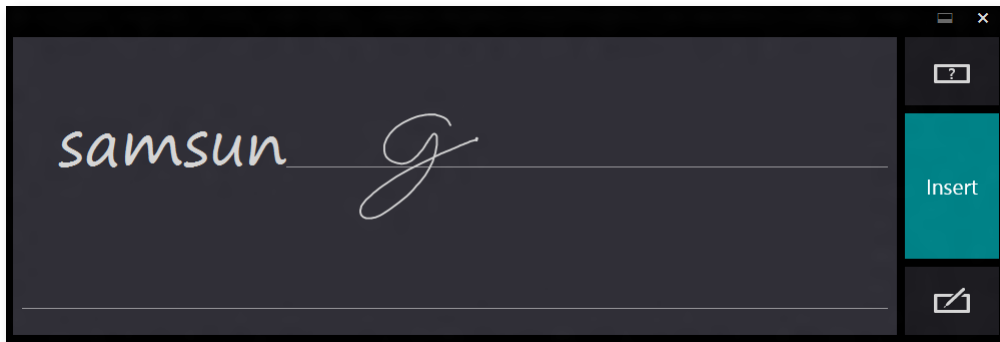

- 3 Press the **Insert** button to enter characters.

Touch screen use precautions

- Use the touch screen with clean and dry hands. In a humid environment, remove the moisture from your hands and the touch screen surface before use.
- Avoid directly spraying liquid cleansing solution onto the touch screen. The liquid solution may enter the touch screen through the bottom edge.

When using a liquid cleansing solution, dampen a cloth in the solution and clean the screen with the cloth (a cleansing solution or cloth containing abrasives may damage the touch screen.)

- Do not apply a severe impact to the touch screen or press the screen with a sharp object such as a ball-point pen. This may damage the touch screen.
- If your finger only touches the touch screen slightly, your touch may not be recognized.
- If you wish to use a pen, please use the provided S Pen (optional). Otherwise, the computer may not work properly.
- Take care that you do not drop the S Pen as this may damage the pen tip.
- When pressing the touch screen, press over an item precisely taking care not to press other items.
- If the touch screen is contaminated by a foreign substance such as a bug or water, the touch screen will not work properly.

Micro SD Card Slot (Optional)

You can only use the micro SD card slot for micro SD cards.

You can use micro SD cards as removable disks and conveniently exchange data with digital devices such as a digital camera, digital camcorder, MP3, etc.



- You have to additionally purchase a micro SD card with the necessary capacity depending on your requirements.
- You can use a micro SD card just like any data storage device.
A copyright protection function is not supported.
- Since you can lose a card when moving the computer, keep the card separately.
- The figures used for the description are of a representative model. Therefore the figures may differ from the real ones.

Using the card

- 1 Open the micro SD card slot cover and insert the micro SD card.

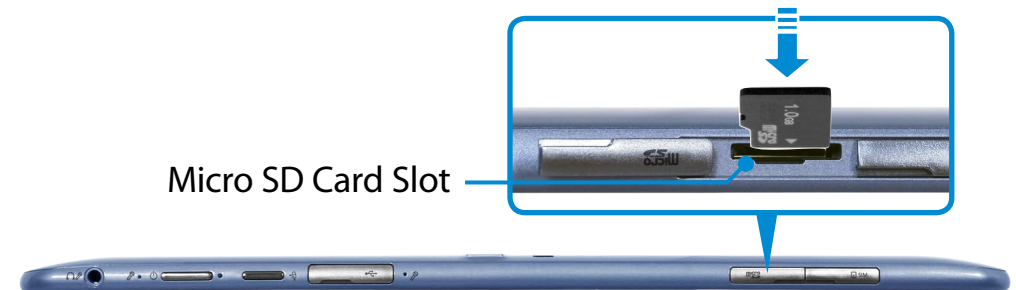

- 2 The following message appears on the top right. Click to **open the folder and click** View Files.

Removable Disk (F:)

Tap to choose what happens with memory cards.



If a message appears to notify you of any problem, click the corresponding window > **Continue without Scanning**. You can perform the following process described in No. 3.

- 3 **Windows Explorer** runs on the Desktop. You can save, move and delete data on the corresponding drive.

Micro SD Card Slot (Optional)

To remove a memory card

Press the card until it pops up, then pull it out by holding the end of the card.

To format a memory card

When using the memory card for the first time, you must format the card before using it.

 Formatting a card deletes all data saved on the card. If the card includes data, backup the data before formatting it.

- 1 Click the **Windows Explorer**  icon in the taskbar on the Desktop.
- 2 Right-click over a card drive with the touchpad and select **Format**.
- 3 Click **Start** to the formatting.



- To use a card to exchange data with a digital device such as a digital camera, formatting the data using the digital device is recommended.
- When you try to use a card, which is formatted in the computer, in another digital device, you may have to format the card again in the device.
- If the write-protect tab is in the **Lock** position, you cannot format, write or delete data on the card.
- Take care when you insert or remove a micro SD card. The micro SD card may be damaged when not treated carefully.

Connecting an External Display Device

If you connect an external display device such as a monitor, TV, projector, etc., you can view the picture on the wider screen of the external device when you give a presentation or watch a video or movie.

Connecting to the monitor port (Optional)

Connect an external monitor, TV, or projector that supports the D-SUB interface to display the image on a wider screen.

You can give better presentations by connecting the computer to a projector.



The VGA adapter is optional and to be purchased.

- 1 Open the monitor port and connect the **VGA adapter**.
Connect the VGA cable (15-pin) to the connected VGA adapter and then connect the other end of the VGA cable to the D-SUB port of the monitor or the TV.

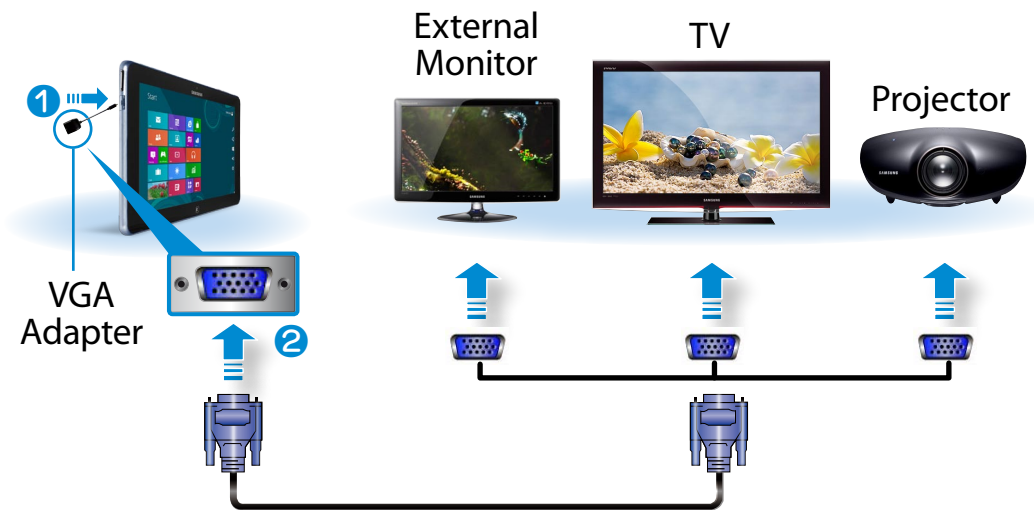





- 2 Connect the power cord of the connected monitor, TV or projector and turn the power on.



Change your TV to external device mode when connecting to the TV.

- 3 Select **Charms menu > Devices**  > **Second Screen**.
Select a desired monitor mode.

	PC screen only The contents are only displayed on the PC monitor (current device).
	Duplicate The contents of the current device are displayed on the external device as well.
	Extend The screen of the current device is expanded to the external device.
	Second screen only The contents are displayed only on the screen of the external device.



Alternatively, to set up dual view:

Open the **Display Settings** window in the Control Panel, select **Monitor 2** and select the **Expand to fit to this monitor** checkbox to set dual view. For more detailed information, refer to the Windows online help.

Connecting through the Micro HDMI port (Optional)

By connecting the computer to a TV with a HDMI port, you can enjoy both a high visual quality and a high sound quality.

After connecting a TV through HDMI, you have to configure the screen and sound.



You have to additionally purchase the HDMI to micro HDMI cable.

- 1 Connect the HDMI to micro HDMI cable to the HDMI port of the TV.

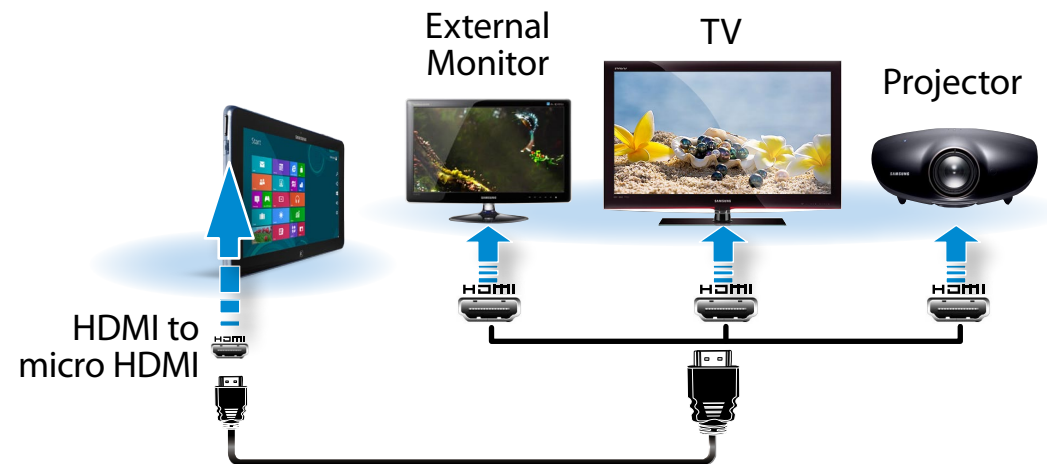



- This is only supported for models that support a TV output port (HDMI).
- When a TV provides more than one HDMI port, connect the computer to the **DVI IN** port.
- When connecting the computer to a TV, switch the external input mode of the TV to **HDMI**.



External Monitor / TV is not supported in the DOS Command Prompt window.

- 2 Select **Charms menu > Devices**  **> Second Screen.**
Select a desired monitor mode.



PC screen only

The contents are only displayed on the PC monitor (current device).



Duplicate

The contents of the current device are displayed on the external device as well.



Extend

The screen of the current device is expanded to the external device.



Second screen only

The contents are displayed only on the screen of the external device.

Adjusting the Volume

You can adjust the volume using the volume control button and the volume control program.

Adjusting the volume with the buttons

You can control the volume by pressing the volume control button on the left side of the computer.

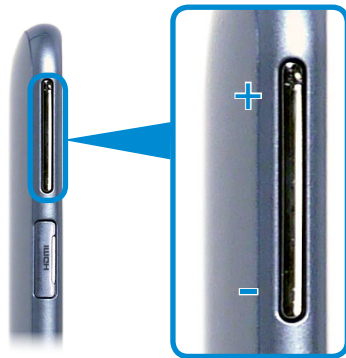

Adjusting the Volume using the Volume Adjustment Program

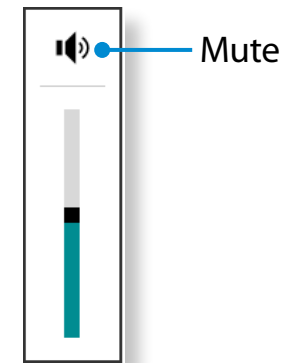

Click the **Charms menu** > **Settings**  >  to adjust the control bar.



Adjusting the Volume

Using the Sound Recorder

The procedures to record sound using the Windows Recorder are described below.

- 1 Connect a microphone to the microphone jack.
Or use built-in microphone.
- 2 Right-click over the **Volume** icon  on the taskbar and select **Recording Device**.
- 3 Check if the microphone is set as the default recording device.
If this is the case, it is already set as the default device. If not, right-click over the microphone and select **Set default**.
- 4 Right-click over the **Charms** menu > **Start**  to click **All Apps**  > **Sound Recorder**. Then press **Start Recording** to record.

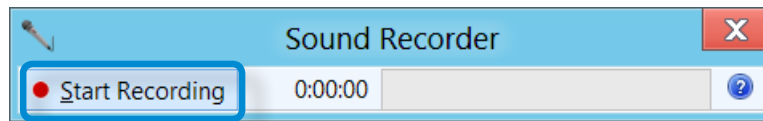

Connecting and using a Ear-set / headset Jack

When there is no sound after connecting an earset or headset, configure the settings as follows.

- 1 On the Desktop, click the **Charms menu** > **Settings**  > **Control Panel** > **Hardware and Sound** > **Sound** > **Play** tab.
- 2 Select the **Speakers (Intel SST Audio Device (WDM))**, click **Set Default** and click **OK**.

Using the Microphone (Optional)



You can optimize the microphone's performance for a single user only or for sharing with others.

- 1 On the notification area of the taskbar, right-click the Audio Manager icon , and then click **Sound Manager**.
- 2 On the **Microphone** tab, select an option to enable, and then click **OK**.
 - . **Narrow**: The computer recognizes sound only from a front 45 degree angle. Select this option if only a single user uses the microphone.
 - . **Wide**: The computer recognizes sound from any front angle so that the microphone can be shared with other people. However, this option may cause noise.

LCD Brightness Control

 The screen brightness is automatically set to the brightest level when AC power is connected and the brightness is automatically set dimmer when the computer runs on battery power to extend the battery use time.

Controlling the Brightness Using the Keyboard

- 1 Click the **Charms menu** > **Settings**  > **Screen Adjustment icon**  .
- 2 Adjust the brightness with the screen brightness control bar.

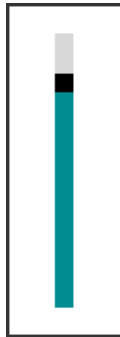

-  • **Saving battery power consumption**
Decreases the LCD brightness when the computer is running on battery power to save battery power consumption.
- **LCD bad pixels principle of computer**
Samsung observes the specifications regarding strict quality and reliability of LCD. But in spite of that, it is inevitable that there might be a small number of bad pixels. A large number of bad pixels can cause problems in appearance, but a small number of pixels doesn't affect the computer performance.
Therefore Samsung observes and manages the following dot principles:
- Bright dot : 2 or less
 - Black dot : 4 or less
 - Combination of Bright and Dark : 4 or less

Instructions for Cleaning the LCD

Clean the LCD panel with a soft cloth lightly moistened with computer cleansing detergent moving in one direction.
Cleaning the LCD panel with excessive force can damage the LCD.

A wireless network (Wireless LAN) environment is a network environment that enables communication between multiple computers at home or a small-size office through wireless LAN devices.

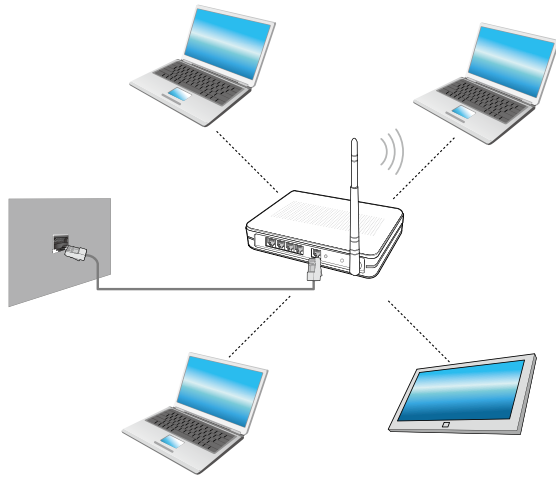

- The screen figures and terms may differ depending on the model.
- The descriptions below are for computer models with a Wireless LAN card or device. A Wireless LAN device is optional.
The pictures in this manual may differ from the actual product depending on your wireless LAN device model.
- If the wireless LAN is turned off, select **Settings > Wireless Network** and set it to **ON**.





What is an Access Point (AP)?

An AP is a network device that bridges wired and wireless LANs, and corresponds to a wireless hub in a wired network. You can connect multiple wireless LAN installed computers to an AP.

Connecting to a Wireless LAN

If there is an AP, you can connect to the Internet via the AP using the Wireless LAN connection method provided by Windows.

1 If you click the **Charms menu** > **Settings**  > **Network Connections**  icon, a list of available APs appears.

If you select an AP to connect to, the **Connect** button appears.

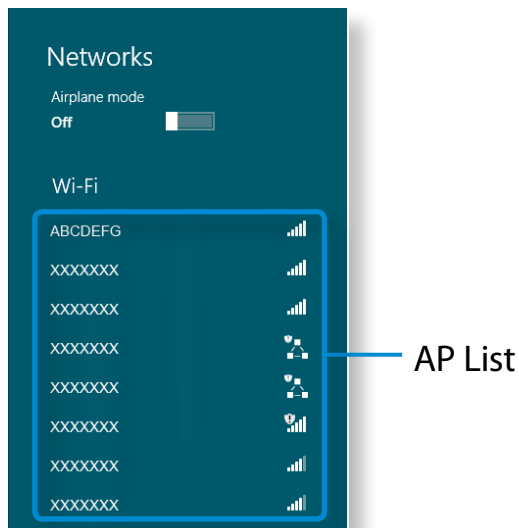

2 Click **Connect**.

If a network key is set for the AP, enter the network key and then click **OK**.



For the network key, please ask your network administrator.

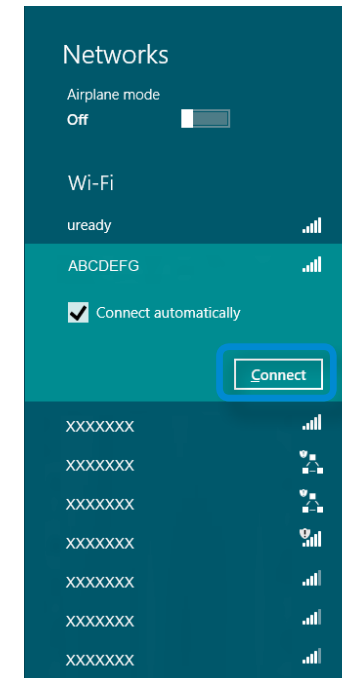



3 When the AP connection is completed, Connected is displayed next to the corresponding AP. You can now use the wireless network.

A wireless wide area network (WWAN) is a mobile broadband network that is available in mobile phone service areas.



- The descriptions below are for computer models with mobile broadband devices. A mobile broadband device is optional.
- Depending on the version of the operating system, some functions may not be provided or different functions may be provided.
- The pictures in this manual may differ from the actual product depending on your WWAN device model.
- For more information on the mobile broadband network, contact the network provider.
- You must activate the SIM before you connect to the mobile broadband.

To find the hardware information for the SIM activation, open the **Charms** and click **Settings**  > **Change PC settings** > **Wireless** > **View mobile broadband hardware information**. You can check IMEI, phone number, and SIM ICC ID information.

- To set a SIM card's PIN for security, open the **Charms** and click **Settings**  > **Network**. Press and hold the carrier name and click **View link properties** > **Secure**.

- 1 Click **Charms** > **Settings**  > **Network** to display available mobile broadband networks as shown below.

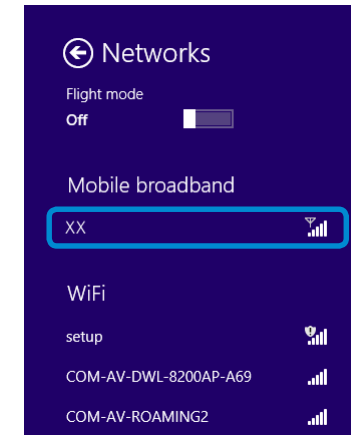

If there are no available network service providers listed under Mobile broadband, turn off the computer, and insert the SIM card correctly, and then turn on the computer.

- 2 Select a carrier, and then click **Connect**.



Clicking **Connect** in a foreign country activates automatic data roaming. Therefore, you may be charged for the data usage.

- 3 If the Profile settings screen appears, follow the onscreen instructions to enter the required information.

- 4 The network connection is established and Internet access is available.

About NFC (Near Field Communication)

- This is a set of standards to establish radio communications within a short distance (usually no more than 10 centimeters). You can share the contents safely and conveniently without any cumbersome setup process.
- Various features such as video/photo transfers, P2P games, mobile payments, reading/writing tags, NFC device communications and so on can be utilized depending on the NFC device.
- You can use the NFC function on devices that have the NFC mark.



For more information on how to use the device, refer to the User Guide of the device.

Simultaneously sharing a website between two computers

This section describes how to connect two NFC computers. You can connect a website displayed on computer A with computer B at the same time.

- 1 Open a website on **computer A** using Internet Explorer.

- 2 On **computer A**, select **Charm menu > Device**  > **Sent by Tap**.

- 3 Put the **NFC antenna**  of the NFC **computer B** into contact with the **NFC antenna**  of **computer A**.



- 4 If the following message appears on the **B computer**, tap on the screen.

Receive content?

Tap to receive content from another device.

- 5 Now, the website contents in computer A are delivered to computer B. You can see the computer A's website on the computer B's Internet Explorer.

Connecting a device

This section describes how to connect an NFC-supported Bluetooth speaker.

- 1 Turn the computer on. Turn the Bluetooth speaker on.
- 2 Put the NFC mark of the speaker into contact with the **NFC antenna**  at the back of the computer.
- 3 The device connection confirmation message appears at the top right of the screen. Tap on the message.
Connect the device according to the instructions on the screen.

Add a device?
Tap to set up your XXXXXXXXXXXX

- 4 The device is connected. You can now use the speaker. Select **Charm menu > Settings > Change PC Settings > Device**  to view the connected device.

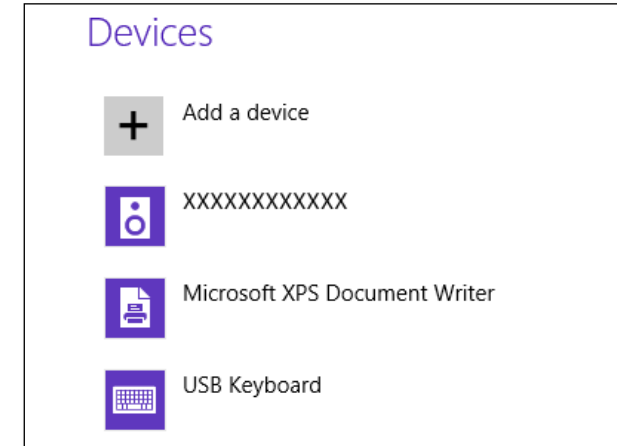

Restrictions

- You can make only one-to-one connection between NFC devices at a time.
- Because the NFC function is not compatible between Windows and Android operating systems, only the URL of the NFC function is transferred to an Android-based mobile device that is connected to the computer.

Use this keyboard dock only with models that support it.

You can use the USB port for external connections while enjoying the convenience of a keyboard.



- You have to purchase the keyboard dock separately.
- Specifications are subject to change without notice .
- The images shown may vary.

Front View

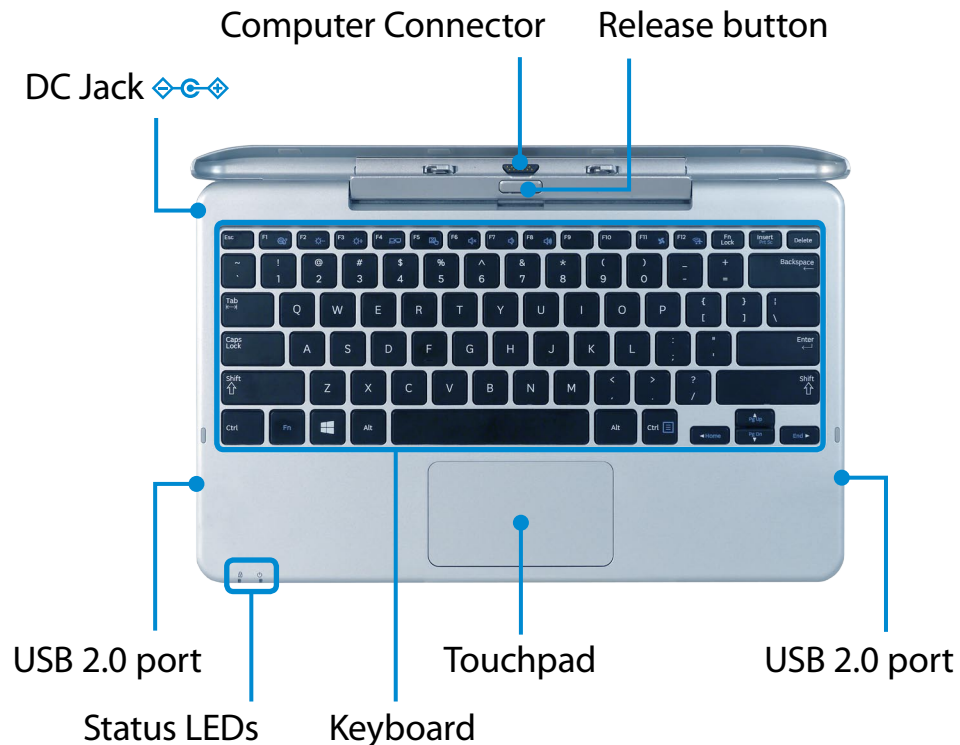

Status LEDs

1 Caps Lock

CAPS LOCK LED indicates the capital lock function. You can enable or disable this function with the Caps Lock key on the keyboard.

- **On:** The English text you type is in capital letters.
- **Off:** The English text you type is in lowercase letters.

2 Power

Power LED indicates the status of your computer and keyboard dock.

- **On:** The computer and the keyboard dock are successfully connected.
- **Blinking:** The Computer and the keyboard dock are not connected properly. Separate the devices and install the computer again.
- **Off:** The computer is in the sleep mode or has no power source. Press the power button to wake up the computer.

Installing/Separating

Attaching the computer

- 1 Align the keyboard dock's connectors and the computer and insert the computer into the docking slot.

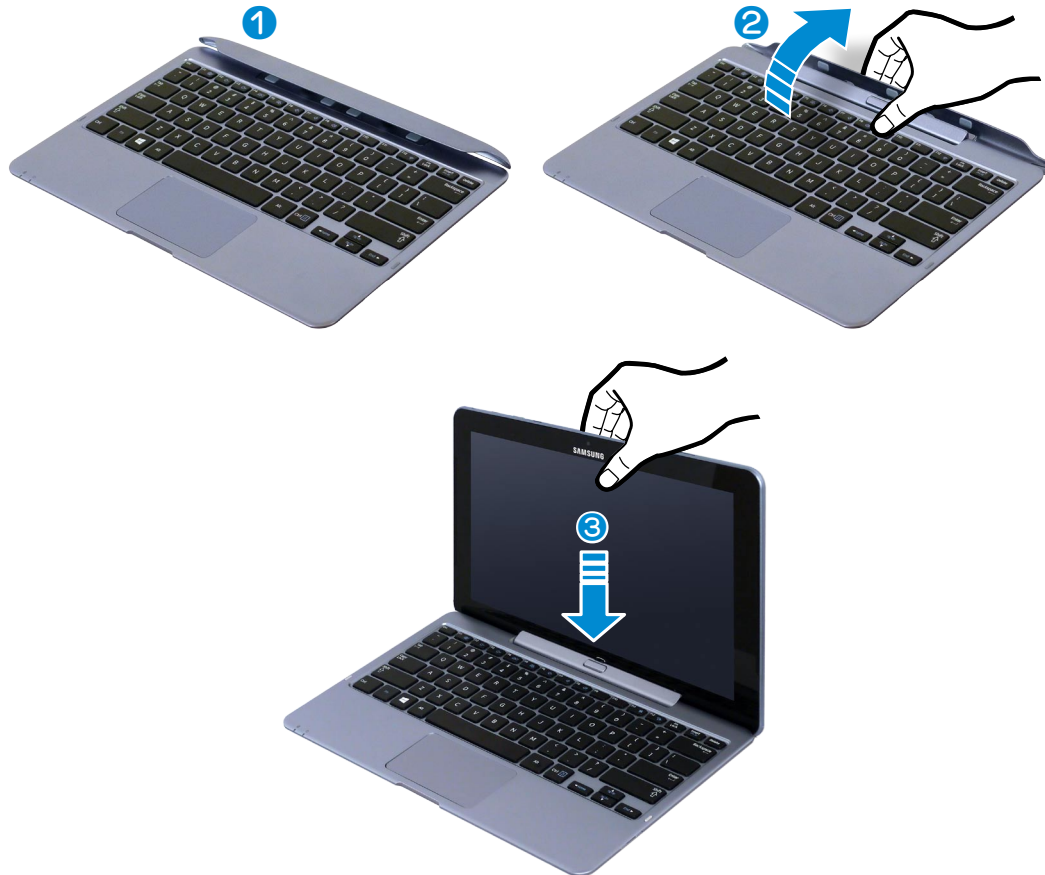

- 2 When the keyboard dock and the computer are properly connected, the keyboard dock **power indicator**  is turned on.



The keyboard dock can operate only on the battery power of the computer.

Separating the Computer

Pull the computer upward by hand while pushing the keyboard dock's release button with the other hand.



The keyboard dock may not operate properly due to impurities on the connectors. Make sure that the connectors are dust-free before connecting the computer to the keyboard dock.

Shortcut Keys

Shortcut key functions and procedures are discussed in the following sections.

Press both the **Fn** key and hot key at the same time.





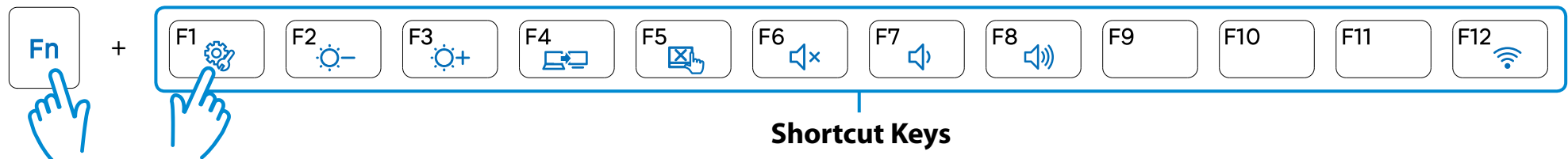

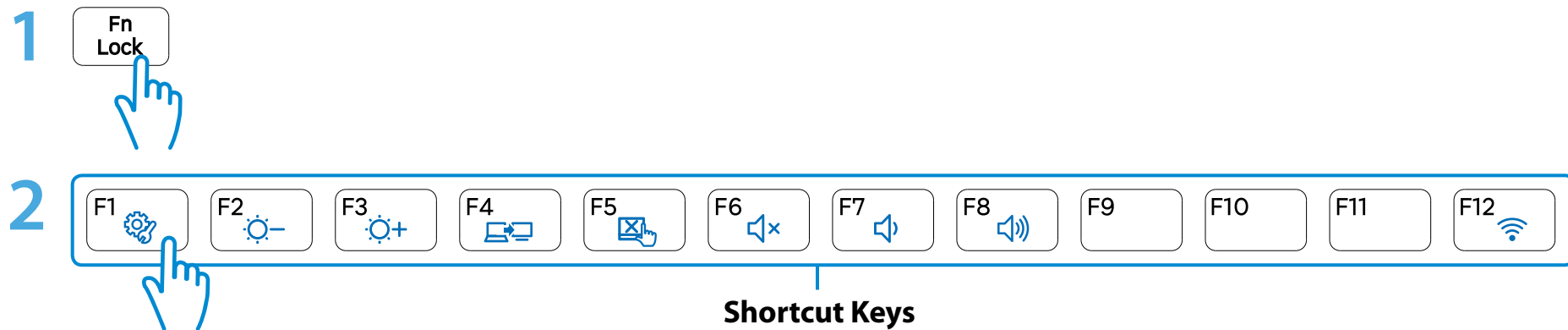

Alternatively, press the **Fn Lock** key as well as a hot key to use the hot key functions more easily.

► Method 1



► Method 2



Shortcut Keys	Name	Function
	Settings	The Samsung software control program, the Settings , is launched.
 	Screen Brightness Control	Controls the screen brightness.
	CRT/LCD	Switches the screen output to the LCD or external monitor when an external monitor (or TV) is connected to the computer.
	Touchpad	Turns the Touchpad function on or off. When using an external mouse only, you can turn the Touchpad off.
	Mute	Press this button to turn the audio on or off.
 	Volume Control	Controls the volume.
	Wireless network	Turns all wireless network devices on or off. (Only for models with a wireless network device.)

Touchpad

The touchpad on this keyboard dock has the same functionality as a typical laptop's touchpad.

In Windows 8, you can use the additional gestures as shown below:

Charms Menu Activating Function

If you place your finger on the right edge of the touch pad and drag your finger toward the center, the Charms menu appears.

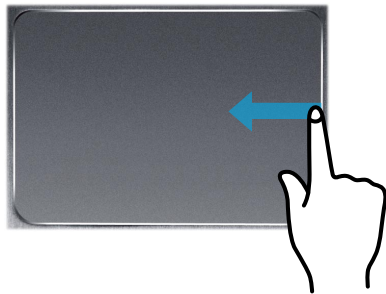

Displaying Additional Menu(s) of a Currently Running App

Place your finger at the edge of the top area on the touch pad and drag your finger toward the center, and the menu of the currently running App appears.

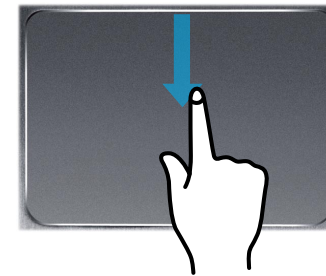

Last Run Window Opening Function

Place your finger on the left edge of the touch pad and drag your finger towards the center to activate a previously operating program from among the currently running programs.

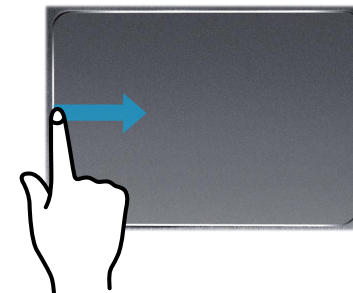

Using the Keyboard Dock (Optional)

The Scroll Function

This function is the same as the scroll area of the Touchpad.

If you place two fingers over the Touchpad and move them up, down, left or right, the screen is scrolled up, down, left or right accordingly.

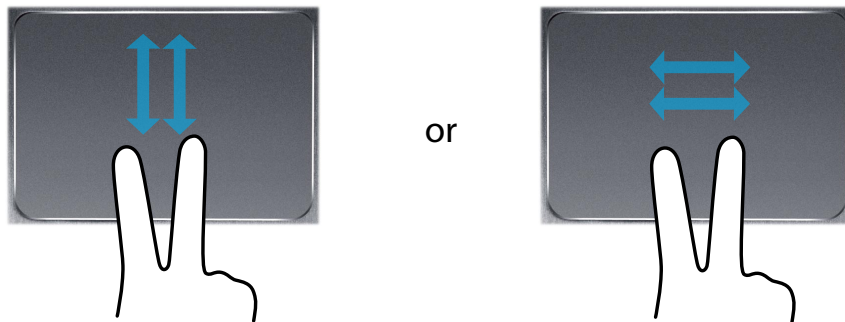

Zoom Functions

If you place two fingers over the Touchpad together or apart, the current image or text is zoomed in or out.

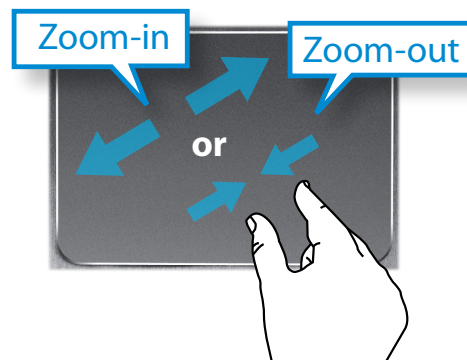



You can design your note using various formats such as idea writing, recipe, diary, travel sketch and so on.

 Depending on the version of the program, some functions may not be provided or different functions may be provided.

Creating a note

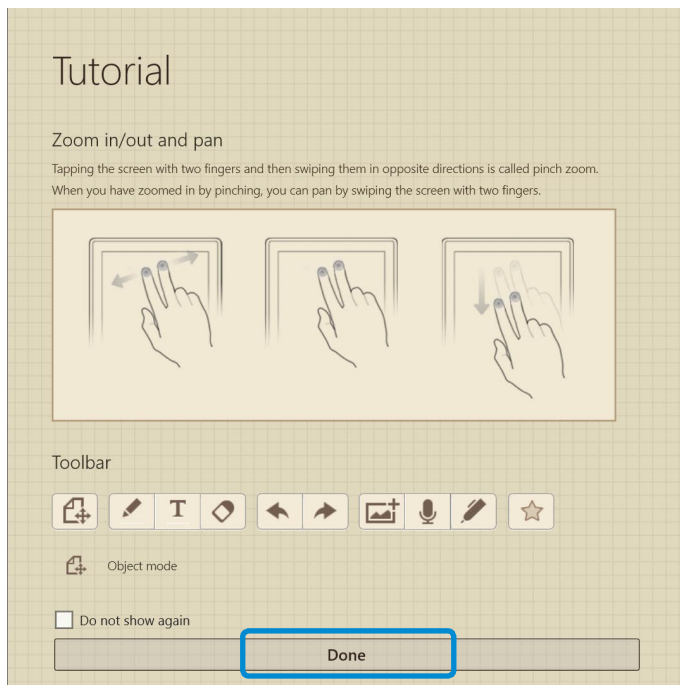
- 1 Select **S Note** in the Start screen.
- 2 The S Note app is launched and the S Note guide appears. Tap **Finish**.



- 3 From the Appbar, tap the **New note** .

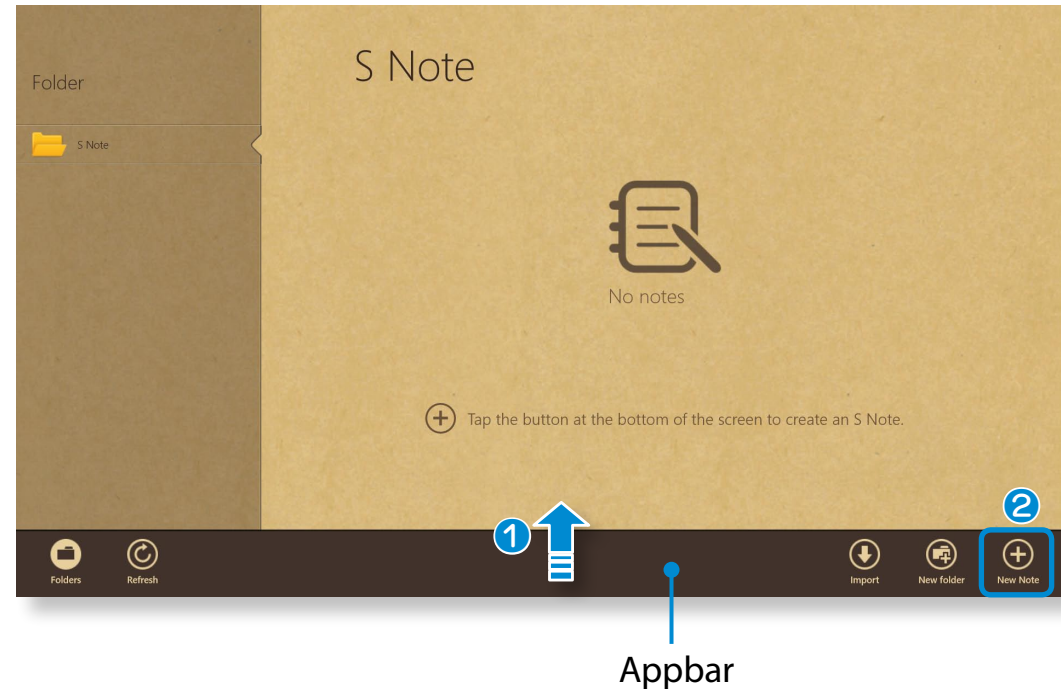

4 Various note format options will appear.
Select a format.

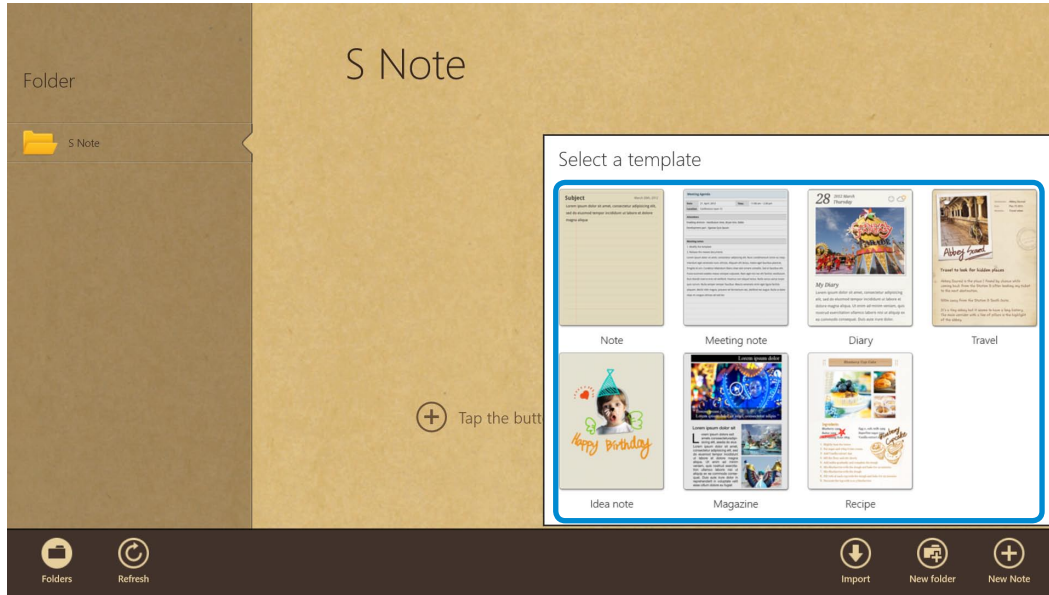

5 Create a note using the Menu.

E.g. When you selected Recipe

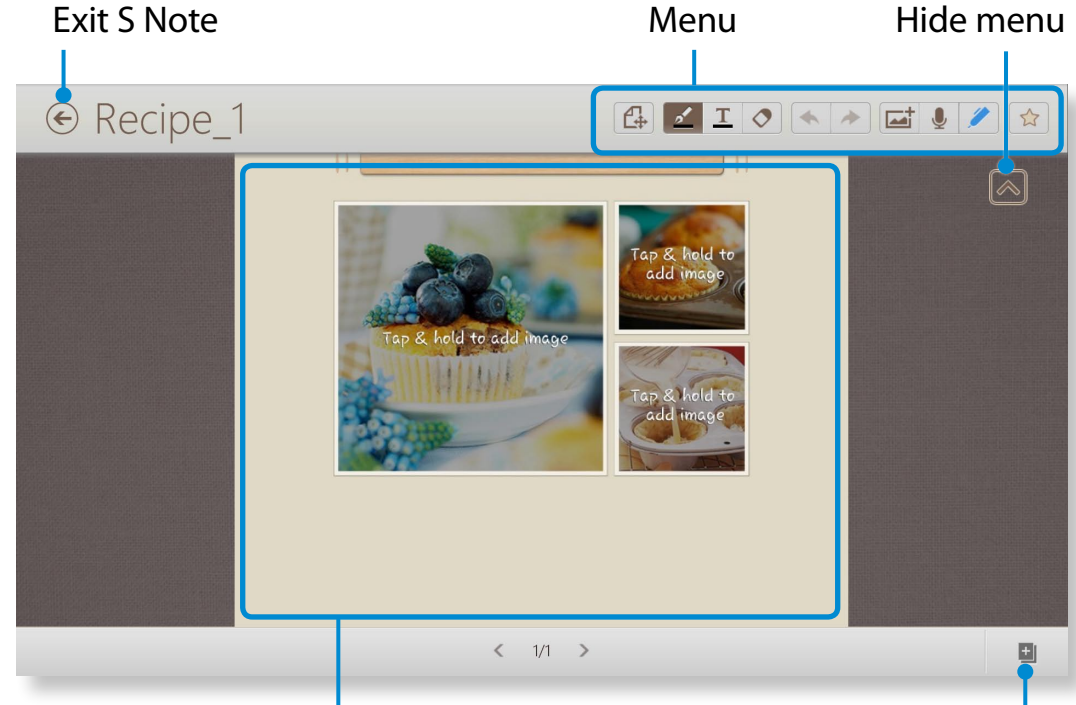

Tap and hold to change the photos or contents.

Add a page

Entering text through the Keypad and style settings

Undo / Redo

Voice memo

Favorites

Select/input mode



Using pens and configuring the pen tools

Eraser

Insert a figure

Turn the S Pen on or off

► Inserting a figure (photo)



We will describe inserting a photo as an example.

- 1 Tap the  icon.
- 2 Select the figure insertion method.
- 3 If you tap on Take a picture, the picture taking screen appears. Tap on the screen to take a picture.





- 4 If the photo has been taken, tap **OK**.
- 5 The photo is inserted into the recipe screen. Adjust the size and location of the photo.
- 6 Inserting a figure is completed.
You can also insert various items such as text boxes, clipart, etc.

► Recording a voice memo

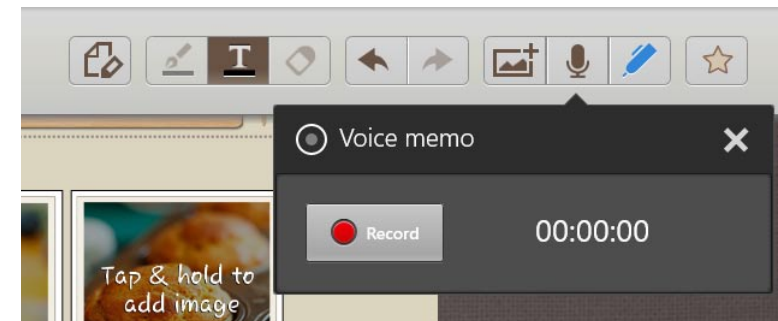
- 1 Tap the  icon.
- 2 The voice memo window appears. Tap the **Record**  button.



- 3 When the recording is complete, tap the **Stop**  button.
- 4 The recording is complete. To make a new recording, tap **Replace**.
- 6 When creating a note is completed, drag the bottom center upward. Tap **Save** to finish creating the note.
- 7 Tap the  icon to exit the note app. Then you can view the newly created note icon.

Sending a note via email

- 1 Slightly drag the note to be sent via email downward in the folder. The note is selected.
- 2 Select **Charm menu > Share**  **> Email**.

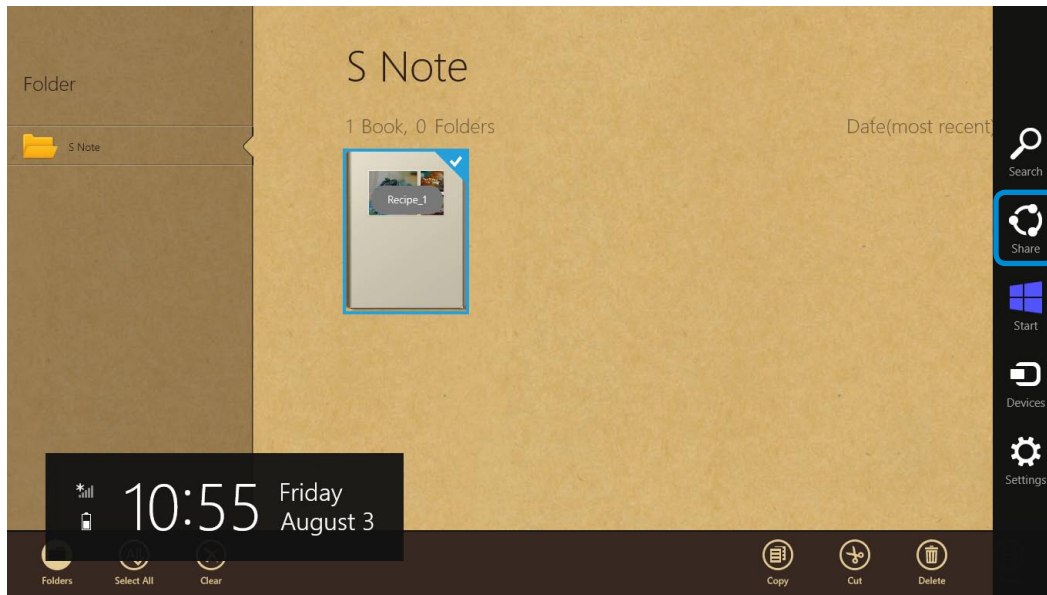

- 3 Send an email according to the instructions below.



- You need a Microsoft account to use the email app.
- To register a note to an app other than the email app, select **Charm menu > Settings > Change PC Settings > Sharing** and set the **App to be used for sharing** option to **On**.

Printing a note

- 1 Slightly drag the note to be printed downward in the folder. The note is selected.
- 2 Select **AppBar > More > Print**.
Alternatively, select **Charm menu > Device** and select a printing device.

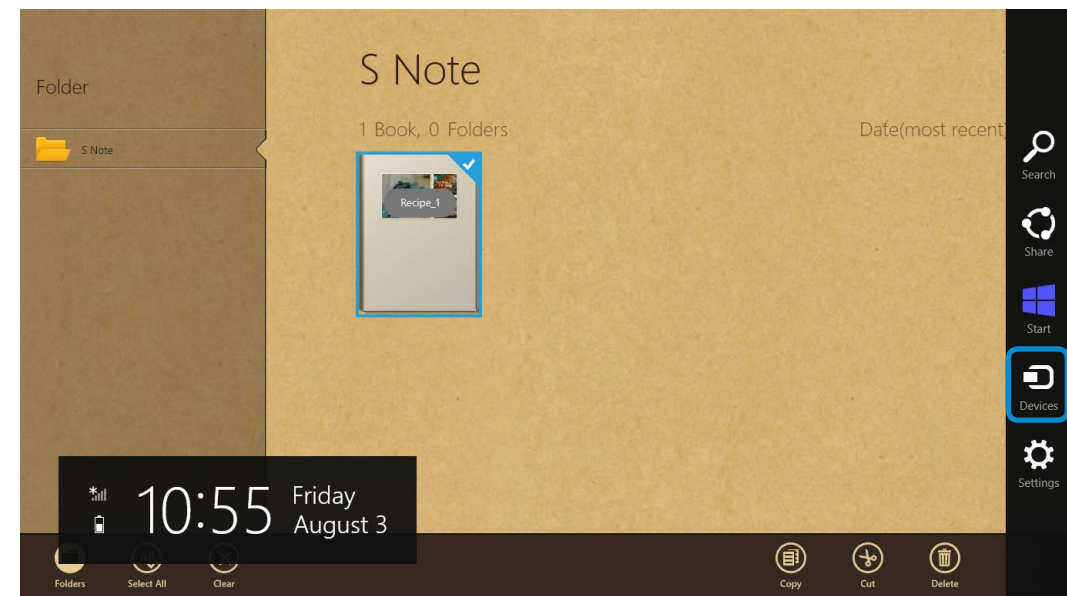

- 3 Print the note according to the instructions.

SW Update is a software program that searches for Samsung software programs and drivers installed when you purchased the computer and helps you update any drivers or programs.



- You can check updatable files before performing the update only when you are connected to the internet.
- SW Update does not provide any updates for device drivers or software programs installed separately by the user.

1 Right-click over the **Start screen**.
Click **SW Update** in the **All Apps**  menu item.

2 If the program is running for the first time, the User Agreement for personal information use appears.
Click **Agree**.

3 The **SW Update** program runs.

Select the items that you want to update before proceeding with the update process.

Software List
Software
Update

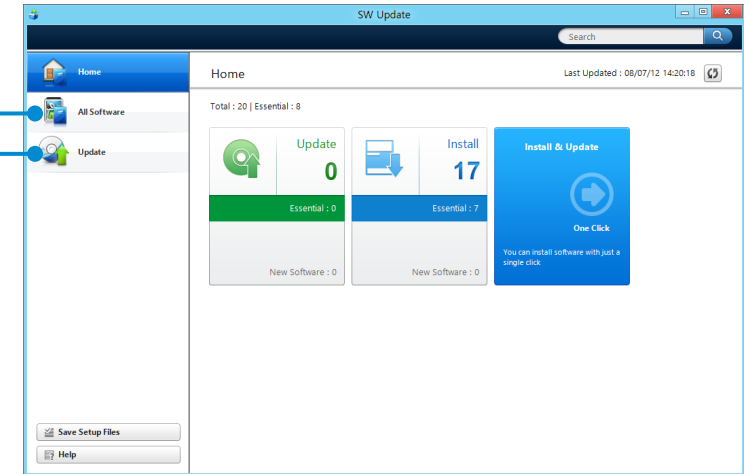

The Support Center program, which is Samsung's computer's troubleshooting guide, supports diagnosing the system and has a FAQ for frequently occurring problem(s).

 Support Center may not be provided or may be a different version depending on the model.

- 1 Right-click over the **Start screen**.
Click **Support Center** in the **All Apps**  menu item.

- 2 Support Center is activated and starts diagnosing your computer.

After the diagnosing process is finished, the System Status menu displays a list of the current problems to be solved as shown.

Diagnosing
Computer and
Troubleshooting
FAQ for
computer's
major problems

Searching for
computer's problems

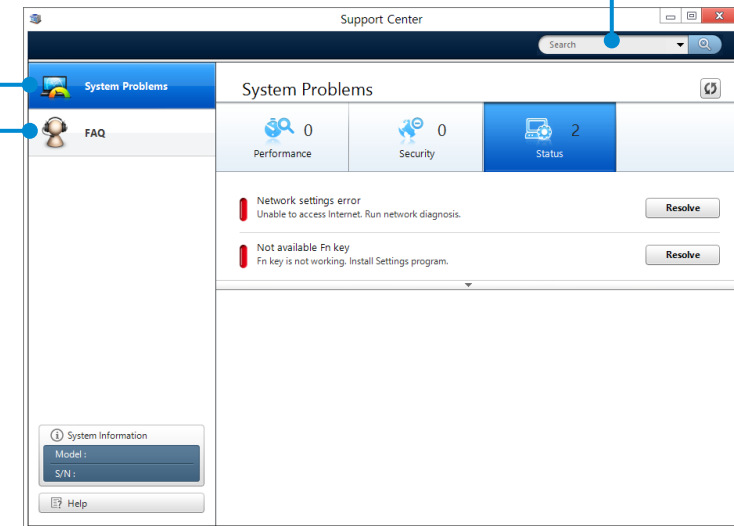

- 3 You can solve a problem by clicking the Troubleshoot button for the problem.

Please refer to the following instructions when running the computer on battery power without connecting the AC power.

This computer is equipped with an internal battery.

! Precautions

- **Users cannot remove or replace the internal battery.**
- **To remove or replace the battery, use an authorized service center in order to protect the product and users. You will be charged for this service.**
- Use only chargers specified in the User Manual.
- Never heat the battery pack, put it near or in a fire or use at a temperature higher than 60°C, as this may cause fire.
- Please refer to the system operation environment of this manual and operate and store the battery at room temperature.

 Before using the computer for the first time, make sure to connect the AC adapter and charge the battery completely.

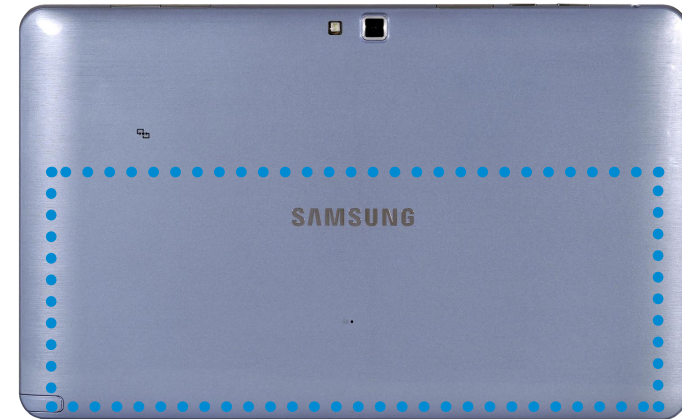

The location of the **internal battery**

Charging the Battery

Connect the AC adapter to the power input jack of the computer.
The battery will start charging.

Measuring the Remaining Battery Charge

You can view the battery charge status by completing the following procedures.

Confirming the battery charge in the Taskbar

Disconnect the AC adapter and move the mouse cursor over the battery icon in the system tray of the Taskbar to confirm the remaining battery charge.

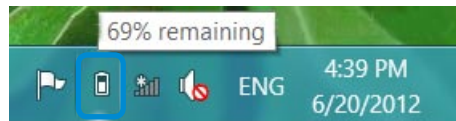



Battery Usage Time Information

A battery is an expendable supply, so when using it over a long time, the capacity/battery life is shortened. If the battery life is reduced to under half of its initial time, we recommend purchasing a new battery.

When not using the battery for a long time, store the battery after charging it to 30-40% of its capacity. This extends the battery life time.

Extending the Battery Usage Time

Decreasing the LCD Brightness

- 1 Click the **Charms menu** > **Settings**  > **Screen**  icon.
- 2 Dims the screen.

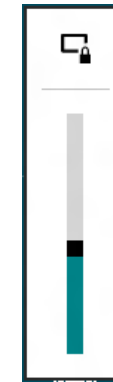

Using the power management program

This program helps you use the battery more efficiently and supports the power mode optimized for the operating environment.

- 1 Click **Charms menu** on the Desktop > **Settings**  > **Control Panel** > **Hardware and Sound** > **Power Options**.

Alternatively, right-click the power measuring device icon  in the notification area of the taskbar and select **Power Options**.

- 2 If the following screen appears, select one of the modes.

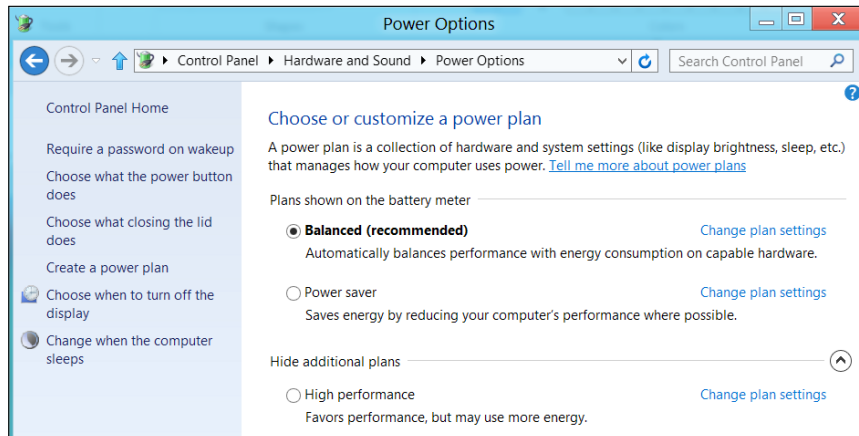

You can check the status of the system (CPU, memory, BIOS version, etc.) in Setup.



- Since incorrect settings may cause your system to malfunction or crash, take care when configuring the BIOS.
- The functions of the BIOS setup are subject to change for product function enhancement purposes.
- The BIOS Setup menus and items may differ depending on your computer model.

Entering the BIOS Setup

- 1 Shut the computer down.
- 2 Press the computer's **Power button**.
If the Samsung logo screen appears, press the **Home button** .
- 3 After a moment, the BIOS setup screen appears.
The items in the BIOS setup may differ depending on the product.

The BIOS Setup Screen

 The BIOS Setup menus and items may differ depending on your computer model.

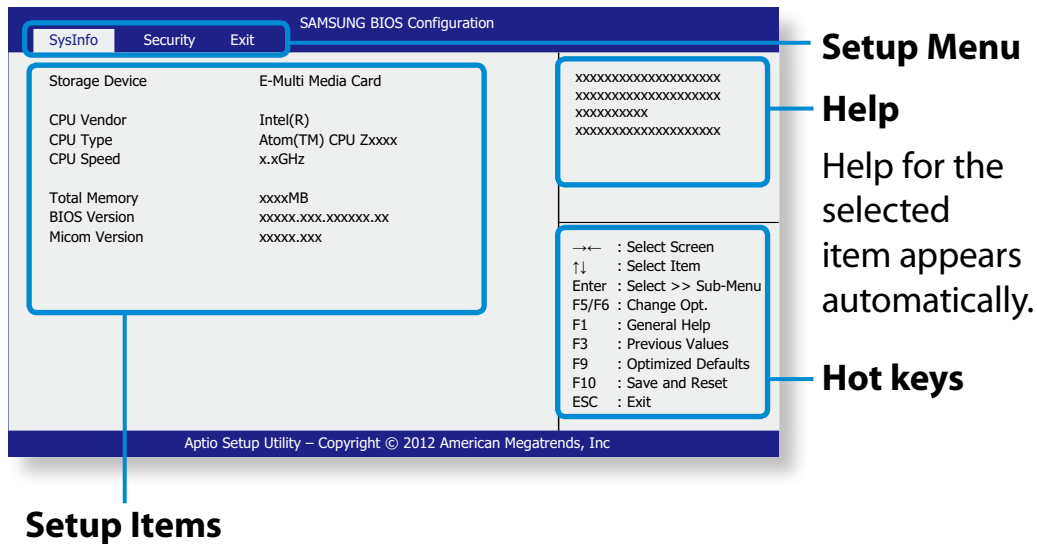

Setup Menu

Help
Help for the selected item appears automatically.

Hot keys

Setup Items

- Touch your screen to access and configure the Setup menu.
- You can perform the various functions by pressing the **hot keys** at the bottom right of your screen.
- To exit the Setup, select **ESC** on the screen.

Setup Menu	Description
SysInfo	This is a description about the basic specifications of the computer.
Security	Used to configure security functions.
Exit	Used to exit the Setup either saving the changes or not.



Chapter 4. Troubleshooting

Recovering the Computer (Optional)

83

Q&A

86



Recovering the Computer (Optional)

Recovery process from a failed boot

If your computer fails to boot up, the recovery process allows you to restore the computer to the default (factory) status.



- The menu on the screen may differ from the program's version.
- If the touch function on the screen does not work, connect an external mouse.



- The restore function of the computer may delete the data saved on the storage device (files and programs).
- Make sure to backup all your important data. Samsung Electronics shall not be held liable for any loss of data.

1 While pressing the **Volume Control (+) button** **1**, press the **Power button** **2**.

Keep pressing the **Volume Control (+) button** until the **Please Wait** message appears at the bottom of the screen.

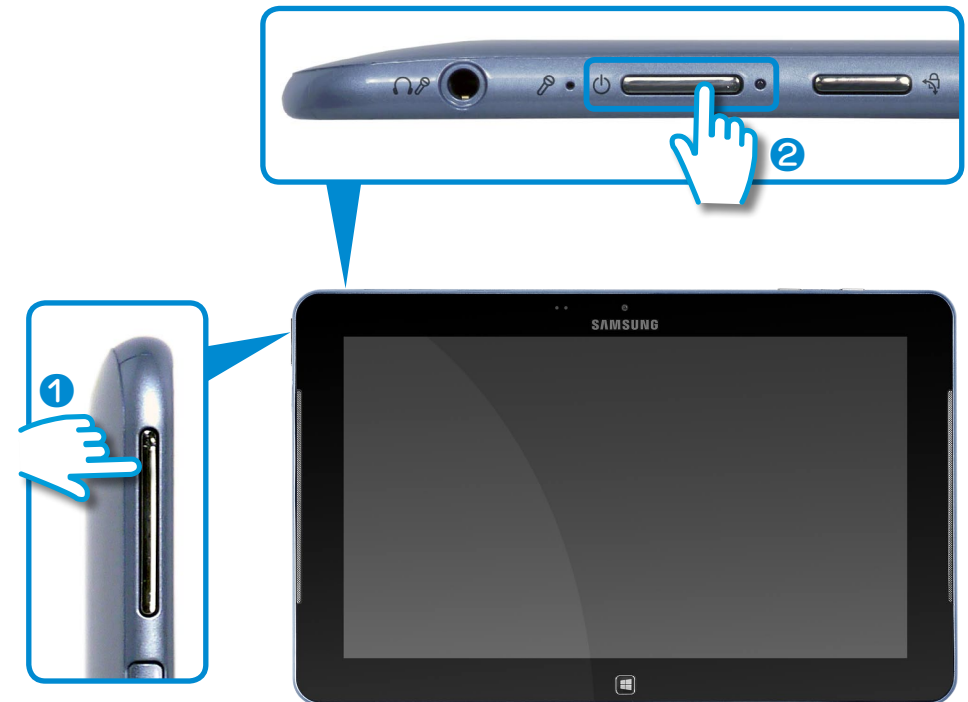

2 Recovery mode starts.

3 Select the input language of the keyboard if the language pop-up window appears.

Recovering the Computer (Optional)

4 Press **Troubleshoot > Refresh your PC** or **Reset your PC**. Follow the instructions on the screen.



Refresh your PC	This option restores your PC while keeping your media files such as photos, videos and music files, etc. as well as your personal documents.
Reset your PC	This option formats your PC and restores the Windows system.

 You should back up the files in the following folders before using the PC Recovery function since these files are not kept. \Windows, \Program files, \Program files(x86), \ProgramData, OEM Folder (ex) c:\samsung), \User\\AppData

► If you choose **Reset your PC**, select a format type and follow the instructions on the screen. Refer to the format type below:

Just remove my files	Format your PC quickly and restore the Windows system.
Fully clean the drive	Fully format your PC and restore the Windows system. This may take several hours.

5 If the recovery is completed successfully, you can use your computer normally.

-  You can restore required Samsung software programs through **All Apps**  **> SW Update**.
- Since only the minimum amount of restoration storage has been allocated to ensure computer operations, you have to additionally install any required applications after performing a restoration.

Recovering the Computer (Optional)

Computer Recovery Function in Windows 8

If a problem occurs with your computer, the recovery program allows you to restore your computer to the default settings.

1 Click the **Charms menu > Settings > Change PC Settings > General**.

2 Click the **Start** button for **Refresh....** or **Remove....**

Refresh....	If your PC does not work properly, you can restore your PC while keeping your media files such as your photo, video and music files, etc. as well as your personal documents.
Remove....	You can remove all items in your PC and reinstall Windows again.

 **You should back up the files in the following folders before using the PC Recovery function since these files are not kept.**

\Windows, \Program files, \Program files(x86), \ProgramData, OEM Folder (ex) c:\samsung), \User\<<user name>\AppData

3 Follow the onscreen instructions to proceed with the recovery process.

If the recovery is complete, you can use your computer normally.



- You can restore required Samsung software programs through **All Apps**  **> SW Update**.
- Since only the minimum amount of restoration storage has been allocated to ensure computer operations, you have to additionally install any required applications after performing a restoration.

You can look for potential problems that may occur with the system and view the relevant solutions. Also, you may look up any reference(s) required while operating the computer.

Windows 8 Related

Q1 I cannot find the Start button on the Desktop.

A There's no Start button in **Windows 8**.

You can use the Control Panel, PC-running menu(s), etc. by activating the **Charms menu**.

Q2 I cannot find the computer's Shutdown button.

A Click the **Charms menu > Settings > Power** to display the **Power Options** menu.

Click **Shutdown**.

Q3 The App disappeared in the Start screen.

A Click the **Charms menu > Search** to display all installed Apps. Right-click over the corresponding App to select in a Tile in the Start Screen.

Q4 Since I'm familiar with Windows 7, I would like the Desktop screen to appear as it does in Windows 7.

A Currently, there is no way to set the Desktop to appear by default.

Press the **Windows key + D key** simultaneously to reveal the Desktop when the Start screen appears. This is currently the only workaround.

Q5 How can I install a printer driver?

A Run your driver installation file and follow the corresponding instructions. You can install it in the same method as the existing OS.

Refer to your printer manual for detailed instructions for each model.

Q6 How can I uninstall the driver?

A On the Desktop, click **Charms menu > Settings > Control Panel > Programs and Features**.

Click the program. Then click **uninstall**.

Q7 How can I change the screen settings, environment settings, type size, color, and so on?

A Click **Charms menu > Settings > Change PC Settings > Personalization**. You can set the OS settings such as the screen design, etc.

To configure your computer in detail, click the **Charms menu** in **Desktop > Settings > Control Panel**.

You can configure your computer in the same way as existing Windows systems.

Q8 Active X does not run in Internet Explorer on the Start screen.

A Since Internet Explorer on the Start screen complies with the HTML5 web standards, it does not support Active X. However, Internet Explorer on the Desktop supports Active X.

► How to activate Active X:

If you right-click over the Internet Explorer, the following window appears. Press the  button and click **View on the Desktop**. Active X is now enabled.

Display Related

Q1 The Desktop displayed on the TV after connecting via the HDMI port does not fit the screen.

A Go to the Graphics Control Panel to adjust the screen settings.

► **For Intel graphics cards**

Right-click over the Desktop and go to **Graphics Properties > Display > General**. Adjust the **Horizontal Ratio** and **Vertical Ratio** settings to fit your screen and click **OK**.

► **For AMD graphics cards**

1. Right-click over the Desktop and select **Graphics Properties > Desktop and Display > My Digital Flat Panel > Expansion Options (Digital Flat Panel)**.
2. Adjust the control bar to fit the TV corners and click **Apply**.

Sound Related

Q1 I cannot hear any sound from the TV after connecting via the HDMI port.

- A**
1. Right-click over the taskbar on the Desktop and click **Play Device**.
 2. Change the option to Digital Audio (HDMI), HDMI device, HDMI Output or another option and click **Set as Default**. Then click **OK**.

Touch screen Related

Q1 The screen is abnormally displayed when the touch screen has been rotated.

A The screen rotation function may not work properly depending on the application.

To fix the screen orientation, press the **Rotation Lock**  button.

Q2 The letters on the computer screen overlap.

A If the font size is set to large, the letters on the screen may overlap.

In this case, select **Settings > Touch Tuning > DPI Settings** and set the text size to **Basic**.



Chapter 5. Appendix

Important Safety Information	91
Replacement Parts and Accessories	93
Regulatory Compliance Statements	95
WEEE Symbol Information	110
Samsung Packaging Take-Back Program	111
TCO Certified (for corresponding models only)	112
Product Specifications	113
Glossary	115
Index	119

Important Safety Information

Safety Instructions

Your system is designed and tested to meet the latest standards for safety of information technology equipment. However, to ensure safe use of this product, it is important that the safety instructions marked on the product and in the documentation are followed.



Always follow these instructions to help guard against personal injury and damage to your system.

Setting Up your System

- Read and follow all instructions marked on the product and in the documentation before you operate your system. Retain all safety and operating instructions for future use.
- Do not use this product near water or a heat source such as a radiator.
- Set up the system on a stable work surface.
- The product should be operated only with the type of power source indicated on the rating label.
- Ensure that the electrical outlet you are using to power your equipment is easily accessible in case of fire or short circuit.
- If your computer has a voltage selector switch, make sure that the switch is in the proper position for your area.
- Openings in the computer case are provided for ventilation. Do not block or cover these openings. Make sure you provide adequate space, at least 6 inches (15 cm), around the system for ventilation when you set up your work area. Never insert objects of any kind into the computer ventilation openings.
- Ensure that the fan vents on the bottom of the casing are clear at all times. Do not place the computer on a soft surface, doing so will block the bottom vents.
- If you use an extension cord with this system, make sure that the total power rating on the products plugged into the extension cord does not exceed the extension cord power rating.
- For Notebooks with glossy display bezels the user should consider the placement of the Notebook as the bezel may cause disturbing reflections from surrounding light and bright surfaces.

Care During Use

- Do not walk on the power cord or allow anything to rest on it.
- Do not spill anything on the system. The best way to avoid spills is to not eat or drink near your system.
- Some products have a replaceable CMOS battery on the system board. There is a danger of explosion if the CMOS battery is replaced incorrectly. Replace the battery with the same or equivalent type recommended by the manufacturer.

Dispose of batteries according to the manufacturers instructions. If the CMOS battery requires replacement insure that a qualified technician performs the task.

- When the computer is turned off, a small amount of electrical current still flows through the computer. To avoid electrical shock, always unplug all power cables, remove the battery and modem cables from the wall outlets before cleaning the system.
- Unplug the system from the wall outlet and refer servicing to qualified personnel if:
 - The power cord or plug is damaged.
 - Liquid has been spilled into the system.
 - The system does not operate properly when the operating instructions are followed.
 - The system was dropped or the casing is damaged.
 - The system performance changes.

The Instruction On Safety Operation of NotePC

1. When installing and operating devices please refer to safety requirements in the user guide.
2. Devices can be used only with the equipment specified in the technical specifications of the devices.
3. If any smell of burning or smoke is detected from the computer the unit should be switched off and battery removed. The unit should be checked by a qualified technician before reuse.
4. Service and repair of devices should be carried out by authorized service centers.
5. Do not allow your portable computer to operate with the base resting directly on exposed skin for extended periods of time. The surface temperature of the base will rise during normal operation (particularly when AC Power is present). Allowing sustained contact with exposed skin can cause discomfort or eventually a burn.

Use only replacement parts and accessories recommended by manufacturer.

 To reduce the risk of fire, use only No. 26 AWG or larger telecommunications line cord.

 Do not use this product in areas classified as hazardous. Such areas include patient care areas of medical and dental facilities, oxygen rich environments, or industrial areas.

Battery Disposal

 Do not put rechargeable batteries or products powered by non-removable rechargeable batteries in the garbage.

Contact the Samsung Helpline for information on how to dispose of batteries that you cannot use or recharge any longer.

Follow all local regulations when disposing of old batteries.

 THERE IS A RISK OF EXPLOSION IF BATTERY IS REPLACED BY AN INCORRECT TYPE.
DISPOSE OF USED BATTERIES ACCORDING TO THE INSTRUCTIONS.

Laser Safety

All systems equipped with CD or DVD drives comply with the appropriate safety standards, including IEC 60825-1. The laser devices in these components are classified as “Class 1 Laser Products” under a US Department of Health and Human Services (DHHS) Radiation Performance Standard. Should the unit ever need servicing, contact an authorized service location.

-  • **Laser Safety Note:**
Use of controls or adjustments or performance of procedures other than those specified in this manual may result in hazardous radiation exposure. To prevent exposure to laser beams, do not try to open the enclosure of a CD or DVD drive.
- Class 1M laser radiation when operating part is open.
Do not view directly with optical instruments.
- Class 3B invisible laser radiation when open.
Avoid exposure to the beam.

Connect and Disconnect the AC adapter

The socket-outlet shall be installed near the equipment and shall be easily accessible.

Do not unplug the power cord by pulling the cable only.

Power Cord Requirements

The power cord set (wall plug, cable and AC adapter plug) you received with your computer meets the requirements for use in the country where you purchased your equipment.

Power cord sets for use in other countries must meet the requirements of the country where you use the computer. For more information on power cord set requirements, contact your authorized dealer, reseller, or service provider.

General Requirements

The requirements listed below are applicable to all countries:

- All power cord sets must be approved by an acceptable accredited agency responsible for evaluation in the country where the power cord set will be used.
- The power cord set must have a minimum current capacity of 7 A and a nominal voltage rating of 125 or 250 volts AC, as required by each country's power system. (USA ONLY)
- The appliance coupler must meet the mechanical configuration of an EN 60 320/IEC 320 Standard Sheet C7 (or C5) connector, for mating with appliance inlet on the computer.

Wireless Guidance

(If fitted with 2.4G band or 5G band)

Low power, Radio LAN type devices (radio frequency (RF) wireless communication devices), operating in the 2.4GHz/5GHz Band, may be present (embedded) in your notebook system. The following section is a general overview of considerations while operating a wireless device.

Additional limitations, cautions, and concerns for specific countries are listed in the specific country sections (or country group sections). The wireless devices in your system are only qualified for use in the countries identified by the Radio Approval Marks on the system rating label. If the country you will be using the wireless device in, is not listed, please contact your local Radio Approval agency for requirements. Wireless devices are closely regulated and use may not be allowed.

The RF field strength of the wireless device or devices that may be embedded in your notebook are well below all international RF exposure limits as known at this time. Because the wireless devices (which may be embedded into your notebook) emit less energy than is allowed in radio frequency safety standards and recommendations, manufacturer believes these devices are safe using. Regardless of the power levels, care should be taken to minimize human contact during normal operation.

Some circumstances require restrictions on wireless devices. Examples of common restrictions are listed on the next page:



- Radio frequency wireless communication can interfere with equipment on commercial aircraft. Current aviation regulations require wireless devices to be turned off while traveling in an airplane. 802.11ABGN (also known as wireless Ethernet or Wifi) and Bluetooth communication devices are examples of devices that provide wireless communication.
- In environments where the risk of interference to other devices or services is harmful or perceived as harmful, the option to use a wireless device may be restricted or eliminated. Airports, Hospitals, and Oxygen or flammable gas laden atmospheres are limited examples where use of wireless devices may be restricted or eliminated. When in environments where you are uncertain of the sanction to use wireless devices, ask the applicable authority for authorization prior to use or turning on the wireless device.
- Every country has different restrictions on the use of wireless devices. Since your system is equipped with a wireless device, when traveling between countries with your system, check with the local Radio Approval authorities prior to any move or trip for any restrictions on the use of a wireless device in the destination country.
- If your system came equipped with an internal embedded wireless device, do not operate the wireless device unless all covers and shields are in place and the system is fully assembled.

-  Wireless devices are not user serviceable. Do not modify them in any way. Modification to a wireless device will void the authorization to use it. Please contact manufacturer for service.
- Only use drivers approved for the country in which the device will be used. See the manufacturer System Restoration Kit, or contact manufacturer Technical Support for additional information.

United States of America

USA and Canada Safety Requirements and Notices

Do not touch or move antenna while the unit is transmitting or receiving.

Do not hold any component containing the radio such that the antenna is very close or touching any exposed parts of the body, especially the face or eyes, while transmitting.

Do not operate the radio or attempt to transmit data unless the antenna is connected; if not, the radio may be damaged.

Use in specific environments:

The use of wireless devices in hazardous locations is limited by the constraints posed by the safety directors of such environments.

The use of wireless devices on airplanes is governed by the Federal Aviation Administration (FAA).

The use of wireless devices in hospitals is restricted to the limits set forth by each hospital.

Explosive Device Proximity Warning

Do not operate a portable transmitter (such as a wireless network device) near unshielded blasting caps or in an explosive environment unless the device has been modified to be qualified for such use.

Use On Aircraft Caution

Regulations of the FCC and FAA prohibit airborne operation of radio-frequency wireless devices because their signals could interfere with critical aircraft instruments.

Other Wireless Devices

Safety Notices for Other Devices in the Wireless Network:

Refer to the documentation supplied with wireless Ethernet adapters or other devices in the wireless network.

 The Part 15 radio device operates on a non-interference basis with other devices operating at this frequency. Any changes or modification to said product not expressly approved by Intel could void the user's authority to operate this device.

Unintentional Emitter per FCC Part 15

This device complies with Part 15 of the FCC Rules. Operation is subject to the following two conditions:(1) this device may not cause harmful interference, and (2) this device must accept any interference received, including interference that may cause undesired operation.

 This equipment has been tested and found to comply with the limits for a Class B digital device pursuant to Part 15 of the FCC Rules. These limits are designed to provide reasonable protection against harmful interference in a residential installation. This equipment generates, uses, and can radiate radio frequency energy. If not installed and used in accordance with the instructions, it may cause harmful interference. If this equipment does cause harmful interference to radio or television reception, which can be determined by turning the equipment off and on, the user is encouraged to try to correct the interference by one or more of the following measures:

- Reorient or relocate the receiving antenna.
- Increase the separation between the equipment and receiver.
- Connect the equipment into an outlet on a circuit different from that to which the receiver is connected.
- Consult the dealer or an experienced radio/TV technician for help.

If necessary, the user should consult the dealer or an experienced radio/television technician for additional suggestions. The user may find the following booklet helpful: "Something About Interference."

This is available at FCC local regional offices. Our company is not responsible for any radio or television interference caused by unauthorized modifications of this equipment or the substitution or attachment of connecting cables and equipment other than those specified by our company. The correction will be the responsibility of the user. Use only shielded data cables with this system.

Intentional emitter per FCC Part 15

(If fitted with 2.4G band or 5G band)

Low power, Radio LAN type devices (radio frequency (RF) wireless communication devices), operating in the 2.4GHz/5GHz Band, may be present (embedded) in your notebook system. This section is only applicable if these devices are present. Refer to the system label to verify the presence of wireless devices.

Wireless devices that may be in your system are only qualified for use in the United States of America if an FCC ID number is on the system label.

This device is restricted to indoor use due to its operation in the 5.15 to 5.25 GHz frequency range. FCC requires this product to be used indoors for the frequency range 5.15 to 5.25 GHz to reduce the potential for harmful interference to co-channel Mobile Satellite systems. High power radars are allocated as primary users of the 5.25 to 5.35 GHz and 5.65 to 5.85 GHz bands. These radar stations can cause interference with and /or damage this device.

Operation of this device is subject to the following two conditions: (1) This device may not cause harmful interference, and (2) this device must accept any interference received, including interference that may cause undesired operation of the device.



Wireless devices are not user serviceable. Do not modify them in any way.

Modification to a wireless device will void the authorization to use it. Contact manufacturer for service.

Health and safety information

Exposure to Radio Frequency (RF) Signals Certification Information (SAR)

This product can contain an embedded radio transmitter and receiver. It is designed and manufactured not to exceed the exposure limits for radio frequency (RF) energy set by the Federal Communications Commission (FCC) of the U.S. government. These FCC exposure limits are derived from the recommendations of two expert organizations, the National Council on Radiation Protection and Measurement (NCRP) and the Institute of Electrical and Electronics Engineers (IEEE). In both cases, the recommendations were developed by scientific and engineering experts drawn from industry, government, and academia after extensive reviews of the scientific literature related to the biological effects of RF energy.

The exposure limit set by the FCC for wireless devices employs a unit of measurement known as the Specific Absorption Rate (SAR). The SAR is a measure of the rate of absorption of RF energy by the human body expressed in units of watts per kilogram (W/kg). The FCC requires wireless devices to comply with a safety limit of 1.6 watts per kilogram (1.6 W/kg). The FCC exposure limit incorporates a substantial margin of safety to give additional protection to the public and to account for any variations in measurements.

SAR tests are conducted using standard operating positions accepted by the FCC with the wireless transmitting at its highest certified power level in all tested frequency bands. Although the SAR is determined at the highest certified power level, the actual

SAR level of the device while operating can be well below the maximum value. This is because the device is designed to operate at multiple power levels so as to use only the power required to reach the network. In general, the closer you are to a wireless base station antenna, the lower the power output.

Before a new model is available for sale to the public, it must be tested and certified to the FCC that it does not exceed the exposure limit established by the FCC. Tests for each model are performed in positions and locations (e.g. at the bottom on the body) as required by the FCC.

For body worn operation, this model has been tested and meets the FCC RF exposure guidelines when used with Samsung accessory designated for this product. Non-compliance with the above restrictions may result in violation of FCC RF exposure guidelines.

SAR information on this and other model can be viewed on-line at <http://www.fcc.gov/oet/ea/fccid/>. This site uses this product FCC ID number on the outside of the product. Sometimes it may be necessary to remove the battery pack to find the number. Once you have the FCC ID number for a particular product, follow the instructions on the website and it should provide values for typical or maximum SAR for a particular product.

Canada

Unintentional Emitter per ICES-003

This digital apparatus does not exceed the Class B limits for radio noise emissions from digital apparatus as set out in the radio interference regulations of Industry Canada.

Le présent appareil numérique n'émet pas de bruits radioélectriques dépassant les limites applicables aux appareils numériques de Classe B prescrites dans le règlement sur le brouillage radioélectrique édicté par Industrie Canada.

Intentional Emitter per RSS 210

This device complies with RSS 210 of Industry Canada. Operation is subject to the following two conditions: (1) this device may not cause interference, and (2) this device must accept any interference, including interference that may cause undesired operation of this device."

L' utilisation de ce dispositif est autorisée seulement aux conditions suivantes : (1) il ne doit pas produire de brouillage et (2) l' utilisateur du dispositif doit être prêt à accepter tout brouillage radioélectrique reçu, même si ce brouillage est susceptible de compromettre le fonctionnement du dispositif.

The term "IC" before the equipment certification number only signifies that the Industry Canada technical specifications were met. To reduce potential radio interference to other users, the antenna type and its gain should be so chosen that the equivalent isotropically radiated power (EIRP) is not more than that required for successful communication. To prevent radio interference to the licensed service, this device is intended to be operated indoors and away from windows to provide maximum shielding. Equipment (or its transmit antenna) that is installed outdoors is subject to licensing.

Pour empêcher que cet appareil cause du brouillage au service faisant l'objet d'une licence, il doit être utilisé à l'intérieur et devrait être placé loin des fenêtres afin de fournir un écran de blindage maximal. Si le matériel (ou son antenne d'émission) est installé à l'extérieur, il doit faire l'objet d'une licence.

(If fitted with 2.4G band or 5G band)

Low power, Radio LAN type devices (radio frequency (RF) wireless communication devices), operating in the 2.4GHz/5GHz Band, may be present (embedded) in your notebook system. This section is only applicable if these devices are present. Refer to the system label to verify the presence of wireless devices.

Wireless devices that may be in your system are only qualified for use in Canada if an Industry Canada ID number is on the system label.

When using IEEE 802.11a wireless LAN, this product is restricted to indoor use due to its operation in the 5.15- to 5.25-GHz frequency

range. Industry Canada requires this product to be used indoors for the frequency range of 5.15 GHz to 5.25 GHz to reduce the potential for harmful interference to co-channel mobile satellite systems. High power radar is allocated as the primary user of the 5.25- to 5.35-GHz and 5.65 to 5.85-GHz bands. These radar stations can cause interference with and/or damage to this device.

The maximum allowed antenna gain for use with this device is 6dBi in order to comply with the E.I.R.P limit for the 5.25- to 5.35 and 5.725 to 5.85 GHz frequency range in point-to-point operation.

The power output of the wireless device (or devices), which may be embedded in your notebook, is well below the RF exposure limits as set by Industry Canada.

Operation of this device is subject to the following two conditions:

(1) This device may not cause harmful interference, and (2) this device must accept any interference received, including interference that may cause undesired operation of the device.

 To prevent radio interference to licensed service, this device is intended to be operated indoors and away from windows to provide maximum shielding. Equipment (or its transmit antenna) that is installed outdoors is subject to licensing.

 Wireless devices are not user serviceable. Do not modify them in any way. Modification to a wireless device will void the authorization to use it. Contact manufacturer for service.

(Si l'appareil est équipé d'une bande 2,4 G ou 5 G)

Des dispositifs de basse puissance, de type radio LAN (périphériques de communication sans fil par radiofréquence RF) fonctionnant sur une bande de 2.4GHz/5GHz sont peut-être intégrés dans votre appareil. Cette section est applicable uniquement si ces dispositifs sont présents. Consultez l'étiquette du système pour vérifiez la présence de dispositifs sans fil.

Les dispositifs sans fil qui peuvent être intégrés dans votre système sont uniquement aptes pour une utilisation au Canada si l'étiquette du système présente un nombre d'identification d'Industrie Canada.

En cas d'utilisation d'un LAN sans fil IEEE 802.11a, ce produit ne peut être utilisé qu'à l'intérieur en raison de son fonctionnement dans une plage des fréquences allant de 5,15 à 5,25 GHz. Industrie Canada exige l'utilisation de ce produit à l'intérieur pour une plage des fréquences allant de 5,15 à 5,25 GHz afin de réduire les éventuelles interférences nuisibles avec les systèmes mobiles par satellite du même canal. Le radar de grande puissance est considéré comme l'utilisateur principal des bandes de 5,25 à 5,35 GHz et de 5,65 à 5,85 GHz. Ces stations radar peuvent provoquer des interférences avec ce périphérique et/ou l'endommager.

Le gain d'antenne maximum autorisé avec ce périphérique est de 6 dBi afin de respecter la limite de P.I.R.E. pour une plage des fréquences de 5,25 à 5,35 GHz et de 5,725 à 5,85 GHz dans un fonctionnement point à point.

La sortie de puissance du dispositif sans fil (ou des dispositifs) qui peut être intégré dans votre système est bien inférieure aux limites d'exposition de RF établies par Industrie Canada.

Son utilisation est soumise aux deux conditions suivantes : 1) ce dispositif ne peut pas provoquer d'interférences nuisibles et 2) ce dispositif doit accepter toute interférence reçue, y compris les interférences qui peuvent provoquer des anomalies dans le système.

 Afin de prévenir des interférences de radio au service autorisé, ce dispositif est prévu pour être utilisé à l'intérieur et éloigné des fenêtres pour fournir une protection maximum. Un équipement (ou son antenne de transmission) qui est installé à l'extérieur est sujet à une autorisation.

 Les dispositifs sans fil ne peuvent pas être réparés par l'utilisateur. Ne les modifiez en aucune façon. La modification d'un dispositif sans fil annulera votre autorisation à son utilisation. Contactez le fabricant pour la réparation.

Brazil

Este produto esta homologado pela ANATEL, de acordo com os procedimentos regulamentados pela Resolucao 242/2000, e atende aos requisitos tecnicos aplicados.

Este equipamento opera em caráter secundário, isto é, não tem direito a proteção contra interferência prejudicial, mesmo de estações do mesmo tipo, e não pode causar interferência a sistemas operando em caráter primário.

European Union

European Union CE Marking and Compliance Notices

Products intended for sale within the European Union are marked with the Conformité Européene (CE) Marking, which indicates compliance with the applicable Directives and European standards and amendments identified below. This equipment also carries the Class 2 identifier.

The following information is only applicable to systems labeled with the CE mark .

European Directives

This Information Technology Equipment has been tested and found to comply with the following European directives:

- EMC Directive 2004/108/EC
- Low Voltage Directive 2006/95/EC
- R&TTE Directive 1999/5/EC

European Radio Approval Information (for products fitted with EU-approved radio devices)

This Product is a Notebook computer; low power, Radio LAN type devices (radio frequency (RF) wireless communication devices), operating in the 2.4GHz/5GHz band, may be present (embedded) in your notebook system which is intended for home or office use. This section is only applicable if these devices are present. Refer to the system label to verify the presence of wireless devices.



Wireless devices that may be in your system are only qualified for use in the European Union or associated areas if a CE mark  with a Notified Body Registration Number and the Alert Symbol is on the system label.







The power output of the wireless device or devices that may be embedded in you notebook is well below the RF exposure limits as set by the European Commission through the R&TTE directive.







The low band 5.15 - 5.35 GHz is for indoor use only.









See 802.11b and 802.11g restrictions for specific countries or regions within countries under the heading “European Economic Area Restrictions” below.

EU R&TTE Compliance Statements

 Česky [Czech]	Samsung tímto prohlašuje, že tento Notebook PC je ve shodě se základními požadavky a dalšími příslušnými ustanoveními směrnice 1999/5/ES.
 Dansk [Danish]	Undertegnede Samsung erklærer herved, at følgende udstyr Notebook PC overholder de væsentlige krav og øvrige relevante krav i direktiv 1999/5/EF.
 Deutsch [German]	Hiermit erklärt Samsung, dass sich das Gerät Notebook PC in Übereinstimmung mit den grundlegenden Anforderungen und den übrigen einschlägigen Bestimmungen der Richtlinie 1999/5/EG befindet.
 Eesti [Estonian]	Käesolevaga kinnitab Samsung seadme Notebook PC vastavust direktiivi 1999/5/EÜ põhinõuetele ja nimetatud direktiivist tulenevatele teistele asjakohastele sätetele.
 English	Hereby, Samsung, declares that this Notebook PC is in compliance with the essential requirements and other relevant provisions of Directive 1999/5/EC.
 Español [Spanish]	Por medio de la presente Samsung declara que el Notebook PC cumple con los requisitos esenciales y cualesquiera otras disposiciones aplicables o exigibles de la Directiva 1999/5/CE.

 Ελληνική [Greek]	ΜΕ ΤΗΝ ΠΑΡΟΥΣΑ Samsung ΔΗΛΩΝΕΙ ΟΤΙ Notebook PC ΣΥΜΜΟΡΦΩΝΕΤΑΙ ΠΡΟΣ ΤΙΣ ΟΥΣΙΩΔΕΙΣ ΑΠΑΙΤΗΣΕΙΣ ΚΑΙ ΤΙΣ ΛΟΙΠΕΣ ΣΧΕΤΙΚΕΣ ΔΙΑΤΑΞΕΙΣ ΤΗΣ ΟΔΗΓΙΑΣ 1999/5/ΕΚ.
 Français [French]	Par la présente Samsung déclare que l'appareil Notebook PC est conforme aux exigences essentielles et aux autres dispositions pertinentes de la directive 1999/5/CE.
 Italiano [Italian]	Con la presente Samsung dichiara che questo Notebook PC è conforme ai requisiti essenziali ed alle altre disposizioni pertinenti stabilite dalla direttiva 1999/5/CE.
 Latviski [Latvian]	Ar šo Samsung deklarē, ka Notebook PC atbilst Direktīvas 1999/5/EK būtiskajām prasībām un citiem ar to saistītajiem noteikumiem.
 Lietuvių [Lithuanian]	Šiuo Samsung deklaruoja, kad šis Notebook PC atitinka esminius reikalavimus ir kitas 1999/5/EB Direktyvos nuostatas.
 Nederlands [Dutch]	Hierbij verklaart Samsung dat het toestel Notebook PC in overeenstemming is met de essentiële eisen en de andere relevante bepalingen van richtlijn 1999/5/EG.
 Malti [Maltese]	Hawnhekk, Samsung, jiddikjara li dan Notebook PC jikkonforma mal-ħtiājiet essenzjali u ma provvedimenti oħrajn rilevanti li hemm fid-Dirrettiva 1999/5/EC.

	Magyar [Hungarian]	Alulírott, Samsung nyilatkozom, hogy a Notebook PC megfelel a vonatkozó alapvető követelményeknek és az 1999/5/EC irányelv egyéb előírásainak.
	Polski [Polish]	Niniejszym Samsung oświadcza, że Notebook PC jest zgodny z zasadniczymi wymogami oraz pozostałymi stosownymi postanowieniami Dyrektywy 1999/5/EC.
	Português [Portuguese]	Samsung declara que este Notebook PC está conforme com os requisitos essenciais e outras disposições da Directiva 1999/5/CE.
	Slovensko [Slovenian]	Samsung izjavlja, da je ta Notebook PC v skladu z bistvenimi zahtevami in ostalimi relevantnimi določili direktive 1999/5/ES.
	Slovensky [Slovak]	Samsung týmto vyhlasuje, že Notebook PC spĺňa základné požiadavky a všetky príslušné ustanovenia Smernice 1999/5/ES.
	Suomi [Finnish]	Samsung vakuuttaa täten että Notebook PC tyyppinen laite on direktiivin 1999/5/EY oleellisten vaatimusten ja sitä koskevien direktiivin muiden ehtojen mukainen.
	Svenska [Swedish]	Härmed intygar Samsung att denna Notebook PC står i överensstämmelse med de väsentliga egenskapskrav och övriga relevanta bestämmelser som framgår av direktiv 1999/5/EG.

	Íslenska [Icelandic]	Hér með lýsir Samsung yfir því að Notebook PC er í samræmi við grunnkröfur og aðrar kröfur, sem gerðar eru í tilskipun 1999/5/EC.
	Norsk [Norwegian]	Samsung erklærer herved at utstyret Notebook PC er i samsvar med de grunnleggende krav og øvrige relevante krav i direktiv 1999/5/EF.
	Türkiye [Türkçe]	Bu belge ile, Samsung bu Notebook PC'nin 1999/5/EC Yönetmeliğinin temel gerekliliklerine ve ilgili hükümlerine uygun olduğunu beyan eder.

To view the EU Declaration of Conformity for this product (in English only), go to: <http://www.samsung.com/uk/support/main/supportMain.do> or <http://www.samsung.com/uk/support> then search the model number of the product.

If the Declaration of Conformity for the model you are interested in is not available on our web-site, please contact your distributor or below address.

doc.eu@samsung.com

Manufacturer Information

Samsung Electronics Co., Ltd.

416, Maetan-3Dong, Yeongtong-Gu, Suwon-City, Gyeonggi-Do, 443-742, Korea

Samsung Electronics Suzhou Computer Co., Ltd.

No. 198, Fangzhou Road, Suzhou Industrial Park, Jiangsu Province, 215021, China

Tel: +86-512-6253-8988

For the web or the phone number of Samsung Service Centre, see the Warranty or contact the retailer where you purchased your product.

European Economic Area Restrictions

Local Restriction of 802.11b/802.11g Radio Usage

[Note to integrator: The following statements on local restrictions must be published in all end-user documentation provided with the system or product incorporating the wireless product.]



Due to the fact that the frequencies used by 802.11b/802.11g wireless LAN devices may not yet be harmonized in all countries, 802.11b/802.11g products are designed for use only in specific countries or regions, and are not allowed to be operated in countries or regions other than those of designated use.

As a user of these products, you are responsible for ensuring that the products are used only in the countries or regions for which they were intended and for verifying that they are configured with the correct selection of frequency and channel for the country or region of use. Any deviation from permissible settings and restrictions in the country or region of use could be an infringement of local law and may be punished as such.

The European variant is intended for use throughout the European Economic Area. However, authorization for use is further restricted in particular countries or regions within countries, as follows:

General

European standards dictate maximum radiated transmit power of 100 mW effective isotropic radiated power (EIRP) and the frequency range 2400 – 2483.5 MHz.

The low band 5.15 - 5.35 GHz is for indoor use only.

Belgium

The product may be used outdoors, but for outdoor transmissions over a distance of 300m or more, a license from the BIPT is required.

This restriction should be indicated in the manual as follows:

Dans le cas d'une utilisation privée, à l'extérieur d'un bâtiment, au-dessus d'un espace public, aucun enregistrement n'est nécessaire pour une distance de moins de 300m. Pour une distance supérieure à 300m un enregistrement auprès de l'IBPT est requise. Pour une utilisation publique à l'extérieur de bâtiments, une licence de l'IBPT est requise. Pour les enregistrements et licences, veuillez contacter l'IBPT.

France

The low band 5.15 - 5.35 GHz is for indoor use only.

RTC CAUTION

CAUTION : Danger of explosion if battery is incorrectly replaced. Replace only with the same or equivalent type recommended by the manufacturer. Discard used batteries according to the Manufacturer's instruction.

Attention: Danger d'explosion si les piles sont mal placées. Remplacez les piles usagées uniquement par des piles de type identique ou équivalent recommandées par le fabricant. Otez les piles usagées selon les instructions du fabricant.

Adapter Information

Vendor	CHICONY
Company Name	CHICONY POWER TECHNOLOGY CO.,LTD
Adapter Model Name	A12-040N1A

RF Exposure (for corresponding 3G models only)

General Statement on RF energy

Your wireless WAN embedded PC contains a transmitter and a receiver. When it is ON, it receives and transmits RF energy. When you communicate with your Notebook PC, the system handling your connection controls the power level at which your Notebook PC transmits.

Specific Absorption Rate (SAR) certification information

This wireless WAN embedded PC is included a radio transmitter and receiver. It is designed not to exceed the limits for exposure to radio waves recommended by international guidelines. These guidelines were developed by the independent scientific organization ICNIRP and include safety margins designed to assure the protection of all persons, regardless of age and health.

The guidelines use a unit of measurement known as the Specific Absorption Rate, or SAR. The SAR limit for mobile devices is 2.0 W/kg and the highest SAR value for this device when tested at the body was 0.565 W/kg. (SAR measurement distance is 0 cm from the phantom)

As SAR is measured utilizing the devices highest transmitting power the actual SAR of this device while operating is typically below that indicated above. This is due to automatic changes to the power level of the device to ensure it only uses the minimum

level required to reach the network.

The World Health Organization has stated that present scientific information does not indicate the need for any special precautions for the use of mobile devices. They note that if you want to reduce your exposure then you can do so by limiting the length of calls to keep the mobile devices away from the head and body.

Limiting exposure to radio frequency (RF) fields

For individuals concerned about limiting their exposure to RF fields, the World Health Organisation (WHO) provides the following advice:

Precautionary measures: Present scientific information does not indicate the need for any special precautions for the use of the Notebook PC. If individuals are concerned, they might choose to limit their own or their children's RF exposure by limiting the length of connections.

Further information on this subject can be obtained from the WHO home page <http://www.who.int/peh-emf>

WHO Fact sheet 193: June 2000.

Declaration of Conformity (for corresponding 3G models only)

Product details

For the following

Product : Notebook PC (Tablet PC)

Model(s) : XE500T1C

Declaration & Applicable standards

We hereby declare, that the product above is in compliance with the essential requirements of the R&TTE Directive (1999/5/EC) by application of the standards below.

This product also meets the essential requirements and other relevant provisions of the EMC Directive (2004/108/EC) and the LVD Directive (2006/95/EC).

EN 60950-1:2006+A11:2009/A1:2010/A12:2011 EN 62311 : 2008

EN 55022:2006+A1:2007 EN 55024:1998+A1:2001+A2:2003

EN 61000-3-2:2006+A2:2009 EN 61000-3-3:2008

EN 301 489-01 V1.9.2 (09-2011) EN 301 489-03 V1.4.1 (2002)

EN 301 489-07 V1.3.1 (11-2005) EN 301 489-17 V2.1.1 (05-2009)

EN 301 489-24 V1.5.1 (10-2010) EN 300 328 V1.7.1 (10-2006)

EN 300 440-1 V1.6.1 (08-2010) EN 301 893 V1.6.1 (11-2011)

EN 300 440-2 V1.4.1 (08-2010)

EN 301 511 V9.0.2 (03-2003)

EN 302 291-1 V1.1.1

EN 301 908-1 V5.2.1 (05-2011)

EN 302 291-2 V1.1.1

EN 301 908-2 V5.2.1 (07-2011)

and the Eco-Design Directive (2009/125/EC) implemented by Regulations (EC) No 1275/2008 for standby and off mode electric power consumption and (EC) No 278/2009 for external power supplies and the Directive (2011/65/EU) on the restriction of the use of certain hazardous substances in electrical and electronic equipment.



Representative in the EU

(YEAR TO BEGIN AFFIXING CE MARKING 2012)

Samsung Electronics Euro QA Lab.
Blackbushe Business Park
Saxony Way, Yateley, Hampshire
GU46 6GG, UK

02 October 2012

Joong-Hoon Choi/Lab. Manager

(Place and date of issue)

(Name and signature of authorized person)



Correct disposal of this product (Waste Electrical & Electronic Equipment)

(Applicable in countries with separate collection systems)

This marking on the product, accessories or literature indicates that the product and its electronic accessories (e.g. charger, headset, USB cable) should not be disposed of with other household waste at the end of their working life.

To prevent possible harm to the environment or human health from uncontrolled waste disposal, please separate these items from other types of waste and recycle them responsibly to promote the sustainable reuse of material resources.

Household users should contact either the retailer where they purchased this product, or their local government office, for details of where and how they can take these items for environmentally safe recycling.

Business users should contact their supplier and check the terms and conditions of the purchase contract. This product and its electronic accessories should not be mixed with other commercial wastes for disposal.

India Only

For more information on safe disposal and recycling visit our website www.samsung.com/in or contact our Helpline numbers - 18002668282, 180030008282.



Correct disposal of batteries in this product

(Applicable in countries with separate collection systems)

This marking on the battery, manual or packaging indicates that the batteries in this product should not be disposed of with other household waste at the end of their working life. Where marked, the chemical symbols Hg, Cd or Pb indicate that the battery contains mercury, cadmium or lead above the reference levels in EC Directive 2006/66. If batteries are not properly disposed of, these substances can cause harm to human health or the environment.

To protect natural resources and to promote material re-use, please separate batteries from other types of waste and recycle them through your local, free battery return system.

USA ONLY



This Perchlorate warning applies only to primary CR (Manganese Dioxide) Lithium coin cells in the product sold or distributed ONLY in California USA.

“Perchlorate Material- special handling may apply, See www.dtsc.ca.gov/hazardouswaste/perchlorate.”

Dispose unwanted electronics through an approved recycler.

To find the nearest recycling location, go to our website: www.samsung.com/recyclingdirect Or call, (877) 278-0799

For battery recycling go to call2recycle.org; or call 1-877-723-1297

Samsung Packaging Take-Back Program

In partnering with select recyclers, Samsung offers packaging take-back at no cost to you.

Simply call the following number for the locations nearest you.

CRT Processing, LLC

(877) 278-0799

Kathy Severson – Logistics contact

Dispose unwanted electronics through an approved recycler.

To find the nearest recycling location, go to our website:

www.samsung.com/recyclingdirect Or call, (877) 278-0799

Congratulations!

This product is designed for both you and the planet!



The product you have just purchased carries the TCO Certified label. This ensures it is designed, manufactured and tested according to some of the strictest quality and environmental

requirements in the world. This makes for a high performance product, designed with the user in focus that also minimizes the impact on the climate and our natural environment.

TCO Certified is a third party verified program, where every product model is tested by an accredited impartial test laboratory. TCO Certified represents one of the toughest certifications for ICT products worldwide.

Some of the Usability features of TCO Certified Tablets

- Visual Ergonomics for image quality is tested to ensure top performance and reduce sight and strain problems. Important parameters are Resolution, Luminance, Contrast, Reflection and Colour characteristics
- Products are tested according to rigorous safety standards at impartial laboratories
- Electric and Magnetic field emissions as low as normal household background levels
- Workload ergonomics to ensure a good physical environment

Some of the Environmental features of TCO Certified Tablets

- Production facilities have an Environmental Management System (EMAS or ISO 14001)
- Low energy consumption to minimize climate impact
- Mercury free
- Restrictions on Chlorinated and Brominated flame retardants, plasticizers, plastics and heavy metals such as cadmium and lead (RoHS compliance)
- Both product and product packaging is prepared for recycling
- The brand owner offers take-back options

Corporate Social Responsibility

The brand owner demonstrates the product is manufactured under working practices that promote good labour relations and working conditions.

The Criteria Document can be downloaded from our web site. The criteria included in this label have been developed by TCO Development in co-operation with scientists, experts, users as well as manufacturers all over the world. Since the end of the 1980s TCO has been involved in influencing the development of IT equipment in a more user and environmentally friendly direction. Our ICT product labeling system began in 1992 and is now requested by users and ICT-manufacturers all over the world.

For more information, please visit
www.tcodevelopment.com

The system specifications may differ depending on the derived models.

For detailed system specifications, refer to the product catalogue.

CPU (Optional)	Intel® ATOM™ Processor
Main Memory	Memory type: LPDDR2 SDRAM on board
Main Chipset	Intel® Clovertrail
Storage Device	e.MMC iNAND™ Embedded Flash Drive
Graphics	Intel® SGX545 (Internal)
Operating Environment	Temperature: -5~40°C for storage, 10~32°C when operating Humidity: 5~90% for storage, 20~80% when operating
AC/DC Rating	Input: 100-240VAC, 50 ~ 60Hz, Output: 12VDC 3.33A
PC Rating	12VDC 3.33A (40W)



- Optional components may not be provided or different components may be provided depending on the computer model.
- The system specifications are subject to change without notice.
- The amount of memory that Windows can use may be smaller than the actual amount of memory available.
- Replacing or adding a memory module for this product is not supported due to the product design.

Registered Trademarks

Samsung is a registered trademark of Samsung Co., Ltd.

Intel, ATOM are registered trademarks of the Intel Corporation.

Microsoft, MS-DOS, and Windows are registered trademarks of the Microsoft Corporation.

The terms HDMI and HDMI High-Definition Multimedia Interface, and the HDMI Logo are trademarks or registered trademarks of HDMI Licensing LLC in the United States and other countries.

All other product or company names mentioned herein are registered trademarks of their respective companies.

ENERGY STAR® Partner



As an ENERGY STAR® Partner, SAMSUNG has determined that this product meets the ENERGY STAR® guidelines for energy efficiency.

HDMI



The Glossary lists the terminologies used in this User Guide. For terminologies other than these, look in Windows Help.

Backup

A way to save the current data to restore it later if necessary. A backup is a way to restore computer data when the data or computer is damaged.

Chargeable USB

This program enables supplying power to a specific USB port when the system is in power saving mode, hibernation mode or off.

Client

This refers to a computer that uses a shared network resource provided by a server.

DDR SDRAM

(Double Data Rate Synchronous Dynamic Random Access Memory)

DRAM is a memory type whose cells consist of a capacitor and transistor manufactured at a low price. SDRAM is a memory type whose performance has been improved by synchronizing the clock with the external CPU clock. DDR SDRAM is a memory type whose performance has been improved by doubling the operating speed of the SDRAM and is widely used nowadays. This computer uses DDR SDRAM.

Device Manager

An administrative tool used to manage computer devices. You can add or remove hardware or update a device driver using the Device Manager.

DHCP (Dynamic Host Configuration Protocol)

This refers to automatically allocating IP addresses to the users on the network by the network administrators.

Direct X

An application interface developed to enable Windows application programs to access hardware devices at a very high speed. Since the operating speed of graphics, memory and sound cards must be very fast to provide high quality video and sound for games, Direct X enables faster control and interaction between applications and hardware devices. By using Direct X, the multimedia performance of Windows has been hugely improved.

Driver

Software that interacts between the hardware and the operating system. An operating system knows the hardware information and controls the hardware. In general, a driver is supplied with the corresponding hardware device.

D-sub (D-subminiature)

This is the cable connecting a general CRT monitor and the computer. Analog video is output through this cable.

DVD (Digital Versatile Disk)

DVD was developed to replace CD (compact disk). Although the shape and size of the disc are the same as that of a CD, the capacity of a DVD is at least 4.7GB while the capacity of a CD is 600MB. DVD video is digital unlike VHS (analog) video and supports MPEG2 compression and digital audio. To play a DVD, a DVD drive is required.

Firewall

A security system used to protect an internal network or intranet from external networks through an authentication procedure.

HDMI

This is a digital video / audio interface specification that transmits video and audio signals over a single cable.

Hibernation Mode

This is the state where the computer saves all the information in memory to the storage device and shuts down. When canceling Hibernation Mode, all application programs that were running are restored to their last state.

Icon

This refers to a small image that represents a file that users can use.

IEEE802.XX

This is a set of specifications developed by the 802 committee of IEEE for the LAN connection method called XX.

LAN (Local Area Network)

A communications network connecting computers, printers and other devices within a local area such as within a building. A LAN enables all connected devices to interact with other devices on the network. The current LAN uses the Ethernet media access control method developed in the early 1980s. To connect to an Ethernet, a network card called a LAN card, Ethernet card or network interface card is required. To exchange data between computers, a protocol is required besides the hardware equipment. Windows uses TCP/IP as the default protocol.

LCD (Liquid Crystal Display)

There are Passive Matrix and Active Matrix LCD types. This computer uses the Active Matrix type LCD called a TFT LCD. Since an LCD is implemented by transistors instead of a cathode-ray tube unlike a CRT, its size can be slim. And because it does not blink, it reduces eye strain.

Network

A group of computers and devices, such as printers and scanners, connected by a communications link. A network can be either small or large and can be connected permanently through cables or temporarily through telephone lines or wireless links. The biggest network is the Internet, a worldwide network.

Network Administrator

A user who plans, configures and manages network operations. Sometimes, a network administrator is called a system administrator.

Notification Area

This refers to the right area of the Taskbar including program icons such as the volume control, the power options and the time.

Partition

This refers to the act or practice of dividing the storage space of a hard disk drive into separate data areas known as partitions. If a 100GB hard disk drive is partitioned into 2 x 50GB partitions, the hard disk drive can be used as if there are 2 hard disk drives.

PCMCIA(Personal Computer Memory Card International Association) card

This is an extended card slot specification for mobile computers such as a notebook computer. Not only a memory, device but also most peripherals such as hard disk drives, LAN cards, etc. can be connected to this card slot.

Protocol

A protocol is a set of rules used by computers to communicate with each other across a network. A protocol is a convention or standard that controls or enables the connection, communication, and data transfer between computing endpoints. It defines the data transmission procedures and the transmission medium for more efficient network functions.

Quick Launch

This refers to a toolbar that can be configured so that you can launch a program such as Internet Explorer or display the Windows Desktop with one click. You can add any icon to the quick launch area of the Taskbar and launch frequently used program by clicking that icon.

Server

In general, a server refers to a computer that provides shared resources for network users.

Share

This refers to setting a resource of a computer such as a folder or printer so that other users can also use it.

Shared Folder

A folder that can be used by other users on the network.

Sleep Mode

A power mode that enables computers to save power consumption when they are not being used. While the computer is in sleep mode, the information in the computer memory is not saved on the storage device. If the power is turned off, the data in memory will be lost.

System File

System Files refer to files that are read and used by the Windows operating system. In general, system files must not be deleted or moved.

TCP/IPv4

This is a 4 byte (32 bit) address system separated into each byte (8 bits) by a dot and each byte is represented as a decimal number.

USB (Universal Serial Bus)

This refers to a serial interface standard developed to replace the conventional interface standards such as Serial and PS/2.

The data transmission specifications are one of the interface standards used to connect a computer to peripheral devices. These specifications include USB 1.0, 1.1, 2.0 and 3.0.

It is appropriate to support peripheral devices that require high data rates such as an AV device, secondary HDD or CD-RW. The higher the version (e.g. USB 3.0), the higher the data rate provided.

Windows Media Player

A multimedia program included with Windows. Using this program, you can play a media file, create an audio CD, listen to a radio broadcast, search and manage media files, and copy files to a portable device, etc.

A

AP 60

B

Battery 77

BIOS Setup 80

C

Charge 77

Click 43

D

Double-Click 43

Drag 43

Dual View 54

L

LCD Brightness 59

M

Monitor Connection / Output 54

Micro SD Card Slot 52

O

Overview 24

P

Product Specifications 116

R

Recorder 58

Recovery 83

S

Safety Precautions 6

Scroll 44

Support Center 76

SW Update 75

V

Volume Control 57

W

Wireless Network 60