



www.blaupunkt.com



Radio | CC

Lexington C32
St. Louis C32

7 642 180 110

7 642 180 112



Operating and installation instructions
Mode d'emploi et de montage
Instrucciones de manejo e instalación
Instruções de serviço e de montagem
Kullanım ve montaj kılavuzu

 **BLAUPUNKT**



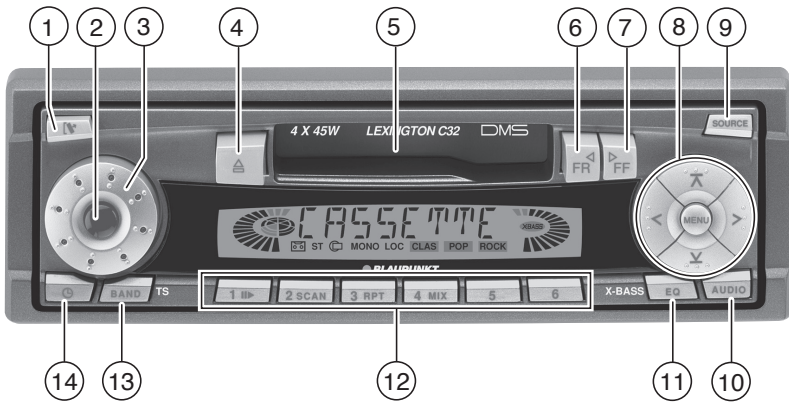





CONTROLS

ENGLISH

- ①  button to release the control panel
- ② Button to switch the unit on/off
- ③ Volume control
- ④  Cassette eject
- ⑤ Cassette compartment
- ⑥ **FR** button, fast tape winding
- ⑦ **FF** button, fast tape winding
- ⑧ Arrow buttons
MENU button, to open the basic settings menu
- ⑨ **SOURCE** button, to select the CC, radio and CD changer sources
- ⑩ **AUDIO** button, to adjust the bass, treble, balance and fader settings (Balance und Fader)
- ⑪ Short press: **EQ** button, to select the sound presets
Long press: **X-BASS**, X-Bass function
- ⑫ Keys **1 - 6**
- ⑬ Short press: **BAND** button, to select the FM memory bank and the AM waveband, source selection to radio mode
Long press: **TS**, to start the Travelstore function.
- ⑭  button, to display the time





CONTENTS

Notes and accessories.....5	CD changer mode 11
Road safety 5	Switching to CD changer mode 11
Installation 5	Selecting CDs 11
Accessories..... 5	Selecting tracks..... 11
Removable control panel6	Fast searching (audible)..... 11
Theft protection 6	Repeating individual tracks or
Detaching the control panel 6	whole CDs (REPEAT) 11
Attaching the control panel..... 6	Random track play (MIX)..... 12
Switching on/off.....7	Scanning all tracks on all CDs
Adjusting the volume7	(SCAN) 12
Setting the power-on volume..... 7	Pausing playback (PAUSE) 12
Instantaneously reducing the	CLOCK - Time.....13
volume (mute) 7	Displaying the time..... 13
Mute while telephoning 8	Setting the clock..... 13
Radio mode8	Selecting 12/24-hour clock mode .. 13
Switching to radio mode 8	Displaying the time when the unit
Selecting the frequency band /	is off and the ignition is on..... 13
memory bank..... 8	Sound and volume
Tuning into a station 9	distribution settings.....14
Setting the sensitivity of station	Adjusting the bass 14
seek tuning 9	Adjusting the treble 14
Storing station presets 9	Adjusting the balance settings..... 14
Storing stations automatically (Tra-	Adjusting the fader settings..... 14
velstore) 9	Equalizer and X-BASS.....15
Listening to station presets 9	X-BASS 15
Cassette mode10	Selecting preset sound effect..... 15
Cassette playback 10	Specifications.....16
Switching over the playing side of	Amplifier 16
the tape 10	Tuner 16
Fast tape winding 10	CC 16
Cassette eject 10	Pre-Amp Out 16
	Installation instructions72





NOTES AND ACCESSORIES

Thank you for deciding to use a Blaupunkt product. We hope you enjoy using this new piece of equipment.

Please read these operating instructions before using the equipment for the first time. The Blaupunkt editors are constantly working on making the operating instructions clearer and easier to understand. However, if you still have any questions on how to operate the equipment, please contact your dealer or the telephone hotline for your country. You will find the hotline telephone numbers printed at the back of this booklet.

Road safety

 Road safety has absolute priority. Only operate your radio unit if the road and traffic conditions allow you to do so. Familiarize yourself with the unit before setting off on your journey.

You should always be able to hear police, fire and ambulance sirens from far. For this reason, set the volume of the program you are listening to at a reasonable level.

Installation

If you want to install your car radio by yourself, please read the installation and connection instructions that follow these operating instructions.

Accessories

Only use accessories approved by Blaupunkt.

Remote control

The RC 04 remote control is optionally available for the Lexington C32 unit.

The St. Louis C32 unit cannot be remotely controlled.

Amplifier

All Blaupunkt and Velocity amplifiers can be used.

CD changer

The Blaupunkt CD changer CDC A 01 (7607 700 022) can be connected to the Lexington C32 unit.

No CD changer can be connected to the St. Louis C32 unit.





REMOVABLE CONTROL PANEL

Removable control panel

Theft protection

As a way of protecting your equipment against theft, the unit is equipped with a detachable control panel (release panel). Without this control panel, the car radio is worthless to a thief.

Protect your equipment against theft by taking the control panel with you every time you leave your vehicle. Do not leave the control panel in your vehicle - not even in a hiding place.

The control panel has been designed to be easily use.

Note:

- Never drop the control panel.
- Never expose the control panel to direct sunlight or other heat sources.
- Avoid making direct skin contact with the control panel's contacts. If necessary, clean the contacts with a lint-free cloth and some alcohol.

Detaching the control panel

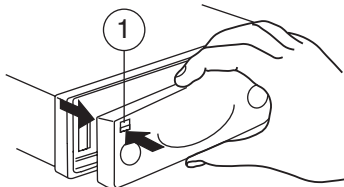

- ⇨ Press the  button (1).

The control panel locking mechanism opens.

- ⇨ First, pull the control panel straight off the unit and then out towards the left.

- The unit switches off after the control panel is removed.
- All current settings of the radio are saved.
- CD already inserted in the unit remains there.

Attaching the control panel

- ⇨ Slide the control panel from left to right into the unit's guide.
- ⇨ Press the left-hand edge of the control panel into the unit until it clicks into place.

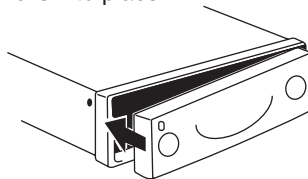

Note:

- When attaching the control panel, make sure you do not press on the display.

If the unit was still switched on when you removed the control panel, the unit will automatically switch back on with the last settings activated i.e. radio, CC or CD changer (CD changer only with the Lexington C32) when the panel is reinserted.





SWITCHING ON/OFF

Switching on/off

There are various ways of switching the unit on/off:

Switching on/off using the vehicle ignition

If the unit is correctly connected to the vehicle's ignition and it was not switched off using button (2), it will switch on/off simultaneously with the ignition.

Switching on/off using the removable control panel

⇨ Remove the control panel.

The unit switches off.

⇨ Attach the control panel again.

The unit switches on. The last settings i.e. radio, CC or CD changer (CD changer only with the Lexington C32) will be reactivated.

Switching on/off using button (2)

⇨ To switch the unit on, press button (2).

The unit can only be switched on when the ignition is turned on.

⇨ To switch the unit off, press button (2) for longer than two seconds.

The unit switches off.

ADJUSTING THE VOLUME

Adjusting the volume

The system volume can be adjusted in steps from 0 (off) to 100 (maximum).

To increase the system volume,
⇨ turn the volume control (3) clockwise.

To decrease the volume,
⇨ turn the volume control (3) anti-clockwise.

Setting the power-on volume

You can set the unit's default power-on volume.

⇨ Press the **MENU** button (8).

⇨ Keep pressing the **▲** or **▼** button (8) until "ON VOL" appears in the display.

⇨ Set the power-on volume using the **<** and **>** buttons (8).

To help you adjusting the volume more easily, the volume will be increased / decreased as you make your changes.

When you have finished making your changes,

⇨ press the **MENU** button (8) twice.

Instantaneously reducing the volume (mute)

You can instantaneously reduce the volume (mute) to a level preset by you.

⇨ Briefly press button (2).





ADJUSTING THE VOLUME

RADIO MODE

“MUTE” appears in the display.

Setting the mute level

You can set the unit's mute volume level.

- ⇨ Press the **MENU** button (8).
- ⇨ Keep pressing the **⏏** or **⏏** button (8) until “MUTE LVL” appears in the display.
- ⇨ Set the mute level using the **<** and **>** buttons (8).

When you have finished making your changes,

- ⇨ press the **MENU** button (8) twice.

Mute while telephoning

If your unit is connected to a mobile telephone, the car radio's volume will be muted as soon as you “pick up” the telephone. “TEL CALL” flashes in the display.

This requires to the mobile telephone be connected to the car radio as described in the installation instructions.

The volume will be reduced to the configured mute volume level.

Radio mode

Switching to radio mode

If you are in CC or CD changer mode (CD changer only with the Lexington C32),

- ⇨ keep pressing the **SOURCE** (9) button until the radio mode appears in the display together with the memory bank and frequency.

Selecting the frequency band / memory bank

This unit can receive programs broadcast over the FM and AM frequency band. There are three preset memory bank for the FM range and one for the AM range. Six stations can be stored on each memory bank.

Selecting the FM memory bank

To switch between the FM memory bank FM1, FM2 and FMT,

- ⇨ press the **BAND/TS** button (13).

Selecting the AM waveband

To select the AM waveband,

- ⇨ keep pressing the **BAND/TS** button (13) until AM appears in the display.





RADIO MODE

Tuning into a station

There are various ways of tuning to a station.

Automatic seek tuning

⇨ Press the **∨** or **∧** button (8).

The unit tunes to the next receivable station.

Setting the sensitivity of station seek tuning

You can choose whether to tune only to strong reception stations or to also tune to those with a weak reception.

⇨ Press the **MENU** button (8).

⇨ Keep pressing the **∨** or **∧** button (8) until “SENS HI” or “SENS LO” appears in the display

“SENS HI” means that the tuner is set high to sensitivity. “SENS LO” means it is set to the low sensitivity setting. If “SENS LO” is selected, “LOC” lights up in the display.

⇨ Set the required sensitivity using the **<** and **>** buttons (8).

When you have finished making your changes,

⇨ press the **MENU** button (8).

Tuning into stations manually

You can also tune into stations manually.

⇨ Press the **<** or **>** button (8).

Storing station presets

Storing stations manually

⇨ Select the required memory bank (FM1, FM2 or FMT) or the AM waveband.

⇨ Tune into the station.

⇨ Press one of the station buttons **1-6** (12) for longer than one second to store the station in that preset memory.

Storing stations automatically (Travelstore)

You can automatically store the six stations with the strongest reception in the region. The stations are stored in the FMT or AM memory depending on the selected frequency band.

Note:

● Any stations that were previously stored on this memory bank are deleted in the process.

⇨ Press and hold the **BAND/TS** button (13) until seek tuning begins.

The station storing procedure begins. Once the procedure finishes, all the stored stations are played briefly.

Listening to station presets

⇨ Select the memory bank on which the station was stored.

⇨ Press the preset station button **1-6** (12) of the station you want to listen to.





CASSETTE MODE

Cassette mode

Cassette playback

- If there is no cassette inserted in the unit.
- ⇨ Insert the cassette with its open edge on the right and side A/1 facing up into the cassette compartment (5).

The side of the cassette that is facing up is then played first of all (side A/1). The cassette symbol appears in the display.

- If a cassette is already inserted in the unit.
- ⇨ Keep pressing the **SOURCE** button (9) until "TAPE" appears in the display.

The cassette is played in the direction that was last set.

Switching over the playing side of the tape

- ⇨ Press the tape-winding buttons **FR** (6) and **FF** (7) simultaneously.

The tape playing direction changes.

The direction of play is automatically switched over when the end of the tape is reached (autoreverse).

Fast tape winding

Fast-forwarding

- To fast forward side A/1,
 - ⇨ press the **FF** tape-winding button (7) so that it clicks into position.
 - To fast forward side B/2,
 - ⇨ press the **FR** tape-winding button (6) so that it clicks into position.
- "TAPE FF" appears in the display.

Fast-rewinding

- To fast rewind side A/1,
 - ⇨ press the **FR** tape-winding button (6) so that it clicks into position.
 - To fast rewind side B/2,
 - ⇨ press the **FF** tape-winding button (7) so that it clicks into position.
- "TAPE FR" appears in the display.

Stopping tape winding

- ⇨ Press the fast tape-winding button for the opposite direction.

Playback is resumed.

Cassette eject

- ⇨ Press the Δ button (4) to eject the cassette from the unit.





CD CHANGER MODE

CD changer mode

You can connect a CD changer to the Lexington C32 unit. You can obtain further information on available CD changers from your dealer.

Note:

- Information on handling CDs, inserting CDs and operating the CD changer can be found in the operating instructions supplied with your CD changer.

Switching to CD changer mode

- Keep pressing the **SOURCE** (9) button until the display shows, for instance, "CDC 1--1".

The first digit in this display represents the CD number (in this case 1), and the second digit represents the track number (in this case 1).

Playback begins with the first CD that the CD changer detects.

Selecting CDs

- To move up or down to another CD,
- press the **▲** or **▼** button (8) once or several times.

Selecting tracks

To move up or down to another track on the current CD,

- press the **>** or **<** button (8) once or several times.

Fast searching (audible)

To fast search backwards or forwards,

- press one of the **<>** buttons (8) pressed until fast searching backwards / forwards begins.

Repeating individual tracks or whole CDs (REPEAT)

To repeat the current track,

- briefly press button **3 (RPT)** (12).

"S--RPT" appears briefly in the display.

To repeat the current CD,

- keep the **3 (RPT)** button (12) pressed for longer than two seconds.

"D--RPT" appears briefly in the display.

Deactivating REPEAT

To stop the current track or current CD from being repeated,

- press button **3 (RPT)** (12) until "S--RPT" or "D--RPT" disappears and the standard CD changer display reappears.





CD CHANGER MODE

Random track play (MIX)

To play the tracks on the current CD in random order,

- ⇨ briefly press button **4 (MIX)** ⁽¹²⁾.

“S--MIX” appears briefly in the display.

To play the tracks on all inserted CDs in random order,

- ⇨ keep the **4 (MIX)** button ⁽¹²⁾ pressed for longer than two seconds.

“D--MIX” appears briefly in the display.

Canceling MIX

To stop the tracks from being played in random order,

- ⇨ press button **4 (MIX)** ⁽¹²⁾ until “S--MIX” or “D--MIX” disappears and the standard CD changer display reappears.

Scanning all tracks on all CDs (SCAN)

Scanning tracks on the current CD

To briefly play all the tracks on the current CD in ascending order,

- ⇨ press button **2 (SCAN)** ⁽¹²⁾.

“S--SCN” appears in the display.

Scanning the first track on all CDs

You can briefly play the first track all CDs in the CD changer.

- ⇨ keep the **2 (SCAN)** button ⁽¹²⁾ pressed for longer than two seconds.

“D--SCAN” appears in the display.

Stopping SCAN

To stop scanning,

- ⇨ briefly press the **2 (SCAN)** button ⁽¹²⁾ again.

The currently scanned track will then continue to be played normally.

Note:

- You can set the scanning time (scantime). For further details, read the section entitled “Setting the scantime” in the “CD mode” chapter.

Pausing playback (PAUSE)

- ⇨ Press button **1 (▶)** ⁽¹²⁾.

“S--PAUSE” appears in the display.

Canceling pause

- ⇨ Press button **2 (▶)** ⁽¹²⁾ while in pause mode.

Playback is resumed.





CLOCK - TIME

CLOCK - Time

Displaying the time

To display the time,

- ⇨ briefly press the **⏻** button (14).

Setting the clock

- ⇨ Press the **MENU** button (8).
- ⇨ Keep pressing the **↔** or **↵** button (8) until "CLOCKSET" appears in the display.
- ⇨ Press the **>** button (8).

The time appears in the display. The minutes flash on and off and can be adjusted.

- ⇨ Adjust the minutes using the **↔** **↵** buttons (8).

Once the minutes are set,

- ⇨ press the **<** button (8).

The hours flash on and off.

- ⇨ Adjust the hours using the **↔** **↵** buttons (8).

When you have finished making your changes,

- ⇨ press the **MENU** button (8) twice.

Selecting 12/24-hour clock mode

- ⇨ Press the **MENU** button (8).
- ⇨ Keep pressing the **↔** or **↵** button (8) until "24 H MODE" or "12 H MODE" appears in the display.
- ⇨ Press the **<** or **>** button (8) to switch between the modes.

When you have finished making your changes,

- ⇨ press the **MENU** button (8).

Displaying the time when the unit is off and the ignition is on

To display the clock when the unit is off and the ignition is on,

- ⇨ press the **MENU** button (8).
- ⇨ Keep pressing the **↔** or **↵** button (8) until "CLOCK OFF" or "CLOCK ON" appears in the display.

- ⇨ Press the **<** or **>** button (8) to switch between the displays.

When you have finished making your changes,

- ⇨ press the **MENU** button (8).





SOUND AND VOLUME DISTRIBUTION SETTINGS

Sound and volume distribution settings

Adjusting the bass

To adjust the BASS,

- ⇨ press the **AUDIO** button (10).

“BAS” appears in the display.

To increase the bass,

- ⇨ turn the volume control (3) clockwise.

To decrease the bass,

- ⇨ turn the volume control (3) anti-clockwise.

When you have finished making your changes,

- ⇨ wait 8 seconds, the settings are saved and the audio source display appears.

Adjusting the treble

To adjust the TREBLE,

- ⇨ keep pressing the **AUDIO** (10) button until “TRE” appears in the display.

To increase the treble,

- ⇨ turn the volume control (3) clockwise.

To decrease the treble,

- ⇨ turn the volume control (3) anti-clockwise.

When you have finished making your changes,

- ⇨ wait 8 seconds, the settings are saved and the audio source display appears.

Adjusting the balance settings

To adjust the left/right volume distribution (balance),

- ⇨ keep pressing the **AUDIO** (10) button until “BAL” appears in the display.

To move the volume distribution toward the right,

- ⇨ turn the volume control (3) clockwise.

To move the volume distribution toward the left,

- ⇨ turn the volume control (3) anti-clockwise.

When you have finished making your changes,

- ⇨ wait 8 seconds, the settings are saved and the audio source display appears.

Adjusting the fader settings

To adjust the front/back volume distribution (fader),

- ⇨ keep pressing the **AUDIO** (10) button until “FAD” appears in the display.

To move the volume distribution toward the back,

- ⇨ turn the volume control (3) clockwise.

To move the volume distribution toward the front,

- ⇨ turn the volume control (3) anti-clockwise.





EQUALIZER AND X-BASS

When you have finished making your changes,

- ⇨ wait 8 seconds, the settings are saved and the audio source display appears.

Equalizer and X-BASS

X-BASS

The X-BASS feature can be used to boost the bass at low volume levels.

To activate X-BASS,

- ⇨ keep the **EQ/X-BASS** button ⁽¹¹⁾ pressed until “XBASS ON” appears in the display.

“X-BASS” appears in the display.

To deactivate X-BASS,

- ⇨ keep the **EQ/X-BASS** button ⁽¹¹⁾ pressed until “XBASS OFF” appears in the display.

“X-BASS” disappears.

Selecting preset sound effect

You can select preset sound effect for the following styles of music:

- CLASSIC
- POP M
- ROCK M

The settings for these music styles have already been programmed.

To select one of the sound presets,

- ⇨ keep pressing the **EQ/X-BASS** button ⁽¹¹⁾ until the required setting appears in the display.

If you want to deactivate the sound preset,

- ⇨ keep pressing the **EQ/X-BASS** button ⁽¹¹⁾ until “DSP OFF” appears in the display.





SPECIFICATIONS

Specifications

Amplifier

Output power:

St. Louis C32: 4 x 22 watts sine
in accordance
with DIN 45 324
at 14.4 V 4 x 50
watts max. power

Lexington C32: 4 x 15 watts sine
in accordance
with DIN 45 324
at 14.4 V 4 x 40
watts max. power

Tuner

Frequency ranges US:

FM: 87.5 - 107.9 MHz

AM: 530 - 1710 kHz

FM mono sensitivity:

15 dBf

FM frequency response:

35 - 16.000 Hz

CC

Frequency response:

30 - 18.000 Hz

Pre-Amp Out

(not applicable to St. Louis C32:)

Output: $1.5 V_{\text{rms}} \pm 2.5 \text{ dB}$

Subject to changes!





ÉLÉMENTS DE COMMANDE



- ① Touche , déverrouiller la façade détachable
- ② Touche, allumer / éteindre l'appareil
- ③ Réglage du volume
- ④  Ejection de la cassette
- ⑤ Fente d'insertion de la cassette
- ⑥ Touche **FR**, défilement rapide de la bande
- ⑦ Touche **FF**, défilement rapide de la bande
- ⑧ Pavé de touches flèche
Touche **MENU**, afficher le menu de configuration
- ⑨ Touche **SOURCE**, sélection du mode CC, Radio, Changeur CD
- ⑩ Touche **AUDIO**, régler les graves, aigus et la répartition du volume (balance et fader)
- ⑪ Presser brièvement: touche **EQ**, choisir l'ambiance sonore
Presser longuement : **X-BASS**, fonction X-Bass
- ⑫ Pavé de touches **1 - 6**
- ⑬ Presser brièvement : touche **BAND**, sélection des niveaux de mémoire FM et de la gamme d'ondes AM, du mode Radio
Pression longuement : **TS**, démarrer la fonction Travelstore
- ⑭ Touche , affichage de l'heure





TABLE DES MATIÈRES

Remarques et accessoires.....	19	Mode Changeur CD.....	25
Sécurité routière	19	Activer le mode Changeur CD	25
Montage	19	Choisir un CD	25
Accessoires.....	19	Choisir une plage.....	25
Façade détachable.....	20	Recherche rapide (audible)	25
Système antivol.....	20	Lecture répétée de plages ou de	
Enlever la façade	20	CD (REPEAT).....	25
Poser la façade.....	20	Lecture aléatoire de plages (MIX)...	26
Allumer / Eteindre.....	21	Balayage de toutes les plages de	
Réglage du volume	21	tous les CD (SCAN)	26
Réglage du volume de mise en		Interrompre la lecture (PAUSE)	26
marche	21	CLOCK - Heure.....	27
Mise en sourdine (mute)	21	Affichage de l'heure.....	27
Mise en sourdine du téléphone	22	Réglage de l'heure.....	27
Mode Radio	22	Sélection du mode 12 / 24 heures ..	27
Activer le mode Radio.....	22	Affichage de l'heure, l'autoradio	
Choisir une gamme d'ondes / un		étant éteint et le contact mis.....	27
niveau de mémoire.....	22	Son et répartition du volume ..	28
Choisir une station	23	Régler les graves.....	28
Régler la sensibilité de recherche		Régler les aigus	28
de stations.....	23	Régler la balance	28
Mémoriser une station.....	23	Régler le fader	28
Mémorisation automatique de		Égaliseur et X-BASS	29
stations (Travelstore)	23	X-BASS	29
Choisir une station mémorisée	23	Sélectionner une ambiance sonore	29
Mode Cassette	24	Caractéristiques techniques ..	30
Lecture de cassette	24	Amplificateur	30
Changement de face	24	Tuner	30
Défilement rapide.....	24	CC	30
Éjection de la cassette	24	Sortie préampli	30
		Notice de montage.....	72





REMARQUES ET ACCESSOIRES

Nous vous remercions d'avoir opté pour ce produit Blaupunkt et nous vous souhaitons beaucoup de plaisir avec ce nouvel appareil.

Avant de mettre votre autoradio en service, lisez attentivement le présent mode d'emploi. Les rédacteurs de Blaupunkt s'efforcent constamment de rédiger les modes d'emploi de la manière la plus claire et la plus compréhensible. Si vous avez toutefois des questions concernant l'utilisation de l'appareil, n'hésitez pas à contacter votre revendeur ou le service d'assistance téléphonique de votre pays. Les numéros de téléphone figurent au dos de ce mode d'emploi.

Sécurité routière

 La sécurité routière est impérative ! Utilisez par conséquent votre autoradio en restant toujours maître de votre véhicule. Familiarisez-vous avec l'autoradio avant de prendre la route.

Assurez-vous de pouvoir toujours bien percevoir les signaux d'avertissement venant de l'extérieur du véhicule comme ceux de la police et des sapeurs-pompiers de façon à pouvoir toujours réagir à temps. Soyez toujours à l'écoute de l'autoradio à un volume modéré pendant vos déplacements.

Montage

Si vous voulez monter vous-même votre autoradio, lisez impérativement les consignes de montage et de branchement figurant à la fin du mode d'emploi.

Accessoires

Utilisez uniquement les accessoires autorisés par Blaupunkt.

Télécommande

La télécommande RC 04 est disponible en option pour le Lexington C32.

Le St. Louis C32 ne peut être télécommandé.

Amplificateurs

Tous les amplis Blaupunkt peuvent être utilisés.

Changeurs CD

Le changeur Blaupunkt CDC A 01 (7607 700 022) peut être raccordé au Lexington C32.

Le St. Louis C32 ne peut être branché sur un changeur CD.





FAÇADE DÉTACHABLE

Façade détachable

Systeme antivol

Votre autoradio est équipé d'une façade détachable qui le protège contre le vol. Sans cette façade détachable, l'autoradio n'a aucune valeur pour le voleur.

Protégez votre autoradio contre le vol en enlevant la façade détachable à chaque fois que vous quittez votre véhicule. Ne laissez jamais la façade dans le véhicule, même en la cachant bien. La forme de la façade assure une manipulation simple.

Note:

- Ne pas laisser tomber la façade par terre.
- Ne pas l'exposer directement au soleil ou à d'autres sources de chaleur.
- La conserver dans l'étui fourni.
- Eviter que la peau touche directement les contacts de la façade. Nettoyer si nécessaire les contacts au moyen d'un chiffon non pelucheux, imprégné d'alcool.

Enlever la façade

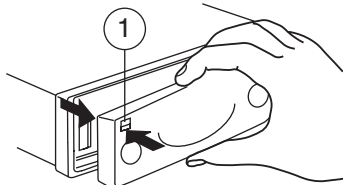

- ⇨ Pressez la touche  ①.

La façade se déverrouille.

- ⇨ Enlevez la façade en la tirant d'abord tout droit et ensuite vers la gauche.
- Après avoir enlevé la façade, l'autoradio s'éteint.
- Le mode sélectionné est mémorisé.
- Un CD inséré reste dans l'appareil.

Poser la façade

- ⇨ Introduisez la façade de gauche à droite dans le guide de l'autoradio.
- ⇨ Poussez le côté gauche de la façade dans l'autoradio jusqu'à ce qu'elle s'enclenche.



Note:

- N'appuyez pas sur l'afficheur en posant la façade.

Si l'autoradio était allumé au moment où vous avez enlevé la façade, il se rallume automatiquement au dernier mode choisi, soit Radio, CC, Changeur CD (changeur CD uniquement pour le Lexington C32), une fois la façade reposée.





ALLUMER / ÉTEINDRE

Allumer / Eteindre

Pour allumer / éteindre l'autoradio, plusieurs possibilités vous sont offertes :

Allumer et Eteindre via le contact du véhicule

Si l'autoradio est relié correctement à l'allumage du véhicule et s'il n'a pas été éteint avec la touche (2), vous l'allumez ou l'éteignez en mettant ou coupant le contact.

Allumer et éteindre avec la façade détachable

⇨ Enlevez la façade.

L'autoradio s'éteint.

⇨ Reposez la façade.

L'autoradio s'allume au dernier mode sélectionné : radio, CC, changeur CD (changeur CD uniquement avec Lexington C32).

Allumer / Eteindre avec la touche (2)

⇨ Pour allumer, pressez la touche (2).

Vous ne pouvez allumer l'autoradio qu'après avoir mis le contact.

⇨ Pour éteindre, maintenez la touche (2) pendant plus de deux secondes.

L'autoradio s'éteint.

RÉGLAGE DU VOLUME

Réglage du volume

Le volume de l'autoradio est réglable de 0 (volume désactivé) à 100 (volume maximal).

Pour augmenter le volume,

⇨ tournez le bouton de réglage du volume (3) vers la droite.

Pour réduire le volume,

⇨ tournez le bouton de réglage du volume (3) vers la gauche.

Réglage du volume de mise en marche

Le volume auquel l'appareil se fait entendre à la mise en marche est réglable.

⇨ Pressez la touche **MENU** (8).

⇨ Pressez la touche **▲** ou **▼** (8) autant de fois que nécessaire jusqu'à ce que « ON VOL » apparaisse sur l'afficheur.

⇨ Réglez le volume de mise en marche avec les touches **<>** (8).

Pour vous faciliter la tâche, les changements de volume sont audibles pendant le réglage.

Une fois le réglage terminé,

⇨ pressez deux fois de suite la touche **MENU** (8).

Mise en sourdine (mute)

Vous pouvez réduire brusquement le volume à une valeur que vous avez choisie auparavant.

⇨ Pressez brièvement la touche (2).
« MUTE » apparaît sur l'afficheur.





MODE RADIO

Régler le volume de mise en sourdine

Le volume de mise en sourdine est réglable.

- ⇨ Pressez la touche **MENU** (8).
- ⇨ Pressez la touche **↶** ou **↷** (8) autant de fois que nécessaire jusqu'à ce que « MUTE LVL » apparaisse sur l'afficheur.
- ⇨ Réglez le volume de mise en sourdine avec les touches **<>** (8).

Une fois le réglage effectué,

- ⇨ pressez deux fois de suite la touche **MENU** (8).

Mise en sourdine du téléphone

Si votre autoradio est relié à un téléphone mobile, l'autoradio est mis en sourdine dès que vous décrochez. « TEL CALL » clignote sur l'afficheur.

Pour cela, le téléphone mobile doit être raccordé à l'autoradio comme décrit dans les consignes de montage.

La mise en sourdine correspond au volume de mise en sourdine réglée (mute level).

Mode Radio

Activer le mode Radio

Si l'autoradio est en mode CC ou Changeur CD (changeur CD uniquement avec Lexington C32),

- ⇨ pressez la touche **SOURCE** (9) autant de fois que nécessaire jusqu'à ce que le mode Radio avec le niveau de mémoire et la fréquence apparaisse sur l'afficheur.

Choisir une gamme d'ondes / un niveau de mémoire

Cet autoradio permet d'écouter les émissions des gammes d'ondes FM et AM. La gamme d'ondes FM offre trois niveaux de mémoire, et la gamme d'ondes AM un niveau de mémoire. Six stations peuvent être mémorisées sur chacun des niveaux de mémoire.

Choisir le niveau de mémoire FM

Pour passer entre les niveaux de mémoire FM soit FM1, FM2 et FMT,

- ⇨ pressez la touche **BAND/TS** (13).

Choisir la gamme d'ondes AM

Pour choisir la gamme d'ondes AM,

- ⇨ pressez la touche **BAND/TS** (13) autant de fois que nécessaire jusqu'à ce que « AM » apparaisse sur l'afficheur.





MODE RADIO

Choisir une station

Plusieurs possibilités vous sont offertes pour vous mettre à l'écoute d'une station.

Recherche automatique de stations

⇨ Pressez la touche **V** ou **∧** (8).

L'autoradio se règle sur la prochaine station qu'il peut capter.

Régler la sensibilité de recherche de stations

Vous avez la possibilité de choisir si la station recherchera uniquement les stations de forte réception ou de faible réception.

⇨ Pressez la touche **MENU** (8).

⇨ Pressez la touche **V** ou **∧** (8) autant de fois que nécessaire jusqu'à ce que « SENS HI » ou « SENS LO » apparaisse sur l'afficheur.

« SENS HI » correspond au niveau de sensibilité le plus élevé, « SENS LO » au niveau le plus faible. Si vous choisissez « SENS LO », « LOC » est allumé sur l'afficheur.

⇨ Réglez le niveau de sensibilité au moyen des touches **<>** (8).

Une fois le réglage terminé,

⇨ pressez la touche **MENU** (8).

Réglage manuel de stations

Vous avez la possibilité de régler les stations manuellement.

⇨ Pressez la touche **<** ou **>** (8).

Mémoriser une station

Mémorisation manuelle de stations

⇨ Choisissez le niveau de mémoire FM 1, FM 2, FMT ou la gamme d'ondes AM.

⇨ Choisissez une station.

⇨ Pressez pendant plus d'une seconde l'une des touches **1-6** (12) sur laquelle vous voulez mémoriser la station.

Mémorisation automatique de stations (Travelstore)

Vous avez la possibilité de mémoriser automatiquement les six stations les plus puissantes de la région. La mémorisation s'effectue au niveau de mémoire FMT ou AM, en fonction de la gamme d'ondes choisie.

Note:

- Les stations déjà mémorisées sur ce niveau de mémoire seront effacées.
- ⇨ Maintenez la touche **BAND/TS** (13) jusqu'au lancement de la recherche.

La mémorisation commence. Une fois la mémorisation terminée, vous entendez successivement toutes les stations mémorisées pendant quelques secondes.

Choisir une station mémorisée

⇨ Choisissez le niveau de mémoire sur lequel la station a été mémorisée.

⇨ Pressez la touche de station **1-6** (12) de la station voulue.





MODE CASSETTE

Mode Casette

Lecture de cassette

- Quand l'appareil ne contient pas de cassette :
- ⇨ Introduire la cassette, le côté bande dirigé vers la droite et la face A/1 vers le haut dans la fente d'insertion de cassette (5).

La lecture de la cassette commence par la face dirigée vers le haut (face A/1). Le symbole Casette est allumé sur l'afficheur.

- Quand l'appareil contient une cassette :
- ⇨ Presser la touche **SOURCE** (9) autant de fois que nécessaire jusqu'à ce que « TAPE » soit visible sur l'afficheur.

La cassette est lu dans le dernier sens de lecture choisi.

Changement de face

- ⇨ Pressez en même temps les touches de défilement **FR** (6) et **FF** (7).

Le sens de lecture change.

A la fin de la bande, la face permute automatiquement (autoreverse).

Défilement rapide

Avance rapide

- Pour faire avancer rapidement la bande (A/ 1),
- ⇨ pressez la touche de défilement **FF** (7) jusqu'à ce qu'elle s'enclenche.
- Pour faire avancer rapidement la bande (B/ 2),
- ⇨ pressez la touche de défilement **FR** (6) jusqu'à ce qu'elle s'enclenche.

Sur l'afficheur apparaît « TAPE FF ».

Recul rapide

- Pour faire reculer rapidement la bande (A/ 1),
- ⇨ pressez la touche de défilement **FR** (6) jusqu'à ce qu'elle s'enclenche.
- Pour faire avancer rapidement la bande (B/ 2),
- ⇨ pressez la touche de défilement **FF** (7) jusqu'à ce qu'elle s'enclenche.

Sur l'afficheur apparaît « TAPE FR ».

Stopper le défilement

- ⇨ Pressez la touche de défilement opposée.

La lecture continue.

Éjection de la cassette

- ⇨ Pressez la touche Δ (4) pour éjecter la cassette de l'appareil.





MODE CHANGEUR CD

Mode Changeur CD

Vous avez la possibilité de raccorder un changeur CD à l'autoradio Lexington C32. Pour plus de détails sur les changeurs CD disponibles, n'hésitez pas de vous adresser à votre revendeur.

Note:

- Reportez-vous au mode d'emploi de votre changeur CD pour toutes informations sur la manipulation des CD, leur insertion et l'utilisation du changeur CD.

Activer le mode Changeur CD

- ⇨ Pressez la touche **SOURCE** (9) autant de fois que nécessaire jusqu'à ce que « CDC 1--1 » apparaisse par exemple sur l'afficheur.

Le premier chiffre affiché indique le numéro du CD (ici : 1), le second le numéro de la plage (ici : 1).

La lecture commence par le premier CD reconnu par le changeur CD.

Choisir un CD

Pour passer à un CD suivant ou précédent,

- ⇨ pressez la touche **⏮** ou **⏭** (8) une ou plusieurs fois de suite.

Choisir une plage

Pour passer à une plage suivante ou précédente du CD écouté,

- ⇨ pressez la touche **>** ou **<** (8) une ou plusieurs fois de suite.

Recherche rapide (audible)

Pour une recherche rapide de plages précédentes ou suivantes,

- ⇨ maintenez l'une des touches **<>** (8) jusqu'à ce que la recherche rapide de plages précédentes ou suivantes démarre.

Lecture répétée de plages ou de CD (REPEAT)

Pour répéter la plage momentanée,

- ⇨ pressez brièvement la touche **3 (RPT)** (12).

« S--RPT » apparaît pendant un court instant.

Pour répéter le CD momentané,

- ⇨ pressez la touche **3 (RPT)** (12) pendant plus de deux secondes.

« D--RPT » apparaît sur l'afficheur pendant un court instant.

Stopper la fonction de répétition

Pour stopper la répétition de la plage momentanée ou du CD momentané,

- ⇨ pressez la touche **3 (RPT)** (12) jusqu'à ce que « S--RPT » ou « D--RPT » s'éteigne sur l'afficheur et que le mode Changeur CD normal réapparaisse.





MODE CHANGEUR CD

Lecture aléatoire de plages (MIX)

Pour écouter les plages du CD momentanément dans un ordre aléatoire,

⇨ pressez brièvement la touche **4 (MIX)** ⁽¹²⁾.

« S--MIX » apparaît sur l'afficheur pendant un court instant.

Pour écouter les morceaux de tous les CD dans un ordre aléatoire,

⇨ pressez la touche **4 (MIX)** ⁽¹²⁾ pendant plus de deux secondes.

« D--MIX » apparaît sur l'afficheur pendant un court instant.

Stopper MIX

Pour stopper la lecture aléatoire de plages,

⇨ pressez la touche **4 (MIX)** ⁽¹²⁾ jusqu'à ce que « S--MIX » ou « D--MIX » s'éteigne sur l'afficheur et que le mode Changeur CD normal réapparaisse.

Balayage de toutes les plages de tous les CD (SCAN)

Balayage des plages du CD momentanément

Pour écouter successivement toutes les plages de tous les CD insérés dans l'ordre ascendant pendant quelques secondes,

⇨ pressez la touche **2 (SCAN)** ⁽¹²⁾.

« S--SCN » apparaît sur l'afficheur.

Balayer la première plage de tous les CD

Pour écouter successivement la première plage de tous les CD insérés pendant quelques secondes,

⇨ pressez la touche **2 (SCAN)** ⁽¹²⁾ pendant plus de 2 secondes.

« D--SCAN » apparaît sur l'afficheur.

Stopper SCAN

Pour stopper le balayage,

⇨ pressez brièvement la touche **2 (SCAN)** ⁽¹²⁾.

Vous restez à l'écoute du morceau balayé.

Note:

- La durée de balayage est réglable. Pour régler la durée de balayage, reportez-vous au paragraphe « Régler la durée de balayage » du chapitre « Mode CD ».

Interrompre la lecture (PAUSE)

⇨ Pressez la touche **1 (P)** ⁽¹²⁾.

« S--PAUSE » apparaît sur l'afficheur.

Annuler la pause

⇨ Pressez la touche **2 (P)** ⁽¹²⁾ pendant la pause.

La lecture se poursuit.





CLOCK - HEURE

CLOCK - Heure

Affichage de l'heure

Pour afficher l'heure,

- ⇨ pressez la touche **⏻** (14).

Réglage de l'heure

- ⇨ Pressez la touche **MENU** (8).
- ⇨ Pressez la touche **↶** ou **↷** (8) autant de fois que nécessaire jusqu'à ce que « CLOCKSET » apparaisse sur l'afficheur.

- ⇨ Pressez la touche **➤** (8).

L'heure apparaît sur l'afficheur. Les minutes clignotent pour vous signaler qu'elles peuvent être réglées.

- ⇨ Réglez les minutes au moyen des touches **↶**/**↷** (8).

Une fois les minutes réglées,

- ⇨ pressez la touche **⏪** (8).

Les heures clignotent.

- ⇨ Réglez les heures au moyen des touches **↶**/**↷** (8).

Une fois le réglage effectué,

- ⇨ pressez deux fois de suite la touche **MENU** (8).

Sélection du mode 12 / 24 heures

- ⇨ Pressez la touche **MENU** (8).
- ⇨ Pressez la touche **↶** ou **↷** (8) autant de fois que nécessaire jusqu'à ce que « 24 H MODE » ou « 12 H MODE » apparaisse sur l'afficheur.

- ⇨ Pressez la touche **⏪** ou **⏩** (8) pour changer de mode.

Une fois le réglage effectué,

- ⇨ pressez la touche **MENU** (8).

Affichage de l'heure, l'autoradio étant éteint et le contact mis

Pour afficher l'heure quand l'autoradio est éteint et le contact est mis,

- ⇨ pressez la touche **MENU** (8).
- ⇨ Pressez la touche **↶** ou **↷** (8) autant de fois que nécessaire jusqu'à ce que « CLOCK OFF » ou « CLOCK ON » apparaisse sur l'afficheur.

- ⇨ Pressez la touche **⏪** ou **⏩** (8) pour changer de mode.

Une fois le réglage effectué,

- ⇨ pressez la touche **MENU** (8).





SON ET RÉPARTITION DU VOLUME

Son et répartition du volume

Régler les graves

Pour régler les graves (BASS),

- ⇨ pressez la touche **AUDIO** ⑩.

« BAS » apparaît sur l'afficheur.

Pour amplifier les graves,

- ⇨ tournez le bouton de réglage du volume ③ vers la droite.

Pour réduire les graves,

- ⇨ tournez le bouton de réglage du volume ③ vers la gauche.

Une fois le réglage effectué,

- ⇨ attendez 8 secondes jusqu'à ce que le réglage soit mémorisé et la source audio apparaisse sur l'afficheur.

Régler les aigus

Pour régler les aigus (TREBLE),

- ⇨ pressez la touche **AUDIO** ⑩ jusqu'à ce que « TRE » apparaisse sur l'afficheur.

Pour amplifier les aigus,

- ⇨ tournez le bouton de réglage du volume ③ vers la droite.

Pour réduire les aigus,

- ⇨ tournez le bouton de réglage du volume ③ vers la gauche.

Une fois le réglage effectué,

- ⇨ attendez 8 secondes jusqu'à ce que le réglage soit mémorisé et la source audio apparaisse sur l'afficheur.

Régler la balance

Pour régler la répartition du volume vers la droite / la gauche (balance),

- ⇨ pressez la touche **AUDIO** ⑩ autant de fois que nécessaire jusqu'à ce que « BAL » apparaisse.

Pour régler la répartition du volume vers la droite,

- ⇨ tournez le bouton de réglage du volume ③ vers la droite.

Pour régler la répartition du volume vers la gauche,

- ⇨ tournez le bouton de réglage du volume ③ vers la gauche.

Une fois le réglage effectué,

- ⇨ attendez 8 secondes jusqu'à ce que le réglage soit mémorisé et la source audio apparaisse sur l'afficheur.

Régler le fader

Pour régler la répartition du volume vers l'avant / l'arrière (fader),

- ⇨ pressez la touche **AUDIO** ⑩ autant de fois que nécessaire jusqu'à ce que « FAD » apparaisse sur l'afficheur.

Pour régler la répartition du volume vers l'arrière,

- ⇨ tournez le bouton de réglage du volume ③ vers la droite.

Pour régler la répartition du volume vers l'avant,

- ⇨ tournez le bouton de réglage du volume ③ vers la gauche.





ÉGALISEUR ET X-BASS

Une fois le réglage effectué,

- ⇨ attendez 8 secondes jusqu'à ce que le réglage soit mémorisé et la source audio apparaisse sur l'afficheur.

Égaliseur et X-BASS

X-BASS

La fonction X-BASS amplifie les sons graves à faible volume.

Pour activer la fonction X-BASS,

- ⇨ maintenez la touche **EQ/ X-BASS** ⁽¹¹⁾ jusqu'à ce que « XBASS ON » apparaisse sur l'afficheur.

« X-BASS » est allumé sur l'afficheur.

Pour désactiver la fonction X-BASS,

- ⇨ maintenez la touche **EQ/ X-BASS** ⁽¹¹⁾ jusqu'à ce que « X-BASS OFF » apparaisse sur l'afficheur.

X-BASS s'éteint sur l'afficheur.

Sélectionner une ambiance sonore

Vous avez la possibilité de choisir des ambiances sonores prédéfinies pour les styles de musique suivants:

- CLASSIC
- POP M
- ROCK M

Les fonctions pour ces styles de musique sont définies par défaut.

Pour choisir l'une des ambiances sonores,

- ⇨ pressez la touche **EQ/X-BASS** ⁽¹¹⁾ autant de fois que nécessaire jusqu'à ce que l'ambiance sonore voulue apparaisse sur l'afficheur.

Pour désactiver une ambiance sonore,

- ⇨ pressez la touche **EQ/X-BASS** ⁽¹¹⁾ autant de fois que nécessaire jusqu'à ce que « DSP OFF » apparaisse sur l'afficheur.





CARACTÉRISTIQUES TECHNIQUES

Caractéristiques techniques

Amplificateur

Puissance de sortie:

St. Louis C32: puissance sinu-
soïdale
4 x 22 watts se-
lon DIN 45 324,
14,4 V
puissance ma-
ximale 4 x 50
watts

Lexington C32: puissance sinu-
soïdale
4 x 15 watts se-
lon DIN 45 324,
14,4 V
puissance ma-
ximale 4 x 40
watts

Tuner

Gammes d'ondes US:

FM: 87,5 - 107,9 MHz

AM: 530 - 1710 kHz

Sensibilité FM mono:

15 dBf

Bande passante FM:

35 - 16 000 Hz

CC

Bande passante:

30 - 18 000 Hz

Sortie préampli

(pas pour St. Louis C32)



Sortie: $1,5 V_{rms} \pm 2,5 \text{ dB}$

Sous réserve de modifications!





ELEMENTOS DE MANDO

- ① Tecla  para desbloquear el frontal extraíble
- ② Tecla para encender y apagar el equipo
- ③ Regulador del volumen
- ④ Tecla  para expulsar la cinta
- ⑤ Compartimento para cinta
- ⑥ Tecla **FR**, bobinado rápido
- ⑦ Tecla **FF**, bobinado rápido
- ⑧ Bloque de teclas con flechas
Tecla **MENU**, para abrir el menú de los ajustes básicos
- ⑨ Tecla **SOURCE** para seleccionar entre CC, radio, cambiadis-cos
- ⑩ Tecla **AUDIO**, para ajustar los graves y agudos y la distribu-ción del volumen (balance y fader)
- ⑪ Pulsación breve: Tecla **EQ**, para seleccionar ajustes predetermi-nados del sonido
Pulsación prolongada: Tecla **X-BASS**, función X-Bass
- ⑫ Bloque de teclas **1 - 6**
- ⑬ Pulsación breve: Tecla **BAND**, para seleccionar los niveles de memoria FM y la banda de ondas AM, selección del modo de radio
Pulsación prolongada: Tecla **TS**, para iniciar la función Tra-velstore
- ⑭ Tecla , para seleccionar la indicación de la hora en la pan-talla





INDICE

Indicaciones y accesorios33
 Seguridad durante la conducción... 33
 Instalación 33
 Accesorios 33

**Unidad de mando
 (Frontal extraíble)34**
 Seguro antirrobo..... 34
 Extraer la unidad de mando..... 34
 Colocar la unidad de mando 34

Encender y apagar el equipo ..35

Regular el volumen35
 Regular el volumen de encendido... 35
 Bajar repentinamente el volumen
 (mute)..... 35
 Supresión del sonido durante el
 modo de teléfono..... 36

Modo de radio36

Activar el modo de radio 36
 Seleccionar la banda de ondas/
 el nivel de memoria 36
 Sintonizar emisoras..... 37
 Modificar la sensibilidad de la
 sintonización automática 37
 Memorizar emisoras..... 37
 Memorización automática
 (Travelstore) 37
 Escuchar emisoras memorizadas ... 37

Modo de cinta.....38

Reproducir una cinta..... 38
 Cambiar la cara de la cinta..... 38
 Bobinado rápido 38
 Expulsar la cinta..... 38

Modo de cambiadiscos39

Activar el modo de cambiadiscos... 39
 Seleccionar un CD 39
 Seleccionar títulos 39
 Búsqueda rápida (audible) 39
 Repetir títulos o CD's enteros
 (REPEAT) 39
 Reproducir títulos en orden
 aleatorio (MIX) 40
 Explorar todos los títulos de todos
 los CD's (SCAN) 40
 Detener la reproducción (PAUSE).. 40

Reloj - Hora41

Ver la hora 41
 Ajustar la hora..... 41
 Seleccionar el formato de 12/24 h. 41
 Ver la hora con el equipo apagado
 y el encendido del vehículo
 conectado 41

**Tono y distribución del
volumen.....42**

Regular los graves 42
 Regular los agudos 42
 Ajustar el valor de balance 42
 Ajustar el valor de fader 42

Ecuilizador y X-BASS43

X-BASS 43
 Seleccionar ajustes
 predeterminados del sonido..... 43

Datos técnicos44

Amplificador 44
 Sintonizador..... 44
 CC 44
 Salida de preamplificador
 (Pre-amp Out) 44

Instrucciones de instalación ...72





INDICACIONES Y ACCESORIOS

Muchas gracias por haberse decidido por un producto de la marca Blaupunkt. Esperamos que disfrute de su nuevo equipo.

Antes de usarlo, lea detenidamente el manual de instrucciones. Los redactores de Blaupunkt han puesto todo su empeño en crear un manual de instrucciones claro y comprensible. No obstante, si tiene alguna duda, póngase en contacto con su proveedor o llame a la línea de atención al cliente de su país. El número de teléfono lo encontrará al final de este manual.

Seguridad durante la conducción

 ¡La seguridad vial tiene prioridad absoluta! Maneje su equipo de radio únicamente si la situación del tráfico lo permite. Familiarícese con él y con la forma de manejarlo antes de comenzar el viaje.

Las señales de alarma de la policía, de los bomberos o de los equipos de salvamento, han de poder escucharse a tiempo dentro del vehículo. Por ello, escuche su programa a un volumen moderado cuando esté circulando.

Instalación

Si Vd. mismo desea realizar la instalación de su radio, lea las instrucciones de instalación y conexión que se encuentran al final de este manual.

Accesorios

Utilice únicamente accesorios autorizados por Blaupunkt.

Mando a distancia

Para el equipo Lexington C32 se puede adquirir el mando a distancia opcional RC 04.

El equipo St. Louis C32 no se puede manejar a distancia.

Amplificador

Se pueden utilizar todos los amplificadores Blaupunkt y Velocity.

Cambiadiscos (Changer)

Al equipo Lexington C32 se puede conectar el cambiadiscos CDC A 01 (7607 700 022) de Blaupunkt.

Al equipo St. Louis C32 no se puede conectar ningún cambiadiscos.

ESPAÑOL





UNIDAD DE MANDO (FRONTAL EXTRAÍBLE)

Unidad de mando (Frontal extraíble)

Seguro antirrobo

Su equipo está dotado de una unidad de mando desmontable (frontal extraíble) que sirve de seguro antirrobo. Sin ella, el equipo no tiene ningún valor para los ladrones.

Asegure su equipo contra los ladrones y llévese la unidad de mando siempre que salga del vehículo. No la deje en su interior, ni siquiera escondida.

El diseño constructivo de la unidad de mando permite manejarla con toda facilidad.

Nota:

- No deje caer la unidad de mando.
- No la exponga a la radiación solar directa ni a ninguna otra fuente de calor.
- Evite el contacto directo de los contactos que tiene la unidad de mando con la piel. En caso necesario, limpie los contactos con un paño impregnado en alcohol que no suelte pelusa.

Extraer la unidad de mando

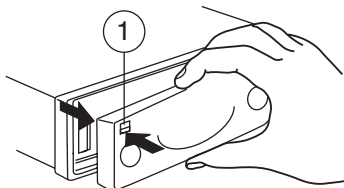

⇨ Pulse la tecla **iv** ①.

Al hacerlo, se suelta el bloqueo de la unidad de mando.

⇨ Extraiga la unidad de mando, tirando primero de ella hacia Vd. y después a la izquierda.

- El equipo se apaga nada más retirar la unidad de mando.
- Todos los valores seleccionados quedan memorizados.
- En caso de haber un CD en la unidad, éste permanece en ella.

Colocar la unidad de mando

⇨ Coloque la unidad de mando en el equipo introduciéndola en la guía de izquierda a derecha.

⇨ Oprima sobre el lado izquierdo de la unidad de mando hasta que quede encajada.

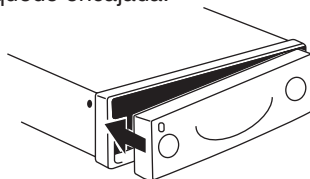

Nota:

- Para colocar la unidad de mando, no haga fuerza sobre la pantalla.

Si el equipo estaba encendido al extraer la unidad de mando, al volver a colocarla se activan automáticamente los últimos valores seleccionados para la radio, el CC o el cambiadiscos (cambiadiscos sólo con el modelo Lexington C32).





ENCENDER Y APAGAR EL EQUIPO

Encender y apagar el equipo

Para encender y apagar el equipo, Vd. tiene las siguientes posibilidades:

Encender y apagar el equipo con el encendido del vehículo

Si el equipo está debidamente conectado al encendido del vehículo y no lo apagó previamente con la tecla (2), podrá encenderlo y apagarlo con el encendido del vehículo

Encender y apagar el equipo con la unidad de mando

⇨ Extraiga la unidad de mando.

El equipo se apaga.

⇨ Vuelva a colocar la unidad de mando.

El equipo se enciende. Simultáneamente se activan los últimos valores seleccionados para la radio, el CC o el cambiadiscos (cambiadiscos sólo con el modelo Lexington C32).

Encender y apagar el equipo con la tecla (2)

⇨ Para encender el equipo, pulse la tecla (2).

El equipo sólo se puede encender con el encendido del vehículo conectado.

⇨ Para apagarlo, mantenga oprimida la tecla (2) durante más de dos segundos.

El equipo se apaga.

REGULAR EL VOLUMEN

Regular el volumen

El volumen del sistema se puede regular en pasos de 0 (desactivado) a 100 (máximo).

Para subir el volumen del sistema,

⇨ gire el regulador del volumen (3) a la derecha.

Para bajar el volumen,

⇨ gire el regulador del volumen (3) a la izquierda.

Regular el volumen de encendido

Vd. puede regular el volumen que tienen el equipo al encenderlo.

⇨ Pulse la tecla **MENU** (8).

⇨ Pulse repetidas veces la tecla **▲** o **▼** (8) hasta que en la pantalla aparezca la indicación "ON VOL".

⇨ Ajuste el volumen de encendido con las teclas **<>** (8).

Para orientarse mejor, el volumen sube y baja durante la operación conforme al valor ajustado.

Cuando haya terminado la operación de ajuste,

⇨ pulse dos veces la tecla **MENU** (8).

Bajar repentinamente el volumen (mute)

Vd. puede bajar repentinamente el volumen hasta un valor establecido previamente (mute).





REGULAR EL VOLUMEN

- ⇨ Pulse brevemente la tecla ②.

En la pantalla se muestra la indicación "MUTE".

Ajustar el volumen para la función MUTE

Vd. puede regular el volumen de la supresión del sonido (Mute Level).

- ⇨ Pulse la tecla **MENU** ⑧.
- ⇨ Pulse repetidas veces la tecla **↵** o **⏏** ⑧ hasta que en la pantalla aparezca la indicación "MUTE LVL".
- ⇨ Ajuste el nivel de la supresión del sonido con las teclas **<>** ⑧.

Cuando haya terminado la operación de ajuste,

- ⇨ pulse dos veces la tecla **MENU** ⑧.

Supresión del sonido durante el modo de teléfono

Si su equipo tiene conectado un teléfono móvil, al "descolgar" el teléfono se suprime el sonido de la radio. En la pantalla parpadea la indicación "TEL CALL".

Para que esto sea posible, es necesario conectar el teléfono móvil a la radio tal y como se indica en las instrucciones de montaje.

El sonido se reproduce con el volumen ajustado (Mute Level).

Modo de radio

Activar el modo de radio

Si se encuentra en el modo de CC o cambiadiscos (sólo con el modelo Lexington C32),

- ⇨ pulse repetidas veces la tecla **SOURCE** ⑨ hasta que en la pantalla aparezca el modo de radio con el nivel de memoria y la frecuencia.

Seleccionar la banda de ondas/ el nivel de memoria

Este equipo puede sintonizar programas de las bandas de frecuencia FM y AM. Para la banda de ondas FM hay tres niveles de memoria y para la banda AM uno. En cada nivel de memoria se pueden memorizar seis emisoras.

Seleccionar el nivel de memoria FM

Para cambiar entre los niveles de memoria FM1, FM2 y FMT,

- ⇨ pulse la tecla **BAND/TS** ⑬.

Seleccionar la banda de ondas AM

Para seleccionar la banda de ondas AM,

- ⇨ pulse repetidas veces la tecla **BAND/TS** ⑬ hasta que aparezca la opción AM en la pantalla.





MODO DE RADIO

Sintonizar emisoras

Existen varias posibilidades de sintonizar emisoras.

Sintonización automática

⇨ Pulse la tecla **V** o **⌂** (8).

La radio sintoniza la primera emisora que tenga suficiente intensidad.

Modificar la sensibilidad de la sintonización automática

Vd. puede elegir si desea sintonizar únicamente emisoras potentes o también emisoras de poca intensidad.

⇨ Pulse la tecla **MENU** (8).

⇨ Pulse repetidas veces la tecla **V** o **⌂** (8) hasta que en la pantalla aparezca la indicación "SENS HI" o "SENS LO".

"SENS HI" significa sensibilidad máxima y "SENS LO" significa sensibilidad mínima. Cuando está seleccionada la opción "SENS LO", luce "LOC" en la pantalla.

⇨ Seleccione la sensibilidad deseada con las teclas **<>** (8).

Cuando haya terminado la operación de ajuste,

⇨ pulse la tecla **MENU** (8).

Sintonización manual

Vd. también puede sintonizar emisoras manualmente.

⇨ Pulse la tecla **< o >** (8).

Memorizar emisoras

Memorización manual

⇨ Seleccione el nivel de memoria

FM deseado (FM1, FM2 o FMT) o la banda de ondas AM.

⇨ Sintonice la emisora que desea memorizar.

⇨ Mantenga pulsada durante más de 1 segundo la tecla de estación **1-6** (12) en la que desea memorizar la emisora.

Memorización automática (Travelstore)

Vd. puede memorizar automáticamente las seis emisoras más potentes de la región. Las emisoras quedan memorizadas en el nivel FMT o AM, dependiendo de cuál sea la banda de ondas seleccionada.

Nota:

- Las emisoras que ya estén memorizadas en ese nivel se borran.
- ⇨ Mantenga pulsada la tecla **BAND/TS** (13) hasta que comience la sintonización.

Comienza el proceso de memorización. Al concluir la operación, se exploran brevemente todas las emisoras memorizadas.

Escuchar emisoras memorizadas

⇨ Seleccione el nivel de memoria en el que almacenó la emisora que desea escuchar.

⇨ Pulse la tecla de estación **1-6** (12) correspondiente a la emisora que desea seleccionar.





MODO DE CINTA

Modo de cinta

Reproducir una cinta

- Si aún no hay ninguna cinta en el equipo,
- ⇒ introduzca la cinta en el compartimento (5), con el lado abierto mirando hacia la derecha y la cara A/1 hacia arriba.

La cinta comienza a sonar por la cara que está mirando hacia arriba (cara A/1). En la pantalla luce el símbolo de la cinta.

- Si ya hay una cinta en el equipo,
- ⇒ pulse repetidas veces la tecla **SOURCE** (9) hasta que en la pantalla aparezca la indicación "TAPE".

La cinta comienza a sonar en la dirección seleccionada en último lugar.

Cambiar la cara de la cinta

- ⇒ Mantenga oprimidas simultáneamente las teclas **FR** (6) y **FF** (7).

El sentido de movimiento de la cinta cambia a la otra cara.

Al llegar al final de la cinta, el equipo cambia automáticamente a la otra cara (Autoreverse).

Bobinado rápido

Avance rápido

- Para un avance rápido de la cara A/1,
- ⇒ pulse la tecla **FF** (7) de modo que quede encajada.
- Para un avance rápido de la cara B/2,

- ⇒ pulse la tecla **FR** (6) de modo que quede encajada.

En la pantalla aparece "TAPE FF".

Retroceso rápido

- Para un retroceso rápido de la cara A/1,
- ⇒ pulse la tecla **FR** (6) de modo que quede encajada.

- Para un retroceso rápido de la cara B/2,

- ⇒ pulse la tecla **FF** (7) de modo que quede encajada.

En la pantalla aparece "TAPE FR".

Finalizar el bobinado

- ⇒ Pulse la tecla de bobinado opuesta.

La reproducción continúa.

Expulsar la cinta

- ⇒ Pulse la tecla Δ (4) para expulsar la cinta del equipo.





MODO DE CAMBIADISCOS

Modo de cambiadiscos

Puede conectar un cambiadiscos al equipo Lexington C32. Para más información sobre los cambiadiscos disponibles, consulte con su comercio especializado.

Nota:

- Para más detalles sobre la manera de manejar los CDs, de colocarlos en el cambiadiscos y de manejar este último, consulte las instrucciones del cambiadiscos.

Activar el modo de cambiadiscos

- ⇒ Pulse repetidas veces la tecla **SOURCE**  hasta que en la pantalla aparezca, p. ej., "CDC 1--1".

El primer número de la indicación TA corresponde al del CD (en este caso: 1). El segundo número corresponde al del título (en este caso: 1).

La reproducción comienza con el primer CD detectado por el cambiadiscos.

Seleccionar un CD

Para cambiar a otro CD anterior o siguiente,

- ⇒ pulse la tecla **⏮** o **⏭**  una o varias veces.

Seleccionar títulos

Para cambiar a otro título anterior o siguiente del CD seleccionado,

- ⇒ pulse la tecla **⏪** o **⏩**  una o varias veces.

Búsqueda rápida (audible)

Para realizar una búsqueda rápida hacia delante o hacia atrás,

- ⇒ mantenga oprimida una de las teclas **<>**  hasta que comience la búsqueda rápida.

Repetir títulos o CD's enteros (REPEAT)

Para repetir el título seleccionado en esos momentos,

- ⇒ pulse brevemente la tecla **3 (RPT)** .

En la pantalla aparece brevemente "S--RPT".

Para repetir el CD seleccionado en esos momentos,

- ⇒ mantenga pulsada la tecla **3 (RPT)**  durante más de dos segundos.

En la pantalla aparece brevemente "D--RPT".

Finalizar la función REPEAT

Para finalizar la repetición del título o CD que está sonando,

- ⇒ pulse la tecla **3 (RPT)**  hasta que el símbolo "S--RPT" o "D--RPT" deje de lucir y vuelva a aparecer la indicación normal de cambiadiscos en la pantalla.





MODO DE CAMBIADISCOS

Reproducir títulos en orden aleatorio (MIX)

Para reproducir en orden aleatorio todos los títulos del CD seleccionado,

⇨ pulse brevemente la tecla **4 (MIX)** ⁽¹²⁾.

En la pantalla aparece brevemente "S--MIX".

Para reproducir en orden aleatorio los títulos de todos los CD's,

⇨ mantenga pulsada la tecla **4 (MIX)** ⁽¹²⁾ durante más de dos segundos.

En la pantalla aparece brevemente "D--MIX".

Finalizar la función MIX

Para finalizar la reproducción aleatoria de los títulos,

⇨ pulse la tecla **4 (MIX)** ⁽¹²⁾ hasta que el símbolo "S--MIX" o "D--MIX" deje de lucir y vuelva a aparecer la indicación normal de cambiadiscos en la pantalla.

Explorar todos los títulos de todos los CD's (SCAN)

Reproducir los títulos del disco seleccionado

Para explorar brevemente en orden sucesivo todos los títulos del disco seleccionado,

⇨ pulse la tecla **2 (SCAN)** ⁽¹²⁾.

En la pantalla aparece "S--SCN".

Explorar el primer título de todos los discos

Vd. puede reproducir brevemente ("explorar") el primer título de todos los CD's que se encuentran en el cambiadiscos.

⇨ mantenga pulsada la tecla **2 (SCAN)** ⁽¹²⁾ durante más de dos segundos.

En la pantalla aparece "D--SCAN".

Finalizar la función SCAN

Para terminar la exploración,

⇨ vuelva a pulsar brevemente la tecla **2 (SCAN)** ⁽¹²⁾.

El título que está sonando sigue reproduciéndose.

Nota:

- El tiempo de exploración puede modificarlo si lo desea. Para más detalles, lea el punto "Seleccionar el tiempo de exploración" en el capítulo "Modo de CD".

Detener la reproducción (PAUSE)

⇨ Pulse la tecla **1 (▶)** ⁽¹²⁾.

En la pantalla aparece "S--PAUSE".

Cancelar la función de pausa

⇨ Pulse la tecla **2 (▶)** ⁽¹²⁾ durante la pausa.

La reproducción continúa.





RELOJ - HORA

Reloj - Hora

Ver la hora

Para ver la hora,

- ⇨ pulse brevemente la tecla **⏸** (14).

Ajustar la hora

- ⇨ Pulse la tecla **MENU** (8).
- ⇨ Pulse repetidas veces la tecla **↶** o **↷** (8) hasta que en la pantalla aparezca la indicación "CLOCK-SET".
- ⇨ Pulse la tecla **>** (8).

La hora se muestra en la pantalla. Los minutos parpadean, lo que significa que se pueden modificar.

- ⇨ Ajuste los minutos con las teclas **↶/↷** (8).

Una vez ajustados los minutos,

- ⇨ pulse la tecla **<** (8).

Las horas parpadean.

- ⇨ Ajuste las horas con las teclas **↶/↷** (8).

Cuando haya terminado la operación de ajuste,

- ⇨ pulse dos veces la tecla **MENU** (8).

Seleccionar el formato de 12/24 h

- ⇨ Pulse la tecla **MENU** (8).
- ⇨ Pulse repetidas veces la tecla **↶** o **↷** (8) hasta que en la pantalla aparezca la indicación "24 H MODE" o "12 H MODE".
- ⇨ Pulse la tecla **< o >** (8) para cambiar de formato.

Cuando haya terminado la operación de ajuste,

- ⇨ pulse la tecla **MENU** (8).

Ver la hora con el equipo apagado y el encendido del vehículo conectado

Para ver la hora con el equipo y el encendido del vehículo conectado,

- ⇨ pulse la tecla **MENU** (8).
- ⇨ Pulse repetidas veces la tecla **↶** o **↷** (8) hasta que en la pantalla aparezca la indicación "CLOCK OFF" o "CLOCK ON".
- ⇨ Pulse la tecla **< o >** (8) para elegir la indicación.

Cuando haya terminado la operación de ajuste,

- ⇨ pulse la tecla **MENU** (8).





TONO Y DISTRIBUCIÓN DEL VOLUMEN

Tono y distribución del volumen

Regular los graves

Para ajustar los tonos graves (BASS),

⇨ pulse la tecla **AUDIO** ⁽¹⁰⁾.

En la pantalla se muestra la indicación "BASS".

Para aumentar el valor de los tonos graves,

⇨ gire el regulador del volumen ⁽³⁾ a la derecha.

Para reducir el valor de los graves,

⇨ gire el regulador del volumen ⁽³⁾ a la izquierda.

Cuando haya terminado la operación de ajuste,

⇨ espere 8 segundos hasta que el nuevo valor esté memorizado y aparezca en la pantalla la fuente de sonido.

Regular los agudos

Para ajustar los tonos agudos (TREBLE),

⇨ pulse repetidas veces la tecla **AUDIO** ⁽¹⁰⁾ hasta que aparezca la indicación "TRE" en la pantalla.

Para aumentar el valor de los tonos agudos,

⇨ gire el regulador del volumen ⁽³⁾ a la derecha.

Para reducir el valor de los agudos,

⇨ gire el regulador del volumen ⁽³⁾ a la izquierda.

Cuando haya terminado la operación de ajuste,

⇨ espere 8 segundos hasta que el nuevo valor esté memorizado y aparezca en la pantalla la fuente de sonido.

Ajustar el valor de balance

Para ajustar la distribución del volumen a derecha / izquierda (balance),

⇨ pulse repetidas veces la tecla **AUDIO** ⁽¹⁰⁾ hasta que aparezca la indicación "BAL" en la pantalla.

Para distribuir el volumen a la derecha,

⇨ gire el regulador del volumen ⁽³⁾ a la derecha.

Para distribuir el volumen a la izquierda,

⇨ gire el regulador del volumen ⁽³⁾ a la izquierda.

Cuando haya terminado la operación de ajuste,

⇨ espere 8 segundos hasta que el nuevo valor esté memorizado y aparezca en la pantalla la fuente de sonido.

Ajustar el valor de fader

Para ajustar la distribución del volumen delante/detrás (fader),

⇨ pulse repetidas veces la tecla **AUDIO** ⁽¹⁰⁾ hasta que aparezca la indicación "FAD" en la pantalla.

Para trasladar la distribución del volumen hacia atrás,

⇨ gire el regulador del volumen ⁽³⁾ a la derecha.





TONO Y DISTRIBUCIÓN DEL VOLUMEN

Para trasladar la distribución del volumen hacia delante,

- ⇨ gire el regulador del volumen ③ a la izquierda.

Cuando haya terminado la operación de ajuste,

- ⇨ espere 8 segundos hasta que el nuevo valor esté memorizado y aparezca en la pantalla la fuente de sonido.

ECUALIZADOR Y X-BASS

Ecualizador y X-BASS

X-BASS

X-Bass significa un realce de los tonos graves a un volumen reducido.

Para activar la función X-BASS,

- ⇨ mantenga oprimida la tecla **EQ/ X-BASS** ⑪ hasta que en la pantalla aparezca la indicación “XBASS ON”.

En la pantalla luce la indicación “X-BASS”.

Para desactivar la función X-BASS,

- ⇨ mantenga oprimida la tecla **EQ/ X-BASS** ⑪ hasta que en la pantalla aparezca la indicación “XBASS OFF”.

La indicación “X-BASS” se apaga.

Seleccionar ajustes predeterminados del sonido

Vd. puede seleccionar ajustes predeterminados del sonido para los siguientes estilos musicales:

- CLASSIC
- POP M
- ROCK M

Los ajustes para estos estilos ya están programados en el equipo.

Para seleccionar uno de los ajustes predeterminados,

- ⇨ pulse repetidas veces la tecla **EQ/X-BASS** ⑪ hasta que en la pantalla aparezca la opción deseada.





ECUALIZADOR Y X-BASS

Si desea desactivar el ajuste predefinido,

- ☞ pulse repetidas veces la tecla **EQ/X-BASS** ⁽¹¹⁾ hasta que en la pantalla aparezca la indicación "DSP OFF".

DATOS TÉCNICOS

Datos técnicos

Amplificador

Potencia de salida:

St. Louis C32:	4 x 22 vatios sinusoidal según DIN 45 324 a 14,4 V 4 x 50 vatios de potencia máxima
Lexington C32:	4 x 15 vatios sinusoidal según DIN 45 324 a 14,4 V 4 x 40 vatios de potencia máxima

Sintonizador

Bandas de ondas EE.UU.:

FM:	87,5 - 107,9 MHz
AM:	530 - 1710 kHz

Sensibilidad FM mono:

15 dBf

Respuesta FM: 35 - 16.000 Hz

CC

Respuesta: 30 - 18.000 Hz

Salida de preamplificador (Pre-amp Out)

(no en St. Louis C32)

Salida: 1,5 V_{rms} ± 2,5 dB

¡Salvo modificaciones!





ELEMENTOS DE COMANDO

- ① Tecla **LV**, para destravar o painel frontal destacável
- ② Tecla para ligar/desligar o aparelho
- ③ Regulador do volume
- ④ Δ Ejeção da cassete
- ⑤ Compartimento da cassete
- ⑥ Tecla **FR**, bobinagem rápida da fita
- ⑦ Tecla **FF**, bobinagem rápida da fita
- ⑧ Bloco das teclas de seta
Tecla **MENU**, abrir o menu para regular os ajustes básicos.
- ⑨ Tecla **SOURCE**, comutar entre as fontes de CC, rádio e leitor Multi-CD
- ⑩ Tecla **AUDIO**, regular os graves, agudos e a relação do volume (“balance” e “fader”)
- ⑪ Toque curto: tecla **EQ**, seleccionar os padrões pré-ajustados para o som
Toque longo: **X-BASS**, função X-Bass
- ⑫ Bloco de teclas **1 - 6**
- ⑬ Toque curto: tecla **BAND**, seleccionar os níveis da memória FM e a banda AM, seleccionar o modo do rádio
Toque longo: **TS**, iniciar a função Travelstore
- ⑭ Tecla \odot , visualizar a hora no visor





ÍNDICE

Informações e acessórios.....	47	Modo de leitor Multi-CD	53
Segurança na estrada.....	47	Iniciar o modo do leitor Multi-CD....	53
Montagem	47	Seleccionar um CD	53
Acessórios	47	Seleccionar uma faixa	53
Painel frontal destacável	48	Busca rápida (com som).....	53
Protecção anti-roubo	48	Repetição de faixas individuais ou	
Retirar o painel frontal.....	48	de CDs completos (REPEAT)	53
Colocar o painel frontal.....	48	Leitura das faixas numa ordem	
Ligar/Desligar.....	49	aleatória (MIX)	54
Regular o volume	49	Tocar o início de todas as faixas	
Regular o volume inicial	49	de cada CD (SCAN).....	54
Baixar o volume repentinamente		Interromper a reprodução	
(Mute).....	49	(PAUSE).....	54
Silenciador do rádio durante um		CLOCK - Relógio	55
telefonema.....	50	Fazer exibir a hora	55
Modo do rádio	50	Acertar o relógio.....	55
Ligar o modo do rádio.....	50	Seleccionar o modo do relógio	
Seleccionar a banda de ondas /		de 12/24 horas	55
o nível de memória.....	50	Fazer exibir a hora com o aparelho	
Sintonizar as estações	50	desligado e a ignição ligada	55
Seleccionar a sensibilidade da		Som e relação do volume	56
sintonia de estações	51	Regular os graves.....	56
Memorizar as estações	51	Regular os agudos.....	56
Memorizar as estações		Regular a função "balance"	56
automaticamente (Travelstore)	51	Regular a função "fader"	56
Seleccionar uma estação		Equalizador e X-BASS.....	57
memorizada	51	X-BASS	57
Modo de cassete	52	Escolher os padrões	
Reprodução de cassete	52	pré-ajustados para o som.....	57
Alterar o lado de leitura	52	Dados técnicos	58
Bobinagem rápida da fita	52	Amplificador	58
Ejecção da cassete.....	52	Sintonizador.....	58
		CC	58
		Pre-Amp Out	58
		Instruções de montagem	72





INFORMAÇÕES E ACESSÓRIOS

Muito obrigado por se ter decidido por um produto da Blaupunkt. Desejamos-lhe muito prazer com o seu aparelho novo.

Antes de utilizar o aparelho pela primeira vez, queira ler estas instruções de serviço. Os redactores da Blaupunkt procuram aperfeiçoar constantemente as instruções de serviço com vista a torná-las bem acessíveis e compreensíveis. Se, não obstante, continuar com dúvidas acerca do comando do aparelho, queira dirigir-se ao seu revendedor especializado ou contacte a linha azul no seu país. Encontrará o número de telefone no verso deste caderno.

Segurança na estrada

 A segurança na estrada tem prioridade máxima. Manipule o seu auto-rádio só quando a situação do trânsito o permitir. Familiarize-se com o funcionamento do aparelho antes de iniciar a viagem.

Terá que estar em condições de ouvir, a tempo, os sinais da polícia, dos bombeiros e das ambulâncias no interior do automóvel. Por conseguinte, ouça o seu programa sempre num volume adequado à situação.

Montagem

Se pretender instalar você mesmo o seu auto-rádio, leia as instruções de instalação e de ligação no fim destas instruções.

Acessórios

Utilize apenas os acessórios admitidos pela Blaupunkt.

Telecomando

O telecomando RC 04 está disponível opcionalmente para o aparelho Lexington C32.

O aparelho St. Louis C32 não pode ser comandado à distância.

Amplificador

Podem utilizar-se todos os amplificadores da Blaupunkt/Velocity.

Leitor Multi-CD (changer)

O aparelho Lexington C32 pode ser ligado ao leitor Multi-CD CDC A 01 da Blaupunkt (7607 700 022).

O aparelho St. Louis C32 não pode ser ligado a qualquer leitor Multi-CD.





PAINEL FRONTAL DESTACÁVEL

Painel frontal destacável

Protecção anti-roubo

O seu aparelho está equipado com um painel frontal destacável (Release Panel) que o protege contra roubo. Sem este painel frontal, o aparelho não tem valor algum para um ladrão. Proteja o seu aparelho contra roubo levando o painel frontal sempre consigo quando deixar o automóvel. Não deixe o painel frontal no automóvel, nem mesmo em lugar escondido. A concepção construtiva específica do painel frontal facilita-lhe a remoção e colocação do mesmo.

Nota:

- Não deixe o painel frontal cair ao chão.
- Nunca exponha o painel frontal à luz solar directa ou a outras fontes de calor.
- Evite tocar com a pele directamente nas superfícies de contacto do painel frontal. Caso necessário, limpe os contactos com um pano embebido em álcool, que não largue pêlos.

Retirar o painel frontal

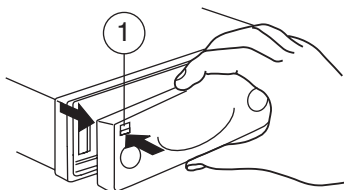

- ⇨ Prima a tecla  ①.

A trava do painel frontal é aberta.

- ⇨ Retire o painel frontal puxando-o

primeiro para a frente e depois para a esquerda.

- Uma vez retirado o painel frontal, o aparelho desliga automaticamente.
- Todos os ajustes seleccionados são memorizados.
- Se estiver um CD no compartimento, este permanece no aparelho.

Colocar o painel frontal

- ⇨ Meta o painel frontal na calha de guia e deslize-o da esquerda para a direita.
- ⇨ Empurre o lado esquerdo do painel frontal para dentro do aparelho até engatar.

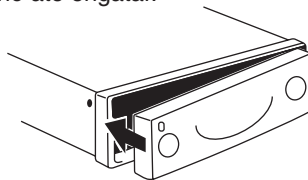

Nota:

- Ao colocar o painel frontal no aparelho, não carregue no visor.

Se o aparelho estiver ligado no momento em que retira o painel frontal, ele volta a ligar automaticamente no modo por último seleccionado, ou seja, rádio, CC ou Multi-CD (leitor Multi-CD só no Lexington C32), logo que voltar a colocar o painel frontal.





LIGAR/DESLIGAR

Ligar/Desligar

Há várias possibilidades para ligar e desligar o aparelho:

Ligar/Desligar através da ignição do automóvel

Se o aparelho estiver correctamente conectado à ignição do automóvel e se não tiver sido desligado com a tecla **(2)**, ele é ligado e desligado juntamente com a ignição.

Ligar/Desligar com o painel frontal destacável

⇨ Retire o painel frontal.

O aparelho é desligado.

⇨ Volte a colocar o painel frontal.

O aparelho é ligado. O último modo seleccionado antes de desligar o aparelho volta a ser activado, ou seja, rádio, CC ou Multi-CD (leitor Multi-CD só no Lexington C32).

Ligar/Desligar com a tecla **(2)**

⇨ Para ligar, prima a tecla **(2)**.

Só é possível ligar o aparelho enquanto a ignição estiver ligada.

⇨ Para desligar, mantenha a tecla **(2)** premida por mais de dois segundos.

O aparelho é desligado.

REGULAR O VOLUME

Regular o volume

O volume do sistema pode ser regulado em passos de 0 (desligado) a 100 (máximo).

Para aumentar o volume do sistema,
⇨ rode o regulador do volume **(3)** para a direita.

Para baixar o volume,
⇨ rode o regulador do volume **(3)** para a esquerda.

Regular o volume inicial

O volume em que o aparelho deve tocar ao ser ligado pode ser regulado.

⇨ Prima a tecla **MENU** **(8)**.

⇨ Prima as vezes necessárias a tecla **↶** ou **↷** **(8)** até "ON VOL" aparecer no visor.

⇨ Regule o volume inicial com as teclas **<>** **(8)**.

Para uma melhor orientação, durante a regulação do volume, este é aumentado e baixado de acordo com os valores regulados.

Quando tiver terminado o ajuste,

⇨ prima duas vezes a tecla **MENU** **(8)**.

Baixar o volume repentinamente (Mute)

O volume pode ser baixado repentinamente para um valor pré-definido por si (Mute).

⇨ Prima por um período curto a tecla **(2)**.

"MUTE" é indicado no visor.





REGULAR O VOLUME

Regular o volume do silenciador

O volume do silenciador (Mute Level) pode ser regulado.

- ⇨ Prima a tecla **MENU** (8).
- ⇨ Prima as vezes necessárias a tecla **⏏** ou **⏏** (8) até "MUTE LVL" aparecer no visor.
- ⇨ Regule o volume do silenciador com as teclas **<>** (8).

Quando tiver terminado o ajuste,

- ⇨ prima duas vezes a tecla **MENU** (8).

Silenciador do rádio durante um telefonema

Se o seu aparelho estiver ligado a um telemóvel, o volume do auto-rádio é suprimido automaticamente ao receber ou fazer uma chamada telefónica. "TEL CALL" pisca no visor.

Para o efeito, é necessário que o telemóvel esteja ligado ao auto-rádio conforme descrito nas instruções de instalação.

O volume do silenciador (Mute Level) é baixado para o volume anteriormente regulado.

MODO DO RÁDIO

Modo do rádio

Ligar o modo do rádio

Se o aparelho se encontrar nos modos de funcionamento CC ou Multi-CD (leitor Multi-CD só no Lexington C32),

- ⇨ prima as vezes necessárias a tecla **SOURCE** (9) até o visor indicar o nível da memória e a frequência no modo do rádio.

Seleccionar a banda de ondas / o nível de memória

Este aparelho permite-lhe captar os programas transmitidos nas bandas de frequência FM e AM. Para a banda FM, estão disponíveis três níveis diferentes na memória e, para a banda AM, um nível. Em cada nível podem ser guardadas seis estações diferentes.

Seleccionar um nível da memória FM

Para comutar entre os vários níveis da memória FM (FM1, FM2 e FMT),

- ⇨ prima a tecla **BAND/TS** (13).

Seleccionar a banda AM

Para seleccionar a banda AM,

- ⇨ prima as vezes necessárias a tecla **BAND/TS** (13) até AM aparecer no visor.

Sintonizar as estações

Há várias possibilidades para sintonizar as estações.

Sintonia automática das estações

- ⇨ Prima a tecla **⏏** ou **⏏** (8).

O aparelho sintoniza a próxima estação que possa ser captada.





MODO DO RÁDIO

Seleccionar a sensibilidade da sintonia de estações

Esta função permite-lhe determinar se o aparelho deve sintonizar apenas estações com sinais fortes ou também estações com sinais fracos.

- ⇨ Prima a tecla **MENU** (8).
- ⇨ Prima as vezes necessárias a tecla **V** ou **⌂** (8) até “SENS HI” ou “SENS LO” aparecer no visor.

“SENS HI” significa sensibilidade máxima. “SENS LO” significa sensibilidade mínima. Quando seleccionar o valor “SENS LO”, a sigla “LOC” é apresentada no visor.

- ⇨ Regule a sensibilidade pretendida com as teclas **<>** (8).

Quando tiver terminado o ajuste,

- ⇨ prima a tecla **MENU** (8).

Sintonia manual das estações

A sintonia das estações também pode ser feita manualmente.

- ⇨ Prima a tecla **< ou >** (8).

Memorizar as estações

Memorizar as estações manualmente

- ⇨ Selecciona o nível de memória pretendido, FM1, FM2, FMT, ou a banda de ondas AM.
- ⇨ Sintonize a estação pretendida.
- ⇨ Prima a tecla de pré-sintonia **1-6** (12) na qual pretende guardar a estação e mantenha esta tecla premida por mais de um segundo.

Memorizar as estações automaticamente (Travelstore)

As seis estações com os sinais mais fortes da região podem ser guardadas automaticamente na memória. A memorização faz-se no nível FMT ou AM, conforme a banda de ondas que está seleccionada.

Nota:

- As estações memorizadas anteriormente neste nível serão apagadas.
- ⇨ Prima a tecla **BAND/TS** (13) e mantenha-a premida até o aparelho iniciar a busca.

A memorização é iniciada. Uma vez terminada a memorização, o aparelho toca, por um período curto, todas as estações guardadas na memória.

Seleccionar uma estação memorizada

- ⇨ Selecciona o nível no qual a estação foi guardada.
- ⇨ Prima a tecla de pré-sintonia **1-6** (12) correspondente à estação pretendida.





MODO DE CASSETE

Modo de cassete

Reprodução de cassete

- Se não estiver ainda nenhuma cassete no aparelho.
- ⇨ Empurre a cassete para dentro do compartimento da cassete (5), com o lado aberto virado para a direita e o lado A/ 1 virado para cima.

O aparelho começa a reproduzir a cassete do lado que mostra para cima (lado A/ 1). O símbolo de cassete acende-se no visor.

- Se já estiver uma cassete no aparelho.
- ⇨ Prima as vezes necessárias a tecla **SOURCE** (9) até "TAPE" aparecer no visor.

O aparelho reproduz a cassete no sentido por último seleccionado.

Alterar o lado de leitura

- ⇨ Prima simultaneamente as teclas para bobinagem da fita, **FR** (6) e **FF** (7).

O sentido de leitura é alterado.

Ao alcançar o fim da fita, o aparelho muda automaticamente o sentido de leitura (auto-reverso).

Bobinagem rápida da fita

Avanço rápido

- Para um avanço rápido do lado A/ 1,
 - ⇨ prima a tecla de bobinagem **FF** (7) até esta engatar.
- Para um avanço rápido do lado B/ 2,
 - ⇨ prima a tecla de bobinagem **FR** (6) até esta engatar.

O visor indica "TAPE FF".

Retrocesso rápido

- Para um retrocesso rápido do lado A/ 1,
 - ⇨ prima a tecla de bobinagem **FR** (6) até esta engatar.
- Para um retrocesso rápido do lado B/ 2,
 - ⇨ prima a tecla de bobinagem **FF** (7) até esta engatar.

O visor indica "TAPE FR".

Terminar a bobinagem da fita

- ⇨ Prima a tecla do sentido inverso.

A leitura é prosseguida.

Ejecção da cassete

- ⇨ Prima a tecla **△** (4) para retirar a cassete do aparelho.





MODO MULTI-CD

Modo de leitor Multi-CD

O Lexington C32 permite-lhe a utilização de um leitor Multi-CD. Pergunte ao seu revendedor quais os leitores Multi-CD disponíveis para este aparelho.

Nota:

- Para informações pormenorizadas sobre como tratar os CDs, como introduzir os CDs e o como manipular o leitor Multi-CD, queira consultar as instruções de serviço do seu leitor Multi-CD.

Iniciar o modo do leitor Multi-CD

- ⇨ Prima as vezes necessárias a tecla **SOURCE** (9) até “CDC 1--1” aparecer no visor.

O primeiro algarismo exibido no visor indica o número do CD (aqui: 1), o segundo algarismo indica o número da faixa (aqui: 1).

O sistema começa a reproduzir o primeiro disco que o leitor Multi-CD identificar.

Seleccionar um CD

Para mudar, por ordem ascendente ou descendente, para um novo CD,

- ⇨ prima uma ou várias vezes a tecla **▲** ou **▼** (8).

Seleccionar uma faixa

Para mudar, por ordem ascendente ou descendente, para uma nova faixa no CD que está a ser tocado,

- ⇨ prima uma ou várias vezes a tecla **>** ou **<** (8).

Busca rápida (com som)

Para efectuar uma busca rápida para trás ou para a frente,

- ⇨ mantenha uma das teclas **<>** (8) premida até o aparelho iniciar a busca pretendida para trás ou para a frente.

Repetição de faixas individuais ou de CDs completos (REPEAT)

Para repetir a faixa que está a ser tocada,

- ⇨ prima por um período curto a tecla **3 (RPT)** (12).

O visor indica “S--RPT” por um período curto.

Para repetir o CD que está a ser tocado,

- ⇨ mantenha a tecla **3 (RPT)** (12) premida por mais de dois segundos.

O visor indica “D--RPT” por um período curto.

Terminar a função REPEAT

Para terminar a repetição da faixa ou do CD que está a ser tocado,

- ⇨ prima a tecla **3 (RPT)** (12) até “S--RPT” ou “D--RPT” se apagar e o modo de indicação normal do CD voltar a aparecer no visor.





MODO MULTI-CD

Leitura das faixas numa ordem aleatória (MIX)

Para ouvir as faixas do CD que está a ser tocado, numa ordem variável, aleatoriamente seleccionada pelo aparelho,

- ⇨ prima por um período curto a tecla **4 (MIX)** (12).

O visor indica “S--MIX” por um período curto.

Para ouvir as faixas de todos os CDs inseridos, numa ordem variável, aleatoriamente seleccionada pelo aparelho,

- ⇨ mantenha a tecla **4 (MIX)** (12) premeida por mais de dois segundos.

O visor indica “D--MIX” por um período curto.

Terminar a função MIX

Para ouvir as faixas numa ordem variável, aleatoriamente seleccionada pelo aparelho,

- ⇨ prima a tecla **4 (MIX)** (12) até “S--MIX” ou “D--MIX” se apagar e o modo de indicação normal do CD voltar a aparecer no visor.

Tocar o início de todas as faixas de cada CD (SCAN)

Tocar as faixas do CD que está a ser tocado

Para ouvir, numa ordem variável, todas as faixas do CD que está a ser tocado,

- ⇨ prima a tecla **2 (SCAN)** (12).

O visor indica “S--SCN”.

Tocar a primeira faixa de cada CD

Esta função permite-lhe tocar a primeira faixa dos CDs inseridos no leitor Multi-CD.

- ⇨ Mantenha a tecla **2 (SCAN)** (12) premeida por mais de dois segundos.

O visor indica “D--SCAN”.

Terminar a função SCAN

Para terminar a reprodução do início das faixas,

- ⇨ volte a premir, por um período curto, a tecla **2 (SCAN)** (12).

A faixa cujo início está a ser tocado continua a ser lida.

Nota:

- O tempo de leitura do início das faixas pode ser regulado. Para tal, leia o parágrafo “Regular o tempo de reprodução SCAN” no capítulo “Modo de CD”.

Interromper a reprodução (PAUSE)

- ⇨ Prima a tecla **1 (▶)** (12).

O visor indica “S--PAUSE”.

Terminar a pausa

- ⇨ Prima, durante a pausa, a tecla **2 (▶)** (12).

A leitura é prosseguida.





CLOCK - RELÓGIO



CLOCK - Relógio

Fazer exibir a hora



Para fazer exibir a hora,

- ⇨ prima por um período curto a tecla  (14).

Acertar o relógio

- ⇨ Prima a tecla **MENU** (8).
- ⇨ Prima as vezes necessárias a tecla  ou  (8) até “CLOCKSET” aparecer no visor.
- ⇨ Prima a tecla  (8).



A hora é exibida no visor. Os minutos piscam indicando que podem ser acertados.

- ⇨ Acerte os minutos com as teclas   (8).

Quando tiver acertados os minutos,

- ⇨ prima a tecla  (8).





As horas piscam.

- ⇨ Acerte as horas com as teclas   (8).

Quando tiver terminado o ajuste,

- ⇨ prima duas vezes a tecla **MENU** (8).

Seleccionar o modo do relógio de 12/24 horas





- ⇨ Prima a tecla **MENU** (8).
- ⇨ Prima as vezes necessárias a tecla  ou  (8) até “24 H MODE” ou “12 H MODE” aparecer no visor.
- ⇨ Prima a tecla  ou  (8) para alterar o modo.

Quando tiver terminado o ajuste,

- ⇨ prima a tecla **MENU** (8).

Fazer exibir a hora com o aparelho desligado e a ignição ligada

Para fazer indicar a hora com o aparelho desligado, mas com a ignição ligada,

- ⇨ prima a tecla **MENU** (8).
- ⇨ Prima as vezes necessárias a tecla  ou  (8) até “CLOCK OFF” ou “CLOCK ON” aparecer no visor.
- ⇨ Prima a tecla  ou  (8) para alterar o modo.

Quando tiver terminado o ajuste,

- ⇨ prima a tecla **MENU** (8).





SOM E RELAÇÃO DO VOLUME

Som e relação do volume

Regular os graves

Para regular os graves (BASS),

⇨ prima a tecla **AUDIO** (10).

“BAS” é indicado no visor.

Para aumentar os graves,

⇨ rode o regulador do volume (3) para a direita.

Para diminuir os graves,

⇨ rode o regulador do volume (3) para a esquerda.

Quando tiver terminado o ajuste,

⇨ aguarde 8 segundos até os ajustes tiverem sido armazenados e o menu da fonte de áudio aparecer no visor.

Regular os agudos

Para regular os agudos (TREBLE),

⇨ prima as vezes necessárias a tecla **AUDIO** (10) até “TRE” aparecer no visor.

Para aumentar os agudos,

⇨ rode o regulador do volume (3) para a direita.

Para diminuir os agudos,

⇨ rode o regulador do volume (3) para a esquerda.

Quando tiver terminado o ajuste,

⇨ aguarde 8 segundos até os ajustes tiverem sido armazenados e o menu da fonte de áudio aparecer no visor.

Regular a função “balance”

Para regular a relação do volume entre os canais à esquerda e à direita (“balance”),

⇨ prima as vezes necessárias a tecla **AUDIO** (10), até “BAL” aparecer no visor.

Para deslocar a relação do volume para o canal direito,

⇨ rode o regulador do volume (3) para a direita.

Para deslocar a relação do volume para o canal esquerdo,

⇨ rode o regulador do volume (3) para a esquerda.

Quando tiver terminado o ajuste,

⇨ aguarde 8 segundos até os ajustes tiverem sido armazenados e o menu da fonte de áudio aparecer no visor.

Regular a função “fader”

Para regular a relação do volume entre os canais dianteiro e traseiro (Fader)

⇨ prima as vezes necessárias a tecla **AUDIO** (10) até “FAD” aparecer no visor.

Para deslocar a relação do volume para o canal traseiro,

⇨ rode o regulador do volume (3) para a direita.

Para deslocar a relação do volume para o canal dianteiro,

⇨ rode o regulador do volume (3) para a esquerda.





SOM E RELAÇÃO DO VOLUME

Quando tiver terminado o ajuste,

- ⇨ aguarde 8 segundos até os ajustes tiverem sido armazenados e o menu da fonte de áudio aparecer no visor.

EQUALIZADOR E X-BASS

Equalizador e X-BASS

X-BASS

X-Bass significa que a acentuação dos graves nos volumes baixos.

Para ligar a função X-BASS,

- ⇨ mantenha a tecla **EQ/ X-BASS** ⁽¹¹⁾ premida até “XBASS ON” aparecer no visor.

X-BASS é apresentado no visor.

Para desligar a função X-BASS,

- ⇨ mantenha a tecla **EQ/ X-BASS** ⁽¹¹⁾ premida até “XBASS OFF” aparecer no visor.

X-BASS é apagado.

Escolher os padrões pré-ajustados para o som

Este aparelho permite-lhe seleccionar padrões pré-ajustados para os seguintes tipos de música:

- CLASSIC
- POP M
- ROCK M

Encontrará ajustes já pré-programados para estes tipos de música.

Para seleccionar um dos padrões pré-ajustados,

- ⇨ prima as vezes necessárias a tecla **EQ/X-BASS** ⁽¹¹⁾ até o padrão pretendido aparecer no visor.

Se pretender desactivar um padrão pré-ajustado,

- ⇨ prima as vezes necessárias a tecla **EQ/X-BASS** ⁽¹¹⁾ até “DSP OFF” aparecer no visor.



DADOS TÉCNICOS

Dados técnicos

Amplificador

Potência de saída:

St. Louis C32: 4 x 22 watts
sinus segundo
DIN 45 324 com
14,4V
4 x 50 watts de
potência máxima

Lexington C32: 4 x 15 watts
sinus segundo
DIN 45 324 com
14,4 V
4 x 40 watts de
potência máxima

Sintonizador

Gama de frequências EUA:

FM: 87,5 - 107,9 MHz

AM: 530 - 1710 kHz

Sensibilidade FM em mono:

15 dBf

Resposta em frequência FM:

35 - 16 000 Hz

CC

Resposta em frequência:

30 - 18 000 Hz

Pre-Amp Out

(só no St. Louis C32)

Saída: $1,5 V_{rms} \pm 2,5 \text{ dB}$

Reservado o direito a alterações!





KULLANIM ELEMANLARI

- ① Kumanda panelini çıkarmak için **LV** tuşu
- ② Cihazı açma / kapatma tuşu
- ③ Ses şiddeti ayarlayıcısı
- ④ **△** kaset çıkarma
- ⑤ Kaset yuvası
- ⑥ **FR** tuşu, hızlı kaset sarma
- ⑦ **FF** tuşu, hızlı kaset sarma
- ⑧ **OK** tuşları
MENU tuşu, temel ayarlar menüsünün çağırılması
- ⑨ **SOURCE** tuşu, CC, radyo ve CD değiştirici kaynaklarının seçilmesi
- ⑩ **AUDIO** tuşu, bas, tiz, balans ve fader konumlarının ayarlanması (Balans ve fader)
- ⑪ Kısa süreli basarak: **EQ** tuşu, ses ön ayarlarını seçmek için
Uzun süreli basarak: **X-BASS**, X-Bass fonksiyonu
- ⑫ **1 - 6** tuşları
- ⑬ Kısa süreli basarak: **BAND** tuşu, FM kayıt alanının ve AM dalga bandının seçilmesi, radyo modu kaynak seçimi
Uzun süreli basarak: **TS**, Travelstore fonksiyonunun başlatılması
- ⑭ **⌚** tuşu, saati göstermek için





İÇİNDEKİLER

Uyarılar ve aksesuarlar	61	CD değıştirici modu	67
Trafik güvenliđi	61	CD değıştirici moduna geçiř	67
Montaj	61	CD'lerin seđilmesi	67
Aksesuarlar	61	Parçaların seđilmesi	67
Çıkarılabilir kumanda paneli	62	Hızlı arama işlemleri (sesli)	67
Hırsızlığa karşı koruma	62	Parçaları ayrı ayrı veya tüm	
Kumanda panelinin çıkarılması	62	CD'leri tekrar çalma (REPEAT) ...	67
Kumanda panelinin takılması	62	Rastgele sırayla parça çalma	
Açma / kapatma	63	(MIX)	68
Ses şiddetinin ayarlanması ..	63	Tüm CD'lerdeki tüm parçaları	
Açılıř ses şiddetinin ayarlanması .	63	tarama (SCAN)	68
Sesin birden düşürülmesi (Mute)..	63	Çalmaya ara verme (PAUSE)	68
Telefonla konuşurken sesin		CLOCK – Saat	69
düşürülmesi	64	Saatin gösterilmesi	69
Radyo modu	64	Saat ayarı	69
Radyo moduna geçiř	64	12 / 24 saat modunun seđilmesi ..	69
Frekans bandının / kayıt alanının		Cihaz kapalı ve kontak açık	
seđilmesi	64	olduđunda saatin gösterilmesi	69
Bir istasyon ayarlama	64	Tını ve ses şiddeti dağılımı	
İstasyon arama işleminin		ayarları	70
hassasiyetinin ayarlanması	65	Bas ayarı	70
İstasyon ön ayarlarının hafızaya		Tiz ayarı	70
kaydedilmesi	65	Balans ayarları	70
İstasyonların otomatik olarak		Fader ayarları	70
hafızaya kaydedilmesi		Ekolayzer ve X-BASS	71
(Travelstore)	65	X-BASS	71
İstasyon ön ayarlarının		Hafızadaki ses efektinin seđimi ...	71
dinlenmesi	65	Teknik veriler	71
Kaset modu	66	Amplifikatör	71
Kaset çalma	66	Radyo	71
Kasetin çalınan yüzünün		CC	71
deđiřtirilmesi	66	Ön amplifikatör çıkışı	71
Hızlı kaset sarma	66	Montaj kılavuzu	72
Kaset çıkarma	66		





UYARILAR VE AKSESUARLAR

Bir Blaupunkt ürünü kullanmaya karar verdiğiniz için teşekkür ederiz. Bu yeni cihazı kullanmaktan keyif alacağınızı ümit ediyoruz.

Cihazı ilk kez kullanmadan önce lütfen bu kullanma kılavuzunu okuyunuz. Blaupunkt editörleri kullanma kılavuzunun açık ve kolay anlaşılır olması için sürekli olarak çalışmaktadırlar. Bununla birlikte, cihazın kullanımı hakkında hala sorularınız varsa, satıcınıza veya ülkenizdeki ilgili telefonla danışma hattına başvurunuz. Telefonla danışma hattı numaralarını bu kılavuzun arka tarafında bulabilirsiniz.

Trafik güvenliği

 Trafik güvenliği her şeyden daha önemlidir. Sadece yol ve trafik koşullarının izin verdiği durumlarda radyonuzu kullanınız. Yola çıkmadan önce cihazınızı tanıyınız.

Polis, itfaiye ve kurtarma hizmetlerinin sesli uyarı sinyalleri aracınızda zamanında duyulabilir. Bu nedenle, yolculuk sırasında programınızı ölçülü bir ses şiddetinde dinleyiniz.

Montaj

Araç radyonuzu kendiniz monte etmek isterseniz, bu kullanma kılavuzunun devamındaki montaj ve bağlantı kılavuzunu lütfen okuyunuz.

Aksesuarlar

Yalnızca Blaupunkt tarafından onaylanmış aksesuarları kullanınız.

Uzaktan kumanda

Lexington C32 cihazı için RC 04 uzaktan kumanda isteğe bağlı olarak kullanılır.

St. Louis C32 cihazı uzaktan kumanda ile kullanılamaz.

Amplifikatör

Tüm Blaupunkt ve Velocity amplifikatörlerini kullanabilirsiniz.

CD değiştirici

Blaupunkt CD değiştirici CDC A 01 (7607 700 022) Lexington C32 ünitesine bağlanabilir.

St. Louis C32 ünitesine CD değiştirici bağlanamaz.





ÇIKARILABİLİR KUMANDA PANELİ

Çıkarılabilir kumanda paneli

Hırsızlığa karşı koruma

Cihazınız, hırsızlığa karşı korunmak amacıyla, çıkarılabilir bir kumanda paneli (çıkarma paneli) ile donatılmıştır. Bu kumanda paneli olmaksızın araç radyosunun hırsız için değeri yoktur.

Cihazınızı hırsızlığa karşı koruyunuz ve aracınızı her terk ettiğinizde kumanda panelini yanınıza alınız. Kumanda panelini otomobil içerisinde gizli bir yerde bile olsa, bırakmayınız.

Kumanda paneli kolayca çıkarılıp takılabilecek biçimde hazırlanmıştır.

Uyarı:

- Kumanda panelini düşürmeyiniz.
- Kumanda panelini doğrudan güneş ışığı veya diğer ısı kaynakları etkisi altında bırakmayınız.
- Kumanda paneli kontaktlarına elle dokunmaktan kaçınınız. İhtiyaç durumunda kontaktları alkolle ıslatılmış havsuz bir bezle siliniz.

Kumanda panelinin çıkarılması

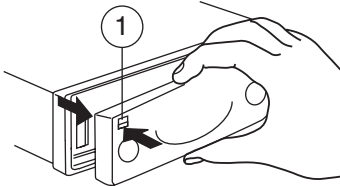

⇒ **[N]** tuşuna ① basınız.

Kumanda paneli kilit mekanizması açılır.

⇒ Kumanda panelini cihazdan önce düz olarak ve sonra dışarı doğru sola çekin.

- Kumanda paneli çıkarıldıktan sonra cihaz kapanır.
- Mevcut tüm radyo ayarları kaydedilir.
- Yerleştirilmiş bir CD varsa, cihaz içerisinde kalır.

Kumanda panelinin takılması

- ⇒ Kumanda panelini soldan sağa doğru cihazdaki yuvasına itiniz.
- ⇒ Kumanda panelinin sol yanından yuvasına tam oturuncaya kadar itiniz.

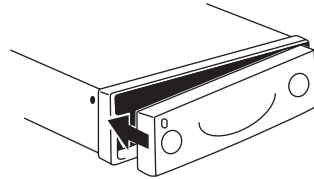

Uyarı:

- Kumanda panelini takarken göstergenin üzerine bastırmayınız.

Kumanda panelini cihaz açıkken çıkarırsanız, panel yeniden takıldığında, cihaz otomatik olarak en son kullanılmış ayarlar ile, yani radyo, CC veya CD değiştirici (CD değiştirici sadece Lexington C32 modelinde) çalışmaya başlar.





AÇMA / KAPATMA

Açma / kapatma

Cihazı açma ve kapatmanın çeşitli yolları vardır:

Kontak anahtarını kullanarak açma / kapatma

Eğer cihaz aracın kontak anahtarı ile doğru bir biçimde bağlanmış ve tuş ② ile kapatılmamışsa, cihaz kontak anahtarı ile aynı anda açılır / kapanır.

Çıkarılabilir kumanda panelini kullanarak açma / kapatma

⇨ Kumanda panelini çıkarınız.

Cihaz kapanır.

⇨ Kumanda panelini tekrar takınız.

Cihaz açılır. Son ayarlar, örn. radyo, CC veya CD değiştirici (CD değiştirici sadece Lexington C32 modelinde) otomatik olarak devreye girer.

Tuş ②'yi kullanarak açma / kapatma

⇨ Cihazı açmak için tuş ②'ye basınız.

Cihaz, sadece kontak açıldığında devreye girebilir.

⇨ Cihazı kapatmak için en az 2 saniye tuş ②'yi basılı tutunuz.

Cihaz kapanır.

SES ŞİDDETİNİN AYARLANMASI

Ses şiddetinin ayarlanması

Sistemin ses şiddeti 0 (kapalı) ile 100 (en yüksek) arasında adım adım ayarlanabilir.

Sistemin ses şiddetini yükseltmek için,

⇨ Ses ayar tuşunu ③ saat yönünde çeviriniz.

Ses şiddetini azaltmak için,

⇨ Ses ayar tuşunu ③ saat yönünün tersine çeviriniz.

Açılış ses şiddetinin ayarlanması

Cihazın açılış sesini ayarlayabilirsiniz

⇨ **MENU** tuşuna ⑧ basınız.

⇨ "ON VOL" ekranda görününceye kadar **V** veya **∞** tuşunu ⑧ basılı tutunuz.

⇨ **<** ve **>** tuşlarını ⑧ kullanarak açılış ses şiddetini ayarlayınız.

Ses şiddetini daha kolay ayarlamanıza yardımcı olmak için, değişikliklerinizi yaparken ses şiddeti artar / azalır.

Değişiklik yapma işleminizi bitirdiğinizde,

⇨ **MENU** tuşuna ⑧ iki kere basınız.

Sesin birden düşürülmesi (Mute)

Ses şiddetini, daha önce ayarladığınız bir seviyeye birden düşürebilirsiniz (Mute).

⇨ ② tuşuna kısa süre basınız.

Ekranda "MUTE" görünür.





SES ŞİDDETİNİN AYARLANMASI

RADYO MODU

Ses düşürme seviyesinin ayarlanması

Cihazın ses düşürme seviyesini ayarlayabilirsiniz.

- ⇒ **MENU** tuşuna (8) basınız.
- ⇒ "MUTE LVL" ekranda görününceye kadar **↵** veya **↶** tuşunu (8) basılı tutunuz.
- ⇒ **<** ve **>** tuşlarını (8) kullanarak ses düşürme seviyesini ayarlayınız.

Değişiklik yapma işleminizi bitirdiğinizde,

- ⇒ **MENU** tuşuna (8) iki kere basınız.

Telefonla konuşurken sesin düşürülmesi

Cihazınız bir mobil telefona bağlıysa, bir telefon çağrısı aldığınızda, araç radyosunun sesi kesilir. Ekranda "TEL CALL" ibaresi yanıp söner.

Bu özelliği kullanabilmek için, mobil telefonunuzun montaj kılavuzunda tarif edildiği gibi araç radyosuna bağlı olması gerekir.

Ses şiddeti, belirlenen ses düşürme seviyesine azalır.

Radio modu

Radio moduna geçiş

Eğer CC veya CD değiştirici modundaysanız (CD değiştirici sadece Lexington C32 modelinde),

- ⇒ Radio modu, kayıt alanı ve frekans ile birlikte ekranda görününceye kadar. **SOURCE** (9) tuşunu basılı tutunuz.

Frekans bandının / kayıt alanının seçilmesi

Bu cihaz FM ve AM frekans bandı üzerinden yayın yapan programları alabilir. FM menzili için üç tane ve AM menzili için bir tane kayıt alanı mevcuttur. Her bir kayıt alanına 6 istasyon kaydedilebilir.

FM kayıt alanı seçimi

FM kayıt alanı FM1, FM2 ve FMT arasında geçiş yapmak için,

- ⇒ **BAND / TS** tuşuna (13) basınız.

AM dalga bandının seçilmesi

AM dalga bandını seçmek için,

- ⇒ Ekranda AM görününceye kadar **BAND / TS** tuşunu (13) basılı tutunuz.

Bir istasyon ayarlama

Çeşitli istasyon arama yöntemleri vardır.

Otomatik arama

- ⇒ **↵** veya **↶** tuşuna (8) basınız.

Cihaz bir sonraki alınabilen istasyona ayarlanır.





RADYO MODU

İstasyon arama işleminin hassasiyetinin ayarlanması

Ya sadece kuvvetli alınan istasyonları ayarlama ya da zayıf istasyonları da ayarlayabilme tercihleri arasında seçim yapabilirsiniz.

☞ **MENU** tuşuna (8) basınız.

☞ "SENS HI" veya "SENS LO" ekranda görününceye kadar **✓** veya **✗** tuşunu (8) basılı tutunuz.

"SENS HI" sembolü durumunda, cihaz yüksek hassasiyete ayarlı demektir. "SENS LO" sembolü durumunda, cihaz düşük hassasiyete ayarlı demektir. "SENS LO" seçilirse, ekranda "LOC" yanar.

☞ **<** ve **>** tuşlarını (8) kullanarak istenen hassasiyeti ayarlayınız.

Değişiklik yapma işleminizi bitirdiğinizde,

☞ **MENU** tuşuna (8) basınız.

Manüel olarak istasyon ayarlama

İstasyonları manüel olarak ayarlayabilirsiniz.

☞ **<** veya **>** tuşuna (8) basınız.

İstasyon ön ayarlarının hafızaya kaydedilmesi

İstasyonları manüel olarak hafızaya alma

☞ İsteddiğiniz kayıt alanını (FM1, FM2 veya FMT) veya AM dalga bandını seçiniz.

☞ İstasyonu ayarlayınız.

☞ İstasyonu o hafıza numarasına kaydetmek için **1-6** istasyon tuşlarını (12) en az 1 saniye basılı tutunuz.

İstasyonların otomatik olarak hafızaya kaydedilmesi (Travelstore)

Bölgenizdeki en kuvvetli altı istasyonu otomatik olarak kaydedebilirsiniz. İstasyonlar, seçilen frekans bandına bağlı olarak FMT veya AM hafızasına kaydedilebilir.

Uyarı:

- Bu kayıt alanına daha önce kaydedilmiş olan istasyonlar bu işlem sırasında silinir.

☞ Arama işlemi başlayıncaya kadar **BAND / TS** tuşunu (13) basılı tutunuz.

İstasyon kaydetme işlemi başlar. İşlem sona erdiğinde, kaydedilen tüm istasyonlar otomatik olarak kısa süre çalınır.

İstasyon ön ayarlarının dinlenmesi

☞ İstasyonun kaydedilmiş olduğu kayıt alanını seçiniz.

☞ Dinlemek istediğiniz ön ayarlı istasyon tuşuna **1-6** (12) basınız.





KASET MODU

Kaset modu

Kaset çalma

- Eğer cihaz içine yerleştirilmiş kaset yoksa,
- ⇨ Kaseti, açık kenarı sağa baka- cak ve A / 1 tarafı yukarı gel- ecek şekilde kaset yuvasına ⑤ yerleştirin.

Kasetin yukarı bakan tarafı ilk olarak çalmaya başlar (A / 1 tarafı). Ekranda kaset sembolü görünür.te symbol ap- pears in the display.

- Eğer cihaz içerisinde bir kaset varsa,
- ⇨ Ekranda "TAPE" mesajı görününceye kadar **SOURCE** tuşunu ⑨ basılı tutunuz.

Kaset, en son belirlenen yönde çalar.

Kasetin çalınan yüzünün değiştirilmesi

- ⇨ Kaset sarma tuşlarına **FR** ⑥ ve **FF** ⑦ aynı anda basınız.

Kaset çalma yönü değişir.

Kasetin sonuna gelindiğinde çalma yüzü otomatik olarak değişir (Auto- reverse).

Hızlı kaset sarma

Hızlı ileri sarma

- A / 1 tarafını hızlı ileri sarmak için,
- ⇨ Sarma konumuna gelebilmesi için **FF** kaset sarma tuşuna ⑦ basınız.
- B / 2 tarafını hızlı ileri sarmak için,
- ⇨ Sarma konumuna gelebilmesi için **FR** kaset sarma tuşuna ⑥ basınız.

Ekranda "TAPE FF" görünür.

Hızlı geri sarma

- A / 1 tarafını hızlı geri sarmak için,
- ⇨ Sarma konumuna gelebilmesi için **FR** kaset sarma tuşuna ⑥ basınız.
- B / 2 tarafını hızlı geri sarmak için,
- ⇨ Sarma konumuna gelebilmesi için **FF** kaset sarma tuşuna ⑦ basınız.

Ekranda "TAPE FR" görünür.

Kaset sarmayı durdurma

- ⇨ Hızlı kaset sarma tuşuna aksi yönde basınız.
- Çalma işlemi devam eder.

Kaset çıkarma

- ⇨ Kaseti cihazdan çıkarmak için  tuşuna ④ basınız.





CD DEĞİŞTİRİCİ MODU

CD değiştirici modu

Lexington C32 cihazına bir CD değiştirici bağlayabilirsiniz. Kullandığınız CD değiştiriciler hakkında satıcınızdan daha detaylı bilgiler alabilirsiniz.

Uyarı:

- CD'lerin kullanımı, yerleştirilmesi ve CD değiştiricinin çalıştırılması hakkındaki bilgileri, CD değiştiriciniz ile birlikte verilen kullanım kılavuzunda bulabilirsiniz.

CD değiştirici moduna geçiş

⇨ Ekranda örneğin "CDC 1--1" görününceye kadar **SOURCE** tuşunu (9) basılı olarak tutunuz.

Bu ekrandaki ilk hane CD numarasını (bu örnekte 1) ve ikinci hane parça numarasını (bu örnekte 1) temsil eder.

Çalma işlemi, CD değiştiricinin tespit ettiği ilk CD ile başlar.

CD'lerin seçilmesi

Yukarıya veya aşağıya doğru bir başka CD'ye geçmek için,

⇨ **↖** veya **↗** tuşuna (8) bir veya bir kaç kere basınız.

Parçaların seçilmesi

Mevcut CD içerisinde yukarıya veya aşağıya doğru bir başka parçaya geçmek için,

⇨ **<** veya **>** tuşuna (8) bir veya bir kaç kere basınız.

Hızlı arama işlemi (sesli)

İleri veya geri hızlı sarmak için,

⇨ ileri veya geri hızlı sarma başlayınca kadar, **<>** tuşlarından (8) birini basılı tutunuz.

Parçaları ayrı ayrı veya tüm CD'leri tekrar çalma (REPEAT)

Mevcut parçayı tekrar çalmak için,

⇨ **3 (RPT)** tuşuna (12) kısa süre basınız.

Ekranda kısa süre "S--RPT" görünür.

Mevcut CD'yi tekrar çalmak için,

⇨ **3 (RPT)** tuşunu (12) en az 2 saniye basılı tutunuz.

Ekranda kısa süre "D--RPT" görünür.

REPEAT fonksiyonunu devreden çıkarma

Mevcut parçanın veya CD'nin tekrar çalmasını sona erdirmek için,

⇨ "S--RPT" veya "D--RPT" ekrandan kayboluncaya ve standart CD değiştirici ekranda yeniden görününceye kadar **3 (RPT)** tuşuna (12) basınız.





CD DEĞİŞTİRİCİ MODU

Rastgele sırayla parça çalma (MIX)

Mevcut CD'deki parçaları rastgele sırayla çalmak için,

- ⇨ Kısa süre **4 (MIX)** tuşuna ⁽¹²⁾ basınız.

Ekranında kısa süre "S--MIX" görünür.

Yerleştirilen tüm CD'lerdeki parçaları rastgele sırayla çalmak için,

- ⇨ **4 (MIX)** tuşunu ⁽¹²⁾ iki saniyeden uzun süre basılı tutunuz.

Ekranında kısa süre "D--MIX" mesajı görünür.

MIX (rastgele çalmayı)'in iptal edilmesi

Parçaların rastgele sırayla çalmasını sona erdirmek için,

- ⇨ "S--MIX" veya "D--MIX" ekrandan kayboluncaya ve standart CD değiştirici ekranda yeniden görününceye kadar **4 (MIX)** tuşuna ⁽¹²⁾ basınız.

Tüm CD'lerdeki tüm parçaları tarama (SCAN)

Mevcut CD'deki parçaları tarama

Mevcut CD'deki tüm parçaları tanıma amaçlı olarak kısa süreli çalmak için,

- ⇨ **2 (SCAN)** tuşuna ⁽¹²⁾ basınız.

Ekranında "S--SCN" mesajı görünür.

Tüm CD'lerdeki ilk parçayı tanıma amaçlı olarak tarama

CD değiştiricideki tüm CD'lerde bulunan ilk parçayı tanıma amaçlı olarak kısa süre çalabilirsiniz.

- ⇨ **2 (SCAN)** tuşunu ⁽¹²⁾ iki saniyeden daha uzun süre basılı tutunuz.

Ekranında "D--SCAN" görünür.

Tarama işlemini (SCAN) durdurma

Taramayı durdurmak için,

- ⇨ **2 (SCAN)** tuşuna ⁽¹²⁾ kısa süre tekrar basınız.

Tanıma amaçlı olarak çalınan parça normal şekilde çalınmaya devam eder.

Uyarı:

- Tarama süresini ayarlayabilirsiniz (tarama süresi). Diğer ayrıntılar için "CD modu" bölümündeki "Tarama süresinin ayarlanması" başlıklı kısmı okuyunuz.

Çalmaya ara verme (PAUSE)

- ⇨ **1 (||)** tuşuna ⁽¹²⁾ basınız.

Ekranında "S--PAUSE" görüntüye gelir.

Ara vermeyi iptal etme

- ⇨ Ara verme modundayken, **2 (||)** ⁽¹²⁾ tuşuna basınız.

Çalma işlemi devam eder.





CLOCK – SAAT

CLOCK – Saat

Saatin gösterilmesi

Saati gösterebilmek için,

- ⇨ **Ⓢ** tuşuna **(14)** kısa süre basınız.

Saat ayarı

- ⇨ **MENU** tuşuna **(8)** basınız.

- ⇨ "CLOCKSET" ekranda görününceye kadar **↵** veya **↶** tuşuna **(8)** basınız.

- ⇨ **>** tuşuna **(8)** basınız.

Ekranda zaman görünür. Dakikalar yanıp söner ve ayarlanabilir.

- ⇨ **↶/↵** tuşlarını **(8)** kullanarak dakikaları ayarlayınız.

Dakika ayarlandıktan sonra,

- ⇨ **<** tuşuna **(8)** basınız.

Saatler yanıp söner.

- ⇨ **↶/↵** tuşlarını **(8)** kullanarak saatleri ayarlayınız.

Değişiklik yapma işleminizi bitirdiğinizde,

- ⇨ **MENU** tuşuna **(8)** iki kere basınız.

12 / 24 saat modunun seçilmesi

- ⇨ **MENU** tuşuna **(8)** basınız.

- ⇨ "24 H MODE" veya "12 H MODE" ekranda görününceye kadar **↵** veya **↶** tuşunu **(8)** basılı tutunuz.

- ⇨ Modlar arasında geçiş yapmak için **<** veya **>** tuşuna **(8)** basınız.

Değişiklik yapma işleminizi bitirdiğinizde,

- ⇨ **MENU** tuşuna **(8)** basınız.

Cihaz kapalı ve kontak açık olduğunda saatin gösterilmesi

Cihaz kapalı ve kontak açık olduğunda saati görüntülemek için,

- ⇨ **MENU** tuşuna **(8)** basınız.

- ⇨ "CLOCK OFF" veya "CLOCK ON" ekranda görününceye kadar **↵** veya **↶** tuşunu **(8)** basılı tutunuz.

- ⇨ Ekranlar arasında geçiş yapmak için **<** veya **>** tuşuna **(8)** basınız.

Değişiklik yapma işleminizi bitirdiğinizde,

- ⇨ **MENU** tuşuna **(8)** basınız.





TINI VE SES ŞİDDETİ DAĞILIMI AYARLARI

Tını ve ses şiddeti dağılımı ayarları

Bas ayarı

BASS seviyesini ayarlamak için,

⇨ **AUDIO** tuşuna (10) basınız.

Ekranda "BASS" görünür.

Bası artırmak için,

⇨ Ses ayar tuşunu (3) saat yönünde çeviriniz.

Bası azaltmak için,

⇨ Ses ayar tuşunu (3) saat yönünün tersine çeviriniz.

Değişiklik yapma işleminizi bitirdiğinizde,

⇨ 8 saniye bekleyiniz, ayarlar kaydedilir ve ekranda audio kaynağı görünür.

Tiz ayarı

Tiz seviyesini ayarlamak için,

⇨ "TRE" ekranda görününceye kadar **AUDIO** tuşunu (10) basılı olarak tutunuz.

Tizi artırmak için,

⇨ Ses ayar tuşunu (3) saat yönünde çeviriniz.

Tizi azaltmak için,

⇨ Ses ayar tuşunu (3) saat yönünün tersine çeviriniz.

Değişiklik yapma işleminizi bitirdiğinizde,

⇨ 8 saniye bekleyiniz, ayarlar kaydedilir ve ekranda audio kaynağı görünür.

Balans ayarları

Sol / sağ ses şiddeti dağılımını (balans) ayarlamak için,

⇨ "BAL" ekranda görününceye kadar **AUDIO** tuşunu (10) basılı olarak tutunuz.

Ses şiddeti dağılımını sağa doğru götürmek için,

⇨ Ses ayar tuşunu (3) saat yönünde çeviriniz.

Ses şiddeti dağılımını sola doğru götürmek için,

⇨ Ses ayar tuşunu (3) saat yönünün tersine çeviriniz.

Değişiklik yapma işleminizi bitirdiğinizde,

⇨ 8 saniye bekleyiniz, ayarlar kaydedilir ve ekranda audio kaynağı görünür.

Fader ayarları

Ön / arka ses şiddeti dağılımını (fader) ayarlamak için,

⇨ "FAD" ekranda görününceye kadar **AUDIO** tuşunu (10) basılı olarak tutunuz.

Ses şiddeti dağılımını arkaya doğru götürmek için,

⇨ Ses ayar tuşunu (3) saat yönünde çeviriniz.

Ses şiddeti dağılımını öne doğru götürmek için,

⇨ Ses ayar tuşunu (3) saat yönünün tersine çeviriniz.

Değişiklik yapma işleminizi bitirdiğinizde,

⇨ 8 saniye bekleyiniz, ayarlar kaydedilir ve ekranda audio kaynağı görünür.





EKOLAYZER VE X-BASS

TEKNİK VERİLER

Ekolayzer ve X-BASS

X-BASS

X-BASS özelliği düşük ses seviyelerinde bas özelliğini yükseltmek için kullanılır.

X-BASS'ı devreye almak için,

⇨ "XBASS ON" ekranda görününceye kadar **EQ/X-BASS** tuşunu ⁽¹¹⁾ basılı tutunuz.

Ekranda "X-BASS" görünür.

X-BASS'ı devreden çıkarmak için,

⇨ "XBASS OFF" ekranda görününceye kadar **EQ/X-BASS** tuşunu ⁽¹¹⁾ basılı tutunuz.

"X-BASS" ekrandan kaybolur.

Hafızadaki ses efektinin seçimi

Aşağıdaki müzik türleri için hafızada kaydedilmiş ses efektlerini seçebilirsiniz:

- CLASSIC
- POP M
- ROCK M

Bu müzik türleri için ayarlar önceden programlanmıştır.

Ses ön ayarlarından birini seçmek için,

⇨ İstenen ayar ekranda görününceye kadar **EQ/X-BASS** tuşunu ⁽¹¹⁾ basılı tutunuz.

Eğer ses ön ayarını devreden çıkarmak istiyorsanız,

⇨ "DSP OFF" ekranda görününceye kadar **EQ/X-BASS** tuşunu ⁽¹¹⁾ basılı tutunuz.

Teknik veriler

Amplifikatör

Çıkış gücü:

St. Louis C32: 4 x 22 Watt sinüs,
DIN 45 324'e göre,
14.4 V'ta
4 x 50 Watt maks.
güç

Lexington C32: 4 x 15 Watt sinüs,
DIN 45 324'e göre,
14.4 V'ta
4 x 40 Watt maks.
güç

Radio

Frekans bandı ABD:

FM: 87.5 - 107.9 MHz

AM: 530 - 1710 kHz

FM mono hassasiyet:

15 dBf

FM frekans aralığı:

35 - 16.000 Hz

CC

Frekans aralığı: 30 - 18.000 Hz

Ön amplifikatör çıkışı

(St. Louis C32 için uygulanamaz:)

Çıkış: 1.5 V_{rms} ± 2.5 dB

Değişiklikler olabilir!





Installation instructions • Notice de montage • Instrucciones de instalación • Instruções de montagem • Montaj kılavuzu

Safety precautions

Installation and connection regulations

- In the event that this equipment is installed or repaired incorrectly, this could cause malfunctions in the vehicle electronics.
- To avoid causing damage to your radio, use the corresponding Blaupunkt adapter cable to connect the 8-pin +/- ISO plug in the vehicle.

While installing and connecting this equipment, please observe the following safety notes:

- Disconnect the negative battery terminal.
- Observe the car manufacturer's safety instructions.
- If you drill any holes, make sure that you do not damage any parts of the vehicle.
- The diameter of the positive/negative cable must not be less than 1.5 mm².

Indications de sécurité

Consignes de montage et de branchement

- En cas d'erreur d'installation ou d'entretien, des perturbations peuvent survenir au niveau des systèmes électroniques du véhicule.
- Pour ne pas détériorer votre autoradio, branchez le connecteur ISO +/- 8 pôles du véhicule uniquement via un câble adaptateur Blaupunkt correspondant.

Pendant le montage et le branchement, observez les consignes de sécurité suivantes :

- Débrancher le pôle (-) de la batterie.
- Observer ce faisant les indications de sécurité du constructeur automobile.
- Veiller à ne pas endommager les pièces du véhicule en perçant des trous.
- La section transversale du câble (+) et (-) ne doit pas être inférieure à 1,5 mm².





E **Normas de seguridad**

Especificaciones sobre la instalación y conexión

- En caso de realizarse una instalación o un mantenimiento inadecuado, éstos pueden ocasionar fallos en las funciones de los sistemas eléctricos del vehículo.
- Para que su radio no sufra daños, debe conectar el enchufe del vehículo de 8 polos +/- ISO sólo al correspondiente cable adaptador Blaupunkt.

Durante el montaje y la conexión observe las siguientes normas de seguridad.

- Desemborne el polo negativo de la batería.
- Al hacerlo, observe las normas de seguridad del fabricante del vehículo.
- Al taladrar orificios asegúrese de que el vehículo no sufra ningún daño.
- El diámetro del cable positivo y negativo no debe ser menor a 1,5 mm².

P **Indicações de segurança**

Directivas de montagem e de conexão

- Podem ocorrer erros de funcionamento em sistemas electrónicos de automóveis devido à uma instalação ou manutenção errada.
- Para evitar a destruição do seu rádio, deverá apenas ligar a ficha ISO de 8 pólos do automóvel através de um respectivo cabo de adaptação Blaupunkt.

Observe por favor as seguintes indicações de segurança durante a montagem e a ligação

- Separar por pressão o pólo negativo da bateria.
- Observar as indicações de segurança do fabricante do automóvel.
- Ao furar orifícios, deverá observar que não sejam danificadas partes do automóvel.
- O diâmetro do cabo positivo e negativo não deve ser inferior a 1,5 mm².

ENGLISH

FRANÇAIS

ESPAÑOL

PORTUGUÊS

TÜRKÇE



(TR) ⚠ Güvenlik uyarıları

Montaj ve bağlantı düzenlemeleri

- Cihazın hatalı bir şekilde monte edilmesi ve onarılması, araç elektronik sisteminde arızalara neden olabilir.
- Radyonuzun zarar görmesini önlemek için araçtaki 8 uçlu +/- ISO fişini bağlamak amacıyla karşılık gelen Blaupunkt adaptörü kullanınız.

Bu cihazın montajı ve bağlanması aşamasında aşağıdaki güvenlik uyarılarını lütfen dikkate alınız:

- Akümülatörün eksi kutbunu sökünüz.
- Araç üreticilerinin güvenlik uyarılarına dikkat ediniz.
- Herhangi bir delik açtığınızda, aracın hiç bir parçasına zarar vermemeye dikkat ediniz.
- Artı ve eksi kablonun çapı 1.5 mm²'den daha küçük olmamalıdır.





Supplied Mounting Hardware

Materiel de montage fourni

Ferretería de montaje suministrada

Elementos de fixação fornecidos

Cihazla beraber verilen montaj donanımı

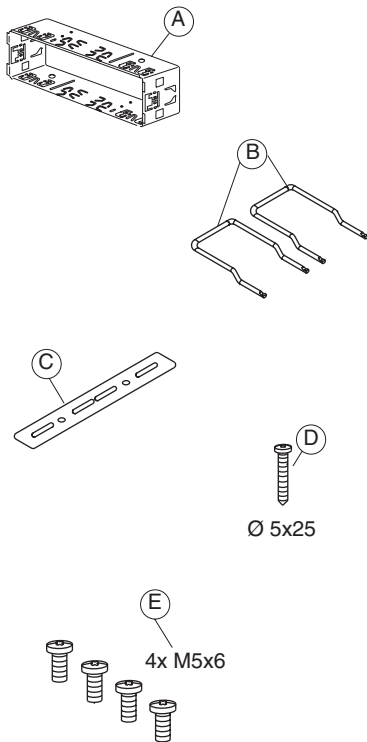

1.

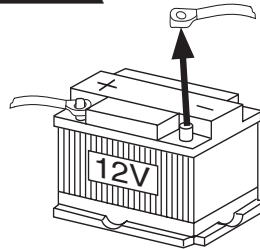

2.

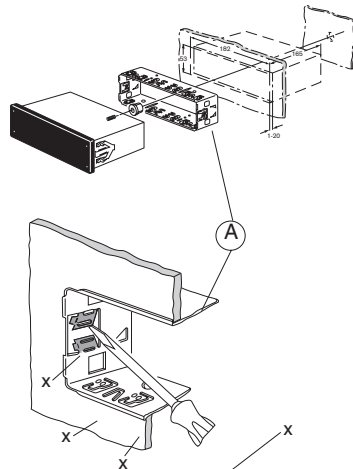

Bend as many taps as possible.
Plier si possible toutes les attaches.
Lo ideal es poder doblar todas las bridas de sujeción.
Devem ser dobradas o máximo possível de braçadeiras.
Mümkün olduğu kadar çok kulakçık kıvrılmalıdır.

ENGLISH

FRANÇAIS

ESPAÑOL

PORTUGUÊS

TÜRKÇE





3.

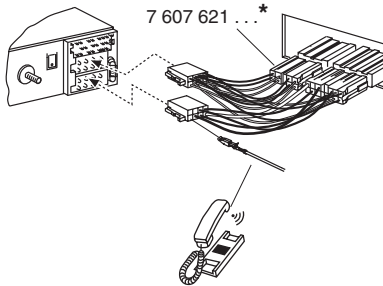

* Car-specific adapter cable which is available at your dealer.

Câble adaptateur spécifique au véhicule, disponible dans le commerce.

Adaptador específico del vehículo, el cual se puede adquirir en el comercio especializado.

Cabo de adaptação específico do automóvel que pode ser adquirido no comércio especializado.

Araca özgü adaptör kablosunu yetkili satıcılarda bulabilirsiniz.

4.

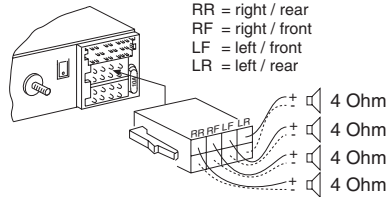

5.

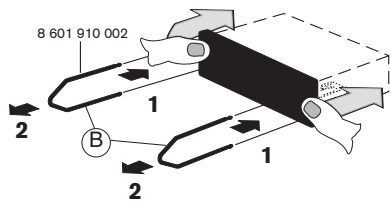

6.

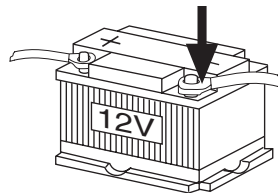



7.

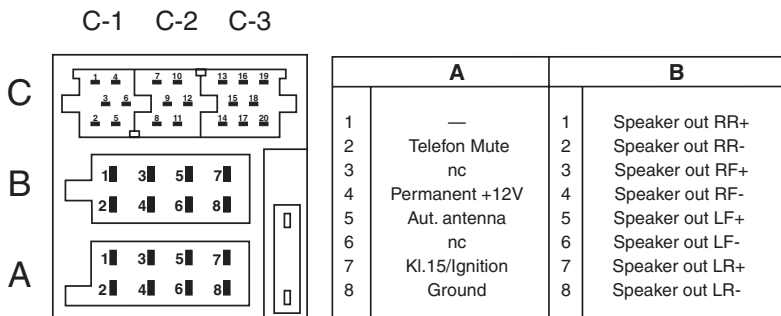

ENGLISH

FRANÇAIS

ESPAÑOL

PORTUGUÊS

TÜRKÇE

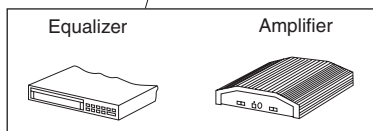
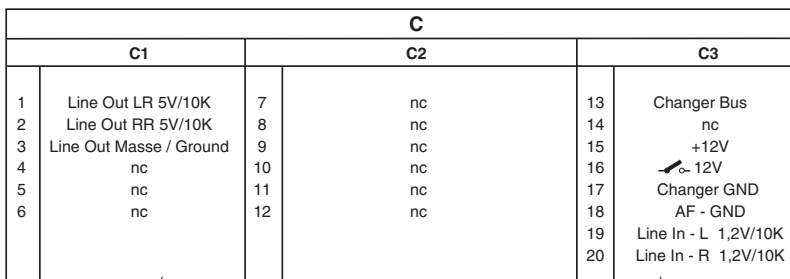

only
Lexington C 32



only
Lexington C 32





8.

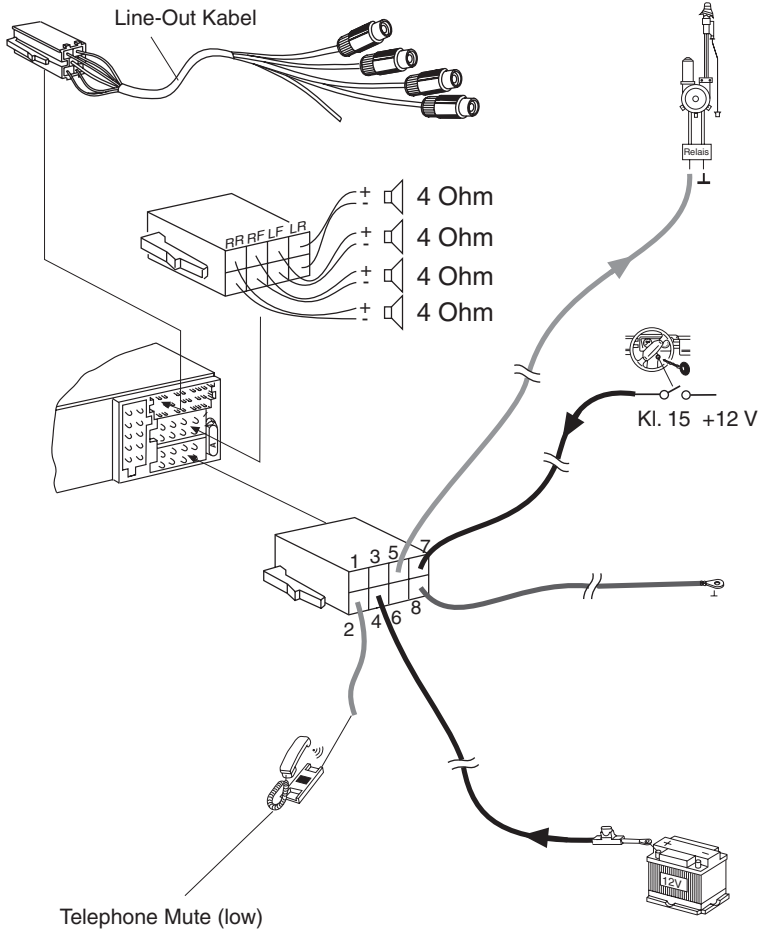

This information is subject to change without notice!
Sous réserve de modifications!
Modificaciones reservadas!
Sob reserva de alterações!
Bu bilgiler önceden haber verilmeksizin değiştirilebilir!





(TR) "Malın kullanım ömrü 10 yıldır"

Üretici firma: Blaupunkt GmbH, P.O.Box 98, D-31132 Hildesheim - ALMANYA

İthalatçı firma: BOSCH Sanayi ve Ticaret A.Ş., P.K.21, 34330 Levent-Istanbul

Please keep the filled-in radio pass in a safe place!
Prière de conserver soigneusement la carte d'autoradio remplie !
¡Favor guardar el documento del aparato debidamente llenado en un lugar seguro!
Por favor, guardar o cartão preenchido do aparelho num lugar seguro!
Lütfen doldurulmuş olan cihaz belgesini saklayınız!





Country:	Phone:	Fax:	WWW:
Germany com	(D) 0180-5000225	05121-49 4002	http://www.blaupunkt.com
Austria	(A) 01-610 39 0	01-610 39 391	
Belgium	(B) 02-525 5444	02-525 5263	
Denmark	(DK) 44 898 360	44-898 644	
Finland	(FIN) 09-435 991	09-435 99236	
France	(F) 01-4010 7007	01-4010 7320	
Great Britain	(GB) 01-89583 8880	01-89583 8394	
Greece	(GR) 210 94 27 337	210 94 12 711	
Ireland	(IRL) 01-46 66 700	01-46 66 706	
Italy	(I) 02-369 62331	02-369 62464	
Luxembourg	(L) 40 4078	40 2085	
Netherlands	(NL) 00 31 24 35 91 338	00 31 24 35 91 336	
Norway	(N) +47 64 87 89 60	+47 64 87 89 02	
Portugal	(P) 2185 00144	2185 00165	
Spain	(E) 902 52 77 70	91 410 4078	
Sweden	(S) 08-7501850	08-7501810	
Switzerland	(CH) 01-8471644	01-8471650	
Czech. Rep.	(CZ) 02-6130 0446	02-6130 0514	
Hungary	(H) 76 511 803	76 511 809	
Poland	(PL) 0800-118922	022-8771260	
Turkey	(TR) 0212-335 06 71	0212-346 00 40	
USA	(USA) 800-950-2528	708-6817188	
Brasil (Mercosur)	(BR) 0800 7045446	+55-19 3745 2773	
Malaysia (Asia Pacific)	(MAL) +604-6382 474	+604-6413 640	

01/07 - CM-AS/SCS1 (gb, fr, es, pt, tr)

Passport

Name:

Type: **7 642**

Serial no.: **BP**

 **BLAUPUNKT**



Blaupunkt GmbH, Robert-Bosch-Straße 200, D-31139 Hildesheim

