



Blu-ray Disc Player | BDP-S1E
Operating Instructions

WARNING

To reduce the risk of fire or electric shock, do not expose this apparatus to rain or moisture.

To avoid electrical shock, do not open the cabinet. Refer servicing to qualified personnel only.

The mains lead must be changed only at a qualified service shop.

Batteries or batteries installed apparatus shall not be exposed to excessive heat such as sunshine, fire or the like.

CAUTION

The use of optical instruments with this product will increase eye hazard. As the laser beam used in this Blu-ray Disc player is harmful to eyes, do not attempt to disassemble the cabinet.

Refer servicing to qualified personnel only.

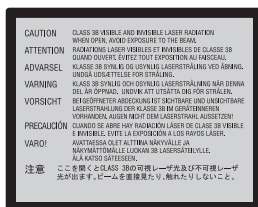



This label is located on the laser protective housing inside the enclosure.



This appliance is classified as a CLASS 1 LASER product. The CLASS 1 LASER PRODUCT MARKING is located on the laser protective housing inside the enclosure.

Notice for customers in the United Kingdom and Republic of Ireland

A moulded plug complying with BS1363 is fitted to this equipment for your safety and convenience. Should the fuse in the plug supplied need to be replaced, a fuse of the same rating as the supplied one and approved by ASTA or BSI to BS1362, (i.e., marked with  or  mark) must be used. If the plug supplied with this equipment has a detachable fuse cover, be sure to attach the fuse cover after you change the fuse. Never use the plug without the fuse cover. If you should lose the fuse cover, please contact your nearest Sony service station.



Disposal of Old Electrical & Electronic Equipment (Applicable in the European Union and other European countries with separate collection systems)

This symbol on the product or on its packaging indicates that this product shall not be treated as household waste. Instead it shall be handed over to the applicable collection point for the recycling of electrical and electronic equipment. By ensuring this product is disposed of correctly, you will help prevent potential negative consequences for the environment and human health, which could otherwise be caused by inappropriate waste handling of this product. The recycling of materials will help to conserve natural resources. For more detailed information about recycling of this product, please contact your local Civic Office, your household waste disposal service or the shop where you purchased the product.

The manufacturer of this product is Sony Corporation, 1-7-1 Konan Minato-ku Tokyo, 108-0075 Japan. The Authorized Representative for EMC and product safety is Sony Deutschland GmbH, Hedelfinger Strasse 61, 70327 Stuttgart, Germany. For any service or guarantee matters please refer to the addresses given in separate service or guarantee documents.

Precautions

Safety

- This unit operates on 220 – 240 V AC, 50/60 Hz. Check that the unit's operating voltage is identical with your local power supply.
- To prevent fire or shock hazard, do not place objects filled with liquids, such as vases, on the apparatus.

Installing

- Do not install the unit in an inclined position. It is designed to be operated in a horizontal position only.
- Keep the unit and discs away from equipment with strong magnet, such as microwave ovens, or large loudspeakers.
- Do not place heavy objects on the unit.
- Do not install this unit in a confined space, such as a bookshelf or similar unit.
- Install this unit so that the power cord can be unplugged from the wall socket immediately in the event of trouble.
- Do not expose the battery to excessive heat such as direct sunlight, fire or the like.

Notes About the Discs

- To keep the disc clean, handle the disc by its edge. Do not touch the surface.



- Do not expose the disc to direct sunlight or heat sources such as hot air ducts, or leave it in a car parked in direct sunlight as the temperature may rise considerably inside the car.
- After playing, store the disc in its case.
- Clean the disc with a cleaning cloth. Wipe the disc from the centre out.



- Do not use solvents such as benzene, thinner, commercially available disc/lens cleaners, or anti-static spray intended for vinyl LPs.
- If you have printed the disc's label, dry the label before playing.

Precautions

On safety

Should any solid object or liquid fall into the cabinet, unplug the player and have it checked by qualified personnel before operating it any further.

On power sources

- The player is not disconnected from the AC power source (mains) as long as it is connected to the wall outlet, even if the player itself has been turned off.
- If you are not going to use the player for a long time, be sure to disconnect the player from the wall outlet. To disconnect the AC power cord (mains lead), grasp the plug itself; never pull the cord.

On placement

- Place the player in a location with adequate ventilation to prevent heat build-up in the player.
- Do not place the player on a soft surface such as a rug.
- Do not place the player in a location near heat sources, or in a place subject to direct sunlight, excessive dust, or mechanical shock.
- The transparent part on the front panel surface is made of glass. Handle with care.

On operation

- If the player is brought directly from a cold to a warm location, or is placed in a very damp room, moisture may condense on the lenses inside the player. Should this occur, the player may not operate properly. In this case, remove the disc and leave the player turned on for about half an hour until the moisture evaporates.
- When you move the player, take out any discs. If you don't, the disc may be damaged.

On adjusting volume

Do not turn up the volume while listening to a section with very low level inputs or no audio signals. If you do, the speakers may be damaged when a peak level section is played.

On cleaning

Clean the cabinet, panel, and controls with a soft cloth slightly moistened with a mild detergent solution. Do not use any type of abrasive pad, scouring powder or solvent such as alcohol or benzene.

On cleaning discs, disc/lens cleaners

Do not use a commercially available cleaning disc or disc/lens cleaner (wet or spray type). These may cause the apparatus to malfunction.

On replacement of parts

In the events that this player is repaired, repaired parts may be collected for reuse or recycling purposes.

IMPORTANT NOTICE

Caution: This player is capable of holding a still video image or on-screen display image on your television screen indefinitely. If you leave the still video image or on-screen display image displayed on your TV for an extended period of time you risk permanent damage to your television screen. Plasma display panel televisions and projection televisions are susceptible to this.

If you have any questions or problems concerning your player, please consult your nearest Sony dealer.

Table of Contents

WARNING	2
Notes About the Discs	2
Precautions	3
Table of Contents	4
About this manual	5
This Player Can Play the Following	
Discs and Files	5
Examples of discs that the player cannot play	6
About playback of discs recorded in AVCHD format	6
BD/DVD region code	7
Note on playback operations of BDs/DVDs	7
Copyrights	7
Main Features	7

Getting Started

Step 1: Unpacking	9
Step 2: Connecting the Video Cords/HDMI Cord	10
Ⓐ Connecting to a video input jack	10
Ⓑ Connecting to an S VIDEO input jack	10
Ⓒ Connecting to component video input jacks (Y, PB/CB, PR/CR)	10
Ⓓ Connecting to an HDMI input jack	11
About the 'BRAVIA' Theatre Sync features (for HDMI connections only)	11
Step 3: Connecting the Audio Cords	12
Ⓐ Connecting to your TV	12
Ⓑ Connecting to a stereo amplifier (receiver) and 2 speakers	13
Ⓒ Connecting to an AV amplifier (receiver) having a Dolby Surround (Pro Logic) decoder and 3 to 6 speakers	14
Ⓓ-1 Connecting to an AV amplifier (receiver) with 5.1ch input jacks and 6 speakers	14
Ⓓ-2 Connecting to an AV amplifier (receiver) with a digital input jack and 6 speakers	15
Ⓓ-3 Connecting to an AV amplifier (receiver) with an HDMI input jack and 8 speakers	15
Step 4: Connecting the Mains Lead	16
Step 5: Preparing the Remote	16
If you want to control your TV with the supplied remote	17
Step 6: Easy Setup	18
Step 7: Additional Adjustments	19

Basic Operations

Playing a Disc	20
Guide to Displays	22
Entering characters	23
Guide to the Remote	24
Playing in various play mode	25
Searching using the remote	26
Checking the Disc Information	26
Clarifying Low Volume Sounds (Audio DRC)	27
Adjusting the Pictures	28
Fine-tuning the picture to your preference	28

Locking a Disc	29
Setting/changing the password	29
Setting the Parental Control for DVD VIDEOS	30
Setting the Parental Control for BD-ROMs	30

Watching Movie Files

Viewing All Titles	32
Playing a title	33
Browsing by Genre, Quicklist, or Folder	34
Searching for a Title	34
Programming Playback (Quicklist)	35

Listening to Music Files

Viewing All Artists	36
Playing a track	37
Browsing by Artist, Album, Genre, Quicklist, or Folder	38
Searching for a Track	38
Programming Playback (Quicklist)	39

Viewing Photo Files

Viewing All Folders	40
Playing a slideshow	41
Browsing by Date, Quicklist, or Folder	42
Searching for a Photo	42
Programming a Slideshow Playback (Quicklist)	43

Changing the Initial Settings

Using the Setup Displays	44
Video Setup	45
Audio Setup	47
Language	49
Parental Control	50
Speakers	51
Options	52
Resetting the Player	53





Additional Information

Troubleshooting	54
Self-Diagnosis Function	57
Index to Parts and Controls	58
Front panel	58
Front panel display	59
Rear panel	59
Glossary	60
Specifications	61
Language Code List	62
Parental Control Country/Area Code List	63
Index	63

About this manual

Instructions in this manual describe the controls on the remote. You can also use the controls on the player if they have the same or similar names as those on the remote.

The meanings of the icons used in this manual are described below:





Icon	Meaning
	Functions available for BD-ROMs including DL discs.
	Functions available for DVD VIDEOS and DVD+RWs/DVD+Rs in +VR mode or DVD-RWs/DVD-Rs in video mode, including 8 cm discs.
	Functions available for DATA DVDs (DVD+RWs/DVD+Rs/DVD-RWs/DVD-Rs containing MPEG-2 PS movie files, MP3* audio tracks, and JPEG image files).
	Functions available for music CDs or CD-Rs/CD-RWs in music CD Format.

* MP3 (MPEG-1 Audio Layer III) is a standard format defined by ISO (International Organization for Standardization)/IEC (International Electrotechnical Commission) MPEG which compresses audio data.

Note

The on-screen display illustrations used in this manual may not match the graphics displayed on your TV screen.

This Player Can Play the Following Discs and Files

Disc Format	
Blu-ray Disc	
DVD VIDEO	
DVD-RW/-R	
DVD+RW/+R	
CD	

“Blu-ray Disc” is a trademark.

“Blu-ray Disc,” “DVD+RW,” “DVD-RW,” “DVD+R,” “DVD-R,” “DVD VIDEO,” and “CD” logos are trademarks.

Supported file formats (DATA DVD only)

DVD+RWs/DVD-RWs/DVD+Rs/DVD-Rs are called “DATA DVD” in this manual when the discs contain playable files. The following file formats are supported:

- MPEG-2 PS movie files.
- MP3 music files.
- JPEG* image files.

* JPEG format conforming to UDF (Universal Disk Format).

Notes about BD-ROM compatibility

This player supports BD-ROM Profile 1 only. Playback of later versions and BDs other than BD-ROM is not guaranteed. Since the Blu-ray Disc specifications are new and evolving, some discs may not play depending on the disc type and the version. The audio output differs depending on the source, connected output jack, and selected audio settings. For details, see *page 48*.

→ continued

Examples of discs that the player cannot play

The player cannot play the following discs:

- BD-REs/BD-Rs.
- BDs with cartridge.
- DVD-RWs/DVD-Rs of VR mode.
- DVD-RAMs.
- HD DVDs.
- DVD Audio discs.
- DATA CDs (CD-Rs/CD-RWs other than music CD format).
- CD-ROMs recorded in PHOTO CD format.
- Data part of CD-Extras.
- VCDs/Super VCDs.
- HD layer on Super Audio CDs.

Also, the player cannot play the following discs:

- A BD-ROM/DVD VIDEO with a different region code.
- A disc that has a non-standard shape (e.g., card, heart).
- A disc with paper or stickers on it.
- A disc that has the adhesive of cellophane tape or a sticker still left on it.

Notes

- **Notes about DVD+RWs/DVD+Rs, DVD-RWs/DVD-Rs, or CD-Rs/CD-RWs**

Some DVD+RWs/DVD+Rs, DVD-RWs/DVD-Rs, or CD-Rs/CD-RWs cannot be played on this player due to the recording quality or physical condition of the disc, or the characteristics of the recording device and authoring software.

The DVD disc will not play if it has not been correctly finalized. For more information, refer to the operating instructions for the recording device. Note that some playback functions may not work with some DVD+RWs/DVD+Rs, even if they have been correctly finalized. In this case, view the disc by normal playback.

- **Music discs encoded with copyright protection technologies**

This product is designed to playback discs that conform to the Compact Disc (CD) standard. Recently, various music discs encoded with copyright protection technologies are being marketed by some record companies. Please be aware that among those discs, there are some that do not conform to the CD standard and may not be playable by this product.

- **Note on DualDiscs**

A DualDisc is a two sided disc product which mates DVD recorded material on one side with digital audio material on the other side.

However, since the audio material side does not conform to the Compact Disc (CD) standard, playback on this product is not guaranteed.

- **Note about double-layer DVDs**

The playback pictures and sound may be momentarily interrupted when the layers switch.

About playback of discs recorded in AVCHD format

This player can play AVCHD format discs.



What is the AVCHD format?

The AVCHD format is a high definition digital video camera format used to record SD (standard definition) or HD (high definition) signals of either the 1080i specification*¹ or the 720p specification*² on DVDs, using efficient data compression coding technology. The MPEG-4 AVC/H.264 format is adopted to compress video data, and the Dolby Digital or Linear PCM system is used to compress audio data. The MPEG-4 AVC/H.264 format is capable of compressing images at higher efficiency than that of the conventional image compressing format. The MPEG-4 AVC/H.264 format enables a high definition (HD) video signal shot on a digital video camera recorder to be recorded on DVD discs, in the same way as it would be for a standard definition (SD) television signal.

“AVCHD” and the AVCHD logo are trademarks of Matsushita Electric Industrial Co., Ltd. and Sony Corporation.

*¹ A high definition specification which utilizes 1080 effective scanning lines and the interlace system.

*² A high definition specification which utilizes 720 effective scanning lines and the progressive system.

Notes

- Some AVCHD format discs may not play, depending on the recording condition.
- The AVCHD format disc will not play if it has not been correctly finalized.

BD/DVD region code

Your player has a region code printed on the back of the unit and only will play BD-ROM/DVD VIDEOS (playback only) labelled with identical region codes. This system is used to protect copyrights.

DVD VIDEOS labelled  will also play on this player.

Depending on the BD-ROM/DVD VIDEO, there may be no region code indication, even though playing the BD-ROM/DVD VIDEO is prohibited by area restrictions.

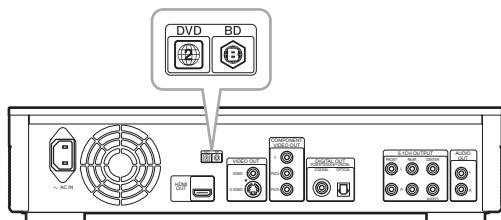

Note on playback operations of BDs/DVDs

Some playback operations of BDs/DVDs may be intentionally set by software producers. Since this player plays BDs/DVDs according to the disc contents the software producers designed, some playback features may not be available. Also, refer to the instructions supplied with the BDs/DVDs.

Copyrights

This product incorporates copyright protection technology that is protected by U.S. patents and other intellectual property rights. Use of this copyright protection technology must be authorized by Macrovision, and is intended for home and other limited viewing uses only unless otherwise authorized by Macrovision. Reverse engineering or disassembly is prohibited.

Main Features

Experience the high definition (HD) quality audio/video output and the library function of this Blu-ray Disc Player.

BD-ROM playback

BD-ROM is a next generation optical disc format in the HD era. Featuring massive storage capacity of 25 to 50 GB (five times larger than a DVD) and a high-speed transfer rate of up to 54 Mbps, the format offers not only uncompromised HD quality video*¹*², but also enables rich bonus content on a single disc and HD quality audio up to 8ch, and interactive operability.

*¹ A compatible HD display device is necessary to enjoy the same quality.

*² Some discs allow viewing only with an HDMI connection.

24p True Cinema

Movies shot with a film camera consist of 24 frames per second. Since conventional televisions (both CRT and flat panels) display frames either at 1/60 or 1/50 second intervals, the 24 frames do not appear at an even pace.

When connected to a TV with 24p capabilities, the player displays each frame at 1/24 second intervals — the same interval originally shot with the film camera, thus faithfully reproducing the original cinema image.

HDMI Control ('BRAVIA' Theatre Sync)

'BRAVIA' Theatre Sync Function makes operations simple by connecting Sony components that are compatible with the HDMI Control function with an HDMI cord (not supplied).

BD-J application

The BD-ROM format supports Java for interactive functions. "BD-J" offers content providers almost unlimited functionality when creating interactive BD-ROM titles*.

Java and all Java-based trademarks and logos are trademarks or registered trademarks of Sun Microsystems, Inc. in the U.S. and other countries.

Esmertec and Jbed are trademarks or registered trademarks of Esmertec AG.

© 2000-2007 Esmertec AG

* This player does not support downloadable BD-J content.

Support of uncompressed multi-channel Linear PCM

In combination with a compatible AV amplifier, the player can output up to 8ch Linear PCM surround sound*. With a non-compatible amplifier, the player can output 5.1ch analog signals from its 5.1CH OUTPUT jack for high quality audio enjoyment.

* Note that the DIGITAL OUT (COAXIAL or OPTICAL) jack does not output 8ch signals. You will need an HDMI cord and an HDMI-compatible device that support 8ch signals.

AVCHD format disc playback

The player supports AVCHD format files—high definition recordings made on AVCHD-compatible camcorders. Your high definition personal archive is readily playable in HD quality.

HDMI (High-Definition Multimedia Interface) digital interface

When connected to an HDMI-equipped display device using a single HDMI cord, the player can output both SD to HD video and multi-channel audio signals, in digital form without degradation.

The HDMI specification supports HDCP (High-bandwidth Digital Content Protection), a copy protection technology that incorporates coding technology for digital video signals.

Library function for recorded files (For JPEG image, MP3 audio, MPEG-2 PS movie files only)

With DATA DVDs created on other DVD devices, three separate movie/music/photo Title List-browsers allow for easy sorting, searching and playback including a slideshow.

Getting Started

Follow steps 1 to 7 to hook up and adjust the settings of the player.

For jack and button names, see “*Index to Parts and Controls*” (page 58).

Notes

- Plug cords securely to prevent unwanted noise.
- Refer to the instructions supplied with the components to be connected.
- You cannot connect this player to a TV that does not have a video input jack.
- Be sure to disconnect the mains lead of each component before connecting.
- Do not apply too much pressure on the connecting cords. Pushing against the cabinet wall, etc., may damage the cord.

- *Step 1: Unpacking* 9
- *Step 2: Connecting the Video Cords/
HDMI Cord* 10
- *Step 3: Connecting the Audio Cords* 12
- *Step 4: Connecting the Mains Lead* 16
- *Step 5: Preparing the Remote* 16
- *Step 6: Easy Setup* 18
- *Step 7: Additional Adjustments* 19

Step 1: Unpacking

Check that you have the following items:

- Video cord (phono plug × 1) (1)
- Stereo audio cord (phono plug × 2) (1)
- Mains lead (1)
- Remote commander (remote) (1)
- R6 (size AA) batteries (2)
- GNU License Information (English only) (1)

Step 2: Connecting the Video Cords/HDMI Cord

Connect this player to your TV monitor, projector or AV amplifier (receiver) using a video cord. Select one of the patterns (A) through (D), according to the input jack on your TV monitor, projector or AV amplifier (receiver).

In order to view 1080p progressive signals with a compatible TV, projector, or monitor with an HDMI input jack, you must select pattern (D). You can use pattern (C) to view 480p/576p/720p progressive signals or 1080i interlace signals on a compatible device with component video input jacks.

(A) Connecting to a video input jack

Connect the supplied video cord (yellow) to the yellow (video) jack. You will enjoy standard quality images.

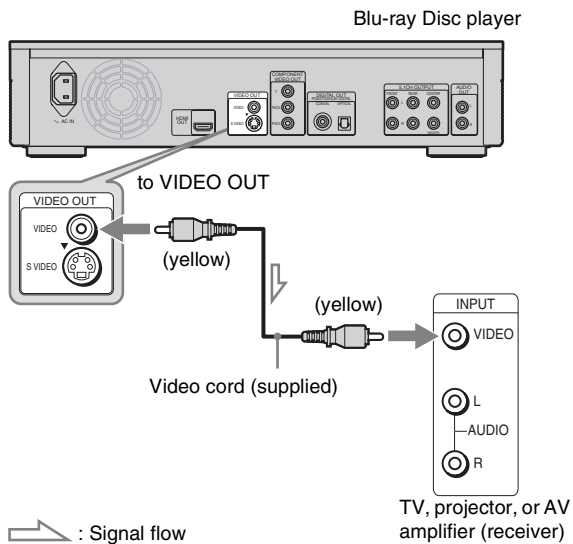

When connecting to a standard 4:3 screen TV

Depending on the disc, the image may not fit your TV screen. To change the aspect ratio, see *page 45*.

Note

Do not connect a VCR, etc., between your TV and the player. If you pass the player signals via the VCR, you may not receive a clear image on the TV screen. If your TV has only one audio/video input jack, connect the player to this jack.

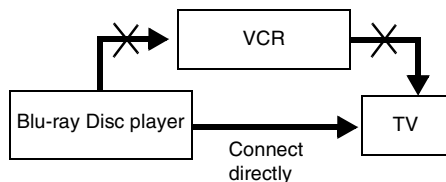

(B) Connecting to an S VIDEO input jack

Connect using an S VIDEO cord (not supplied). You will enjoy high quality images.

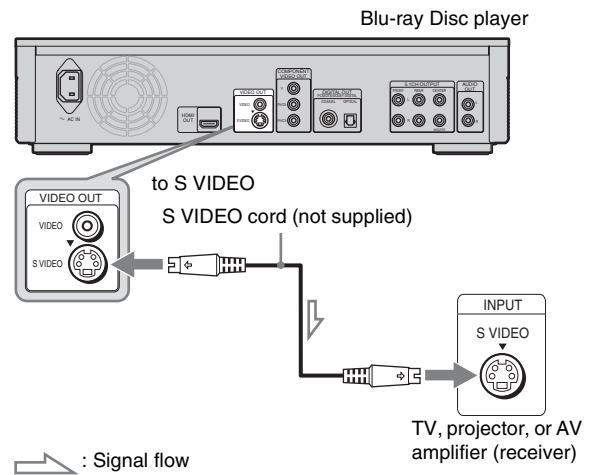

(C) Connecting to component video input jacks (Y, Pb/Cb, Pr/Cr)

Connect the component via the COMPONENT VIDEO OUT jacks using a component video cord (not supplied) or three video cords (not supplied) of the same kind and length. You will enjoy accurate colour reproduction and high quality images. You can also enjoy higher quality pictures from 480p/576p/720p progressive signals or 1080i interlace signals, if your TV, projector or AV amplifier (receiver) is compatible.

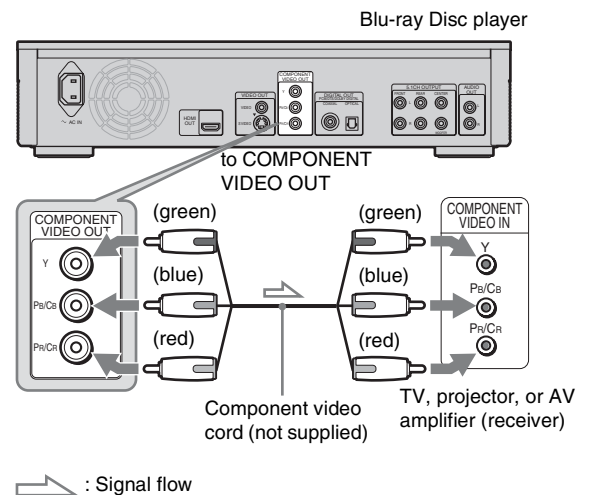

④ Connecting to an HDMI input jack

Use a certified Sony HDMI cord (not supplied) to enjoy high quality digital pictures and sound through the HDMI OUT jack. You will enjoy higher quality pictures from 480p/576p/1080i, or 1080p (highest among the player output), if your TV, projector or AV amplifier (receiver) is compatible.

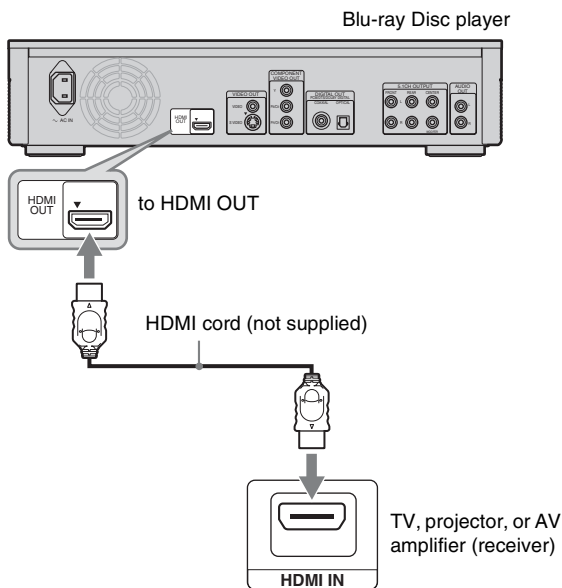

This Blu-ray Disc player incorporates High-Definition Multimedia Interface (HDMI™) technology. HDMI, the HDMI logo and High-Definition Multimedia Interface are trademarks or registered trademarks of HDMI Licensing LLC.

Notes on connecting to the HDMI OUT jack

Observe the following as improper handling may damage the HDMI OUT jack and the connector.

- Carefully align the HDMI OUT jack on the back of the player and the HDMI connector by checking their shapes. Make sure the connector is not upside down or tilted.

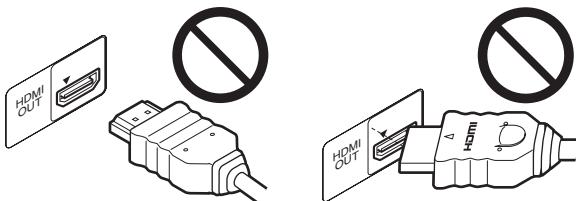

- Be sure to disconnect the HDMI cord when moving the player.

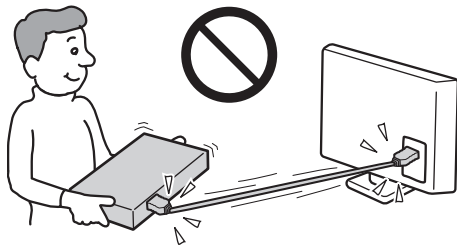

- If you place the player on the cabinet with the HDMI cord connected, do not apply too much pressure to the cabinet wall. It may damage the HDMI OUT jack or the HDMI cord.
- When connecting or disconnecting, do not screw in or rotate the HDMI connector.

About indicators for HDMI connection

After the player is turned on, the HD indicator on the front panel lights up when outputting 720p/1080i/1080p video signals. The HDMI indicator lights up when an HDMI device is connected.

Notes

- Consumers should note that not all high definition television sets are fully compatible with this product and may cause artifacts to be displayed in the picture. In the case of 480/576/720/1080 progressive scan picture problems, it is recommended that the user switch the connection to the 'standard definition' output. If there are questions regarding our TV set compatibility with this model 480p/576p/720p/1080p Blu-ray Disc player, please contact our customer service centre.
- If the picture is not clear, natural, or to your satisfaction, change the video output resolution by pressing VIDEO FORMAT (page 46).
- Be sure to use only an HDMI cord that bears the HDMI logo.

About the 'BRAVIA' Theatre Sync features (for HDMI connections only)

By connecting Sony components that are compatible with the HDMI Control function with an HDMI cord (not supplied), operation is simplified as below:

- One-Touch Play (page 21)
You can turn on the player and TV/AV receiver, set the TV/AV receiver's input to the player, and start playback with one touch of the  button.
- System Power-Off
When you turn the TV off by using the POWER button on the TV's remote, the HDMI compatible components turn off automatically.

To prepare for the 'BRAVIA' Theatre Sync features

Set "HDMI Control" of "Options" setup to "On" (page 52).

Note

Depending on the connected component, the HDMI Control function may not work. Refer to the operating instructions supplied with the component.

Step 3: Connecting the Audio Cords

Select the connection that best suits your system. Be sure to read the instructions for the components you wish to connect.

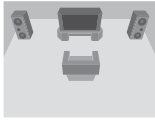
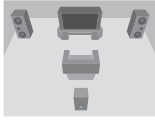
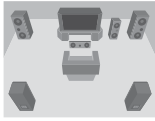
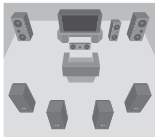
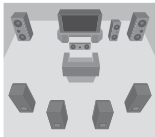
Connection	Your setup
A TV	
B Stereo amplifier (receiver) and two speakers	
C AV amplifier (receiver) having a Dolby^{*1} Surround (Pro Logic) decoder and 3 to 6 speakers <ul style="list-style-type: none"> • Surround effects: Dolby Surround (Pro Logic) 	
D-1 AV amplifier (receiver) with 5.1ch input jacks and 6 speakers <ul style="list-style-type: none"> • Surround effects: Dolby Digital (5.1ch), DTS (5.1ch) 	
D-2 AV amplifier (receiver) with a digital input jack having a Dolby Digital or DTS^{*2} decoder and 6 speakers <ul style="list-style-type: none"> • Surround effects: Dolby Digital (5.1ch), DTS (5.1ch) 	
D-3 AV amplifier (receiver) with an HDMI input jack and 8 speakers <ul style="list-style-type: none"> • Surround effects: 8ch Linear PCM 	

^{*1} Manufactured under license from Dolby laboratories. “Dolby,” “Pro Logic,” and the double-D symbol are trademarks of Dolby Laboratories.

^{*2} “DTS” and “DTS Digital Surround” are registered trademarks of DTS, Inc.

Notes about the HDMI OUT jack

- When you connect the player to an AV amplifier (receiver) using an HDMI cord, you will need to do one of the following:
 - Connect the AV amplifier (receiver) to a TV with the HDMI cord.
 - Connect the player to the TV with a video cord other than an HDMI cord (component video cord, S VIDEO cord, or video cord).
- When connecting to the HDMI OUT jack, carefully align the HDMI connector with the jack. Do not bend or apply pressure to the HDMI cord.
- If you change the component connected to the HDMI OUT jack, change “Audio (HDMI)” in “Audio Setup” to match the new component (*page 47*). The player stores the HDMI related settings for up to five components.
- The HDMI connection is compatible with 2ch Linear PCM signals (48 to 192 kHz, 16/20/24 bit), and 6 to 8ch Linear PCM signals (48 to 96 kHz, 16/20/24 bit), in addition to Dolby Digital and DTS bit stream (5.1ch signals up to 96 kHz, 16/20/24bit).

Note

If you connect a component that does not conform to the selected audio signal, a loud noise (or no sound) will come out from the speakers, which could damage your ears or speakers.

A Connecting to your TV

This connection will use your TV's speakers for sound.

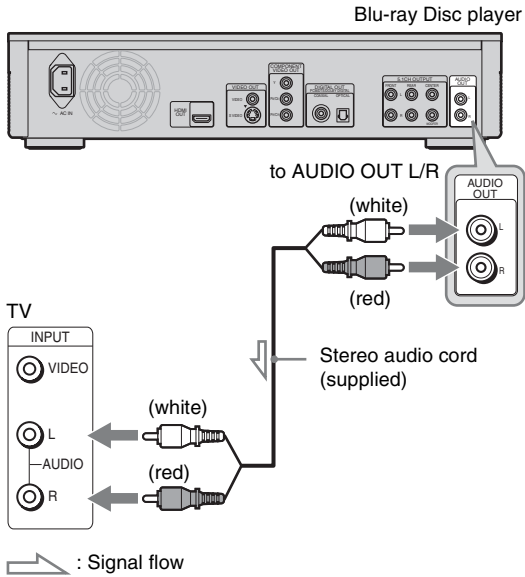

B Connecting to a stereo amplifier (receiver) and 2 speakers

If your stereo amplifier (receiver) only has audio input jacks L and R, use **B-1**. If your amplifier (receiver) has a digital input jack, use **B-2**.

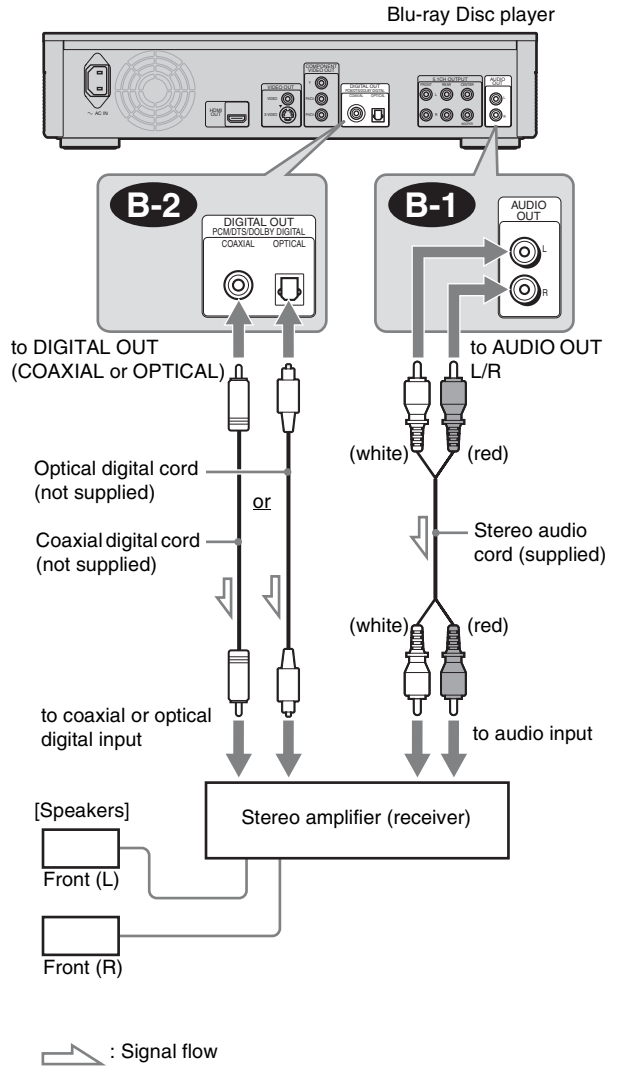

C Connecting to an AV amplifier (receiver) having a Dolby Surround (Pro Logic) decoder and 3 to 6 speakers

If your AV amplifier (receiver) only has L and R audio input jacks, use **C-1**. If your amplifier (receiver) has a digital input jack, use **C-2**.

You can enjoy surround effects only when playing Dolby Surround audio or multi-channel audio (Dolby Digital or DTS) discs.

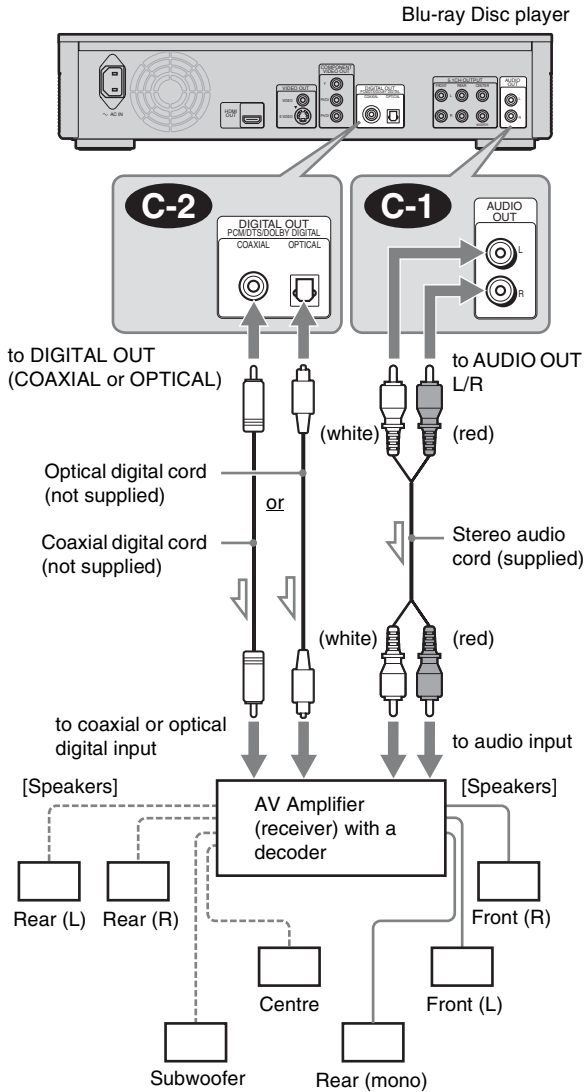

: Signal flow

Hint

For correct speaker location, see the operating instructions of the connected components.

Note

When connecting 6 speakers, you do not need the "Rear (mono)" speaker above.

D-1 Connecting to an AV amplifier (receiver) with 5.1ch input jacks and 6 speakers

If your AV amplifier (receiver) has 5.1 channel inputs, use **D-1**.

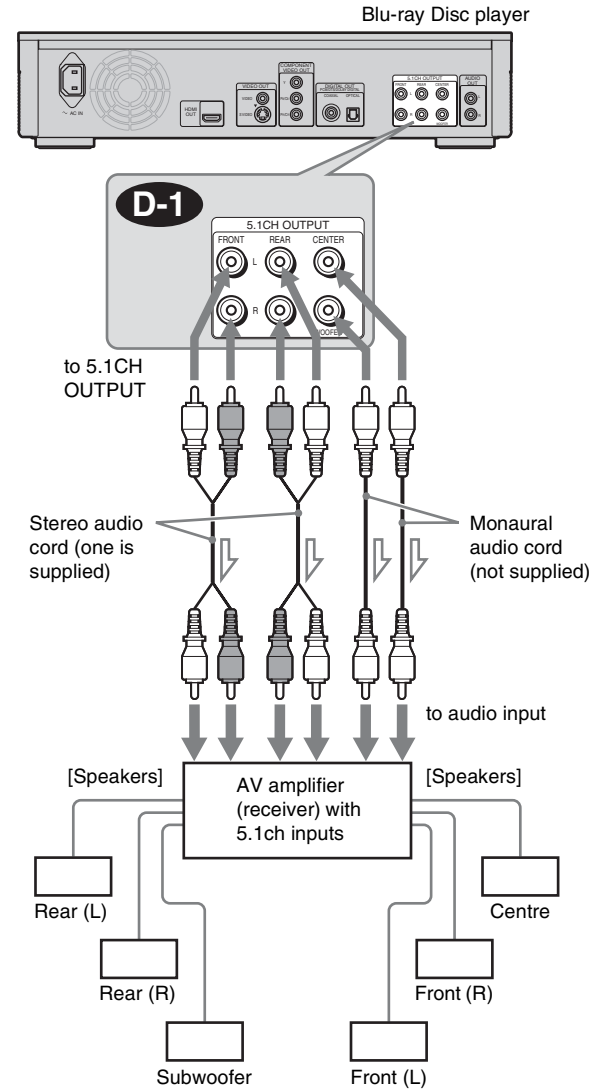

: Signal flow

Hint

For correct speaker location, see the operating instructions of the connected components.

D-2 Connecting to an AV amplifier (receiver) with a digital input jack and 6 speakers

If you want to use the Dolby Digital, or DTS decoder function on your AV amplifier (receiver), connect to its digital jack using **D-2**. You can enjoy a more realistic audio presence.

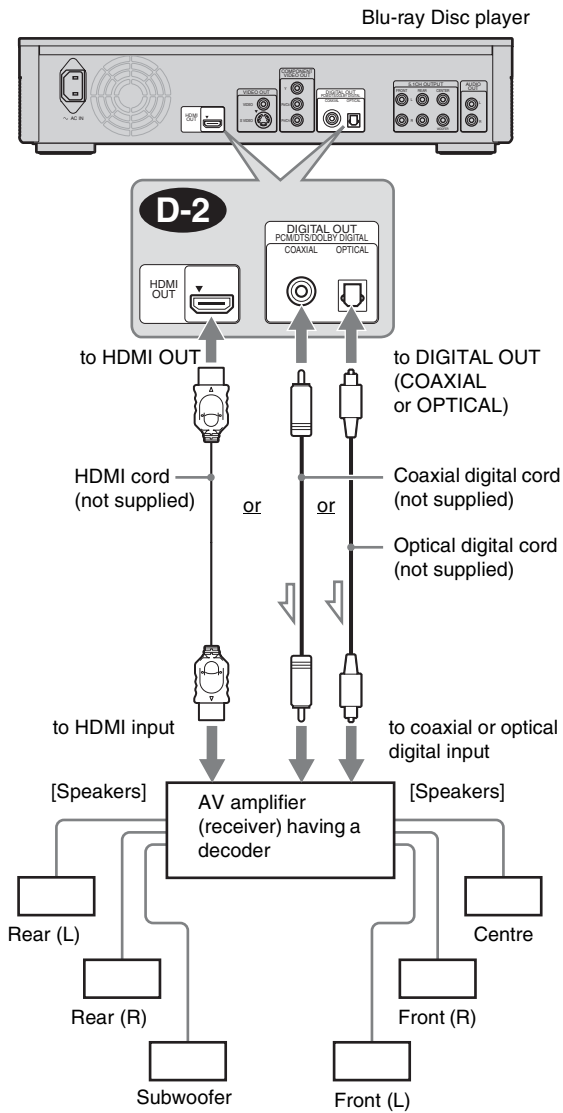

 : Signal flow

Hint

For correct speaker location, see the operating instructions of the connected components.

D-3 Connecting to an AV amplifier (receiver) with an HDMI input jack and 8 speakers

If your AV amplifier (receiver) accepts 8ch Linear PCM input with an HDMI connection, you can enjoy the surround sound using **D-3**.

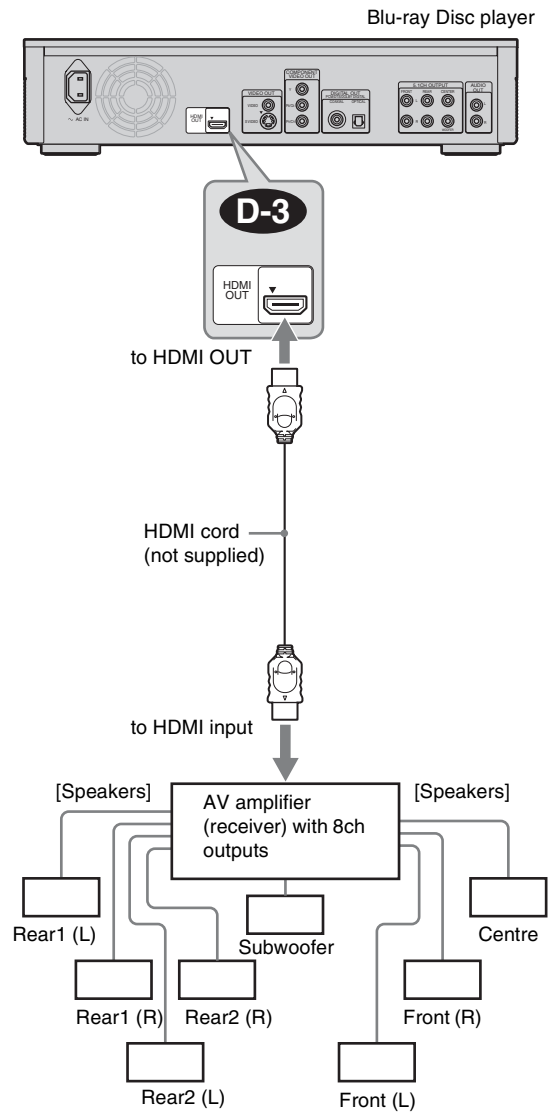

Hint

For correct speaker location, see the operating instructions of the connected components.

Note

Not all HDMI-compatible AV amplifiers (receivers) accept 8ch Linear PCM signals. See also the operating instructions supplied with the connected AV amplifier (receiver).

Step 4: Connecting the Mains Lead

After all of the other connections are complete, connect the supplied mains lead to the AC IN terminal of the player. Then plug the player and TV mains lead (power cords) into the mains.

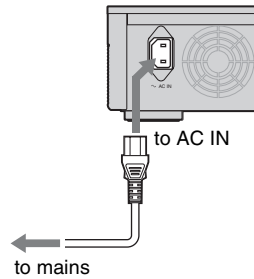

Step 5: Preparing the Remote

You can control the player using the supplied remote. Insert two R6 (size AA) batteries by matching the \oplus and \ominus ends on the batteries to the markings inside the battery compartment. When using the remote, point it at the remote sensor on the player (*page 58*).

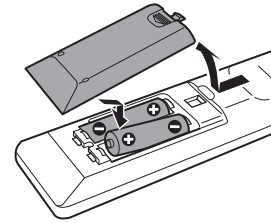

Notes

- Do not leave the remote in an extremely hot or humid place.
- Do not drop any foreign object into the remote casing, particularly when replacing the batteries.
- Do not expose the remote sensor to direct sunlight or a lighting apparatus. Doing so may cause a malfunction.
- If you do not use the remote for an extended period of time, remove the batteries to avoid possible damage from battery leakage and corrosion.

If you want to control your TV with the supplied remote

You can control the volume, input source, and power switch of your Sony TV with the supplied remote.

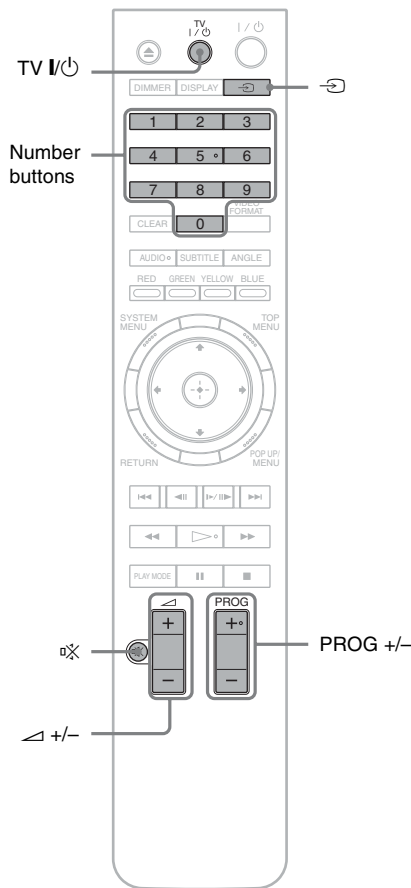

By pressing	You can
TV I/O	Turn the TV on or off.
∧ +/-	Adjust the volume of the TV.
↻	Switch the TV's input source between the TV and other input sources.
PROG +/-	Select the channel up and down.
⊘	Mute the sound (for Sony TV only).

To control other TVs with the remote

You can control the volume, input source, and power switch of non-Sony TVs as well.

If your TV is listed in the table below, set the appropriate manufacturer's code.

1 While holding down TV I/O, press the number buttons to select your TV manufacturer's code (see the table below).

2 Release TV I/O.

◆Code numbers of controllable TVs

If more than one code number is listed, try entering them one at a time until you find the one that works with your TV.

Manufacturer	Code number
Sony	01 (default)
Aiwa	01
Grundig	11
Hitachi	23, 24, 72
Loewe	06, 45
Nokia	15, 16, 69, 73
Panasonic	17, 49
Philips	06, 07, 08, 23, 45, 72
Saba	12, 13, 36, 43, 74, 75
Samsung	06, 22, 23, 71, 72
Sanyo	25
Sharp	29
Telefunken	12, 13, 36, 43, 74, 75
Thomson	12, 13, 43, 74, 75
Toshiba	38
LG	06
JVC	33

◆To return the remote to its default settings

- 1** Remove the batteries from the remote.
- 2** Re-insert the batteries while pressing down 1, 2, and 3 of the number buttons.
- 3** Wait for a few seconds.

Note

Depending on the connected unit, you may not be able to control your TV using all or some of the buttons on the supplied remote.

Step 6: Easy Setup

Follow the steps below to make the minimum number of basic adjustments for using the player. If you do not complete Easy Setup, it will appear each time you turn on your player. Make the settings below in the following order.

When turned on for the first time

Wait about 90 seconds before the player turns on and starts Easy Setup. The start-up time will be much shorter once Easy Setup is completed.

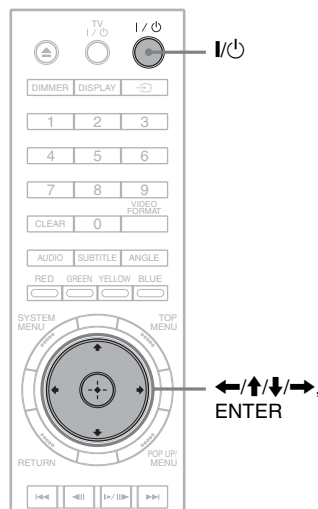

1 Turn on the TV.

2 Press **I/O** to turn on the player.
The player turns on after a moment.

3 Switch the input selector on your TV so that the signal from the player appears on your TV screen.

If the display for OSD language selection does not appear, select “Start” of “Easy Setup” in “Options” Setup (page 52).

4 Select the OSD language you want to display, and press **ENTER**.

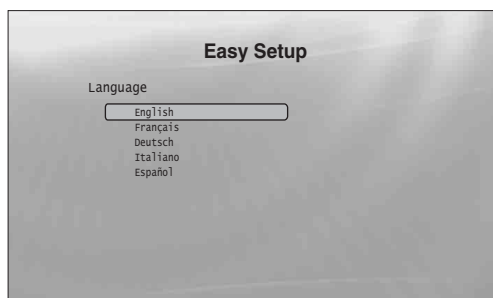

This will determine the Audio, Subtitle and BD/DVD menu languages as well.

5 Select “Start,” and press **ENTER** to start “Easy Setup.”

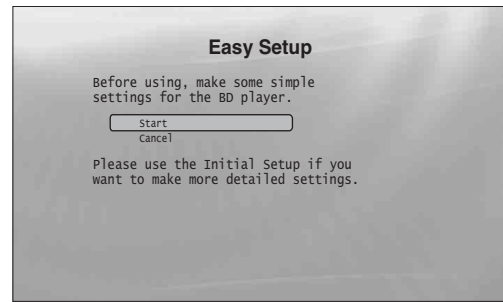

◆ If the above display does not appear

Go to step 6. This display appears only when the player is turned on for the first time.

6 Select the video output format for the connected TV, and press **ENTER**.

For details about the video output, see page 46.

◆ When using the HDMI OUT jack

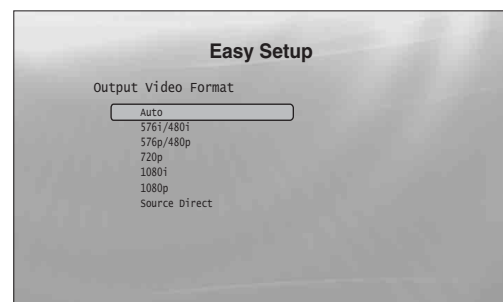

Select from “Auto,” “576i/480i,” “576p/480p,” “720p,” “1080i,” “1080p,” or “Source Direct,” then go to step 8. “TV Type” in step 7 will be set to “16:9” (wide screen).

◆ When using the jacks other than the HDMI OUT jack

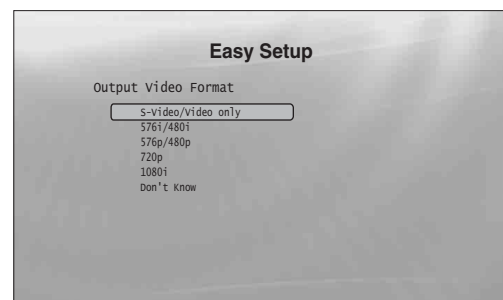

Select from “S-Video/Video only,” “576i/480i,” “576p/480p,” “720p,” “1080i” or “Don’t Know.” If you select “720p” or “1080i,” go to step 8. “TV Type” in step 7 will be set to “16:9” (wide screen).

- 7** Select the aspect ratio that matches your TV, and press ENTER.

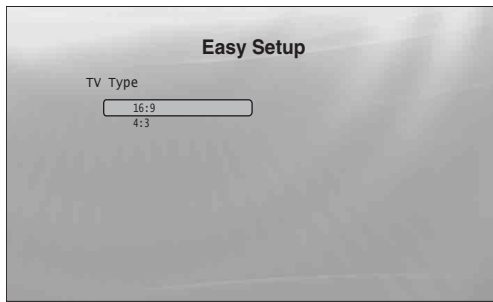

- ◆ **If you have a wide screen TV or a 4:3 standard TV with a wide screen mode**
Select “16:9” (page 45).
- ◆ **If you have a 4:3 standard TV**
Select “4:3” (page 45).

- 8** Select “Finish Setup,” and press ENTER.



🔧 Hints

- If you want to reset these settings to their factory defaults, see “Resetting the Player” (page 53).
- You can re-run “Easy Setup” from “Options” Setup (page 52).

Step 7: Additional Adjustments

The following settings and adjustments are necessary when your connection applies.

For video connection

- ◆ **When using the COMPONENT VIDEO OUT jacks**
(Pattern **C** –page 10)
 - Select the video output resolution for your TV by pressing VIDEO FORMAT (page 46).
- ◆ **When using the HDMI OUT jack**
(Pattern **D** –page 11)
 - Select the video output resolution for your TV by pressing VIDEO FORMAT (page 46).
 - Select the type of video output from the HDMI OUT jack in “YCbCr/RGBPC (HDMI)” of “Video Setup” (page 45).

For audio connection

- ◆ **When using the DIGITAL OUT (OPTICAL or COAXIAL) jack**
(Connection **B-2**, **C-2**, **D-2** –page 13 to 15)
 - Set “Dolby Digital Output” and “DTS Output” in “Audio Setup” (page 47) according to your AV amplifier’s (receiver’s) decoder.
- ◆ **When using the HDMI OUT jack**
(HDMI connection of **D-2**, **D-3** –page 15)
 - Set “Dolby Digital Output” and “DTS Output” in “Audio Setup” (page 47) according to your AV amplifier’s (receiver’s) decoder.
 - Select the audio output method from the HDMI OUT jack in “Audio (HDMI)” of “Audio Setup” (page 47).
- ◆ **When using the AUDIO OUT (L/R) jacks**
(Connection **C-1** –page 14)
 - Set “DTS Downmix” to “Lt/Rt” in “Audio Setup” (page 47).
- ◆ **When using the 5.1CH OUTPUT jacks**
(Connection **D-1** –page 14)
 - Set “Audio Output Mode” to “5.1 Channel” in “Speakers” Setup (page 51), and adjust the “Speaker Setup” setting for your system.

Notes

- If you connect a component that does not conform to the selected audio signal, a loud noise (or no sound) will come out from the speakers, which could damage your ears or speakers.
- If you connect using the HDMI OUT jack or COMPONENT VIDEO OUT jacks and the picture does not appear clearly, the connected display device may not be compatible with the progressive signals. In this case, connect the display device to the S VIDEO jack or the VIDEO jack (pattern **A**) or **B** – see page 10), re-run the “Easy Setup” from the “Options” Setup (page 52), and select “S-Video/Video only” in step 6 (page 18). Also, check the above items again to see if any additional adjustment is required.

Basic Operations

Most of the BD playback operations are common to DVD. This section covers BD/DVD/CD playback in general, together with the basic operation of the player.

For browsing recorded files on DATA DVDs*, a separate library function is available. See also *page 32* for movie, *36* for music, *40* for photo files.

For operations using the remote, a complete list is located on *page 24*.

* DVD+RWs/DVD+Rs/DVD-RWs/DVD-Rs containing MPEG-2 PS movie, MP3 audio, or JPEG image files.

- *Playing a Disc* 20
- *Guide to Displays* 22
- *Guide to the Remote* 24
- *Checking the Disc Information* 26
- *Clarifying Low Volume Sounds (Audio DRC)* . 27
- *Adjusting the Pictures* 28
- *Locking a Disc* 29

Playing a Disc

BD **DVD** **CD**

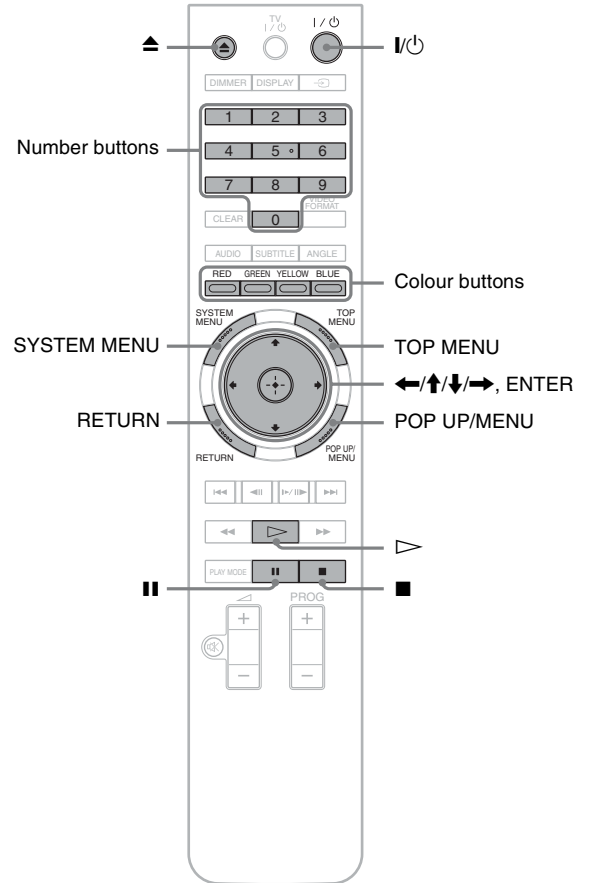

- 1** Press **I/O**.
The player turns on after a moment.
- 2** Switch the input selector on your TV so that the signal from the player appears on your TV screen.
- 3** Press **▲** to open the disc tray.
- 4** Place a disc on the disc tray with the playback side facing down.

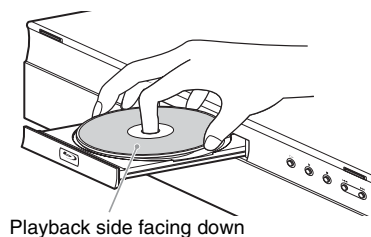





5 Press  to close the disc tray.





Wait a short while until the disc type appears on the front panel display.

6 Press  to start playback.

For more information about the remote's operations, see *page 24*.

Buttons	Details
	Pauses playback, or restarts playback from the same point.
	Stops playback, or cancels the resume point when pressed twice.
	Starts or restarts playback from the previous stop point.

7 When you finish playing, press  to open the disc tray.**8 Remove the disc, and press  again to close the disc tray.****9 Press  to turn off the player.****To use the BD's or DVD's menu**

When you play a BD-ROM, DVD VIDEO, or a finalized DVD+RW, DVD-RW (Video mode), DVD+R, or DVD-R (Video mode), you can display the disc's menu by pressing TOP MENU or POP UP/MENU. Some BDs/DVDs display the menu automatically. Either cases, navigate through the menu using , , , , ENTER, or the number buttons and the colour buttons as indicated by the disc's on-screen instructions. The BD menu is operable without interrupting playback.

To play restricted BDs

If "CAN'T PLAY" appears on the front panel display for a BD-ROM, change the "BD Parental Control" setting (*page 30*).

To play restricted DVDs

For a restricted DVD, the display asks for the password. For "DVD Parental Control" setting, see *page 30*.

1 Enter your four-digit password using the number buttons.**2 Press ENTER to confirm.**

To register or change the password, see *page 29*.

Notes about Resume Play

- Playback starts from the beginning if the title has not been played or the previous stop point is cancelled.
- The stop point is cancelled when:
 - you change the settings on the player.
 - you turn off the player (BD-ROM and CD only).
 - you press  twice.
 - you open the disc tray.
 - you finish a search.
- The player remembers the stop point for one title/track/file only. On a music CD, playback resumes from the beginning of the track.

About the screen saver function

To prevent damage to your display device (ghosting), a screen saver image appears when the player is left unattended, has no disc inserted, or no title/slideshow is displayed for 15 minutes. To cancel, press any button on the remote or the player.

About One-Touch Play (for HDMI connections only)

With one touch of the  button, the player and your TV/AV receiver automatically turn on and the TV/AV receiver's input is switched to the player. Playback starts automatically. To use this function, set "HDMI Control" of "Options" setup to "On" (*page 52*).

The TV/AV receiver's input will also switch to the player automatically, in the following cases:

- You press , SYSTEM MENU, TOP MENU, or POP UP/MENU buttons on the remote.
- A disc with auto playback function is loaded.

Guide to Displays

BD **DVD** **DATA DVD** **CD**

When 'Select an item, and press ENTER' appears in this manual, press the **←/↑/↓/→** keys on the remote to select the item then the entry button in the middle. You can operate the player likewise using displays.



1 Press **SYSTEM MENU** to turn on the above "System Menu."

The player's start menu appears, with entries to all of the functions.

2 Select an item, and press **ENTER**.

Each item leads to the following function displays. See the pages in parentheses for operations. When you want to return to the previous display, press **RETURN**.

Title List

For DATA DVDs, this display leads further to the Title Lists of content type. The three Title Lists appear similar and are operable in a similar way.



Select the Title List you want to view; from "Movies," "Photos," or "Music," and press **ENTER**.

◆ **Movies**

Displays movies/video titles only (page 32).

◆ **Photos**

Displays image files only (page 40).

◆ **Music**

Displays music files only (page 36).

A/V Control (page 27)

Adjusts the audio/video settings. Select either "Video Control," or "Audio Control," and press **ENTER**.

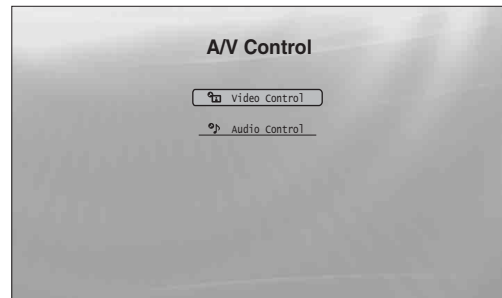

Setup (page 44)

Enters the Setup displays for changing the player's settings. Select the related Setup display, and press **ENTER**.

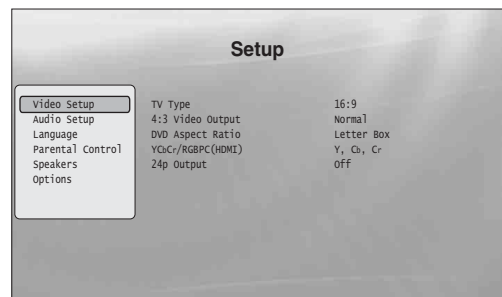

Entering characters

DATA DVD

When an on-screen keyboard appears (e.g., when searching for a title), enter the characters as follows.

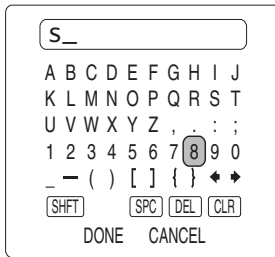

1 Select the character you want to enter, and press ENTER.

The character appears in the entry field. If necessary, select the following items, and press ENTER.

Items	Details
SHFT	Switches between upper and lower case characters. Select this before entering the character.
SPC	Inserts a space.
DEL	Deletes the last character input.
CLR	Clears all input characters.

2 Repeat step 1 to complete the entry.

3 Select “DONE,” and press ENTER to close the on-screen keyboard.

Note

You cannot use the extended character set.

Guide to the Remote

The following covers all of the remote's functions. Refer to the list when necessary.

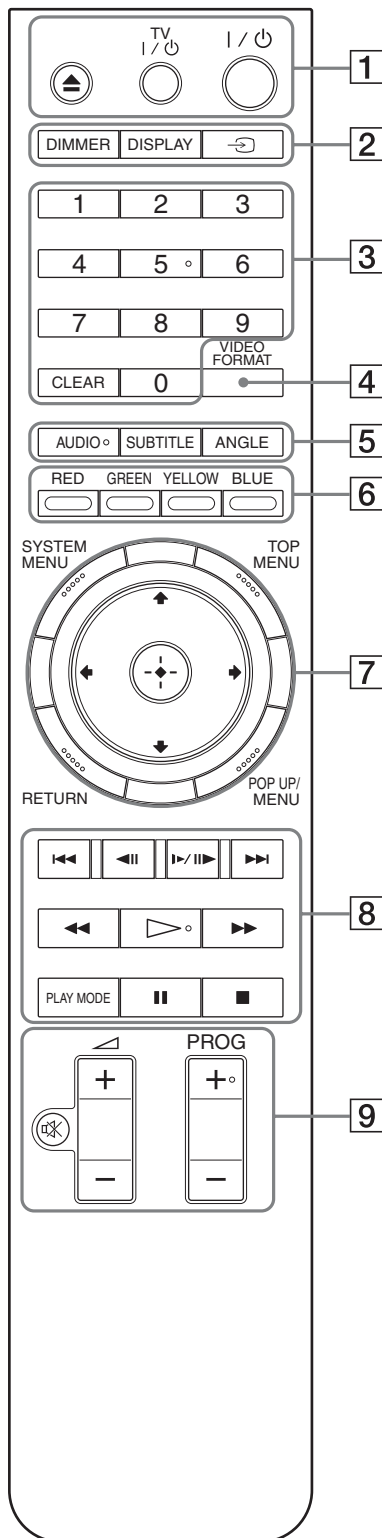

1 ▲ (open/close) (page 20)

– Opens/closes the disc tray.

TV I/⏻ (on/standby) (page 17)

– Turns the TV on or to standby mode.

I/⏻ (on/standby) (page 18)

– Turns on, or sets the player to standby mode.

2 DIMMER (page 59)

– Changes the brightness of the front panel display on the player (when completely darkened, indicators on the front panel are also turned off and the FL OFF indicator lights up).

DISPLAY (page 26)

– Displays the disc information on the screen.

↻ (TV/video) (page 17)

– Switches between TV and other input sources.

3 Number buttons (page 26)

– Enters the title/chapter numbers, etc.

CLEAR

– Clears the entry field.

4 VIDEO FORMAT (page 45)

– Changes the video output resolution from the HDMI OUT jack and the COMPONENT VIDEO OUT jacks. Press this button repeatedly if no picture appears.

5 AUDIO*¹ (page 49)

– Selects the sound track or the language track on a BD/DVD.

*¹ When playing MPEG-2 movie files or MP3 music files on a DATA DVD, or a music CD, you cannot select the left or right channel only.

SUBTITLE (page 49)

– Selects the subtitle language on a BD/DVD.

ANGLE

– Switches to other viewing angles when available.

6 Colour buttons (RED/GREEN/YELLOW/BLUE)

– Short cut keys for selecting items on some BD's menus (can also be used for BD's Java interactive operations).

Number 5, AUDIO, PROG+, and ▷ buttons have a tactile dot. Use the tactile dot as a reference when operating the player.

7 SYSTEM MENU (page 22)

- Enters/exits the player's start menu ("System Menu").

TOP MENU (page 20)

- Opens/closes the BD's or DVD's top menu.

POP UP/MENU (page 20)

- Opens/closes the BD's pop up menu, or the DVD's disc menu.

RETURN (page 20, 22)

- Returns to the previous display.

←/↑/↓/→ (page 20, 22)

- Moves the highlight to select a displayed item.

Centre button (ENTER) (page 20, 22)

- Enters the selected item.

8 I◀◀/▶▶I (previous/next)

- Skips to the previous/next chapter, track, or file.

◀◀/▶▶II (slow/step)*2

- Plays in slow motion or stop motion. To return to normal play, press ▷.
- To play in slow motion
Press ▶▶II▶▶ during playback. When slow motion play starts, press ▶▶II▶▶ repeatedly to change the speed : 1/16 → 1/8 → 1/4 → 1/2 of normal playback speed.
- To play in stop motion (step by step)
Press II during playback, then press ◀◀II or ▶▶II▶▶ repeatedly.

◀◀/▶▶ (scan)*2

- Scans backwards or forward. The speed changes when pressed repeatedly.

*2 Depending on the disc or file type, the function may not work or the scan speeds may differ.

▷ (play)

- Starts or re-starts playback.

PLAY MODE

- Switches to other play modes (Repeat Play, etc.) when pressed during playback.
- Searches for a specific point (page 26).

II (pause)

- Pauses/re-starts playback.

■ (stop)

- Stops playback.
- Clears the resume point when pressed twice. The resume point for a title is the last point you played, the last track for an audio file, or the last photo for a photo file.

- 9** For TVs operable with the following buttons, see page 17.

⊗ (muting) (page 17)

- Mutes the TV sound.

◁ (volume) +/- (page 17)

- Adjusts the TV volume.

PROG (programme) +/- (page 17)

- Selects the TV channels up and down.

Playing in various play mode

BD **DVD** **DATA DVD** **CD**

1 During playback, press PLAY MODE repeatedly.

Available items differ depending on the current title/track/file or the disc type. To cancel the Play Mode, press PLAY MODE again. For "Time Search," see "Searching using the remote" (page 26).

◆When playing a video or movie title

Items	Details
Repeat Chapter (BD-ROM/DVD VIDEO only)	Repeats the current chapter.
Repeat Title	Repeats the current title.

◆When playing a music track

Items	Details
Repeat Track	Repeats the current track.
Repeat All	Repeats all the tracks on the disc or the "Music" Title List.
Random	Plays all the tracks on the disc or the "Music" Title List in a random order.

◆When playing a photo image

Items	Details
Repeat All	Repeats all the files on the disc or "Photos" Title List.
Random	Plays all the files on the disc or "Photos" Title List in a random order.

Searching using the remote

BD **DVD** **DATA DVD**

You can search by entering the title/chapter number or the time code (elapsed time from the beginning of the disc).

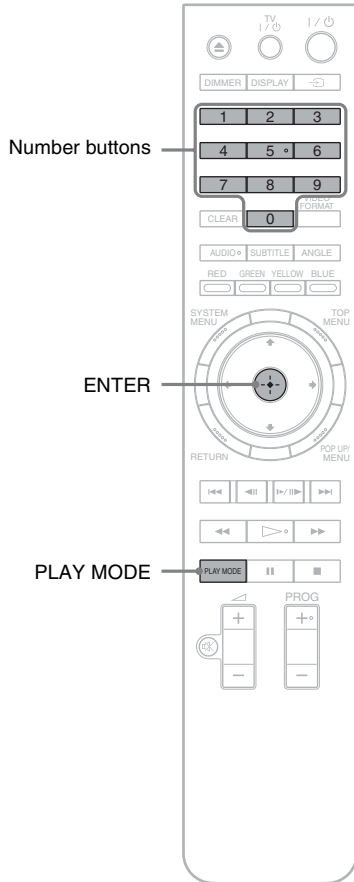

To search for a title or chapter (BD-ROM, DVD VIDEO only)

- 1 Enter the title number using the number buttons while the player is in stop mode.**
To search for a chapter, enter the chapter number during playback. If you make a mistake, press CLEAR once and re-enter.
- 2 Press ENTER to start playback.**

To search for a specific point

- 1 During playback, press PLAY MODE repeatedly until "Time Search" appears.**
- 2 Enter the time code using the number buttons.**
Enter the time in minutes and seconds (e.g., '12030' for 1 hour, 20 minutes and 30 seconds). If you make a mistake, press CLEAR once and re-enter.
- 3 Press ENTER to start playback.**

Note

Depending on the DVD VIDEO/BD-ROM/DATA DVD, these search functions may not work.

Checking the Disc Information

BD **DVD** **DATA DVD** **CD**

You can check the title/chapter/track information including video transmission rate etc., by pressing DISPLAY. The information differs depending on the disc type and the player status.

1 Press DISPLAY.

Example: When playing a DVD VIDEO.

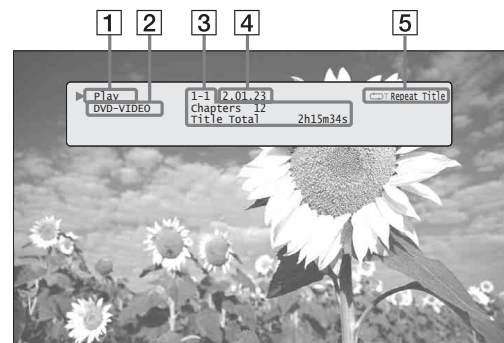

The following information appears:

- 1 Playback status**
- 2 Disc type**
- 3 Title information**
 - Currently playing title number/currently playing chapter number.
 - Total number of chapters within the title.
 - Total playback time of the title.
- 4 Elapsed time of the current title**
- 5 Play mode**

2 Press DISPLAY again.



The display switches to show the following information:

- 1 Chapter information**
 - Elapsed time of the current chapter.
 - Total playback time of the current chapter.
- 2 Video transmission rate and the stream information**

Hints

- You can check disc information also on the front panel display (page 59) or the Title List display (page 22).
- You can check the audio information by pressing AUDIO.

Clarifying Low Volume Sounds (Audio DRC)

BD **DVD** **DATA DVD**

Even at low volume, you can make low sounds such as dialogues more audible.

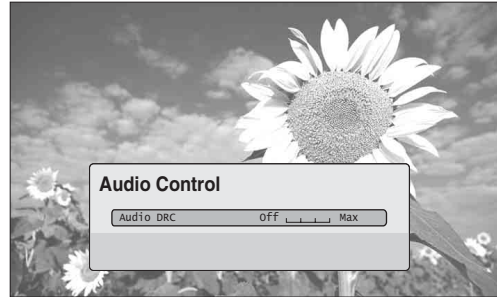

Convenient when you cannot turn up the volume (e.g., at night)

- 1** Press **SYSTEM MENU** during playback.
- 2** Select “A/V Control,” and press **ENTER**.
- 3** Select “Audio Control,” and press **ENTER** to turn on the above display.
- 4** While “Audio DRC” is highlighted, select from “Max” to “Off” by pressing **←/→**.
- 5** Press **ENTER**.

Note

“Audio DRC” is effective only when the disc is a Dolby Digital Blu-ray Disc or DVD, and:

- “Dolby Digital Output” in “Audio Setup” is set to “Downmix PCM” (page 47) and the audio signals are output from the DIGITAL OUT (OPTICAL or COAXIAL) jack or the HDMI OUT jack.
- “Audio (HDMI)” in “Audio Setup” is set to “PCM” (page 47) and the audio signals are output from the HDMI OUT jack.
- the audio signals are output from the AUDIO OUT (L/R) jacks or the 5.1CH OUTPUT jacks.

Adjusting the Pictures

BD DVD DATA DVD

The “cinema tuned” picture preset setting will allow you to maximize the visual impact of the BD or DVD you are watching by optimizing the picture settings for different lighting environments. “Memory” allows you to make your own detailed adjustments.

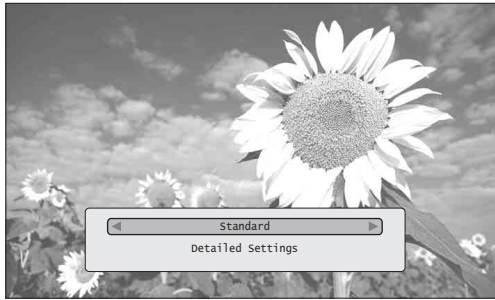

- 1** Press **SYSTEM MENU** during playback.
- 2** Select “A/V Control,” and press **ENTER**.
- 3** Select “Video Control,” and press **ENTER** to turn on the above display.
- 4** Press **←/→** to select a setting.

Items	Details
Brighter Room	For a room brighter than normal.
Theatre Room	For a dark room such as a home theatre.
Standard (default)	Normally, select this.
Memory (1-3)	Select a setting when you want to use the detailed picture adjustments you previously made, or when you want to make a new set. The player remembers up to three sets (see page 28).

- 5** Press **ENTER**.

Hint

The above description applies when the picture setting of your TV (if any) is set to ‘Standard.’

Note

“Memory” settings do not affect the output from the S VIDEO OUT or VIDEO OUT jacks.

Fine-tuning the picture to your preference

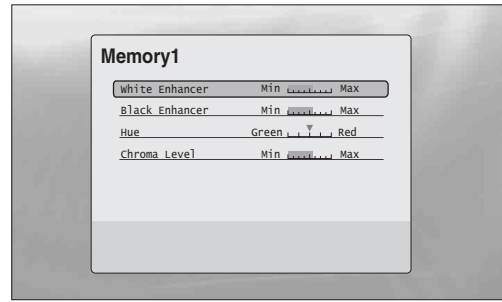

- 1** Select from “Memory 1” to “Memory 3” in step 4 of “Adjusting the Pictures” (page 28).
- 2** Select “Detailed Settings,” and press **ENTER** to turn on the above display.
To switch to another “Memory,” press **RETURN**.
- 3** Select each of the picture elements, and adjust using **←/→**.

◆ **To adjust while previewing the effect**

Select a setting and press **ENTER** to switch the display for the setting. Press **←/→** to adjust while checking the effect on the background playback picture. Then press **ENTER** to save the adjustment.

Underlined are the default settings for “Memory.”

Items	Details
White Enhancer (Min~ <u>(mid)</u> ~Max)	Adjusts the brightness of white colours.
Black Enhancer (Min~ <u>(mid)</u> ~Max)	Adjusts the richness of dark colours.
Hue (Green~ <u>(mid)</u> ~Red)	Balances the green and the red colours.
Chroma Level (Min~ <u>(mid)</u> ~Max)	Adjusts the colour saturation.

- 4** Press **RETURN**.

Locking a Disc

BD DVD

By setting the password and your limit in “Parental Control” Setup, you can control playback of inappropriate discs.

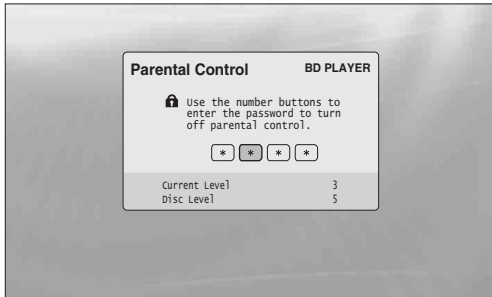

The password is required when the DVD exceeds the level you set.

Notes

- You cannot limit playback if the DVD VIDEO/BD-ROM does not have the “Parental Control” function.
- If you forget the password, you will have to return all of the player settings to their factory defaults (page 53).
- The above display does not appear for BD-ROM. If you cannot play a BD-ROM because of Parental Control, reset “Change Age Restriction” of “BD Parental Control” (page 30).

Setting/changing the password

BD DVD

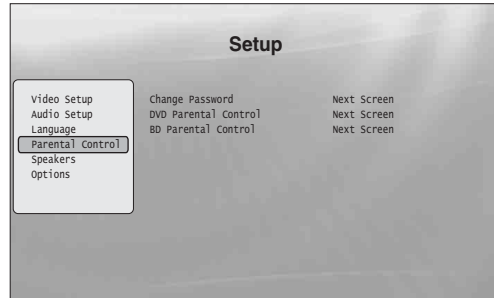

- 1** Press **SYSTEM MENU**.
- 2** Select “Setup,” and press **ENTER**.
- 3** Select “Parental Control,” and press **ENTER** to turn on the above “Parental Control” Setup.
- 4** Select “Change Password (Set Password),” and press **ENTER**.
- 5** Select “Next Screen,” and press **ENTER** to turn on the password display.
 - ◆ **When you have not yet registered a password**
Enter a four-digit password using the number buttons, and press **↓**. Re-enter it for confirmation, and press **ENTER**.
 - ◆ **When you have already registered a password**
Enter the four-digit password using the number buttons, and press **ENTER**. Enter a new password and press **↓**, then re-enter it for confirmation, and press **ENTER**.

Hint

To continue to set “DVD Parental Control,” go to step 4 of “Setting the Parental Control for DVD VIDEOS” (page 30).

Setting the Parental Control for DVD VIDEOS

DVD

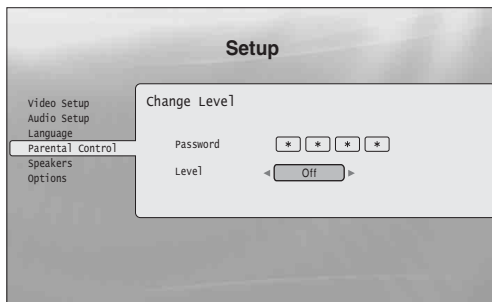

- 1 Press SYSTEM MENU.
- 2 Select “Setup,” and press ENTER.
- 3 Select “Parental Control,” and press ENTER to turn on the “Parental Control” Setup.
- 4 Select “DVD Parental Control,” and press ENTER.
- 5 Select “Change Level,” and press ENTER to turn on the above display.
This will set the playback limitation level.
- 6 Enter the password using the number buttons, and press ENTER.
- 7 Press \leftarrow/\rightarrow to select the limitation level from “Off” to “Level 8,” and press ENTER.
Note that the lower the value, the stricter the limitation.
- 8 When the display returns to the “Parental Control” Setup, select “DVD Parental Control,” and press ENTER.
- 9 Select “DVD Country Code,” and press ENTER.
This ensures that you see the scenes intended for your residential area.
- 10 On the “DVD Country Code” display, enter the password using the number buttons, and press ENTER.
- 11 Press \leftarrow/\rightarrow to select your country code (see page 63), or press \downarrow and enter the code for your area using the number buttons.
- 12 Press ENTER.

Hint

To continue to set “BD Parental Control,” go to step 4 of “Setting the Parental Control for BD-ROMs” (page 30).

Setting the Parental Control for BD-ROMs

BD



- 1 Press SYSTEM MENU.
- 2 Select “Setup,” and press ENTER.
- 3 Select “Parental Control,” and press ENTER to turn on the “Parental Control” Setup.
- 4 Select “BD Parental Control,” and press ENTER.
- 5 Select “Change Age Restriction,” and press ENTER to turn on the above display.
For BD-ROMs, the restriction is set by age, not by level.
- 6 Enter the password using the number buttons, and press ENTER.
- 7 Press \leftarrow/\rightarrow to select the age from “0” to “255,” and press ENTER.
- 8 When the display returns to the “Parental Control” Setup, select “BD Parental Control,” and press ENTER.
- 9 Select “BD Country Code,” and press ENTER.
This ensures that you see the scenes intended for your residential area.
- 10 On the “BD Country Code” display, enter the password using the number buttons, and press ENTER.
- 11 Press \leftarrow/\rightarrow to select your country code (see page 63), or press \downarrow and enter the code for your area using the number buttons.
- 12 Press ENTER.

Watching Movie Files

Use the “Movies” Title List to browse through and sort MPEG-2 PS movie files on DATA DVDs.

Viewing All Titles

DATA DVD

The “Movies” Title List first displays all titles on the disc.

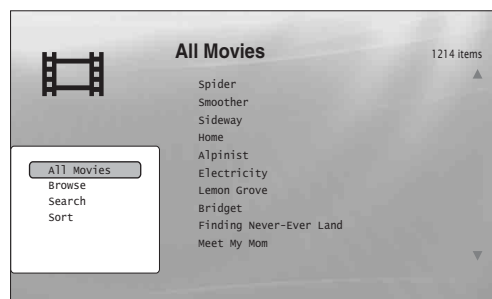

The Browse menu appears when you press ←

- 1** Press **SYSTEM MENU**.
- 2** Select “Title List,” and press **ENTER**.
- 3** Select “Movies,” and press **ENTER**.
The above “All Movies” display appears, showing all titles (scrollable by pressing ↓). From “All Movies” you can apply items to all titles using the Browse menu (see below).

To use the Browse menu

Press ← after step 3 to display the items for the “Movies” Title List. For operations, see the pages in parentheses. Available items differ depending on the display.

Items	Details
All Movies	Lists all titles (as above).
Browse	Displays a list of genres, Quicklist, or folders (page 34).
Search	Searches for a title using the on-screen keyboard (page 34).
Sort	Reorders the titles by date or alphabet (see below).

◆Example: To apply “Sort” to all titles

- 1** Select “Sort,” and press **ENTER**.
- 2** Select the setting you want to sort by; “Recent first,” “Oldest first,” “By title (A→Z),” “By title (Z→A),” and press **ENTER**.

- *Viewing All Titles* 32
- *Browsing by Genre, Quicklist, or Folder* 34
- *Searching for a Title* 34
- *Programming Playback (Quicklist)* 35

Playing a title

- 1 After step 3 of “Viewing All Titles” above, select the title you want to play, and press **ENTER** or **▷**.

The title starts playing. You can apply other playback settings to the selected title using the “Options” menu (see below).

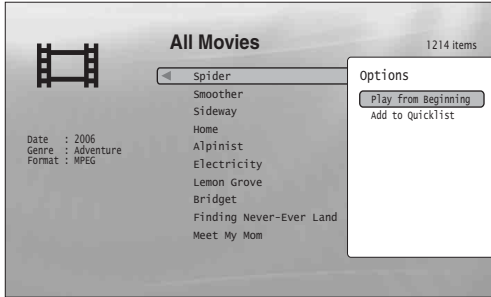

The “Options” menu appears when you select a title and press **→**

To use the “Options” menu

Press **→** instead of **ENTER** in the above step to display the “Options” menu settings applicable to the title in the given situation. In the above example, the following items are available.

Items	Details
Play from Beginning	Starts playing the title you selected from the beginning.
Add to Quicklist	Adds the selected title to the Quicklist.

◆ **Example: To apply “Play from Beginning” to the selected title**

- 1 Select “Play from Beginning,” and press **ENTER**.

To play in other play mode

During playback, press **PLAY MODE** repeatedly. The selected item changes with each press: “Time Search” (page 26) — “Repeat Title” — “Repeat Off”
See page 25 for details.

Hint

See page 24 for the remote’s operations.

About the “Movies” (All Movies) Title List display

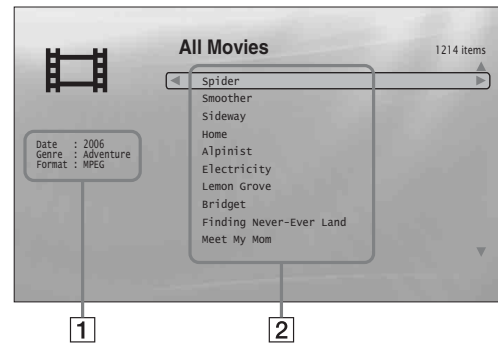

- 1 **Detailed information**
Displays details about the selected title.
 - Date: Displays the recording year.
 - Genre: Displays the genre name.
 - Format: Displays the coding format.
- 2 **List area**
Displays the title names of all content.

Browsing by Genre, Quicklist, or Folder

DATA DVD

Narrow down the list of titles by selecting the category type (e.g., “Folders”), then the category.



- 1** Press **SYSTEM MENU**.
- 2** Select “Title List,” and press **ENTER**.
- 3** Select “Movies,” and press **ENTER**.
- 4** Press **←** to turn on the Browse menu.
- 5** Select “Browse,” and press **ENTER**.
- 6** Select the list you want to view from “Genres,” “Quicklist,” or “Folders,” and press **ENTER**.
The list of genres/Quicklist/folders appears as above. For details about the Quicklist, see “Programming Playback (Quicklist)” (page 35).
- 7** Select the genre/Quicklist/folder you want to view, and press **ENTER**.

Hint

You can select a title and start playback by pressing **▷** or **ENTER**, or using the “Options” menu (press **→**).

Searching for a Title

DATA DVD

You can find the exact title, or titles with a similar name.

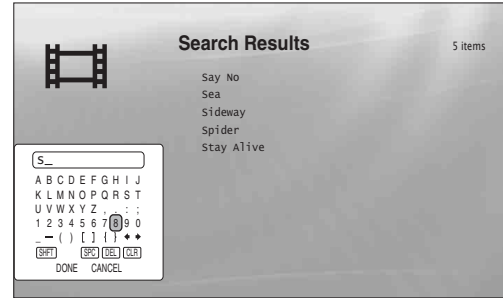

Search results are narrowed down as more characters are entered

- 1** Press **SYSTEM MENU**.
- 2** Select “Title List,” and press **ENTER**.
- 3** Select “Movies,” and press **ENTER**.
- 4** Press **←** to turn on the Browse menu.
- 5** Select “Search,” and press **ENTER** to turn on the above display.
- 6** Enter the title name using the on-screen keyboard (see page 23).

Hint

You can select a title and start playback by pressing **▷** or **ENTER**, or using the “Options” menu (press **→**).

Programming Playback (Quicklist)

DATA DVD

Play your favourite titles in the order you like by making your own “Quicklist.”

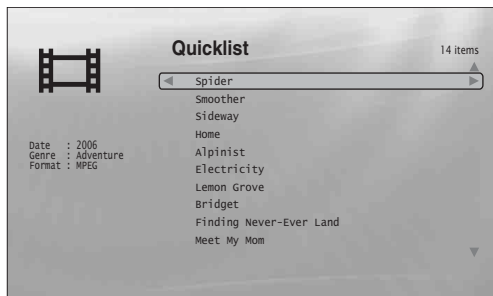

The “Quicklist” does not affect the original recording on the disc

- 1 Press SYSTEM MENU.**
- 2 Select “Title List,” and press ENTER.**
- 3 Select “Movies,” and press ENTER.**
- 4 When the “All Movies” Title List appears, select the title you want to add to the top of the “Quicklist,” and press →.**
- 5 Select “Add to Quicklist” from the “Options” menu, and press ENTER.**
- 6 Repeat step 4 and 5 to select all the desired titles.**

Select in the order you want to play. You can add the same title multiple times.
The “Quicklist” can contain up to 25 titles.
- 7 Press ← to turn on the Browse menu.**
- 8 Select “Browse,” and press ENTER.**
- 9 Select “Quicklist,” and press ENTER to turn on the above display.**

The “Quicklist” Title List appears with the programmed content.
- 10 Select the title you want to start playback, and press ENTER.**

To remove the title from the “Quicklist”

- 1 Select the title you want to remove from the displayed “Quicklist,” and press →.**
- 2 Select “Remove,” and press ENTER.**

Hint

You can play the “Quicklist” content in other play modes by pressing PLAY MODE (page 25).

Note

The “Quicklist” may be cleared after some operations (e.g., opening the disc tray, or turning off the player etc.).

Listening to Music Files

Use the “Music” Title List to browse through and play the MP3 track files on DATA DVDs. You can make a “Quicklist” of your favourites and play in various play modes.

- *Viewing All Artists* 36
- *Browsing by Artist, Album, Genre, Quicklist, or Folder* 38
- *Searching for a Track* 38
- *Programming Playback (Quicklist)* 39

Viewing All Artists

DATA DVD

The “Music” Title List first displays a list of the artist names on the disc.



The Browse menu appears when you press ←

- 1** Press **SYSTEM MENU**.
- 2** Select “Title List,” and press **ENTER**.
- 3** Select “Music,” and press **ENTER**.
The above “Artists” display appears, showing all artist names (scrollable by pressing ↓). From “Artists” you can apply items to all tracks using the Browse menu (see below).

To use the Browse menu

Press ← after step 3 to display the items for the “Music” Title List. For operations, see the pages in parentheses. Available items differ depending on the display.

Items	Details
All Songs	Lists all tracks (page 37).
Browse	Displays a list of artists, albums, genres, Quicklist, or folders (page 38).
Search	Searches for a track using the on-screen keyboard (page 38).
Sort	Reorders the tracks by alphabet, or year, etc. (see below).
Now Playing	Displays the track information and the playback information during playback.

◆Example: To apply “Sort” to all tracks

- 1** To display the list of tracks, select “All Songs” from the Browse menu and press **ENTER**.
- 2** Press ← to turn on the Browse menu.
- 3** Select “Sort,” and press **ENTER**.
- 4** Select the setting you want to sort by; “Recent first,” “Oldest first,” “By title (A→Z),” “By title (Z→A),” “By artist (A→Z),” “By artist (Z→A),” and press **ENTER**.

Playing a track

- 1 After step 3 of “Viewing All Artists” above, narrow down the list of tracks by selecting the artist, then the album.

To list all tracks, press **←** and select “All Songs” from the Browse menu.

- 2 Select the track you want to play, and press **ENTER** or **▷**.

The title starts playing. You can apply other playback settings to the selected track using the “Options” menu (see below).

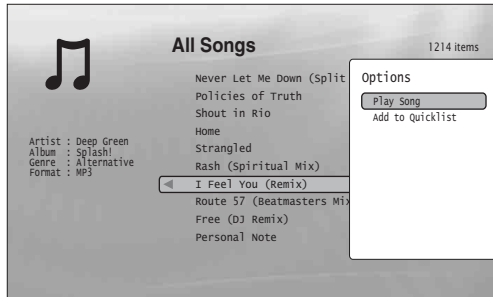

The “Options” menu appears when you select a track and press **→**

To use the “Options” menu

Press **→** instead of **ENTER** in the above step to display the “Options” menu settings applicable to the track in the given situation. In the above example, the following items are available.

Items	Details
Play Song	Starts playing the track you selected from the beginning.
Add to Quicklist	Adds the selected track to the Quicklist.

◆ Example: To apply “Play Song” to the selected track

- 1 Select “Play Song,” and press **ENTER**.

To play in other play mode

During playback, press **PLAY MODE** repeatedly. The selected item changes with each press: “Repeat Track” — “Repeat All” — “Random” — “Repeat Off”

See page 25 for details.

🔔 Hints

- See page 24 for the remote’s operations.
- Even after stopping playback, the player resumes playback from the last track you played.
- Depending on the writing software used, the displayed track or album names may be different from the characters you input.

Notes

- Playback time of MP3 audio tracks may not be displayed correctly.
- If you put an extension “.MP3” to a non-MP3 file, the file may accidentally play on the player. Note that such output may cause the connected device to malfunction.
- Playback may not start immediately after skipping to another album.
- When using the Resume function on MP3 tracks, playback starts from the beginning of the track.

About the “Music” (All Songs) Title List display

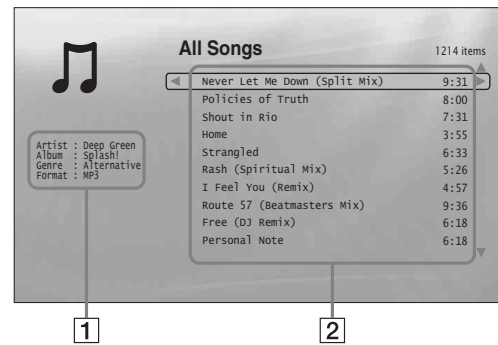

- 1 Detailed information

Displays details about the selected track.

- Artist: Displays the artist name.
- Album: Displays the album name.
- Genre: Displays the genre name.
- Format: Displays the coding format.

- 2 List area

Displays overall content.

- Main area: Displays the track names.
- Sub area: Displays the total playback time of each track.

About unplayable audio track files

The player does not play the file if:

- The DATA DVD is not recorded in an MP3 format that conforms to UDF (Universal Disk Format).
- The audio track file does not have the extension “.MP3.”
- The data is not formatted properly even though it has the extension “.MP3.”
- The data is not MPEG-1 Audio Layer III data.
- The data is recorded in mp3PRO format.
- The file name contains characters other than numbers and English alphabet.

Browsing by Artist, Album, Genre, Quicklist, or Folder

DATA DVD

Narrow down the list of tracks by selecting the category type (e.g., “Genres”), then the category.

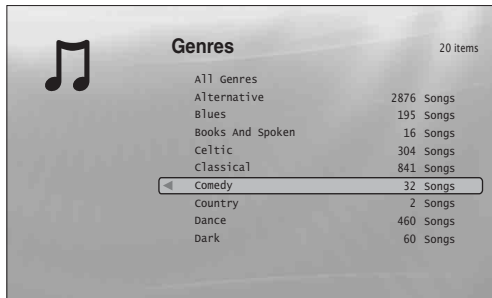

Genres without content do not appear in the list

- 1 Press **SYSTEM MENU**.
- 2 Select “Title List,” and press **ENTER**.
- 3 Select “Music,” and press **ENTER**.
- 4 Press **←** to turn on the Browse menu.
- 5 Select “Browse,” and press **ENTER**.
- 6 Select the list you want to view from “Artists,” “Albums,” “Genres,” “Quicklist” or “Folders,” and press **ENTER**.
The list of artists/albums/genres/Quicklist/folders appears as above.
For details about the Quicklist, see “Programming Playback (Quicklist)” (page 39).
- 7 Select the artist/album/genre/Quicklist/folder you want to view, and press **ENTER**.

Hint

You can select a track from the list of tracks, and start playback by pressing **ENTER** or **▷**, or using the “Options” menu (press **➡**).

Searching for a Track

DATA DVD

You can find the exact track, or tracks with a similar name.

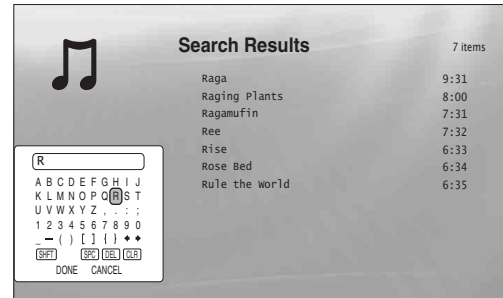

Search results are narrowed down as more characters are entered

- 1 Press **SYSTEM MENU**.
- 2 Select “Title List,” and press **ENTER**.
- 3 Select “Music,” and press **ENTER**.
- 4 Press **←** to turn on the Browse menu.
- 5 Select “All Songs,” and press **ENTER**.
- 6 Press **←** to turn on the Browse menu.
- 7 Select “Search,” and press **ENTER** to turn on the above display.
- 8 Enter the track name using the on-screen keyboard (see page 23).

Hints

- You can select a track from the search result, and start playback by pressing **ENTER** or **▷**, or using the “Options” menu (press **➡**).
- You can search for a genre, artist, album, or folder name from each Title List (e.g., “Genres”).

Programming Playback (Quicklist)

DATA DVD

Play your favourite tracks in the order you like by making your own “Quicklist.”

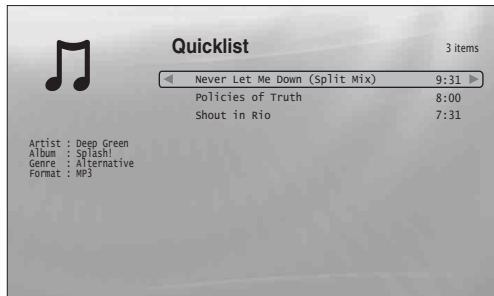

The “Quicklist” does not affect the original recording on the disc

- 1 Press SYSTEM MENU.**
- 2 Select “Title List,” and press ENTER.**
- 3 Select “Music,” and press ENTER.**
- 4 Press ← to turn on the Browse menu.**
- 5 Select “All Songs,” and press ENTER.**
- 6 When the “All Songs” Title List appears, select the track you want to add to the top of the “Quicklist,” and press →.**
- 7 Select “Add to Quicklist” from the “Options” menu, and press ENTER.**
- 8 Repeat step 6 and 7 to select all the desired tracks.**

Select in the order you want to play. You can add the same track multiple times.
The “Quicklist” can contain up to 25 tracks.
- 9 Press ← to turn on the Browse menu.**
- 10 Select “Browse,” and press ENTER.**
- 11 Select “Quicklist,” and press ENTER to turn on the above display.**

The “Quicklist” Title List appears with the programmed content.
- 12 Select the track you want to start playback, and press ENTER.**

To remove the title from the “Quicklist”

- 1 Select the track you want to remove from the displayed “Quicklist,” and press →.**
- 2 Select “Remove,” and press ENTER.**

Hint

You can play the “Quicklist” content in other play modes by pressing PLAY MODE (page 25).

Note

The “Quicklist” may be cleared after some operations (e.g., opening the disc tray, or turning off the player etc.).

Viewing Photo Files

Use the “Photos” Title List to view the JPEG images on DATA DVDs. You can reorder the files and start playing a slideshow.

- *Viewing All Folders* 40
- *Browsing by Date, Quicklist, or Folder* 42
- *Searching for a Photo* 42
- *Programming a Slideshow Playback (Quicklist)* 43

Viewing All Folders

DATA DVD

The “Photos” Title List first displays all the folders on the disc.

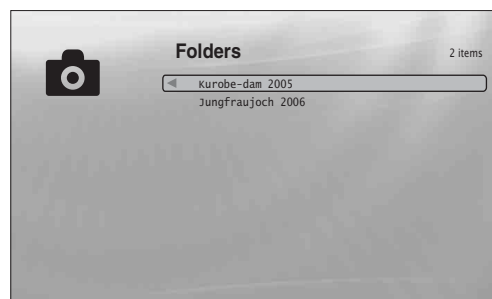

The Browse menu appears when you press ← while on the leftmost row

- 1** Press **SYSTEM MENU**.
- 2** Select **“Title List,”** and press **ENTER**.
- 3** Select **“Photos,”** and press **ENTER**.
The above “Folders” display appears, showing all folders (scrollable by pressing ↓). From “Folders” you can apply items to all files using the Browse menu (see below).

To use the Browse menu

Press ← after step 3 to display the items for “Photos” Title List. For operations, see the pages in parentheses. Available items differ depending on the display.

Items	Details
All Photos	Displays all files in alphabetical order (page 41).
Browse	Displays a list of dates, Quicklist, or folders (page 42).
Search	Searches for a file using the on-screen keyboard (page 42).
Sort	Reorders the files by date or alphabet (see below).

◆Example: To apply “Sort” to all files

- 1** To display the list of all files, select **“All Photos”** from the Browse menu and press **ENTER**.
- 2** Move the highlight to the left most row, and press ← to turn on the Browse menu.
- 3** Select **“Sort,”** and press **ENTER**.
- 4** Select the setting you want to sort by; **“Recent first,”** **“Oldest first,”** **“By title (A→Z),”** **“By title (Z→A),”** and press **ENTER**.

Playing a slideshow

- 1 After step 3 of “Viewing All Folders” above, press **←** and select “All Photos” from the Browse menu.
- 2 Select the file you want to start from, and press **ENTER** to turn on the “Options” menu.
- 3 Select “Slideshow,” and press **ENTER**. Slideshow starts.
You can apply other playback settings to the selected file using the “Options” menu (see below).

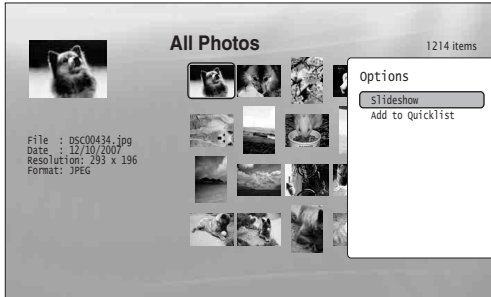

The “Options” menu appears when you select a file and press **ENTER**

To use the “Options” menu

Available “Options” menu settings differ depending on the situation. In the above example of the use of the “Options” menu, the following items are available.

Items	Details
Slideshow	Starts playing a slideshow as above.
Add to Quicklist	Adds the selected file to the Quicklist for later slideshow playback.

To play in other play mode

During playback, press **PLAY MODE** repeatedly. The selected item changes with each press:

“Repeat All” — “Random” — “Repeat Off”

See *page 25* for details.

🔔 Hints

- See *page 24* for the remote’s operations.
- Even after stopping playback, the player resumes playback from the last file you played.

Note

The photos may appear slowly depending on the size and the number of files.

About the “Photos” (All Photos) Title List display

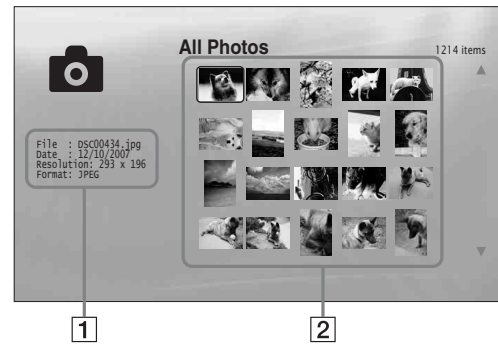

1 Detailed information

Displays details about the selected file.

- File: Displays the file name.
- Date: Displays the shooting date.
- Resolution: Displays the picture resolution in width × height.
- Format: Displays the recording format.

2 List area

Displays overall photo content in thumbnail.

About unplayable photo files

The player does not play the file if:

- The DATA DVD is not recorded in a JPEG format that conforms to UDF (Universal Disk Format).
- The photo file is not recorded in a format that conforms to the DCF*.
- The file has an extension other than “.JPEG.”
- The image is larger than 4,096 (width) × 4,096 (height) in normal mode, or progressive JPEG.
- The image does not fit the screen (the image is reduced).
- The file name contains characters other than numbers and English alphabet.
- Even when the above are not applicable, some files may not play depending on the recording condition or the method (e.g., writer software).
- Files may not play on this player if edited on a PC.
- * “Design rule for Camera File system”: Image standards for digital cameras regulated by JEITA (Japan Electronics and Information Technology Industries Association).

Browsing by Date, Quicklist, or Folder

DATA DVD

Narrow down the list of files by selecting the category type (e.g., “Date”), then the category.

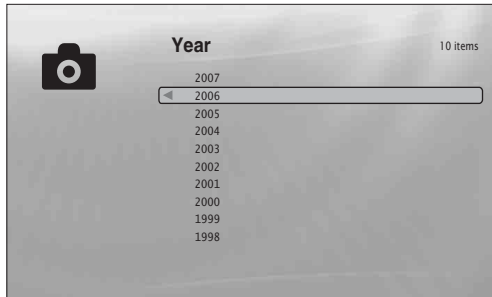

- 1 Press SYSTEM MENU.
- 2 Select “Title List,” and press ENTER.
- 3 Select “Photos,” and press ENTER.
- 4 Press ← to turn on the Browse menu.
- 5 Select “Browse,” and press ENTER.
- 6 Select the list you want to view from “Date,” “Quicklist,” or “Folders” and press ENTER. The list of date/Quicklist/folders appears as above. For details about the Quicklist, see “Programming a Slideshow Playback (Quicklist)” (page 43).
- 7 Select the date/Quicklist/folder you want to view, and press ENTER.

Hint

You can select a file and start slideshow by using “Options” menu (press →).

Searching for a Photo

DATA DVD

You can find the exact file, or files with a similar name.

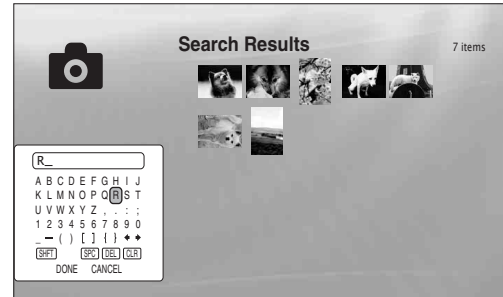

Search results are narrowed down as more characters are entered

- 1 Press SYSTEM MENU.
- 2 Select “Title List,” and press ENTER.
- 3 Select “Photos,” and press ENTER.
- 4 Press ← to turn on the Browse menu.
- 5 Select “All Photos,” and press ENTER.
- 6 Move the highlight to the leftmost row, and press ← to turn on the Browse menu.
- 7 Select “Search,” and press ENTER to turn on the above display.
- 8 Enter the file name using the on-screen keyboard (see page 23).

Hint

You can select a file and start slideshow by using “Options” menu (press →).

Programming a Slideshow Playback (Quicklist)

DATA DVD

Play a slideshow in the order you like by making your own “Quicklist.”

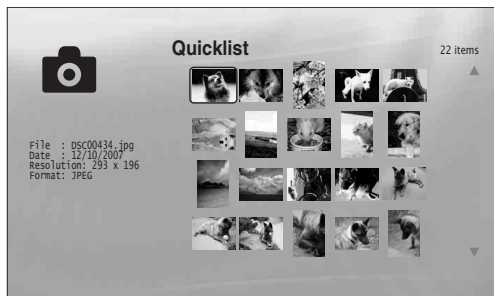

The “Quicklist” does not affect the original recording on the disc

- 1** Press **SYSTEM MENU**.
- 2** Select “**Title List,**” and press **ENTER**.
- 3** Select “**Photos,**” and press **ENTER**.
- 4** Press **←** to turn on the **Browse** menu.
- 5** Select “**All Photos,**” and press **ENTER**.
- 6** When the “**All Photos**” Title List appears, select the file you want to add to the top of the “**Quicklist,**” and press **ENTER**.
- 7** Select “**Add to Quicklist**” from the “**Options**” menu, and press **ENTER**.
- 8** Repeat step 6 and 7 to select all the desired files.
Select in the order you want to play. You can add the same file multiple times.
The “Quicklist” can contain up to 25 files.
- 9** Move the highlight to the leftmost row, and press **←** to turn on the **Browse** menu.
- 10** Select “**Browse,**” and press **ENTER**.
- 11** Select “**Quicklist,**” and press **ENTER** to turn on the above display.
The “Quicklist” Title List appears with the programmed content.
- 12** Select the file you want to start playback, and press **ENTER**.

- 13** Select “**Slideshow**” from the “**Options**” menu, and press **ENTER**.

To remove from the “Quicklist”

- 1** Select the file you want to remove from the displayed “Quicklist,” and press **ENTER**.
- 2** Select “**Remove,**” and press **ENTER**.

Hint

You can play the “Quicklist” content in other play modes by pressing **PLAY MODE** (page 25).

Note

The “Quicklist” may be cleared after some operations (e.g., opening the disc tray, or turning off the player etc.).

Changing the Initial Settings

Select “Setup” from the “System Menu” when you need to change the settings of the player (e.g., when changing the connected device or the audio/video output, etc.). The last part of this section explains how to return all of these settings to their factory defaults.

Note

Playback settings described in this section may not work when there is any preset playback setting in the disc. The disc’s playback settings take priority over the player’s playback settings.

- *Using the Setup Displays* 44
- *Video Setup* 45
- *Audio Setup* 47
- *Language* 49
- *Parental Control* 50
- *Speakers* 51
- *Options* 52
- *Resetting the Player* 53

Using the Setup Displays

BD **DVD** **DATA DVD** **CD**

From the “System Menu,” enter the “Setup” displays to change the settings of the player.

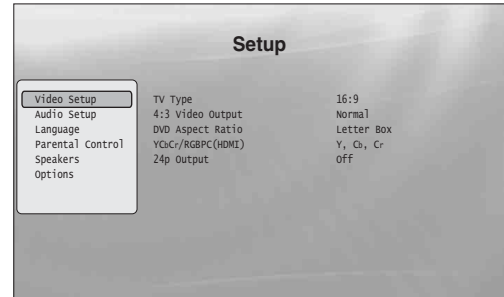



- 1** Press **SYSTEM MENU** while the player is stopped.
- 2** Select “Setup,” and press **ENTER**.
- 3** Select the “Setup” display you want to use, from “Video Setup,” “Audio Setup,” “Language,” “Parental Control,” “Speakers,” or “Options,” and press **ENTER**.
The “Setup” display appears with the related items. Note that the display switches to the screen saver if you do not operate for 15 minutes.
- 4** Select the item you want to change, and press **ENTER**.
Refer to the explanations in the following sections.

To return to the previous display

Press **RETURN**.

Video Setup

Underlined items are the default settings.

TV Type – Select your TV type.	<u>4:3</u> – 4:3 screen TV. <u>16:9</u> – Wide-screen TV, or a TV with a wide mode function.
4:3 Video Output – Select the display configuration for a 4:3 screen picture on a 16:9 wide screen TV.	<u>Full</u> – Displays a 4:3 screen picture in 16:9 aspect ratio. <u>Normal</u> – Displays a 4:3 screen picture in 4:3 aspect ratio with black bands on the sides. Select this if your TV does not have a 4:3 screen mode.
DVD Aspect Ratio – Select the display configuration for a 16:9 DVD picture on a 4:3 screen TV (selectable when “TV Type” is set to “4:3”). Note that the aspect ratio is fixed on some discs. For example, a 4:3 letterbox picture may appear even when “Pan Scan” is selected.	<u>Letter Box</u> – Displays a wide picture with black bands on the top and bottom.  <u>Pan Scan</u> – Displays a full-height picture on the entire screen, with trimmed sides. 
YCbCr / RGBPC (HDMI) – Select the type of output from the HDMI OUT jack.	<u>Y, Cb, Cr</u> – Select this when connecting to an HDMI device. RGB (16-235) – Select this when connecting to a device with an HDCP-compliant DVI jack. RGB (0-255) – Select this when connecting to an RGB (0-255) device.
24p Output – For connection to a 1080/24p-compatible TV using the HDMI OUT jack.	<u>On</u> – Sends 1920 × 1080p/24 Hz video signals when playing Film-based materials on BD-ROMs (720p/24 Hz or 1080p/24 Hz). Select this when the connection applies. <u>Off</u> – Select this for any other connection.

Note

“TV Type” and “DVD Aspect Ratio” can be set when video output resolution is 480i/576i or 480p/576p.

To set the video output resolution

Press VIDEO FORMAT repeatedly to select the desired resolution. Note that the resolution differs depending on the display device, connecting jack and the source material as below.

Settings \ Connecting jack	HDMI OUT	COMPONENT VIDEO OUT	VIDEO/S VIDEO
Auto	Automatically selects the recommended resolution acceptable for your TV.	480i/576i	480i/576i
576i/480i	480i/576i	480i/576i	480i/576i
576p/480p	480p/576p	480p/576p	480i/576i
720p	720p	BD:720p/576i* ¹ , DVD:480p/576i	480i/576i
1080i	1080i	BD:1080i/576i* ¹ , DVD:480p/576i	480i/576i
1080p	1080p	480i/576i	480i/576i
Source Direct	Output differs depending on source material* ²	Output differs depending on source material* ³	480i/576i

*¹ 576i when in 50Hz to comply with the international standards.

*² Outputs in the same resolution and frequency as recorded on the disc.

*³ 1080/24p video signals are not output from the COMPONENT VIDEO OUT jacks.

Notes

- If the picture is not clear, natural or to your satisfaction, try another resolution that suits the disc and your TV/projector, etc. For the details, refer also to the instruction manual supplied with the TV/projector, etc.
- 480i/576i or 480p/576p video signals may be output when you connect to the COMPONENT VIDEO OUT jacks and play some copy-guarded BDs/DVDs. To enjoy the HD quality resolution in this case, connect the display device to the HDMI OUT jack using an HDMI cord.
- Even when you select a setting other than “Auto,” the player automatically adjusts the video signals if the TV cannot accept the set resolution.

To output the 1080/24p video signals

A 1080/24p-compatible TV is required for this setting.

- 1** Set “24p Output” in “Video Setup” to “On” (page 45).
- 2** Press VIDEO FORMAT repeatedly to select “Auto” or “Source Direct.”

Note

If there is no picture, press VIDEO FORMAT repeatedly until the picture appears correctly.

Audio Setup

Underlined items are the default settings. Since many factors affect the type of audio output, see also “About the audio output signals” on page 48.

Dolby Digital Output – Select the audio signals output when playing Dolby Digital discs. This setting affects the output from the DIGITAL OUT (COAXIAL or OPTICAL) jack.	Dolby Digital – Select this when connecting to a device with a built-in Dolby Digital decoder. <u>Downmix PCM</u> – Converts to output Linear PCM signals. Select this when connecting to a device without a built-in Dolby Digital decoder.
DTS Output – Select the audio signals output when playing DTS discs. This setting affects the output from the DIGITAL OUT (COAXIAL or OPTICAL) jack.	DTS – Select this when connecting to a device with a built-in DTS decoder. <u>Downmix PCM</u> – Converts to output Linear PCM signals. Select this when connecting to a device without a built-in DTS decoder.
DTS Downmix – Select the type of 2-channel signals when down-mixed from multi-channel DTS sources (effective for audio connections when “DTS Output” is set to “Downmix PCM”).	Stereo – Downmixes multi-channel audio signals for two channel stereo. <u>Lt/Rt</u> – Allows you to hear surround sound when the connected device has a built-in Dolby Pro Logic decoder.
Audio (HDMI) – Select the output method from the HDMI OUT jack.	Auto – Normally, select this. Outputs audio signals according to the status of the connected HDMI device. PCM – Converts all audio signals to Linear PCM.

About the audio output signals

The audio output differs as follows, depending on the source, output jack, and the selected settings.

Disc/source	Jacks/ settings	AUDIO OUT L/R jacks* ¹		DIGITAL OUT (OPTICAL/ COAXIAL) jacks* ²		HDMI OUT jack* ³	
		2ch	5.1ch	PCM	Bitstream	PCM* ⁴	Auto* ⁴
BD- ROM	Linear PCM 2ch	2ch	2ch	2ch LPCM	2ch LPCM	2ch LPCM	2ch LPCM
	5.1ch* ⁵	2ch Downmix	5.1ch	2ch Downmix LPCM	2ch Downmix LPCM	5.1ch LPCM	5.1ch LPCM
	7.1ch	2ch Downmix	5.1ch Downmix	2ch Downmix LPCM	2ch Downmix LPCM	7.1ch LPCM	7.1ch LPCM
	Dolby Digital	2ch Downmix	5.1ch	2ch Downmix LPCM	Dolby Digital	5.1ch LPCM	Dolby Digital
	Dolby Digital Plus	2ch Downmix	5.1ch	2ch Downmix LPCM	Dolby Digital	7.1ch LPCM* ⁶	Dolby Digital
	Dolby TrueHD	2ch Downmix	5.1ch	2ch Downmix LPCM	Dolby Digital	7.1ch LPCM* ⁷	Dolby Digital
	DTS	2ch Downmix	5.1ch	2ch Downmix LPCM	DTS	5.1ch LPCM	DTS
	DTS-HD	2ch Downmix	5.1ch	2ch Downmix LPCM	DTS	5.1ch LPCM	DTS
DVD	Linear PCM	2ch	2ch	2ch LPCM	2ch LPCM	2ch LPCM	2ch LPCM
	Dolby Digital	2ch Downmix	5.1ch	2ch Downmix LPCM	Dolby Digital	5.1ch LPCM	Dolby Digital
	DTS	2ch Downmix	5.1ch	2ch Downmix LPCM	DTS	5.1ch LPCM	DTS
	MPEG	2ch	2ch	2ch LPCM	—	2ch LPCM	2ch LPCM
CD	Linear PCM 2ch	2ch	2ch	2ch LPCM	2ch LPCM	2ch LPCM	2ch LPCM
	DTS	2ch Downmix	5.1ch	2ch Downmix LPCM	DTS	5.1ch LPCM	DTS

*¹ “2 Channel” and “5.1 Channel” are selectable under “Audio Output Mode” in “Speakers” Setup (page 51).

*² PCM : when “Dolby Digital Output” or “DTS Output” in “Audio Setup” is set to “Downmix PCM” (page 47).

Bitstream : when “Dolby Digital Output” or “DTS Output” in “Audio Setup” is set to “Dolby Digital” or “DTS” (page 47).

*³ Selectable under “Audio (HDMI)” in “Audio Setup” (page 47).

*⁴ Selectable under “Audio (HDMI)” in “Audio Setup” (page 47). Resulting output may differ depending on the connected HDMI device.

*⁵ When the sampling frequency is 192 kHz, the player downmixes to 2ch signals even if the disc or source is 5.1ch.

*⁶ Outputs 7.1ch LPCM signals decoded from Dolby Digital Plus audio stream.

*⁷ Outputs 7.1ch LPCM signals decoded from Dolby True HD audio stream.

The player outputs up to 7.1ch LPCM when the source sampling frequency is 48 kHz; up to 5.1ch at 96 kHz; up to 2ch at 192 kHz.

Language

Underlined items are the default settings.

Notes

- When you select a language in “Audio,” “Subtitles,” “BD/DVD Menu” that is not recorded on the disc, one of the recorded languages is automatically selected.
- Playback settings stored in the disc take priority over these settings.

OSD	<u>English / Français / Deutsch / Italiano / Español</u> – Select your language for the player on-screen displays.
Audio	<u>English / French / German / Italian / Spanish</u> – Select the default soundtrack language for BD-ROMs/DVD VIDEOS. Other – See “ <i>Language Code List</i> ” on page 62 and enter the code for your language.
Subtitles	<u>English / French / German / Italian / Spanish</u> – Select the default subtitle language for BD-ROMs/DVD VIDEOS. Other – See “ <i>Language Code List</i> ” on page 62 and enter the code for your language.
BD/DVD Menu	<u>w/Subtitle Language</u> – Select the default menu language for BD-ROMs/DVD VIDEOS. – Displays BD’s/DVD’s menus in the same language as the subtitle language. English / French / German / Italian / Spanish – Displays BD’s/DVD’s menus in the selected language. Other – See “ <i>Language Code List</i> ” on page 62 and enter the code for your language.
Subtitle Display	<u>On</u> – Turns on the subtitles. Off – Turns off the subtitles.

Parental Control

This function limits playback of DVD VIDEOS and BD-ROMs. To activate, see “*Locking a Disc*” (page 29). The default settings are underlined.

Notes

- You cannot limit playback if the disc does not have the Parental Control function.
- If you forget the password for “Parental Control,” you will need to reset the player (page 53). Note that all the settings you made also return to their defaults.

Change Password (Set Password)

Next Screen

– Set or change the password for the “Parental Control” function. You will be asked for the password when playing restricted discs or when changing the control level.

DVD Parental Control

Change Level

– Set the control level. The display asks for the password if the disc’s pre-determined level exceeds the limit you set. The default setting is “Off.”

DVD Country Code

– This ensures that you see the scenes intended for your residential area. The default setting is “us” (2119).

BD Parental Control

Change Age Restriction

– Set the control level. The display asks for the password if the disc’s pre-determined age restriction is higher than the age you set. The default setting is “255.”

BD Country Code

– This ensures that you see the scenes intended for your residential area when playing BD-ROMs. The default setting is “us” (2119).

Speakers

The following items are necessary when using the 5.1CH OUTPUT jacks.

The default settings are underlined.

Audio Output Mode –For analog connection.	<u>2 Channel</u> –Select this when connecting to an AV amplifier (receiver) using the AUDIO OUT (L/R) jacks. <u>5.1 Channel</u> –Select this when connecting to an AV amplifier (receiver) using the 5.1CH OUTPUT jacks.
Speaker Setup –This setting affects the output from the 5.1CH OUTPUT jacks.	Next Screen <ol style="list-style-type: none">Select the speaker setting that needs adjusting by pressing ↑/↓.<ul style="list-style-type: none">• “C” (centre speaker): “<u>Yes</u>” or “No”• “Ls/Rs” (left surround speaker/right surround speaker): “<u>Yes</u>” or “No”• “L/R” (left front speaker/right front speaker): “<u>Large</u>” or “Small”Adjust the setting by pressing ←/→.<ul style="list-style-type: none">• For “C” and “Ls/Rs,” select whether the speakers are included in your system.• For “L/R,” select the size. This setting is disabled if either of “C” or “Ls/Rs” is set to “No.”Press ENTER to save the adjustments.

Options

Underlined items are the default settings.

On Screen Display	<u>On</u> – Displays playback status. Off – Playback status is not displayed.
– Select whether to display the playback status on the screen (Stop, Play, etc.).	
Auto Power Off	<u>On</u> – Turns off the player when the player is left in stop or pause mode without operation for 30 minutes. Off – The player remains turned on with or without operation.
– Select whether to activate the “Auto Power Off” function of the player.	
Easy Setup	Start – Press ENTER and see <i>page 18</i> .
– Re-runs the Easy Setup to make the basic settings.	
HDMI Control	On – Activates the function. <u>Off</u> – Turns off the function.
– Select whether to activate the HDMI Control function of the player (<i>page 11</i>).	
Hybrid Disc Playback Layer	<u>BD</u> – Plays BD layer. DVD – Plays DVD layer. CD – Plays CD layer.
– Select the layer priority when playing a Hybrid Disc. Remove the disc when you change the setting.	

Resetting the Player

You can return all of the player settings to their factory defaults.

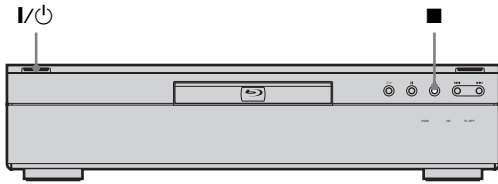

- 1** When the power is on, hold down ■ on the front panel, and press I/O.
The player turns off, and all of the settings return to their factory defaults.

Additional Information

• Troubleshooting	54
• Self-Diagnosis Function	57
• Index to Parts and Controls	58
• Glossary	60
• Specifications	61
• Language Code List	62
• Parental Control Country/Area Code List	63
• Index	63

Troubleshooting

If you experience any of the following difficulties while using the player, use this troubleshooting guide to help remedy the problem before requesting repairs. Should any problem persist, consult your nearest Sony dealer.

Power

The power does not turn on.

- ➔ Check that the mains lead is connected securely.
- ➔ It takes a short while before the player turns on.

Picture

There is no picture/picture noise appears.

- ➔ Re-connect the connecting cord securely.
- ➔ The connecting cords are damaged.
- ➔ Check the connection to your TV (*page 10*) and switch the input selector on your TV so that the signal from the player appears on the TV screen.
- ➔ The disc is dirty or flawed.
- ➔ If the picture output from your player goes through your VCR to get to your TV or if you are connected to a combination TV/VIDEO player, the copy-protection signal applied to some BD/DVD programmes could affect picture quality. If you still experience problems even when you connect your player directly to your TV, try connecting your player to your TV's S VIDEO input (*page 10*).
- ➔ The player is connected to an input device that is not HDCP-compliant (the HDMI indicator on the front panel does not light up). See *page 11*.
- ➔ If the HDMI OUT jack or the COMPONENT VIDEO OUT jacks are used for video output, changing the output resolution may solve the problem (*page 46*). Press VIDEO FORMAT repeatedly until the picture appears correctly.
- ➔ Depending on the disc, the picture quality may be poor when the VIDEO FORMAT setting is set to other than "480i," even when the player is connected to a progressive or HD TV using a component cord or an HDMI cord. If this happens, press VIDEO FORMAT repeatedly to switch to "480i."
- ➔ When playing a double-layer DVD, the video and audio may be momentarily interrupted at the point where the layers switch.

There is no picture or picture noise appears when connected to the HDMI OUT jack.

- ➔ Try the following: ① Turn the player off and on again.
② Turn the connected equipment off and on again.
③ Disconnect and then connect the HDMI cord again.
- ➔ If the HDMI OUT jack is used for video output, changing the video output resolution may solve the problem (*page 46*). Press VIDEO FORMAT repeatedly until the picture appears correctly.

The picture does not fill the screen, even though the aspect ratio is set in “TV Type” under “Video Setup.”

- ➔ The aspect ratio of the disc is fixed on your BD/DVD. See *page 45*.

The dark area of the picture is too dark/the bright area is too bright or unnatural.

- ➔ Set “Video Control” in “A/V Control” to “Standard” (default) (*page 28*).
- ➔ Adjust each picture setting for “Memory” in “Video Control” to midpoint (default) (*page 28*).

Sound

There is no sound.

- ➔ The disc is dirty or flawed.
- ➔ Re-connect the connecting cord securely.
- ➔ The connecting cord is damaged.
- ➔ The player is connected to the wrong input jack on the amplifier (receiver) (*page 12*).
- ➔ The amplifier (receiver) input is not correctly set.
- ➔ The player is in pause mode or in Slow-motion Play mode.
- ➔ The player is in scan mode.
- ➔ If the audio signal does not come through the DIGITAL OUT (OPTICAL or COAXIAL)/HDMI OUT jack, check the audio settings (*page 47*).
- ➔ The equipment connected to the HDMI OUT jack does not conform to the audio signal format, in this case set “Audio (HDMI)” in “Audio Setup” to “PCM” (*page 47*).

The sound is not output correctly.

- ➔ Check the “Audio Output Mode” in “Speakers” Setup (*page 51*) if the AUDIO OUT (L/R) jacks or the 5.1CH OUTPUT jacks are used for audio connection.

No sound is output from the HDMI OUT jack

- ➔ Try the following: ①Turn the player off and on again.
②Turn the connected equipment off and on again.
③Disconnect and then reconnect the HDMI cord.
- ➔ The HDMI OUT jack is connected to a DVI device (DVI jacks do not accept audio signals).

The sound volume is low.

- ➔ The sound volume is low on some BDs/DVDs. The sound volume may improve if you adjust the “Audio Control” setting in “A/V Control” (*page 27*).

Operation

The remote does not function.

- ➔ The batteries in the remote are weak (*page 16*).
- ➔ There are obstacles between the remote and the player.
- ➔ The distance between the remote and the player is too far.
- ➔ The remote is not pointed at the remote sensor on the player.

The disc does not play.

- ➔ The disc is turned over. Insert the disc with the playback side facing down.
- ➔ The disc is skewed.
- ➔ The player cannot play certain discs (*page 6*).
- ➔ The region code on the BD/DVD does not match the player.
- ➔ Moisture has condensed inside the player (*page 3*).
- ➔ The player cannot play a recorded disc that is not correctly finalized (*page 6*).
- ➔ The movie file size exceeds 2 GB.
- ➔ The file on the DATA DVD contains characters other than numbers and English alphabet.

The MP3 audio track file cannot be played (page 36).

- ➔ The DATA DVD is not recorded in the MP3 format that conforms to UDF (Universal Disk Format).
- ➔ The audio track file does not have the extension “.MP3.”
- ➔ The data is not formatted properly even though it has the extension “.MP3.”
- ➔ The data is not MPEG-1 Audio Layer III data.
- ➔ The player cannot play audio tracks in mp3PRO format.
- ➔ Characters other than numbers and English alphabet are contained in the file name.

The photo file cannot be played (page 40).

- ➔ The disc is dirty or flawed.
- ➔ The DATA DVD is not recorded in a JPEG format that conforms to UDF (Universal Disk Format).
- ➔ The file has an extension other than “.JPEG” or “.JPG.”
- ➔ The image is larger than 4,096 (width) × 4,096 (height) in normal mode. (Some progressive JPEG files cannot be displayed even if the file size is within this specified capacity.)
- ➔ The image does not fit the screen (the image is reduced).
- ➔ The photo file format does not conform to DCF* (*page 41*).
- ➔ Characters other than numbers and English alphabet are contained in the file name.

* “Design rule for Camera File system”: Image standards for digital cameras regulated by JEITA (Japan Electronics and Information Technology Industries Association).

The file name is not correctly displayed.

- ➔ The player can only display numbers and alphabet. Other characters may be displayed differently.
- ➔ Depending on the writing software used, the input characters may be displayed differently.

The disc does not start playing from the beginning.

- ➔ Random Play or Repeat Play is selected (*page 25*).
- ➔ Resume play mode is on (*page 20*).

The player starts playing the disc automatically.

- ➔ The disc features an auto playback function.

Playback stops automatically.

- ➔ While playing discs with an auto pause signal, the player stops playback at the auto pause signal.

Some functions such as Stop, Search, Slow-motion Play, Repeat Play, or Random Play cannot be performed.

- ➔ Depending on the disc, you may not be able to do some of the operations above. Refer to the operating manual that comes with the disc.

The language for the soundtrack cannot be changed.

- ➔ Try using the BD's or DVD's menu instead of the direct selection button on the remote (page 21).
- ➔ Multi-lingual tracks are not recorded on the BD/DVD being played.
- ➔ The BD/DVD prohibits the changing of the language for the sound track.

The subtitle language cannot be changed or turned off.

- ➔ Try using the BD's or DVD's menu instead of the direct selection button on the remote (page 21).
- ➔ Multi-lingual subtitles are not recorded on the BD/DVD being played.
- ➔ The BD/DVD prohibits the changing of subtitles.

The angles cannot be changed.

- ➔ Try using the BD's or DVD's menu instead of the direct selection button on the remote (page 21).
- ➔ Multi-angles are not recorded on the BD/DVD being played.
- ➔ The BD/DVD prohibits changing of the angles.

The HDMI Control function does not work.

- ➔ If the HDMI indicator on the front panel does not light up, check the HDMI connection (page 11, 15).
- ➔ Set "HDMI Control" to "On" (page 52).
- ➔ Make sure that the connected component is compatible with the HDMI Control function. Refer to the operating instructions of the component for details.
- ➔ Check that the mains lead of the connected component is connected securely.
- ➔ Check the connected component's setting for the HDMI Control function. Refer to the operating instructions of the component.
- ➔ If you change the HDMI connection, connect and disconnect the mains lead, or if a power failure occurs, set "HDMI Control" to "Off," then set "HDMI Control" to "On" (page 52).
- ➔ For details on the HDMI Control function, see "About the 'BRAVIA' Theatre Sync features (for HDMI connections only)" (page 11).

The display language on the screen switches automatically.

- ➔ When "HDMI Control" is set to "On" (page 52), the display language on the screen automatically switches according to the language setting of the connected TV (if you change the setting on your TV, etc.).

The player does not operate properly.

- ➔ When static electricity, etc., causes the player to operate abnormally, unplug the player.

The disc tray does not open and "LOCK" appears on the front panel display.

- ➔ Contact your Sony dealer or local authorized Sony service facility.

The disc tray does not open and you cannot remove the disc even after you press .

- ➔ Turn on the player.
As soon as "POWER ON" appears on the front panel display, press  on the player (not the remote) repeatedly until the tray opens. Repeat the above procedure several times if the tray does not open on the first try.

"UNPLAYABLE" appears when playing a DATA DVD.

- ➔ See also "The photo file cannot be played" or "The MP3 audio track file cannot be played" (page 55).
- ➔ The MP3 audio track/JPEG image file you want to play/view is damaged.
- ➔ The data is not MPEG-1 Audio Layer III data.
- ➔ The JPEG image file format does not conform to DCF* (page 41).
- ➔ The JPEG image file has the extension ".JPG" or ".JPEG," but is not in JPEG format.

* "Design rule for Camera File system": Image standards for digital cameras regulated by JEITA (Japan Electronics and Information Technology Industries Association).

The player does not accept any button.

- ➔ Hold down  on the player for more than five seconds until the indicators on the front panel display turn off.

Self-Diagnosis Function

When the self-diagnosis function is activated to prevent the player from malfunctioning, the “ERR” error code appears on the front panel display indicating the cause.

Error code	Cause and/or corrective action
AACS ERR	AACS read failure. →Remove the protected disc.
LSI1 ERR LSI2 ERR LSI3 ERR MEM ERR FLASH ERR ROM ERR	→Contact your nearest Sony dealer or local authorized Sony service facility and give the error code.

Index to Parts and Controls

Buttons on the remote and the player have the same function if they have the same or similar name.
For details, see the pages in parentheses.

Front panel

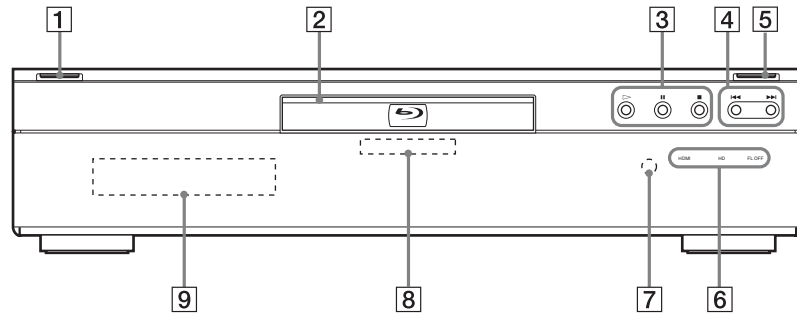

1 I/⏻ (20)

- Turns on the player, or sets to standby mode.
- Lights up in white while the power is on.

2 Disc tray (20)

3 ▷, ||, ■ (20)

- Starts, pauses, or stops playback.

4 ◀◀/▶▶ (24)

- Skips to the previous/next chapter or track.
- Scans forward or backwards when held down.

5 ≡ (20)

- Opens or closes the disc tray.
- Lights up in white while the power is on.

6 HDMI indicator (11)

- Lights up when an HDMI device is connected.

HD indicator (11)

- Lights up when outputting 720p/1080i/1080p video signals.

FL OFF indicator (24)

- Lights up when the front panel display and other indicators on the front panel are turned off.

7 Remote sensor (16)

8 Blu-ray Disc indicator

- Lights up when a BD is recognized.
- Lights up for a few seconds when the player is turned on.

9 Front panel display (59)

Note

The transparent part on the front panel surface is made of glass. Handle with care.

Front panel display

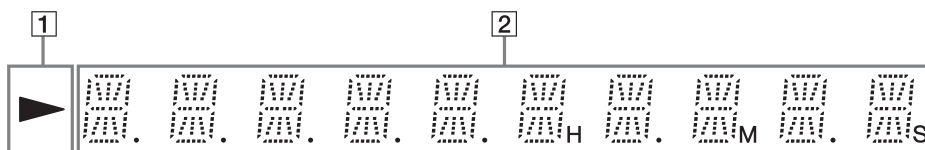

- 1**  – Lights up during playback.

2 Playback information

 **Hint**

You can change the brightness of the front panel display by pressing DIMMER (page 24).

The playback information is displayed as follows.

Example: When playing a DVD VIDEO or a BD-ROM

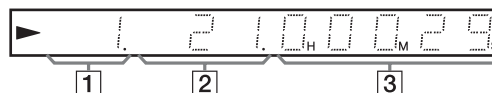

1 Current title number

2 Current chapter number

Note that the chapter number is not displayed if the title's elapsed time exceeds 10 hours.

3 Elapsed time of the title

Rear panel

For connections, see page 10 to 16.

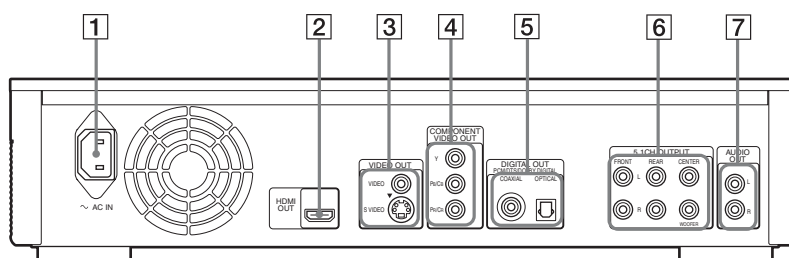

1 AC IN terminal (16)

2 HDMI OUT jack (11, 12, 15)

3 VIDEO OUT (VIDEO/S VIDEO) jacks (10)

4 COMPONENT VIDEO OUT (Y, P_B/C_B, P_R/C_R) jacks (10)

5 DIGITAL OUT (COAXIAL/OPTICAL) jacks (13, 14)

6 5.1CH OUTPUT (FRONT L/R, REAR L/R, CENTER, WOOFER) jacks (14)

7 AUDIO OUT (L/R) jacks (13, 14)

Glossary

AACS

“Advanced Access Content System” is a specification for managing digital entertainment contents stored on the next generation of prerecorded and recorded optical media. The specification enables consumers to enjoy digital entertainment content, including high-definition content.

AVCHD (page 6)

The AVCHD format is a high definition digital video camera format used to record SD (standard definition) or HD (high definition) signals of either the 1080i specification*¹ or the 720p specification*² on DVDs, using efficient data compression coding technology. The MPEG-4 AVC/H.264 format is adopted to compress video data, and the Dolby Digital or Linear PCM is used to compress audio data. The MPEG-4 AVC/H.264 format is capable of compressing images at higher efficiency than that of the conventional image compression format. The MPEG-4 AVC/ H.264 format enables a high definition (HD) video signal shot on a digital video camera recorder to be recorded on DVDs in the same way as for a standard definition (SD) television signal.

*¹ A high definition specification that utilizes 1080 effective scanning lines and the interlace format.

*² A high definition specification that utilizes 720 effective scanning lines and the progressive format.

BD-J application

The BD-ROM format supports Java for interactive functions.

“BD-J” offers content providers almost unlimited functionality when creating interactive BD-ROM titles.

BD-R

BD-R (Blu-ray Disc Recordable) is a recordable, write-once Blu-ray Disc, available in the same capacities as the BD below. Since contents can be recorded and cannot be overwritten, a BD-R can be used to archive valuable data or storing and distributing video material.

BD-RE

BD-RE (Blu-ray Disc Rewritable) is a recordable and rewritable Blu-ray Disc, available in the same capacities as the BD below. The re-recordable feature makes extensive editing and time-shifting applications possible.

BD-ROM (page 5)

BD-ROMs (Blu-ray Disc Read-Only Memory) are commercially produced discs and are available in the same capacities as the BD below. Other than conventional movie and video contents, these discs have enhanced features such as interactive content, menu operations using pop-up menus (see below), selection of subtitle display, and slideshow. Although a BD-ROM may contain any form of data, most BD ROM discs will contain movies in High Definition format, for playback on Blu-ray Disc players.

Blu-ray Disc (BD) (page 5)

A disc format developed for recording/playing high-definition (HD) video (for HDTV, etc.), and for storing large amounts of data. A single layer Blu-ray Disc holds up to 25 GB, and a dual-layer Blu-ray Disc holds up to 50 GB of data.

Chapter (page 25)

Sections of a picture or a music feature that are smaller than titles. A title is composed of several chapters. Depending on the disc, no chapters may be recorded.

Dolby Digital (page 47)

Digital audio compression technology developed by Dolby Laboratories. This technology conforms to multi-channel surround sound. The rear channel is stereo and there is a discrete subwoofer channel in this format. Dolby Digital provides the same discrete channels of high quality digital audio found in “Dolby Digital” theatre surround sound systems. Good channel separation is realized because all of the channel data is recorded discretely and little deterioration occurs because all channel data processing is digital.

Dolby Digital Plus (page 48)

Developed as an extension to Dolby Digital, the audio coding technology supports 7.1 multi-channel surround sound.

Dolby Surround (Pro Logic) (page 47)

Audio signal processing technology that Dolby Laboratories developed for surround sound. When the input signal contains a surround component, the Pro Logic process outputs the front, centre and rear signals. The rear channel is monaural.

Dolby TrueHD (page 48)

Dolby TrueHD is a lossless coding technology that supports up to 8 channels of multi-channel surround sound for the next generation optical discs. The reproduced sound is true to the original source bit-for-bit.

DTS (page 47)

Digital audio compression technology that DTS, Inc. developed. This technology conforms to multi-channel surround sound. The rear channel is stereo and there is a discrete subwoofer channel in this format. DTS provides the same discrete channels of high quality digital audio.

Good channel separation is realized because all of the channel data is recorded discretely and little deterioration occurs because all channel data processing is digital.

DTS-HD (page 48)

DTS-HD is an extended format of the Coherent Acoustics audio coding system, which also encompasses DTS Digital Surround, DTS-ES, and DTS 96/24. DTS-HD is highly flexible in supporting the number of discrete surround sound channels. While 7.1ch surround sound is planned for Blu-ray Discs, the audio signals can be downmixed to 5.1 or 2 channels for backward compatibility, and the reproduced audio quality can either be at the bit rate of DTS Digital Surround or the lossless mode.

DVD VIDEO (page 5)

A disc format that contains up to eight hours of moving pictures on a disc the same diameter as a CD. A single-layer single sided DVD holds up to 4.7 GB; a double layer single-sided DVD, 8.5 GB; a single layer double-sided DVD, 9.4 GB; double-layer double-sided DVD, 17 GB. The MPEG 2 format is adopted for the efficient video data compression. The variable rate coding technology that changes the data to be allocated according to the status of the picture is adopted for reproducing high-quality pictures. Audio information is recorded in a multi-channel format, such as Dolby Digital, allowing for a realistic audio presence.

Specifications

System

Laser: Semiconductor laser

Outputs

(**Jack name:** Jack type/Output level/Load impedance)

AUDIO OUT L/R:

Phono jack/2 V_{rms}/10 kilohms

DIGITAL OUT (OPTICAL):

Optical output jack/-18 dBm (wave length 660 nm)

DIGITAL OUT (COAXIAL):

Phono jack/0.5 V_{p-p}/75 ohms

5.1CH OUTPUT:

Phono jack/2 V_{rms}/10 kilohms

HDMI OUT:

HDMI 19-pin standard connector

COMPONENT VIDEO OUT(Y, P_B/C_B, P_R/C_R):

Phono jack/Y: 1.0 V_{p-p}, P_B/C_B, P_R/C_R: progressive or interlace = 0.7 V_{p-p}/75 ohms

VIDEO: Phono jack/1.0 V_{p-p}/75 ohms

S VIDEO: 4-pin mini DIN/Y:

1.0 V_{p-p}, C: 0.3 V_{p-p} (PAL)/75 ohms

General

Power requirements:

220-240 V AC, 50/60 Hz

Power consumption: 33 W

Dimensions (approx.):

430 × 106 × 355 mm (width/height/depth) incl. projecting parts

Mass (approx.): 7.5 kg

Operating temperature:

5 °C to 35 °C

Operating humidity:

25 % to 80 %

Supplied accessories

See page 9.

Specifications and design are subject to change without notice.

DVD-R (page 5)

A DVD-R is a recordable disc that is the same size as a DVD VIDEO. Contents can be recorded only once to a DVD-R, and will have the same format as a DVD VIDEO. The DVD-R has two different modes: VR mode and Video mode. DVDs created in Video mode have the same format as a DVD VIDEO, while discs created in VR (Video Recording) mode allow the contents to be programmed or edited.

DVD-RW (page 5)

A DVD-RW is a recordable and rewritable disc that is the same size as a DVD VIDEO. The DVD-RW has two different modes: VR mode and Video mode. DVDs created in Video mode have the same format as a DVD VIDEO, while discs created in VR (Video Recording) mode allow the contents to be programmed or edited.

DVD+R (page 5)

A DVD+R (read “plus R”) is a recordable disc that is the same size as a DVD VIDEO. Contents can be recorded only once to a DVD+R, and will have the same format as a DVD VIDEO.

DVD+RW (page 5)

A DVD+RW (read “plus RW”) is a recordable and rewritable disc. DVD+RWs use a recording format that is comparable to the DVD VIDEO format.

Film-based software, Video-based software

DVDs can be classified as Film-based or Video-based software. Film-based DVDs contain the same images (24 frames per second) that are shown at movie theatres. Video-based DVDs, such as television dramas or sitcoms, display images at 25 frames/50 fields (30 frames/60 fields) per second.

HDMI (High-Definition Multimedia Interface)

HDMI is an interface that supports both video and audio on a single digital connection. The HDMI connection carries standard to high definition video signals and multi-channel audio signals to AV components such as HDMI equipped TVs, in digital form without degradation.

The HDMI specification supports HDCP (High-bandwidth Digital Contents Protection), a copy protection technology for digital entertainment contents for HDMI.

Interlace format

Interlace format shows every other line of an image as a single “field” and is the standard method for displaying images on television. The even number field shows the even numbered lines of an image, and the odd numbered field shows the odd numbered lines of an image.

MPEG-2

One of the video data compression schemes established by the Moving Picture Experts Group (MPEG), which is adopted for DVD VIDEOS and digital broadcasts worldwide. The scheme specifies MPEG-2 PS (Program Stream) for recordable media such as a DVD VIDEO, and MPEG-2 TS (Transport Stream) for digital broadcasts and other communications.

Pop-up menu

An enhanced menu operation available on BD-ROMs. The pop-up menu appears when MENU is pressed during playback, and can be operated while playback is in progress.

Progressive format

Compared to the Interlace format that alternately shows every other line of an image (field) to create one frame, the Progressive format shows the entire image at once as a single frame. This means that while the Interlace format can show 25 or 30 frames (50-60 fields) in one second, the Progressive format can show 50-60 frames in one second. The overall picture quality increases and still images, text, and horizontal lines appear sharper.

Title (page 26)

The longest section of a picture or music feature on a DVD, movie, etc., in video software, or the entire album in audio software.

Language Code List

For details, *see page 49*.

Language (abbr.)	Code
Japanese (ja)	1001
English (en)	0514
French (fr)	0618
German (de)	0405
Italian (it)	0920
Spanish (es)	0519
Dutch (nl)	1412
Russian (ru)	1821
Chinese (zh)	2608
Korean (ko)	1115
Greek (el)	0512
Afar (aa)	0101
Abkhazian (ab)	0102
Afrikaans (af)	0106
Amharic (am)	0113
Arabic (ar)	0118
Assamese (as)	0119
Aymara (ay)	0125
Azerbaijani (az)	0126
Bashkir (ba)	0201
Byelorussian (be)	0205
Bulgarian (bg)	0207
Bihari (bh)	0208
Bislama (bi)	0209
Bengali (bn)	0214
Tibetan (bo)	0215
Breton (br)	0218
Catalan (ca)	0301
Corsican (co)	0315
Czech (cs)	0319
Welsh (cy)	0325
Danish (da)	0401
Bhutani (dz)	0426
Esperanto (eo)	0515
Estonian (et)	0520
Basque (eu)	0521
Persian (fa)	0601
Finnish (fi)	0609
Fiji (fj)	0610
Faroese (fo)	0615
Frisian (fy)	0625
Irish (ga)	0701
Scots-Gaelic (gd)	0704
Galician (gl)	0712
Guarani (gn)	0714
Gujarati (gu)	0721
Hausa (ha)	0801

Language (abbr.)	Code
Hindi (hi)	0809
Croatian (hr)	0818
Hungarian (hu)	0821
Armenian (hy)	0825
Interlingua (ia)	0901
Interlingue (ie)	0905
Inupiak (ik)	0911
Indonesian (in)	0914
Icelandic (is)	0919
Hebrew (iw)	0923
Yiddish (ji)	1009
Javanese (jw)	1023
Georgian (ka)	1101
Kazakh (kk)	1111
Greenlandic (kl)	1112
Cambodian (km)	1113
Kannada (kn)	1114
Kashmiri (ks)	1119
Kurdish (ku)	1121
Kirghiz (ky)	1125
Latin (la)	1201
Lingala (ln)	1214
Laothian (lo)	1215
Lithuanian (lt)	1220
Latvian (lv)	1222
Malagasy (mg)	1307
Maori (mi)	1309
Macedonian (mk)	1311
Malayalam (ml)	1312
Mongolian (mn)	1314
Moldavian (mo)	1315
Marathi (mr)	1318
Malay (ms)	1319
Maltese (mt)	1320
Burmese (my)	1325
Nauru (na)	1401
Nepali (ne)	1405
Norwegian (no)	1415
Occitan (oc)	1503
Oromo (om)	1513
Oriya (or)	1518
Panjabi (pa)	1601
Polish (pl)	1612
Pashto, Pushto (ps)	1619
Portuguese (pt)	1620
Quechua (qu)	1721
Rhaeto-Romance (rm)	1813
Kirundi (rn)	1814
Romanian (ro)	1815
Kinyarwanda (rw)	1823
Sanskrit (sa)	1901
Sindhi (sd)	1904
Sangho (sg)	1907
Serbo-Croatian (sh)	1908

Language (abbr.)	Code
Sinhalese (si)	1909
lovak (sk)	1911
Slovenian (sl)	1912
Samoan (sm)	1913
Shona (sn)	1914
Somali (so)	1915
Albanian (sq)	1917
Serbian (sr)	1918
Siswati (ss)	1919
Sesotho (st)	1920
Sundanese (su)	1921
Swedish (sv)	1922
Swahili (sw)	1923
Tamil (ta)	2001
Telugu (te)	2005
Tajik (tg)	2007
Thai (th)	2008
Tigrinya (ti)	2009
Turkmen (tk)	2011
Tagalog (tl)	2012
Setswana (tn)	2014
Tonga (to)	2015
Turkish (tr)	2018
Tsonga (ts)	2019
Tatar (tt)	2020
Twi (tw)	2023
Ukrainian (uk)	2111
Urdu (ur)	2118
Uzbek (uz)	2126
Vietnamese (vi)	2209
Volapük (vo)	2215
Wolof (wo)	2315
Xhosa (xh)	2408
Yoruba (yo)	2515
Zulu (zu)	2621

Parental Control Country/Area Code List

For details, see pages 50 and 52.

Area (abbr.)	Code
Argentina (ar)	0118
Australia (au)	0121
Austria (at)	0120
Belgium (be)	0205
Brazil (br)	0218
Canada (ca)	0301
Chile (cl)	0312
China (cn)	0314
Denmark (dk)	0411
Finland (fi)	0609
France (fr)	0618
Germany (de)	0405
Hong Kong (hk)	0811
India (in)	0914
Indonesia (id)	0904
Italy (it)	0920
Japan (jp)	1016
Korea, Republic of (kr)	1118
Malaysia (my)	1325
Mexico (mx)	1324
Netherlands (nl)	1412
New Zealand (nz)	1426
Norway (no)	1415
Pakistan (pk)	1611
Philippines (ph)	1608
Portugal (pt)	1620
Russian Federation (ru)	1821
Singapore (sg)	1907
Spain (es)	0519
Switzerland (ch)	0308
Sweden (se)	1905
Taiwan (tw)	2023
Thailand (th)	2008
United Kingdom (gb)	0702
United States of America (us)	2119

Index

Words in quotations appear in the on-screen displays.

Numerics

5.1CH OUTPUT 14, 51

A

“A/V Control” 22
 AACS 60
 ANGLE 24
 AUDIO 24
 “Audio Control” 27
 “Audio Output Mode” 51
 “Audio Setup” 47
 AVCHD 6, 60

B

Batteries 16
 Blu-ray Disc 5, 60
 ‘BRAVIA’ Theatre Sync 11

C

CD 5
 Chapter 60
 Colour buttons 24
 Connecting
 the audio cords 12
 the video cords 10

D

DIMMER 24
 Disc Information 26
 DISPLAY 24
 Display
 front panel display 59
 Dolby Digital 14, 60
 “Dolby Digital Output” 47
 Dolby Digital Plus 48, 60
 Dolby TrueHD 48, 60
 DTS 60
 “DTS Downmix” 47
 “DTS Output” 47
 DTS-HD 48, 60
 DVD VIDEO 60
 DVD+R 61
 DVD+RW 61
 DVD-R 61
 DVD-RW 61

E

Easy Setup 18

F

Film based software 61
 Front panel display 59

H

HDMI 11, 12, 18, 45, 47, 61
 HDMI Control 11, 21, 52

I

Interlace format 61

L

“Language” 49

M

“Memory” 28
 “Movies” 32
 MPEG 32
 “Music” 36

O

“Options” 52

P

“Parental Control” 50
 “Photos” 40
 POP UP/MENU 25
 Pro Logic 14, 47, 60
 Progressive format 61

R

Region code 7
 Remote 16, 17, 24
 Resetting the Player 53

S

Searching 26, 34, 38, 42
 “Setup” 22
 Setup Displays 44
 “Slideshow” 41
 “Speaker Setup” 51
 “Speakers” 12, 51
 SUBTITLE 24

T

Title 61
 Title List 22
 TOP MENU 25
 Troubleshooting 54
 “TV Type” 45

U

Usable discs 5

V

Video based software 61
 “Video Control” 28
 “Video Setup” 45



<http://www.sony.net/>

 To find out useful hints, tips and information about Sony products and services please visit: www.sony-europe.com/myproduct

Printed in Japan



Printed on 70% or more recycled paper using VOC (Volatile Organic Compound)-free vegetable oil based ink.



* 1 - 3 1 9 7 0 9 3 1 1 2 *

3-197-093-11 (1)