

Compact Disc Player

Operating Instructions



CDP-CX55

WARNING

To prevent fire or shock hazard, do not expose the unit to rain or moisture.

To avoid electrical shock, do not open the cabinet. Refer servicing to qualified personnel only. Do not install the appliance in a confined space, such as a bookcase or built-in cabinet.

For the customers in the United States

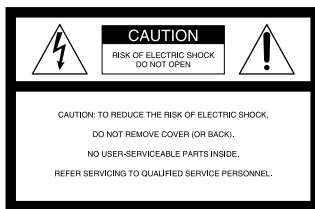

This symbol is intended to alert the user to the presence of uninsulated "dangerous voltage" within the product's enclosure that may be of sufficient magnitude to constitute a risk of electric shock to persons.



This symbol is intended to alert the user to the presence of important operating and maintenance (servicing) instructions in the literature accompanying the appliance.

INFORMATION

This equipment has been tested and found to comply with the limits for a Class B digital device, pursuant to Part 15 of the FCC Rules. These limits are designed to provide reasonable protection against harmful interference in a residential installation. This equipment generates, uses, and can radiate radio frequency energy and, if not installed and used in accordance with the instructions, may cause harmful interference to radio communications.

However, there is no guarantee that interference will not occur in a particular installation. If this equipment does cause harmful interference to radio or television reception, which can be determined by turning the equipment off and on, the user is encouraged to try to correct the interference by one or more of the following measures:

- Reorient or relocate the receiving antenna.
- Increase the separation between the equipment and receiver.
- Connect the equipment into an outlet on a circuit different from that to which the receiver is connected.
- Consult the dealer or an experienced radio/TV technician for help.

CAUTION

You are cautioned that any changes or modification not expressly approved in this manual could void your authority to operate this equipment.

Owner's Record

The model and serial numbers are located at the rear of the unit.

Record the serial number in the space provided below. Refer to them whenever you call upon your Sony dealer regarding this product.

Model No. CDP-CX55

Serial No. _____

(Except for the customers in the United States and Canada)

The following caution label is located inside the unit.



This appliance is classified as a CLASS 1 LASER product.

The CLASS 1 LASER PRODUCT MARKING is located on the rear exterior.

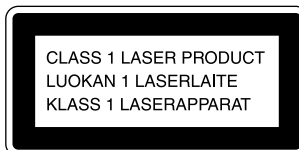

For the customers in Canada

CAUTION

TO PREVENT ELECTRIC SHOCK, DO NOT USE THIS POLARIZED AC PLUG WITH AN EXTENSION CORD, RECEPTACLE OR OTHER OUTLET UNLESS THE BLADES CAN BE FULLY INSERTED TO PREVENT BLADE EXPOSURE.

This equipment is intended for home entertainment purposes only. The warranty shall be invalidated if used in commercial environments, such as by disc jockeys, etc., even within the Warranty Period.

Welcome!

Thank you for purchasing the Sony Compact Disc Player. Before operating the unit, please read this manual thoroughly and retain it for future reference.

About This Manual

The instructions in this manual are for model CDP-CX55.

Conventions

- Instructions in this manual describe the controls on the player. You can also use the controls on the remote if they have the same or similar names as those on the player.
- The following icons are used in this manual:



Indicates that you can do the task using the remote.



Indicates hints and tips for making the task easier.

TABLE OF CONTENTS

Getting Started

Unpacking	4
Hooking Up the System	4
Connecting Another CD Player	6
Inserting CDs	7

Playing a CD	10
--------------------	----

Playing CDs

Using the Display	12
Locating a Specific Disc	13
Specifying the Next Disc to Play	15
Locating a Specific Track or a Point in a Track	15
Playing Repeatedly	16
Playing in Random Order (Shuffle Play)	16
Creating Your Own Program (Program Play)	17
Looping Part of a Disc (Loop) 	19
Playing Your Favorite Disc Independently (Plus One Play)	19
Controlling Another CD Player (Mega Control)	20
Playing Alternately (No-Delay Play/X-Fade Play)	21

Storing Information About CDs (Custom Files)

What You Can Do With the Custom Files	22
Labeling Discs (Disc Memo)	22
Storing Specific Tracks (Delete Bank)	25

Additional Information

Precautions	26
Notes on CDs	26
Troubleshooting	27
Specifications	27

Index	Back cover
-------------	------------

Unpacking

Check that you received the following items:

- Audio cord (1)
- Remote commander (remote) (1)
- Sony SUM-3 (NS) batteries (2)
- CD booklet holder (1)

💡 How to use the CD booklet holder

The CD booklet holder helps you locate the disc easily. After you have inserted discs into the player, you can put the CD booklet (which comes with a CD) into the supplied holder.

Inserting batteries into the remote

You can control the player using the supplied remote. Insert two size AA (R6) batteries by matching the + and - on the batteries. When using the remote, point it at the remote sensor  on the player.

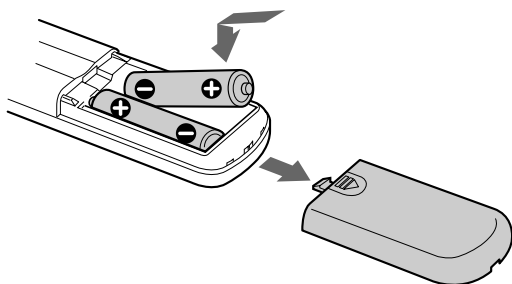

💡 When to replace batteries

With normal use, the batteries should last for about six months. When the remote no longer operates the player, replace all the batteries with new ones.

Notes

- Do not leave the remote near an extremely hot or humid place.
- Do not drop any foreign object into the remote casing, particularly when replacing the batteries.
- Do not expose the remote sensor to direct sunlight or lighting apparatuses. Doing so may cause a malfunction.
- If you do not use the remote for an extended period of time, remove the batteries to avoid possible damage from battery leakage and corrosion.

Hooking Up the System

Overview

This section describes how to hook up the CD player to an amplifier. Be sure to turn off the power of each component before making the connections.

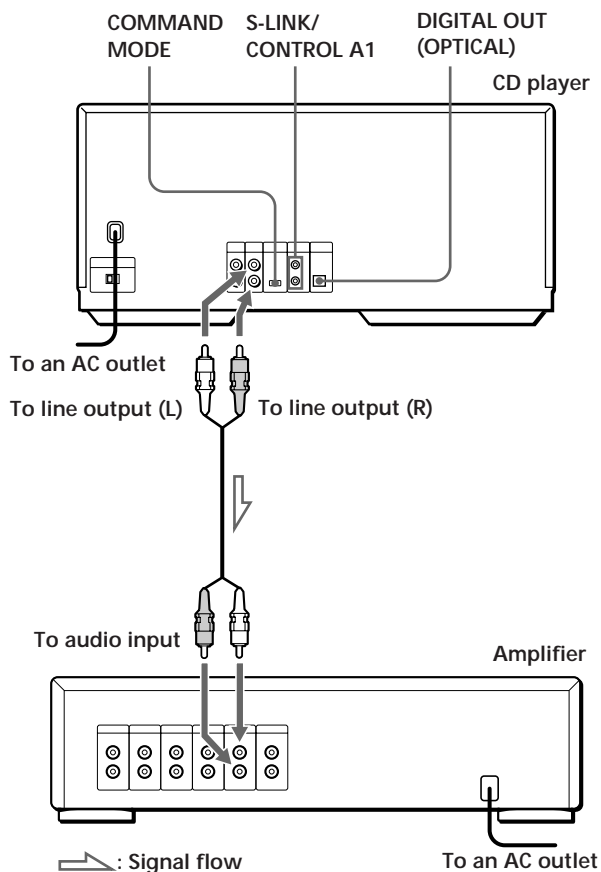

What cords will I need?

Audio cord (1) (supplied)

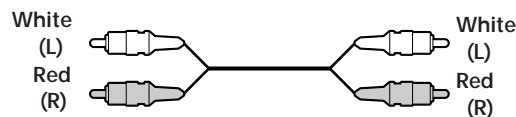

Hookups

When connecting the audio cord, be sure to match the color-coded cord to the appropriate jacks on the components: Red (right) to Red and White (left) to White. Be sure to make connections firmly to avoid hum and noise.

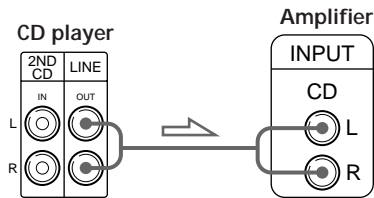

- If you have a digital component such as a digital amplifier, D/A converter, DAT or MD

Connect the component via the DIGITAL OUT (OPTICAL) connector using an optical cable (not supplied). Take off the cap and plug in the optical cable.

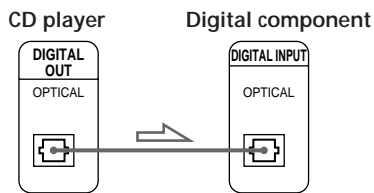
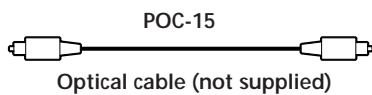

Note

When you connect via the DIGITAL OUT (OPTICAL) connector, noise may occur when you play CD software other than music, such as a CD-ROM.

- If you have a Sony component with the CONTROL A1 jack

Connect the component via the CONTROL A1 jack. You can simplify the operation of audio systems composed of separate Sony components. For details, refer to the supplementary "CONTROL-A1 Control System" instructions.

- When using another Sony CD player together with this player

You can make the supplied remote effective only for this player.

- When using the player equipped with the COMMAND MODE selector:
 - Set the COMMAND MODE selector of this player to CD 1 and that of another player to CD 2 or CD 3. Then set the CD 1/2/3 switch on the remote supplied for each player accordingly.
- When using the player not equipped with the COMMAND MODE selector:
 - The command mode of the player without the COMMAND MODE selector is set to CD 1. Set the COMMAND MODE selector of this player to CD 2, and set the CD 1/2/3 switch on the remote to CD 2.

Setting the voltage selector (voltage selector equipped models only)

Check that the voltage selector on the rear panel of the player is set to the local power line voltage. If not, set the selector to the correct position using a screwdriver before connecting the AC power cord to a wall outlet.

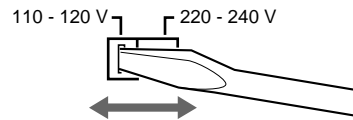

Connecting the AC power cord

Connect the AC power cord to a wall outlet.

Note on placement

Be sure to place the player on a horizontal place. If the player is slanted, it may cause malfunction or damage the player.

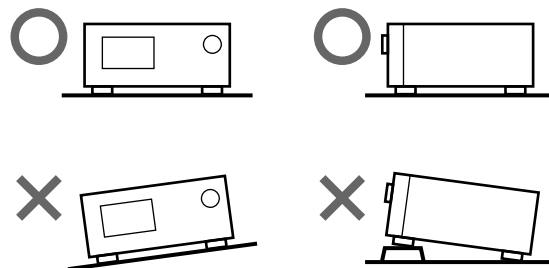

Connecting Another CD Player

If you have a Sony CD player equipped with the CONTROL A1 jack and the command mode of that player can be set to CD 3, you can control that player as the second player with this unit. After connecting this unit and an amplifier, follow the procedure below. Be sure to turn off the power of each player before making this connection.

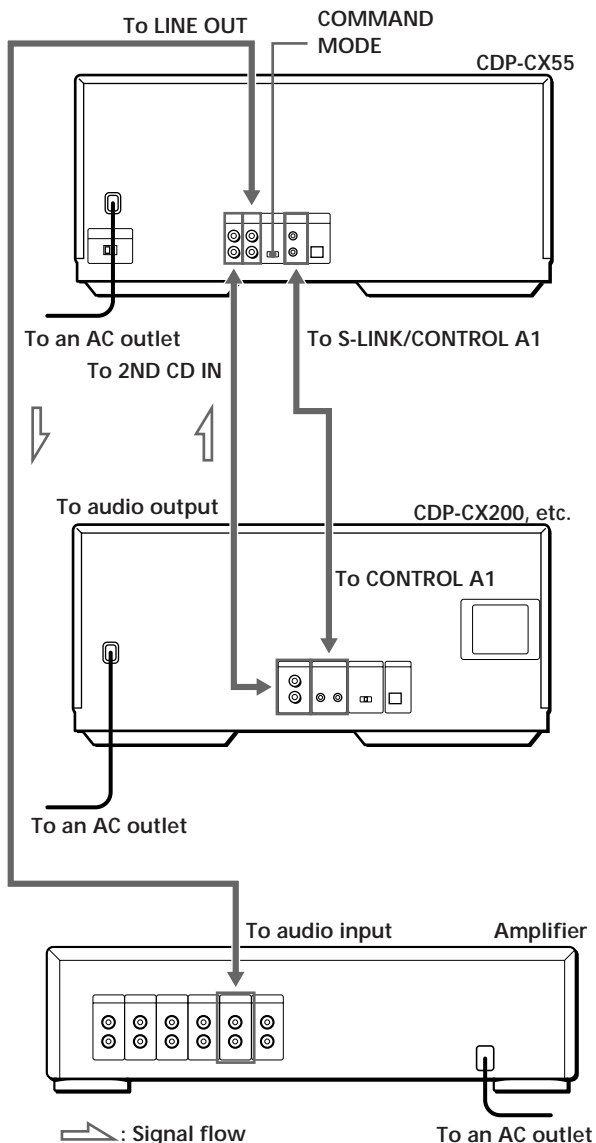

What cords will I need?

- Audio cord (1) (Use the cord supplied with the player to be connected.)
- CONTROL A1 cord (1) (not supplied)

- 1 Connect the players with an audio cord (see also “Hookups” on page 5).

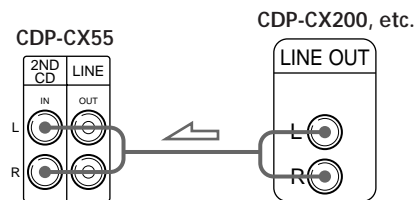

- 2 Connect the players with a CONTROL A1 cord.

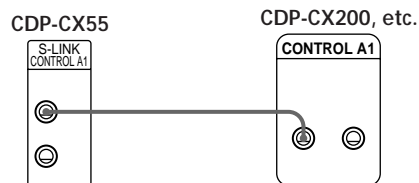

For details on this connection, refer to the supplementary “CONTROL-A1 Control System” instructions.

- 3 Set the COMMAND MODE selector of each player. Set the COMMAND MODE selector of this player to CD 1 or CD 2, and set that of the second player to CD 3.

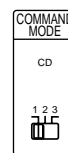

For details on how to operate the second player, see “Controlling Another CD Player” on page 20 and “Playing Alternately” on page 21.

- 4 Connect the AC power cord of both players to AC outlets.

Notes

- Do not connect a player other than that you use as the second player to the 2ND CD IN jacks of this player.
- When connecting a second CD player, do not connect the DIGITAL OUT (OPTICAL) connector of this unit to the amplifier.

Inserting CDs

You can insert up to 51 discs into this player.

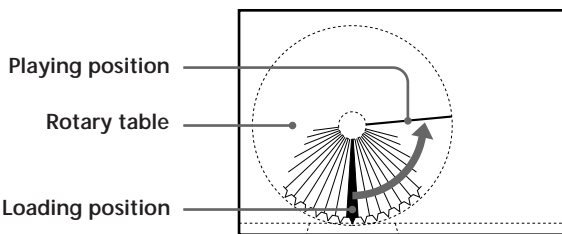
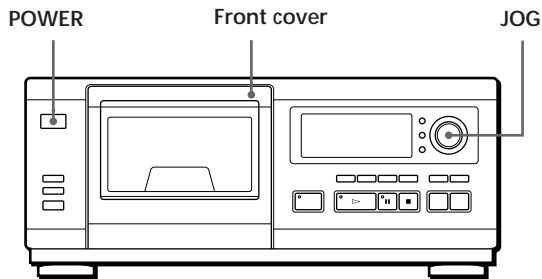

- 1 Press POWER to turn on the player.
- 2 Open the front cover by pushing the right edge of the cover.

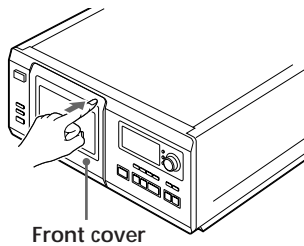

- 3 Turn the JOG dial until you find the disc slot where you want to insert a disc, while checking the disc number (written beside every slot and also indicated in the display).

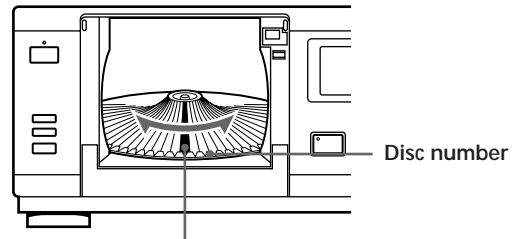

The disc number at the loading position appears in the display.* If the disc has the Disc Memo (see page 22), the Disc Memo appears instead of the disc number. As you turn the JOG dial, the disc number or the Disc Memo changes.

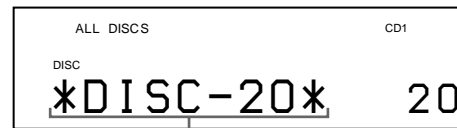

Disc number or the Disc Memo

You can play the disc you want independently by using the Plus One function. When using this function, insert the disc into the PLUS ONE slot. For details, see "Playing Your Favorite Disc Independently" on page 19.

* If you have already inserted discs, the disc number at the playing position appears. When you turn the JOG dial, the displayed disc number changes to the one at the loading position.

(Continued)

Getting Started

- 4 Insert a disc with the label side facing right.

Notes

- Make sure you have inserted the disc into each slot at a right angle to the rotary table. If the disc is not put in straight, it may damage the player or the disc.
- Make sure the rotary table comes to a complete stop before inserting or removing discs.

With the label side facing right

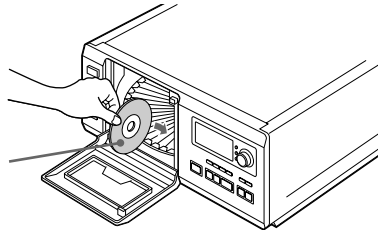

After inserting the disc, you can input the original disc titles instead of the disc numbers (see “Labeling Discs” on page 22) to locate it easily when you start playing.



- 5 Repeat Steps 3 and 4 to insert more discs.
- 6 Close the front cover by pushing the right edge of the cover until it clicks.

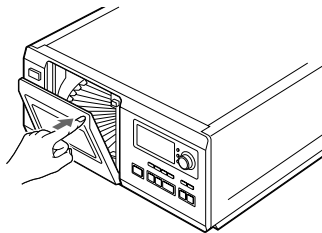

The rotary table turns and the disc slot at the loading position is set to the playing position. Always close the front cover except when you insert or remove discs.

 The supplied CD booklet holder helps you locate a disc

You can store up to 50 CD booklets.

Notes

- Do not insert an empty 8 cm (3-inch) CD adaptor (CSA-8). It may damage the player.
- Do not attach anything such as seals or sleeves to CDs. It may damage the player or the disc.
- If you drop a disc into the player and the CD won't go into the slot correctly, consult your nearest Sony dealer.
- When transporting the player, remove all discs from the player.

Removing CDs

After following Steps 1 to 3 of “Inserting CDs” on page 7, remove the discs. Then close the front cover.

Note

The disc being played does not come to the loading position if you open the front cover during playback. (The disc number flashes in the display.)

If you want to remove the disc being played, push the JOG dial after opening the front cover. The disc comes to the loading position. Remove the disc after the rotary table comes to a complete stop.

Playing a CD

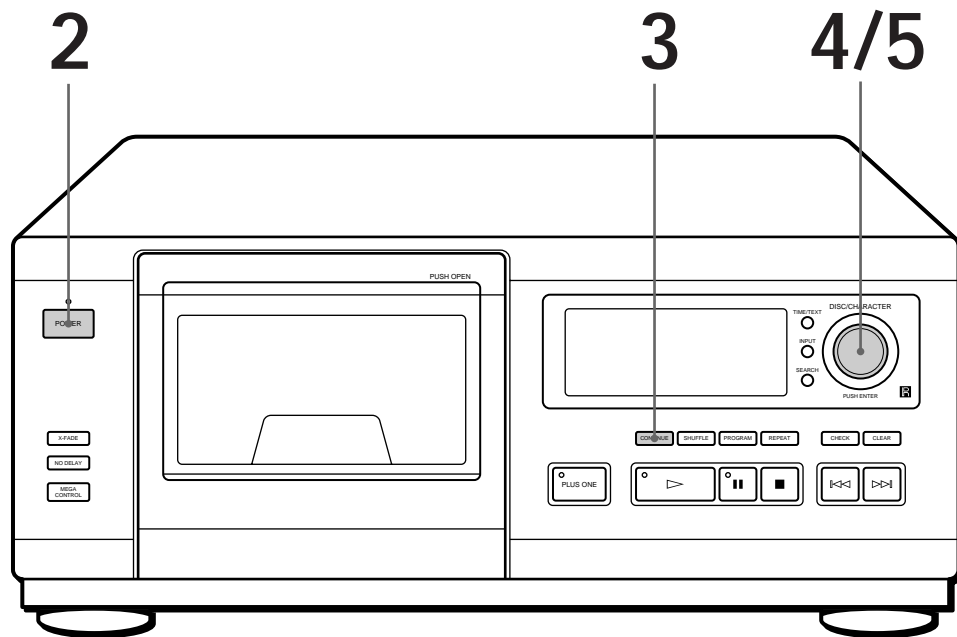

- See pages 4 – 5 for the hookup information.
- Make sure you have inserted the discs correctly as indicated on page 7.
- You can play all the tracks on a disc in the original order (Continuous Play). You can also play up to 51 discs consecutively.

💡 You can turn on the player by pressing POWER on the remote 

- 1 Turn on the amplifier and select the CD player position.
- 2 Press POWER to turn on the player.
- 3 Press CONTINUE to select ALL DISCS or 1 DISC Continuous Play mode.
Each time you press CONTINUE, “ALL DISCS” or “1 DISC” appears in the display.

When you select	The player plays
ALL DISCS	All discs in the player consecutively in the order of disc number. Empty disc slots are skipped.
1 DISC	Only one disc you have selected

- 4 Turn the JOG dial until the disc number or the Disc Memo (see page 22) you want appears in the display to select the first disc (ALL DISCS) or the disc you want (1 DISC).









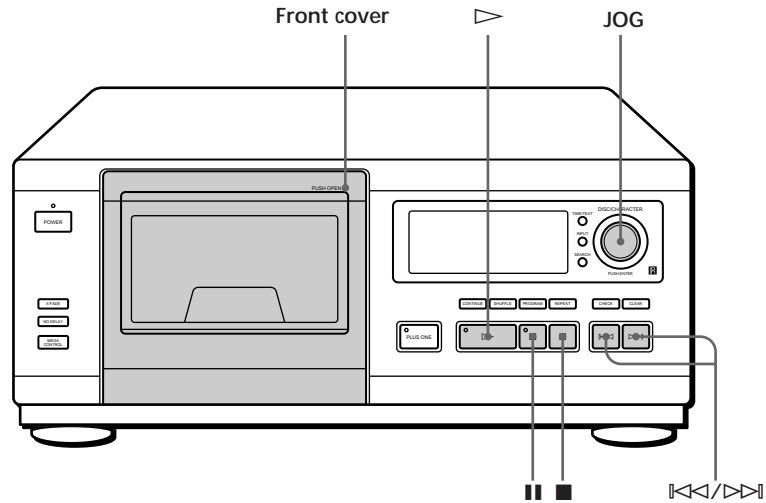

 When you turn off the player
The player remembers the
last playing disc and the
play mode (Continuous,
Shuffle (see page 16) or
Program (see page 17)).
When you turn on the
player again, therefore, the
player plays the same disc in
the same play mode.

- 5** Push the JOG dial to start playing.
The selected disc is set to the playing position, and the player
plays all the discs from the selected one (ALL DISCS) or all the
tracks once (1 DISC).
Adjust the volume on the amplifier.

To stop playback

Press .



To	You need to
Pause	Press 
Resume playing after pause	Press  or 
Go to the next disc 	Press DISC SKIP + once. Hold down the button to skip discs.
Go back to the preceding disc 	Press DISC SKIP - once. Hold down the button to skip discs.
Go to the next track	Press 
Go back to the preceding track	Press 
Stop playing and remove the disc	Open the front cover, then push the JOG dial

Using the Display

You can check information about the disc using the display.

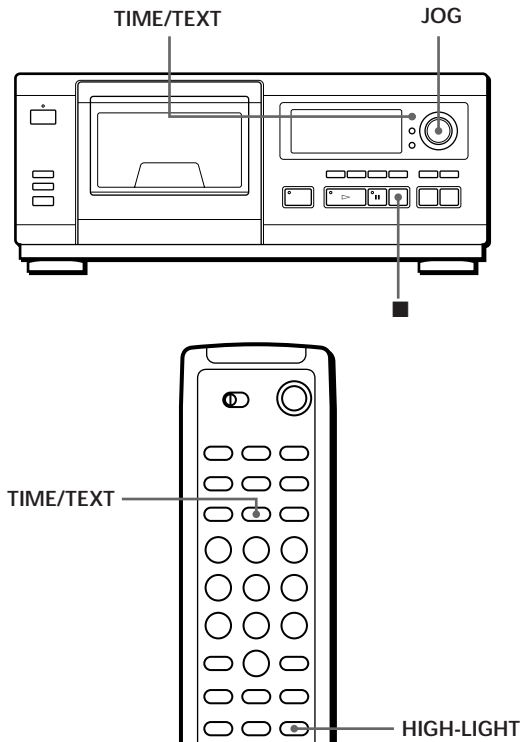

Display information while playing a disc

While playing a disc, the display shows the current disc number, track number, playing time of the track and the next disc number.

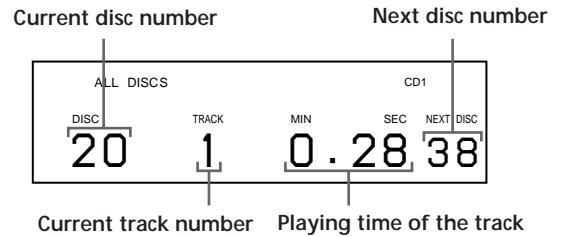

Checking the information of CD-TEXT discs

CD-TEXT discs have information, such as the disc titles or artist names, memorized in a blank space on the discs where there is no information on normal discs. The display shows the CD-TEXT information of the disc so that you can check the current disc title, track title and artist name. When you select a CD-TEXT disc, the "CD-TEXT" indication lights up in the display.

Display information before you start playing

The display shows the disc title. When you press TIME/TEXT, the artist name scrolls in the display. If you press TIME/TEXT again, the display shows the current disc number, total number of tracks and total playing time of the disc. The display shows the disc title again after a while.



Checking the total number and playing time of the tracks

Select the disc you want to check, and push the JOG dial in the Continuous Play mode. As the player starts play automatically, press ■ to stop, and then TIME/TEXT.

The display shows the current disc number, total number of tracks and total playing time of the disc.

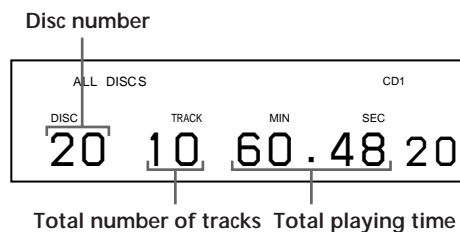

- 💡 When you want to check another disc  Press DISC SKIP on the remote in the stop mode to select the disc you want to check. The total number of tracks and the total playing time of the selected disc appear for a while.

Display information while playing a disc

Each time you press TIME/TEXT, the display shows the information as shown below.

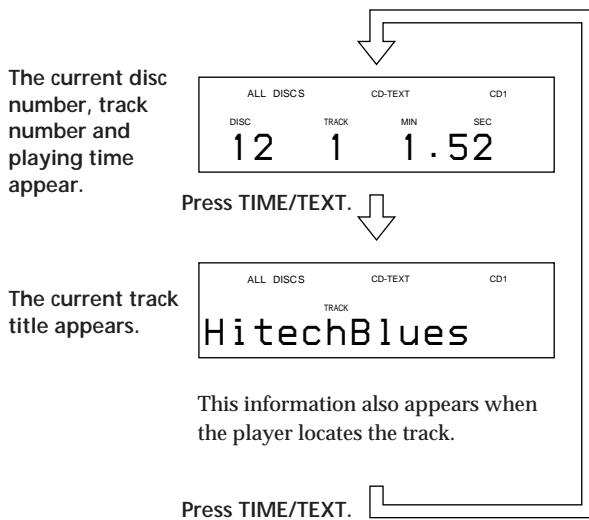

To play disc highlights

Some CD-TEXT discs have a feature to play only the highlights of the discs.

Press HIGH-LIGHT on the remote to start playing disc highlights in the stop mode.

The indicator on the  button flashes while playing disc highlights.

If you press HIGH-LIGHT while selecting discs without this feature, "NO HIGHLIGHT" appears in the display.

Locating a Specific Disc

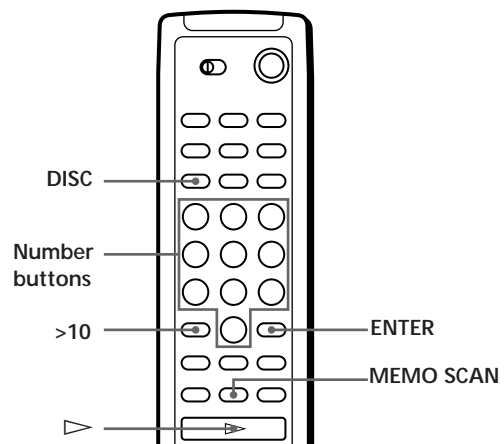
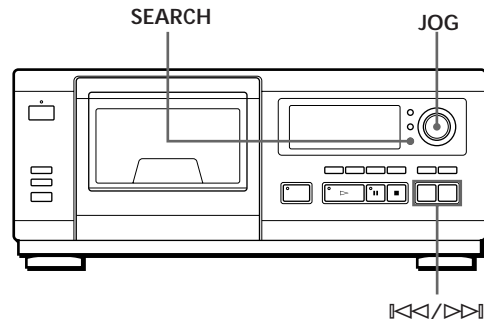

Selecting a disc on the player

Turn the JOG dial until the disc number or Disc Memo (see page 22) you want appears in the display. Push the JOG dial to start play.

Selecting a disc directly using the remote

- 1 Press DISC.
- 2 Press the number button of the disc.
Example: To enter number 35
Press >10 first, then 3 and 5.
- 3 Press ENTER to start play.

Locating a disc by scanning each Disc Memo (Memo Scan)

You can locate a disc you want to play quickly by scanning the Disc Memos (see page 22) in the display and start playing.

Note that you cannot use this function in the ALL DISCS Shuffle Play mode.

- 1 Press MEMO SCAN.
“MEMO SCAN” appears in the display, and the Disc Memos scroll in the display.
- 2 Press \triangleright when the Disc Memo of the disc you want to play appears.
The disc is set to the playing position, and the player starts playing.
In Program Play mode, the disc will be added to the end of the program if you press ENTER instead of \triangleright .

Note

If “NO ENTRY” appears in the display, no disc has been labeled with the Disc Memo. Try the Memo Scan function again after labeling the discs.

Locating a disc by searching a specific Disc Memo (Memo Search)

You can search and locate a disc you want by inputting the first character used in the Disc Memo (see page 22).

- 1 Press SEARCH.
“MEMO SEARCH” appears in the display.
- 2 Press $\llcorner\llcorner/\triangleright\triangleright$ repeatedly to input the first character.



Each time you press $\llcorner\llcorner/\triangleright\triangleright$, the characters appear in the following order.

A B C D E F G H I J K L M N O P Q R S T U V W X
Y Z 0 1 2 3 4 5 6 7 8 9

If “NOT FOUND” appears in the display while inputting the first character with the $\llcorner\llcorner/\triangleright\triangleright$ buttons, no disc has been labeled using the input character.

Notes

- When searching input characters, blanks and symbols before the first character in the Disc Memo are ignored.
 - When searching input characters, upper and lower cases cannot be differentiated.
- 3 Turn the JOG dial to find the disc you want.
As you turn the JOG dial, the Disc Memos starting with the input character appear in the display.
 - 4 Push the JOG dial to select the disc.
In Program Play mode, the disc will be added to the end of the program.

To cancel Memo Search
Press SEARCH again.

 If there is no more Disc Memo starting with the input character in Step 3
The input character changes to the next one when you turn the JOG dial.

Specifying the Next Disc to Play

You can specify the next disc to play while playing a disc in Continuous or 1 DISC Shuffle Play mode.

While playing a disc, turn the JOG dial until the disc number or Disc Memo (see page 22) you want appears in the display.

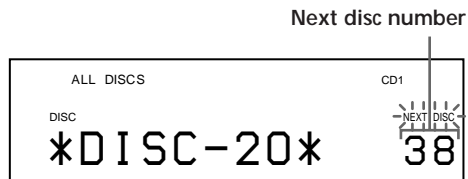

After the current disc is played, the next disc you have specified starts playing.

If you want to skip to the next disc right away, push the JOG dial while playing the current disc.

To cancel the disc you have specified
Press CONTINUE twice.

Locating a Specific Track or a Point in a Track

You can quickly locate any track while playing a disc using the \lll/\ggg (AMS: Automatic Music Sensor) buttons or number buttons on the remote. You can also locate a specific point in a track while playing a disc.

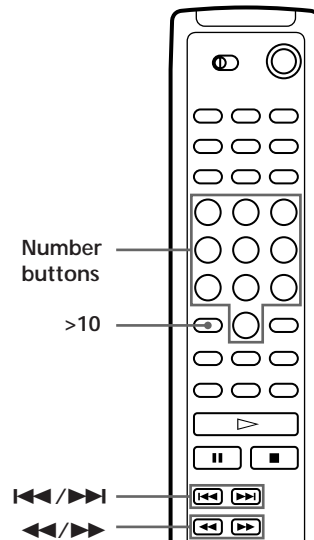
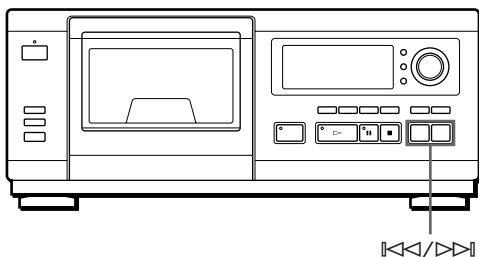

To locate	Press
the next or succeeding tracks	\ggg repeatedly until you find the track
the current or preceding tracks	\lll repeatedly until you find the track
a specific track directly \mathbb{I}	Number button of the track on the remote
a point in a track while monitoring the sound \mathbb{I}	\lll (backward)/ \ggg (forward) on the remote and hold down until you find the point
a point in a track quickly by observing the display \mathbb{I}	\lll (backward)/ \ggg (forward) on the remote and hold down until you find the point during pause. You will not hear the sound during the operation.

\mathbb{I} When you directly locate a track numbered over 10 \mathbb{I}
Press >10 first, then the corresponding number buttons on the remote.

Note

If "OVER" appears in the display, the disc has reached the end while you were pressing \ggg . Press \lll or \lll to go back.

Playing Repeatedly

You can play discs/tracks repeatedly in any play mode.

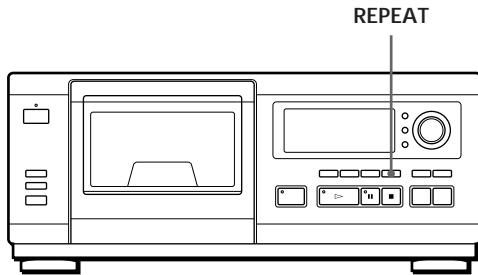

Press REPEAT while playing a disc. "REPEAT" appears in the display. The player repeats the discs/tracks as follows:

When the disc is played in	The player repeats
ALL DISCS Continuous Play (page 10)	All tracks on all discs
1 DISC Continuous Play (page 10)	All tracks on the current disc
ALL DISCS Shuffle Play (page 16)	All tracks on all discs in random order
1 DISC Shuffle Play (page 16)	All tracks on the current disc in random order
Program Play (page 17)	The same program

To cancel Repeat Play
Press REPEAT repeatedly until "REPEAT OFF" appears in the display.

Repeating the current track

You can repeat only the current track.

While the track you want is being played, press REPEAT repeatedly until "REPEAT 1" appears in the display.

Playing in Random Order (Shuffle Play)

You can have the player "shuffle" the tracks and play in random order. The player shuffles all the tracks on all discs or on the disc you specified.

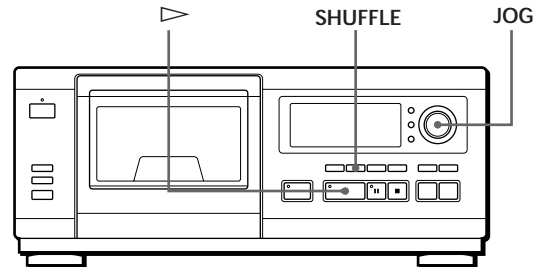

- 1 Press SHUFFLE to select ALL DISCS or 1 DISC Shuffle Play mode. Each time you press SHUFFLE, "ALL DISCS" or "1 DISC" appears in the display.



When you select	The player plays
ALL DISCS	All tracks on all discs in random order
1 DISC	All tracks on the specific disc in random order

- 2 When you want to specify the disc for 1 DISC Shuffle Play, turn the JOG dial until the disc number or Disc Memo (see page 22) you want appears in the display.
- 3 Push the JOG dial or press ▷. ALL DISCS or 1 DISC Shuffle Play starts. "◻" appears in the display while the player is "shuffling" the discs or the tracks.

To cancel Shuffle Play
Press CONTINUE.

💡 You can start Shuffle Play while playing
Press SHUFFLE, and Shuffle Play starts from the current track.

💡 You can directly select a disc for 1 DISC Shuffle Play 📶
See "Selecting a disc directly using the remote" on page 13.

 You can go to the next disc during 1 DISC Shuffle Play 
Press DISC SKIP +.

 You can specify the next disc to play during 1 DISC Shuffle Play
Turn the JOG dial to specify the next disc. After all the tracks on the current disc are played in random order, the next disc starts playing. If you want to skip to the next disc right away, push the JOG dial while playing the current disc.

Notes

- You cannot specify the next disc to play during ALL DISCS Shuffle Play.
- Even if you press  or turn off the player during ALL DISCS Shuffle Play, the player remembers which discs/tracks were played and which were not. Therefore, if you want to start ALL DISCS Shuffle Play again from the beginning, be sure to repeat the procedure from Step 1.

Creating Your Own Program (Program Play)

You can arrange the order of the tracks and/or discs to create three different programs and programs are stored automatically. Each program (PROGRAM 1, 2 or 3) can contain up to 32 “steps” — one “step” may contain a track or a whole disc.

You can make programs using the controls on the remote as well as ones on the player. However, the programming procedures are different.

Creating a program on the player

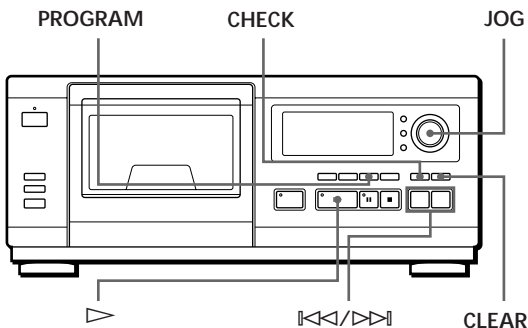

- 1 Press PROGRAM until the program number you want (PROGRAM 1, 2 or 3) appears in the display. If a program is already stored in the selected program number, the last step of the program appears in the display. When you want to erase the whole program, hold down CLEAR until “ALL CLEAR” appears in the display (see page 19).
- 2 Turn the JOG dial until the disc number you want appears in the display.

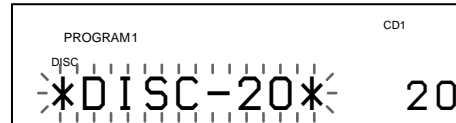

- 3 To program a whole disc, skip this step. Press  until the track number you want appears in the display.

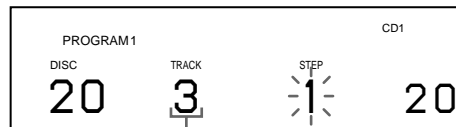

Track number

- 4 Push the JOG dial or press PROGRAM.

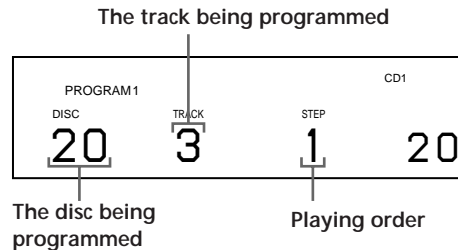

- 5 To program other discs/tracks, do the following:

To program	Repeat Steps
Other discs	2 and 4
Other tracks on the same disc	3 and 4
Other tracks on other discs	2 to 4

- 6 Press  to start Program Play.

To cancel Program Play
Press CONTINUE.

Playing CDs

 The programs remain even after Program Play ends. When you press \triangleright , you can play the same program again.

 When you press PROGRAM during Continuous or Shuffle Play. The program will be played after the current track.

 The programs remain until you erase them. If you replace discs, the programmed disc and track numbers remain. So, the player plays only the existing disc and track numbers. However, the disc and track numbers that are not found in the player or on the disc are deleted from the program, and the rest of the program is played in the programmed order.

Creating a program using the remote

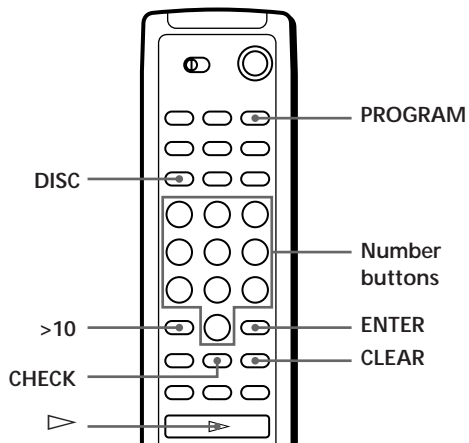

- 1 Press PROGRAM until the program number you want (PROGRAM 1, 2 or 3) appears in the display.
- 2 Press DISC.

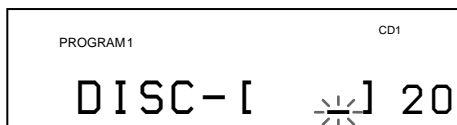

- 3 Press the number button of the disc.

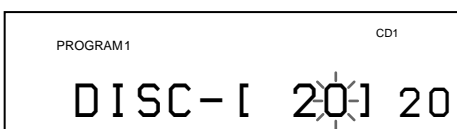

- 4 To program a whole disc, skip this step and go to Step 6. Press >10.

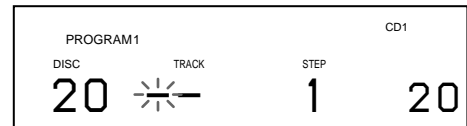

- 5 Press the number button of the track. The number you pressed is entered into the flashing digit.

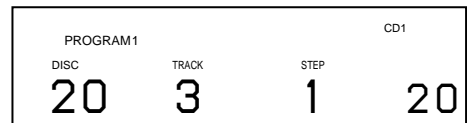

- 6 Press ENTER.

The disc being programmed

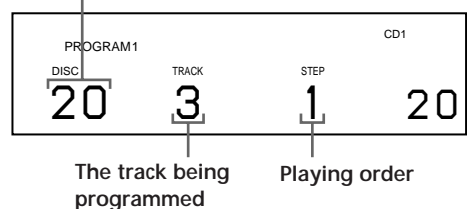

- 7 To program other discs/tracks, do the following:

To program	Repeat Steps
Other discs	2, 3 and 6
Other tracks on the same disc	4 to 6
Other tracks on other discs	2 to 6

- 8 Press \triangleright to start Program Play.

To cancel Program Play
Press CONTINUE.

Checking the programmed order

You can check your program before or after you start playing.

Press CHECK.

Each time you press this button, the display shows the disc and track number of each step in the programmed order. (When a whole disc is programmed as one step, "ALL" appears instead of the track number.) After the last step in the program, the display shows "END" and returns to the original display.

Changing the programmed order

You can change your program before you start playing.

To	You need to
Erase a track or disc	Press CHECK until the track or disc you do not want appears in the display, then press CLEAR
Erase the last track or disc in the program	Press CLEAR. Each time you press the button, the last track or disc will be cleared.
Add tracks or discs to the end of the program	Follow the programming procedure
Change the whole program completely	Hold down CLEAR until "ALL CLEAR" appears in the display to erase the whole program, then create a new program following the programming procedure

Erasing the programs stored in memory

- 1 Press PROGRAM repeatedly in the stop mode until the program number (PROGRAM 1, 2 or 3) you want to erase appears in the display.
- 2 Hold down CLEAR until "ALL CLEAR" appears in the display.

Looping Part of a Disc (Loop)



You can repeat part of a disc during playback. This function lets you create original recordings.

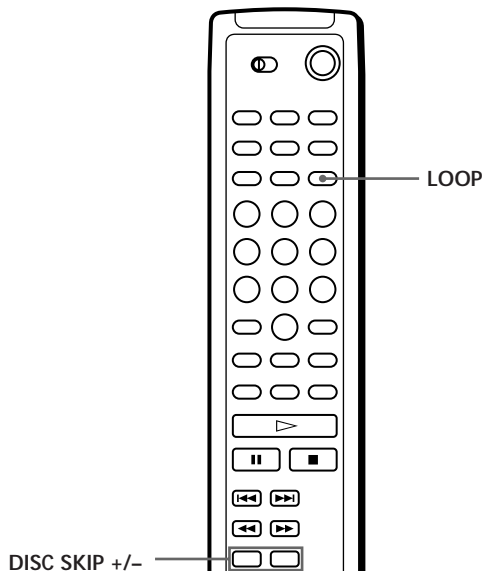

Press and hold LOOP during playback at the point you want to start the Loop function, and release to resume normal play.

To adjust the loop length

Press DISC SKIP +/- while holding LOOP on the remote to select different loop lengths (LOOP 1-20).

Playing Your Favorite Disc Independently (Plus One Play)

When you insert a disc into the PLUS ONE slot, you can play the disc independently from other discs. When using this function, the player is automatically set to 1 DISC Continuous Play mode.

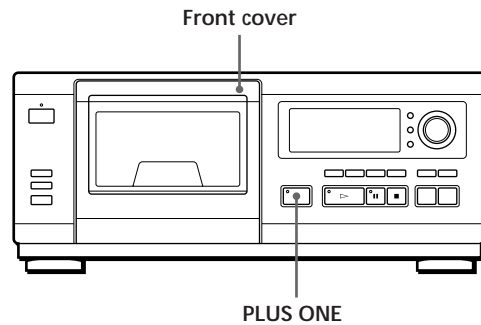

- 1 Open the front cover.
- 2 Press PLUS ONE. The indicator on the PLUS ONE button lights up.



The PLUS ONE slot comes to the loading position.

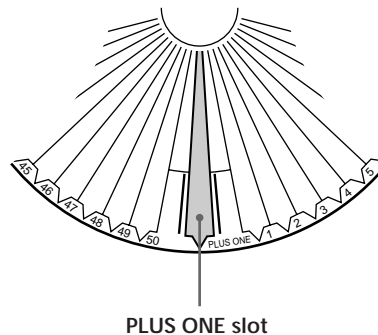



(Continued)

- 3 Insert a disc into the PLUS ONE slot.
- 4 Close the front cover.
“P1” appears in the display instead of the disc number, and the player starts playing the disc in the PLUS ONE slot.



To cancel Plus One Play

Press PLUS ONE. The indicator on the PLUS ONE button goes off. The disc number in the display changes to 51 and you can play the disc as the 51st disc.

-  If you have already inserted a disc into the PLUS ONE slot
Press PLUS ONE while the front cover is closed. Plus One Play starts immediately.
-  You can select Shuffle Play mode during Plus One Play
Press SHUFFLE before Step 4 above.

Notes

- Plus One Play will be canceled if you turn the JOG dial or press buttons to specify the other disc.
- Plus One Play will be canceled if you press the PROGRAM button.
- The PLUS ONE slot comes to the loading position automatically if you open the front cover during Plus One Play. Do not put your hand inside the compartment nor change the disc before the rotary table comes to a complete stop. If you do, you may injure your hand or damage the disc.

Controlling Another CD Player (Mega Control)

This unit can control a second CD player (see “Connecting Another CD Player” on page 6). Even when a second CD player is connected, the controls on both of the units will function. When you press the play button on either unit, the operating player stops and the resting player starts. Make sure “2nd DETECTED” appears in this player’s display after turning on both players.

The controls indicated in the illustration below are effective while the MEGA CONTROL button is lit.

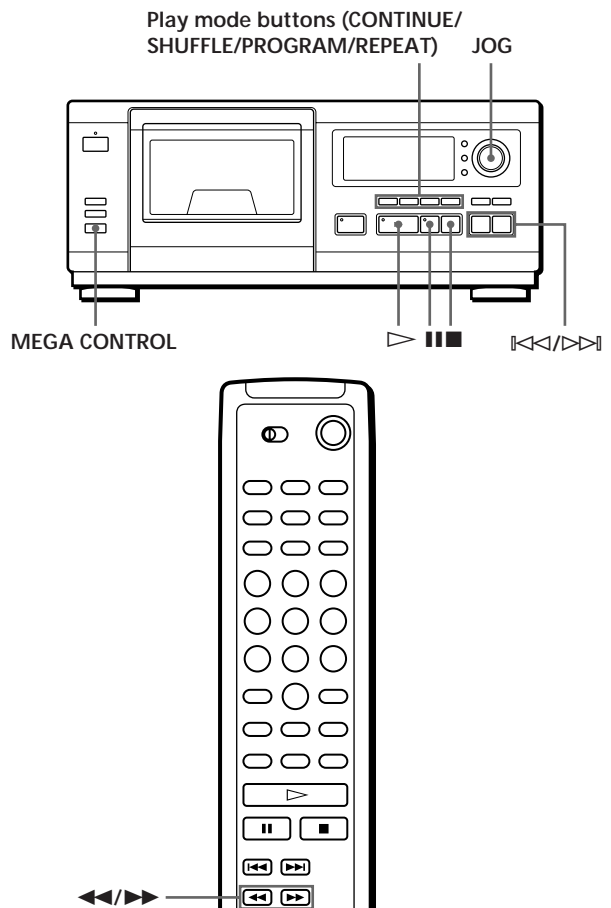

- 1 Press MEGA CONTROL on this player.
The MEGA CONTROL button and “2nd” in the display light up. The display shows the current disc number of the second player.

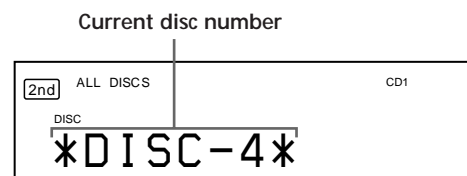

- 2 Select the play mode you want.
To program tracks, use the controls on the second player.
- 3 Press ▷ on this player to start playing.
The play starts and the display shows the current disc and track numbers and the playing time of the track.
While the MEGA CONTROL button is lit, you can control the second player with the controls on this player.

To control the second player directly using the supplied remote
Set CD 1/2/3 on the remote to CD 3 which is the same position as the COMMAND MODE selector on the rear panel of the second player.

To control this player again
Press MEGA CONTROL. The MEGA CONTROL button goes off and you can control this player.

Playing Alternately (No-Delay Play/X-Fade Play)

When you connect the second player, you can play tracks in this player and those in the second player alternately in any play mode (see “Connecting Another CD Player” on page 6).

Select one of the following methods:

- **No-Delay Play:** The current player changes at each track. Each time the current player changes to the other player, the other player starts play without a break in sound immediately after the current player ends play. The other player skips the lead-in portion and starts playing from where the sound actually begins.
- **X-Fade Play:** The current player changes at each track or at the specified interval. You can select the interval among 30, 60 and 90 seconds. Each time the current player changes to the other player, the sound from both players is mixed. The current player ends play by fading out, and the other player starts play by fading in.

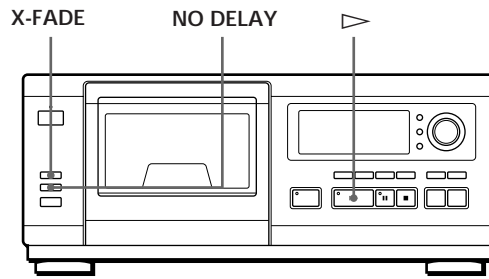

- 1 Select the play mode you want on each player.

- 2 When you select No-Delay Play
Press NO DELAY.
“NO DELAY” appears in the display.
When you select X-Fade Play
Press X-FADE.
“X-FADE” appears in the display.

Each time you press the X-FADE button, the indication appears as follows:

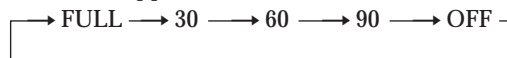

To change the current player each time a whole track is finished, select “FULL.”

To change the current player at the specified interval, press X-FADE repeatedly until the interval you want appears in the display.

- 3 Press ▷ to start playing.
The MEGA CONTROL button lights up while the track in the second player is selected.

To cancel No-Delay/X-Fade Play

Press the corresponding button repeatedly until “NO DELAY” or “X-FADE” disappears from the display. The current player continues playing.

- 💡 You can change the method (No-Delay or X-Fade) during play
Press the corresponding button (NO DELAY or X-FADE) following the procedure in Step 2 above.

Notes

- The play starts from the second player if you start play while the MEGA CONTROL button is lit.
- When one player has played all the discs/tracks in the player ahead of the other player, the play stops.
- Do not use the controls on the second player during No-Delay/X-Fade Play. They may not work correctly.

What You Can Do With the Custom Files

The player can store two types of information called “Custom Files” for each disc. Once you have stored Custom Files for a disc, the player automatically recalls what you have stored whenever you select the disc. Note that Custom Files will be erased if you do not use the player for about one month.

You can store this information:

When you use	You can
Disc Memo (page 22)	Label discs using up to 12 characters
Delete Bank (page 25)	Delete unwanted tracks and store only the tracks you want

Where are Custom Files stored?

Custom Files are stored not on the disc, but in the player’s memory. It means you cannot use Custom Files when you play the disc on other players.

If you replace discs you have filed in the Custom Files

The Custom File information you have stored remains, since each Custom File information is assigned to each slot. Erase all Custom Files (Disc Memo and Delete Bank) of the old disc, and then file the new disc information in the Custom Files.

Erasing all Custom Files of all discs

Turn off the player. While holding down CLEAR, press POWER to turn on the player. “ALL ERASE” appears in the display, and all Custom Files will be erased.

Labeling Discs (Disc Memo)

You can label discs using up to 12 characters and have the player display the Disc Memo each time you select the disc. The Disc Memo can be anything you like, such as a title, musician’s name, category or date of purchase.



When you select a CD-TEXT disc

The disc title is stored as the Disc Memo automatically. If the disc title has more than 12 characters, the first 12 characters of the disc title are stored (see page 12).

When you replace a disc with a CD-TEXT disc, the disc title of the CD-TEXT disc is also stored automatically. Note that you cannot change the Disc Memo of the CD-TEXT disc.



You can label discs while the front cover is open

Labeling discs on the player

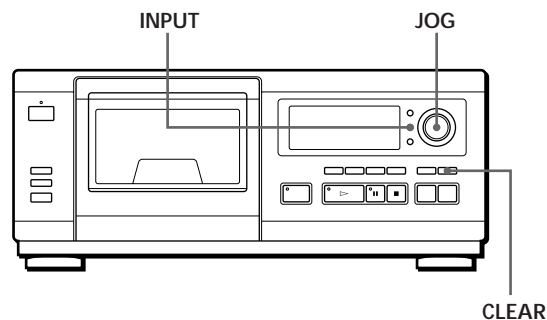

- 1 Turn the JOG dial until the disc number to which you want to assign a Disc Memo appears in the display.
When you label a disc with the front cover closed, the disc number of the disc at the playing position appears.
When you label a disc with the front cover open, the disc number at the loading position appears.
- 2 Press INPUT.
The flashing cursor (◀) appears.

- 3** Turn the JOG dial until the character you want appears in the display.
The cursor disappears and the first space for the Disc Memo flashes.
As you turn the JOG dial clockwise, the characters appear in the following order. Turn the JOG dial counterclockwise to go back to the previous character.

(space) A B C D E F G H I J K L M N O P Q R S T U
V W X Y Z a b c d e f g h i j k l m n o p q r s t u v w
x y z 0 1 2 3 4 5 6 7 8 9 ! " # \$ % & ' () * + , - . / : ; <
= > ? @ [\] ^ _ ` { | } ~



- 4** Push the JOG dial to select the character.
The selected character lights up, and the flashing cursor appears to indicate the next space to be input.



If you have made a mistake
Press CLEAR and begin again by inputting the correct characters.

- 5** Repeat Steps 3 and 4 to input more characters.
6 Press INPUT to store the Disc Memo.
The Disc Memo lights up in the display.



Repeat Steps 1 to 6 to assign Disc Memos to other discs.

Labeling discs using the remote

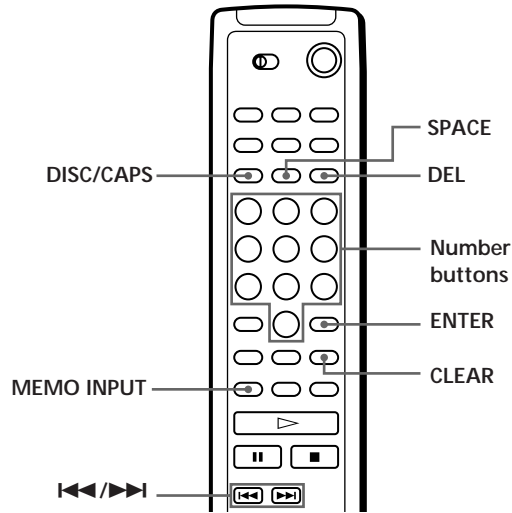

- 1** Press DISC/CAPS.
- 2** Press the number button of the disc you want to assign a Disc Memo, and then ENTER.
- 3** Press MEMO INPUT.
The flashing cursor (◀) appears.
- 4** Press DISC/CAPS to find the letter type you want.
Each time you press the button, the letter type changes cyclically among capital letters (AB), small letters (ab) and numbers (12). The selected letter type appears in the right end of the display.

(Continued)

Storing Information About CDs (Custom Files)

- 5** Press the number button corresponding to the character you want (indicated beside each number button).
The cursor disappears and the first space for the Disc Memo flashes.
Each time you press the button, the character changes cyclically among the ones indicated beside the button.

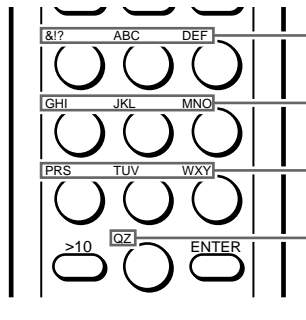

Characters assigned to each number button

Example: To select the letter E
Press the number button 3 twice.

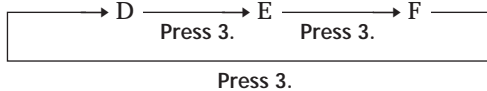

To insert a space, press SPACE once.
To input a number, press DISC/CAPS twice in Step 4, then press the number button you want.
To input symbols, press the number button 1 repeatedly until the symbol you want appears in the display.

- 6** Press ENTER to select the character.
The selected character lights up, and the flashing cursor appears to indicate the next space to be input.
You can also go to the next space by pressing other number buttons.
- 7** Repeat Steps 4 through 6 to input more characters.
- 8** Press MEMO INPUT to store the Disc Memo.
The Disc Memo lights up in the display.



Repeat Steps 1 through 8 to assign Disc Memos to other discs.

💡 If you have made a mistake while inputting the character

To correct the character which has been input

- 1 Press ◀◀ or ▶▶ until the cursor moves next to the incorrect character.



- 2 Press DEL to delete the incorrect character.



- 3 Input the correct character.



To correct the character currently being input

- 1 Press DEL to delete the incorrect character.
- 2 Input the correct character.

To insert a character between the input characters
Press ◀◀ or ▶▶ until the cursor moves next to the point you want to insert, and enter the character.

Erasing the Disc Memo

- 1 Follow Steps 1 and 2 in “Labeling discs on the player” on page 22 to select the Disc Memo you want to erase.
- 2 Press CLEAR.
The Disc Memo disappears.
- 3 Press INPUT.

Storing Specific Tracks (Delete Bank)

You can delete unwanted tracks and store only the tracks you want. When you select the disc containing a Delete Bank, you can play only the remaining tracks.

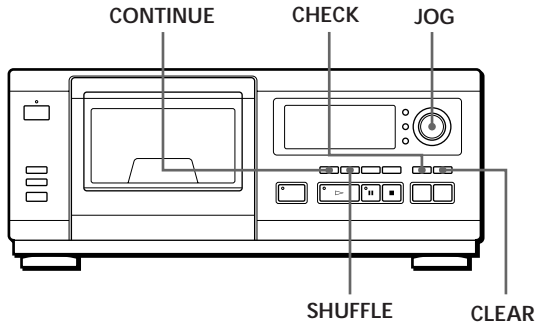

- 1 Press CONTINUE or SHUFFLE before you start playing.
- 2 Turn the JOG dial to select the disc.
- 3 Press CHECK repeatedly until the track you want to delete appears in the display.

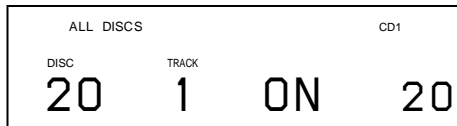

- 4 Press CLEAR. "DELETE FILE" and "OFF" appear in the display.

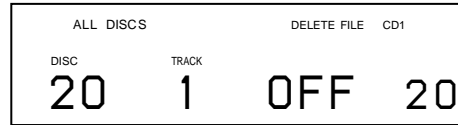

If you want to recover the track, press CLEAR again.

- 5 Repeat Steps 3 and 4 to delete more tracks.

 You can recover all the tracks you have deleted. Hold down CLEAR until "ALL SELECT" appears in the display.

Note

The deleted tracks are skipped even in the Shuffle or Program Play mode (when the whole disc containing a Delete Bank is programmed as one step).

Precautions

On safety

- Caution — The use of optical instruments with this product will increase eye hazard.
- Should any solid object or liquid fall into the cabinet, unplug the player and have it checked by qualified personnel before operating it any further.

On power sources

- Before operating the player, check that the operating voltage of the player is identical with your local power supply. The operating voltage is indicated on the nameplate at the rear of the player.
- The player is not disconnected from the AC power source (mains) as long as it is connected to the wall outlet, even if the player itself has been turned off.
- If you are not going to use the player for a long time, be sure to disconnect the player from the wall outlet. To disconnect the AC power cord (mains lead), grasp the plug itself; never pull the cord.
- AC power cord must be changed only at the qualified service shop.

On placement

- Place the player in a location with adequate ventilation to prevent heat build-up in the player.
- Do not place the player on a soft surface such as a rug that might block the ventilation holes on the bottom.
- Do not place the player in a location near heat sources, or in a place subject to direct sunlight, excessive dust or mechanical shock.

On operation

- If the player is brought directly from a cold to a warm location, or is placed in a very damp room, moisture may condense on the lenses inside the player. Should this occur, the player may not operate properly. In this case, leave the player turned on for about an hour until the moisture evaporates.

On adjusting volume

- Do not turn up the volume while listening to a portion with very low level inputs or no audio signals. If you do, the speakers may be damaged when a peak level portion is played.

On cleaning

- Clean the cabinet, panel and controls with a soft cloth slightly moistened with a mild detergent solution. Do not use any type of abrasive pad, scouring powder or solvent such as alcohol or benzine.

On transportation

- When transporting the player, open the front cover then remove all the discs from the player and turn the power off.

If you have any questions or problems concerning your player, please consult your nearest Sony dealer.

Notes on CDs

On handling CDs

- To keep the disc clean, handle the disc carefully.
- Do not stick paper or tape on the disc.

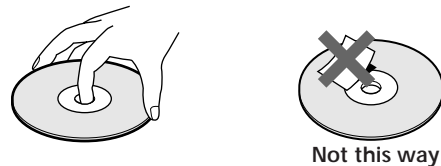

- Do not expose the disc to direct sunlight or heat sources such as hot air ducts, nor leave it in a car parked in direct sunlight as there can be considerable rise in temperature inside the car.
- After removing a disc from the disc slot, store the disc in its case.

On cleaning

- Before playing, clean the disc with a cleaning cloth. Wipe the disc from the center out.

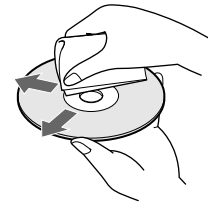

- Do not use solvents such as benzine, thinner, commercially available cleaners or anti-static spray intended for vinyl LPs.

Troubleshooting

If you experience any of the following difficulties while using the player, use this troubleshooting guide to help you remedy the problem. Should any problem persist, consult your nearest Sony dealer.

There is no sound.

- ➔ Check that the player is connected securely.
- ➔ Make sure you operate the amplifier correctly.

The CD does not play.

- ➔ There is no CD in a slot (“-NO DISC-” appears).
Insert a CD.
- ➔ Insert the CD with the label side facing right.
- ➔ Clean the CD (see page 26).
- ➔ Moisture has condensed inside the player. Open the front cover and leave the player turned on for about an hour (see page 26).

The remote does not function.

- ➔ Remove obstacles in the path of the remote and the player.
- ➔ Point the remote at the remote sensor  on the player.
- ➔ Replace all the batteries in the remote with new ones if they are weak.
- ➔ Set the CD 1/2/3 switch on the remote according to the position of the COMMAND MODE selector displayed in the front panel display (see page 5).

The player functions incorrectly.

- ➔ The microcomputer chips may be operating incorrectly. Disconnect the AC power cord, then connect it back to the wall outlet to reset the player.

Specifications

Compact disc player

Laser	Semiconductor laser ($\lambda = 780 \text{ nm}$) Emission duration: continuous
Laser output	Max 44.6 μW * * This output is the value measured at a distance of 200 mm from the objective lens surface on the Optical Pick-up block with 7 mm aperture.
Frequency response	2 Hz to 20 kHz $\pm 1 \text{ dB}$
Signal-to-noise ratio	More than 107 dB
Dynamic range	More than 88 dB
Harmonic distortion	Less than 0.013 %
Channel separation	More than 100 dB

Outputs

	Jack type	Maximum output level	Load impedance
LINE OUT	Phono jacks	2 V (at 50 kilohms)	Over 10 kilohms
DIGITAL OUT (OPTICAL)	Optical output connector	-18 dBm	Wave length: 660 nm

General

Power requirements

Where purchased	Power requirements
USA/Canada	120 V AC, 60 Hz
Australia	240 V AC, 50/60 Hz
UK	220 V - 230 V AC, 50/60 Hz
Other countries	110 V - 120 V or 220 V - 240 V AC, adjustable, 50/60 Hz

Power consumption	12 W
Dimensions (approx.) (w/h/d)	When the front cover is closed 430 × 182.5 × 295 mm (17 × 7 1/4 × 1 5/8 in.) incl. projecting parts When the front cover is open 430 × 182.5 × 414 mm (17 × 7 1/4 × 16 3/8 in.) incl. projecting parts
Mass (approx.)	5.3 kg (11 lbs 11 oz)

Supplied accessories

- Audio cord (2 phono plugs - 2 phono plugs) (1)
- Remote commander (remote) (1)
- Sony SUM-3 (NS) batteries (2)
- CD booklet holder (1)

Design and specifications are subject to change without notice.

Index

A, B

- AMS 15
- Automatic Music Sensor 15

C

- CD-TEXT 12
- Connecting 4
 - another CD player 6
- Continuous Play 10
- X-Fade Play 21
- Custom Files
 - Delete Bank 25
 - Disc Memo 22
 - what you can do with 22

D

- Delete Bank 25
- Disc Memo 22

E, F, G

- Erasing
 - Custom Files 22
 - Delete Bank 25
 - Disc Memo 24
 - programs 19

H

- Handling CDs 26
- Hookups
 - overview 4

I

- Inserting CDs 7

J, K

- JOG dial 7

L

- Labeling a disc 22
- Locating
 - a specific point 15
 - a specific track 15
 - by monitoring 15
 - by observing the display 15
 - directly 15
 - discs 13
 - using AMS 15

M

- Mega Control 20
- Memo Scan 14
- Memo Search 14

N, O

- No-Delay Play 21

P, Q

- Playback
 - Continuous Play 10
 - Program Play 17
 - Repeat Play 16
 - Shuffle Play 16
- Plus One Play 19
- Program
 - changing 19
 - checking 18
 - erasing 19

R

- Remote control 4
- Repeating 16
- Rotary table 7

S

- Searching. *See* Locating
- Selecting a disc 13
- Shuffle Play
 - on all discs 16
 - on one disc 16
- Specifying the next disc 15
- Storing
 - information about CDs 22
 - specific tracks 25

T

- Total playing time 12
- Troubleshooting 27

U, V, W, X, Y, Z

- Unpacking 4

Names of controls

Buttons

- CAPS 23
- CHECK 18, 25
- CLEAR 19, 24
- CONTINUE 10
- X-FADE 21
- DEL 24
- DISC 13, 18, 23
- DISC SKIP 11
- ENTER 13, 18, 24
- HIGH-LIGHT 13
- INPUT 22
- LOOP 19
- MEGA CONTROL 21
- MEMO INPUT 23
- MEMO SCAN 14
- NO DELAY 21
- Number 13, 15
- PLUS ONE 19
- PROGRAM 17
- REPEAT 16
- SEARCH 14
- SHUFFLE 16
- SPACE 24
- TIME/TEXT 12
- ⏪/⏩ 15
- ▷ 11
- ⏸ 11
- 11
- ⏪/⏩ 15
- ⏪/⏩ 15
- >10 13, 15

Switches

- CD 1/2/3 5
- POWER 10

Jacks

- LINE OUT 5
- S-LINK/CONTROL A1 6
- 2ND CD IN 6

Connectors

- DIGITAL OUT (OPTICAL) 5

Others

- COMMAND MODE selector 6
- Disc slots 7
- Display 12
- Front cover 7
- JOG dial 10
- Rotary table 7
- Ⓜ 4