

LCD Colour TV

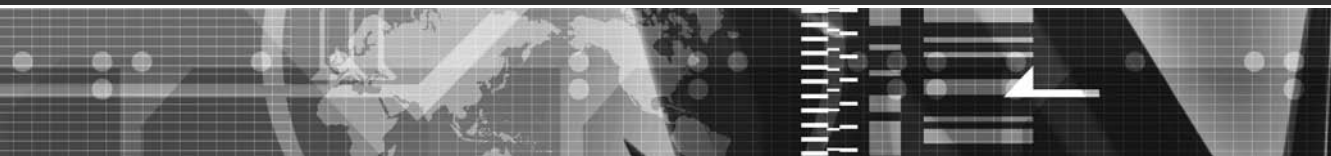

Operating Instructions

- ⚠ Before operating the TV, please read the “Safety Information” section of this manual.
Retain this manual for future reference.

KLV-15SR3U

WEGA

NOTICE FOR CUSTOMERS

A moulded plug complying with BS1363 is fitted to this equipment for your safety and convenience.

Should the fuse in the plug supplied need to be replaced, a 13 AMP fuse approved by ASTA or BSI to BS 1362 (i.e., marked with ⚡ or ⚡) must be used.

When an alternative type of plug is used it should be fitted with a 13 AMP FUSE, otherwise the circuit should be protected by a 13 AMP FUSE at the distribution board.

If the plug supplied with this equipment has a detachable fuse cover, be sure to attach the fuse cover after you change the fuse. Never use the plug without the fuse cover. If you should lose the fuse cover, please contact your nearest Sony service station.

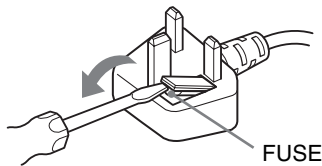

How to replace the fuse

Open the fuse compartment with a blade screwdriver, and replace the fuse.

WARNING

- To prevent the risk of electric shock, do not insert the plug cut off from the mains lead into a socket outlet. This plug cannot be used and should be destroyed.
- To reduce the risk of fire or electric shock, do not expose this apparatus to rain or moisture.
- Dangerously high voltages are present inside the TV set. Do not open the cabinet. Refer servicing to qualified personnel only.

Introduction

Thank you for choosing this Sony product. Before operating the TV, please read this manual thoroughly and retain it for future reference.

Trademark information

- “PlayStation” is a trademark of Sony Computer Entertainment, Inc.

Table of Contents

Safety information	4
Precautions	7
Disposal of the TV set.....	7
Overview of the remote	8
Overview of the TV buttons and indicators.....	9

Getting Started

1: Checking the accessories	10
2: Inserting batteries into the remote.....	10
3: Removing the rear cover.....	11
4: Connecting an aerial/VCR.....	12
5: Attaching the rear cover	13
6: Adjusting the viewing angle of the TV ...	14
7: Switching on the TV	14
8: Selecting the language and country/ region	15
9: Auto-tuning the TV	16

Watching TV

Watching TV.....	17
Viewing pictures from connected equipment	18

Using the Menu

Navigating through menus	19
Overview of the menus.....	19
“Picture Adjustment” menu.....	21
Picture Mode	21
Contrast/Brightness/Colour/Hue/Sharpness/ Backlight.....	21
Reset	21
Noise Reduction	21
Colour Tone	22
“Sound Adjustment” menu	23
Sound Effect	23
Treble/Bass/Balance	23
Reset	23
Dual Sound.....	24
Auto Volume	24

“Features” menu	25
Power Saving	25
TV Speakers	25
RGB Center	25
“Set Up” menu	26
Language	26
Country	26
Auto Tuning	26
Programme Sorting	27
Programme Labels.....	27
AV Preset.....	27
Manual Programme Preset.....	28

Using Optional Equipment

Connecting optional equipment	30
-------------------------------------	----

Additional Information

Specifications	32
Troubleshooting.....	33
Index.....	35

Safety information

Mains lead

- Unplug the mains lead when moving the TV set. Do not move the TV set with the mains lead plugged in. It may damage the mains lead and result in fire or electric shock.
- If you damage the mains lead, it may result in fire or electric shock.
 - Do not pinch, bend, or twist the mains lead excessively. The core conductors may be exposed or broken, causing a short-circuit, which may cause fire or electric shock.
 - Do not modify or damage the mains lead.
 - Do not put anything heavy on the mains lead. Do not pull the mains lead.
 - Keep the mains lead away from heat sources.
 - Be sure to grasp the plug when disconnecting the mains lead.
- If the mains lead is damaged, stop using it and ask your dealer or Sony service centre to exchange it.
- Do not use the supplied mains lead on any other equipment.
- Use only an original Sony mains lead, not other brands.

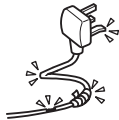
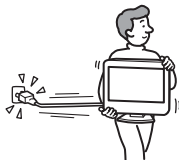

Mains lead/cable protection

Pull out the mains lead/cable by the plug. Do not pull on the mains lead/cable itself.

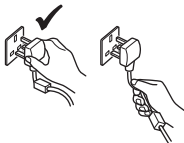

Mains

Do not use a poor fitting mains socket. Insert the plug fully into the mains socket. A poor fit may cause arcing and result in fire. Contact your electrician to have the mains socket changed.

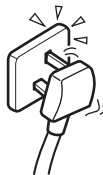

Optional accessories

Observe the following when installing the TV set using a wall-mount bracket. If you do not do so, the TV set may fall and cause serious injury.

- Use the specified wall-mount bracket.
- Secure the TV set properly, following the instructions supplied with your wall-mount bracket when installing the TV set.



Installation

If the TV set is to be installed on a wall, have the installation carried out by qualified service men. Improper installation may render the TV set unsafe.



Medical institutions

Do not place this TV set in a place where medical equipment is in use. It may cause malfunction of medical instruments.



Carrying

- Before carrying the TV set, disconnect all the cables from the TV set.
- When you carry the TV set by hand, hold the TV set as illustrated on the right. If you do not do so, the TV set may fall and be damaged or cause serious injury. If the TV set has been dropped or damaged, have it checked immediately by qualified service personnel.
- When transporting it, do not subject the TV set to jolts or excessive vibration. The TV set may fall and be damaged or cause serious injury.
- When you carry the TV set in for repair or when you move it, pack it using the original carton and packing material.
- Carrying the TV set requires two or more people.



Ventilation

- Never cover the ventilation holes in the cabinet. It may cause overheating and result in fire.
- Unless proper ventilation is provided, the TV set may gather dust and get dirty. For proper ventilation, observe the following:
 - Do not install the TV set turned backwards or sideways.
 - Do not install the TV set turned over or upside down.
 - Do not install the TV set on a shelf or in a closet.
 - Do not place the TV set on a rug or bed.
 - Do not cover the TV set with cloth, such as curtains, or items such as newspapers, etc.
- Leave some space around the TV set and the AC adaptor. Otherwise, air-circulation may be inadequate and cause overheating, which may cause fire or damage to the TV set.

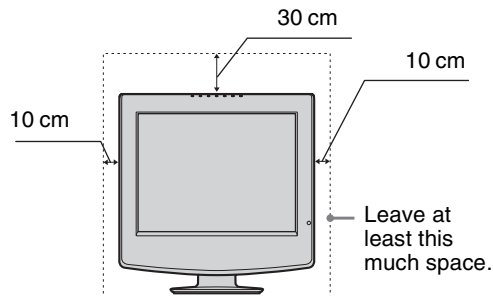

AC adaptor

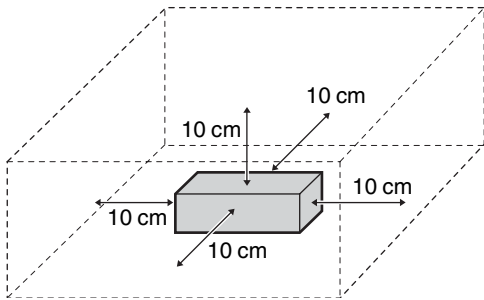

- When installing the TV set on the wall, leave at least 10 cm space from the bottom of the TV set.
- Never install the TV set as follows:

Air circulation is blocked.

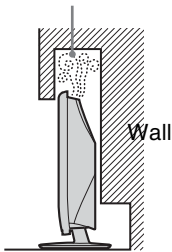

Air circulation is blocked.

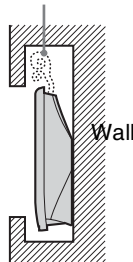

Ventilation holes

Do not insert anything in the ventilation holes. If metal or liquid is inserted in these holes, it may result in fire or electric shock.



Placement

- Never place the TV set in hot, humid or excessively dusty places.
- Do not install the TV set where insects may enter.
- Do not install the TV set where it may be exposed to mechanical vibration.
- Place the TV set on a stable, level surface. Otherwise, the TV set may fall and cause injury.
- Do not install the TV set in a location where it may protrude, such as on or behind a pillar, or where you might bump your head on it. Otherwise, it may result in injury.



Water and moisture

- Do not use this TV set near water – for example, near a bathtub or shower room. Also do not expose to rain, moisture or smoke. This may result in fire or electric shock.



- Do not touch the mains lead and the TV set with wet hands. Doing so may cause electric shock or damage to the TV set.



Moisture and flammable objects

- Do not let this TV set get wet. Never spill liquid of any kind on the TV set. If any liquid or solid object does fall through openings in the cabinet, do not operate the TV set. It may result in electric shock or damage to the TV set. Have it checked immediately by qualified service personnel.
- To prevent fire, keep flammable objects (candles, etc.) and electric bulbs away from the TV set.

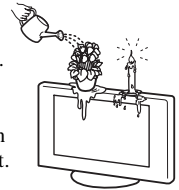

Oils

Do not install this TV set in restaurants that use oil. Dust absorbing oil may enter and damage the TV set.

Fall

Place the TV set on a secure, stable stand. Do not hang anything on the TV set. If you do, the TV set may fall from the stand or wall-mount bracket, causing damage or serious injury. Do not allow children to climb on the TV set.



Vehicle or ceiling

Do not install this TV set in a vehicle. The motion of the vehicle may cause the TV set to fall down and cause injury. Do not hang this TV set from the ceiling.

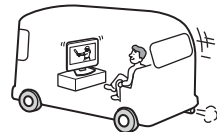

Ships and other vessels

Do not install this TV set on a ship or other vessel. If the TV set is exposed to seawater, it may cause fire or damage the TV set.

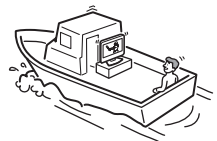

Outdoor use

- Do not expose the TV set to direct sunlight. The TV set may heat up and this may result in damage to the TV set.
- Do not install this TV set outdoors.



Wiring

- Unplug the mains lead when wiring cables. When hooking up, be sure to unplug the mains lead for your safety.
- Take care not to catch your feet on the cables. It may damage the TV set.

Cleaning

- Unplug the mains lead when cleaning the mains plug and this TV set. If you do not, it may result in electric shock.
- Clean the mains plug regularly. If the plug is covered with dust and it picks up moisture, its insulation may deteriorate and result in fire.



Continued

Lightning storms

For your own safety, do not touch any part of the TV set, mains lead, or aerial lead during lightning storms.



Damage requiring service

If the surface of the TV set cracks, do not touch it until you have unplugged the mains lead. Otherwise electric shock may result.

Servicing

Do not open the cabinet. Entrust the TV set to qualified service personnel only.



Small accessories removal and fittable

Keep accessories out of children's reach. If they are swallowed, choking or suffocation may occur. Call a doctor immediately.

Broken glass

Do not throw anything at the TV set. The screen glass may explode by the impact and cause serious injury.



When not in use

For environmental and safety reasons, it is recommended that the TV set is not left in standby when unused. Disconnect from



the mains. However, some TV sets may have features which need the TV set to be left in standby to work correctly. The instructions in this manual will inform you if this applies.

Viewing the TV

- To view the TV comfortably, the recommended viewing position is from four to seven times the screen's vertical length away from the TV set.
- View the TV in moderate light, as viewing the TV in poor light strains your eyes. Watching the screen continuously for long periods of time can also strain your eyes.
- If the angle of the TV set is to be adjusted, steady the base of the stand with your hand to prevent the TV set from becoming separated from the stand. Be careful not to get your fingers caught between the TV set and the stand.

Volume adjustment

- Adjust the volume so as not to trouble your neighbours. Sound carries very easily at night time. Therefore, closing the windows or using headphones is suggested.
- When using headphones, adjust the volume so as to avoid excessive levels, as hearing damage may result.

Overloading

This TV set is designed to operate on a 220–240 V supply only. Take care not to connect too many appliances to the same mains socket as this could result in fire or electric shock.

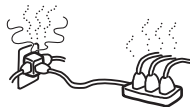

Heat

Do not touch the surface of the TV set. It remains hot, even after the TV set has been turned off for some time.

Corrosion

If you use this TV set near the seashore, salt may corrode metal parts of the TV set and cause internal damage or fire. It may also shorten the life of the TV set. Steps should be taken to reduce the humidity and moderate the temperature of the area where the TV set is located.

Precautions

LCD screen

- Although the LCD screen is made with high-precision technology and 99.99% or more of the pixels are effective, black dots may appear or bright points of light (red, blue, or green) may appear constantly on the LCD screen. This is a structural property of the LCD panel and is not a malfunction.
- Do not expose the LCD screen surface to the sun. Doing so may damage the screen surface.
- Do not push or scratch the front filter, or place objects on top of this TV set. The image may be uneven or the LCD panel may be damaged.
- If this TV set is used in a cold place, a smear may occur in the picture or the picture may become dark. This does not indicate a failure. These phenomena disappear as the temperature rises.
- Ghosting may occur when still pictures are displayed continuously. It may disappear after a few moments.
- The screen and cabinet get warm when this TV set is in use. This is not a malfunction.
- The LCD contains a small amount of liquid crystal and mercury. The fluorescent tube used in this TV set also contains mercury. Follow your local ordinances and regulations for disposal.

Fluorescent lamp

This TV set uses a special fluorescent lamp as its light source. If the screen image becomes dark, flickers, or does not appear, the fluorescent lamp has worn out and should be replaced. For replacement, consult qualified service personnel.

Installing the TV set

- Do not install the TV set in places subject to extreme temperature, for example in direct sunlight, or near a radiator, or heating vent. If the TV set is exposed to extreme temperature, the TV set may overheat and cause deformation of the casing or cause the TV set to malfunction.
- The TV set is not disconnected from the mains when the TV set is switched off. To disconnect the TV set completely, pull the plug from the mains.
- To obtain a clear picture, do not expose the screen to direct illumination or direct sunlight. If possible, use spot lighting directed down from the ceiling.
- Do not install optional components too close to the TV set. Keep optional components at least 30 cm away from the TV set. If a VCR is installed in front of the TV set or beside the TV set, the picture may become distorted.

Handling and cleaning the screen surface/cabinet of the TV set

The screen surface is finished with a special coating to prevent strong light reflections.

To avoid material degradation or screen coating degradation, observe the following precautions.

- Do not push on the screen, scratch it with a hard object, or throw anything at it. The screen may be damaged.
- Do not touch the display panel after operating the TV set continuously for a long period as the display panel becomes hot.
- We recommend that the screen surface be touched as little as possible.
- To remove dust from the screen surface/cabinet, wipe gently with a soft cloth. If dust is persistent, wipe with a soft cloth slightly moistened with a diluted mild detergent solution.
- Never use any type of abrasive pad, alkaline/acid cleaner, scouring powder, or volatile solvent, such as alcohol, benzene, thinner or insecticide. Using such materials or maintaining prolonged contact with rubber or vinyl materials may result in damage to the screen surface and cabinet material.
- The ventilation holes can accumulate dust over time. To ensure proper ventilation, we recommend removing the dust periodically (once a month) using a vacuum cleaner.

Disposal of the TV set



Disposal of Old Electrical & Electronic Equipment (Applicable in the European Union and other European countries with separate collection systems)

This symbol on the product or on its packaging indicates that this product shall not be treated as household waste. Instead it shall be handed over to the applicable collection point for the recycling of electrical and electronic equipment. By ensuring this product is disposed of correctly, you will help prevent potential negative consequences for the environment and human health, which could otherwise be caused by inappropriate waste handling of this product. The recycling of materials will help to conserve natural resources. For more detailed information about recycling of this product, please contact your local city office, your household waste disposal service or the shop where you purchased the product.

Overview of the remote

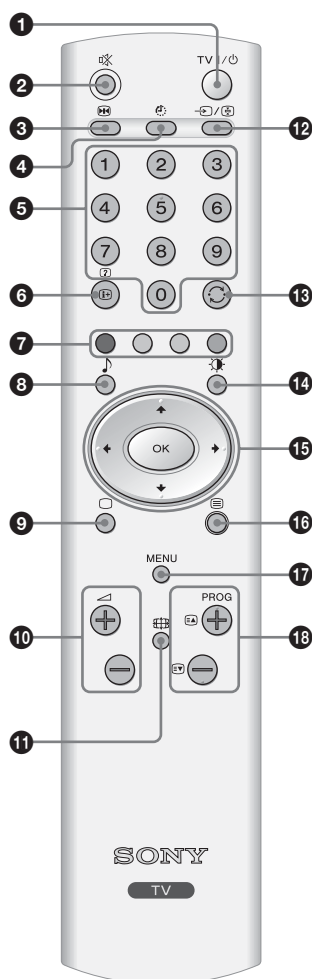



- 1 TV I/⏻: TV standby**
Switches off the TV temporarily, and on from standby mode.
- 2** : **Mute (page 17)**
- 3** : **Screen Memo (page 17)**
- 4** : **Sleep Timer (page 17)**
- 5** **Number buttons**
 - In TV mode: Selects channels. For channel numbers 10 and above, enter the second digit within two seconds.
 - In Text mode: Enters the three digit page number to select the page.
- 6** : **Info/Text reveal**
 - In TV mode: Displays information such as current channel number and screen mode.
 - In Text mode (page 18): Reveals hidden information (e.g., answers to a quiz).
- 7** **Coloured buttons**
In Text mode (page 18): Function as Fastext buttons.
- 8** : **Sound Effect (page 23)**
- 9** : **TV mode (page 18)**
- 10** : **Volume**
- 11** : **Screen mode (page 18)**
- 12** : **Input select/Text hold**
 - In TV mode (page 18): Selects the input source from equipment connected to the TV sockets.
 - In Text mode (page 18): Holds the current page.
- 13** : **Previous channel**
Returns to the previous channel watched (for more than five seconds).
- 14** : **Picture mode**
 - In TV mode (page 21): Selects the picture mode.
 - In Text mode (page 18): Adjusts the brightness of Text page.
- 15** : **Up/Down/Left/Right/OK (page 17, 18, 19)**
- 16** : **Text (page 18)**
- 17** **MENU (page 19)**
- 18** **PROG +/- (page 17)**
 - In TV mode: Selects the next (+) or previous (-) channel.
 - In Text mode: Selects the next (+) or previous (-) page.

Tip

The , PROG+/-, and number 5 buttons have tactile dots. Use the tactile dots as references when operating the TV.

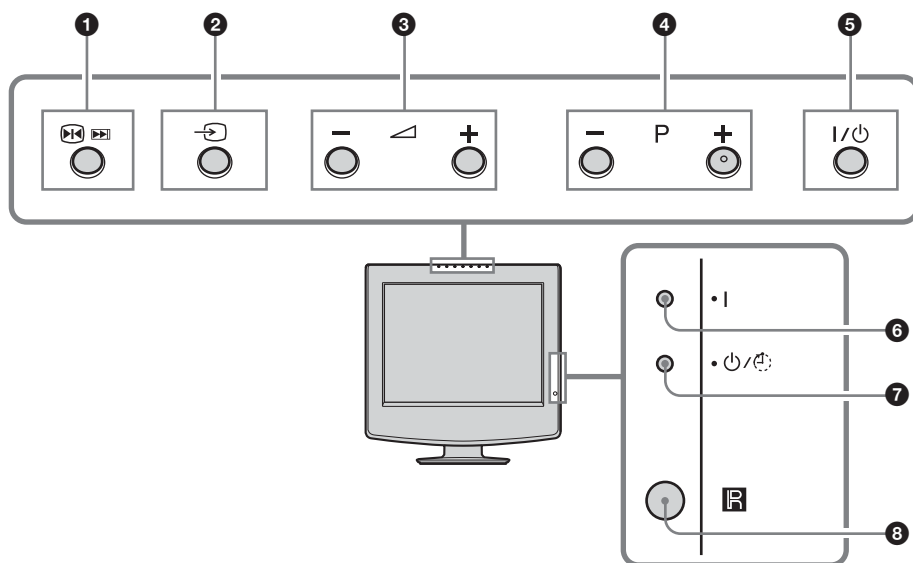
Overview of the TV buttons and indicators



- 1** : **Screen Memo/Auto start up**
 - Freezes the picture (e.g., to make a note of a telephone number or recipe).
 - Starts the Auto Start Up sequence. To start this function, press and hold this button for three seconds.
- 2** : **Input select (page 18)**

Selects the input source from equipment connected to the TV sockets.
- 3** : **Volume**

Increases (+) or decreases (-) the volume.
- 4** **P +/-: Programme**

In TV mode: Selects the next (+) or previous (-) channel.
- 5** : **Power**

Switches the TV on or off.
- 6** **I: Power indicator**

Lights up in green when the TV is switched on.
- 7** : **Standby/Sleep Timer indicator**
 - Lights up in red when the TV is in standby mode.
 - Flashes red when a button is pressed on the remote control.
 - Lights up in red when the sleep timer is set (page 17).
- 8** **Remote control sensor**

1: Checking the accessories

Remote RM-Y1108 (1)

Size AA batteries (R06 type) (2)

Mains lead (Type BF) (1)



AC adaptor (1)

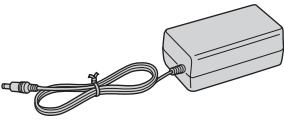

2: Inserting batteries into the remote

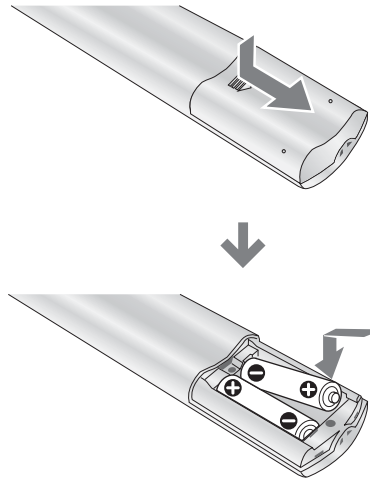

Notes

- Observe the correct polarity when inserting batteries.
- Dispose of batteries in an environmentally friendly way. Certain regions may regulate disposal of the battery. Please consult your local authority.
- Do not use different types of batteries together or mix old and new batteries.
- Handle the remote with care. Do not drop or step on it, or spill liquid of any kind onto it.
- Do not place the remote in a location near a heat source, or in a place subject to direct sunlight, or in a damp room.

3: Removing the rear cover

- 1 Hold the stand of the TV.
- 2 Pull the rear cover down slowly, being careful not to catch your hand.

Tip

The rear cover has tabs on the lower right and left side. The cover can be easily removed by pulling out one side while stabilizing the other side with your other hand.

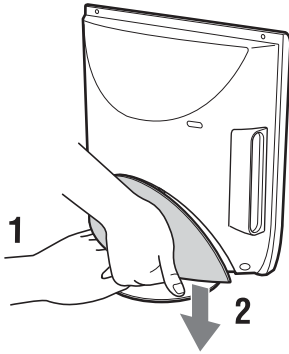
**Note**

Do not carry the TV holding the rear cover.

4: Connecting an aerial/VCR

A

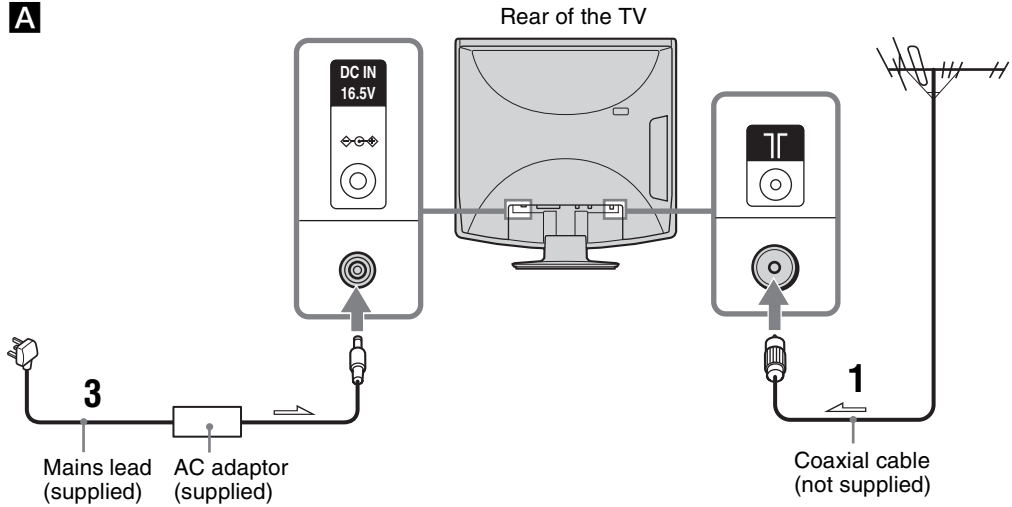

B

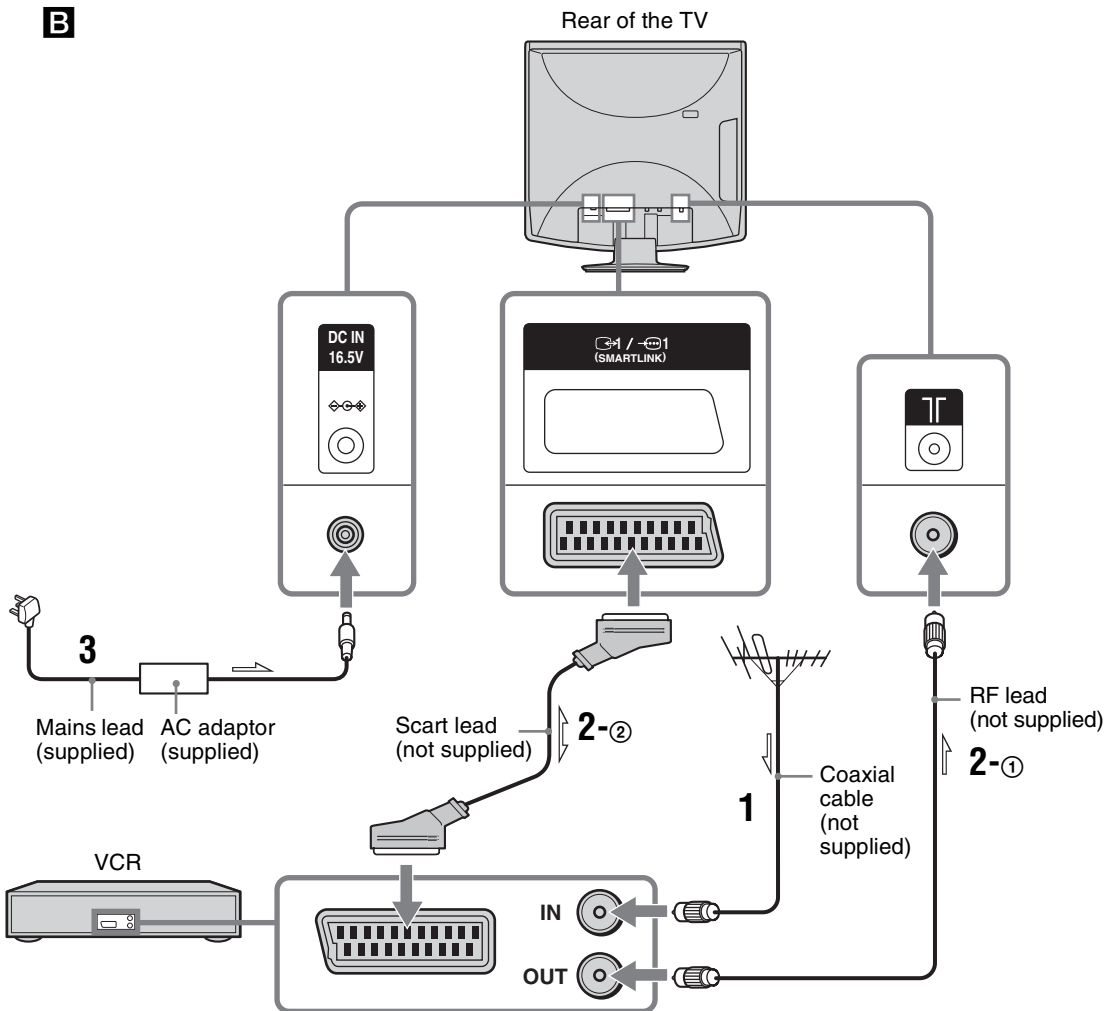

1 Connect your aerial with the coaxial cable.

If connecting to an aerial only (A)

Connect your aerial to the  socket on the rear of the TV, then go to step 3.

If connecting to a VCR with an aerial (B)

Connect your aerial to the input socket on your VCR.

2 Connect your VCR.

① Connect the output socket on your VCR to the  socket on the rear of the TV with the RF lead.

② Connect the Scart socket on your VCR to the  Scart socket on the rear of the TV with a Scart lead.

3 Connect the mains lead to the AC adaptor.

4 Connect the AC adaptor to the DC IN socket on the rear of the TV.

Note

Do not connect the mains lead to your mains socket until all connections are complete.

5: Attaching the rear cover

1 Insert the two tabs of the upper side of the rear cover into the slots of the TV cabinet.

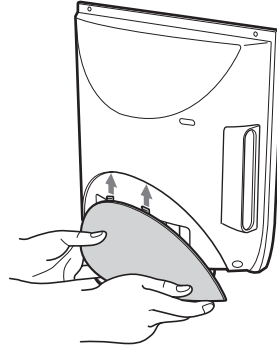

2 Push the two tabs of the lower side of the rear cover into the slots of the TV cabinet.

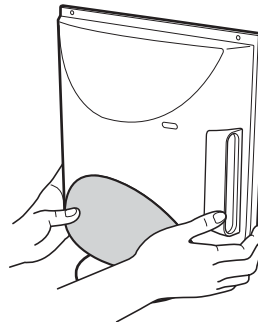

6: Adjusting the viewing angle of the TV

Tilt

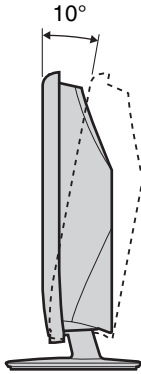

Swivel

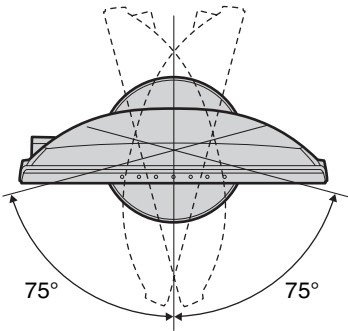

Note

When adjusting the angle, hold the stand with one hand to prevent the stand from slipping or tipping.



7: Switching on the TV

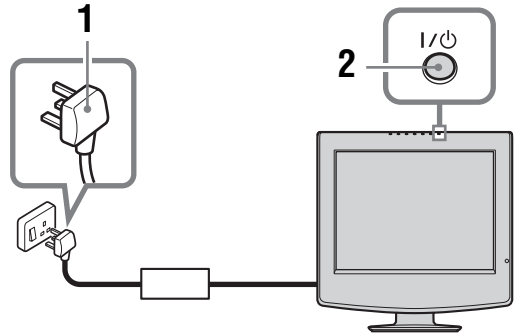

1 Connect the TV to your mains socket (220–240 V, 50/60 Hz).

2 Press **I/⏻** on the TV.

When you switch on the TV for the first time, the “Language” menu appears on the screen, then go to “8: Selecting the language and country/region” on page 15.

When the TV is in standby mode (the **⏻/⏸** (standby/sleep timer) indicator on the front of the TV flashes red), press TV **I/⏻** on the remote to switch on the TV.

8: Selecting the language and country/region

When you switch on the TV for the first time, the “Language” menu appears on the screen.

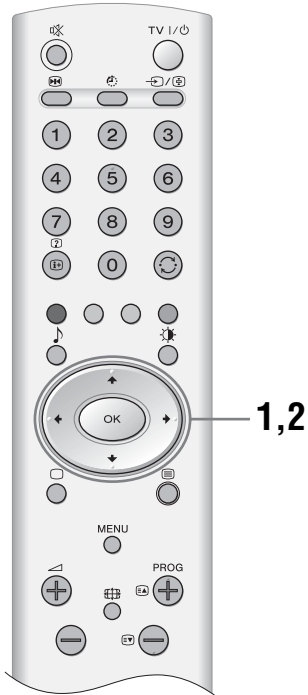

- 1 Press **↑/↓** to select the language displayed on the menu screens, then press **OK**.



- 2 Press **↑/↓** to select the country/region in which you will operate the TV, then press **OK**.



If the country/region in which you want to use the TV does not appear in the list, select “—” instead of a country/region.

The message confirming the TV start auto-tuning appears on the screen, then go to “9: Auto-tuning the TV” on page 16.

9: Auto-tuning the TV

After selecting the language and country/region, a message confirming the TV start auto-tuning appears on the screen.

You must tune the TV to receive channels (TV broadcasts). Do the following to search and store all available channels.

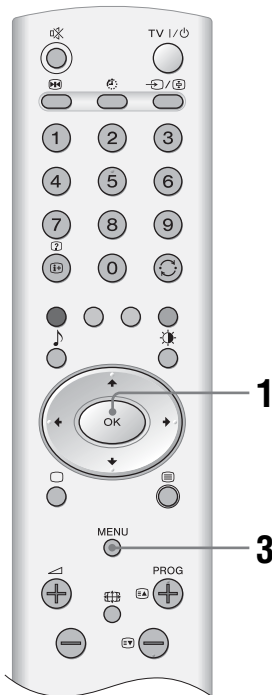

1 Press OK to select “Yes”.

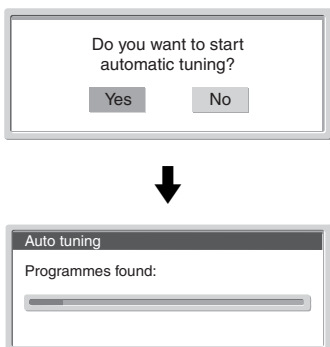

The TV starts searching for all available channels. This may take some time, please be patient and do not press any buttons on the TV or remote. Once all available channels have been stored, the TV returns to normal operation, displaying the channel stored on channel number 1.

When a message appears for you to confirm the aerial connections

No channels are found. Check all the aerial connections and press OK to start auto-tuning again.

2 When the “Programme Sorting” menu appears on the screen, follow step 2 to 3 of “Programme Sorting” (page 27).

If you want to keep the channels in their tuned order, go to step 3.

3 Press MENU to exit.

The TV has now tuned in all the available channels.

Watching TV

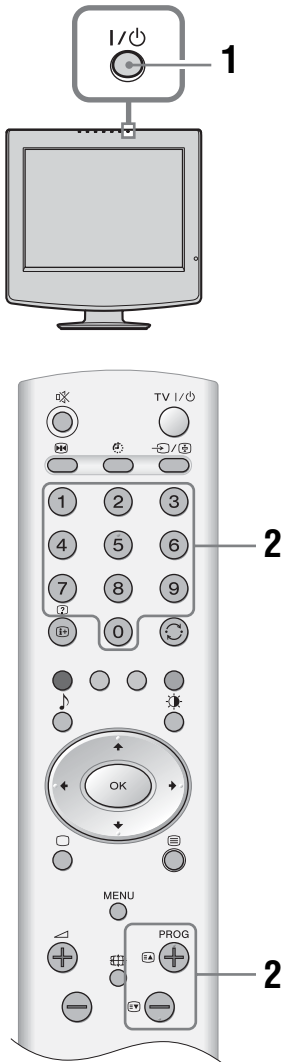

- 1** Press **I/⏻** on the TV to switch on the TV.
When the TV is in standby mode (the **⏻/⏸** (standby/sleep timer) indicator on the front of the TV flashes red), press TV **I/⏻** on the remote to switch on the TV.
- 2** Press the number buttons or PROG +/- to select a TV channel.
To select channel numbers 10 and above using the number buttons, enter the second digit within 2.5 seconds.

Additional operations

To	Do this
Turn off the TV temporarily (Standby mode)	Press TV I/⏻ .
Turn off the TV completely	Press I/⏻ on the top of the TV.
Adjust the volume	Press ⏮ + (increase) / - (decrease).
Mute the sound	Press ⏸ . Press again to restore.
Return to the previous channel watched (for more than five seconds)	Press ⏮ .
Access the Programme index table	Press OK. To select a channel, press ⏮/⏭ , then press OK. To access the Input signal index table, see page 18.
Switch the TV automatically to the standby mode after a specified time period – Sleep	Press ⏸ repeatedly to set the desired time (30, 60, 90 or 120 minutes).
Temporarily freeze and review the picture on the screen	Press ⏮ . Press again to cancel.

Continued



To access Text

Press .

Each time you press , the display changes cyclically as follows:

Text mode → Text Superimpose mode → TV mode → Text mode → (repeat)

To select a page, press the number buttons or PROG +/-.

To hold a page, press /.

To reveal hidden information, press /?.

To change brightness of Text, press  repeatedly to choose between four different options.

To switch off Text, press .

Tips

- Ensure that the TV is receiving a good signal, or some text errors may occur.
- Most TV channels broadcast a Text service. For information on the use of the service, select the index page (usually page 100).
- When four coloured items appear at the bottom of the Text page, Fastext is available. Fastext allows you to access pages quickly and easily. Press the corresponding coloured button to access the page.

To change the wide screen mode

Press  to change to 16:9 (wide screen mode).

To return to 4:3, press  again.

4:3

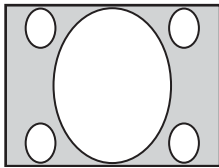

16:9 aspect ratio (widescreen pictures) are displayed stretched in the vertical direction.



16:9

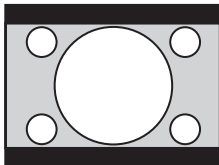

16:9 aspect ratio (widescreen pictures) are in correct proportion.

Viewing pictures from connected equipment

Switch on the connected equipment, then perform one of the following operation.

For equipment connected to the Scart socket using a fully-wired 21-pin Scart lead



Start playback on the connected equipment.



The picture from the connected equipment appears on the screen.



For an auto-tuned VCR (page 12)



Press PROG +/-, or the number buttons, to select the video channel.







For other connected equipment

Press / repeatedly until the correct input symbol (see below) appears on the screen.





 1/ 1:

Audio/video or RGB input signal through the Scart socket  1/ 1.  1 appears only if an RGB source has been connected.

 2/S 2:

Video input signal through the video socket  2, and audio input signal through the audio socket L/G/S/I (MONO), R/D/D/D sockets  2. S 2 appears only if the equipment is connected to the S video socket S 2 instead of the video socket  2, and S video input signal is input through the S video socket S 2.

Additional operations

To	Do this
Return to the normal TV operation	Press  .
Access the Input signal index table	Press OK, then press  . To select an input source, press   , then press OK.

Navigating through menus

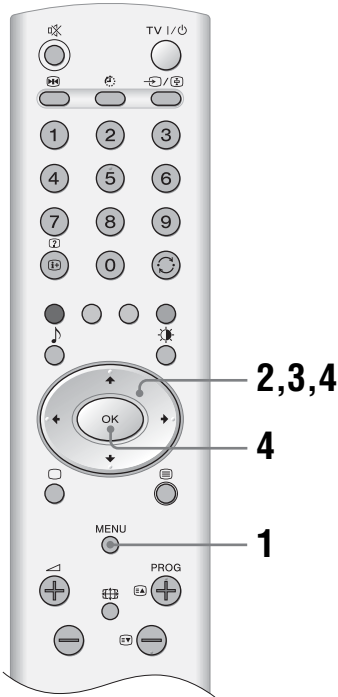

- 1** Press MENU to display the menu.
- 2** Press **↑/↓** to select a menu icon.
- 3** Press **↑/↓/←/→** to select an option.
- 4** Press **↑/↓/←/→** to change/set the setting, then press OK.

To exit the menu, press MENU.

To return to the last display, press **←**.

Overview of the menus

The following options are available in each menu. For details on navigating through menus, see page 19. Also, see page in parentheses for details of each menu.

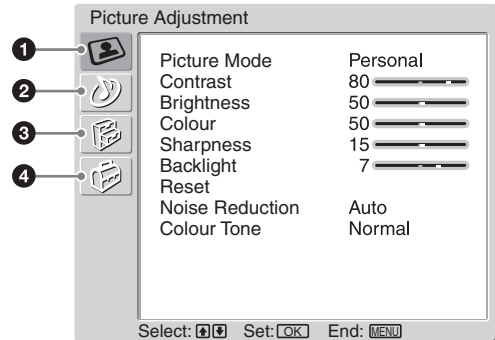

- 1** **Picture Adjustment**
 - Picture Mode (21)
 - Contrast/Brightness/Colour/Hue/Sharpness/Backlight (21)
 - Reset (21)
 - Noise Reduction (21)
 - Colour Tone (22)
- 2** **Sound Adjustment**
 - Sound Effect (23)
 - Treble/Bass/Balance (23)
 - Reset (23)
 - Dual Sound (24)
 - Auto Volume (24)
- 3** **Features**
 - Power Saving (25)
 - TV Speakers (25)
 - RGB Center (25)

4 Set Up

- Language (26)
- Country (26)
- Auto Tuning (26)
- Programme Sorting (27)
- Programme Labels (27)
- AV Preset (27)
 - Label/Sound Offset
- Manual Programme Preset (28)
 - Programme/System/Channel/Label/AFT/
Audio Filter/Skip/Decoder

Note

The options you can adjust vary depending on the situation.
Only the options that can be operated are displayed.

“Picture Adjustment” menu

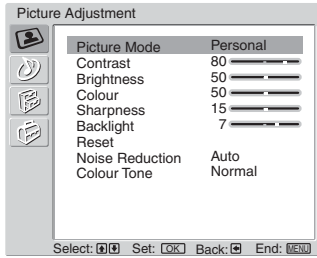

You can select the options listed below on the “Picture Adjustment” menu. To select options, see “Navigating through menus” (page 19).

Tip

When you set the “Picture Mode” option to “Live” or “Movie”, you can adjust only “Picture Mode”, “Contrast”, and “Reset”.

Picture Mode

Selects the picture mode.

- 1 Press OK to select “Picture Mode”.
- 2 Press **↑/↓** to select one of the following picture modes, then press OK.

Live: For watching live broadcasts.

Movie: For watching movies.

Personal: Allows you to store your own preferred settings.

Tip

You can also change the picture mode by pressing **⏮** repeatedly.

Contrast/Brightness/Colour/Hue/Sharpness/Backlight

- 1 Press OK to select the option.
- 2 Press **←/→** to set the level, then press OK.

Tip

“Hue” can only be adjusted for an NTSC colour signal (e.g., U.S.A. video tapes).

Reset

Resets all the picture settings to the factory settings.

- 1 Press OK to select “Reset”.
- 2 Press **↑/↓** to select “OK”, then press OK.

Noise Reduction

Reduces the picture noise (snowy picture) in a weak broadcast signal.

- 1 Press OK to select “Noise Reduction”.
- 2 Press **↑/↓** to select one of the following, then press OK.

Auto: Automatically reduces the picture noise.

Off: Modifies the effect of the noise reduction.

Colour Tone

- 1 Press OK to select “Colour Tone”.
- 2 Press **↑/↓** to select one of the following, then press OK.
 - Warm: Gives the white colours a red tint.
 - Normal: Gives the white colours a neutral tint.
 - Cool: Gives the white colours a blue tint.

“Sound Adjustment” menu

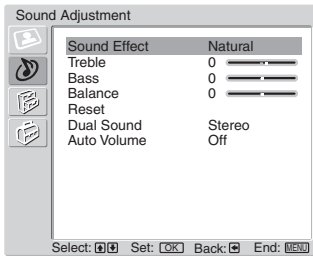

You can select the options listed below on the “Sound Adjustment” menu. To select options, see “Navigating through menus” (page 19).

Sound Effect

- 1 Press OK to select “Sound Effect”.
- 2 Press **↑/↓** to select one of the following sound effects, then press OK.
Natural: Enhances clarity, detail, and sound presence by using “BBE High Definition Sound System”^{*1}.
Dynamic: Intensifies clarity and sound presence for better intelligibility and musical realism by using the “BBE High Definition Sound System”.
Off: Flat response.

Tip

You can also change sound effect by pressing **♪** repeatedly.

^{*1} Licensed by BBE Sound, Inc. under USP4638258, 4482866. “BBE” and BBE symbol are trademarks of BBE Sound, Inc.

Treble/Bass/Balance

Adjusts higher-pitched sounds (“Treble”), adjusts lower-pitched sounds (“Bass”), and emphasizes left or right speaker balance (“Balance”).

- 1 Press OK to select the option.
- 2 Press **←/→** to set the level, then press OK.

Reset

Resets the “Treble”, “Bass” and “Balance” settings to the factory settings.

- 1 Press OK to select “Reset”.
- 2 Press **↑/↓** to select “OK”, then press OK.

Dual Sound

Selects the sound from the speaker for a stereo or bilingual broadcast.

1 Press OK to select “Dual Sound”.

2 Press **↑/↓** to select one of the following, then press OK.

Stereo, Mono: For a stereo broadcast.

A/B/Mono: For a bilingual broadcast, select “A” for sound channel 1, “B” for sound channel 2, or “Mono” for a mono channel, if available.

Tip

If you select other equipment connected to the TV, set “Dual Sound” to “Stereo”, “A” or “B”.

Auto Volume

Keeps a constant volume level even when volume level gaps occur (e.g., adverts tend to be louder than programmes).

1 Press OK to select “Auto Volume”.

2 Press **↑/↓** to select “On”, then press OK.

“Features” menu

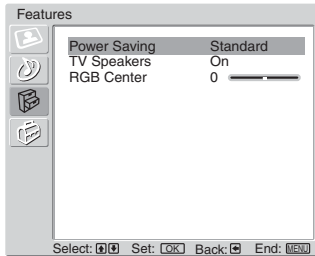

You can select the options listed below on the “Features” menu. To select options, see “Navigating through menus” (page 19).

Power Saving

Reduces the power consumption of the TV.

- 1 Press OK to select “Power Saving”.
- 2 Press **↑/↓** to select “Reduce”, then press OK.

TV Speakers

Switches on/off the TV’s internal speakers.

- 1 Press OK to select “TV Speakers”.
- 2 Press **↑/↓** to select “On” or “Off”, then press OK.

On: The sound of the TV is output through the TV’s speakers.

One Time Off: The TV speakers are temporarily turned off allowing you listen to the sound from external audio equipment. The “TV Speakers” option automatically returns to “On” when the TV is switched off.

Permanent Off: The TV speakers are permanently turned off allowing you to always listen to the sound from external audio equipment.

RGB Center

Adjusts the horizontal picture position so that the picture is in the middle of screen. This option is only available if an RGB source has been connected to the Scart socket **↔ 1/→ 1**.

- 1 Press OK to select “RGB Center”.
- 2 Press **←/→** to adjust the centre of the picture between –5 and +5, then press OK.

“Set Up” menu

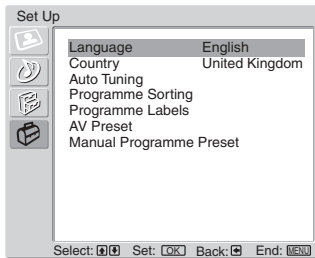

You can select the options listed below on the “Set Up” menu. To select options, see “Navigating through menus” (page 19).

Language

Selects the language in which the menus are displayed.

- 1 Press OK to select “Language”.
- 2 Press **↑/↓** to select the language, then press OK.
All menus will appear in the selected language.

Country

Selects the country/region where you operate the TV.

- 1 Press OK to select “Country”.
- 2 Press **↑/↓** to select the country/region in which you will operate the TV, then press OK.
If the country/region in which you want to use the TV does not appear in the list, select “-” instead of a country/region.

Auto Tuning

Tunes in all the available channels.

Usually you do not need to do this operation because the channels are already tuned when the TV was first installed (page 16). However, this option allows you to repeat the process (e.g., to retune the TV after moving house, or to search for new channels that have been launched by broadcasters).

- 1 Press OK to select “Auto Tuning”.
- 2 Follow step 1 of “9: Auto-tuning the TV” (page 16).
When all available channels have been tuned, the TV returns to normal operation.

Programme Sorting

Changes the order in which the channels are stored on the TV.

- 1 Press OK to select “Programme Sorting”.
- 2 Press **↑/↓** to select the channel you want to move to a new position, then press OK.
- 3 Press **↑/↓** to select the new position for your channel, then press OK.
Repeat the procedure in steps 2 and 3 to move other channels if required.

Programme Labels

Assigns a channel name of your choice up to five letters or numbers. The name will be displayed briefly on the screen when the channel is selected. (Names for channels are usually taken automatically from Text (if available).)

- 1 Press OK to select “Programme Labels”.
- 2 Press **↑/↓** to select the channel you want to name, then press OK.
- 3 Press **↑/↓/←/→** to select the desired letter or number (“□” for a blank space), then press OK.
If you input a wrong character
Press **↑/↓/←/→** to select **⊠/⊡** and press OK repeatedly until the wrong character is selected. Then, press **↑/↓/←/→** to select the correct character and press OK.
- 4 Repeat the procedure in step 3 until the name is complete.
- 5 Press **↑/↓/←/→** to select “End”, then press OK.

AV Preset

Do the following options.

- 1 Press OK to select “AV Preset”.
- 2 Press **↑/↓** to select the desired input source, then press OK.
- 3 Press **↑/↓** to select the desired option below, then press OK.

Option	Description
Label	Assigns a name to any equipment connected to the side or rear sockets. The name will be displayed briefly on the screen when the equipment is selected. Press ↑/↓ to select one of the following, then press OK. VIDEO/DVD/CABLE/GAME/CAM/SAT: Uses one of these preset labels. Edit: Creates your own label. Follow steps 3 to 5 of “Programme Labels” (page 27).



Option	Description
Sound Offset	Changes the input sound level of the equipment connected to the TV. Press ↑/↓ to adjust the input sound level between -9 and +9, then press OK.

Manual Programme Preset

Before selecting “Label”/“AFT”/“Audio Filter”/“Skip”/“Decoder”, press PROG +/- to select the programme number with the channel. You cannot select a programme number that is set to skip (page 29).

- 1** Press OK to select “Manual Programme Preset”.
- 2** Press **↑/↓** to select one of the following options, then press OK.

Option	Description
Programme	Presets programme channels manually.
System	1 Press ↑/↓ to select “Programme”, then press OK.
Channel	<p>2 Press ↑/↓ to select the programme number you want to manually tune (if tuning a VCR, select channel 0), then press ←.</p> <p>3 Press ↑/↓ to select “System”, then press OK.</p> <p>Note Depending on the country/region selected for “Country” (page 26), this option may not be available.</p> <p>4 Press ↑/↓ to select one of the following TV broadcast systems, then press ←. B/G: For western European countries/regions D/K: For eastern European countries/regions I: For the United Kingdom L: For France</p> <p>5 Press ↑/↓ to select “Channel”, then press OK.</p> <p>6 Press ↑/↓ to select “S” (for cable channels) or “C” (for terrestrial channels), then press →.</p> <p>7 Tune the channels as follows: If you do not know the channel number (frequency) Press ↑/↓ to search for the next available channel. When a channel has been found, the search will stop. To continue searching, press ↑/↓. If you know the channel number (frequency) Press the number buttons to enter the channel number of the broadcast you want or your VCR channel number.</p> <p>8 Press OK twice to store. Repeat the procedure above to preset other channels manually.</p>
Label	<p>Assigns a name of your choice, up to five letters or numbers, to the selected channel. This name will be displayed briefly on the screen when the channel is selected.</p> <p>1 Follow steps 3 to 5 of “Programme Labels” (page 27).</p> <p>2 Press OK.</p>

Option	Description
AFT	<p>Fine-tunes the selected programme number manually if you feel that a slight tuning adjustment will improve the picture quality. (Normally, fine tuning is performed automatically.)</p> <ol style="list-style-type: none"> 1 After selecting "AFT", press ➡. 2 Press ⬆/⬇ to adjust the fine tuning from -15 to +15, then press OK twice.
Audio Filter	<p>Improves the sound for individual channels in the case of distortion in mono broadcasts. Sometimes a non-standard broadcast signal can cause sound distortion or intermittent sound muting when watching mono programmes.</p> <ol style="list-style-type: none"> 1 After selecting "Audio Filter", press ➡. 2 Press ⬆/⬇ to select "Low" or "High", then press OK. If you do not experience any sound distortion, we recommend that you leave this option set to the factory setting "Off". <p>Note You cannot receive stereo or dual sound when "Low" or "High" is selected.</p>
Skip	<p>Skips unused channels when you press PROG +/- to select channels. (You can still select a skipped channel using the number buttons.)</p> <ol style="list-style-type: none"> 1 After selecting "Skip", press ➡. 2 Press ⬆/⬇ to select "On", then press OK. To restore a skipped channel, select "Off" in step 2.
Decoder	<p>Views and records the scrambled channel selected when using a decoder connected to the Scart socket  1/➡  1 either directly or via a VCR.</p> <p>Note Depending on the country/region selected for "Country" (page 26), this option may not be available.</p> <ol style="list-style-type: none"> 1 After selecting "Decoder", press ➡. 2 Press ⬆/⬇ to select "On", then press OK. To cancel this function at a later time, select "Off" in step 2.

Connecting optional equipment





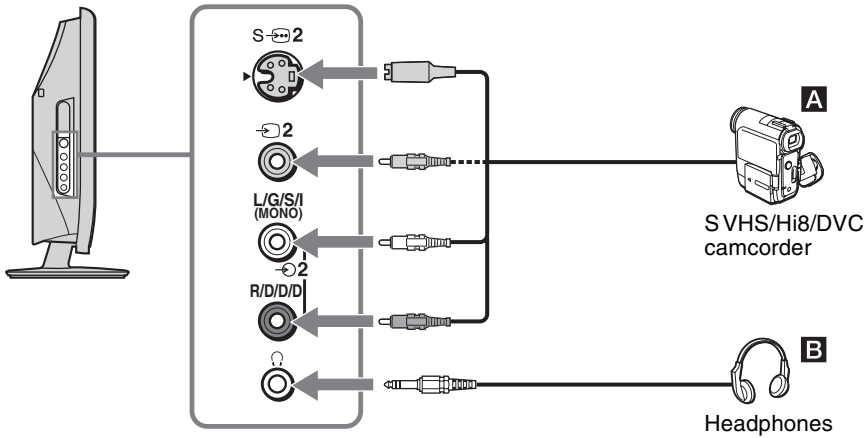

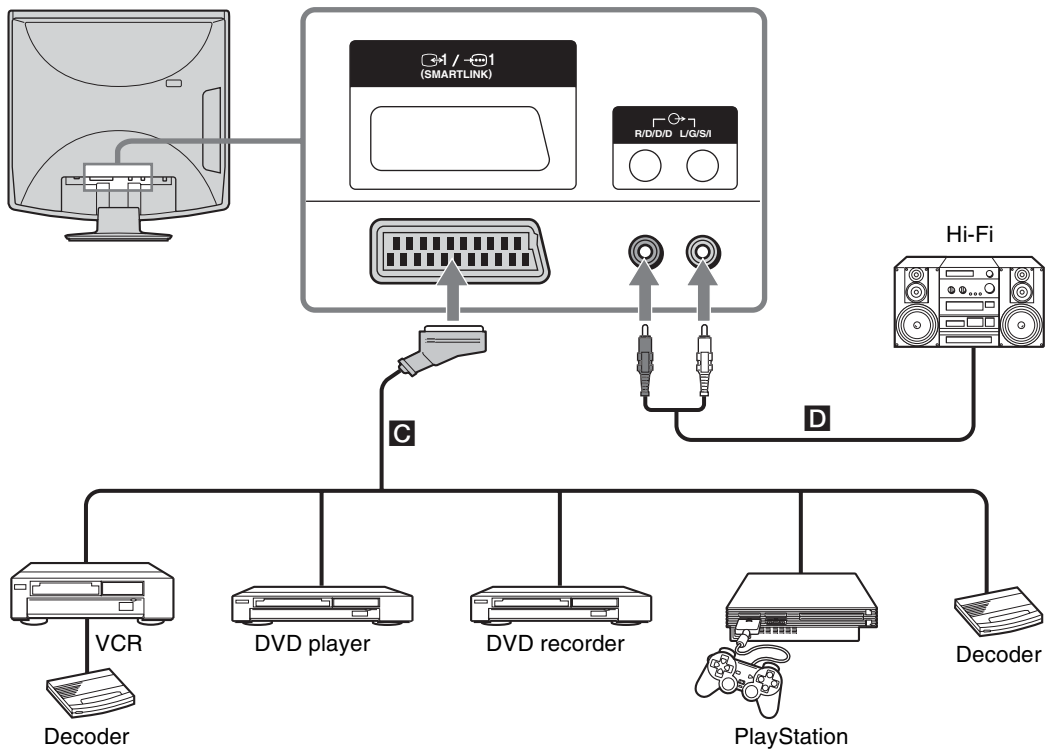

You can connect a wide range of optional equipment to your TV. Connecting cables are not supplied.

Connecting to the side of the TV (side)



Connecting to the rear of the TV



To connect	Do this
S VHS/Hi8/DVC camcorder A	Connect to the S video socket S-  2 or the video socket  2, and the audio sockets  2. To avoid picture noise, do not connect external equipment to the video socket  2 and the S video socket S-  2 at the same time.
Headphones B	Connect to the  socket to listen to sound from the TV on headphones.
“PlayStation”, DVD player, decoder, DVD recorder or VCR that supports SmartLink C	Connect to the Scart socket  1/  1. SmartLink is a direct link between the TV and a VCR/DVD recorder. For more information on SmartLink, refer to the instruction manual supplied with your VCR or DVD recorder.
Hi-Fi audio equipment D	Connect to the audio output sockets  to listen to the sound from the TV on Hi-Fi audio equipment. To turn off the sound of the TV speakers, set “TV Speakers” to “Permanent Off” (page 25).

Specifications

Display Unit

Power Requirements:

220–240 V, 50/60 Hz

Screen Size:

15 inches

Approx. 38.0 cm measured diagonally

Display Resolution:

640 dots (horizontal) × 480 lines (vertical)

Power Consumption:

50 W

Standby Power Consumption:

1 W or less

Dimensions (w × h × d):

Approx. 380 × 397 × 179 mm (with stand)

Approx. 380 × 361 × 92 mm (without stand)

Mass:

Approx. 4.2 kg (with stand)

Approx. 3.6 kg (without stand)

Panel System

LCD (Liquid Crystal Display) Panel

TV System

Depending on your country/region selection:

B/G/H, D/K, L, I

Colour System

PAL, SECAM

NTSC 3.58, 4.43 (only Video In)

Aerial

75 ohm external terminal for VHF/UHF

Channel Coverage

VHF: E2–E12

UHF: E21–E69

CATV: S1–S20



HYPERS: S21–S41

D/K: R1–R12, R21–R69

L: F2–F10, B–Q, F21–F69

I: UHF B21–B69

Terminals

 1 /  1 (SMARTLINK)

21-pin Scart socket (CENELEC standard) including audio/video input, RGB input, and TV audio/video output.

 2 S video input (4-pin mini DIN)

 2 Video input (phono jack)

 2 Audio input (phono jacks)

 Audio output (left/right) (phono jacks)

 Headphones jack

Sound Output

2 W + 2 W

Supplied Accessories

- Remote RM-Y1108 (1)
- Size AA batteries (R06 type) (2)
- Mains lead (Type BF) (1)
- AC adaptor (1)

Optional Accessory

- Wall-Mount Bracket SU-W110

Design and specifications are subject to change without notice.

Troubleshooting

Picture

Problem	Cause/Remedy
No picture (screen is dark) and no sound	<ul style="list-style-type: none"> • Check the aerial connection. • Connect the TV to the mains, and press I/⏻ on the TV. • If the ⏻/⏸ (standby/sleep timer) indicator lights up in red, press TV I/⏻.
No picture or no menu information from equipment connected to the Scart socket	<ul style="list-style-type: none"> • Check that the optional equipment is on and press →/⏸ repeatedly until the correct input symbol is displayed on the screen. • Check the connection between the optional equipment and the TV.
Distorted picture	<ul style="list-style-type: none"> • Check if any connected optional equipment is installed in front of the TV or beside the TV. When installing optional equipment, leave some space between the optional equipment and the TV. • When changing programmes or selecting Text, turn off any equipment connected to the Scart socket on the rear of the TV.
Double images or ghosting	<ul style="list-style-type: none"> • Check aerial/cable connections. • Check the aerial location and direction.
Only snow and noise appear on the screen	<ul style="list-style-type: none"> • Check if the aerial is broken or bent. • Check if the aerial has reached the end of its serviceable life (three to five years in normal use, one to two years at the seaside).
Picture (dotted lines or stripes) noise	<ul style="list-style-type: none"> • Keep the TV away from electrical noise sources such as cars, motorcycles, or hair-dryers. • Make sure that the aerial is connected using the coaxial cable. • Keep the aerial cable away from other connecting cables. • Do not use a 300-ohm twin lead cable as interference may occur.
Picture noise when viewing a TV channel	<ul style="list-style-type: none"> • Select “Manual Programme Preset” in the “Set Up” menu and adjust “AFT” (Automatic Fine Tuning) to obtain better picture reception (page 29). • Select “Noise Reduction” in the “Picture Adjustment” menu to reduce the noise in the picture (page 21).
Stripe noise during playback/recording of a VCR	<ul style="list-style-type: none"> • Video head interference. Keep your VCR away from the TV. • Leave a space of 30 cm between your VCR and the TV to avoid noise. • Avoid installing your VCR in front of the TV or beside the TV.
Some tiny black points and/or bright points on the screen	<ul style="list-style-type: none"> • The picture of a display unit is composed of pixels. Tiny black points and/or bright points (pixels) on the screen do not indicate a malfunction.
No colour on programmes	<ul style="list-style-type: none"> • Select “Reset” in the “Picture Adjustment” menu to return to the factory settings (page 21). • If you set the “Power Saving” function to “Reduce”, picture colours may become dimmer (page 25).

Sound

Problem	Cause/Remedy
No sound, but good picture	<ul style="list-style-type: none">• Press \triangle +/- or M (Mute).• Check that “TV Speakers” is set to “On” in the “Features” menu (page 25).
Noisy sound	<ul style="list-style-type: none">• See the Picture noise causes/remedies on page 33.• Communication problems may occur if the infrared communication equipment (e.g., infrared cordless headphones) is used near the TV. Do not use infrared cordless headphones, or move the infrared transmitter away from the TV until the noise is eliminated, or move the transmitter and receiver of the infrared communication equipment closer together.• Check that “Audio Filter” is set to “Low” or “High” in the “Manual Programme Preset” option (page 29).
Unable to receive a stereo or dual sound broadcast	<ul style="list-style-type: none">• Check that “Audio Filter” is set to “Off” in the “Manual Programme Preset” option (page 29).

General

Problem	Cause/Remedy
The TV turns off automatically (the TV enters standby mode)	<ul style="list-style-type: none">• Check if the Sleep Timer function is activated (page 17).
The remote does not function	<ul style="list-style-type: none">• Replace the batteries.
Wrong characters appear when viewing the menu/Text	<ul style="list-style-type: none">• Select “Language” and “Country” in the “Set Up” menu and set the language and country/region in which Text is provided (page 26). For Cyrillic languages, we recommended that you select Russia if your own country/region does not appear in the list.
Cannot operate the menu	<ul style="list-style-type: none">• If the item you want to select appears in a pale colour, you cannot select it.

Index

Numerics

0-9 buttons 8

4:3 18

A

Accessories 10

Aerial, connecting 12

AFT 29

Audio Filter 29

Auto Tuning 16, 26

Auto Volume 24

AV Preset 27

B

Backlight 21

Balance 23

Bass 23

Batteries, inserting into the remote 10

BBE 23

Brightness 21

C

Channels

auto-tuning 16

selecting 17

Skip 29

Colour 21

Colour Tone 22

Coloured buttons 8

Connecting

an aerial/VCR 12

optional equipment 30

Contrast 21

Country 26

D

Decoder 29

Dual Sound 24

F

Fasttext 18

Features menu 25

H

Headphones

connecting 31

Hue 21

I

Info (ⓘ) button 8

Input select (↔) button 8, 9

Input signal index table 18

L

Label 27, 28

Language 26

M

Manual Programme Preset 28

MENU button 8

Mute (ⓧ) button 8

N

Noise Reduction 21

Number buttons 8

O

OK button 8

P

P +/- buttons 9

Picture Adjustment menu 21

Picture Mode 21

Picture mode (🖼️) button 8

Power (⏻) indicator 9

Power (⏻) switch 9

Power Saving 25

Previous channel (⏪) button 8

PROG +/- buttons 8

Programme index table 17

Programme Labels 27

Programme Sorting 27

R

Remote

control sensor 9

inserting batteries 10

overview 8

Reset

picture adjustment 21

sound adjustment 23

RGB Center 25

S

Screen Memo (📄) button 8

Screen mode 18

Screen mode (📄) button 8

Set Up menu 26

Sharpness 21

Skip 29

Sleep Timer (🕒) button 8

Sound Adjustment menu 23

Sound Effect 23

Sound Effect (🎵) button 8

Sound Offset 28

Speaker 25

Specifications 32

Standby/Sleep Timer (🕒) indicator 9

T

Text 18

Text hold (🔒) button 8

Text reveal (🔍) button 8

Treble 23

TV mode (📺) button 8

TV standby (TV ⏻) button 8

V

VCR

connecting 12

Volume (🔊) +/- buttons 8, 9

<http://www.sony.net/>

KLV-15SR3U

Printed in Taiwan