

SONY®

2-672-379-13(1)

# Camera Operating Guide

Read this first

Digital Video Camera Recorder  
**HANDYCAM®**  
**DCR-SR90E/SR100E**

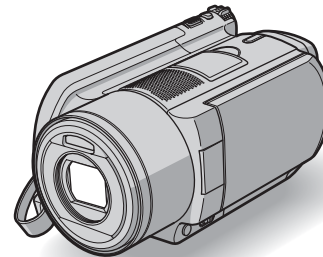

 Enjoying with your Hard Disk Drive Handycam 10

Getting Started 13

 Easy Handycam 22

 Recording /Playback 28

Using the Setup items 46

Editing images 65

Dubbing, Printing 69

Troubleshooting 76

Additional Information 90

Glossary, Index 99

Additional information on this product and answers to frequently asked questions can be found at our Customer Support Website.

<http://www.sony.net/>

 Printed on 100% recycled paper using VOC (Volatile Organic Compound)-free vegetable oil based ink.

Printed in Japan



© 2006 Sony Corporation

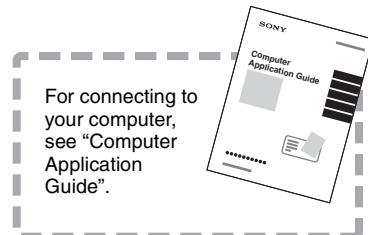

# Read this first

Before operating the unit, please read this manual thoroughly, and retain it for future reference.

## WARNING

To reduce fire or shock hazard, do not expose the unit to rain or moisture.

## CAUTION

Replace the battery with the specified type only. Otherwise, fire or injury may result.

## FOR CUSTOMERS IN THE UNITED KINGDOM

### NOTICE ON THE SUPPLIED AC ADAPTOR

A moulded plug complying with BS1363 is fitted to this equipment for your safety and convenience.

Should the fuse in the plug supplied need to be replaced, a fuse of the same rating as the supplied one and approved by ASTA or BSI to BS1362 (i.e., marked with  $\diamond$  or  $\heartsuit$  mark) must be used. If the plug supplied with this equipment has a detachable fuse cover, be sure to attach the fuse cover after you change the fuse. Never use the plug without the fuse cover.

If you should lose the fuse cover, please contact your nearest Sony service station.

## FOR CUSTOMERS IN EUROPE

### ATTENTION

The electromagnetic fields at the specific frequencies may influence the picture and sound of this camcorder.

This product has been tested and found compliant with the limits set out in the EMC Directive for using connection cables shorter than 3 meters. (9.8 feet)



**Disposal of Old Electrical & Electronic Equipment (Applicable in the European Union and other European countries with separate collection systems)**

This symbol on the product or on its packaging indicates that this product shall not be treated as household waste. Instead it shall be handed over to the applicable collection point for the recycling of electrical and electronic equipment.

By ensuring this product is disposed of correctly, you will help prevent potential negative consequences for the environment and human health, which could otherwise be caused by inappropriate waste handling of this product. The recycling of materials will help to conserve natural resources.

For more detailed information about recycling of this product, please contact your local Civic Office, your household waste disposal service or the shop where you purchased the product.

Applicable Accessories: Remote Commander

### Notice

If static electricity or electromagnetism causes data transfer to discontinue midway (fail), restart the application or disconnect and connect the USB cable again.

## Notes on use

### Your camcorder is supplied with two kinds of operations guides.

- "Camera Operating Guide" (This manual)
- "Computer Application Guide"

### On using the camcorder

- Do not hold the camcorder by the following parts.



Viewfinder



LCD screen

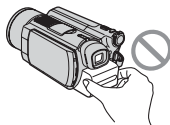

Battery

- The camcorder is not dust proofed, drip proofed or waterproofed. See "Maintenance and precautions" (p.94).
- To prevent the hard disk from being broken or recorded images from being lost, do not do the followings when either of the respective lamps of the POWER switch (p.17) or the ACCESS lamp (p.28) is on:
  - Removing the battery pack or AC Adaptor from the camcorder
  - Applying mechanical shock or vibration to the camcorder
- Before connecting your camcorder to another device with a USB cable etc., be sure to insert the connector plug in the proper direction. If you insert the connector plug forcibly in the wrong direction, the terminal may be damaged, or this may cause a malfunction of your camcorder.

### Notes on the Setup items, LCD screen, viewfinder, and lens

- A setup item that is grayed out is not available under the current recording or playback conditions.

- The LCD screen and the viewfinder are manufactured using extremely high-precision technology, so over 99.99% of the pixels are operational for effective use. However, there may be some tiny black points and/or bright points (white, red, blue, or green in color) that appear constantly on the LCD screen and the viewfinder. These points are normal.

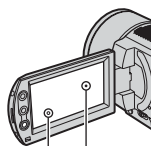

Black point  
White, red, blue or green point

- Exposing the LCD screen, the viewfinder, or the lens to direct sunlight for long periods of time may cause malfunctions. Be careful when placing the camera near a window or outdoors.
- Do not aim at the sun. Doing so might cause your camcorder to malfunction. Take images of the sun only in low light conditions, such as at dusk.

### On recording

- Before starting to record, test the recording function to make sure the image and sound are recorded without any problems.
- Compensation for the contents of recordings cannot be provided, even if recording or playback is not possible due to a malfunction of the camcorder.
- TV color systems differ depending on the countries/regions. To view your recordings on a TV, you need a PAL system-based TV.
- Television programs, films, video tapes, and other materials may be copyrighted. Unauthorized recording of such materials may be contrary to the copyright laws. You cannot dub copyright protected software on your camcorder.

## Read this first (continued)

### Compatibility of images

- You cannot play back both movies and still images other than the images recorded with your camcorder. You also cannot play back images recorded with other DCR-SR100E.

### On this manual

- The images of the LCD screen and the viewfinder used on this manual are captured using a digital still camera, and thus may appear different from what you see.
- Design and specifications of this camcorder and accessories are subject to change without notice.
- The on-screen displays in each local language are used for illustrating the operating procedures. Change the screen language before using your camcorder if necessary (p.62).

### About the Carl Zeiss lens

Your camcorder is equipped with a Carl Zeiss lens, which was developed jointly by Carl Zeiss, in Germany, and Sony Corporation, and produces superior images.

It adopts the MTF\* measurement system for video cameras and offers a quality typical of a Carl Zeiss lens.

Also, the lens for your camcorder is T\*-coated to suppress unwanted reflections and faithfully reproduce colors.

- \* MTF stands for Modulation Transfer Function. The number value indicates the amount of light from a subject coming into the lens.

# Notes on using the Hard Disk Drive Handycam

## Save all your recorded image data

- In the case of your image data being damaged, save all your recorded images. It is recommended that you save the image data on a DVD using your computer (see “Computer Application Guide”). Also, you can save it using VCR/DVD device (p.69).
- It is recommended that you save your image data periodically after recording.

## Do not apply shock or vibration to your camcorder

- The hard disk of the camcorder may not be recognized, or recording or playback may not be possible.
- Especially, during recording/playback, do not apply shock. After recording, do not apply vibration or shock to the camcorder, while the ACCESS lamp is lit.
- While using the shoulder belt (not supplied), do not crash the camera against a subject.

## On the drop sensor

- To protect the internal hard disk from the shock by dropping, the camcorder has the drop sensor function (p.58). When a drop occurs, or under a non-gravity condition, the block noise to protect the camcorder may also be recorded. If the drop sensor catches a drop repeatedly, recording/playback may be stopped.

## Notes on Battery Pack/AC Adaptor

- While the ACCESS lamp is lit, be sure to avoid the followings. They may cause malfunctions.
  - Removing the battery pack
  - Removing the AC Adaptor (while charging using the AC Adaptor)
- Be sure to remove the battery pack or the AC Adaptor after turning off the POWER switch.

## Note on operational temperatures

- When the temperature of the camcorder becomes extremely high or extremely low, you may not record or playback the camcorder to provide protection to the camcorder. In case of this, a message appears on the LCD screen (p.87).

## Note on using the camcorder in highlands

- You cannot use the camcorder in a low-pressure area, where its altitude is more than 3,000 meters (9,800 feet).

## Note on disposal/transfer

- If you perform [HDD FORMAT] (p.57) or formatting the camcorder, you may not delete data from the hard disk completely. When you transfer the camcorder, it is recommended that you perform [EMPTY HDD] (p.58) to make it difficult to recover your data. In addition to the above, when you dispose of the camcorder, it is recommended that you destroy the actual body of the camcorder. This may prevent data recovery on the hard disk of the camcorder.

## If you cannot record/play back images, perform [HDD FORMAT]

- If you repeat recording/deleting images for a long time, fragmentation occurs. Images cannot be saved/recorded. In such case, save the images to perform [HDD FORMAT] (p.57).  
Fragmentation ⓘ Glossary (p.99)

# Table of Contents

Read this first.....	2
Notes on using the Hard Disk Drive Handycam.....	5



## Enjoying with your Hard Disk Drive Handycam

What you can do with your Hard Disk Drive Handycam .....	10
Using your Hard Disk Drive Handycam .....	12

## Getting Started

Step 1: Checking supplied items.....	13
Step 2: Charging the battery pack .....	14
Step 3: Turning the power on, and holding your camcorder .....	17
Step 4: Adjusting the LCD screen and viewfinder.....	18
Step 5: Using the touch panel.....	19
Step 6: Setting the date and time.....	20
Step 7: Selecting the aspect ratio (16:9 or 4:3) of the recording image.....	21



## Easy Handycam – using your camcorder with automatic settings

Using Easy Handycam operation.....	22
Recording with ease .....	24
Playback with ease .....	26



## Recording/Playback

Recording.....	28
Playback .....	29
Searching for the desired images by date (Date Index) .....	30
Functions used for recording/playback, etc. ....	32

### Recording

- To use zoom
- To use the flash
- To record in dark places (NightShot)
- To adjust the exposure for backlit subjects (BACK LIGHT)

- To record sound with more presence (5.1ch surround recording)
- To adjust the focus for an off center subject
- To fix the exposure for the selected subject
- To add special effects
- To record in mirror mode
- To use a tripod
- To attach the shoulder belt

### **Playback**







- To play back a series of still images (Slide show)
- To use Playback zoom

### **Recording/playback**

- To check the remaining battery
- Check the available free hard disk space
- To turn off the operation confirmation beep
- To initialize the settings (Reset)
- Other part names and functions

Checking/Deleting the last scene (Review/Review deleting) .....	36
Indicators displayed during recording/playback .....	37
Remote Commander .....	39
Playing the image on a TV .....	40
Saving images.....	42
Deleting images.....	43

## **Using the Setup items**

Using the Setup items .....	46
Setup items .....	48
 <b>CAMERA SET</b> .....	50
Settings to adjust your camcorder to the recording conditions (EXPOSURE/WHITE BAL./STEADYSHOT, etc.)	
 <b>STILL SET</b> .....	54
Settings for still images (BURST/QUALITY/IMAGE SIZE, etc.)	
 <b>PICT. APPLI</b> .....	55
Special effects on images or additional functions on recording/playback (PICT. EFFECT/D. EFFECT, etc.)	
 <b>HDD SET</b> .....	57
Settings for the hard disk (HDD FORMAT/HDD INFO, etc.)	
 <b>STANDARD SET</b> .....	59
Settings while recording or other basic settings (REC MODE/LCD/VF SET/USB SPEED, etc.)	
 <b>TIME/LANGU</b> .....	62
(CLOCK SET/AREA SET/LANGUAGE, etc.)	

## Table of Contents (continued)

Customizing Personal Menu .....	63
---------------------------------	----

### Editing images

Creating the Playlist .....	65
Playing the Playlist .....	67
Setting image protection (Protection) .....	67

### Dubbing, Printing

Dubbing to VCR/DVD devices .....	69
Recording images from a TV or VCR/DVD device (For DCR-SR100E only) .....	71
Printing recorded still images (PictBridge compliant printer) .....	73
Jacks to connect external devices .....	75

### Troubleshooting

Troubleshooting .....	76
Warning indicators and messages .....	86

### Additional Information

Using your camcorder abroad .....	90
Files on the camcorder hard disk/folder structure .....	92
About the “InfoLITHIUM” battery pack .....	93
Maintenance and precautions .....	94
Specifications .....	96

### Glossary, Index

Glossary .....	99
Index .....	101







Enjoying with your Hard Disk Drive Handycam

# What you can do with your Hard Disk Drive Handycam

You can record images to the hard disk of the camcorder. Hard Disk Drive Handycam offers more options than the tape or the DVD camcorder for your convenience and entertainment.

## “Recording and viewing” : clear, easy and convenient

### Recording onto the hard disk for long hours (p.15, 28)

You can record more than seven hours\* when the image is set to high quality ([HQ]) onto the hard disk. All the recorded images are saved on the free hard disk space. You are not at a risk to write images onto your favorite images by mistake.

Also, you do not need to rewind or fast-forward your movie, and you can start recording whenever you are ready.

\* If you change the image quality of a movie, you can record images for longer hours.

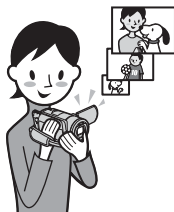

### You can find a scene quickly by using the VISUAL INDEX screen (p.29).

The VISUAL INDEX screen allows you to check the recorded images at a glance. All you have to do is touch the scene you want to view.

Also, you can search for a desired scene by date using Date Index.

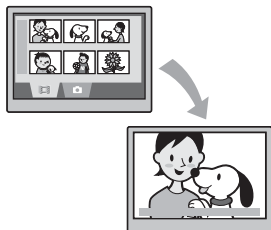

### Viewing on a TV or saving to VCR/DVD devices

You can connect your Handycam directly to a TV to play back the recorded images (p.40). Also, you can save them to VCR/DVD devices.



## Realistic sounds can be recorded (5.1ch surround sound) (p.33)

You can record the movie with 5.1ch surround sound. You can create a DVD containing your movies with 5.1ch surround sound with supplied computer software. This provides full sound on a home theater.

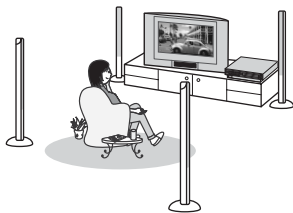

## Connecting Hard Disk Drive Handycam to a computer

### One Touch DVD Burn ("Computer Application Guide")

You can save a recorded image on a DVD with a simple touch. Images that have not been saved to a DVD with One Touch DVD Burn can automatically be saved.

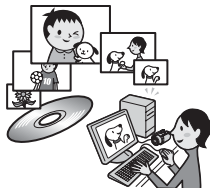

### Edit images and create a DVD with selected images ("Computer Application Guide")

You can copy images to your computer. You can also edit images and create a DVD with selected images.

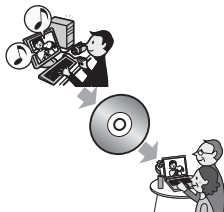

# Using your Hard Disk Drive Handycam

Images are recorded on the internal hard disk. When the hard disk becomes full, you cannot record new images. It is recommended that you save the image data periodically, then delete the unnecessary images from the hard disk of your camcorder.

- If you delete the images, you can record images on the free hard disk space again.

## Preparing (p.13)



## Recording (p.28)



## Viewing on your Hard Disk Drive Handycam

- Viewing on the LCD screen (p.29)
- Viewing on a TV (p.40)



## Saving

Save recorded images on a DVD or alike.

- Saving images on a DVD using a computer (“Computer Application Guide”).
- Copying images to a computer (“Computer Application Guide”).
- Dubbing on VCR/DVD devices (p.69).



## Deleting images

Delete the image data that has been saved on your camcorder. If you delete the images, you can record new images on the free hard disk space again.

- Select image and delete it (p.43).
- Delete all the images ([HDD FORMAT], p.57).

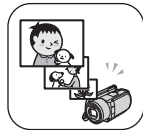

## Step 1: Checking supplied items

Make sure that you have following items supplied with your camcorder. The number in the parentheses indicates the number of that item supplied.

AC Adaptor (1) (p.14)

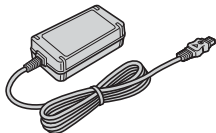

Mains lead (1) (p.14)

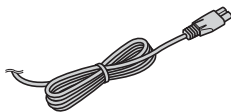

A/V connecting cable (1) (p.40, 69, 71)



USB cable (1) (p.73, 75)

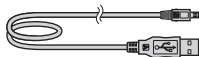

Wireless Remote Commander (1) (p.39)

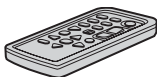

A button-type lithium battery is already installed.

Rechargeable battery pack  
NP-FP60 (1) (p.15)

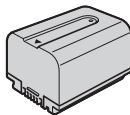

CD-ROM "ImageMixer for HDD  
Camcorder" (1)

"Camera Operating Guide" (This manual) (1)

"Computer Application Guide" (1)

## Step 2: Charging the battery pack

You can charge the battery after attaching the "InfoLITHIUM" battery pack (P series) (p.93) to your camcorder.

- You cannot use an NP-FP30 battery pack with your camcorder. (See the reverse side of the battery pack for the model number.) Installing the battery pack with excess force may lead to camcorder malfunction such as deterioration in battery pack performance or difficulty in removing the battery pack.

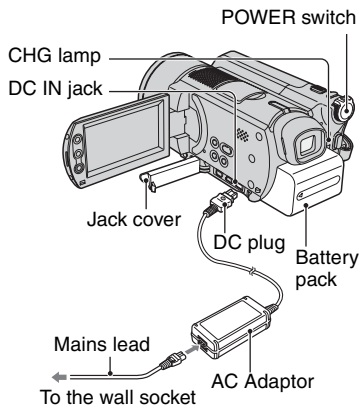

- 1** Slide the battery pack in the direction of the arrow until it clicks.

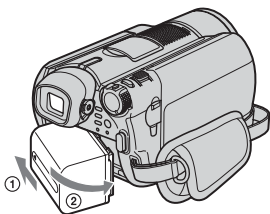

- 2** Slide the POWER switch in the direction of the arrow to set it to OFF (CHG) (The default setting).

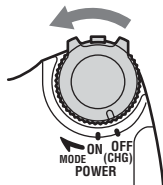

- 3** Connect the AC Adaptor to the DC IN jack on your camcorder.

Open the jack cover to connect the AC Adaptor.

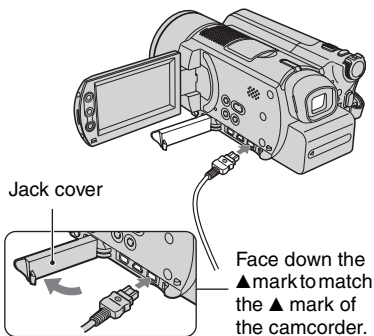

- 4** Connect the mains lead to the AC Adaptor and the wall socket.

The CHG (charge) lamp lights up and charging starts.



## 5 The CHG (charge) lamp turns off when the battery is fully charged. Remove the AC Adaptor from the DC IN jack on your camcorder.

- Remove the AC Adaptor holding both your camcorder and the DC plug.

### To remove the battery pack

Slide the POWER switch to OFF (CHG). Slide the BATT (battery) release lever and remove the battery pack.

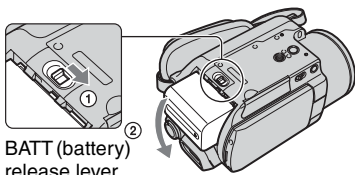

BATT (battery) release lever

- When you remove the battery pack, make sure that none of the respective lamps of the POWER switch (p.17) is on.

### When storing the battery pack

Use up the battery pack completely if you do not intend to use it for a long time (p.93).

### To use an outside power source

Make the same connections as you do when charging the battery pack. The battery pack will not lose its charge in this case.

### Charging time (full charge)

Approximate time (min.) required when you fully charge a fully discharged battery pack.

Battery pack	Charging time
NP-FP50	125
NP-FP60 (supplied)	135
NP-FP70	155
NP-FP71	170
NP-FP90	220

### Recording time

Approximate time (min.) available when you use a fully charged battery pack.

Battery pack	Continuous recording time	Typical recording time*
NP-FP50	65	30
	70	35
	70	35
NP-FP60 (supplied)	100	50
	110	55
	110	55
NP-FP70	135	65
	150	75
	155	75
NP-FP71	165	80
	180	90
	185	90
NP-FP90	250	125
	270	135
	275	135

\* Typical recording time shows the time when you repeat recording start/stop, turning the power on/off and zooming.

- Times shown vary according to the following conditions.
  - Top: When the LCD backlight turns on.
  - Middle: When the LCD backlight turns off.
  - Bottom: Recording time when recording with the viewfinder while the LCD panel is closed.

## Step 2: Charging the battery pack (continued)

### Playback time

Approximate time (min.) available when you use a fully charged battery pack.

Battery pack	LCD screen opened*	LCD screen closed
NP-FP50	105	125
NP-FP60 (supplied)	160	190
NP-FP70	225	265
NP-FP71	270	315
NP-FP90	400	475

\* When the LCD backlight turns on.

### On the battery pack

- Before changing the battery pack, slide the POWER switch to OFF (CHG).
- The CHG (charge) lamp flashes during charging, or BATTERY INFO (p.35) will not be correctly displayed under the following conditions.
  - The battery pack is not attached correctly.
  - The battery pack is damaged.
  - The battery pack is fully discharged. (For BATTERY INFO only.)
- The power will not be supplied from the battery as long as the AC Adaptor is connected to the DC IN jack of your camcorder, even when the mains lead is removed from the wall socket.
- We recommend that you use an NP-FP70, NP-FP71 or NP-FP90 battery pack when a video light (optional) is attached.

### On the charging/recording/playback time

- Times measured with the camcorder at 25 °C (77°F). (10-30°C (50-86°F) is recommended.)
- Available recording and playback time will be shorter when you use your camcorder in low temperatures.
- The available recording and playback time will be shorter depending on the conditions under which you use your camcorder.

### On the AC Adaptor

- Connect the AC Adaptor to an easily accessible wall socket close by. If any trouble occurs while using the adaptor, immediately shut off the power by removing the plug from the wall socket.
- Do not use the AC Adaptor placed in a narrow space, such as between a wall and furniture.
- Do not short-circuit the DC plug of the AC Adaptor or battery terminal with any metallic objects. This may cause a malfunction.

### PRECAUTION

- Even if your camcorder is turned off, AC power (mains) is still supplied to it while connected to the wall socket via the AC Adaptor.



## Step 3: Turning the power on, and holding your camcorder

To record, slide the POWER switch to turn on the respective lamp.

When using it for the first time, the [CLOCK SET] screen appears (p.20).

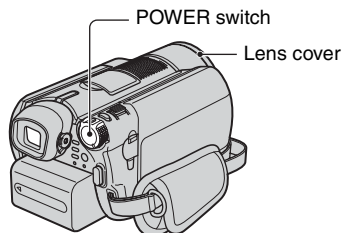

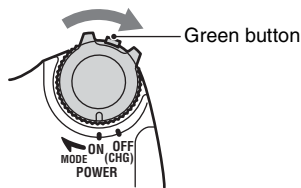

### 1 Turn on the power by sliding the POWER switch in the direction of the arrow while pressing the green button in the center.

When you record, switch the power mode by sliding the POWER switch in the direction of the arrow until the respective lamp lights up.





 (Movie): To record movies

 (Still): To record still images

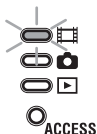
 (PLAY/EDIT): To play back images on your camcorder, or to edit/delete them



- When you set the POWER switch to  (Movie) or  (Still), the lens cover opens up.

- After you have set the date and time ([CLOCK SET], p.20), the next time you turn on the power of your camcorder, the current date and time will be displayed on the LCD screen for a few seconds.

### 2 Hold your camcorder correctly.

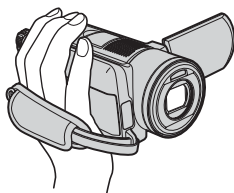

### 3 Ensure a good grip, then fasten the belt.

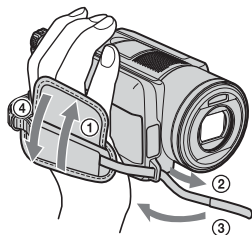

### To turn off the power

Slide the POWER switch to OFF (CHG).

- At the time of purchase, the power will be set to turn off automatically if you leave your camcorder without any operation for approximately five minutes, to save battery power. ([A.SHUT OFF], p.62).

# Step 4: Adjusting the LCD screen and viewfinder

## The LCD screen

Open the LCD screen 90 degrees to the camcorder (①), then rotate it to the best angle to record or play (②).

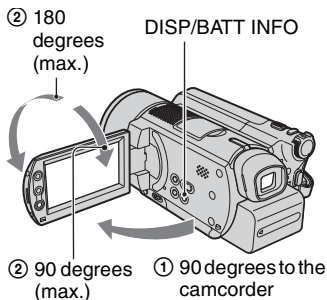

- Be careful not to press the buttons on the LCD frame accidentally, when you open or adjust the LCD screen.
- If you open the LCD screen 90 degrees to the camcorder, then rotate it 180 degrees to the lens side, you can close it with the LCD screen side facing out. This is convenient during playback operations.

## To turn off the LCD backlight to make the battery last longer

Press and hold DISP/BATT INFO for a few seconds until  $\text{LCD OFF}$  appears.

This setting is practical when you use your camcorder in bright conditions or you want to save battery power. The recorded image will not be affected by the setting. To cancel, press and hold DISP/BATT INFO until  $\text{LCD OFF}$  disappears.

- See [LCD/VF SET] - [LCD BRIGHT] (p.60) to adjust the brightness of the LCD screen.

## The viewfinder

You can view images using the viewfinder with the LCD panel closed to avoid wearing down the battery, or when the image seen on the LCD screen is poor.

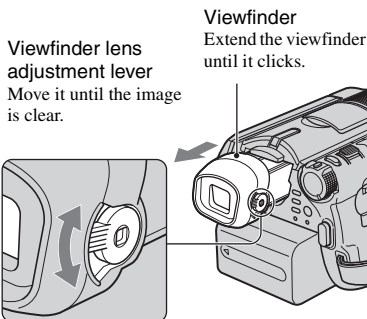

- You can adjust the brightness of the viewfinder backlight by selecting  $\text{STANDARD SET}$  - [LCD/VF SET] - [VF B.LIGHT] (p.60). The recorded image will not be affected by the setting.
- You can adjust [FADER] and [EXPOSURE] while looking through the viewfinder (p.56).

## Step 5: Using the touch panel

You can play back recorded images (p.26, 29), or change the settings (p.46) using the touch panel.

Touch the buttons displayed on the screen.

---

**Support the rear of the LCD panel with your finger. Then, touch the buttons displayed on the screen.**

Touch the button on the LCD screen.

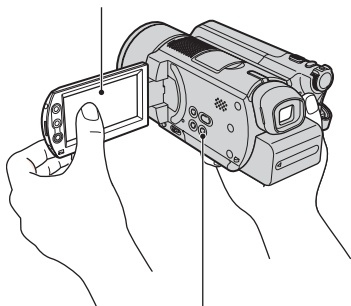

DISP/BATT INFO

- Perform the same actions as described above when you press the buttons on the LCD frame.
- Be careful not to press the buttons on the LCD frame accidentally while using the touch panel.
- If the buttons on the touch panel do not work correctly, adjust the LCD screen (CALIBRATION) (p.95).

---

### To hide the screen indicators

Press DISP/BATT INFO to hide or show the screen indicators (counter, etc.).

### Changing the language setting

You can change the on-screen displays to show messages in a specified language. Select the screen language in [LANGUAGE] on the TIME/LANGU. (p.62).

# Step 6: Setting the date and time

Set the date and time when using this camcorder for the first time. If you do not set the date and time, the [CLOCK SET] screen appears every time you turn on your camcorder or slide the POWER switch.

- If you do not use your camcorder for about **3 months**, the built-in rechargeable battery gets discharged and the date and time settings may be cleared from the memory. In that case, charge the rechargeable battery and then set the date and time again (p.95).

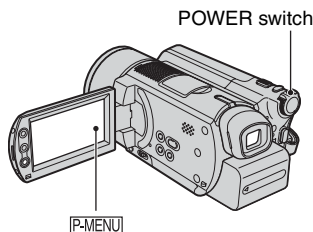

Skip to step 4 when you set the clock for the first time.

- 1 Touch **[P-MENU]** → **[SETUP]**.

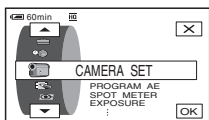

- 2 Select **(TIME/LANGU.)** with **[▲]/[▼]**, then touch **[OK]**.

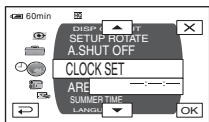

- 3 Select **[CLOCK SET]** with **[▲]/[▼]**, then touch **[OK]**.

- 4 Select the desired geographical area with **[▲]/[▼]**, then touch **[OK]**.

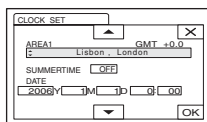

- 5 Set **[SUMMERTIME]** to **[ON]** with **[▲]/[▼]**, if necessary, then touch **[OK]**.

- 6 Set **[Y]** (year) with **[▲]/[▼]**, then touch **[OK]**.

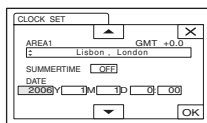

- You can set any year up to the year 2079.

- 7 Set **[M]** (month), **[D]** (day), hour and minute, then touch **[OK]**.

The clock starts.

- Refer to page 91 for information concerning "World time difference."
- The recording date and time are not displayed during recording, but are automatically recorded onto the hard disk and displayed during playback ([DATA CODE], p.60).

## Step 7: Selecting the aspect ratio (16:9 or 4:3) of the recording image

By recording in the 16:9 (wide) mode, you can enjoy wide-angle, high-resolution images.

- If you intend to view images on a wide TV, recording in the 16:9 (wide) mode is recommended.

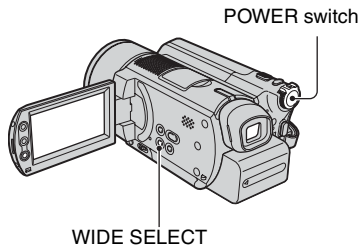

- You cannot change the aspect ratio in the following cases:
  - while recording movies
  - when [D. EFFECT] is set to [OLD MOVIE] (p.56)
- Differences in the angle of view between 16:9(wide) and 4:3 vary depending on the zoom position.

### To play back images after connecting your camcorder to a TV

Set [TV TYPE] to [16:9] or [4:3] according to your TV (16:9/4:3) (p.40).

- When viewing 16:9 (wide) images with [TV TYPE] set to [4:3], images may appear rough depending on subjects.

## Movies

- 1 Slide the **POWER** switch in the direction of the arrow to light up the  (Movie) lamp.

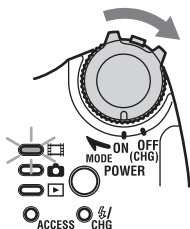

- 2 Press **WIDE SELECT** repeatedly to select the desired screen aspect ratio.

16:9 (wide)\*



4:3\*





\* When viewing on the LCD screen. The image may look different in the viewfinder.

## Still images

- 1 Slide the **POWER** switch to light up the  (Still) lamp.

The image size ratio changes to 4:3.

- 2 Press **WIDE SELECT** repeatedly to select the desired setting.

- Still image size is set to [ 2.3M] () when 16:9 (wide) is selected. [3.0M] () is set in maximum mode when 4:3 is selected.
- The number of recordable still images is 9,999.



## Using Easy Handycam operation

Easy Handycam operation is a function for making nearly all settings automatic with just one press of the EASY button. Since only basic functions become available and screen font size increases for easy viewing, even first time users can enjoy easy operation.

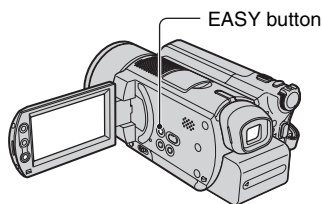

### The settings of your camcorder during Easy Handycam operation

Touch [SETUP] to display the available setup items.

For details on setup, See page 47.

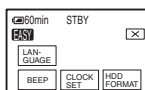
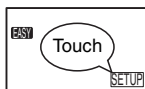

- Nearly all setup items are automatically fixed.
- **P-MENU** is not displayed during Easy Handycam operation.
- To perform settings such as focusing manually and adding special effects, cancel Easy Handycam operation.

### Invalid buttons during Easy Handycam operation

You cannot use following buttons or functions since they are automatically set. If you set an invalid operation, [Invalid during Easy Handycam operation] may appears.

- BACK LIGHT (p.33)
- Press and hold DISP/BATT INFO (p.18)
- Zoom lever/buttons (during playback)



Now try recording → page 24

Complete the preparations described in steps 1 to 7 (p.13 to 21) before operation.





# Recording with ease

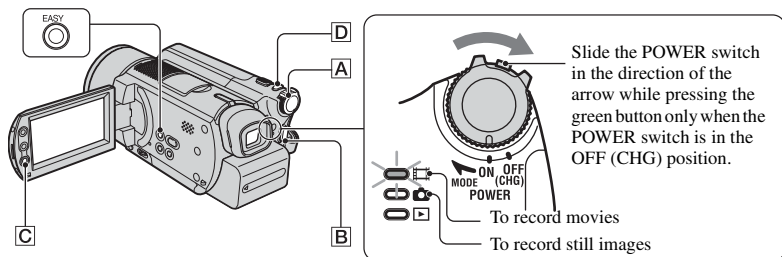

## Movies

**1** Slide the POWER switch **A** in the direction of the arrow to light up the (Movie) lamp.

**2** Press EASY.

[Easy Handycam operation ON.] appears, then **EASY** appears on the LCD screen.



**3** Press START/STOP **B** (or **C**).

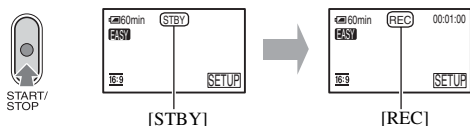

To stop recording, press START/STOP again.

- [REC MODE] is set to [HQ] (default settings) (p.59).
- A recordable time of movies you can record in a succession is up to 12 hours.

## To record the next movies

Perform step 3.





**1** Slide the POWER switch **A** in the direction of the arrow to light up the (Still) lamp.

**2** Press EASY.

[Easy Handycam operation ON.] appears, then **EASY** appears on the LCD screen.



**3** Press PHOTO **D** lightly to adjust the focus **A**, then press it fully **B**.

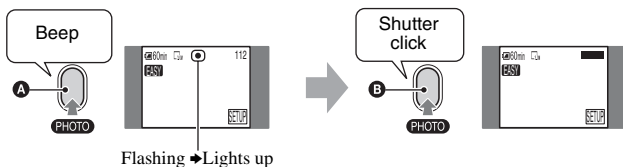

A shutter sound is heard. When disappears, the image has been recorded.

- [ QUALITY ] is set to [ FINE ] (default settings) (p.55).

### To record the next still images

Perform step 3.

### To cancel Easy Handycam

Press EASY again. **EASY** disappears on the LCD screen.



# Playback with ease

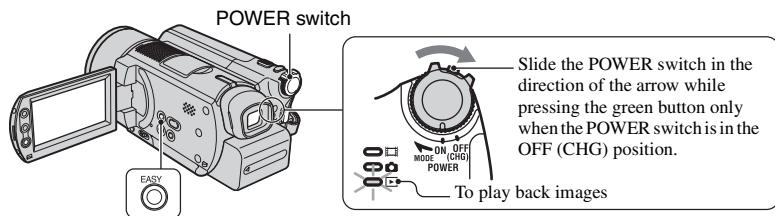

- 1 Slide the POWER switch in the direction of the arrow repeatedly to light up the  (PLAY/EDIT) lamp.**

The VISUAL INDEX screen appears on the LCD screen.

- 2 Press EASY.**

[Easy Handycam operation ON.] appears, then **EASY** appears on the LCD screen.

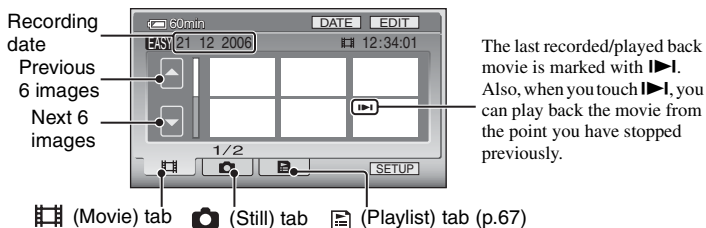

### 3 Start playback.

#### Movies



Touch (Movie) tab, then touch the thumbnail of the movie to be played back.

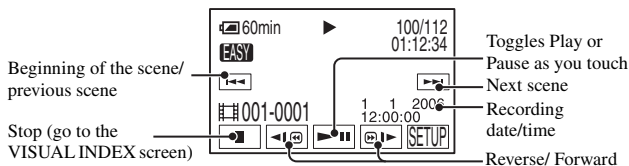

When the selected movie has played back to the end, the screen returns to the VISUAL INDEX screen.

- Touch / during pause to play back movie slowly.
- Touch [SETUP] → [VOLUME], then adjust it with / .

#### Still Images



Touch (Still) tab, then touch the thumbnail of the still image to be played back.

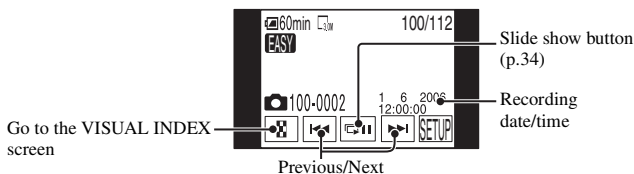

- It may take some time to display the VISUAL INDEX screen.
- When you touch [EDIT] on the VISUAL INDEX screen, you can delete images. See “Deleting images” on page 43.

#### To cancel Easy Handycam

Press EASY again. **EASY** disappears on the LCD screen.

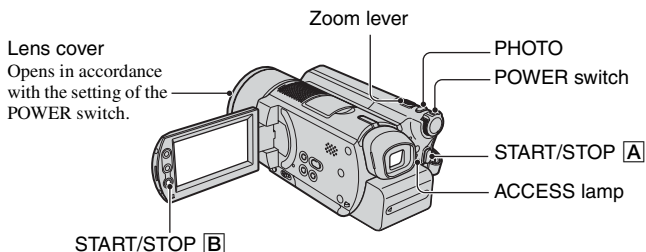

- 1** Slide the **POWER** switch in the direction of the arrow repeatedly to light up the respective lamp.

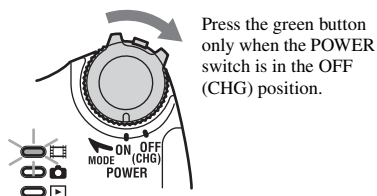

- 2** Start recording.

**Movies**

Press **START/STOP [A]** (or **[B]**).

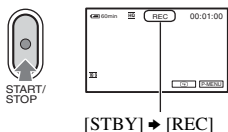

To stop recording, press **START/STOP** again.

**Still Images**

Press **PHOTO** lightly to adjust the focus **[A]**, then press it fully **[B]**.

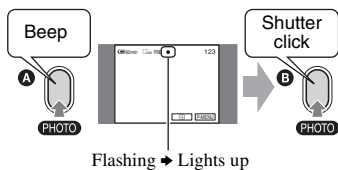

A shutter sound is heard. When **||||** disappears, the image has been recorded.



- If the **ACCESS** lamp is on after recording is finished, it means data is still being written onto the hard disk. Do not apply shock or vibration to your camcorder, and do not remove the battery pack or AC Adaptor.
- You cannot record movies and still images at the same time.
- A recordable time of movies in a succession is up to 12 hours.
- When a movie data file exceeds 2 GB, the next file is created automatically.
- For image quality of movies, see [REC MODE] (p.59), of still images, see [IMAGE SIZE] (p.55).



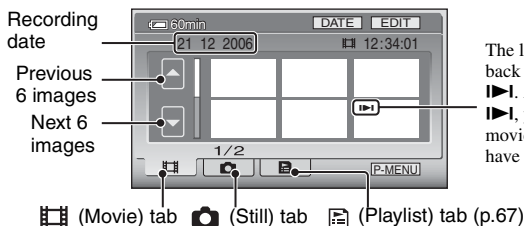

# Playback

## 1 Slide the POWER switch repeatedly to light up the (PLAY/EDIT) lamp.

The VISUAL INDEX screen appears on the LCD screen.



The last recorded/played back movie is marked with . Also, when you touch , you can play back the movie from the point you have stopped previously.

- Moving the zoom lever changes the VISUAL INDEX screen indication from 6 to 12 and more images can be displayed at the same time.
- Touch  [DISPLAY] in  STANDARD SET to set the number of thumbnails that appear in the VISUAL INDEX screen (p.61)
- If you press and hold  / , you can scroll the thumbnail index quickly.



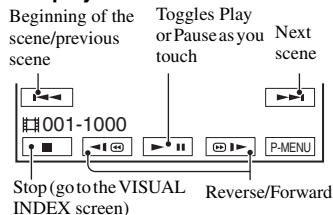

## 2 Start playback.

### Movies

Touch  (Movie) tab and the movie to be played back.



The screen returns to the VISUAL INDEX screen when playback has completed.



- Touch  /  during pause to play back movie slowly.
- One touch of  /  makes the reverse/fast forward approximately five times faster, two touches make it approximately 10 times faster, three touches make it approximately 30 times faster, four touches make it approximately 60 times faster.

### Still Images

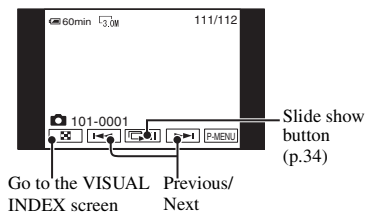
Touch  (Still) tab and the still image to be played back.



### To adjust the volume

Touch  → [VOLUME], then adjust it with  / .

- If you cannot find [VOLUME] in , touch [SETUP] (p.46).

### Searching for the desired images by date (Date Index)

You can search for desired images by date efficiently.

- 1 Slide the **POWER** switch repeatedly to light up the **(PLAY/EDIT)** lamp.

The **VISUAL INDEX** screen appears on the LCD screen.

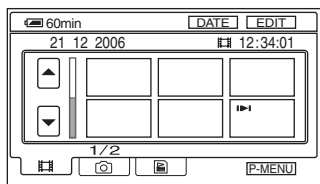

- 2 To search for movies, touch **[#]** (Movie) tab. To search for still images, touch **[📷]** (Still) tab.

- 3 Touch **[DATE]**.

The recording dates of images are displayed on the screen.

Return to the **VISUAL INDEX** screen

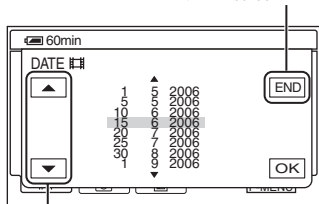

Previous/Next Date button

- 4 Touch **Previous/Next Date** button to select the date of the desired image.

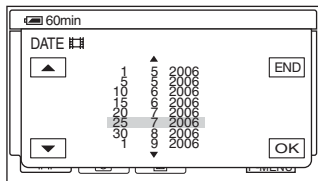

- 5 Touch **[OK]** while the selected date of the desired image is highlighted.

The images for selected date are displayed on the **VISUAL INDEX** screen.



# Functions used for recording/playback, etc.

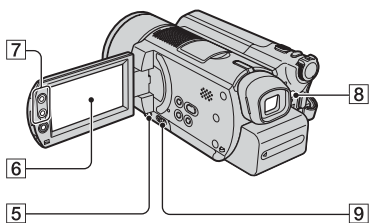
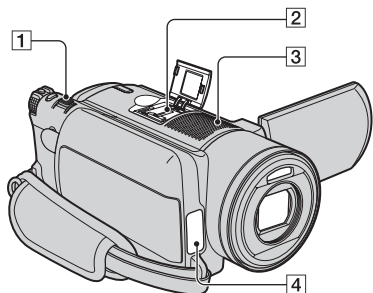

## Recording

### To use zoom ..... 1 7

Move the power zoom lever **1** slightly for a slower zoom. Move it further for a faster zoom.

**Wider range of view: (Wide)**

**Close view: (Telephoto)**

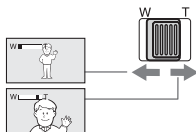

- Be careful not to remove your finger suddenly from the power zoom lever **1**. If you do so, the sound of the lever moving may be recorded.
- You cannot change the zoom speed with the zoom buttons **7** on the LCD frame.
- The minimum distance required between your camcorder and the subject to get a sharp focus is about 1 cm (about 1/2 inch) for wide angle and about 80 cm (about 2 5/8 feet) for telephoto.

- You can set [DIGITAL ZOOM] if you want to zoom to a level greater than 10 × (p.54).

### To use the flash ..... 8

Press **8** (flash) repeatedly to select the setting.

**No indicator displayed:** Automatically flashes when there is insufficient ambient light.



**⚡ (Forced flash):** Always uses the flash regardless of the surrounding brightness.



**⊗ (No flash):** Records without flash.

- The recommended distance to the subject when using the built-in flash is 0.3 to 2.7 m (1 to 9 feet).
- Remove any dust from the surface of the flash lamp before using it. Flash effect may be impaired if heat discoloration or dust obscures the lamp.
- The flash charge lamp flickers when charging the flash, and remains lit when the battery charge is complete.
- If you use the flash in bright places such as when shooting a backlit subject, the flash may not be effective.
- The flash does not work when attaching the conversion lens (optional) or filter (optional).
- You can change the brightness of the flash by setting [FLASH LEVEL], or you can prevent the redeye by setting [REDEYE REDUC] (p.52).

### To record in dark places (NightShot) ..... 9

Set the NIGHTSHOT switch **9** to ON. (  and ["NIGHTSHOT"] appear.)

- To record an image brighter, use Super NightShot function (p.53). To record an image brighter in dim light, use Color Slow Shutter function (p.53).
- The NightShot and Super NightShot use infrared light. Therefore, do not cover the infrared port **4** with your fingers or other objects.
- Remove the conversion lens (optional).
- Adjust the focus manually ([FOCUS], p.52) when it is hard to focus automatically.
- Do not use these functions in bright places. This may cause a malfunction.



### To adjust the exposure for backlit subjects (BACK LIGHT) ..... [5]

To adjust the exposure for backlit subjects, press BACK LIGHT [5] to display . To cancel the back light function, press BACK LIGHT again.

### To record sound with more presence (5.1ch surround recording) ..... [2][3]



Your camcorder has Dolby Digital 5.1 Creator installed for recording 5.1ch surround sound. Using the supplied computer applications, you can create a DVD containing movies with the 5.1ch surround sound, which provides full sound on an appropriate device.

- **5.1ch** is displayed on the screen during 5.1ch recording. 5.1ch sound is converted to 2ch when played back on your camcorder.

Dolby Digital 5.1 Creator, 5.1ch surround sound Glossary (p.99)

Sound picked up by the built-in 4ch microphone [3] is converted to 5.1ch surround sound and recorded.

### To record with a wireless microphone

You can use a wireless microphone\* (optional) to record distant sound wirelessly.

The sound it picks up is allotted to the front center part of the 5.1ch surround sound, mixed with the sound picked up by the internal microphone, and recorded. You can enjoy more realistic sound by playing back a DVD created with the supplied computer application on the device that supports 5.1ch surround sound. Attach the wireless microphone to the Active Interface Shoe [2] (p.75). For details, refer to the instruction manual of your wireless microphone.

\* Optional wireless microphone is not available in all countries.

### To adjust the focus for an off center subject ..... [6]

See [SPOT FOCUS] on page 52.

### To fix the exposure for the selected subject ..... [6]

See [SPOT METER] on page 50.

### To add special effects ..... [6]

See PICT. APPLI. on page 55.

## Functions used for recording/playback, etc. (continued)

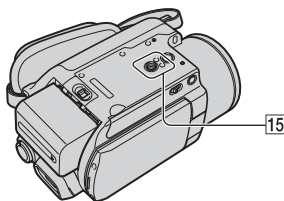
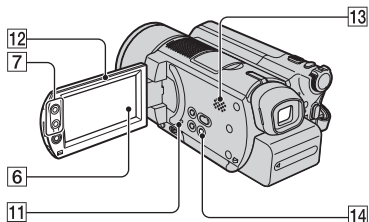
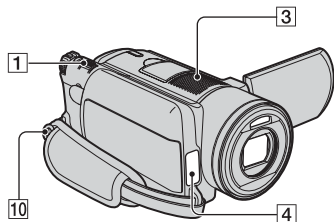

### To record in mirror mode..... 12

Open the LCD screen 12 90 degrees to the camcorder (1), then rotate it 180 degrees to the lens side (2).

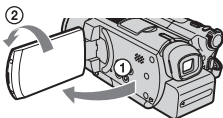

- A mirror-image of the subject appears on the LCD screen, but the image will be normal when recorded.

### To use a tripod..... 15

Attach the tripod (optional): the length of the screw must be less than 5.5 mm) to the tripod receptacle 15 using a tripod screw.

### To attach the shoulder belt ..... 10



Attach the shoulder belt (optional) with your camcorder to the hook for the shoulder belt.

## Playback

### To play back a series of still images (Slide show) ..... 6

Touch  on the still image playback screen (p.29).

The slide show begins from the selected image.

Touch  to stop the slide show. To restart, touch  again.

- You can touch  to set continuous slide show playback. The default setting is [ON] (continuous playback).
- You cannot operate playback zoom during slide show.

### To use Playback zoom..... 1 7

You can magnify images from about 1.1 to 5 times the original size.

Magnification can be adjusted with the power zoom lever 1 or the zoom buttons 7 on the LCD frame.

- 1 Play back the image you want to magnify.
- 2 Magnify the image with T (Telephoto). A frame appears on the LCD screen.
- 3 Touch the portion that you want to display in the center of the LCD screen.
- 4 Adjust the magnification with W (Wide angle)/T (Telephoto).

To cancel, touch [END].

- You cannot change the zoom speed with the zoom buttons 7 on the LCD frame.

## Recording/playback

### To check the remaining battery .... [14]

Set the POWER switch to OFF (CHG), then press DISP/BATT INFO [14]. If you press this button once, BATTERY INFO appears on the screen for about seven seconds. Press the button while BATTERY INFO appears on the screen to extend the indication to the 20-second maximum.

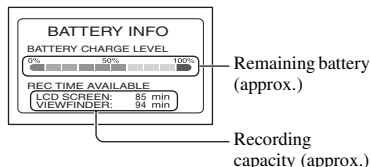

### Check the available free hard disk space ..... [6]

See [HDD INFO] (p.57).

- During recording, the remaining recordable time/ number of still images are displayed.

### To turn off the operation confirmation beep ..... [6]

See [BEEP] on page 62.

### To initialize the settings (Reset) ... [11]

Press RESET [11] to initialize all the settings, including settings for date and time. (Setup items customized on Personal Menu are not initialized.)

## Other part names and functions

### [3] Built-in 4ch microphone

When an external microphone (optional) is connected, it takes precedence over the internal microphone.

### [4] Remote sensor

Point the Remote Commander (p.39) towards the remote sensor to operate your camcorder.

### [4] Recording lamp

The recording lamp lights up in red during recording (p.61).

The lamp flashes when the remaining capacity for the battery or the hard disk of the camcorder is running low.

### [13] Speaker



Sounds come out from the speaker while playing back.

- For how to adjust the volume, see page 29.

# Checking/Deleting the last scene (Review/Review deleting)

You can check the last recorded movies/still images. Also, you can delete the checked images.

## Checking the last scene (Review)

- 1 Slide the **POWER** switch to light up the  (Movie) or  (Still) lamp, then touch .

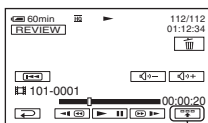

The playback of the latest scene starts.

Movie



Touch to display below function buttons.

 : Return to the beginning of the viewing movie.

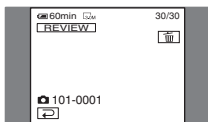

 /  : Adjust the volume.

Still image



## To return to recording

Touch .

- Camera data (recording date, conditions etc.) is not displayed.
- When reviewing still images recorded continuously (p.54), you can forward/backward the images with  / .

## Deleting the last scene (Review deleting)

If the checked scene is unnecessary, you can delete it on the spot.

- 1 Press  during the review.

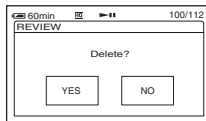

- 2 Touch [YES].

- You cannot recover a scene once you delete it.
- You can delete the last recorded image in a succession with Review deleting.
- You can only delete the last recorded image in order with Review. To delete the desired image, see page 43.
- When the recorded images are deleted in order with Review deleting, you cannot continue to delete them if a protected image appears on the screen.
- When you delete still images that were recorded continuously (p.54), all the images are deleted at the same time.

# Indicators displayed during recording/playback

( ) is a reference page.

The indicators during recording will not be recorded.

## Recording movies

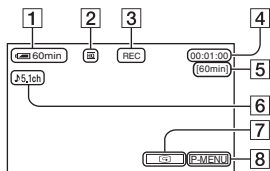

- 1 Remaining battery (approx.) (35)
- 2 Recording mode (HQ / SP / LP) (59)
- 3 Recording status ([STBY] (standby) / [REC] (recording))
- 4 Counter (hour: minute: second)
- 5 Remaining recordable time of movies
- 6 5.1ch surround recording (33)
- 7 Review button (36)
- 8 Personal Menu button (46)

## Recording still images

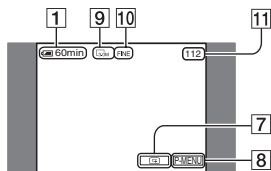

- 9 Image size (55)
- 10 Quality ([FINE] / [STD]) (55)
- 11 Number of recordable still images

## Viewing movies

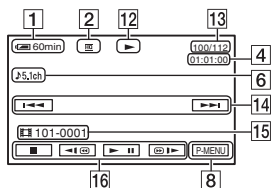

- 12 Playback mode
- 13 Number of played back movies/Total number of recorded movies
- 14 Previous/Next button (27, 29)
- 15 Recording folders/files (92)
- 16 Video operation buttons (27, 29)

## Viewing still images

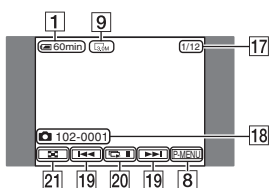

- 17 Number of played back still images/Total number of recorded still images
- 18 Recording folders/files (92)
- 19 Previous/Next button (27, 29)
- 20 Slide show button (34)
- 21 VISUAL INDEX button (27, 29)

## Indicators displayed during recording/playback (continued)

( ) is a reference page.

### Indicators on the LCD screen and viewfinder

When you can change the setup items, or during recording or playback, following indicators are displayed.

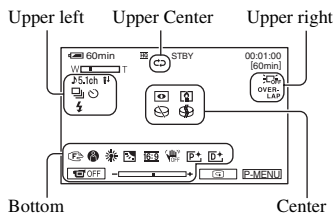

#### Upper left

Indicator	Meaning
	5.1ch surround recording (33)
	Self-timer recording (53)
	Continuous photo recording /Bracket recording (54)
	Flash light (52)
	MICREF LEVEL low (59)

#### Upper center

Indicator	Meaning
	Repeat of Slide show (34)

#### Upper right

Indicator	Meaning
	WHITE FADER
	BLACK FADER
	OVER-LAP
	WIPE
	Fader (55)
	LCD backlight off (18)
	Drop sensor off (58)
	Drop sensor (58)

#### Center

Indicator	Meaning
	NightShot (32)
	Super NightShot (53)
	Color Slow Shutter (53)
	PictBridge connecting (73)
	Warning (86)

#### Bottom

Indicator	Meaning
	Picture effect (56)
	Digital effect (56)
	Manual focus (52)
	PROGRAM AE (50)
	Backlight (33)
	White balance (51)
	WIDE SELECT (21)
	SteadyShot off (54)
	Flexible spot meter (50)/ Exposure (51)
	LCD panel off (56)

### DATA CODE while recording

The recording date and time are recorded automatically. They are not displayed while recording. However, you can check them as [DATA CODE] during playback (p.60).

# Remote Commander

Remove the insulation sheet before using the Remote Commander.

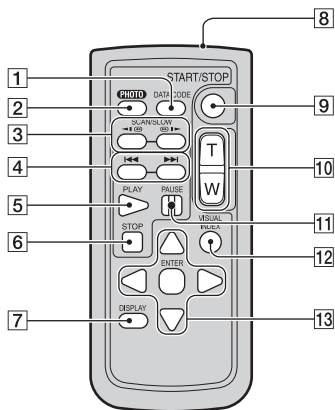
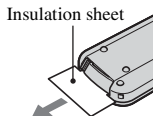

## 1 DATA CODE (p.60)

Displays the date and time or camera setting data of the recorded images (p.60) when you press this while playing back.

## 2 PHOTO (p.25, 28)

The on-screen image when you press this button will be recorded as a still image.

## 3 SCAN/SLOW (p.27, 29)

## 4 ◀◀ ▶▶ (Previous/Next) (p.27, 29)

## 5 PLAY (p.27, 29)

## 6 STOP (p.27, 29)

## 7 DISPLAY (p.19)

## 8 Transmitter

## 9 START/STOP (p.24, 28)

## 10 Power zoom (p.32, 34)

## 11 PAUSE (p.27, 29)

## 12 VISUAL INDEX (p.26, 29)

Displays a VISUAL INDEX screen when you press this while playing back.

## 13 ◀ / ▶ / ▲ / ▼ / ENTER

When you press any button, the orange frame appears on the LCD screen. Select a desired button or an item with ◀ / ▶ / ▲ / ▼, then press ENTER to enter.

- Point the Remote Commander towards the remote sensor to operate your camcorder (p.35).
- When no commands have been sent from the Remote Commander in a certain period, the orange frame disappears. When you press any of ◀ / ▶ / ▲ / ▼, or ENTER again, the frame appears at the position where it was displayed last.
- To change the battery, see page 96.

# Playing the image on a TV

Connect your camcorder to the input jack of TV or VCR using A/V connecting cable **1** or A/V connecting cable with S VIDEO **2**. Connect your camcorder to the wall socket using the supplied AC Adaptor for this operation (p.14). Refer also to the instruction manuals supplied with the devices to be connected.

- To view the recorded images on a computer, see “Computer Application Guide”.

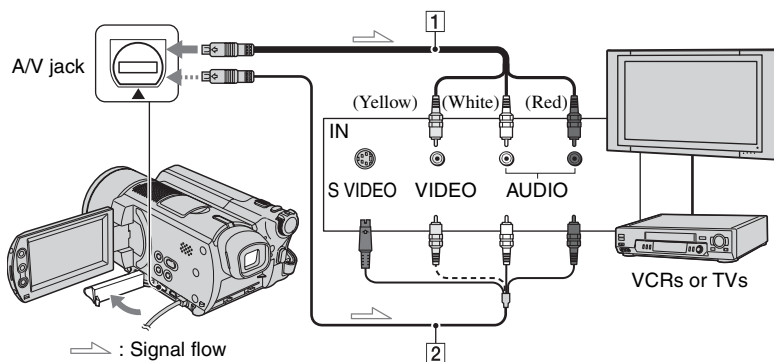

## **1** A/V connecting cable (supplied)

Connect to the input jack of the other device.

## **2** A/V connecting cable with S VIDEO (optional)

When connecting to another device via the S VIDEO jack, by using an A/V connecting cable with an S VIDEO cable (optional), higher quality images can be produced than with an A/V connecting cable. Connect the white and red plug (left/right audio) and the S VIDEO plug (S VIDEO channel) of the A/V connecting cable with an S VIDEO cable (optional). The yellow plug connection is not necessary. S VIDEO connection only will not output audio.

## When your TV is connected to a VCR

Connect your camcorder to the LINE IN input on the VCR. Set the input selector on the VCR to LINE (VIDEO 1, VIDEO 2, etc.), if the VCR has an input selector.

## To set the aspect ratio according to the connected TV (16:9/4:3)

Change the setting according to the screen aspect ratio of the TV you will view images on.

- ① Slide the POWER switch to light up the (PLAY/EDIT) lamp.
- ② Touch **[P-MENU]** → **[SETUP]** → STANDARD SET → **[TV TYPE]** → **[16:9]** or **[4:3]** → **[OK]**.

- When you set [TV TYPE] to [4:3], the image quality may deteriorate. Also, when the recorded image's aspect ratio switches between 16:9 (wide) and 4:3, the image may jitter.
- If you connect the camcorder to a TV, you cannot play back images with 5.1ch surround sound. Using the supplied computer applications (“Computer Application Guide”), you can create a DVD containing movies with the 5.1ch surround sound on an appropriate device.



- On some 4:3 TVs, the still images recorded in 4:3 aspect ratio may not be displayed full screen. This is not a malfunction.



- When you play back an image recorded in 16:9 (wide) aspect ratio on a 4:3 TV not compatible with the 16:9 (wide) signal, set [TV TYPE] to [4:3].

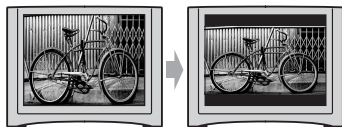

### When your TV is monaural (When your TV has only one audio input jack)

Connect the yellow plug of the A/V connecting cable to the video input jack and connect the white (left channel) or the red (right channel) plug to the audio input jack of your TV or VCR.

- You can display the counter on the TV screen by setting [DISP OUTPUT] to [V-OUT/PANEL] (p.62).

### If your TV/VCR has a 21-pin adaptor (EUROCONNECTOR)

Use a 21-pin adaptor (optional) to view playback image.

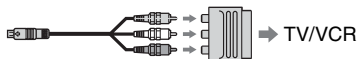

# Saving images

Recorded images are stored on the internal hard disk of the camcorder. Due to some limitations on the internal hard disk, make sure that you save the image data to the external media. You can save the images recorded on the camcorder as described below.

## Saving images on DVD using your computer

By using the software in the supplied CD-ROM, you can save images recorded on the camcorder. For details, see "Computer Application Guide".

### Create DVD with One Touch

You can save images recorded on the camcorder directly to a DVD with ease.



See "Computer Application Guide".

### Create DVD with the desired images

You can save images copied to your computer on a DVD. You can also edit the images.



See "Computer Application Guide".

## Saving images by connecting the camcorder to other VCR/DVD devices

You can save images recorded on the camcorder by connecting to other VCR/DVD devices.

### Dub to VCR/DVD devices

You can save the images recorded on the camcorder by connecting the camcorder to VCR/DVD devices.



See "Dubbing to VCR/DVD devices" on page 69.

# Deleting images

You can provide free hard disk space by deleting image data on the camcorder.

- You can check the free hard disk space of the camcorder on [HDD INFO] (p.57).
- Protected images cannot be deleted. To delete the images, cancel the protection (p.68).
- Important data should be saved (p.42).
- Do not delete the image data on the hard disk of the camcorder from your computer.

## Deleting the desired images

### 1 Slide the POWER switch to light up the (PLAY/EDIT) lamp.

The VISUAL INDEX screen appears on the LCD screen.

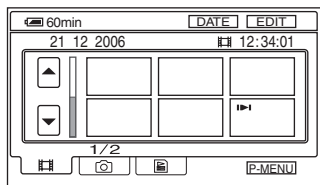

### 2 Select the (Movie) tab or the (Still) tab that includes the image you want to delete, then touch [EDIT].

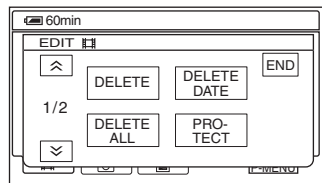



- When you touch [EDIT] during Easy Handycam operation, only [DELETE], [DELETE ALL] and [DELETE DATE] appears (p.26).

### 3 Touch [DELETE].

### 4 Select the image to be deleted.

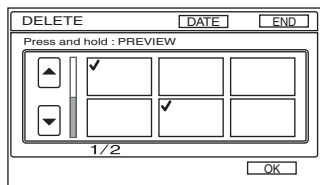
The selected image is marked with .





- Press and hold the movie on the LCD screen to check the movie (Preview). Touch  to return to the previous screen. The Preview screen buttons have the same functions as the ones on the Review screen (p.36).
- You can select multiple images at the same time.

### 5 Touch → [YES].

- You cannot recover an image once you delete it.

- If you delete an original movie that is listed in a Playlist (p.65), it is also deleted from the Playlist.

## To delete all movies or still images at once

- ① To delete a movie, touch  (Movie) tab, to delete still images, touch  (Still) tab on the VISUAL INDEX screen.
- ② Touch [EDIT] → [DELETE ALL] → [YES] → [YES].

- Protected images cannot be deleted (p.67).
- To recover all the recordable space of hard disk, perform [HDD FORMAT] (p.57).

## Deleting images (continued)

### Deleting images by date

You can delete movies or still images by date at once.

- 1 Slide the **POWER** switch to light up the **▶ (PLAY/EDIT)** lamp.

The **VISUAL INDEX** screen appears on the LCD screen.

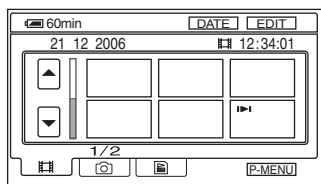

- 2 To delete movies, touch **🎬 (Movie)** tab. To delete still images, touch **📷 (Still)** tab.

- 3 Touch **[DATE]**.

The recording dates of images are displayed on the screen.

Return to the **VISUAL INDEX** screen

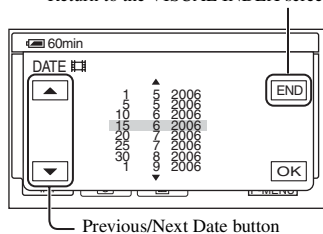

- 4 Touch **Previous/Next Date** button to select the date of the desired image.

- 5 Touch **[OK]** while the selected date of the desired image is highlighted.

Go back to the **VISUAL INDEX** screen.

- 6 Touch **[EDIT]**, then touch **[DELETE DATE]** → **[YES]**.

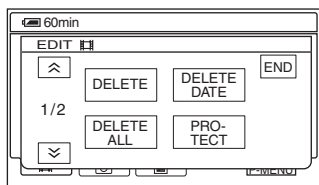

Delete movies or still images recorded on the selected date at once.

- You cannot delete movies and still images recorded on the same date at the same time.
- You cannot delete protected images (p.67).
- When the multiple number of the same date is displayed in step 3, only the image data in the selected date folder can be deleted.



# Using the Setup items

- Slide the **POWER** switch in the direction of the arrow repeatedly to light up the respective lamp.

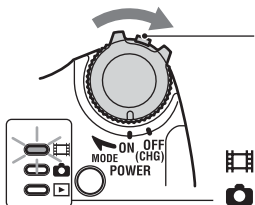

Slide the **POWER** switch while pressing the green button in the center only when the **POWER** switch is in the **OFF (CHG)** position.

- : Settings for movies
- : Settings for still images
- : Settings for **PLAY/EDIT**

- Touch the **LCD** screen to select the setup item.

Unavailable items will be grayed out.

## ■ To use the short-cuts of Personal Menu

On Personal Menu, short-cuts for frequently used setup items are added.

- You can customize Personal Menu as you like (p.63).

- Touch **P-MENU**.

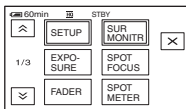

- Touch the desired setup item.

If the desired setup item is not displayed on the screen, touch / until it is displayed.

- Select the desired setting, then touch **OK**.

## ■ To change the setup items

You can customize setup items that are not added to Personal Menu.

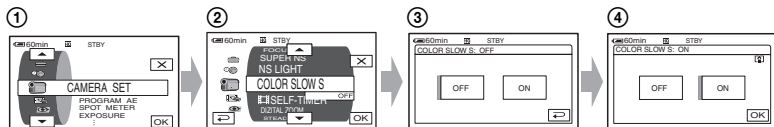

- ① Touch **[P-MENU]** → **[SETUP]**.
- ② Select the desired setup item.  
Touch **[▲]** / **[▼]** to select the item, then touch **[OK]**. (The process in step ③ is the same as that in step ②.)
- ③ Select the desired item.
  - You can also touch the item directly to select it.
- ④ Customize the item.  
After finishing the settings, touch **[OK]** → **[X]** (close) to hide the setup screen.  
If you decide not to change the setting, touch **[↶]** to return to the previous screen.

## ■ To change the setup items during Easy Handycam operation

**[P-MENU]** does not appear during Easy Handycam operation (p.22).

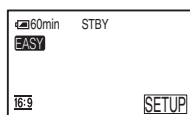

- ① Touch **[SETUP]**.  
Available setup items appear.
- ② Select the desired item.
- ③ Customize the item.  
Touch **[OK]** after finishing the setting.  
If you decide not to change the setting, touch **[↶]** to return to the previous screen.
  - Cancel the Easy Handycam operation (p.25) to change the setup items for the standard operation.

# Setup items

Available setup items (●) vary depending on the operating mode. The following settings are made automatically during Easy Handycam operation (p.22).

Position of lamp: Movie Still PLAY/EDIT **Easy Handycam**

## CAMERA SET (p.50)

PROGRAM AE	●	●	–	AUTO
SPOT METER	●	●	–	AUTO
EXPOSURE	●	●	–	AUTO
WHITE BAL.	●	●	–	AUTO
AUTO SHUTTER	●	–	–	ON
SPOT FOCUS	●	●	–	AUTO
FOCUS	●	●	–	AUTO
FLASH SET	–	●	–	⚡ *1/OFF
SUPER NS	●	–	–	OFF
NS LIGHT	●	●	–	OFF
COLOR SLOW S	●	–	–	OFF
SELF-TIMER	●	–	–	OFF
SELF-TIMER	–	●	–	OFF
DIGITAL ZOOM	●	–	–	OFF
STEADYSHOT	●	–	–	ON

## STILL SET (p.54)

BURST	–	●	–	OFF
QUALITY	–	●	–	FINE
IMAGE SIZE	–	●	–	●

## PICT. APPLI. (p.55)

FADER	●	–	–	OFF
D. EFFECT	●	–	–	OFF
PICT. EFFECT	●	–	–	OFF
REC CTRL *3	–	–	●	–
USB SELECT *2	●	●	●	–
DEMO MODE	●	–	–	ON



## HDD SET (p.57)

HDD FORMAT	●	●	●	●
HDD INFO	●	●	●	–
DROP SENSOR	●	●	●	ON
EMPTY HDD	●	●	●	–



Position of lamp:

 Movie Still PLAY/EDIT**Easy Handycam** **STANDARD SET** (p.59)

REC MODE	●	–	–	HQ
VOLUME	–	–	●	●*1
MULTI-SOUND	–	–	●	STEREO
MICREF LEVEL	●	–	–	NORMAL
SUR MONITOR	●	–	–	–
LCD/VF SET	●	●	●	–/NORMAL/–/ NORMAL/–*1
TV TYPE	●	●	●	–
USB SPEED	●	●	●	–*1
DATA CODE	–	–	●	DATE/TIME
 DISPLAY	–	–	●	–*1
 REMAINING	●	–	–	AUTO
REMOTE CTRL	●	●	●	ON
REC LAMP	●	●	–	ON
BEEP	●	●	●	●*1
DISP OUTPUT	●	●	●	LCD PANEL
SETUP ROTATE	●	●	●	–
A.SHUT OFF	●	●	●	5min
CALIBRATION	–	–	●	–

 **TIME/LANGU.** (p.62)

CLOCK SET	●	●	●	●*1
AREA SET	●	●	●	–*1
SUMMERTIME	●	●	●	–*1
LANGUAGE	●	●	●	–*1

\*1 The setting values before Easy Handycam operation are maintained.

\*2 [USB SELECT] appears automatically when your camcorder is connected to a computer or other device with the USB cable.

\*3 For DCR-SR100E only.

# CAMERA SET

## Settings to adjust your camcorder to the recording conditions (EXPOSURE/WHITE BAL./STEADYSHOT, etc.)

The default settings are marked with ►.  
The indicators in parentheses appear when the items are selected.  
See page 46 for details on selecting setup items.

### PROGRAM AE

You can record images effectively in various situations with the PROGRAM AE function.

#### ► AUTO

Select to automatically record images effectively without the [PROGRAM AE] function.

#### SPOTLIGHT\* (☹)



Select to prevent people's faces from appearing excessively white when subjects are lit by strong light.

#### PORTRAIT (Soft portrait) (☺)



Select to bring out the subject such as people or flowers while creating a soft background.

#### SPORTS\* (Sports lesson) (⚡)



Select to minimize shake when shooting fast moving subjects.

#### BEACH&SKI\* (🌴)



Select to prevent people's faces from appearing dark in strong light or reflected light, such as at a beach in midsummer or on a ski slope.

#### SUNSET&MOON\*\* (☾)



Select to maintain the atmosphere of situations such as sunsets, general night views or fireworks.

#### LANDSCAPE\*\* (🏞)



Select to shoot distant subjects clearly. This setting also prevents your camcorder from focusing on glass or metal mesh in windows that comes in between the camcorder and the subject.

- Items with one asterisk (\*) can be adjusted so as not to focus on subjects only a short distance away. Items with two asterisks (\*\*) can be adjusted to focus on subjects farther away.
- The setting returns to [AUTO] after you remove the power source for more than five minutes.

### SPOT METER (Flexible spot meter)

You can adjust and fix the exposure to the subject, so that it is recorded in suitable brightness even when there is strong contrast between the subject and the background, such as subjects in the spotlight on stage.

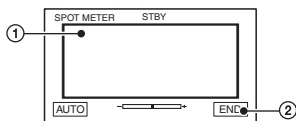

- ① Touch the point where you want to fix and adjust the exposure on the screen.  
↔ appears.
- ② Touch [END].

To return the setting to automatic exposure, touch [AUTO]→[END].

- If you set [SPOT METER], [EXPOSURE] is automatically set to [MANUAL].
- The setting returns to [AUTO] after you remove the power source for more than five minutes.

## EXPOSURE

You can fix the brightness of an image manually. When recording indoors on a clear day, for example, you can avoid backlight shadows on people next to the window by fixing the exposure to that of the wall side of the room.

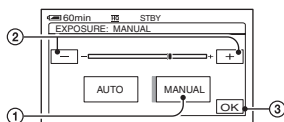

- ① Touch [MANUAL].  
→ appears.
- ② Adjust the exposure by touching / .
- ③ Touch .

To return the setting to automatic exposure, touch [AUTO] → .

- If you rotate the LCD panel 180 degrees and close the LCD panel with the screen facing outwards, you can adjust [FADER] and [EXPOSURE] while looking through the viewfinder (p.56).
- The setting returns to [AUTO] after you remove the power source for more than five minutes.

## WHITE BAL. (White balance)

You can adjust the color balance to the brightness of the recording environment.

### ► AUTO

The white balance is adjusted automatically.

### OUTDOOR ( )

The white balance is adjusted to be appropriate for the following recording conditions:

- Outdoors
- Night views, neon signs and fireworks
- Sunrise or sunset
- Under daylight fluorescent lamps

### INDOOR ( )

The white balance is adjusted to be appropriate for the following recording conditions:

- Indoors
- At party scenes or studios where the lighting conditions change quickly
- Under the video lamps of those at a studio, or under sodium lamps or incandescent-like color lamps

### ONE PUSH ( )

The white balance will be adjusted according to the ambient light.

- ① Touch [ONE PUSH].
- ② Frame a white object such as a piece of paper, to fill the screen under the same lighting conditions as you will shoot the subject.
- ③ Touch .  
 flashes quickly. When the white balance has been adjusted and stored in the memory, the indicator stops flashing.
  - Keep framing white object while is flashing quickly.
  - flashes slowly if white balance could not be set.
  - keeps flashing even after you have touched , set [WHITE BAL.] to [AUTO].

- When you have changed the battery pack while [AUTO] is selected, or you bring your camcorder outdoors from inside the house while using fixed exposure, select [AUTO] and aim your camcorder at a nearby white object for about 10 seconds for better color balance adjustment.
- Redo the [ONE PUSH] procedure if you change the [PROGRAM AE] settings, or bring your camcorder outdoors from inside the house, or vice versa during the [ONE PUSH] is set to on.
- Set [WHITE BAL.] to [AUTO] or [ONE PUSH] under white or cool white fluorescent lamps.
- The setting returns to [AUTO] after you remove the power source for more than five minutes.

## AUTO SHUTTER

Automatically activates the electronic shutter to adjust the shutter speed when recording in bright conditions if you set it to [ON] (the default setting).

## SPOT FOCUS

You can select and adjust the focal point to aim it at a subject not located in the center of the screen.

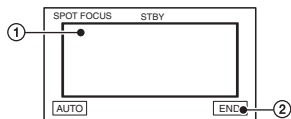

① Touch the subject on the screen.  
 F appears.

② Touch [END].

To adjust the focus automatically, touch [AUTO]→[END] in step ①.

- If you set [SPOT FOCUS], [FOCUS] is automatically set to [MANUAL].
- The setting returns to [AUTO] after you remove the power source for more than five minutes.

## FOCUS

You can adjust the focus manually. Select this when you want to focus on a certain subject intentionally.



① Touch [MANUAL].  
 F appears.

② Touch (focusing on close subjects)/  
 (focusing on distant subjects) to sharpen the focus.  
 A person icon appears when the focus cannot be adjusted any closer, and a triangle icon appears when the focus cannot be adjusted farther away.

③ Touch [OK].

To adjust the focus automatically, touch [AUTO]→[OK] in step ①.

- It is easier to focus on the subject by moving the power zoom lever towards T (telephoto) to adjust the focus, then towards W (wide angle) to adjust the zoom for recording. When you want to record a subject at close range, move the power zoom lever to W (wide angle), then adjust the focus.
- The minimum distance required between your camcorder and the subject to get a sharp focus is about 1 cm (about 1/2 inch) for wide angle and about 80 cm (about 2 5/8 feet) for telephoto.
- The setting returns to [AUTO] after you remove the power source for more than five minutes.

## FLASH SET

You can set this function when you use the built-in flash or an external flash (optional) that is compatible with your camcorder.

### FLASH LEVEL

#### HIGH (⚡+)

Makes the flash level higher.

#### ▶ NORMAL (⚡)

#### LOW (⚡-)

Makes the flash level lower.

- The setting returns to [NORMAL] after you remove the power source for more than five minutes.

### REDEYE REDUC

You can prevent redevye by activating the flash before recording.

Set [REDEYE REDUC] to [ON], then press ⚡ (flash) (p.32) repeatedly to select a setting.

👁️ (Auto redevye reduction): Pre-flashes to reduce redevye before the flash automatically flashes when there is insufficient ambient light.



👁️ ⚡ (Forced redevye reduction): Always uses the flash and the redevye reducing pre-flash.



🚫 (No flash): Records without flash.

- The redevye reduction may not produce the desired effect due to individual differences and other conditions.

- The setting returns to [OFF] after you remove the power source for more than five minutes.

## SUPER NS (Super NightShot)

You can record images at a maximum of 16 times the sensitivity of NightShot in dark places.

Set [SUPER NS] to [ON] while the NIGHTSHOT switch is set to ON.  and [“SUPER NS”] flash on the screen.

To cancel the setting, set [SUPER NS] to [OFF].

- Do not use NightShot and [SUPER NS] in bright places. This may cause a malfunction.
- Do not cover the infrared port with your fingers or other objects (p.32).
- Remove the conversion lens (optional).
- Adjust the focus manually ([FOCUS], p.52) when it is hard to focus automatically.
- The shutter speed of your camcorder changes depending on the brightness. The motion of the image may slow down at this time.

## NS LIGHT (NightShot Light)

You can record clearer images with the light which emits infrared light while using NightShot. The default setting is [ON].

- Do not cover the infrared port with your fingers or other objects (p.32).
- Remove the conversion lens (optional).
- The maximum shooting distance using [NS LIGHT] is about 3 m (10 feet).

## COLOR SLOW S (Color Slow Shutter)

You can record an image brighter in color even in dark places.

Set [COLOR SLOW S] to [ON].  and [COLOR SLOW SHUTTER] flash on the screen.

To cancel [COLOR SLOW S], touch [OFF].



- Adjust the focus manually ([FOCUS], p.52), when it is hard to focus automatically.

- The shutter speed of your camcorder changes depending on the brightness. The motion of the image may slow down at this time.

## SELF-TIMER

The self-timer starts recording a movie after about 10 seconds.

Press START/STOP when

 SELF-TIMER] is set to [ON] ().



To cancel the count down, touch [RESET].

To cancel the self-timer, select [OFF].

- You can also use the self-timer with START/STOP on the Remote Commander (p.39).

## SELF-TIMER

The self-timer starts recording a still image after about 10 seconds.

Press PHOTO when [ SELF-TIMER] is set to [ON] ().

To cancel the count down, touch [RESET].

To cancel the self-timer, select [OFF].

- You can also use the self-timer with PHOTO on the Remote Commander (p.39).

## DIGITAL ZOOM

You can select the maximum zoom level in case you want to zoom to a level greater than 10×(the default setting) while recording. Note that the image quality decreases when you are using the digital zoom.

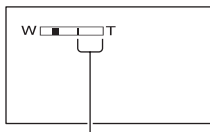

The right side of the bar shows the digital zooming factor. The zooming zone appears when you select the zooming level.

## ▶ OFF

Up to 10 × zoom is performed optically.

## 20 ×

Up to 10 × zoom is performed optically, and after that up to 20 × zoom is performed digitally.

## 120 ×

Up to 10 × zoom is performed optically, and after that, up to 120 × zoom is performed digitally.

## STEADYSHOT

You can record images using [STEADYSHOT] (the default setting is [ON]). Set [STEADYSHOT] to [OFF] (OFF) when using a tripod or the conversion lens (optional).

## STILL SET

Settings for still images  
(BURST/QUALITY/IMAGE SIZE, etc.)

The default settings are marked with ▶. The indicators in parentheses appear when the items are selected.

See page 46 for details on selecting setup items.

## BURST

You can record several still images one after another by pressing PHOTO.

## ▶ OFF

Select this when not recording continuously.

## NORMAL ( )

Records still images continuously at approximately 0.5 seconds intervals. The numbers of the maximum recordable images are as follows:

3.0M (3.0M) : 3 images

1.9M (1.9M) : 4 images

VGA (0.3M) (VGA) : 21 images

2.3M (2.3M) : 3 images

## EXP. BRKTG (BRK)

Records 3 images consecutively with different exposures at approximately 0.5 second intervals. You can compare the three images and select an image recorded at the best exposure.

- The flash will not function during continuous recording.
- The maximum number of images will be recorded in the self-timer mode or when you are operating with the Remote Commander.
- You may not be able to record continuous images up to the maximum number depending on the image size and the remaining hard disk space of the camcorder.
- [EXP. BRKTG] does not function, if the hard disk space is only available for less than three still images.
- It takes longer to record continuous images to the hard disk compared to normal recording. Record the next still image after the scroll bar indicator (■■■■) and the ACCESS lamp turns off.

## QUALITY



### ► FINE (FINE)

Records still images at the fine image quality level.

### STANDARD (STD)

Records still images at the standard image quality level.

## The size of still images (Approx. kB)

	3.0M 	2.3M 	1.9M 	VGA (0.3M) 
FINE (FINE)	1540	1150	960	150
STANDARD (STD)	640	480	420	60

## IMAGE SIZE

### ► 3.0M ()



Records still images clearly.

### 1.9M ()

Allows you to record more still images in relatively clear quality.

### VGA (0.3M) ()

Allows for the maximum number of images to be recorded.

- When the aspect ratio is changed to 16:9 (wide), the image size is changed to [ 2.3M] () (p.21).
- The number of pixels for each image size is as follows:  
3.0M : 2016×1512  
1.9M : 1600×1200  
VGA (0.3M) : 640×480  
 2.3M : 2016×1134
- The maximum number of recordable still images is 9,999.

## PICT. APPLI.

Special effects on images or additional functions on recording/playback (PICT. EFFECT/D. EFFECT, etc.)

The default settings are marked with ►. The indicators in parentheses appear when the items are selected.

See page 46 for details on selecting setup items.

## FADER

You can add the following effects to currently recording images.

- During standby (fade in) or recording (fade out), select the desired effect, then touch . When you select [OVERLAP] or [WIPE], the image is stored as a still image. (While storing the image, the screen turns to blue.)
- Press START/STOP. The fader indicator stops flashing and disappears when the fade is complete.

To cancel the current setting before your operation, touch [OFF] in step ①. Once you press START/STOP, the setting is cancelled.



### WHITE FADER



### BLACK FADER



### OVERLAP (fade in only)





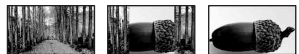



### WIPE (fade in only)



**Using the viewfinder**







You can adjust [EXPOSURE] and [FADER] while using the viewfinder by having the LCD screen rotated 180 degrees and closed with the screen facing out.

- ① Make sure the  (Movie) lamp lights up.
- ② Extend the viewfinder, and close the LCD screen with the screen facing out.  
 appears.
- ③ Touch .  
[Set LCD off?] appears on the screen.
- ④ Touch [YES].  
The LCD screen is turned off.
- ⑤ Touch the LCD screen while checking the display in the viewfinder.  
[EXPOSURE], etc. are displayed.
- ⑥ Touch the button you want to set.  
[EXPOSURE] : Adjust with  / , and touch .  
[FADER] : Touch it repeatedly to select a desired effect.  
 : The LCD screen lights up.

To hide the buttons, touch .

**D. EFFECT (Digital effect)**

You can add digital effects to your recordings.  appears.

- ① Touch the desired effect.
- ② When you select [LUMI. KEY], adjust the effect with  / , then touch .  
The image displayed when you touch  is saved as a still image.
- ③ Touch .  
 appears.

To cancel [D. EFFECT], touch [OFF] in step ①.

**LUMI. KEY (luminance key)**

Replaces a brighter area in a previously recorded still image (e.g. a person) with a movie.

**OLD MOVIE**

Adds an sepia colored effect to movies.

- The aspect ratio cannot be changed to 16:9 (wide) when [OLD MOVIE] is selected.

**PICT. EFFECT (Picture effect)**

You can add special effects to a picture during recording.  appears.

**▶ OFF**

Does not use [PICT. EFFECT] setting.

**SEPIA**

Picture appears in sepia.

**B&W**

Picture appears in black and white.

**PASTEL**

Picture appears like a pale pastel drawing.

**MOSAIC**

Picture appears mosaic-patterned.

**REC CTRL (DCR-SR100E)**

See page 71.

**USB SELECT**

You can copy images to a computer when connecting your camcorder to your computer with the USB cable or print still images when connecting to the PictBridge compliant printer (p.73).

**DVD BURN**

The item has the same function as DVD BURN button on the camcorder body. See "Computer Application Guide".



## HDD

By connecting the USB cable between the camcorder and a computer, you can access from the computer to the hard disk of the camcorder.

### PictBridge PRINT

See page 73.

- For details on a computer connection, see "Computer Application Guide".

## DEMO MODE

The default setting is [ON] so that you can view the demonstration in about 10 minutes, after you have set the POWER switch to  (Movie).

- The demonstration will be suspended in situations such as those described below.
  - when you touch the screen during the demonstration (The demonstration starts again in about 10 minutes.)
  - when you operate the buttons and switches
  - when the POWER switch is set to  (Still)
  - when you set the NIGHTSHOT switch to ON (p.32)

## HDD SET

### Settings for the hard disk (HDD FORMAT/HDD INFO, etc.)

See page 46 for details on selecting setup items.

## HDD FORMAT

You can delete all the images on the hard disk of the camcorder to recover recordable free space to allow you to write in.

- To avoid the loss of important images, they should be saved (p.42) before performing [HDD FORMAT].

① To perform [HDD FORMAT], touch [YES] → [YES].

② When [Completed.] is displayed, touch .

- Protected images are also deleted.
- While [HDD FORMAT] is activated, do not remove the AC Adaptor or the battery pack.
- While [HDD FORMAT] is activated, do not apply vibration or shock.

## HDD INFO

The hard disk information of the camcorder can be displayed to allow you to check approximate used and free spaces.

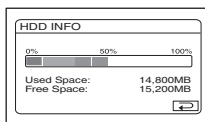

- The calculation for hard disk space is 1MB = 1,048,576. The fractions less than MB are discarded when the hard disk space is displayed. Only the figures that are less than 30,000 MB for available and unavailable hard disk spaces appear.
- Since there is the management file area, the used space is not displayed as 0MB when you perform [HDD FORMAT] or [EMPTY HDD].

## DROP SENSOR







The [DROP SENSOR] is set to [ON] as the default setting. When the drop sensor senses a drop of the camcorder ( appears), you may not record/play back the images to protect the internal hard disk.

- Set the drop sensor to [ON] (default setting) when you use the camcorder. Otherwise when you drop the camcorder, you may damage the hard disk of the camcorder.
- In a non-gravity situation, the drop sensor activates. When you record images during activity such as roller-coasting or skydiving, you can set [DROP SENSOR] to [OFF] () not to activate the dropsensor.
- [DROP SENSOR] is automatically set to [ON] after you remove the power source for more than five minutes.

## EMPTY HDD

[EMPTY HDD] allows you to write non important data onto the hard disk of the camcorder. In this way, it may become more difficult to recover any original data. When you dispose or transfer the camcorder to others, it is recommended that you perform [EMPTY HDD].

- If you perform [EMPTY HDD], all the images are deleted. To avoid the loss of important images, they should be saved (p.42) before performing [EMPTY HDD].

- ① Be sure the AC Adaptor is connected. While pressing DISP/BATT INFO, slide the POWER switch to turn on.
  - You can perform this operation, whichever position of the  (Movie) /  (Still) /  (PLAY/EDIT) is lit.
- ② Touch  →  HDD SET → [EMPTY HDD] → [YES] → [YES].
- ③ When [Completed.] is displayed, touch .

- If you do not follow the instructions above to turn on the switch, [EMPTY HDD] cannot be displayed on the set up items.
- The actual performing time for [EMPTY HDD] is approximately 30 minutes.
- Remove all cables except the AC Adaptor. Do not remove the AC Adaptor during the operation.
- While performing [EMPTY HDD], do not apply any vibrations or shocks.
- When you have cancelled [EMPTY HDD] during the operation, perform [HDD FORMAT] or [EMPTY HDD] when you use the camcorder for the next time.
- Protected images (p.67) are also deleted.



## STANDARD SET

### Settings while recording or other basic settings (REC MODE/LCD/VF SET/USB SPEED, etc.)

The default settings are marked with ►.  
The indicators in parentheses appear when the item is selected.

See page 46 for details on selecting setup items.

#### REC MODE (Recording mode)

You can select an image quality of the movie from three levels.

##### ► HQ (HQ)

Records in high quality mode (approx. recordable time is up to 7 hours 20 min.).

##### SP (SP)

Records in standard quality mode (approx. recordable time is up to 10 hours 50min.).

##### LP (LP)

Increases the recording time (Long Play) (approx. recordable time is up to 20 hours 50 min.).

- The remaining recordable time is displayed on the screen.
- The maximum number of recordable movies is 9,999.
- If you record in the LP mode, the quality of scenes may be degraded, or scenes with quick movements may appear with a block noise when you play back the images.

#### VOLUME

See page 29.

#### MULTI-SOUND

You can select whether to play back audio recorded using [REC CTRL](p.71) with dual sound or stereo sound.

##### ► STEREO

Plays back with main and sub sound (or stereo sound).

##### 1

Plays back with main sound or the left channel sound.

##### 2

Plays back with sub sound or the right channel sound.

- The setting returns to [STEREO] after you remove the power source for more than five minutes.

#### MICREF LEVEL

You can select the microphone level for recording sound.  
Select [LOW] when you want to record exciting and powerful sound in a concert hall, etc.

##### ► NORMAL

Records various surround sounds, converting them into the same level.

##### LOW (f)

Records surround sound faithfully. This setting is not suitable for recording conversations.

- The setting returns to [NORMAL] after you remove the power source for more than five minutes.

#### SUR MONITOR

You can display the direction from which the recording sound comes when recording in 5.1ch mode.

**LCD/VF SET**

The recorded image will not be affected even when you change the setting.

**LCD BRIGHT**

You can adjust the brightness of the LCD screen.

- Adjust the brightness with  $\square$  /  $\square$ .
- Touch  $\square$ .

**LCD BL LEVEL**

You can adjust the brightness of the LCD screen's backlight.

**► NORMAL**

Standard brightness.

**BRIGHT**

Brightens the LCD screen.

- When you use the AC Adaptor as the power source, [BRIGHT] is automatically selected for the setting.
- When you select [BRIGHT], battery life is slightly reduced during recording.

**LCD COLOR**

You can adjust the color on the LCD screen with  $\square$  /  $\square$ .



Low intensity

High intensity

**VF B.LIGHT**

You can adjust the brightness of the viewfinder.

**► NORMAL**

Standard brightness.

**BRIGHT**

Brightens the viewfinder screen.

- When you connect your camcorder to AC Adaptor, [BRIGHT] is automatically selected for the setting.
- When you select [BRIGHT], battery life is slightly reduced during recording.

**VF WIDE DISP**

You can select how a 16:9 (wide) aspect ratio image appears in the viewfinder.

**► LETTER BOX**

Normal setting (standard type of screen)

**SQUEEZE (Squeeze)**

Expands the image vertically if black bands at the top and bottom in 16:9 (wide) aspect ratio are undesirable.

**TV TYPE**

See page 40.

**USB SPEED**

You can select data transfer speed used to transfer data to your computer.

**► AUTO**

Sends data by switching automatically between the Hi-Speed USB (USB 2.0) and the speed corresponding to USB1.1 (full speed transfer).

**FULL SPEED**

Sends data corresponding to USB1.1 (full speed transfer).

**DATA CODE**

You can check the information recorded automatically (data code) during playback.

**► OFF**

Data code is not displayed.

**DATE/TIME**

Displays the date and time of recorded images.

**CAMERA DATA**

Displays the camera setting data of recorded images.

## DATE/TIME

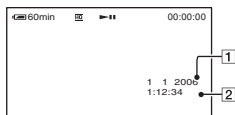

- 1 Date  
2 Time

## CAMERA DATA

Movie

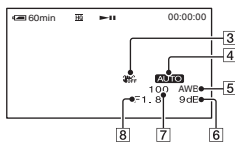

Still image

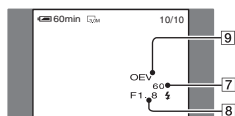

- 3 SteadyShot off  
4 Exposure  
5 White balance  
6 Gain  
7 Shutter speed  
8 Aperture value  
9 Exposure value

- appears for an image recorded using a flash.
- The data code is displayed on the TV screen, if you connect your camcorder to a TV.
- The indicator toggles through the following sequences as you press DATA CODE on the Remote Commander: DATE/TIME → CAMERA DATA → OFF (no indication).
- Depending on the hard disk condition of the camcorder, bars [---:---] appear.
- The setting returns to [OFF] after you remove the power source for more than five minutes.

## DISPLAY

You can select the number of thumbnails that appear on the VISUAL INDEX screen. Thumbnail Glossary (p.100)

## ZOOM LINK

Change the number of thumbnails (6 or 12) with the zoom lever on your camcorder.\*

### 6IMAGES

Displays thumbnails of 6 images.

### 12IMAGES

Displays thumbnails of 12 images.

\* You can operate with the zoom buttons on the LCD frame or on the Remote Commander.

## REMAINING

### AUTO

Displays the remaining hard disk free space for about eight seconds as described below.

- When your camcorder recognizes the free hard disk space, with the POWER switch is set to (Movie)
- When you press DISP/BATT INFO to switch the screen display from off to on, with the POWER switch is set to (Movie)
- When the available free space of the hard disk remains less than five minutes for movies
- When you start recording from the line input (For DCR-SR100E only)

### ON

Always displays the remaining hard disk free space indicator.

## REMOTE CTRL (Remote control)

The default setting is [ON] so that you can use the supplied Remote Commander (p.39).

- Set to [OFF] to prevent your camcorder from responding to a command sent by other device's remote control.
- The setting returns to [ON] after you remove the power source for more than five minutes.

## REC LAMP (Recording lamp)

The camera recording lamp will not light up during recording when you set this to [OFF]. (The default setting is [ON].)

**(CLOCK SET/AREA SET/LANGUAGE, etc.)**

See page 46 for details on selecting setup items.

## BEEP

### ▶ ON

A melody sounds when you start/stop recording, or operate the touch panel.

### OFF

Cancels the melody.

## DISP OUTPUT

### ▶ LCD PANEL

Shows displays such as the counter on the LCD screen and in the viewfinder.

### V-OUT/PANEL

Shows the display also on the TV screen.

## SETUP ROTATE

### ▶ NORMAL

Scrolls the setup items downwards by touching .

### OPPOSITE

Scrolls the setup items upwards by touching .

## A.SHUT OFF (Auto shut off)

### ▶ 5min

The camcorder is automatically turned off, when you do not operate your camcorder for more than approximately 5 minutes.

### NEVER

The camcorder is not automatically turned off.

- When you connect your camcorder to a wall socket, [A.SHUT OFF] is automatically set to [NEVER].

## CALIBRATION

See page 95.

## CLOCK SET

See page 20.

## AREA SET

You can adjust a time difference without stopping the clock.

Set your local area with ▲/▼ when using your camcorder overseas.

Refer to “World time difference” on page 91.

## SUMMERTIME

You can change this setting without stopping the clock.

Set to [ON] to move the time forward one hour.

## LANGUAGE



You can select the language to be used on the LCD screen.

- Your camcorder offers [ENG[SIMP]] (simplified English) for when you cannot find your native tongue among the options.

# Customizing Personal Menu

You can add desired setup items to Personal Menu, and customize Personal Menu settings. This is convenient if you add frequently used setup items to Personal Menu.

## Adding a setup item

You can add up to 27 setup items for  (Movie),  (Still) or  (PLAY/EDIT). Delete a less important setup item, if you want to add more.

- 1 Touch **[P-MENU]** → **[P-MENU SET UP]** → **[ADD]**.

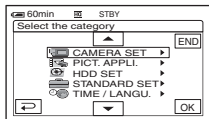

- 2 Touch **[▲]/[▼]** to select a setup category, then touch **[OK]**.

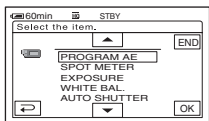

- 3 Touch **[▲]/[▼]** to select a setup item, then touch **[OK]** → **[YES]** → **[X]**.

The setup item is added to the end of list.

## Deleting a setup item

- 1 Touch **[P-MENU]** → **[P-MENU SET UP]** → **[DELETE]**.

If the desired setup item is not displayed, touch **[▲]/[▼]**.

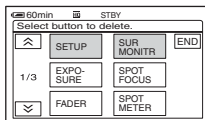

- 2 Touch the setup item that you want to delete.

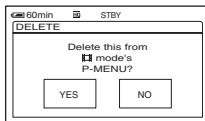

- 3 Touch **[YES]** → **[X]**.

- You cannot delete [SETUP] and [P-MENU SET UP].

### Arranging the order of setup items displayed on Personal Menu

- 1 Touch **[P-MENU]** → **[P-MENU SET UP]** → **[SORT]**.

If the desired setup item is not displayed, touch **[↑]**/**[↓]**.

- 2 Touch the setup item you want to move.

- 3 Touch **[↑]**/**[↓]** to move the setup item to the desired place.

- 4 Touch **[OK]**.

To sort more items, repeat step 2 to 4.

- 5 Touch **[END]** → **[X]**.

- You cannot move [P-MENU SET UP].

### Initializing the Personal Menu settings (Reset)

Touch **[P-MENU]** → **[P-MENU SET UP]** → **[RESET]** → **[YES]** → **[YES]** → **[X]**.



# Creating the Playlist

A Playlist is a list displaying your favorite movies selected from the original movies. Playlist  Glossary (p.99)

- Do not remove the battery pack or the AC Adaptor from your camcorder while editing the Playlist. It may damage the hard disk of the camcorder.
- You can add up to 99 scenes in the Playlist.
- You cannot add still images on the Playlist.
- If you delete the original image data from the camcorder, they are automatically deleted from the Playlist.



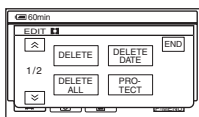

## 1 Slide the POWER switch to light up the (PLAY/EDIT) lamp.

The VISUAL INDEX screen appears.

## 2 Select (Movie) tab, then touch [EDIT].





## 3 Touch [ ADD ].

- Touch / to display [  ADD ] when [  ADD ] is not displayed.

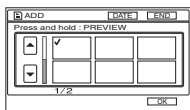
## 4 Select the scene to be added to the Playlist.



The selected scene is marked with .

- If you press and hold the thumbnail of the image, you can check the image. Touch  to return to the previous screen.
- You can select several images at once.

## 5 Touch [OK] → [YES].

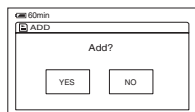

## To add all the images selected by date on the Playlist

Touch [  ADD DATE ] in step 3.

## Erasing unnecessary scenes from the Playlist

## 1 Slide the POWER switch to light up the (PLAY/EDIT) lamp.

The VISUAL INDEX screen appears.

## 2 Touch (Playlist) tab → [EDIT] → [ERASE].

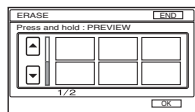

## 3 Select the scene to be deleted from the list.

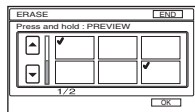

The selected scene is marked with .

- If you press and hold the thumbnail of the image, you can check the image. Touch  to return to the previous screen.
- You can select multiple images at once.

## Creating the Playlist (continued)

**4** Touch  OK → [YES].

### To erase all the scenes at the same time

Touch [ERASE ALL] in step 2 → [YES].

- The original images are not changed even if you erase the images from the Playlist.

## Changing the order within the Playlist

**1** Slide the **POWER** switch to light up the  (PLAY/EDIT) lamp.

The VISUAL INDEX screen appears on the LCD screen.

**2** Touch  (Playlist) tab → [EDIT] → [MOVE].

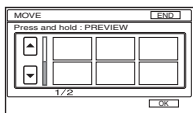

**3** Select the scene to be moved.

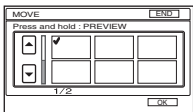

The selected scene is marked with ✓.

- If you press and hold the thumbnail of the image, you can check the image. Touch  to return to the previous screen.
- You can select several images at once.

**4** Touch  OK.

**5** Select the designated position with [←]/[→].

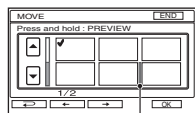

Move destination bar

**6** Touch  OK → [YES].

- When you have selected multiple scenes, the scenes are moved following the order appeared in the Playlist.

# Playing the Playlist

You can play the Playlist.

---

## 1 Slide the POWER switch to light up the (PLAY/EDIT) lamp.

The VISUAL INDEX screen appears on the LCD screen.

---

## 2 Touch (Playlist) tab.

A list of the scenes added in the Playlist appears.

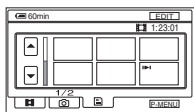

---

## 3 Touch the image from which you want to playback.

The screen returns to the VISUAL INDEX screen when the Playlist is played back from the selected scene to the end.

- You can save images in your Playlist on a DVD using a computer. For details, see "Computer Application Guide".

# Setting image protection (Protection)

You can protect selected images not to be deleted (p.43). By setting protection, you can prevent your images from being deleted by mistake.

## Protecting the desired image

You can set protection to an individual image.

---

## 1 Slide the POWER switch to light up the (PLAY/EDIT) lamp.

The VISUAL INDEX screen appears on the LCD screen.

---

## 2 Touch [EDIT] → [PROTECT].

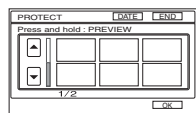

---

## 3 Touch the desired image you want to protect.

The selected image is marked with .

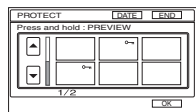

- You can select several images at once.
- If you press and hold the thumbnail of the image, you can check the image. Touch  to return to the previous screen.

---



## 4 Touch [OK] → [YES].

Protection on the image is set.

- 
- The protected image is marked with  on the VISUAL INDEX screen.

## Setting image protection (Protection) (continued)

### To cancel protection from the desired image

Touch the image marked with  in step 3.  mark disappears.

### To cancel protection from the desired image by date

Touch [EDIT] → [PROTCT DATE] → [OFF] in step 4.  does not appear on the images that are cancelled for protection.

## Protecting images by date

You can set protection for selected images by recording date.

### 1 Slide the POWER switch to light up the (PLAY/EDIT) lamp.

The VISUAL INDEX screen appears on the LCD screen.

### 2 Touch [DATE].

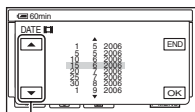

Previous/Next Date button

### 3 Select the desired date to protect with Previous/Next Date button, then touch .

Return to the VISUAL INDEX screen.

### 4 Touch [EDIT] → [PROTCT DATE] → [ON].

Set protection for all the images in the selected folder by date.

- Protected images are marked with  on VISUAL INDEX screen.

## Dubbing to VCR/DVD devices

You can save images on your camcorder to VCRs or DVD recorders. Connect your camcorder to the wall socket using the supplied AC Adaptor for this operation (p.14). Refer also to the instruction manuals supplied with the devices to be connected.

- To save image data on your computer or to save DVD using a computer, see “Computer Application Guide”.
- You cannot use the i.LINK cable.
- Since you dub your data to other device through analogue data, the image quality may decline.

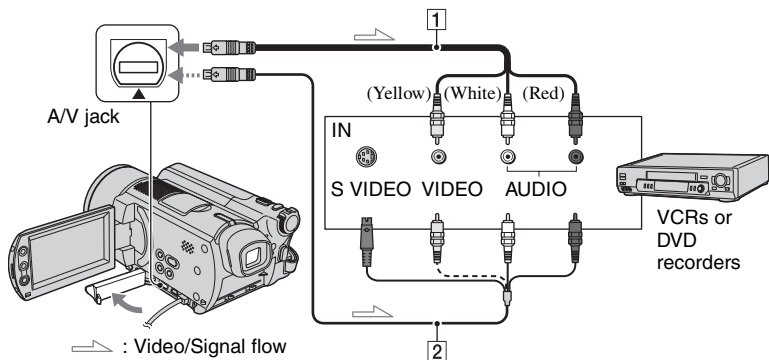

### 1 A/V connecting cable (supplied)

Connect to the input jack of the other device.

### 2 A/V connecting cable with S VIDEO (optional)

When connecting to another device via the S VIDEO jack, by using an A/V connecting cable with an S VIDEO cable (optional), higher quality images can be produced than with an A/V connecting cable. Connect the white and red plug (left/right audio) and the S VIDEO plug (S VIDEO channel) of the A/V connecting cable with an S VIDEO cable (optional). The yellow plug connection is not necessary. S VIDEO connection only will not output audio.

- To hide the screen indicators (such as a counter, etc.) on the screen of the monitor device connected, set [DISP OUTPUT] to [LCD PANEL] (the default setting, p.62).
- To record the date/time and camera settings data, display them on the screen (p.60).
- When you are connecting your camcorder to a monaural device, connect the yellow plug of the A/V connecting cable to the video input jack, and the red (right channel) or the white (left channel) plug to the audio input jack on the VCR or the TV.

### **1 Slide the POWER switch to light up the (PLAY/EDIT) lamp.**

Set [TV TYPE] according to the playback device (p.40).

---

### **2 Insert the recording media for your VCR or DVD recorder.**

If your recording device has an input selector, set it to the input mode.

---

### **3 Connect your camcorder to the VCR/DVD device with the A/V connecting cable (supplied) or the A/V connecting cable with S VIDEO (optional) .**

- Connect your camcorder to the input jacks of a VCR or DVD device.
- 

### **4 Start the playback on your camcorder, and record it on the recording device.**

Refer to the instruction manuals supplied with your recording device for details.

---

### **5 When dubbing is finished, stop your camcorder and the recording device.**

- After dubbing your images, it is recommended that you delete unnecessary images from the hard disk of the camcorder (p.43).

# Recording images from a TV or VCR/DVD device (For DCR-SR100E only)

You can record images or TV programs from a VCR, TV or DVD device onto the hard disk of camcorder.

Connect your camcorder to the wall socket using the supplied AC Adaptor for this operation (p.14). Refer also to the instruction manuals supplied with the devices to be connected.

- On your camcorder, you cannot view images copied from a computer.

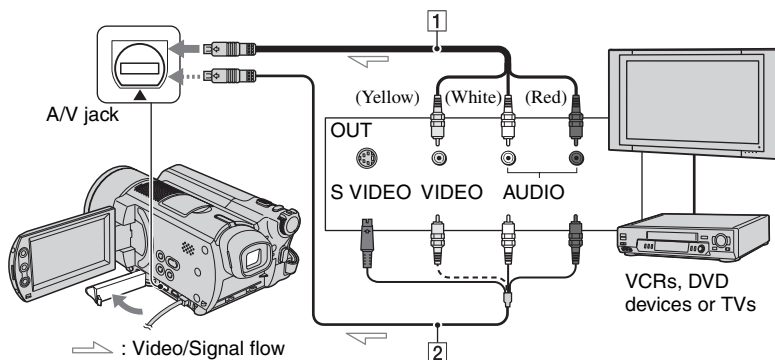

## 1 A/V connecting cable (supplied)

Connect to the output jack of the other device.

## 2 A/V connecting cable with S VIDEO (optional)

When connecting to another device via the S VIDEO jack, by using an A/V connecting cable with an S VIDEO cable (optional), higher quality images can be produced than with an A/V connecting cable. Connect the white and red plug (left/right audio) and the S VIDEO plug (S VIDEO channel) of the A/V connecting cable with an S VIDEO cable (optional). The yellow plug connection is not necessary. S VIDEO connection only will not output audio.

- You cannot record images from a TV with no output jacks.
- You cannot record TV programs which allow you to record once, or have copy control technology.
- When you are connecting your camcorder to a monaural device, connect the yellow plug of the A/V connecting cable to the video output jack, and the red (right channel) or the white (left channel) plug to the audio output jack on the VCR or the TV.
- Your camcorder can only record from a PAL source. For example, French video or TV programs (SECAM) cannot be recorded correctly. See page 90 for details on TV color systems.
- If you use a 21-pin adaptor to input PAL source, you need a dual direction 21-pin adaptor (optional).

## Recording images from a TV or VCR/DVD device (For DCR-SR100E only) (continued)

---

**1** Connect your camcorder to the TV or VCR/DVD device with the A/V connecting cable (supplied) **1** or the A/V connecting cable with S VIDEO (optional) **2**.

- Connect your camcorder to the output jacks of a TV or VCR/DVD device.

---

**2** If you are recording from a VCR/DVD device, insert the video tape or the DVD into the playback device.

---

**3** Slide the POWER switch to light up the  (PLAY/EDIT) lamp.

---

**4** Touch  → [REC CTRL].

If you connected your camcorder to the device which has the S VIDEO jack, touch [SET] → [VIDEO INPUT] → [S VIDEO] → .

- Touch [SET] to change the recording mode or adjust the volume.
- Touch [SET] →  REMAIN → [ON] to display the remaining hard disk free space indicator all the time.

---

**5** Start playing the cassette or the DVD on the play back device, or select a TV program.

The image played on the connected device appears on the LCD screen of your camcorder.

---

**6** Touch [REC] at the point you want to start recording.

---

**7** Touch  at the point you want to stop recording.

---

**8** Touch [END].

- 
- There may be a time difference between the point where you press [REC] and the actual point that the recording starts/stops.
  - You cannot record an image as a still image even if you press PHOTO during recording.



# Printing recorded still images

## (PictBridge compliant printer)

You can print out still images using a PictBridge compliant printer without connecting the camcorder to a computer.

### PictBridge



Connect your camcorder to the wall socket using the supplied AC Adaptor for this operation.

Turn on the power of the printer.

- To print still images after having copied them onto a computer, see “Computer Application Guide”.

### Connect your camcorder to the printer

#### 1 Slide the **POWER** switch to turn on.

- You can perform this operation, whichever position of the  (Movie) /  (Still) /  (PLAY/EDIT) is lit.

#### 2 Connect the (USB) jack of your camcorder to the printer using the USB cable (supplied).

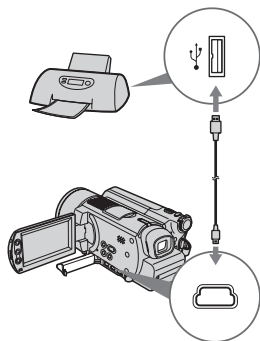



[USB SELECT] screen appears on the LCD screen.

#### 3 Touch [PictBridge PRINT].

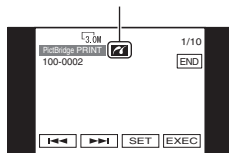
When connection is complete,  (PictBridge connecting) appears on the screen.



The still image appears.

- You can also display [USB SELECT] screen by touching  → [SETUP] →  PICT. APPLI. → [USB SELECT].
- We cannot guarantee the operation of models that are not PictBridge compatible.

### Printing

#### 1 Select the image to be printed with / .

#### 2 Touch [SET] → [COPIES].

#### 3 Select the number of copies to be printed with / .

You can set a maximum of 20 copies of one image to be printed.

#### 4 Touch → [END].

To print the date on the image, touch [SET] → [DATE/TIME] → [DATE] or [DAY&TIME] → .

### 5 Touch [EXEC] → [YES].

When printing is finished, [Printing...] disappears and the image selection screen appears again. You can continue to print other images.

---

### 6 When printing is finished, touch [END] → [END].

---

- Refer also to the instruction manual for the printer to be used.
- Do not attempt the following operations when  is on the screen. The operations may not be performed properly.
  - Operating the POWER switch
  - Removing the USB cable (supplied) from the printer
- If the printer stops working, remove the USB cable (supplied), turn the printer off and on again and restart the operation from the beginning.
- If you print a still image recorded with a 16:9 (wide) ratio, left and right ends of the image may be cut off.
- Some printer models may not support the date printing function. Refer to your printer's instruction manual for details.
- Still images that have a file size of 2 MB or more or are larger than 2304 × 1728 pixels cannot be printed.
- PictBridge is an industry standard established by the Camera & Imaging Products Association (CIPA). You can print still images without using a computer by connecting a printer directly to a digital video camera or digital still camera, regardless of model or manufacturer.

### To remove the USB cable from the camcorder and the printer

- ① Touch [END].
- ② Remove the USB cable from the camcorder and the printer.

# Jacks to connect external devices

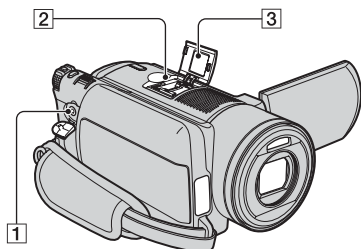

2

3

1

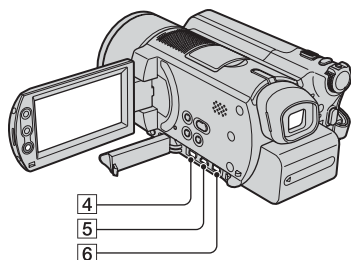

4

5

6

2 ...Open the shoe cover.

4 5 6 ...Open the jack cover.

## 1 REMOTE jack

- Connect other optional accessories.

## 2 Active Interface Shoe

The Active Interface Shoe supplies power to optional accessories such as a video light, a flash, or a microphone. The accessory can be turned on or off as you operate the POWER switch on your camcorder. Refer also to the instruction manual supplied with your accessory for details.

- The Active Interface Shoe has a safety device for fixing the installed accessory securely. To connect an accessory, press down and push it to the end, and then tighten the screw. To remove an accessory, loosen the screw, and then press down and pull out the accessory.
- When you are recording with the external flash (optional), turn off the power of the external flash to prevent charging noise being recorded.
- You cannot use an external flash (optional) and the built-in flash at the same time.
- When an external microphone (optional) is connected, it takes precedence over the internal microphone (p.33).

## 3 Shoe cover

4 A/V (audio/video) jack (p.40, 69, 71)

5  $\psi$  (USB) jack (p.73)

6 DC IN jack (p.14)

# Troubleshooting

If you run into any problems using your camcorder, use the following table to troubleshoot the problem. If the problem persists, remove the power source and contact your Sony dealer.

- For connecting your camcorder to your computer, see “Computer Application Guide”.

## Note before sending your camcorder for repair

- Your camcorder may be needed to initialize or change the current hard disk of the camcorder, depending on the problem. In the event of this, the data stored on the hard disk will be deleted. Be sure to save (backup) the data on the hard disk (p.42) on the other media before sending your camcorder to repair. We cannot guarantee any loss of your hard disk data.
- When repairing the camcorder, we may check a minimum amount of data stored on the hard disk in order to improve the condition. However, Sony dealer will neither copy nor save your data.

## Overall operations/Easy Handycam

### The camcorder does not operate even when the power is set to on.

- Remove the AC Adaptor from the wall socket or remove the battery pack, then reconnect it after about one minute. If the functions still do not work, press the RESET button (p.35) using a sharp-pointed object. (If you press the RESET button, all settings are reset, except the Personal Menu items.)
- The temperature of your camcorder is extremely high. Turn off your camcorder and leave it for a while in a cool place.
- The temperature of your camcorder is extremely low. Move it to a warm place and turn on the power after a little while.

### Buttons do not work.

- During Easy Handycam operation, the available buttons are limited. Cancel Easy Handycam operation (p.25).

### You cannot turn Easy Handycam operation on or off.

- You cannot turn Easy Handycam operation on or off while recording or communicating with another device via USB cable.

### Settings change during Easy Handycam operation.

- Some of the settings of your camcorder are restored to the default setting when you set Easy Handycam operation (p.22). The settings return to the ones before Easy Handycam operation when you cancel Easy Handycam operation (p.25).

### [DEMO MODE] does not start.

- You cannot view the demonstration when the NIGHTSHOT switch is set to ON. Set the NIGHTSHOT switch to OFF (p.32).
- Set the POWER switch to  (Movie).

### A vibration is felt in your hand or a faint sound is heard during operation.

- This is not a malfunction.

---

**Your camcorder gets warm.**

- This is because the power has been turned on for a long time. This is not a malfunction. Turn off your camcorder and leave it for a while in a cool place.

---

**Batteries/Power sources****The power does not turn on.**

- The battery pack is not attached to the camcorder. Attach a charged battery pack to the camcorder (p.14).
- The battery pack is discharged or running low. Charge the battery pack (p.14).
- The plug of the AC Adaptor has been removed from the wall socket. Connect it to the wall socket (p.14).

---

**The power abruptly turns off.**

- When approximately 5 minutes have elapsed while you do not operate your camcorder, the camcorder is automatically turned off (A.SHUT OFF). Change the setting of [A.SHUT OFF] (p.62), or turn on the power again, or use the AC Adaptor.
- The battery pack is discharged or running low. Charge the battery pack (p.14).

---

**The CHG (charge) lamp does not light while the battery pack is being charged.**

- Slide the POWER switch to OFF (CHG) (p.14).
- Attach the battery pack to the camcorder correctly (p.14).
- Connect the mains lead to the wall socket properly.
- The battery charge is completed (p.14).

---

**The CHG (charge) lamp flashes while the battery pack is being charged.**

- Attach the battery pack to the camcorder correctly (p.14). If the problem persists, remove the AC Adaptor from the wall socket and contact your Sony dealer. The battery pack may be damaged.

---

**The power turns off frequently although the remaining battery indicator indicates that the battery pack has enough power to operate.**

- A problem has occurred in the remaining battery time indicator, or the battery pack has not been charged enough. Fully charge the battery again to correct the indication (p.14).

---

**The remaining battery time indicator does not indicate the correct time.**

- The temperature of the environment is too high or too low. This is not a malfunction.
- The battery pack has not been charged enough. Fully charge the battery again. If the problem persists, replace the battery pack with a new one (p.14).
- The indicated time may not be correct depending on the environment of use. When you open or close the LCD screen, it takes about one minute to display the correct remaining battery time.

---

**The battery pack is quickly discharged.**

- The temperature of the environment is too high or low. This is not a malfunction.
- The battery pack has not been charged enough. Fully charge the battery again. If the problem persists, replace the battery pack with a new one (p.14).

### **A problem occurs when the camcorder is connected to the AC Adaptor.**

- Turn off the power, and remove the AC Adaptor from the wall socket. Then, connect it again.

## **LCD screen/viewfinder**

### **An unknown image appears on the screen.**

- The camcorder is in [DEMO MODE] (p.57). Touch the LCD screen.

### **An unknown indicator appears on the screen.**

- They may be warning indicators or messages (p.86).

### **The image remains on the LCD screen.**

- This occurs if you remove the AC Adaptor from the wall socket or remove the battery pack without turning off the power first. This is not a malfunction.

### **You cannot turn the LCD backlight off.**

- During Easy Handycam operation (p.22), you cannot turn the LCD backlight on/off pressing and holding DISP/BATT INFO. Cancel Easy Handycam operation (p.25).

### **The buttons do not appear on the touch panel.**

- Touch the LCD screen lightly.
- Press DISP/BATT INFO on your camcorder (or DISPLAY on the Remote Commander) (p.19, 39).

### **The buttons on the touch panel do not work correctly or do not work at all.**

- Adjust the screen ([CALIBRATION]) (p.95).
- If you change the aspect ratio of the image, the aspect ratio of the buttons of the touch panel and indicators will switch to the selected one (p.21).

### **The image in the viewfinder is not clear.**

- Extend the viewfinder (p.18).
- Use the viewfinder lens adjustment lever to adjust the lens (p.18).



### **The image in the viewfinder has disappeared.**

- The image is not displayed in the viewfinder when the LCD screen is open. Close the LCD screen (p.18).

## Recording

Refer also to “Adjusting the image during recording” (p.80).

### Pressing START/STOP or PHOTO does not record movies/still images.

- Slide the POWER switch to light up the  (Movie) or the  (Still) lamp.
- Your camcorder is recording the image you have just shot on the hard disk of the camcorder. You cannot press PHOTO while [CAPTURE] or  appears on the LCD screen (p.25, 28).
- The hard disk of the camcorder is full. Delete unnecessary images. Or perform [HDD FORMAT] (p.57).
- The temperature of your camcorder is extremely high. Turn off your camcorder and leave it for a while in a cool place.
- The temperature of your camcorder is extremely low. Turn on your camcorder and leave it for a while. If you still cannot operate the camcorder, move it to a warmer place.
- Moisture condensation has occurred. Turn off your camcorder and leave it for about one hour.
- The folder number shows 999, and the file number shows 9,999. Delete images (p.43) or perform [HDD FORMAT] (p.57).
- While activating [DROP SENSOR] (p.58), you may not record movies/still images.

### The ACCESS lamp lights up even when you stop recording.

- Your camcorder is recording the image you have just shot on the hard disk of the camcorder. Do not remove the AC Adaptor or the battery pack while the lamp is turned on.

### The recording angle differs depending on the POWER switch setting position.

- The recording angle for the still image is wider than the one for the movie.

### The shutter sound is not heard when you record a still image.

- Set [BEEP] to [ON] (p.62).

### The flash does not work.

- You cannot record with the flash with:
  - During recording movies
  - [SUPER NS]
  - [COLOR SLOW S]
  - [D. EFFECT]
  - [ BURST]
  - When the conversion lens attached
- The flash does not light up in the following cases even when you set [AUTO] or [REDEYE REDUC] in [FLASH SET]:
  - NightShot
  - [SPOTLIGHT], [SUNSET&MOON] or [LANDSCAPE] in [PROGRAM AE]
  - [EXPOSURE]
  - [SPOT METER]
- The power of the external flash (optional) is not turned on, or the flash is not attached correctly.

### **The actual recording time for movie is less than the expected approximate recording time.**

- When you record an object that moves fast, the time available for recording may shorten (p.15, 59).
- 

### **The recording stops.**

- The temperature of your camcorder is extremely high. Turn off your camcorder and leave it for a while in a cool place.
  - The temperature of your camcorder is extremely low. Turn on your camcorder and leave it for a while. If you still cannot record, take the camcorder to a warm place.
  - The maximum continuous recordable time is 12 hours.
  - If you keep applying vibration on the camcorder, recording may stop.
  - Fragmentation has occurred. Perform [HDD FORMAT] (p.57).
- 

### **There is a time difference between the point where you press START/STOP and the point that the recorded movie starts/stops.**

- On your camcorder, there may be a slight time difference between the point where you press START/STOP and the actual point that recording movie starts/stops. This is not a malfunction.
- 

## **Adjusting the image during recording**

Refer also to “Setup items” (p.82).

---

### **The auto focus does not function.**

- Set [FOCUS] to [AUTO] (p.52).
  - The recording conditions are not suitable for auto focus. Adjust the focus manually (p.52).
- 

### **[STEADYSHOT] does not function.**

- Set [STEADYSHOT] to [ON] (p.54).
  - [STEADYSHOT] may not work for an excessive camera shake even if [STEADYSHOT] is set to [ON].
- 

### **The back light function does not function.**

- The back light function is cancelled when you set [EXPOSURE] to [MANUAL] (p.51) or select [SPOT METER] (p.50).
  - The back light function does not work during Easy Handycam operation. Cancel Easy Handycam operation (p.25).
- 

### **A vertical band appears when recording candlelight or electric light in the dark.**

- This occurs when the contrast between the subject and the background is too high. This is not a malfunction.
- 

### **A vertical band appears when recording a bright subject.**

- This phenomenon is called the smear effect. This is not a malfunction.
-



---

**Tiny spots in white, red, blue, or green appear on the screen.**

- The spots appear when you are recording in [SUPER NS] or [COLOR SLOW S]. This is not a malfunction.

---

**The color of the image is not correctly displayed.**

- Set the NIGHTSHOT switch to OFF (p.32).

---

**The image appears too bright on the screen, and the subject does not appear on the screen.**

- Set the NIGHTSHOT switch to OFF (p.32).

---

**The image appears too dark on the screen, and the subject does not appear on the screen.**

- The LCD screen backlight is switched off. Turn on the LCD backlight by pressing and holding DISP/BATT INFO (p.18).

---

**Flickering or changes in color occurs.**

- This occurs when recording images under a fluorescent lamp, sodium lamp, or mercury lamp with [PORTRAIT] or [SPORTS]. Cancel [PROGRAM AE] in this case (p.50).

---

**Black bands appear when you record a TV screen or computer screen.**

- Set [STEADYSHOT] to [OFF] (p.54).

## Remote Commander

**The supplied Remote Commander does not function.**

- Set [REMOTE CTRL] to [ON] (p.61).
- Insert a battery into the battery holder with the +/- polarities correctly matching the +/- marks (p.96).
- Remove any obstructions between the Remote Commander and the remote sensor.
- Point the remote sensor away from strong light sources such as direct sunlight or overhead lighting. Otherwise, the Remote Commander may not function properly.
- Remove the conversion lens (optional) as the remote sensor may be obstructed by it.

---

**Another DVD device malfunctions when you use the supplied Remote Commander.**

- Select a commander mode other than DVD 2 for your DVD device, or cover the sensor of your DVD device with black paper.

### Playback

#### “?” is indicated on an image in the VISUAL INDEX screen.

- Loading of the data may have failed. It may be indicated correctly when you turn off the power and then turn it on again.
- You removed the AC Adaptor or the battery pack before the ACCESS lamp is turned on after recording. This may damage your image data and [?] is displayed.

#### “⚡” is indicated on an image in the VISUAL INDEX screen.

- The image data is damaged. Delete the image marked with ⚡ (p.43).

#### No sound or only a low sound is heard when playing back.

- Set [MULTI-SOUND] to [STEREO] (p.59).
- Turn up the volume (p.29).
- Sound is not output when the LCD screen is closed. Open the LCD screen.
- When you record sound with [MICREF LEVEL] (p.59) set to [LOW], the recorded sound may be difficult to hear.

### Image data

#### Images cannot be deleted.

- Protected images cannot be deleted. Cancel the image protection (p.68).

#### The data file name is not indicated correctly.

- Only the file name is displayed if the directory structure does not conform to the camcorder standard.
- The file is damaged.
- The file format is not supported on your camcorder (p.92).

#### The data file name flashes.

- The file is damaged.
- The file format is not supported on your camcorder (p.92).

### Setup items

#### Setup items are grayed out.

- You cannot select grayed items in the current situation.

#### [P-MENU] is not displayed.

- You can operate limited operations during Easy Handycam operation. Cancel Easy Handycam operation (p.25).

---

**You cannot use [PROGRAM AE].**

- You cannot use [PROGRAM AE] together with:
  - NightShot
  - [SUPER NS]
  - [COLOR SLOW S]
  - [OLD MOVIE]
- [SPORTS] will not work when the POWER switch is set to  (Still).

---

**You cannot use [SPOT METER].**

- You cannot use [SPOT METER] together with:
  - NightShot
  - [SUPER NS]
  - [COLOR SLOW S]
- If you set [PROGRAM AE], [SPOT METER] is automatically set to [AUTO].

---

**You cannot use [EXPOSURE].**

- You cannot use [EXPOSURE] together with:
  - NightShot
  - [SUPER NS]
  - [COLOR SLOW S]
- If you set [PROGRAM AE], [EXPOSURE] is automatically set to [AUTO].

---

**You cannot use [WHITE BAL.].**

- You cannot use [WHITE BAL.] together with:
  - NightShot
  - [SUPER NS]

---

**You cannot use [SPOT FOCUS].**

- You cannot use [SPOT FOCUS] together with [PROGRAM AE].

---

**You cannot use [SUPER NS].**

- The NIGHTSHOT switch is not set to ON.
- You cannot use [SUPER NS] together with:
  - [FADER]
  - [D. EFFECT]

### **[COLOR SLOW S] does not operate correctly.**

- [COLOR SLOW S] may not operate correctly in total darkness. Use NightShot or [SUPER NS].
  - You cannot use [COLOR SLOW S] together with:
    - [FADER]
    - [D. EFFECT]
    - [PROGRAM AE]
    - [EXPOSURE]
    - [SPOT METER]
- 

### **You cannot use SELF-TIMER.**

- You cannot use  SELF-TIMER together with [FADER].
- 

### **You cannot use [FADER].**

- You cannot use [FADER] together with:
    - [SUPER NS]
    - [COLOR SLOW S]
    - [D. EFFECT]
- 

### **You cannot use [D. EFFECT].**

- You cannot use [D. EFFECT] together with:
    - [SUPER NS]
    - [COLOR SLOW S]
    - [FADER]
  - You cannot use [OLD MOVIE] together with:
    - [PROGRAM AE]
    - [PICT. EFFECT]
- 



### **You cannot use [PICT. EFFECT].**

- You cannot use [PICT. EFFECT] together with [OLD MOVIE].
- 

### **You cannot view [SUR MONITOR].**

- You cannot view the [SUR MONITOR] either you are not recording in 5.1ch surround recording or together with [FADER].
- 

### **You cannot adjust [LCD BL LEVEL].**

- You cannot adjust [LCD BL LEVEL] when power is supplied from the AC Adaptor, or when you turn the LCD panel facing out on your camcorder when the POWER switch is set to  (movie) or  (Still).

## Editing for movies and still images

### Scenes cannot be added in the Playlist.

- The added scenes exceed 99. Delete unnecessary scenes (p.43, 65).

### A scene cannot be deleted.

- Protected images cannot be deleted. Cancel the image protection (p.68)

## Dubbing/Connecting to other devices

### Images from connected devices are not displayed on the LCD screen or the viewfinder (For DCR-SR100E only).

- Touch [P-MENU] → [REC CTRL] (p.72).

### The aspect ratio of the playback is not correct when connecting your camcorder to the TV.

- Set [TV TYPE] depending on your TV (p.40).

### Images from connected devices cannot be zoomed.

- You cannot zoom scenes input from the other device on your camcorder.

### No sound is heard during playback.

- The audio will not be output when you connect a device via the S VIDEO plug only. Connect the white and red plugs of the A/V connecting cable, too (p.40, 69).

### You cannot dub correctly using the A/V connecting cable.

- The A/V connecting cable is not connected properly. Make sure that the A/V connecting cable is connected to the proper jack, i.e. to the output jack of a device you are dubbing a image from, or to the input jack of another device for dubbing a image from your camcorder (p.69, 71).

## Others

### The beep sounds for five seconds.

- The temperature of your camcorder is extremely high. Turn off your camcorder and leave it for a while in a cool place.
- Some problems have occurred in your camcorder. Turn off and on, then operate your camcorder again.

# Warning indicators and messages

## Self-diagnosis display/Warning indicators

If indicators appear on the LCD screen or in the viewfinder, check the following. Some symptoms you can fix by yourself. If the problem persists even after you have tried a couple of times, contact your Sony dealer or local authorized Sony service facility.

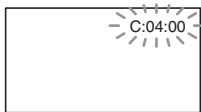

### C:(or E:) □□:□□ (Self-diagnosis display)

#### C:04:□□

- The battery pack is not an “InfoLITHIUM” battery pack. Use an “InfoLITHIUM” battery pack (p.93).
- Connect the DC plug of the AC Adaptor to the DC IN jack of your camcorder securely (p.14).

#### C:13:□□

- Remove the power source. Reconnect it and operate your camcorder again.

#### C:32:□□

- Remove the power source. Reconnect it and operate your camcorder again.

#### E:20:□□ / E:31:□□ / E:40:□□ / E:61:□□ / E:62:□□ / E:91:□□ / E:94:□□

- A malfunction that you cannot service has occurred. Contact your Sony dealer or local authorized Sony service facility. Inform them of the 5-digit code, which starts from “E.”

### 100-0001 (Warning indicator pertaining to files)

#### Slow flashing

- The file is damaged.
- The file is unreadable.

### (Warning on the hard disk of the camcorder)\*

#### Fast flashing

- An error might have occurred with the hard disk drive in your camcorder.

### (Warning on the hard disk of the camcorder)\*

#### Fast flashing

- The hard disk of the camcorder is fully recorded.
- An error might have occurred with the hard disk drive in your camcorder.

### (Battery level warning)

#### Slow flashing

- The battery pack is nearly used up.
- Depending on the operating environment or battery conditions,  may flash, even if there are approximately 20 minutes remaining.

### (High temperature warning)

#### Slow flashing

- The temperature of your camcorder is getting higher. Turn off your camcorder and leave it for a while in a cool place.

#### Fast flashing\*

- The temperature of your camcorder is extremely high. Turn off your camcorder and leave it for a while in a cool place.

### (Low temperature warning)

#### Fast flashing

- The temperature of your camcorder is extremely low. Make the camcorder warm.

### (Warning indicator pertaining to the flash)\*

#### Slow flashing

- Still charging.

#### Fast flashing

- There is something wrong with the flash.

---

 **(Warning indicator pertaining to camera-shake warning)**

- The amount of lights is not sufficient, so camera-shake easily occurs. Use the flash.
- The camcorder is unsteady, so camera-shake easily occurs. Hold the camcorder steady with both hands and record the image. However, note that the camera-shake warning indicator does not disappear.

---

\* You hear a melody when the warning indicators appear on the screen (p.62).

## Description of warning messages

If messages appear on the screen, follow the instructions.

### ■ Battery

---

**Use the “InfoLITHIUM” battery pack.** (p.93)

---

**Battery level is low.** (p.14, 93)

---

**Old Battery. Use a new one.** (p.93)

### ■ Hard disk

---

 **Drive error. Turn on power again.**

- A problem occurred with the hard disk. Turn off and then on again.

---

 **Overheated. Cannot access HDD.**

---

 **Low temperature. Cannot access HDD.**

---

 **Recording disabled.**

- A malfunction has occurred with the hard disk of the camcorder. Turn off and then on again.

---

 **HDD full. Cannot record.**

- Delete unnecessary images (p.43).

---

 **Movie scene number is full. Cannot record.**

- Delete unnecessary images (p.43).

---

 **Movie folder full. Cannot record movies.**

- Delete unnecessary images (p.43) or perform [HDD FORMAT].

---

 **Still scene number is full. Cannot record.**

- Delete unnecessary images (p.43).

---

 **Still pic folder full. Cannot record stills.**

- Delete unnecessary images (p.43) or perform [HDD FORMAT].

---

 **Movie recording disabled.**

- Movies cannot be recorded due to some limitations of the hard disk of the camcorder. However, you may be able to record still images.

---

 **Still recording disabled.**

- Still images cannot be recorded due to some limitations of the hard disk of the camcorder. However, you may be able to record movies.

---

**No applicable files available.**

- Image files have been deleted.

---

**Format error. Please format.**

- The hard disk of the camcorder is set differently from the default format. Performing [HDD FORMAT] (p.57) may enable you to use your camcorder.

---

**Data error.**

- An error occurred during reading or writing the hard disk of the camcorder.

---

### Access error.

- An error occurred during reading or writing the hard disk of the camcorder.

---

### Management file damaged. Create new file?

- The image management file is damaged. When you touch [YES], a new image management file is created. When a new management file is created, the old recorded images on the hard disk of the camcorder cannot be played back. (Image files are not damaged.) In this case, copy the image files to computer by following the steps in “Copying images to a computer” in “Computer Application Guide”.

---

### Buffer overflow

- The drop sensor senses a drop of the camcorder, and you may not record the image. Set the drop sensor to [OFF], and you may be able to record the image again.

---

### Recovering data Avoid any vibration.

- Your camcorder tries to recover data automatically if the data writing was not performed properly.

---

### Cannot recover data.

- Writing data onto the hard disk of the camcorder has failed. Attempts were made to recover the data, but they were unsuccessful.

---

### ■ PictBridge compliant printer

---

#### Check the connected device.

- Turn off the printer and on again, then remove the USB cable (supplied) and reconnect it.

---

### Connect the camcorder to a PictBridge compatible printer.

- Turn off the printer and on again, then remove the USB cable (supplied) and reconnect it.

---

### Error. Cancel the task.

- Check the printer.

---

### Cannot print. Check the printer.

- Turn off the printer and on again, then remove the USB cable (supplied) and reconnect it.

---

### ■ Flash

---

#### Charging... Cannot record still images.

- You are trying to record a still image while the flash is charging.

---

#### Flash cannot charge. Not available.

- A malfunction has occurred with the strobe and disable charging.

---

#### Lens accessory attached. Cannot use flash.

- The flash does not work when attaching the conversion lens (optional) or filter (optional).

---

### ■ Lens cover

---

#### Lens cover not fully open. Turn power off then on. (p.17)

---

#### Lens cover is not closed. Turn the power off once. (p.17)



## ■ Easy Handycam

---

**Cannot start Easy Handycam.** (p.22)

---

**Cannot cancel Easy Handycam.** (p.22)

---

**Cannot start Easy Handycam with USB connected.** (p.22)

---

**Cannot cancel Easy Handycam with USB connected.** (p.22)

---

**Invalid during Easy Handycam operation** (p.22)

---

## ■ Other

---

🔌 **Please connect AC Adaptor.**

- You are trying to format the camcorder hard disk, while the battery capacity is low. Use the AC Adaptor as the power source to prevent the battery from wearing out in the middle of this operation.
- 

**Playback prohibited.**

- You can only play back the images recorded by the camcorder.
- 

**Playlist full.**

- You cannot create the playlist exceeding 99 scenes.
- 

**Data protected.**

- The data is protected (p.67).
- 

**Copy Inhibit.**

- The copyright protected images cannot be dubbed on the camcorder.
- 

---

**Already added to  mode's P-MENU.**

---

**Drop sensor activated. USB function ended.**

---

**Press END button and end USB connection.**

- During USB connection, you cannot perform One Touch DVD Burn.

# Using your camcorder abroad

## Power supply

You can use your camcorder in any countries/regions using the AC Adaptor supplied with your camcorder within the AC 100 V to 240 V, 50/60 Hz range.

## On TV color systems

Your camcorder is a PAL system-based camcorder. If you want to view the playback picture on a TV, it must be a PAL system based TV with an AUDIO/VIDEO input jack.

System	Used in
PAL	Australia, Austria, Belgium, China, Czech Republic, Denmark, Finland, Germany, Holland, Hong Kong, Hungary, Italy, Kuwait, Malaysia, New Zealand, Norway, Poland, Portugal, Singapore, Slovak Republic, Spain, Sweden, Switzerland, Thailand, United Kingdom, etc.
PAL - M	Brazil
PAL - N	Argentina, Paraguay, Uruguay.
NTSC	Bahama Islands, Bolivia, Canada, Central America, Chile, Colombia, Ecuador, Guyana, Jamaica, Japan, Korea, Mexico, Peru, Surinam, Taiwan, the Philippines, the U.S.A., Venezuela, etc.
SECAM	Bulgaria, France, Guyana, Iran, Iraq, Monaco, Russia, Ukraine, etc.

## Setting to the local time

You can easily set the clock to the local time by setting a time difference when using your camcorder abroad. Set [AREA SET] and [SUMMERTIME] in the  TIME/LANGU. (p.20).

## World time difference

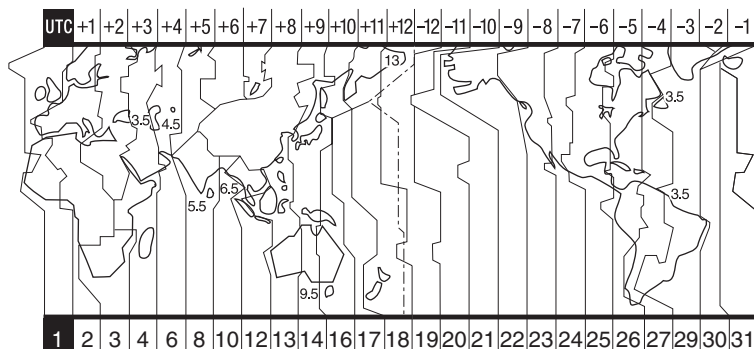

Area code	Time-zone differences	Area setting
1	GMT	Lisbon, London
2	+01:00	Berlin, Paris
3	+02:00	Helsinki, Cairo
4	+03:00	Moscow, Nairobi
5	+03:30	Tehran
6	+04:00	Abu Dhabi, Baku
7	+04:30	Kabul
8	+05:00	Karachi, Islamabad
9	+05:30	Calcutta, New Delhi
10	+06:00	Almaty, Dhaka
11	+06:30	Rangoon
12	+07:00	Bangkok, Jakarta
13	+08:00	HongKong, Singapore
14	+09:00	Seoul, Tokyo
15	+09:30	Adelaide, Darwin
16	+10:00	Melbourne, Sydney

Area code	Time-zone differences	Area setting
17	+11:00	Solomon Is.
18	+12:00	Fiji, Wellington
19	-12:00	Eniwetok, Kwajalein
20	-11:00	Midway Is., Samoa
21	-10:00	Hawaii
22	-09:00	Alaska
23	-08:00	Los Angeles, Tijuana
24	-07:00	Denver, Arizona
25	-06:00	Chicago, Mexico City
26	-05:00	New York, Bogota
27	-04:00	Santiago
28	-03:30	St. John's
29	-03:00	Brasilia, Montevideo
30	-02:00	Fernando de Noronha
31	-01:00	Azores

# Files on the camcorder hard disk/folder structure

The files/folder structure are shown below. You do not usually need to acknowledge the files/folder structure, when recording/playing back images on a camcorder. To enjoy still images or movies by connecting to a computer, refer to “Computer Application Guide,” then use the supplied application.

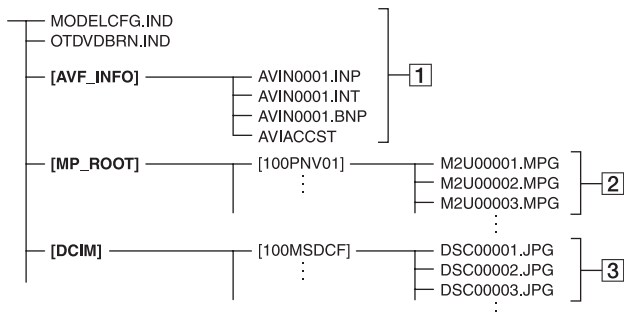

## 1 Image management files

The files are defaulted as hidden files and not usually displayed. When you delete the files, you cannot record/playback the images correctly.

## 2 Movie files (MPEG2 files)

The extension of the files is “.MPG”. The maximum size is 2GB. When the capacity of a file exceeds 2GB, the file becomes divided.

The file numbers go up automatically. When the file numbers exceeds 9,999, another folder is created to store new movie files.

The folder name goes up: [100PNV01] → [101PNV01]

## 3 Still image files (JPEG files)

The extension of the files is “.JPG”. The file numbers go up automatically. When the capacity of a file number exceeds 9,999, another folder is created to store new image files.

The folder name goes higher as shown here: [100MSDCF] → [101MSDCF]

- Do not modify the files or folders on the camcorder through the computer without using the supplied computer application. The image files may be destroyed or may not be played back.
- Operation is not guaranteed, if you perform the above operation without using the supplied computer application.
- When you delete image files, see the steps on page 43. Do not delete the image files on the camcorder directly from the computer.
- Do not format the hard disk of the camcorder using the computer. It may not operate correctly.
- When the file extensions are not displayed on the screen of the computer, see “Troubleshooting” in the “Computer Application Guide”.
- Do not copy the files on the hard disk of the camcorder from the computer. Operation is not guaranteed.
- When the folder number shows 999 and file number exceeds 9,999, recording may not be possible. In this case, perform [HDD FORMAT] (p.57).

### For DCR-SR90E only:

- You cannot copy data on the hard disk of the camcorder from the computer.

- You can access from the computer when you set [USB SELECT] to [HDD] (p.56) on the hard disk of the camcorder by connecting the USB cable to your computer.

# About the “InfoLITHIUM” battery pack

This unit is compatible with an “InfoLITHIUM” battery pack (P series). Your camcorder operates only with an “InfoLITHIUM” battery pack. “InfoLITHIUM” P series battery packs have the  mark.

## What is an “InfoLITHIUM” battery pack?

An “InfoLITHIUM” battery pack is a lithium-ion battery pack that has functions for communicating information related to operating conditions between your camcorder and an optional AC Adaptor/charger (optional).

The “InfoLITHIUM” battery pack calculates the power consumption according to the operating conditions of your camcorder, and displays the remaining battery time in minutes.

## Charging the battery pack

- Be sure to charge the battery pack before you start using your camcorder.
- It is recommended that you charge the battery pack in an ambient temperature of between 10°C to 30°C (50°F to 86°F) until CHG (Charge) lamp turns off. If you charge the battery pack outside of this temperature range, you may not be able to charge the battery pack efficiently.
- After charging is complete, either remove the cable from the DC IN jack on your camcorder or remove the battery pack.

## Effective use of the battery pack

- Battery pack performance decreases when the surrounding temperature is 10°C (50°F) or below, and the length of time you can use the battery pack becomes shorter. In that case, do one of the following to use the battery pack for a longer time.
  - Put the battery pack in a pocket to warm it up, and insert it in your camcorder right before you start taking shots.
  - Use a large capacity battery pack: NP-FP71/ NP-FP90 (optional).
- Frequent use of the LCD screen or a frequent playback, fast forward or reverse operation wears out the battery pack faster. It is recommended that you use a large capacity battery pack: NP-FP71/ NP-FP90 (optional).

- Be sure to slide the POWER switch to OFF (CHG) when not shooting or playing back on your camcorder. The battery pack is also consumed when your camcorder is in the standby mode or playback is paused.
- Have spare battery packs ready for two or three times the expected recording time, and make trial recordings before making the actual recording.
- Do not expose the battery pack to water. The battery pack is not water-resistant.

## Remaining battery time indicator

- If the power goes off even though the remaining battery time indicator indicates that the battery pack has enough power to operate, charge the battery pack fully again so that the indication on the remaining battery time indicator is correct. Note, however, that the correct battery indication sometimes will not be restored if the battery is used in high temperatures for a long time or left in a fully charged state, or the battery pack is used frequently. Regard the remaining battery time indication as the approximate shooting time.
- The  mark indicating that there is little remaining battery time sometimes flashes depending on the operating conditions or ambient temperature and environment even if the remaining battery time is approximately 20 minutes.

## How to store the battery pack

- If the battery pack is not used for a long time, fully charge the battery pack and discharge it on your camcorder once a year to maintain the proper function. To store the battery pack, remove it from your camcorder and put it in a dry, cool place.
- To use the battery pack up on your camcorder, leave your camcorder in the recording standby with the [A.SHUT OFF] to [NEVER] in the  STANDARD SET in the SETUP screen until the power goes off (p.62).

## Battery life

- The battery life is limited. Battery capacity drops little by little as you use it more and more, and as time passes. When the available battery time is shortened considerably, a probable cause is that the battery pack has reached the end of its life. Please buy a new battery pack.
- The battery life varies according to how it is stored, the operating conditions, and environment in which each battery pack is used.

# Maintenance and precautions

## On use and care

- Do not use or store the camcorder and accessories in the following locations.
  - Anywhere extremely hot or cold or humid places. Never leave them exposed to temperatures above 60°C (140°F), such as under direct sunlight, near heaters or in a car parked in the sun. They may malfunction or become deformed.
  - Near strong magnetic fields or mechanical vibration. The camcorder may malfunction.
  - Near strong radio waves or radiation. The camcorder may not be able to record properly.
  - Near AM receivers and video equipment. Noise may occur.
  - On a sandy beach or anywhere dusty. If sand or dust gets in your camcorder, it may malfunction. Sometimes this malfunction cannot be repaired.
  - Near windows or outdoors, where the LCD screen, the viewfinder, or the lens may be exposed to direct sunlight. This damages the inside of the viewfinder or the LCD screen.
  - Anywhere very humid.
- Operate your camcorder on DC 7.2 V (battery pack) or DC 8.4 V (AC Adaptor).
- For DC or AC operation, use the accessories recommended in these instruction manual.
- Do not let your camcorder get wet, for example, from rain or sea water. If your camcorder gets wet, it may malfunction. Sometimes this malfunction cannot be repaired.
- If any solid object or liquid gets inside the casing, unplug your camcorder and have it checked by a Sony dealer before operating it any further.
- Avoid rough handling, disassembling, modifying, physical shock, or impact such as hammering, dropping or stepping on the product. Be particularly careful of the lens.
- Keep the POWER switch setting to OFF (CHG) when you are not using your camcorder.
- Do not wrap your camcorder with a towel, for example, and operate it. Doing so might cause heat to build up inside.
- When removing the mains lead, pull it by the plug and not the cord.
- Do not damage the mains lead such as by placing anything heavy on it.
- Keep metal contacts clean.
- Keep the Remote Commander and button-type battery out of children's reach. If the battery is

accidentally swallowed, consult a doctor immediately.

- If the battery electrolytic liquid has leaked,
  - consult your local authorized Sony service facility.
  - wash off any liquid that may have contacted your skin
  - if any liquid gets in your eyes, wash with plenty of water and consult a doctor.

### ■ When not using your camcorder for a long time

- Occasionally turn it on and let it run such as by playing back images or recording for about three minutes.
- Use up the battery pack completely before storing it.

## Moisture condensation

If your camcorder is brought directly from a cold place to a warm place, moisture may condense inside your camcorder. This may cause malfunction to your camcorder.

### ■ Note on moisture condensation

Moisture may condense when you bring your camcorder from a cold place into a warm place (or vice versa) or when you use your camcorder in a humid place as follows:

- You bring your camcorder from a ski slope into a place warmed up by a heating device.
- You bring your camcorder from an air conditioned car or room into a hot place outside.
- You use your camcorder after a squall or a shower.
- You use your camcorder in a hot and humid place.

### ■ How to prevent moisture condensation

When you bring your camcorder from a cold place into a warm place, put your camcorder in a plastic bag and seal it tightly. Remove the bag when the air temperature inside the plastic bag has reached the surrounding temperature (after about one hour).

### ■ If moisture condensation has occurred

Turn off your camcorder, and leave it for about an hour.

## On the LCD screen

- Do not exert excessive pressure on the LCD screen. Blurs appear and it may cause a malfunction of your camcorder.
- If your camcorder is used in a cold place, a residual image may appear on the LCD screen. This is not a malfunction.
- While you are using your camcorder, the back of the LCD screen may heat up. This is not a malfunction.



### ■ To clean the LCD screen

If fingerprints or dust make the LCD screen dirty, use the cleaning cloth (optional) to clean the LCD screen.

When you use the LCD Cleaning Kit (optional), do not apply the cleaning liquid directly to the LCD screen. Use cleaning paper moistened with the liquid.

### ■ On adjustment of the LCD screen (CALIBRATION)

The buttons on the touch panel may not work correctly. If this happens, follow the procedure below. It is recommended you connect your camcorder to the wall socket using the supplied AC Adaptor during the operation.

- ① Slide the POWER switch to light up the  (PLAY/EDIT) lamp.
- ② Remove cables other than that of the AC Adaptor from your camcorder.
- ③ Touch **P-MENU** → [SETUP] →  STANDARD SET → [CALIBRATION].

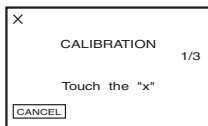

- ④ Touch the “x” displayed on the screen with a thin object such as a corner of “Memory Stick Duo”.

The position of the “x” changes.

Touch [CANCEL] to cancel.

If you did not press the right spot, try the calibration again.

- Do not use a sharp-pointed tool to calibrate the LCD screen. Doing so may damage the surface of the screen.
- You cannot calibrate the LCD screen if you have rotated it, or if you have set it with the LCD screen side facing out.

## On handling the casing

- If the casing is soiled, clean the camcorder body with a soft cloth lightly moistened with water, and then wipe the casing with a dry soft cloth.
- Avoid the followings to prevent damage to the finish.
  - Using chemicals such as thinner, benzine, alcohol, chemical cloths, repellent and insecticide and sunscreen.
  - Handling with above substances on your hands.
  - Leaving the casing in contact with rubber or vinyl objects for a long period of time.

## Care and storage of the camera lens

- Wipe the surface of the lens clean with a soft cloth in the following instances:
  - when there are fingerprints on the lens surface.
  - in hot or humid locations
  - when the lens is exposed to salty air such as at the seaside.
- Store the lens in a well-ventilated location subject to little dirt or dust.
- To prevent mold, periodically clean the lens as described above. It is recommended that you operate your camcorder about once a month to keep it in optimum state for a long time.

## To charge the pre-installed rechargeable battery

Your camcorder has a pre-installed rechargeable battery to retain the date, time, and other settings even when the POWER switch is set to OFF (CHG). The pre-installed rechargeable battery is always charged while you are using your camcorder but it will get discharged gradually if you do not use your camcorder. The rechargeable battery will be fully discharged in **about 3 months** if you do not use your camcorder at all. However, even if the pre-installed rechargeable battery is not charged, the camcorder operation will not be affected as long as you are not recording the date.

### ■ Procedures

Connect your camcorder to a wall socket using the AC Adaptor supplied with your camcorder, and leave your camcorder with the POWER switch turned off for more than 24 hours.

### To change the battery of the Remote Commander

- ① While pressing on the tab, inset your fingernail into the slit to pull out the battery case.
- ② Place a new battery with the + side facing up.
- ③ Insert the battery case back into the Remote Commander until it clicks.

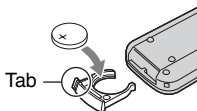

### WARNING

Battery may explode if mistreated. Do not recharge, disassemble or dispose of in fire.

- A button-type lithium battery (CR2025) is used in the Remote Commander. Do not use batteries other than the CR2025.
- When the lithium battery becomes weak, the operating distance of the Remote Commander may shorten, or the Remote Commander may not function properly. In this case, replace the battery with a Sony CR2025 lithium battery. Use of another battery may present a risk of fire or explosion.

### System

#### Video compression format

MPEG2/JPEG (Still images)

#### Hard Disk

30 GB

#### Audio compression format

Dolby Digital 2/5.1ch

Dolby Digital 5.1 Creator

#### Video signal

PAL color, CCIR standards

#### Recording format

Movie

MPEG2-PS

#### Still image

Exif \*1 Ver.2.2

#### Recording/playback time

HQ: Approx. 440 min

SP: Approx. 650 min

LP: Approx. 1 250 min

#### Number of recordable movies/still images

Movie: Maximum of 9 999

Still image: Maximum of 9 999

#### Viewfinder

Electric viewfinder  
color

#### Image device

5.9 mm (1/3 type) CCD (Charge Coupled Device)

Gross:

Approx. 3 310 000 pixels

Effective (Movie, 4:3):

Approx. 2 050 000 pixels

Effective (Movie, 16:9):

Approx. 2 060 000 pixels

Effective (Still, 4:3):

Approx. 3 050 000 pixels

Effective (Still, 16:9):

Approx. 2 290 000 pixels

#### Lens

Carl Zeiss Vario-Sonnar T\*

Filter diameter:30 mm (1 3/16 in.)

Optical:10 $\times$ , Digital:20 $\times$ , 120 $\times$

F=1.8 - 2.9

#### Focal length

f=5.1 - 51 mm (7/32 - 2 1/8 in.)

When converted to a 35 mm still camera

For movies:

42.8 - 495 mm (1 11/16 - 19 1/2 in.) (16:9)<sup>2</sup>

45 - 450 mm (1 13/16 - 17 3/4 in.) (4:3)

For still images:

40.6 - 406 mm (1 5/8 - 16 in.) (16:9)

37 - 370 mm (1 1/2 - 14 5/8 in.) (4:3)



### Color temperature

[AUTO], [ONE PUSH], [INDOOR] (3 200 K),  
[OUTDOOR] (5 800 K)

### Minimum illumination

5 lx (lux) (F1.8)  
0 lx (lux) (in the NightShot function)

<sup>1</sup> “Exif” is a file format for still images, established by the JEITA (Japan Electronics and Information Technology Industries Association). Files in this format can have additional information such as your camcorder’s setting information at the time of recording.

<sup>2</sup> In 16:9 mode, the focal length figures are actual figures resulting from wide angle pixel readout.

- Manufactured under license from Dolby Laboratories.

## Input/Output connectors

### DCR-SR90E

#### Audio/Video output

10-pin connector  
Video signal: 1 Vp-p, 75 Ω (ohms), unbalanced  
Luminance signal: 1 Vp-p, 75 Ω (ohms), unbalanced  
Chrominance signal: 0.3Vp-p, 75 Ω (ohms), unbalanced  
Audio signal: 327 mV (at load impedance 47 kΩ (kilohms)), Output impedance with less than 2.2 kΩ (kilohms)

#### USB jack

mini-B

#### REMOTE jack

Stereo mini-minijack (Ø 2.5 mm)

### DCR-SR100E

#### Audio/Video input/output

10 pin connector  
Input/Output auto switch  
Video signal: 1 Vp-p, 75 Ω (ohms), unbalanced  
Luminance signal: 1 Vp-p, 75 Ω (ohms), unbalanced  
Chrominance signal: 0.3 Vp-p, 75 Ω (ohms), unbalanced  
Audio signal: 327 mV (at load impedance 47 kΩ (kilohms)), Input impedance more than 47 kΩ (kilohms), Output impedance less than 2.2 kΩ (kilohms)

#### USB jack

mini-B

#### REMOTE jack

Stereo mini-minijack (Ø 2.5 mm)

## LCD screen

### Picture

6.9 cm (2.7 type, aspect ratio 16:9)

### Total number of pixels

123 200 (560 × 220)

## General

### Power requirements

7.2 V (battery pack) 8.4 V (AC Adaptor)

### Average power consumption (when using the battery pack)

During camera recording using LCD

4.1 W

Viewfinder

3.7 W

### Operating temperature

0°C to +40°C (32°F to 104°F)

### Storage temperature

-20°C to +60°C (-4°F to +140°F)

### Dimensions (Approx.)

82 × 69 × 149 mm (3 3/8 × 2 3/4 × 5 7/8 in.)  
(w×h×d)

### Mass (Approx.)

535 g (1 lb 2 oz) main unit only  
615 g (1 lb 5 oz) including the NP-FP60 rechargeable battery pack

### Supplied accessories

See page 13.

## AC Adaptor AC-L200

### Power requirements

AC 100 - 240 V, 50/60 Hz

### Current consumption

0.35 - 0.18 A

### Power consumption

18 W

### Output voltage

DC 8.4 V\*

### Operating temperature

0°C to +40°C (32°F to 104°F)

### Storage temperature

-20°C to +60°C (-4°F to +140°F)

### Dimensions (Approx.)

48 × 29 × 81 mm (1 15/16 × 1 3/16 × 3 1/4 in.)  
(w×h×d) excluding the projecting parts

### Mass (Approx.)

170 g (6 oz) excluding the mains lead

- \* See at the label of AC Adaptor for other specifications.

## Specifications (continued)

### Rechargeable battery pack

#### NP-FP60

##### Maximum output voltage

DC 8.4 V

##### Output voltage

DC 7.2 V

##### Capacity

7.2 wh (1 000 mAh)

##### Dimensions (Approx.)

31.8 × 33.3 × 45.0 mm  
(1 5/16 × 1 5/16 × 1 13/16 in.) (w×h×d)

##### Mass (Approx.)

80 g (2.9 oz)

##### Operating temperature

0°C to + 40°C (32°F to 104°F)

##### Type

Li-ion

Design and specifications are subject to change without notice.

### On trademarks

- “Handycam” and **HANDYCAM** are registered trademarks of Sony Corporation.
- “InfoLITHIUM” is a trademark of Sony Corporation.
- “Memory Stick Duo” is a trademark of Sony Corporation.
- “ImageMixer for HDD Camcorder” is a trademark of Pixela Corporation.
- Dolby and the double-D symbol are trademarks of Dolby Laboratories.
- Dolby Digital 5.1 Creator and Dolby Digital Stereo Creator are trademarks of Dolby Laboratories.

All other product names mentioned herein may be the trademarks or registered trademarks of their respective companies. Furthermore, <sup>TM</sup> and “®” are not mentioned in each case in this manual.

### Notes on the License

ANY USE OF THIS PRODUCT OTHER THAN CONSUMER PERSONAL USE IN ANY MANNER THAT COMPLIES WITH THE MPEG-2 STANDARD FOR ENCODING VIDEO INFORMATION FOR PACKAGED MEDIA IS EXPRESSLY PROHIBITED WITHOUT A LICENSE UNDER APPLICABLE PATENTS IN THE MPEG-2 PATENT PORTFOLIO, WHICH LICENSE IS AVAILABLE FROM MPEG LA, L.L.C., 250 STEELE STREET, SUITE 300, DENVER, COLORADO 80206.

# Glossary

## ■ 5.1ch surround sound

A system that plays back sound on 6 speakers, 3 at the front (left, right and center) and 2 at the rear (right and left) with an additional low-pass sub woofer counted as a 0.1 channel for frequencies of 120Hz or lower. The sub woofer is only counted as 0.1 channel because its playback band is narrow. The all-round audio reproduction is more realistic than stereo, which only reproduces movement of sound from side to side.

## ■ Dolby Digital

An audio encoding (compression) system developed by Dolby Laboratories Inc. Sound can be recorded in various formats, from 5.1ch surround to 2ch stereo or monaural audio.

## ■ Dolby Digital 5.1 Creator

Sound compression technology developed by Dolby Laboratories Inc. which compresses audio efficiently while preserving high sound quality. It enables recording of 5.1ch surround sound while using the hard disk space of the camcorder more efficiently. DVD created by Dolby Digital 5.1 Creator can be played back on a DVD devices compatible with Dolby Digital 5.1. If you own a 5.1ch system (such as a home theater system) you can enjoy a powerful sound.

## ■ Extension

The last three letters of a file name after “.”. The extension of a movie file recorded on the camcorder is “.MPG,” while that of a still image is “.JPG”. If you cannot see an extension on your file name, see “Computer Application Guide”.

## ■ Formatting

The process of deleting all recorded image data from the hard disk of the camcorder and restoring its original storage capacity. You can initialize the hard disk of the camcorder using [HDD FORMAT] (p.57).

## ■ Fragmentation

The condition of a hard disk in which files are divided into pieces scattered around the hard disk. You may not save your images correct. You can solve the condition by performing [HDD FORMAT] (p.57).

## ■ JPEG

JPEG stands for Joint Photographic Experts Group, a still image data compression (data capacity reduction) standard. Hard Disk Drive Handycam records still images in JPEG format.

## ■ MPEG2

MPEG stands for Moving Picture Experts Group, the group of standards for the coding (image compression) of video (movie) and audio. There are MPEG1 (standard definition) and MPEG2 (high definition) formats. Hard Disk Drive Handycam records movies in MPEG2 format.

## ■ Photomovie

A series of still images (JPEG format) converted and resaved as a movie (MPEG format), which can be played back on another DVD device or computer. Create a Photomovie to view still images on a DVD device that does not support JPEG playback. Still images converted to a Photomovie are played back continuously like a slide show. Resolution is slightly reduced.

## ■ PictBridge

PictBridge is a standard created for direct printing from digital cameras to printers. By connecting a PictBridge-compatible printer, you can print out still images without using a computer (p.73).

## ■ Playlist

A list of your favorite selected original movies.

It enables simple editing of original recorded data such as changing playback order.

### ■ Protection

The setting for preventing you from deleting image data.

### ■ Recording mode

By setting the recording mode before recording, you can select the image quality. There are 3 modes: HQ (high quality), SP (standard play) and LP (long play). The higher the recording quality, the shorter the recording time.

### ■ Thumbnail

Reduced-size images which enable you to view many images at the same time. The VISUAL INDEX screen uses a thumbnail display system.

### ■ USB 2.0

USB 2.0 is a standard for connecting with various devices. When your computer is compatible with USB 2.0, you can transfer data in high-speed between computers.

### ■ VBR

VBR stands for Variable Bit Rate, the recording format for automatically controlling the bit rate (the volume of recording data in a given time segment) according to the scene being recorded. For fast-moving video, a lot of disc space is used to produce a clear image so the recording time is short.

### ■ VISUAL INDEX

This function displays images of movies and still images you have recorded so that you can select those scenes you want to play back.

# Index

## Numeric

12IMAGES .....	61
16:9 (wide).....	21
21-pin adaptor.....	41
4:3 .....	21
5.1ch surround recording.....	33
5.1ch surround sound.....	99
6IMAGES .....	61

## A

A/V connecting cable .....	13, 40, 69, 71
A/V jack.....	40, 69, 71, 75
AC Adaptor.....	13, 14
ACCESS lamp .....	28
Active Interface Shoe .....	75
Adjusting exposure for back light.....	33
Application .....	See "Computer Application Guide"
AREA SET .....	62
Aspect ratio.....	21
AUTO SHUTTER .....	52
A.SHUT OFF (Auto shut off) .....	62

## B

BACK LIGHT button.....	33
Backup.....	See <i>Saving images</i>
Battery	
BATTERY INFO .....	35
Battery pack.....	14
Remaining battery .....	35
BATT (battery) release lever .....	15
BEACH&SKI .....	50
BEEP .....	62
BLACK FADER.....	55
Build-in 4ch microphone.....	35
BURST .....	54
EXP. BRKTG.....	54

NORMAL .....	54
Button-type lithium battery .....	96
B&W .....	56

## C

CALIBRATION .....	95
CAMERA DATA .....	61
CAMERA SET .....	50
CD-ROM.....	13
Charging the battery .....	14
Charging time .....	15
CHG (charge) lamp .....	14
CLOCK SET .....	20
COLOR SLOW S (Color Slow Shutter) .....	53, 84
Computer Application Guide .....	3
Computer .....	See "Computer Application Guide"
Connect	
Computer.....	See "Computer Application Guide"
Printer.....	73
TV .....	40
VCR/DVD device .....	69, 71
Copyright.....	3
Counter .....	37

## D

DATA CODE.....	20, 38, 60
Date Index .....	30
DATE/TIME .....	61
DC IN jack.....	14, 75
DC plug .....	14
Delete.....	12, 36, 43
DEMO MODE .....	57
DIGITAL ZOOM.....	54
DISP OUTPUT.....	62
DISP/BATT INFO .....	18, 19, 35
DISPLAY .....	61

Display indicators .....	37, 38
Dolby Digital.....	99
Dolby Digital 5.1 Creator .....	33, 99
DROP SENSOR.....	58
Dubbing.....	69
DVD BURN .....	56
D.EFFECT (Digital effect).....	56, 84

## E

EASY button .....	22
Easy Handycam operation .....	22, 47
EMPTY HDD .....	58
EUROCONNECTOR .....	41
EXP. BRKTG.....	54
EXPOSURE .....	51, 83
Extension.....	92, 99

## F

FADER.....	55, 84
File .....	92
FINE.....	55
Fireworks .....	50
Fixing the exposure .....	See <i>SPOT METER</i>
Flash .....	32
FLASH LEVEL .....	52
FLASH SET .....	52
FOCUS.....	52, 80
Formatting.....	57, 99
Fragmentation .....	99
Full charge.....	15
FULL SPEED .....	60

## H

Hard disk .....	10
HDD .....	57
HDD FORMAT .....	57
HDD INFO.....	57
HDD SET .....	57

## Index (continued)

- Highland ..... 5  
Holding the camcorder ..... 17  
HQ ..... 59
- I**
- Icon ..... *See Display indicators*  
Image management files ..... 92  
IMAGE SIZE ..... 55  
ImageMixer for HDD  
Camcorder ..... 13  
INDOOR ..... 51  
"InfoLITHIUM" battery pack  
..... 93  
Initialize (Reset) ..... 35  
Insulation sheet ..... 39
- J**
- Jack ..... 75  
Jack cover ..... 14  
JPEG ..... 92, 99
- L**
- LANDSCAPE ..... 50  
LANGUAGE ..... 62  
LCD/VF SET ..... 60  
LCD backlight ..... 18  
LCD BL LEVEL ..... 60, 84  
LCD BRIGHT ..... 60  
LCD COLOR ..... 60  
LCD PANEL ..... 62  
LCD screen ..... 18  
Lens cover ..... 17, 28  
LETTER BOX ..... 60  
LOW ..... 59  
LP (Long Play) ..... 59  
LUMI. KEY  
(luminance key) ..... 56
- M**
- Main sound ..... 59  
Mains lead ..... 14  
Maintenance ..... 94
- MICREF LEVEL ..... 59  
Mirror mode ..... 34  
Moisture condensation ..... 94  
MOSAIC ..... 56  
Movie  
REC MODE  
(Recording mode) ..... 59  
Recording ..... 24, 28  
Movie files ..... 92  
MPEG2 ..... 92, 99  
MULTI-SOUND ..... 59
- N**
- NightShot ..... 32  
NIGHT SHOT switch ..... 32  
NORMAL ..... 54  
NS LIGHT  
(NightShot Light) ..... 53  
NTSC ..... 90  
Number of recordable still  
images ..... 37
- O**
- OLD MOVIE ..... 56  
ONE PUSH ..... 51  
Operation confirmation  
beep ..... *See BEEP*  
OUTDOOR ..... 51  
OVERLAP ..... 55
- P**
- PAL ..... 90  
PASTEL ..... 56  
Personal Menu ..... 46, 63  
Add ..... 63  
Arrange the order ..... 63  
Delete ..... 63  
Reset ..... 64  
Personal Menu button ..... 37  
PHOTO button ..... 25, 28, 39  
Photomovie ..... 99  
PictBridge ..... 73, 99
- PictBridge PRINT ..... 57  
PICT.APPLI.  
(Picture Application) ..... 55  
PICT. EFFECT  
(Picture effect) ..... 56, 84  
Playback ..... 26, 29  
Playback time ..... 16  
Playback zoom ..... 34  
Playlist ..... 65, 99  
ADD ..... 65  
ERASE ..... 65  
MOVE ..... 66  
Play ..... 67  
tab ..... 26  
PORTRAIT (Soft portrait) ... 50  
Power supply ..... 90  
POWER switch ..... 14  
Pre-installed rechargeable  
battery ..... 95  
Preparation  
Camcorder ..... 13  
Computer .....  
*See "Computer Application  
Guide"*  
Previous/next button ..... 27, 29  
Previous/Next Date  
button ..... 30, 44, 68  
Print ..... 73  
PROGRAM AE ..... 50, 83  
PROTECT ..... 67  
Protection ..... 67, 100  
P-MENU ... *See Personal Menu*
- Q**
- QUALITY ..... 55
- R**
- Rechargeable battery  
pack ..... *See Battery*  
Recording ..... 24, 28  
Recording format ..... 96  
Recording lamp ..... 35, 61  
Recording mode ..... 59, 100

Recording time .....	15
REC CTRL .....	72
REC LAMP .....	61
REC MODE.....	59
REDEYE REDUC.....	52
REMAINING .....	61
Remaining battery.....	35
Remote Commander .....	39
REMOTE CTRL.....	61
REMOTE jack .....	75
Remote sensor.....	35
RESET .....	35
Review .....	36
Review deleting .....	36

## S

Saving images .....	12, 42
Searching for the images by date.....	30
Self-diagnosis display.....	86
SELF-TIMER .....	53, 84
SEPIA .....	56
Setup .....	46
CAMERA SET.....	50
HDD SET .....	57
Personal Menu.....	46, 63
PICT.APPLI.....	55
Setup items .....	48
STANDARD SET .....	59
STILL SET .....	54
TIME/LANGU.....	62
Using the Setup items....	46
SETUP ROTATE .....	62
Shoe cover .....	75
Shoulder belt.....	34
Slide show .....	34
Slide show button .....	27, 29, 34
Software.....	
See "Computer Application Guide"	
SP.....	59
Speaker .....	35
Specifications .....	96
SPORTS (Sports lesson) .....	50
SPOTLIGHT .....	50
SPOT FOCUS .....	52, 83
SPOT METER (Flexible spot meter) .....	50, 83
SQUEZE (Squeeze).....	60
STANDARD .....	55
STANDARD SET .....	59
START/STOP .....	24, 28
STEADYSHOT.....	54, 80
Still image	
IMAGE SIZE .....	55
QUALITY .....	55
Recording .....	25, 28
Still image files.....	92
STILL SET .....	54
Sub sound .....	59
SUMMERTIME.....	20, 62
SUNSET&MOON.....	50
SUPER NS (Super NightShot).....	53, 83
Supplied items .....	13
SUR MONITOR.....	59, 84
S VIDEO cable .....	40, 69, 71
S VIDEO jack.....	40, 69, 71

## T

Telephoto.....	32
Thumbnail .....	61, 100
TIME/LANGU. (Language).....	62
Touch panel .....	19
Transmitter .....	39
Tripod .....	34
TV .....	40
TV color system .....	90
TV TYPE.....	40

## U

USB1.1 .....	60
--------------	----

USB2.0.....	60, 100
USB cable .....	13, 73
USB jack .....	73, 75
USB SELECT .....	56
USB SPEED.....	60
Using abroad .....	90

## V

VBR .....	100
VF B.LIGHT (Viewfinder back light).....	60
VF WIDE DISP (View finder wide display) .....	60
Video operation buttons .....	37
Viewfinder .....	18
Brightness .....	60
Viewfinder lens adjustment lever .....	18
VISUAL INDEX....	26, 29, 100
Volume.....	27, 29
V-OUT/PANEL .....	62

## W

Wall socket.....	14
Warning indicators.....	86
Warning messages.....	86
WHITE BAL. (White balance).....	51, 83
WHITE FADER.....	55
Wide angle .....	32
WIDE SELECT.....	21
WIPE.....	55
Wireless microphone.....	33
Wireless Remote Commander ..... See <i>Remote Commander</i>	
World time difference .....	91

## Z

Zoom .....	32
Zoom lever .....	32
ZOOM LINK .....	61