

Digital Still Camera

Operating Instructions

Before operating the unit, please read this manual thoroughly, and retain it for future reference.

Owner's Record

The model and serial numbers are located on the bottom. Record the serial number in the space provided below. Refer to these numbers whenever you call upon your Sony dealer regarding this product.

Model No. DSC-S75

Serial No. _____

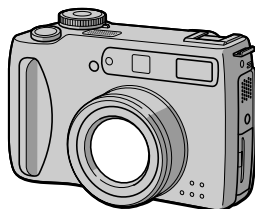

Cyber-shot
Digital Still Camera

 **InfoLITHIUM**

 **M**



MEMORY STICK™

DSC-S75

WARNING

To prevent fire or shock hazard, do not expose the unit to rain or moisture.

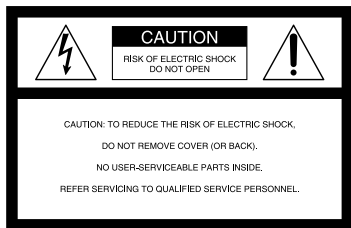
For the Customers in the U.S.A.



This symbol is intended to alert the user to the presence of uninsulated “dangerous voltage” within the product’s enclosure that may be of sufficient magnitude to constitute a risk of electric shock to persons.



This symbol is intended to alert the user to the presence of important operating and maintenance (servicing) instructions in the literature accompanying the appliance.

Never expose the battery pack to temperature above 60°C (140°F), such as in a car parked in the sun or under direct sunlight.

If you have any questions about this product, you may call:

Sony Customer Information Services Center
1-800-222-SONY (7669)

The number below is for the FCC related matters only.

Declaration of Conformity

Trade Name: SONY
Model No.: DSC-S75
Responsible Party: Sony Electronics Inc.
Address: 680 Kinderkamack
Road, Oradell, NJ
07649 USA
Telephone No.: 201-930-6972

This device complies with Part 15 of the FCC Rules. Operation is subject to the following two conditions: (1) This device may not cause harmful interference, and (2) this device must accept any interference received, including interference that may cause undesired operation.

CAUTION

You are cautioned that any changes or modifications not expressly approved in this manual could void your authority to operate this equipment.

Note:

This equipment has been tested and found to comply with the limits for a Class B digital device, pursuant to Part 15 of the FCC Rules. These limits are designed to provide reasonable protection against harmful interference in a residential installation. This equipment generates, uses, and can radiate radio frequency energy and, if not installed and used in accordance with the instructions, may cause harmful interference to radio communications. However, there is no guarantee that interference will not occur in a particular installation. If this equipment does cause harmful interference to radio or television reception, which can be determined by turning the equipment off and on, the user is encouraged to try to correct the interference by one or more of the following measures:

- Reorient or relocate the receiving antenna.
- Increase the separation between the equipment and receiver.

- Connect the equipment into an outlet on a circuit different from that to which the receiver is connected.
- Consult the dealer or an experienced radio/TV technician for help.

The supplied interface cable must be used with the equipment in order to comply with the limits for a digital device pursuant to Subpart B of Part 15 of FCC Rules.

For the Customers in the U.S.A.

DISPOSAL OF LITHIUM ION BATTERY.

LITHIUM ION BATTERY. DISPOSE OF PROPERLY.

You can return your unwanted lithium ion batteries to your nearest Sony Service Center.

Note:

In some areas the disposal of lithium ion batteries in household or business trash may be prohibited.

For the Sony Service Center nearest you call 1-800-222-SONY (United States only)

Caution:

Do not handle damaged or leaking lithium ion battery.

For the Customers in Germany

Directive:EMC Directive 89/336/EEC, 92/31/EEC

This equipment complies with the EMC regulations when used under the following circumstances:

- Residential area
- Business district
- Light-industry district

(This equipment complies with the EMC standard regulations EN55022 Class B.)

Attention for the Customers in Europe

This product has been tested and found compliant with the limits sets out on the EMC Directive for using connection cables shorter than 3 meters.

The electromagnetic fields at the specific frequencies may influence the picture and sound of this camera.

“Memory Stick”



For the Customers in the U.S.A. and Canada

THIS CLASS B DIGITAL DEVICE COMPLIES WITH PART 15 OF THE FCC RULES AND THE CANADIAN ICES-003 OPERATION IS SUBJECT TO THE FOLLOWING TWO CONDITIONS:
 (1) THIS DEVICE MAY NOT CAUSE HARMFUL INTERFERENCE, AND
 (2) THIS DEVICE MUST ACCEPT ANY INTERFERENCE RECEIVED, INCLUDING INTERFERENCE THAT MAY CAUSE UNDESIRE OPERATION.

Be sure to read the following before using your camera

Trial recording

Before you record one-time events, you may want to make a trial recording to make sure that the camera is working correctly.

No compensation for contents of the recording

Contents of the recording cannot be compensated for if recording or playback is not possible due to a malfunction of your camera or recording medium, etc.

Notes on image data compatibility

- This camera conforms with the Design Rules for Camera File Systems universal standard established by the JEITA (Japan Electric and Information Technology Industries Association). You cannot play back on your camera still images recorded on other equipment (DCR-TRV890E/TRV900/TRV900E, DSC-D700, DSC-D770) that does not conform with this universal standard. (These models are not sold in some areas.)
- Playback of images recorded with your camera on other equipment and playback of images recorded or edited with other equipment on your camera are not guaranteed.

Precaution on copyright

Television programs, films, video tapes, and other materials may be copyrighted. Unauthorized recording of such materials may be contrary to the provision of the copyright laws.

Do not shake or strike the camera

In addition to malfunctions and inability to record images, this may render the "Memory Stick" unusable or image data breakdown, damage or loss may occur.

Do not aim the camera at the sun or other bright light

This may cause irrecoverable damage to your eyes.

LCD screen, LCD finder (only models with a finder) and lens

- The LCD screen and the LCD finder are manufactured using extremely high-

precision technology so over 99.99% of the pixels are operational for effective use. However, there may be some tiny black points and/or bright points (white, red, blue or green in color) that constantly appear on the LCD screen and the LCD finder. These points are normal in the manufacturing process and do not affect the recording in any way.

- Be careful when placing the camera near a window or outdoors. Exposing the LCD screen, the finder or the lens to direct sunlight for long periods may cause malfunctions.

Do not get the camera wet

When taking pictures outdoors in the rain or under similar conditions, be careful not to get the camera wet. If moisture condensation occurs, refer to page 79 and follow the instructions on how to remove it before using the camera.

Back up recommendation

To avoid the potential risk of data loss, always copy (back up) data to a disk.

Handling of the movable lens

This camera uses a movable lens.

Be careful not to strike or apply excessive force to the lens portion.

When the camera is used for long periods

Note that the camera body may become hot.

About the Carl Zeiss lens

This camera is equipped with a Carl Zeiss lens which is capable of reproducing fine images. The lens for this camera uses the MTF* measurement system for cameras developed jointly by Carl Zeiss, in Germany, and Sony Corporation, and offers the same quality as other Carl Zeiss lenses.

* MTF is the abbreviation of Modulation Transfer Function/Factor, a numeric value indicating the amount of light from a specific part of the subject gathered at the corresponding position in the image.

Introduction

Checks the image after recording images

Recording still images:

page 19

Playing back still images:

page 28

Deleting images (DELETE):

page 67

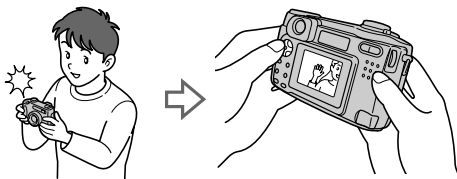

Captures images with your computer

You can copy images onto your computer and view and modify images or attach images to e-mail on your computer using the supplied USB cable and application software.

Viewing images using a personal computer: page 31

Recording still images for e-mail (E-MAIL): page 53

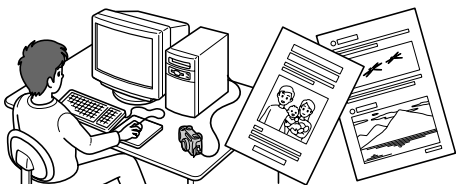

Records a moving picture (MPEG Movie or Clip Motion) according to your purpose

The digital still camera can record a moving

picture with audio (MPEG MOVIE):

page 26



Selects the recording mode from various types of recordings according to your situation

Creating Clip Motion Files: page 56

Adding audio files to still images (VOICE): page 54

Recording text documents (TEXT): page 55

Recording still images as uncompressed files (TIFF): page 56

Table of contents

Getting started

Identifying the parts	8
Preparing the power supply	10
Setting the date and time	15
Inserting the “Memory Stick”	17

Basic operations

► Recording

Recording still images	19
Recording moving images	26

► Playback

Playing back still images	28
Playing back moving images	29
Viewing images using a personal computer	31
Image file storage destinations and image files	38

Advanced operations

Before performing advanced operations

How to use the mode dial	40
How to use the control button	41
How to use the jog dial	42
Setting the image size (IMAGE SIZE)	47

► Various recording

Recording with the exposure fixed (AE LOCK)	49
Recording with the manual adjustments	50
Records images according to shooting conditions (SCENE SELECTION)	51
Recording two images continuously ...	52
Recording still images for e-mail (E-MAIL)	53
Adding audio files to still images (VOICE)	54
Recording text documents (TEXT)	55

Recording still images as uncompressed files (TIFF)	56
Creating Clip Motion Files	56
Setting the distance to the subject	58
Recording images in macro	58
Adjusting the exposure (EXPOSURE)	59
Adjusting the white balance (WHITE BALANCE)	60
Enjoying picture effects (P. EFFECT)	61
Recording the date and time on the still image (DATE/TIME)	61
Using the spot light-metering function	62

► Various playback

Playing back three or nine images at once	63
Enlarging a part of the still image (Zoom and trimming)	64
Playing back the still images in order (SLIDE)	65
Rotating a still image (ROTATE)	66
Viewing images on a TV screen	66

► Editing

Deleting images (DELETE)	67
Preventing accidental erasure (PROTECT)	68
Changing the recorded still image size (RESIZE)	70
Copying images (COPY)	71
Selecting still images to print (PRINT)	72
Dividing a moving image file (DIVIDE)	74
Changing the setup settings (SETUP) ...	76

Additional information

Precautions	79
On “Memory Sticks”	80
About “InfoLITHIUM” battery pack ..	81
Using your camera abroad	82
Troubleshooting	83
Warning and notice messages	89
Self-diagnosis display	91
Specifications	92
Display window indicators	93
LCD screen indicators	94
Index	97



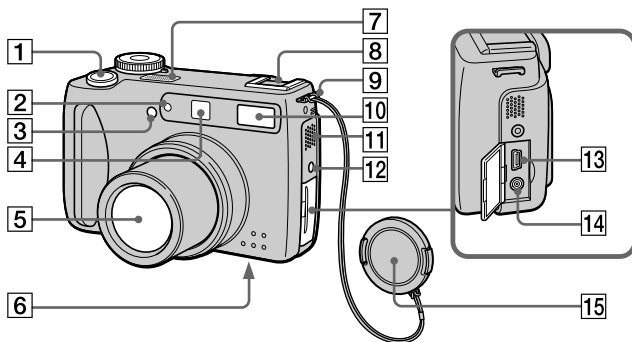

Identifying the parts

See the pages in parentheses for details of operation.

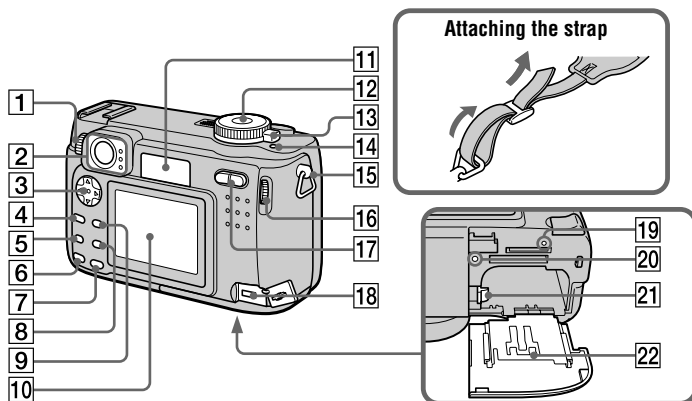

- | | |
|--|--|
| <p>1 Shutter button (19) (27)</p> <p>2 Self-timer (23) (27)/
AF illuminator (25)</p> <p>3 Photocell window for flash
Do not block while recording with the flash.</p> <p>4 Finder window</p> <p>5 Lens
When cleaning the lens, first return the lens to the fully retracted position and turn off the power, then gently wipe the lens.</p> <p>6 Tripod receptacle (bottom surface)
Use a tripod with a screw length of less than 5.5 mm (7/32 inch). You will be unable to firmly secure the camera to tripods having longer screws, and may damage the camera.</p> | <p>7 Built-in microphone
Do not touch while recording.</p> <p>8 Accessory shoe</p> <p>9 Hook for lens cap/strap</p> <p>10 Flash (24)</p> <p>11 Speaker</p> <p>12 ACC (Accessory) jack</p> <p>13 USB jack (33) (35)</p> <p>14 A/V OUT jack (66)
Audio output is monaural.</p> <p>15 Lens cap (supplied)
Be sure to remove the lens cap before recording.</p> |
|--|--|



- 1** Finder adjustment dial (21)
- 2** Finder
Self-timer/recording lamp (red)
AE/AF lock lamp (green)
⚡ Flash charge lamp (orange)
(24)
- 3** Control button (18) (41)
- 4** MENU button (41)
- 5**  (Exposure) button (59)
- 6** FOCUS button (58)
- 7** AE LOCK button (49)
- 8**  (spot meter) button (62)
- 9** DSPL/LCD ON/OFF button (23)
- 10** LCD screen
- 11** Display window
- 12** Mode dial (18) (40)
-  : To record still images,
VOICE mode audio data
 -  : To playback or edit
images
 -  : To record moving images
or Clip Motion images

SET UP: To set the setup items

SCN: To record in the SCENE
SELECTION mode

M: To record with the
manual adjustment

A: To record in the aperture
priority mode

S: To record in the shutter
speed priority mode

- 13** POWER switch (15)
- 14** POWER ON/OFF (CHG) lamp
(15)
- 15** Hook for strap
- 16** Jog dial (42)
- 17** Zoom button (for recording)
(22)
INDEX/zoom button (for
playback) (64)
- 18** DC IN jack (11) (14)
- 19** RESET button (83)
- 20** Access lamp (17)
- 21** Battery eject lever (10)
- 22** Battery/"Memory Stick" cover

Preparing the power supply

Installing the battery pack

Your camera operates only with the “InfoLITHIUM” NP-FM50 battery pack* (M series). You cannot use any other battery pack. See page 81 for more information about “InfoLITHIUM” battery pack.

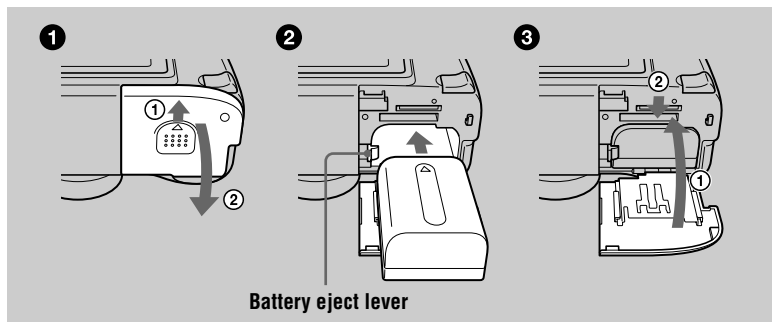

- 1 Open the battery/“Memory Stick” cover.**
Slide the cover in the direction of the arrow.
- 2 Install the battery pack.**
Insert the battery pack with the ▲ mark facing toward the battery compartment as illustrated.
- 3 Close the battery/“Memory Stick” cover.**

To remove the battery pack

Open the battery/“Memory Stick” cover. Slide the battery eject lever downward, and remove the battery pack.

Be careful not to drop the battery pack when removing it.

* What is “InfoLITHIUM”?

“InfoLITHIUM” is a lithium ion battery pack which can exchange information such as battery consumption with compatible video equipment. This unit is compatible with the “InfoLITHIUM” battery pack (M series). “InfoLITHIUM” M series battery packs have the  mark. “InfoLITHIUM” is a trademark of Sony Corporation.

Charging the battery pack

You cannot charge the battery pack while your camera is turned on. Be sure to turn off your camera.

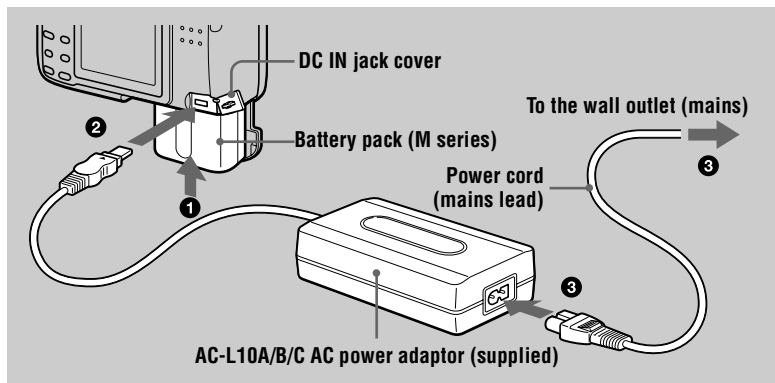

- 1** Insert the battery pack into your camera.
- 2** Open the DC IN jack cover and connect the DC connecting cable to the DC IN jack of your camera with the ▲ mark facing up.
- 3** Connect the power cord (mains lead) to the AC power adaptor and then to a wall outlet (mains).
The battery indicator  flashes when charging begins. When the flashing stops and the FULL indicator appears in the display window, charging is completed.

After charging the battery pack

Disconnect the AC power adaptor from the DC IN jack on your camera.

Battery remaining indicator

The LCD screen on the camera shows the remaining time for which you can still record or play back images.

This indication may not be entirely accurate depending on the conditions of use and the operating environment.

Charging at 10°C to 30°C (50°F to 86°F) circumstances is recommended.

Using your camera abroad

For details, see page 82.

NP-FM50 battery pack

When you record images in an extremely cold location or using the LCD screen, the operating time becomes short. When using the camera in an extremely cold location, place the battery pack in your pocket or other place to keep it warm, then insert the battery pack into the camera just before recording. When using a pocket heater, take care not to let the heater directly contact the battery.

Charging time

Battery pack	Full charge (min.)
NP-FM50 (supplied)	Approx. 150

Approximate time to charge a completely discharged battery pack using the AC-L10A AC power adaptor at a temperature of 25°C (77°F).

Battery life and number of images that can be recorded/played back

Still image recording*

	NP-FM50 (supplied)	
	Battery life (min.)	Number of images
LCD screen ON	Approx. 150	Approx. 2500
LCD screen OFF	Approx. 180	Approx. 3000

Still image playback**

	NP-FM50 (supplied)	
	Battery life (min.)	Number of images
LCD screen ON	Approx. 270	Approx. 5000

Approximate battery life and number of images that can be recorded/played back with a fully charged battery pack at a temperature of 25°C (77°F), 640×480 image size, standard picture quality and in NORMAL recording mode.

* Recording at about 4-second intervals

**Playing back single images in order at about 3-second intervals

Moving image recording

	NP-FM50 (supplied)	
	LCD screen OFF (min.)	LCD screen ON (min.)
Continuous recording	Approx. 210	Approx. 170

Approximate recording time with a fully charged battery pack at a temperature of 25°C (77°F) and 160×112 image size.

Notes

- The battery life and number of images will be decreased if you use your camera at low temperatures, use the flash, repeatedly turn the power on/off or use the zoom.
- The numbers of images shown on tables above are as a guide. The numbers may be smaller depending on conditions.
- The capacity of the “Memory Stick” is limited. The above figures are a guide when you continuously record/play back while replacing the “Memory Stick.”
- “----” appears in the display window until the battery usable time is calculated.
- During charging, the indicators in the display window may not appear correctly or may flash in the following cases.
 - When the battery pack is not installed correctly.
 - When the AC power adaptor is disconnected.
 - When the battery pack has malfunctioned.
- When you turn the LCD screen on and off, it takes about one minute for the correct battery remaining time to appear.
- If sufficient battery remaining time is indicated but the power runs out soon, fully charge the battery so that the correct battery remaining time appears.
- Do not short the DC plug of the AC power adaptor with a metallic object, as this may cause malfunction.

Using the AC power adaptor

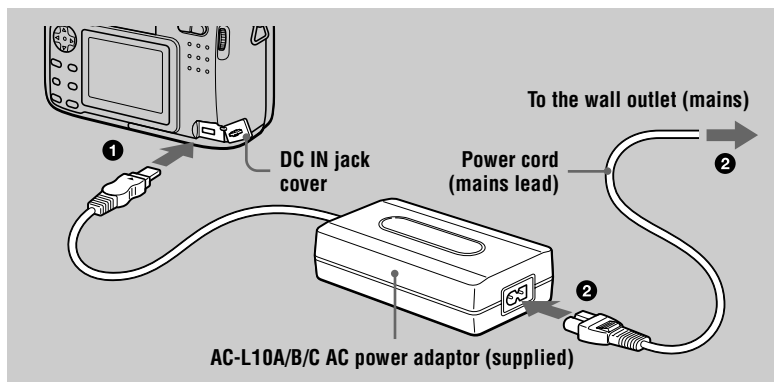

- 1** Open the DC IN jack cover and connect the DC connecting cable to the DC IN jack of your camera with the ▲ mark facing up.
- 2** Connect the power cord (mains lead) to the AC power adaptor and then to a wall outlet (mains).

Using a car battery

Use Sony DC adaptor/charger (not supplied).

When using the AC power adaptor

Be sure to use it near the wall outlet. If a malfunction occurs, disconnect the plug from the wall outlet.

Setting the date and time

When you first use your camera, set the date and time. If these are not set, the CLOCK SET screen appears whenever you turn on your camera.

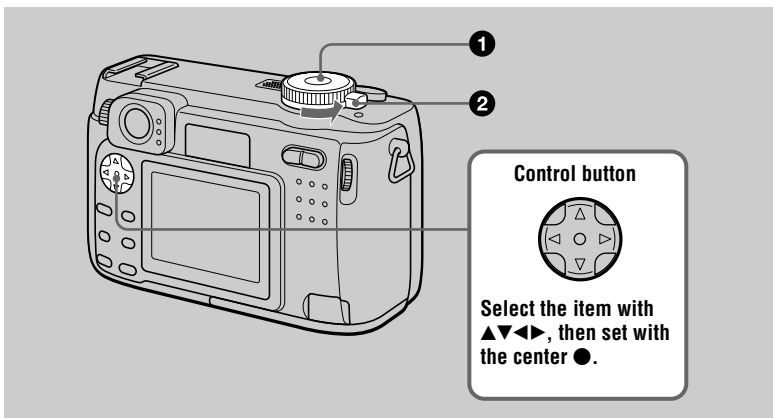

1 Set the mode dial to , S, A, M, SCN, , or .

2 Slide the **POWER** switch in the direction of the arrow to turn on the power.

The POWER ON/OFF (CHG) lamp (green) lights up.
The CLOCK SET screen appears on the LCD screen.

To change the date and time, set the mode dial to SET UP (page 77) and perform the procedure from step **3**.

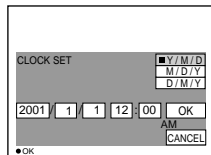

3 Select the desired date display format with ▲/▼ on the control button, then press the center ●.

Select from [Y/M/D] (year/month/day), [M/D/Y] (month/day/year) or [D/M/Y] (day/month/year).

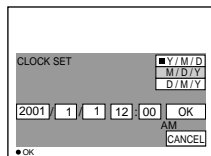

- 4** Select the year, month, day, hour or minute item you want to set with ◀/▶ on the control button.

The item to be set is indicated with ▲/▼.

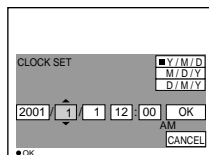

- 5** Set the numeric value with ▲/▼ on the control button, then press the center ● to enter it.

After entering the number, ▲/▼ moves to the next item.

If you selected [D/M/Y] in step 3, set the time on a 24-hour cycle.

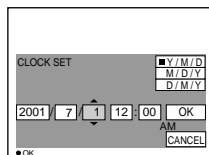

- 6** Select [OK] with ▶ on the control button, then press the center ● at the desired moment to begin clock movement.

The date and time are entered.

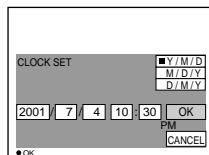

To cancel the date and time setting

Select [CANCEL] with ▲/▼/◀/▶ on the control button, then press the center ●.

Note

If the rechargeable button battery is ever fully discharged (page 80), the CLOCK SET screen will appear again. When this happens, reset the date and time, by starting from step 3 above.

Inserting the “Memory Stick”

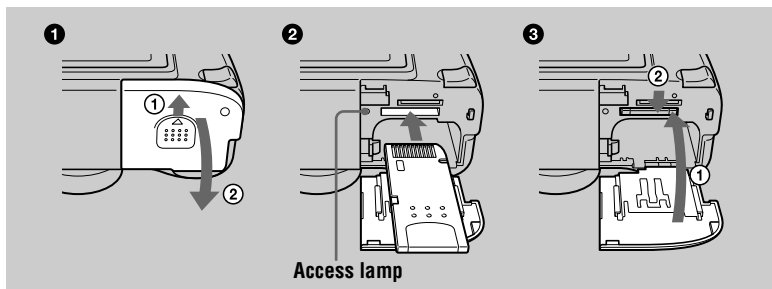

- 1** **Open the battery/“Memory Stick” cover.**
Slide the cover in the direction of the arrow.
- 2** **Insert the “Memory Stick.”**
Insert the “Memory Stick” with the ► mark facing toward the battery compartment as illustrated until it clicks.
- 3** **Close the battery/“Memory Stick” cover.**

Removing the “Memory Stick”

Open the battery/“Memory Stick” cover, then press the “Memory Stick” once lightly.

Notes

- Insert the “Memory Stick” firmly until it clicks, otherwise a message such as “MEMORY STICK ERROR” will be displayed.
- Never remove the “Memory Stick” or turn off the power while the access lamp is lit up.
- You cannot record or edit images on a “Memory Stick” if the erasure prevention switch is set to the LOCK position.

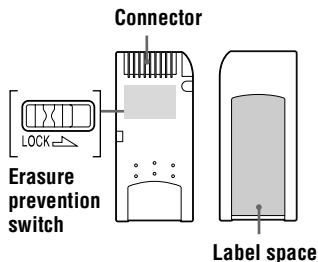





The position and shape of the erasure prevention switch may differ depending on the types of “Memory Stick” used.

Basic operations

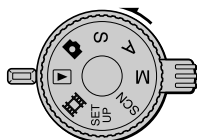
How to use the mode dial

The mode dial switches the function which is used for recording, playback, or editing. Set the dial as follows before starting to operate your camera.





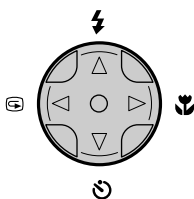

- : To record still images, VOICE mode audio data
- : To play back or edit images
- : To record moving images or Clip Motion images
- SET UP:** To set the setup items (The SET UP position changes the settings of infrequently-used items.)
- M:** To record with the shutter speed and aperture set manually
- A:** To record in the aperture priority mode
- S:** To record in the shutter speed priority mode
- SCN:** To record in the SCENE SELECTION mode (Set in advance the SCENE SELECTION in SET UP screen)

How to use the control button

When the menu is not displayed, the control button is used to perform the following operations.



-  (▲): Recording with flash
-  (▼): Recording with self-timer
-  (◀): Checking the last recorded image
-  (▶): Recording close subjects

Recording still images

Still images are recorded in JPEG format.

Before recording still images, slide the POWER switch in the direction of the arrow to turn on the power and insert a “Memory Stick.”

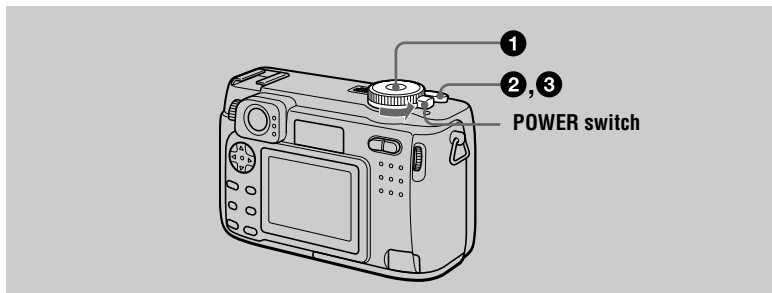

1 Set the mode dial to , S, A, M or SCN.

2 Press and hold the shutter button halfway down.

The image freezes momentarily, but is not yet recorded. While the AE/AF lock indicator ● is flashing, the camera automatically adjusts the exposure and focus of the captured image. When the camera finishes the automatic adjustments, the AE/AF lock indicator ● stops flashing, then lights up and the camera is ready for recording.*

If you release the shutter button, the recording will be canceled.

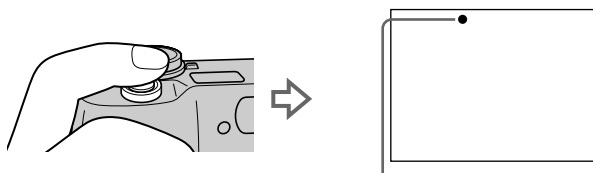

AE/AF lock indicator (green) flashes → lights up

3 Press the shutter button fully down.

The shutter sounds.

“RECORDING” appears on the LCD screen, and the image will be recorded on the “Memory Stick.” When “RECORDING” disappears, you can record the next image.

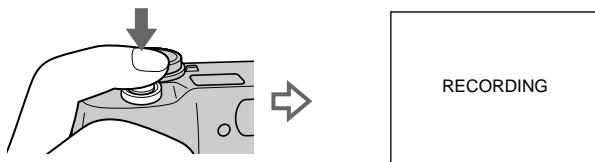

* If the flashing AE/AF lock indicator changes to flashing slowly, the subject may be difficult to focus on (dark, poor contrast) or the subject may be extremely close. Release the shutter button, then focus again.

Auto power-off function

If you do not operate the camera for about three minutes during recording or playback, the camera turns off automatically to prevent wearing down the battery. To use the camera again, slide the POWER switch in the direction of the arrow to turn on the camera again. The auto power-off function only operates when the camera is operating using a battery pack. The auto power-off also will not operate when playing back moving images or playing back a SLIDE SHOW (page 65), or when a connector is plugged into the USB jack, the DC IN jack, or the A/V OUT jack.

The number of images you can record on a “Memory Stick” (8 MB)

See pages 48 and 53 to 57.

Notes

- Do not touch the lens portion while it is operating.
- When recording a bright subject, the LCD screen color may change after AE/AF lock, but this does not affect the recorded image.
- When you press the shutter button fully down at once in step 2, the camera starts recording after the automatic adjustment is complete. However, the recording cannot be carried out while the  flash charge lamp (page 21) is flashing. (During this time, the camera is charging the flash.)

Recording images with the finder

You can extend the battery time by turning off the LCD screen and recording using the finder. Turn the finder adjustment dial until the image appears clearly within the finder, then record the image.

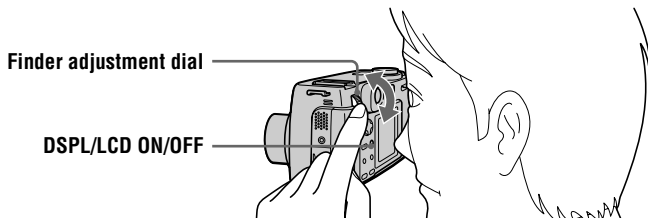

Indicators in the finder

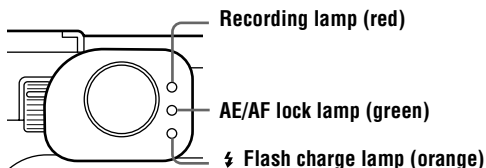

Checking the last recorded image (Quick Review)

You can check the last recorded image by clearing the menu from the screen (page 41) and pressing ◀ (⊞) on the control button.

To return to the normal recording mode: press lightly on the shutter button or press ◀ (⊞) again.

To delete the image: 1. Press MENU. 2. Select [DELETE] with ▶ on the control button, then press the center ●. 3. Select [OK] with ▲ on the control button, then press the center ●.

Using the zoom feature

The lens portion moves during zoom operation. Be careful not to touch the lens portion while it is operating.

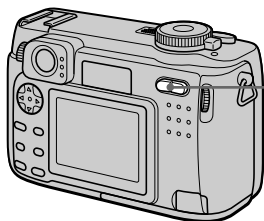

Zoom button

W side: for wide-angle (subject appears farther away)

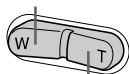

T side: for telephoto (subject appears closer)

Minimum focal distance to the subject

W side: About 50 cm (19 3/4 inches) or more

T side: About 50 cm (19 3/4 inches) or more

To record even closer subjects, see page 58.

Digital zoom function

This camera has a digital zoom function.

Digital zoom enlarges the image by digital processing and it starts to function when zoom exceeds 3 \times .

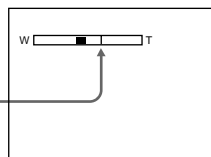

The T side of the bar shows the digital zooming zone.

Using digital zoom

- The maximum zoom magnification is 6 \times .
- Digital zooming deteriorates the picture quality. When digital zoom is not necessary, set [DIGITAL ZOOM] to [OFF] in the setup settings (page 76).

Notes

- Zoom does not work for moving images.
- Use the LCD screen when using the digital zoom function. Digitally zoomed images do not appear in the finder.
- The AF frame (page 94) does not appear on the LCD screen.

The indicators on the LCD screen

Each time you press DSPL/LCD ON/OFF, the status of the LCD screen changes as follows:

The LCD backlight is turned on.
(All the available indicators are turned on.)



The LCD backlight is turned on.
(Warning messages and manual adjustment items which are set using the jog dial are turned on.)



The LCD backlight is turned off.

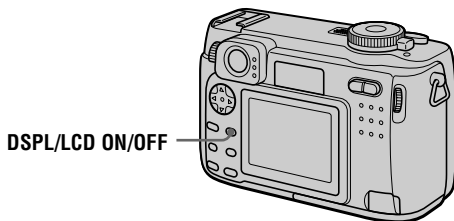

See page 94 for a detailed description of the indicated items.

Notes

- Because of the difference of the portion of the finder and the lens, use the LCD screen when you record a subject closer than 1 m (3 1/4 feet).
- You cannot turn off the LCD screen when [DEMO] or [CONVERSION LENS] are set to [ON] in the SET UP settings.
- You cannot turn off the LCD backlight in SET UP and when displaying the menu.
- You cannot turn off the self-timer indicators and some of the indicators used in advanced operations.
- The indicators on the LCD screen are not recorded.

Using the self-timer

When you use the self-timer function, the subject is recorded about 10 seconds after you press the shutter button.

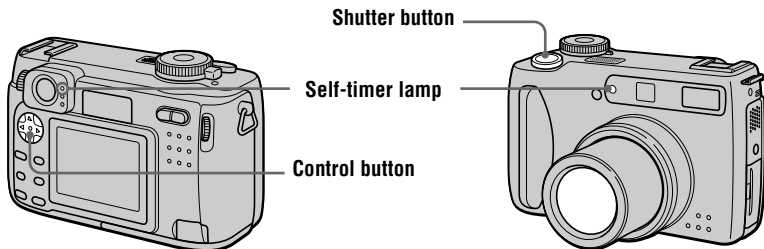

Clear the menu (page 41), then press the control button \blacktriangledown (⊙). The ⊙ (self-timer) indicator appears on the LCD screen, and about 10 seconds after you press the shutter button, the subject is recorded. The self-timer lamp flashes and the beep sounds after you press the shutter button until the shutter is released. To cancel the self-timer recording, press the control button \blacktriangledown (⊙) again.

Recording images with the flash

The factory setting is auto (no indicator). In this mode, the flash automatically strobes when the surroundings is dark. To change the flash mode, clear the menu (page 41), then press the control button \blacktriangle (⚡) repeatedly so that the flash mode indicator appears on the LCD screen.

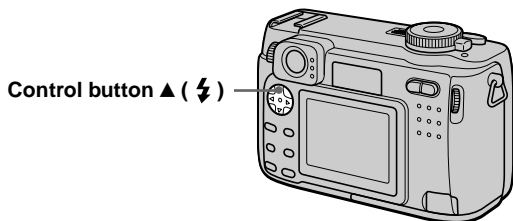

Each time you press the control button \blacktriangle (⚡), the indicator changes as follows.

(No indicator) \rightarrow ⚡ \rightarrow ⊙ \rightarrow (No indicator)

⚡ Forced flash: The flash strobes regardless of the surrounding brightness.

⊙ No flash: The flash does not strobe.

You can change the brightness of the flash with [⚡ \pm] (FLASH LEVEL) in the menu settings (page 44).

To reduce the red-eye phenomenon

Set [RED EYE REDUCTION] to [ON] in the setup settings, the flash strobes before recording to reduce the red-eye phenomenon (page 76). When [ON] is selected, \bullet appears on the LCD screen.

Notes

- When [ISO] is set to [AUTO] in the menu settings, the recommended shooting distance using the built-in flash is 0.3 m to 3.0 m (11 7/8 inches to 9 feet 10 1/8 inches). When it is not set to [AUTO], the flash may be ineffective even if the flash level is changed.
- Attaching a conversion lens (not supplied) may block the light from the flash or cause the lens shadow to appear.
- You cannot use an external flash (not supplied) and the built-in flash at the same time.
- Red-eye reduction may not produce the desired effects depending on individual differences, the distance to the subject, if the subject does not see the pre-strobe, or other conditions.
- Red-eye reduction effects are also difficult to obtain if you set the shutter to a slow speed in the shutter speed priority mode.
- The flash effect is not obtained easily when you use forced flash in a bright location.
- While charging the flash, the ⚡ flash charge lamp flashes. After the charging is complete, the lamp goes out.

- The flash does not function when recording moving images (excluding Clip Motion) or recording in BURST2 mode.

Recording images with the AF illuminator

The AF illuminator is fill light to focus on a subject easily. Set [AF ILLUMINATOR] (page 76) to [ON] in the setup settings, **AF ON** appears on the LCD screen and the AF illuminator emits light when the shutter button is pressed halfway. It keeps emitting light until the focus is locked.

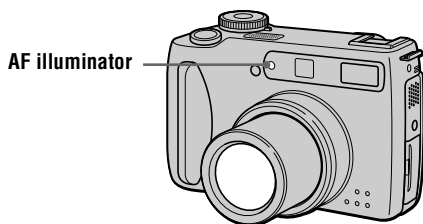

Notes

- If AF illuminator light does not reach the subject sufficiently or the subject has no contrast, focus will not be achieved. (Approximate 0.3 to 3.0 m (11 7/8 inches to 9 feet 10 1/8 inches) distance is recommended.)
- In TWILIGHT mode of the SCENE SELECTION function (page 51), the AF illuminator will emit only when the flash mode is set to **⚡** (Forced flash).
- The AF illuminator will not emit when the LANDSCAPE mode of the SCENE SELECTION function (page 51) is selected or [CONVERSION LENS] (page 77) is set to [ON] in the setup settings.
- Focus is achieved as long as AF illuminator light reaches to the subject even if its light is slightly out of the middle position of the subject.
- The AF illuminator does not operate when adjusting focus manually.
- The AF illuminator is a very bright light. Although it is safe to use, avoid shining it directly into someone's eyes at a close distance.

Recording moving images

Moving images with audio are recorded in MPEG format (page 39).

To record moving images, slide the POWER switch in the direction of the arrow to turn on the power and insert a “Memory Stick.”

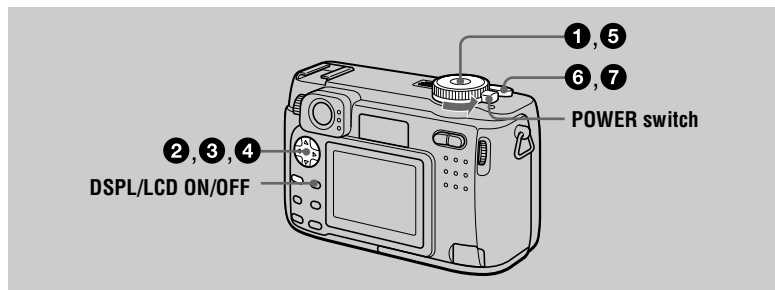

1 Set the mode dial to SET UP.

2 Select [CAMERA] with ▲/▼ on the control button, then press ►.

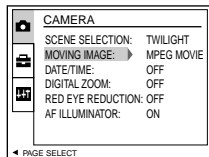

3 Select [MOVING IMAGE] with ▲/▼ on the control button, then press ►.

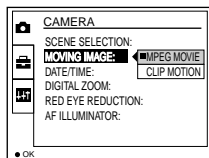

4 Select [MPEG MOVIE] with ▲/▼ on the control button, then press the center ●.

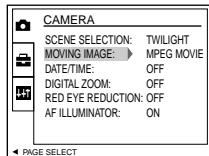

5 Select the mode dial to .

-
- 6 Press the shutter button fully down.**
“REC” appears on the LCD screen, and recording of the image and sound on the “Memory Stick” begins.
-

- 7 Press the shutter button fully down again to stop recording.**
The recording stops.
When selecting the 320 (HQ) size: The recording stops in approximate 15 seconds (page 47).
When selecting the 320×240 or 160×112 sizes: The recording stops when the “Memory Stick” is full.
For details on the image size, see “Setting the image size (IMAGE SIZE)” on page 47.
-

Using the self-timer

When you use the self-timer function, the subject is recorded about 10 seconds after you press the shutter button.

Clear the menu (page 41), then press the control button ▼ (⊙). The ⊙ (self-timer) indicator appears on the LCD screen, and the recording starts about 10 seconds after you press the shutter button. The self-timer lamp flashes and the beep sounds after you press the shutter button until the shutter is released. To stop the self-timer recording, press the control button ▼ (⊙) again.

LCD screen indicators during recording

Each time you press DSPL/LCD ON/OFF, the status of the LCD screen changes as follows: all indicators on → indicators off → LCD screen off.

These indicators are not recorded. See page 95 for a detailed description of the indicators.

Playing back still images

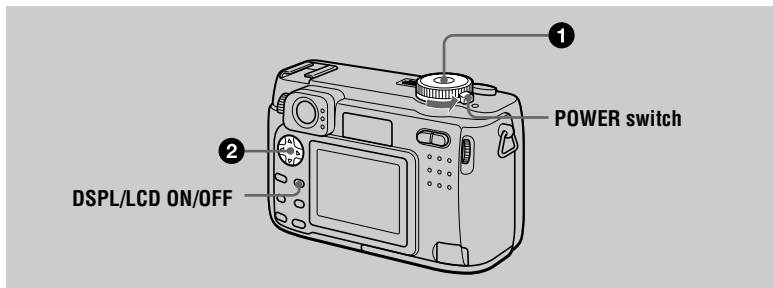

- 1 Set the mode dial to .
The last recorded image (still or moving) appears on the LCD screen.

- 2 Select the desired still image with the control button / .

- ◀: To display the preceding image.
- ▶: To display the next image.

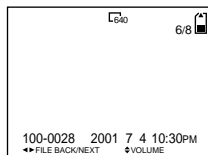

Notes

- You might not be able to correctly play back images recorded with this camera on other equipment.
- You cannot play back on this camera images larger than the maximum image size that can be recorded with this camera.
- A rough image is played back, followed by the normal image.

LCD screen indicators during still image playback

Each time you press DSPL/LCD ON/OFF, the status of the LCD screen changes as follows: all indicators on → indicators off → LCD screen off.
See page 96 for a detailed description of the indicators.

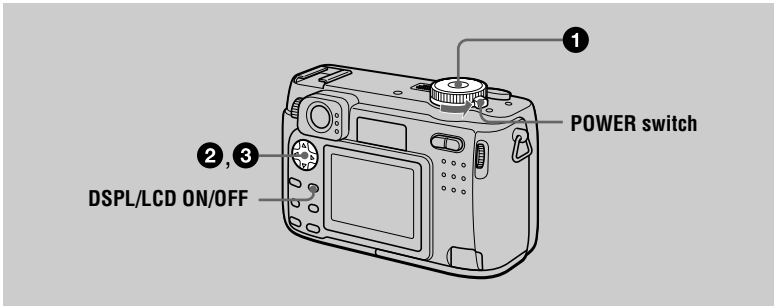

Playing back moving images

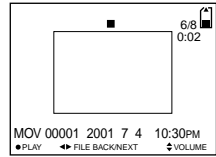

1 Set the mode dial to .
The last recorded image (still or moving) appears on the LCD screen.

2 Select the desired moving image with the control button .
Moving images are displayed one-size smaller than still images.
◀: To display the preceding image.
▶: To display the next image.



3 Select the center  to start the playback.
The moving image and sound are played back.
During playback,  (playback) appears on the LCD screen.
To advance or rewind, press the control button  during playback.

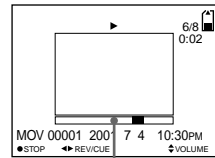



Playback bar

To pause playback

Press the center  on the control button to stop the playback.

To advance or rewind the moving image

Press the control button  during playback.

To return to the normal playback, press the center  on the control button.

Moving images recorded with the image of [320 (HQ)] (page 47)

The images are displayed over the entire screen in steps ② and ③.

Adjusting the volume

Press the control button ▲/▼ to adjust the volume.

LCD screen indicators during moving image playback

Each time you press DSPL/LCD ON/OFF, the status of the LCD screen changes as follows: all indicators on → indicators off → LCD screen off.

See page 96 for a detailed description of the indicators.

Viewing images using a personal computer

You can view data recorded with your camera on a personal computer, modify and attach it to e-mail using application software. This section describes the method for viewing images on a personal computer using the supplied USB cable.

There are two ways to make the USB connection, which are the normal connection and the PTP connection (page 77). This is set using [USB CONNECT] in the setup settings. Here describes the way using the [NORMAL] setting. Users will be informed at the Sony website when PTP connection is supported.

The factory setting of USB mode is [NORMAL].

The mode can be checked and set as follows.

- ① Set the mode dial to SET UP.
- ② Select [SETUP2] with ▲/▼, then press ►.
- ③ Select [USB CONNECT] with ▲/▼, then press ►.
- ④ Select the connection mode with ▲/▼.

The USB cable is used to connect the camera to a personal computer so that operations can be performed on image files recorded in a “Memory Stick” from the personal computer.

In order to use the USB cable, a USB driver must be installed in the personal computer beforehand.

Be sure to also refer to the operation manuals for your personal computer and the application software.

Notes

- Data recorded with your camera is stored in the following formats. Make sure that applications that support these file formats are installed on your personal computer.
 - Still images (other than TEXT mode, uncompressed mode and Clip Motion): JPEG format
 - Moving images/audio: MPEG format
 - Uncompressed mode still images: TIFF format
 - TEXT mode/Clip Motion: GIF format
- Depending on your application software, the file size may increase when you open a still image file.
- When you copy the image to the camera from your computer, which was modified with a retouching software and was converted to another file format, the “FILE ERROR” message may appear and you may be unable to open the image.
- Depending on your application software, only the first frame of the Clip Motion file may be played back.

Communications with your computer (for Windows only)

Communications between your camera and your computer may not recover after recovering from Suspend or Sleep.

Recommended computer environment

Recommended Windows environment

OS: Microsoft Windows 98, Windows 98SE, Windows 2000 Professional, Windows Millennium Edition

The above OS is required to be installed at the factory.

Operation is not assured in an environment upgraded to the operating systems described above.

CPU: MMX Pentium 200 MHz or faster

The USB connector must be provided as standard.

Recommended Macintosh environment

Macintosh computer with the Mac OS 8.5.1/8.6/9.0/9.1 standard installation

However, note that the update to Mac OS 9.0/9.1 should be used for the following models.

- iMac with the Mac OS 8.6 factory pre-installed and a slot loading type CD-ROM drive
- iBook or Power Mac G4 with the Mac OS 8.6 factory pre-installed

The USB connector must be provided as standard.

QuickTime 3.0 or newer must be installed (to play back moving pictures).

Notes

- If you connect two or more USB equipment to a single personal computer at the same time, some equipment may not operate depending on the type of USB equipment.
- Operations are not guaranteed when using a hub.
- Operations are not guaranteed for all the recommended computer environments mentioned above.

-
- Microsoft and Windows are registered trademarks of Microsoft Corporation in the United States and /or other countries.
 - Macintosh and Mac OS, QuickTime are either registered trademarks or trademarks of Apple Computer, Inc.
 - All other product names mentioned herein may be the trademarks or registered trademarks of their respective companies. Furthermore, “™” and “®” are not mentioned in each case in this manual.

Installing the USB driver

Before connecting your camera to your personal computer, install the USB driver to the computer. The USB driver is included with the application software in the CD-ROM which is supplied with your camera.

Be sure to complete installation of the USB driver before connecting the USB cable. If you connect the USB cable first, you will be unable to install the USB driver properly.

See page 88 for corrective measures if the USB cable was connected before installing the driver and the driver software could not be installed correctly.

For Windows 98/98SE/Me and Windows 2000 users

- 1 Turn on your personal computer and allow Windows to load.**
Do not connect the USB cable in this step.
- 2 Insert the supplied CD-ROM in the CD-ROM drive of your personal computer.**
The application software screen appears.
- 3 Click “USB Driver Installation for Windows 98/98SE/Me and Windows 2000”.**
USB driver installation starts.
- 4 Follow the on-screen messages to install the USB driver.**
Your personal computer may restart.
- 5 Connect the USB jack (mini-B) on your camera with the USB connector on your personal computer using the supplied USB cable.**

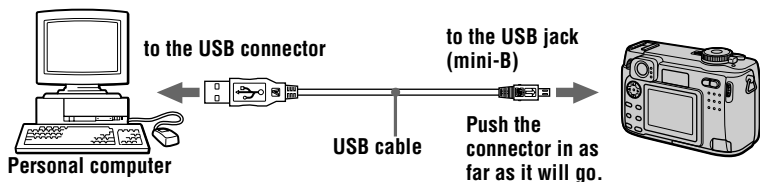

- 6 Insert a “Memory Stick” into your camera, connect the AC power adaptor and turn on your camera.**
“USB MODE” appears on the LCD screen of your camera and the camera is set to communication standby mode. Your personal computer recognizes the camera, and the Windows Add Hardware Wizard starts.

7 Follow the on-screen messages to have the Add Hardware Wizard recognize the hardware.

The Add Hardware Wizard starts twice because two different USB drivers are to be installed. Be sure to allow the installation to complete without interrupting it.

Notes

- Do not connect the USB cable before the USB driver installation is completed in step 4.
- In step 7, make sure that a “Memory Stick” is inserted into your camera before installing the USB driver. Otherwise, you will be unable to install the USB driver.

For Macintosh users

• **When using MacOS9.1**

It is not necessary to install the USB driver. The Macintosh recognizes the camera as a drive simply by connecting it to the Macintosh with the USB cable.

• **When using MacOS8.5.1/8.6/9.0**

Follow the procedures below to install the driver.

1 Turn on your personal computer and allow the Mac OS to load.

2 Insert the supplied CD-ROM in the CD-ROM drive of your personal computer.

3 Double-click the CD-ROM drive icon to open the window.

4 Double-click the icon of the hard disk containing the OS to open the window.

5 Move the following two files from the window opened in step 3 to the “System Folder” icon in the window opened in step 4 (drag and drop).

- Sony USB Driver
 - Sony USB Shim
-

6 When “Put these items into the Extensions folder?” appears, click “OK.”

7 Restart your personal computer.

Viewing images

When viewing moving images on a Windows system, RealPlayer, Windows Media Player or other moving image playback applications must be installed. When viewing moving images on a Macintosh system, QuickTime 3.0 or later must be installed.

- 1 Turn on the power of your personal computer and allow Windows or Mac OS to load.
- 2 Connect the USB jack (mini-B) on the camera with the USB connector on your personal computer using the supplied USB cable.

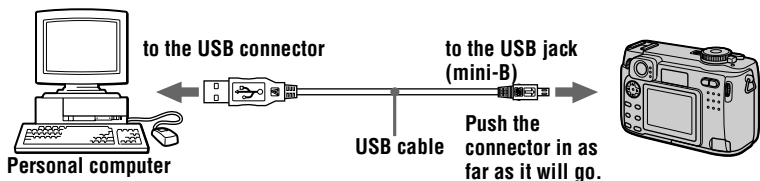

- 3 Insert a "Memory Stick" into your camera, and connect the AC power adaptor to your camera and then to a wall outlet (mains).
- 4 Turn on the power of your camera.
"USB MODE" appears on the LCD screen of the camera.

For Windows 98/98SE/Me and Windows 2000 users

- 5 Open "  My Computer" on Windows and double click the newly recognized drive. (Example: "Removable Disk (E:)")
The folders inside the "Memory Stick" are displayed.
If the drive is not recognized, see "Troubleshooting" on page 83.

6 Select and double-click the desired image/sound file from the folder.

For the detailed folder and file name, see “Image file storage destinations and image files” on page 38.

Desired file type	Double-click in this order
Still image	“Dcim” folder → “100msdcf” folder → Image file
Moving image*	“Mssony” folder → “Moml0001” folder → Image file*
Audio*	“Mssony” folder → “Momlv100” folder → Audio file*
Clip Motion image	“Dcim” folder → “100msdcf” folder → Image file
E-mail image TIFF image (uncompressed)	“Mssony” folder → “Imcif100” folder → Image file

* Copying a file to the hard disk of your personal computer before viewing it is recommended. If you play back the file directly from the “Memory Stick”, the image and sound may break off.

For Macintosh users

Follow the procedure **1** – **4** on page 35.

5 Double click the newly recognized icon on the desktop.

The folders inside the “Memory Stick” are displayed.

6 Select and double-click the desired image/sound file from the folder.

Notes on using your personal computer

“Memory Stick”

- Operation is not guaranteed if you are using a “Memory Stick” that was formatted with a personal computer, or if you used a personal computer to format the “Memory Stick” in your camera through a USB connection.
- Do not optimize the “Memory Stick” on a Windows machine. This will shorten the “Memory Stick” life.
- Do not compress the data on the “Memory Stick.” Compressed files cannot be played back on your camera.

For Windows Me and Windows 2000 users

The following procedures are recommended when disconnecting the USB cable from your personal computer or ejecting the “Memory Stick” from the camera while it is connected to your personal computer.

- 1** Stop the drive by clicking on the “Unplug/Eject” icon in the task tray.
- 2** When the message appears confirming the safe removal of the hardware, disconnect the USB cable or eject the “Memory Stick”.

Software

- Depending on your application software, the file size may increase when you open a still image file.
- When you load an image modified using the supplied retouch software from your personal computer to the camera or when you directly modify the image on the camera, the image format will differ so the “FILE ERROR” message may appear and you may be unable to open the file.
- Depending on your application software, only the first frame of the Clip Motion file may be played back.

Communications with your personal computer (for Windows only)

Communications between your camera and your personal computer may not recover after recovering from Suspend, Resume, or Sleep.

Image file storage destinations and image files

Image files recorded with your camera are grouped in folders by recording mode. The meanings of the file names are as follows. □□□□ stands for any number within the range from 0001 to 9999.

For Windows Me users (The drive recognizing the camera is "E.")

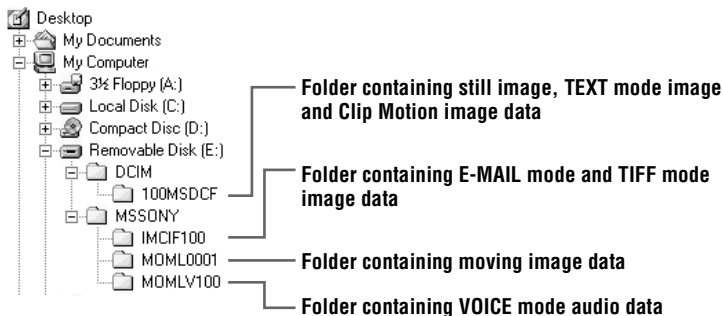

Folder	File	Meaning
100MSDCF	DSC0□□□□.JPG	<ul style="list-style-type: none"> • Still image file recorded normally • Still image file recorded in <ul style="list-style-type: none"> – E-MAIL mode (page 53) – TIFF mode (page 56) – VOICE mode (page 54) – Burst mode (page 52)
	CLP0□□□□.GIF	• Clip Motion file recorded in NORMAL mode (page 56)
	CLP0□□□□.THM	• Index image file of Clip Motion file recorded in NORMAL mode
	MBL0□□□□.GIF	• Clip Motion file recorded in MOBILE mode (page 56)
	MBL0□□□□.THM	• Index image file of Clip Motion file recorded in MOBILE mode
	TXT0□□□□.GIF	• Still image file recorded in TEXT mode (page 55)
	TXT0□□□□.THM	• Index image file of still image file recorded in TEXT mode

Folder	File	Meaning
IMCIF100	DSC0□□□□.JPG	• Small-size image file recorded in E-MAIL mode (page 53)
	DSC0□□□□.TIF	• Uncompressed image file recorded in TIFF mode (page 56)
MOML0001	MOV0□□□□.MPG	• Moving image file recorded normally
MOMLV100	DSC0□□□□.MPG	• Audio file recorded in VOICE mode (page 54)

The numerical portions of the following files are the same.

- A small-size image file recorded in E-MAIL mode and its corresponding image file
- An uncompressed image file recorded in TIFF mode and its corresponding image file
- An audio file recorded in VOICE mode and its corresponding image file
- An image file recorded in TEXT mode and its corresponding index image file
- An image file recorded with Clip Motion and its corresponding index image file

Tips

The digital still camera saves recorded images as digital data. The format of the saved data is called as the file format. The formats that can be used with this camera are as follows:

JPEG format

Most digital still cameras, operating systems of computers, and browser software adopt this format. This format is able to compress files without appreciable deterioration. However, if the image is compressed and saved on repeated occasions, the image will deteriorate. This camera records still images using the JPEG format for normal recording.

GIF format

Using this format, the image will not deteriorate even if the image is compressed and saved on repeated occasions. This format limits the number of colors to 256 colors. This camera records still images using the GIF format in Clip Motion (page 56) or TEXT mode (page 55).

TIFF format

Stores shooting images without compression, so the image does not deteriorate. Most of operating systems and applications correspond to this format. This camera records still images using the TIFF format for the TIFF mode (page 56).

MPEG format

This format is very typical for moving images. This camera records audio using the MPEG format for the moving images recording and the VOICE mode (page 54).



Before performing advanced operations

This section describes the basic control methods that are frequently used for “Advanced operations.”

How to use the mode dial

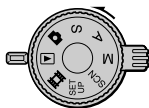
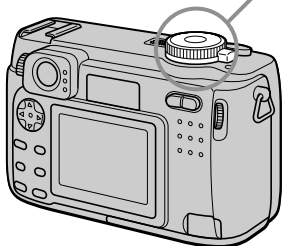
The mode dial switches the function which is used for recording, playback, or editing. Set the dial as follows before starting to operate your camera.



-  : To record still images, VOICE mode audio data
-  : To play back or edit images
-  : To record moving images or Clip Motion images
- SET UP:** To set the setup items (The SET UP position changes the settings of infrequently-used items.)
- SCN:** To record in the SCENE SELECTION mode
- M:** To record with the shutter speed and aperture set manually
- A:** To record in the aperture priority mode
- S:** To record in the shutter speed priority mode

How to use the control button

When the menu or setup screen is displayed, the control button is used to select the buttons, images and menu items displayed on the LCD screen of your camera and modify the settings. The operation methods that are frequently used for “Advanced operations” are described below.

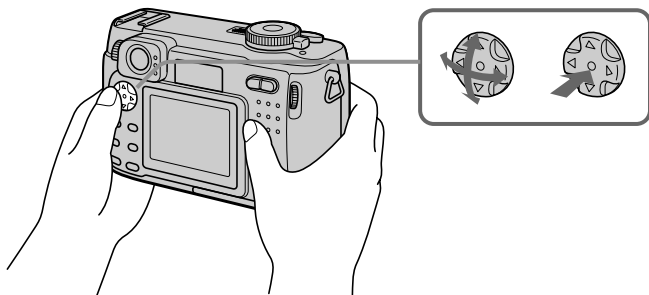

Turning on/off the operation buttons (menu) on the LCD screen

Press MENU to display/
clear the menu on the
LCD screen.

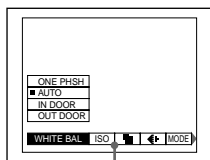
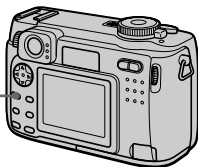





Menu

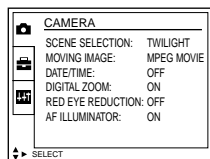

Setting up the items in the setup or menu





- 1 Set the mode dial to SET UP so that the setup screen appears, or press MENU so that the menu appears.



2 When the mode dial is set to SET UP or :

- 1 Press /// on the control button to select the item you want to set up.
- 2 Press the center  on the control button to enter the item.

When the mode dial is set to , S, A, M, SCN, or :

Press /// on the control button to select the setting of the item.

The selected setting is turned to yellow, and the setup is complete.

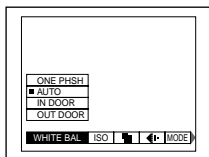

How to use the jog dial

The functions which are used frequently in recording are set up using the jog dial and the following direct buttons. The jog dial is used to change the value in manual adjustments.

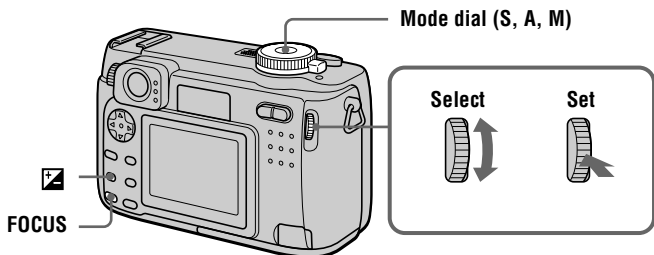

1 Set the mode dial to S, A, or M.

The adjustable value number appears at the right corner on the LCD.

2 Turn the jog dial to select the item or value number you want to adjust.

- When the indication ◀ at the right corner on the LCD screen is in yellow, you can select the item. In such cases, go to step 3.
- When the value number at the right corner on the LCD screen is in yellow, you can adjust the value. (When you press FOCUS, the ∞ mark appears on value number position.)

When you adjust only the value, the adjustment is complete.

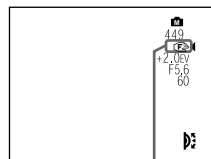
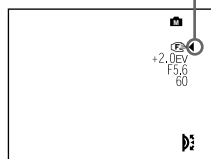

Yellow

3 Press the jog dial.

The value number turns to yellow. To adjust the value, repeat step 2.





Viewing the next/previous image using the jog dial during playback



When the mode dial is set to \blacktriangleright , you can easily view the next/previous image by turning the jog dial.

Menu settings

Menu items that can be modified differ depending on the positions of the mode dial. The LCD screen shows only the items you can operate at the moment. Factory settings are indicated with ■.

When the mode dial is set to /SCN/S/A/M



Item	Setting	Description
WB (WHITE BAL)	ONE PUSH ■ AUTO IN DOOR OUT DOOR	Sets the white balance (page 60).
ISO	400 200 100 ■ AUTO	Selects the ISO film speed. When recording under dark situations or recording a fast-moving subject, use a high-number setting. When you record high-quality images, use a low-number setting (except when the mode dial is set to SCN).
 (IMAGE SIZE)	■ 2048×1536 2048 (3:2) 1600×1200 1280×960 640×480	Selects the image size when recording still images.
 (P. QUALITY)	■ FINE STANDARD	Records still images in the fine image quality mode. Records still images in the standard image quality mode.
MODE (REC MODE)	TIFF TEXT VOICE E-MAIL BURST2 ■ NORMAL	Records a TIFF (uncompressed) file in addition to the JPEG file (page 56). Records a GIF file in black-and-white (page 55). Records an audio file (with a still image) in addition to the JPEG file (page 54). Records a small-size (320×240) JPEG file in addition to the selected image size (page 53). Records two images continuously (page 52). Records an image using the normal recording mode.
 (FLASH LEVEL)	HIGH ■ NORMAL LOW	Makes the flash level higher than normal. Normal setting. Makes the flash level lower than normal.



Item	Setting	Description
PFX (P. EFFECT)	SOLARIZE B&W SEPIA NEG.ART ■ OFF	Sets the image special effects (page 61).
 (SHARPNESS)	+2 +1 ■ 0 -1 -2	Adjusts the sharpness of the image. The  indicator appears (except when the setting is 0).

When the mode dial is set to  (MOVING IMAGE is set to MPEG MOVIE in the setup settings.)



Item	Setting	Description
WB (WHITE BAL)	ONE PUSH ■ AUTO IN DOOR OUT DOOR	Sets the white balance (page 60).
 (IMAGE SIZE)	320 (HQ) 320×240 ■ 160×112	Selects the MPEG image size when recording moving images (page 47).
PFX (P. EFFECT)	SOLARIZE B&W SEPIA NEG.ART ■ OFF	Sets the image special effects (page 61).

When the mode dial is set to  (MOVING IMAGE is set to CLIP MOTION in the setup settings.)

Item	Setting	Description
WB (WHITE BAL)	ONE PUSH ■ AUTO IN DOOR OUT DOOR	Sets the white balance (page 60).
 (IMAGE SIZE)	■ NORMAL MOBILE	Selects the Clip Motion image size (page 56).
 (FLASH LEVEL)	HIGH ■ NORMAL LOW	Makes the flash level higher than normal. Normal setting. Makes the flash level lower than normal.

Item	Setting	Description
PFX (P. EFFECT)	SOLARIZE B&W SEPIA NEG.ART ■ OFF	Sets the image special effects (page 61).
 (SHARPNESS)	+2 +1 ■ 0 -1 -2	Adjusts the sharpness of the image. The  indicator appears (except when the setting is 0).





When the mode dial is set to

Item	Setting	Description
DELETE	OK CANCEL	Deletes the displayed image (page 67). Cancels deleting of the image.
PROTECT	–	Protects images against accidental erasure (page 68).
PRINT	–	Marks the print mark on still images (page 72).
SLIDE*	INTERVAL REPEAT START CANCEL	Sets the slide show interval. ■ 3 sec/5 sec/10 sec/30 sec/1 min ■ ON/OFF Starts the slide show. Cancels the slide show.
COPY	OK CANCEL	Copies an image (page 71). Cancels copying of the image.
RESIZE*	2048×1536 1600×1200 1280×960 640×480 CANCEL	Changes the recorded image size (page 70).
ROTATE*	  OK CANCEL	Rotates the still image (page 66).
DIVIDE*	OK CANCEL	Divides a moving image (page 74).

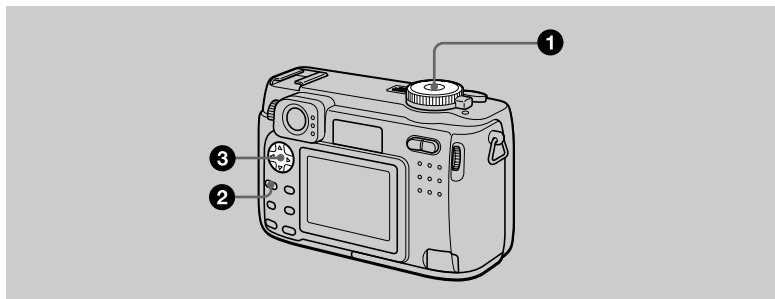
* Only in single-image mode.

Setting the image size (IMAGE SIZE)



- 1** Set the mode dial to , SCN, S, A, M, or .
- 2** Press MENU.
The menu appears.
- 3** Select the desired image size from [] (IMAGE SIZE) and press /.

Still image sizes:

2048×1536, 2048 (3:2)*, 1600×1200, 1280×960, 640×480

* The image is recorded in the ratio of three to two to fit the printing paper size. Using this image size, the margin of an image is not printed out. However, the slight amount of the upper and lower black portions are displayed on the LCD screen.

Moving image (MPEG movie) sizes:

320 (HQ)*, 320×240, 160×112

* High Quality mode

Clip Motion sizes:

NORMAL (160×120), MOBILE (80×72)

The number of images or the time* that you can record on a “Memory Stick” (8 MB)

Still images:

Image size	Usage	Quality	
		STANDARD	FINE
2048×1536	Modifying images	Approx. 9	Approx. 5
2048 (3:2)	Printing in 3:2 ratio	Approx. 9	Approx. 5
1600×1200	Printing in A4 format	Approx. 15	Approx. 8
1280×960	Printing in post card size	Approx. 22	Approx. 12
640×480	Attaching to e-mail	Approx. 118	Approx. 48

Moving images:

Image size	Usage	Number of images or time
320 (HQ)	Viewing on TV	Approx. 20 sec.
320×240	Viewing on web site	Approx. 80 sec.
160×112	Attaching to e-mail	Approx. 320 sec.
MOBILE (80×72)	–	Approx. 350
NORMAL (160×120)**	–	Approx. 40

* The maximum recording time in continuous recording.

** When recording 10 frames per Clip Motion file.

Remaining number of recordable images or recordable time (page 94)

The actual number of remaining images or recordable time may differ depending on the recording conditions.

► Various recording

Recording with the exposure fixed (AE LOCK)

Mode dial: /S/A/M/SCN

Once you press AE LOCK, the exposure, now captured, is fixed. For instance, this function is convenient in the following use:

Measure the exposure of the desired portion of the subject using the spot light-metering function and fix its exposure value by pressing AE LOCK. Then, recompose the picture.

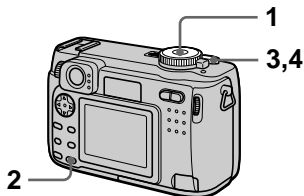

- 1** Set the mode dial to , S, A, M or SCN.
- 2** Target the subject that has desired exposure value, then press AE LOCK.
The exposure is fixed and the AE-L mark appears.
- 3** Target the subject you want to record and press and hold the shutter button halfway down.
The focus is automatically adjusted.
- 4** Press down the shutter button.

To release AE LOCK

Carry out one of the followings:

- Press AE LOCK again after step 2.
- Release your finger from the shutter button after step 3.
- Press down the shutter button in step 4.

Recording with the manual adjustments

Mode dial: S/A/M

Shutter speed priority mode

Once the shutter speed is adjusted manually, the aperture will be automatically adjusted to the suitable value to attain correct exposure according to the brightness of the subject. Using the higher shutter speed, you can record a fast-moving subject with its motion frozen. And using the lower shutter speed, you can record the flow motion of a moving subject.

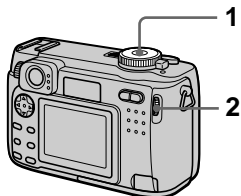

- 1 Set the mode dial to S.
- 2 Select a shutter speed with the jog dial, then press the jog dial.
The shutter speed can be selected from 8" to 1/1000.

Aperture priority mode

Once the aperture is adjusted manually, the shutter speed will be automatically adjusted to the suitable value to attain correct exposure according to the brightness of the subject. Selecting a lower aperture value opens the lens iris. Using a lower aperture value, you can record a subject with its background unclear. And using a higher aperture value, you can record both the subject and the background stand out clearly.

50

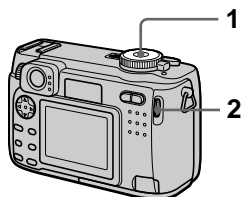

- 1 Set the mode dial to A.
- 2 Select an aperture value with the jog dial, then press the jog dial.
The aperture value can be selected from F2 to F8.

Manual exposure mode

You can manually adjust the shutter speed and aperture values to achieve the desired shooting condition according to your purpose. The exposure value appears on the LCD screen (page 59). And you can also adjust the aperture value and the shutter speed value according to your taste. 0 EV is the most suitable value set by the camera.

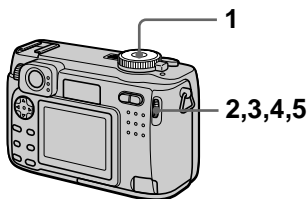

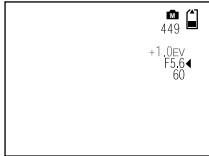
- 1 Set the mode dial to M.
- 
- 2 Select the aperture value indication with the jog dial, then press the jog dial.

- 3 Select the aperture value with the jog dial, then press the jog dial.
- 4 Select the shutter speed value indication with the jog dial, then press the jog dial.
- 5 Select the shutter speed value with the jog dial, then press the jog dial.
For details on available values, see “Shutter speed priority mode” on page 50, or “Aperture priority mode” on page 50.

Note

If the setting is not appropriate in aperture priority mode, shutter speed priority mode, or manual exposure mode, the setting value indicator on the LCD screen flashes. You can record in this setting, we, however, recommend that you adjust the flashed-value again.

Records images according to shooting conditions (SCENE SELECTION)

Mode dial: SCN

This camera has preset three SCENE SELECTION modes. Each mode is suitable for the following situations; night scene, landscape, and portrait.

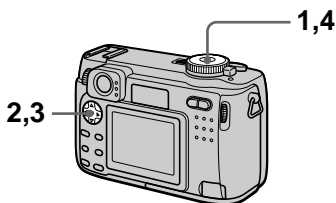

- 1 Set the mode dial to SET UP.
The setup screen appears.
- 2 Select [CAMERA] with ▲/▼, [SCENE SELECTION] with ►/▲/▼, then press ►.
- 3 Select the desired setting, then press ●.

☾ TWILIGHT mode

Allows you to record bright subjects in dark places without losing the dark atmosphere of the surroundings. The shutter speed becomes slower, so we recommend that you use a tripod to prevent shaking.

🏞️ LANDSCAPE mode



Focuses only on a distant subject to record landscapes, etc.

👤 PORTRAIT mode



Suits for portrait recordings. Backgrounds blurred away, and the frontward person is sharpened.

- 4 Set the mode dial to SCN.
The selected setting is loaded.

To cancel the SCENE SELECTION function

Set the mode dial to , S, A, M, , or .

Notes

- You can focus only on distant subjects in LANDSCAPE mode.
- Set the forced flash  when you use the flash in the following modes:
 - TWILIGHT mode
 - LANDSCAPE mode
- When using the SCENE SELECTION mode, the AF illuminator (page 25) does not emit in the following conditions:
 - TWILIGHT mode: when the flash mode is not set to the  forced flash mode
 - LANDSCAPE mode: you cannot use the AF illuminator.

Tips



Under normal recording conditions, the camera automatically makes various adjustments, such as those for the focus, iris, exposure, and white balance, as it shoots. However, you may not be able to carry out your desired shooting depending on shooting conditions. The SCENE SELECTION function provides you with near-optimum adjustments to suit your shooting situation.

Recording two images continuously

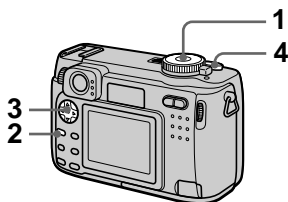

Mode dial: /S/A/M/SCN

This mode is used for a continuous recording.



- 1 Set the mode dial to , S, A, M or SCN.
- 2 Press MENU.
The menu appears.
- 3 Select [MODE] (REC MODE) with , [BURST2] with .
- 4 Record the image.

To return to normal recording mode

Select [NORMAL] with /  in step 3.

Notes

- You cannot use the flash in this mode.
- During recording in this mode, the image is not displayed on the LCD screen. Make the composition before pressing the shutter button.
- The recording interval is approximate 0.6 second.
- You cannot select a shutter speed slower than 1" when recording two images continuously.

Recording still images for e-mail (E-MAIL)

Mode dial: /S/A/M/SCN

In the E-MAIL mode, a small-size image which is suitable for e-mail transmission is also recorded at the same time as recording a normal still image. (The size of the normal still image is set using [] (IMAGE SIZE) in the menu settings (page 47).)

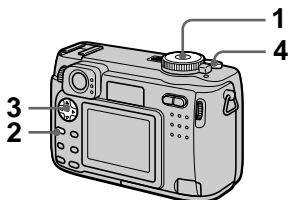

- 1 Set the mode dial to , S, A, M or SCN.
- 2 Press MENU.
The menu appears.
- 3 Select [MODE] (REC MODE) with , [E-MAIL] with .
- 4 Record the image.

The number of images that you can record on a “Memory Stick” (8 MB) in E-MAIL mode

Image size	Quality	
	STANDARD	FINE
2048×1536	Approx. 8	Approx. 4
2048 (3:2)	Approx. 8	Approx. 4
1600×1200	Approx. 14	Approx. 8
1280×960	Approx. 21	Approx. 12
640×480	Approx. 95	Approx. 43

Remaining number of recordable images (page 94)

The actual number of remaining images may differ depending on the recording conditions.

To return to normal recording mode



Select [NORMAL] with / in step 3.

Adding audio files to still images (VOICE)

Mode dial: /S/A/M/SCN

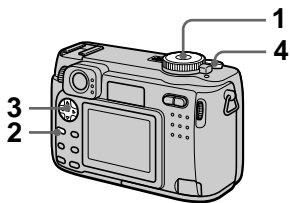
In the VOICE mode, the audio is also recorded at the same time as recording a still image. You can vividly record the situation with audio.





- 1 Set the mode dial to , S, A, M or SCN.**
- 2 Press MENU.**
The menu appears.
- 3 Select [MODE] (REC MODE) with , [VOICE] with .**
- 4 Record the image.**
If you press and release the shutter button, sound is recorded for five seconds.
If you hold down the shutter button, sound is recorded until you release the shutter button for up to 40 seconds.

The number of images that you can record on a "Memory Stick" (8 MB) in VOICE mode*

Image size	Quality	
	STANDARD	FINE
2048×1536	Approx. 8	Approx. 4
2048 (3:2)	Approx. 8	Approx. 4
1600×1200	Approx. 13	Approx. 7
1280×960	Approx. 19	Approx. 11
640×480	Approx. 56	Approx. 34

* When recording 5-second audio.

To return to normal recording mode



Select [NORMAL] with / in step 3.

Recording text documents (TEXT)

Mode dial: 

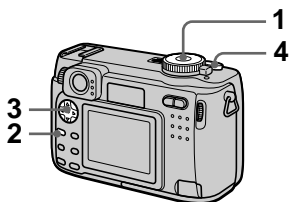
The TEXT mode is suitable for recording a document to emphasize its character by the black and white colors. The LCD screen also turns to black and white, and the image is recorded in the GIF format.





- 1 Set the mode dial to .
- 2 Press MENU.
The menu appears.
- 3 Select [MODE] (REC MODE) with , [TEXT] with .
- 4 Record the image.

The number of images that you can record on a "Memory Stick" (8 MB) in TEXT mode*

Image size	Number of images
2048×1536	14–108
2048 (3:2)	16–108
1600×1200	24–138
1280×960	36–162
640×480	121–323

* The maximum number of recordable images depends on the document condition, such as the amount of text portions.

To return to normal recording mode

Select [NORMAL] with / in step 3.

Notes



- If the subject is not evenly illuminated, you may be unable to record a clear image.
- Writing and reading data take more time than normal recording.
- When the mode dial is set to S, A, M, or SCN images can be recorded, but the image may be bleached out or may be turned black.
- Remaining number of recordable images is not displayed.
- The number of recordable images is the same regardless of whether [] (P. QUALITY) is set to STANDARD or FINE.

Recording still images as uncompressed files (TIFF)

Mode dial: /S/A/M/SCN

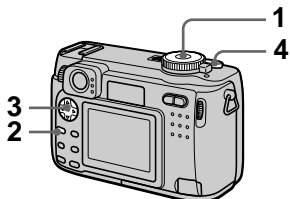
Records the images without compression, so the image does not deteriorate. Images recorded in this mode are suitable for printing with a high-quality image. The JPEG (compressed) format image is also recorded with the TIFF format image.



- 1 Set the mode dial to , S, A, M or SCN.
- 2 Press MENU.
The menu appears.
- 3 Select [MODE] (REC MODE) with , [TIFF] with .
- 4 Record the image.
The number of images that you can record on a “Memory Stick” (16 MB) in TIFF mode is approx. 1.

To return to normal recording mode

Select [NORMAL] with  in step 3.

Notes







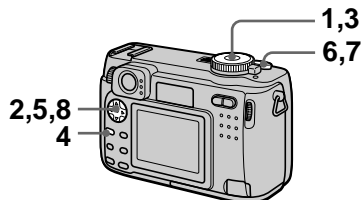

- JPEG images are recorded in the image size selected by the  (IMAGE SIZE) menu (page 47). TIFF images are recorded in [2048×1536] size other than when [2048 (3:2)] is selected.
- Writing data takes more time than in normal recording.
- The “Memory Stick” (8 MB) does not have sufficient capacity to record uncompressed images.

Creating Clip Motion Files

Mode dial: 

Clip Motion is an animation function that plays back still images in succession. The images are stored in GIF format, which is convenient for creating home pages or attaching images to an e-mail.



- 1 Set the mode dial to SET UP.
The setup screen appears.
- 2 Select  (CAMERA) with , [MOVING IMAGE] with , [CLIP MOTION] with , then press .
- 3 Set the mode dial to .
- 4 Press MENU.
The menu appears.
- 5 Select  (IMAGE SIZE) with , the desired mode with .

NORMAL (160×120)

Clip Motion of up to 10 frames can be recorded. This is suitable for use on home pages, etc.

MOBILE (80×72)

Clip Motion of up to 2 frames can be recorded. This is suitable for use with portable data terminals.

6 Record the image for the first frame.

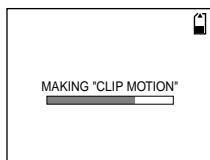

Before carrying out step 8, the images are temporarily stored in memory. These images are not recorded on the “Memory Stick”, yet.

7 Record the image for the next frame.

Image recording can be repeated up to the maximum number of recordable frames.

8 Press ●.

All the frame images are recorded on the “Memory Stick”.

To delete some or all the frame images while making a Clip Motion recording

- 1 Press the control button ◀ (⊕) in step 6 or 7.

The recorded frame images are played back in turn and stop at the last image.

- 2 Press MENU, and select [DELETE LAST] or [DELETE ALL], then press ●.

- 3 Select [OK], then press ●.

When [DELETE LAST] is selected in step 2, each time you repeat steps 1 through 3, the recorded frame is deleted from the newest one.

The number of Clip Motion frames that you can record on a “Memory Stick” (8 MB)

Image size	Number of images
NORMAL (160×120)	Approx. 40*
MOBILE (80×72)	Approx. 350

* When recording 10 frames per Clip Motion file

Notes

- You cannot change the image size partway through a Clip Motion recording.
- Reading and writing data take more time than normal image recording.
- Due to the limitations of the GIF format, the number of colors for Clip Motion images is reduced to 256 colors or less. Therefore, the picture quality may deteriorate for some images.
- The file size is reduced in MOBILE mode, so the picture quality deteriorates.
- GIF files not created on this camera may not be displayed correctly.
- All the frame images are immediately recorded on the “Memory Stick” if the mode dial is switched or the power is turned off.

Setting the distance to the subject

Mode dial: / S / A / M / SCN /

Normally the focus is automatically adjusted. This function is useful when the auto focus does not work well such as in dark places.

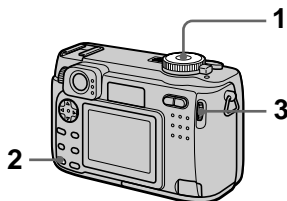

1 Set the mode dial to , S, A, M, SCN or .

2 Press FOCUS.
The focus is fixed and the (manual focus) indicator appears.

3 Turn the jog dial to select the desired focus setting.

You can select from 15 focus settings (unit: m) including the position:

0.1, 0.2, 0.3, 0.5, 0.8, 1.0, 1.5, 2, 3, 5, 7, 10, 15, and ∞ (infinity)

To reactivate auto focusing

Press FOCUS again and the focal point information disappears.

Notes

- Focal point information may not completely show the correct distance. Use the information as a guide.
- The focus preset cannot be set when attaching a conversion lens.
- Focusing error increases if the lens is pointed up or down.
- If you shoot a subject within 0.2 m (7 7/8 inches) while the zoom is set to the T side, you cannot get a clear focus. In such cases, the focal point information flashes. Press the zoom W button until the indicator stops flashing.

Recording images in macro

Mode dial: / S / A / M / SCN /

The macro recording is used when zooming up a little subject, such as flowers, insects.

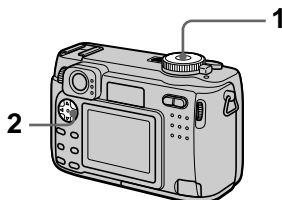

1 Set the mode dial to , S, A, M, SCN or .

2 Clear the menu, and press the control button ().
The (macro) indicator appears on the LCD screen.

You can record a subject as close as about 4 cm (1 5/8 inches) from the lens surface with the zoom set all the way to the W side, or about 20 cm (8 inches) with the zoom set all the way to the T side.

To return to normal recording mode

Press the control button () again.
The indicator disappears.

Notes

- You cannot record images in macro with the LANDSCAPE mode of the SCENE SELECTION function.
- When recording images in macro, use the LCD screen. If you record using the finder, the range visible in the finder may differ from the actual recording range.

Adjusting the exposure (EXPOSURE)

Mode dial: / S / A / SCN /

Adjusts the exposure value which is set in the automatic adjustment.

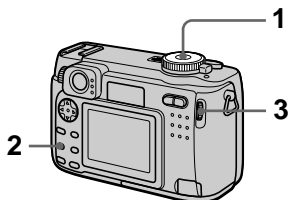

1 Set the mode dial to , S, A, SCN or .

2 Press .

3 Select the desired exposure value with the jog dial.

Adjust the exposure value while checking the brightness of the background.

You can select values ranging from +2.0 EV to -2.0 EV in steps of 1/3 EV.

Note

If a subject is under extremely bright or dark situations, or the flash is used, the exposure adjustment may not be effective.

Tips

Normally, the camera automatically adjusts the exposure. If the color of the image is too dark or bright as illustrated below, we recommend that you adjust the exposure manually. When recording a backlit subject or a subject in the snow, set it toward +, and when recording a dark subject with fully displayed on the LCD screen, set it toward -.

Set the exposure toward +



Set the exposure toward -

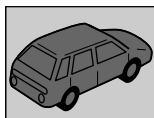
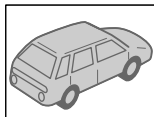

Adjusting the white balance (WHITE BALANCE)

Mode dial: /S/A/M/SCN/

Normally, the white balance is automatically adjusted (AUTO). When you record with the shooting condition fixed or under the specific lighting condition, you can manually adjust the white balance.

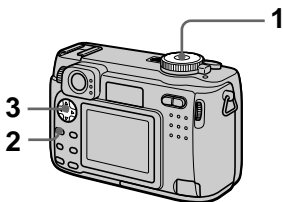

- 1 Set the mode dial to , S, A, M, SCN or .**
- 2 Press MENU.**
The menu appears.
- 3 Select [WB] (WHITE BAL) with /, the desired setting with /.**

ONE PUSH ()

Adjusting the white balance depending on the light source

AUTO (No indicator)

Adjusts the white balance automatically
Under fluorescent lighting

IN DOOR ()

- Places where the lighting condition changes quickly
- Under bright lighting such as photography studios
- Under sodium or mercury lamps

OUT DOOR ()

Recording a sunrise/sunset, night scene, neon signs, or fireworks

To shoot in one-push white balance mode

- 1** Select [ONE PUSH]. The indicator appears.
- 2** Shoot a white object such as paper full under the same situation you will shoot.
- 3** Press .
The indicator flashes quickly. When the white balance has been adjusted and stored in the memory, the indicator stops flashing.

To reactivate auto adjustment

Select [AUTO] with / in step 3.

Notes

- The indicator means:
Slow flashing: white balance is not set or was not able to be set.
Quick flashing: white balance is being adjusted (after you pressed).
Lit steady: white balance has been set.
- If the indicator keeps flashing even when you press , record in automatic white balance mode.

Tips

The image is susceptible to lighting conditions. The image looks blue under sunlight in the summer, and looks red under mercury lamps. Human eyes can resolve these problems. However, the camera cannot resolve the problem without making adjustments. Normally, the camera adjusts it automatically, but, if the image appears in strange colors, we recommend that you change the white balance mode.

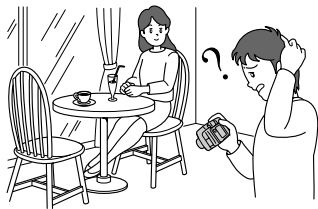

Enjoying picture effects (P. EFFECT)

Mode dial: /S/A/M/SCN/

You can digitally process images to obtain special effect.

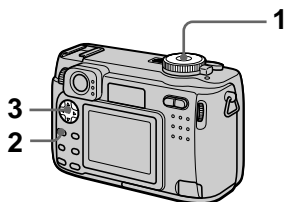

- 1 Set the mode dial to , S, A, M, SCN or .
- 2 Press MENU.
The menu appears.
- 3 Select [PFX] (P. EFFECT) with /, the desired mode with /.

SOLARIZE

The light contrast is clearer and the picture looks like an illustration.

B&W

The picture is monochrome (black and white).

SEPIA

The picture is sepia-toned like an old photograph.

NEG.ART

The color and brightness of the picture are reversed as in a negative.

OFF

Does not use the picture effect function.

To cancel picture effect

Select [OFF] with / in step 3.

Recording the date and time on the still image (DATE/TIME)

Mode dial: /S/A/M/SCN

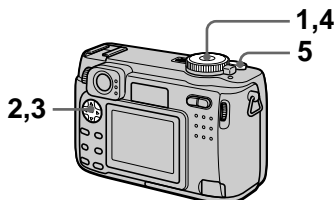

- 1 Set the mode dial to SET UP.
The setup screen appears.
- 2 Select [] (CAMERA) with /, [DATE/TIME] with /, then press .
- 3 Select the date and time setting with /, then press .

DAY & TIME

Imposes the date, hour, and minute.

DATE

Imposes the year, month, and day.

OFF

Does not impose the date and time.

- 4 Set the mode dial to , S, A, M, or SCN.
- 5 Record the image.
The date and time do not appear on the LCD screen during shooting. These appear during playback only.



Notes

- If you select [DATE] in step 3, the date is imposed onto the image in the order selected with “Setting the date and time” (page 15).
- The date and time are not superimposed onto moving images or Clip Motion images.

Using the spot light-metering function

Mode dial:  /S/A/M/SCN/

Use this function when there is backlight or when there is strong contrast between the subject and the background, etc. Position the point you want to record on the spot light-metering cross hair.

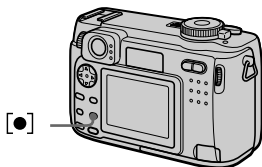

Press [●] to activate the spot light-metering function.

Position the point you want to record at the spot light-metering cross hair. Record the picture when the automatic adjustment has been completed.

LCD screen

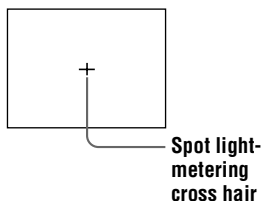

► Various playback

Playing back three or nine images at once

Mode dial: ►

You can display multiple images on the LCD screen at one time using the zoom buttons.

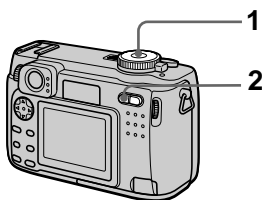

1 Set the mode dial to ►.

2 Press the zoom W button repeatedly.

The LCD screen display changes as follows:

- Single (single-image) screen

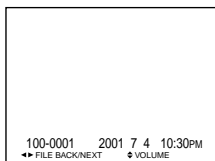

- Index (nine-image) screen

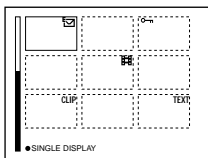

- Triple-image screen

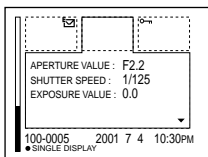

The image indicated by the yellow frame in the index screen is displayed in the middle of the triple-image screen with the recording information. To display the other information, press the control button ▲/▼.

The following marks are displayed on each image according to the image type and settings.

📁: Moving image file

🎵: VOICE mode file

✉: E-mail file

🖨: Print mark

🔑: Protect mark

TEXT: TEXT file

TIFF: TIFF file

CLIP: Clip Motion file

(No mark): Normal recording (no settings)

To display the next (previous) index screen

Press the control button ▲/▼/◀/▶.

To return to normal playback (single-image)

- Press the zoom T button repeatedly.
- Press the control button ●.

Note

When viewing an image recorded in Clip Motion or TEXT mode on the index screen, the image may appear different from the actual image.

Tips

When the triple-image screen is displayed, pressing MENU opens the menu including [PRINT], [PROTECT], and [DELETE]. For details on these items, see pages 67, 68, or 72. To close the menu, press MENU again. The menu disappears and the recording information is indicated.

Enlarging a part of the still image (Zoom and trimming)

Mode dial: 

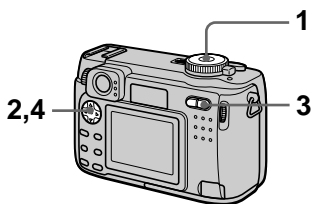





- 1 Set the mode dial to .
- 2 Display the image to be enlarged.
- 3 Zoom in/out the image with the zoom T/W buttons.
- 4 Press the control button repeatedly to select the desired portion of the image.
 - ▲: The image moves downward
 - ▼: The image moves upward
 - ◀: The image moves rightward
 - ▶: The image moves leftward

To return to the normal size

Press the control button .

To record an enlarged image (trimming)

- ① Press MENU after zooming.
 - ② Select [TRIMMING] with , then press .
 - ③ Select the image size with /, then press .
- The image is recorded and the image on the LCD screen returns to the normal size after recording.

Notes



- You cannot zoom moving images.
- You can zoom images recorded in TEXT mode, but cannot trim them.
- Zoom scaling is up to 5× regardless of the original image size.
- The quality of enlarged images may be deteriorated.
- The original data is left even if you enlarge the image.
- The enlarged image is recorded as the newest file.
- If you trim an image, the remaining “Memory Stick” capacity will be decreased.
- If the remaining “Memory Stick” capacity is not sufficient, you may be unable to trim an image.
- You cannot trim to an image of 3:2.
- You cannot trim uncompressed (TIFF) images.

Playing back the still images in order (SLIDE)

Mode dial: 

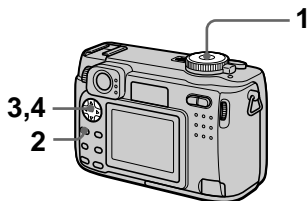
This function is useful for checking the recorded images or for presentations, etc.







- 1 Set the mode dial to .
- 2 Press MENU.
The menu appears.
- 3 Select [SLIDE] with , then press .

INTERVAL





You can select from 1 min (one minute), 30 sec (30 seconds), 10 sec (10 seconds), 5 sec (5 seconds), or 3 sec (3 seconds).

REPEAT



ON: Plays back images in a continuous loop.
OFF: After all images have been played back, the slide show ends.

- 4 Select [START] with , , , then press .



To cancel the SLIDE SHOW setting

Select [CANCEL] with , ,  in step 3, then press .

To stop the SLIDE SHOW playback

Press , select [EXIT] with , then press .

To skip to the next/previous image during the SLIDE SHOW

Press  (next) or  (previous).

Note







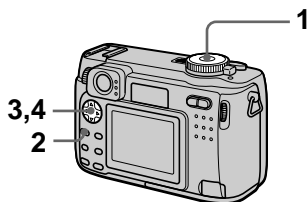

The interval setting time may vary depending on the image size.

Rotating a still image (ROTATE)



Mode dial: 

You can rotate the image recorded in portrait orientation and display it in landscape orientation.



- 1 Set the mode dial to , and display the image to rotate.
- 2 Press MENU.
The menu appears.
- 3 Select [ROTATE] with , then press .
- 4 Select [, ] with , then rotate the image with . Select [OK] with , then press .

To cancel rotation

Select [CANCEL] with , then press .

Notes

- You cannot rotate protected or uncompressed images, or images recorded in TEXT mode.
- You may not be able to rotate images recorded with other equipment.
- Also, when viewing images on a computer, the image rotation information may not be reflected depending on the application software.

Viewing images on a TV screen

Mode dial: 

Before connecting your camera, be sure to turn off the TV.

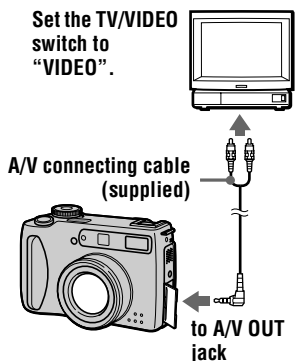

- 1 Connect the A/V connecting cable to the A/V OUT jack of your camera and to the audio/video input jacks of the TV.
If your TV has stereo type input jacks, connect the audio plug (black) of the A/V connecting cable to the Lch jack.
- 2 Turn on the TV and start playback on your camera.
The playback image appears on the TV screen.

Notes

- You cannot use a TV that has an antenna (aerial) connector only.
- When viewing a still image on the TV, the black band may appear around the image.

► Editing

Deleting images (DELETE)

Mode dial: ►

You can delete unwanted files.

In single-image or triple-image mode

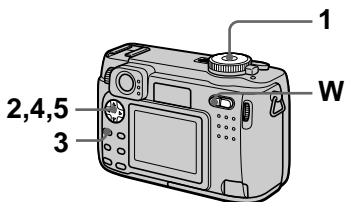

- 1 Set the mode dial to ►.
- 2 In single-image mode:
Display the image you want to delete with ◀/▶.
In triple-image mode:
Press the zoom W button twice in the single-image mode to turn to the triple-image mode. Display the image you want to delete with ◀/▶.
- 3 Press MENU.
The menu appears.
- 4 Select [DELETE] with ◀/▶ in single-image mode, or with ▲/▼ in triple-image mode, then press ●.
- 5 Select [OK] with ▲/▼, then press ●.
The image (or the middle-positioned image in triple-image mode) is deleted.

In index mode

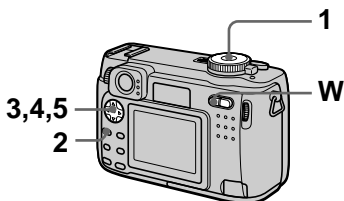

- 1 Set the mode dial to ►, then display the index screen with the zoom W button.
- 2 Press MENU.
The menu appears.
- 3 Select [DELETE] with ◀/▶, then press ●.
- 4 Select [ALL] or [SELECT] with ◀/▶, then press ●.
- 5 When you select [ALL]
Select [ENTER] with ◀/▶, then press ●.
All the unprotected images are deleted.

When you select [SELECT]

The frame of the selected image turns green.

- ① Select the images to be deleted with the control button, then press ●.
To cancel, press ● again.
Repeat this step to select other images.
The  (delete) indicator appears on the selected images.

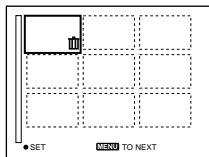

- ② Press MENU.
- ③ Select [OK] with ◀/▶, then press ●.

To cancel deleting

Select [CANCEL] with ◀/▶ in step 4 or [EXIT] with ◀/▶ in step 5, then press ●.

Note

If there are files on the “Memory Stick” with names having the same last 4 digits as the file name of the image to be deleted, these files are also deleted at the same time.

Preventing accidental erasure (PROTECT)

Mode dial: ▶

Protects images against accidental erasure.

In single-image or triple-image mode

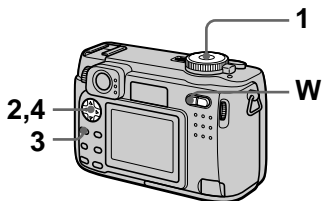

1 Set the mode dial to ▶.

2 In single-image mode

Display the image you want to protect with ◀/▶.

In triple-image mode

Press the zoom W button twice in the single-image mode to turn to the triple-image mode.

Display the image you want to protect with ◀/▶.

3 Press MENU.

The menu appears.

4 Select [PROTECT] with ◀/▶ in single-image mode, or with ▲/▼ in triple-image mode, then press ●.

The displayed image (or the middle-positioned image in triple-image mode) is protected.

The ◯ indicator appears on the image.

To release protection

Press ● again in step 4. ◯ indicator disappears.

In index mode

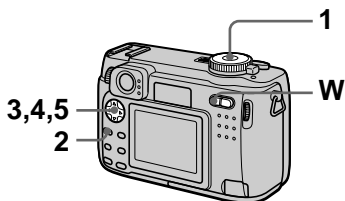



1 Set the mode dial to , then display the index screen with the zoom W button.

2 Press MENU.
The menu appears.

3 Select [PROTECT] with , then press .



4 Select [ALL] or [SELECT] with , then press .

5 When you select [ALL]
Select [ON] with , then press .

All the images in the “Memory Stick” are protected.



When you select [SELECT]

The frame of the selected image turns green.



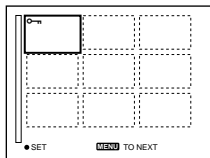





① Select the images to be protected with the control button, then press .
To cancel, press  again.
Repeat this step to select other images.

The  indicator appears on the selected images.





② Press MENU.
③ Select [OK] with , then press .

To release protection

If you selected [ALL] in step 4, select [OFF] with , then press . If you selected [SELECT] in step 4, select the images to be unprotected with , then press . Repeat this step to select other images. When you have selected all the images to be unprotected, press MENU and select [OK] with , then press .

To cancel protection

Select [CANCEL] with  in step 4 or [EXIT] with  in step 5, then press .

Changing the recorded still image size (RESIZE)

Mode dial: 

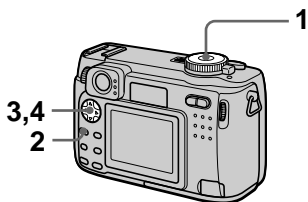

You can change the image size of the recorded image.



1 Set the mode dial to , then display the image of which you want to change the size.

2 Press MENU.
The menu appears.



3 Select [RESIZE] with , then press .

4 Select the desired size with , then press .

2048×1536, 1600×1200,
1280×960, 640×480

The resized image is recorded.

To cancel changing the size

Select [CANCEL] with , then press .

Notes

- The original image is retained even after resizing.
- You cannot change the size of images recorded in TEXT mode, moving images, uncompressed images, or Clip Motion images.
- The resized image is recorded as the newest file.
- If you resize an image, the remaining “Memory Stick” capacity will be decreased.
- When you change from a small size to a large size, the picture quality deteriorates.
- If the remaining “Memory Stick” capacity is not sufficient, you may not be able to resize an image.
- You cannot resize to an image of 3:2.
- When you resize a 3:2 image, the upper and lower black portions are displayed on the LCD screen.





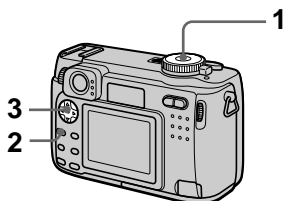

Copying images (COPY)

Mode dial: 

You can copy images to another “Memory Stick.”

In single mode









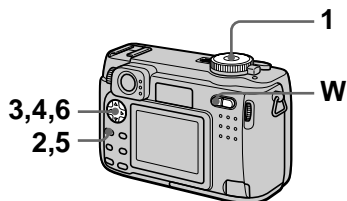

- 1 Set the mode dial to , then display the image which you want to copy.
- 2 Press MENU.
The menu appears.
- 3 Select [COPY] with , [OK] with , then press .
“MEMORY STICK ACCESS” appears.
- 4 When “CHANGE MEMORY STICK” appears, eject the “Memory Stick.”
“INSERT MEMORY STICK” appears.
- 5 Insert the “Memory Stick” on which to copy the image.
“RECORDING” appears. When copying is completed, “COMPLETE” appears.
To end copying, select [EXIT] with , then press .

To copy the image to another “Memory Stick”



Select [CONTINUE] with , press , then repeat steps 4 and 5.

In index mode

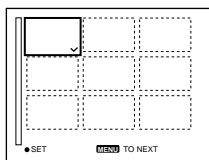

- 1 Set the mode dial to , then display the index screen with the zoom W button.
- 2 Press MENU.
The menu appears.
- 3 Select [COPY] with , then press . Select [Select] with , then press .
The frame of the selected image turns green.
- 4 Select the image to copy with the control button, then press .
To cancel, press  again. Repeat this step to select other images.
The  (select) indicator appears on the image.



- 5 Press MENU.
The menu appears.
- 6 Select [ENTER] with , then press .
“MEMORY STICK ACCESS” appears.

7 When “CHANGE MEMORY STICK” is displayed, eject the “Memory Stick.”

“INSERT MEMORY STICK” appears.

8 Insert another “Memory Stick.”

“RECORDING” appears. When copying is completed, “COMPLETE” appears.

To end copying, select [EXIT] with ▲/▼, then press ●.

To copy the image to another “Memory Stick”

Select [CONTINUE] with ▲/▼ in step 8, press ●, then repeat steps 7 and 8.

To cancel copying part-way

Select [CANCEL] with ◀/▶ in step 3 or [EXIT] with ◀/▶ in step 6, then press ●.

Notes

- If you do not select [EXIT] after “COMPLETE” appears and instead insert a new “Memory Stick,” the same image is copied again.
- You cannot copy uncompressed images.
- You cannot copy images that are bigger than 5 MB at once. If “NOT ENOUGH MEMORY” appears or ✓ flashes on the INDEX screen, cancel some images to copy and try again.

Selecting still images to print (PRINT)

Mode dial: ▶

You can mark a print mark on still images recorded with your camera. This mark is convenient when you have images printed at a shop that conforms with the DPOF (Digital Print Order Format) standard.

In single-image or triple-image mode

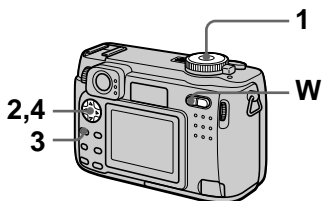

1 Set the mode dial to ▶.

2 In single-image mode

Display the image you want to print with ◀/▶.

In triple-image mode

Press the zoom W button twice in the single-image mode to turn to the triple-image mode.

Display the image you want to print with ◀/▶.

3 Press MENU.

The menu appears.

4 Select [PRINT] with ◀/▶ in single-image mode, or with ▲/▼ in triple-image mode, then press ●.

The ✓ (print) mark is marked on the displayed image (or the middle-positioned image in triple-image mode).

To unmark the print mark

Press ● again in step 4.  mark disappears.

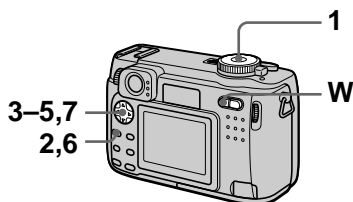

In index mode



1 Set the mode dial to , then display the index screen with the zoom W button.

2 Press MENU.
The menu appears.

3 Select [PRINT] with , then press ●.

4 Select [SELECT] with , then press ●.
When marking the , you cannot select [ALL].
The frame of the selected image turns green.

5 Select the images to be marked with the control button, then press ●.
To cancel, press ● again.
Repeat this step to select other images. The  mark appears on the selected image.

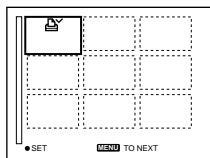



6 Press MENU.
The menu appears.

7 Select [OK] with , then press ●.



To unmark selected print marks

Select the images to be unmarked in step 5 with the control button, then press ●.

To unmark all the print marks

Select [ALL] with , then press ●. Select [OFF] with , then press ●.
The  marks on all images are unmarked.

To cancel marking the print mark

Select [CANCEL] with , then press ● or select [EXIT] with , then press ●.

Notes









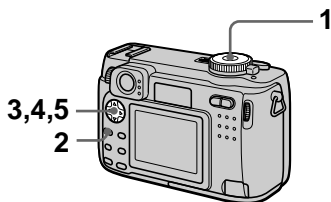



























- You cannot mark moving images, Clip Motion images or images recorded in TEXT mode.
- If you mark an image recorded in TIFF mode with a print mark, only the uncompressed image is printed, and the JPEG image recorded at the same time is not printed.
- In E-mail mode, a print mark is marked on the normal size image that is recorded at the same time.

Dividing a moving image file (DIVIDE)

Mode dial: 

You can divide moving images recorded in MPEG MOVIE mode. This is convenient when there is not enough space on a “Memory Stick” or when attaching moving images to e-mails.



- 1 Set the mode dial to  and display the moving image you want to divide.**
- 2 Press MENU.**
The menu appears.
- 3 Select [DIVIDE] with , then press , select [OK] with , then press .**
- 4 Play the moving image.**
If you press  at the divide point, [, , , , , , , , , , , , , , , , , , , , , , , , , , , , , , , ,

Step 1: Divide the unwanted scene A.

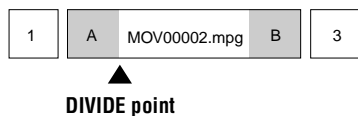

Step 2: Divide the unwanted scene B.

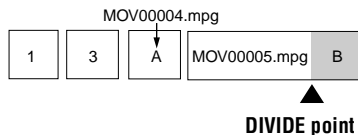

Step 3: Delete the unwanted scenes A and B.

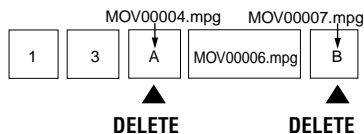

Step 4: Only the desired scene remains.

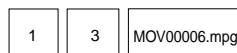

Notes

- You cannot divide Clip Motion files.
- You cannot recombine divided files.
- The original undivided file is not saved.

Changing the setup settings (SETUP)

Set the mode dial to SET UP. The setup screen appears. You can set up the following items with the control button. Factory settings are indicated with ■.

CAMERA

Item	Setting	Description
SCENE SELECTION	■ TWILIGHT LANDSCAPE PORTRAIT	Selects the SCENE SELECTION mode that is assigned to the SCN position (page 51).
MOVING IMAGE	■ MPEG MOVIE CLIP MOTION	Records the MPEG movie (pages 26, 56). Records the Clip Motion.
DATE/TIME	DAY & TIME DATE ■ OFF	Sets whether to insert the date and time into the image (page 61).
DIGITAL ZOOM	■ ON OFF	Uses digital zoom (page 22). Does not use digital zoom.
RED EYE REDUCTION	ON ■ OFF	Reduces the red-eye phenomenon (page 24).
AF ILLUMINATOR	■ ON OFF	Uses when it is hard to focus on the subject under dark situations (page 25).

SETUP 1

Item	Setting	Description
FORMAT	OK	Formats a “Memory Stick”. Note that formatting erases all the information recorded on a “Memory Stick”, including even erasure protected images (page 91).
	CANCEL	Cancels formatting of a “Memory Stick”.
FILE NUMBER	■ SERIES	Assigns numbers to files in sequence even if the “Memory Stick” is changed.
	RESET	Resets the file numbering each time the “Memory Stick” is changed.

Item	Setting	Description
CONVERSION LENS	ON ■ OFF	Set to "ON" when using the VCL-MHG07 conversion lens (not supplied). At this time, the zoom function does not work and you cannot turn off the LCD screen. Also, note that the VAD-S70 adaptor ring needed to mount the conversion lens to your camera is not sold in some countries and regions.
言語/ LANGUAGE	■ ENGLISH 日本語/JPN	Displays the menu items in English. Displays the menu items in Japanese.
CLOCK SET	OK CANCEL	Sets the date and time (Perform the procedure from step ③ on page 15).

SETUP 2

Item	Setting	Description
LCD BRIGHTNESS	BRIGHT ■ NORMAL DARK	Selects the LCD brightness. This has no effect on the recorded images.
LCD BACKLIGHT	BRIGHT ■ NORMAL	Displayed only when using your camera with the battery pack: Selects the brightness of the LCD backlight. Lets you set the brightness of the LCD backlight to [BRIGHT] or [NORMAL]. Selecting [BRIGHT] makes the screen bright and easy to see when using the camera outdoors or in other bright locations, but also uses up the battery charge faster.
BEEP	SHUTTER ■ ON OFF	Turns on the shutter sound only. (The shutter sound is heard when you press the shutter button.) Turns on the beep/shutter sound (when you press the control button/shutter button). Turns off the beep/shutter sound.
VIDEO OUT	NTSC PAL	Sets the video output signal to NTSC mode (e.g., Japan, the USA) (page 82). Sets the video output signal to PAL mode (e.g., Europe) (page 82).
USB CONNECT	PTP ■ NORMAL	Switches the USB mode (page 31).

Item	Setting	Description
DEMO	<input checked="" type="checkbox"/> ON/STBY <input type="checkbox"/> OFF	Displayed only when you use your camera with the AC power adaptor. [DEMO] is set to [STBY] at the factory and the demonstration starts about 10 minutes after you have set the mode dial to  , S, A, or M. To cancel the demonstration, turn off the power.

Notes on [DATE/TIME]

- The date and time do not appear on the LCD screen during shooting. These appear during playback.
- The date and time are not superimposed onto moving images and Clip Motion images.

Precautions

On cleaning

Cleaning the LCD screen

Wipe the screen surface with a cleaning cloth (not supplied) or a LCD cleaning kit (not supplied) to remove fingerprints, dust, etc.

Cleaning the camera surface

Clean the camera surface with a soft cloth slightly moistened with water, then wipe the surface dry. Do not use any type of solvent such as thinner, alcohol or benzine as this may damage the finish or the casing.

After using your camera at the seashore or other dusty locations

Clean your camera carefully. Otherwise, the salty air may corrode the metal fittings or dust may enter the inside of your camera, causing a malfunction.

Note on operating temperature

Your camera is designed for use between the temperatures of 0°C and 40°C (32°F and 104°F). Recording in extremely cold or hot places that exceed this range is not recommended.

On moisture condensation

If the camera is brought directly from a cold to a warm location, or is placed in a very damp room, moisture may condense inside or outside the camera. Should this occur, the camera will not operate properly.

Moisture condensation occurs easily when:

- The camera is brought from a cold location such as a ski slope into a warmly heated room.
- The camera is taken from an air-conditioned room or car interior to the hot outdoors, etc.

How to prevent moisture condensation

When bringing the camera from a cold place to a warm place, seal the camera in a plastic bag and allow it to adapt to conditions at the new location over a period of time (about an hour).

If moisture condensation occurs

Turn off the camera and wait about an hour for the moisture to evaporate. Note that if you attempt to record with moisture remaining inside the lens, you will be unable to record clear images.

On AC power adaptor

- Unplug the unit from the wall outlet (mains) when you are not using the unit for a long time.
- To disconnect the power cord (mains lead), pull it out by the plug. Never pull the power cord (mains lead) itself.
- Do not operate the unit with a damaged cord (mains lead) or if the unit has been dropped or damaged.
- Do not bend the power cord (mains lead) forcibly, or place a heavy object on it. This will damage the cord (mains lead) and may cause fire or electrical shock.
- Prevent metallic objects from coming into contact with the metal parts of the connecting section. If this happens, a short may occur and the unit may be damaged.
- Always keep metal contacts clean.
- Do not disassemble the unit.
- Do not apply mechanical shock or drop the unit.
- While the unit is in use, particularly during charging, keep it away from AM receivers and video equipment. AM reception and video operation are disturbed.
- The unit becomes warm during use. This is not a malfunction.
- Do not place the unit in locations that are:
 - Extremely hot or cold
 - Dusty or dirty
 - Very humid
 - Vibrating

On battery pack

- Use only the specified charger with the charging function.
- To prevent accident from a short circuit, do not allow metal objects to come into contact with the battery terminals.
- Keep the battery pack away from fire.
- Never expose the battery pack to temperatures above 60°C (140°F), such as in a car parked in the sun or under direct sunlight.
- Keep the battery pack dry.
- Do not expose the battery pack to any mechanical shock.
- Do not disassemble nor modify the battery pack.
- Install the battery pack to the camera securely.
- Charging while some capacity remains does not affect the original battery capacity.

If any problem occurs, unplug your camera and contact your nearest Sony dealer.

On internal rechargeable button battery

This camera has an internal rechargeable button battery for maintaining the date and time and other settings regardless of whether the power is on or off. This rechargeable button battery is constantly charged as long as you are using the camera. However, if you use the camera for only short periods it discharges gradually, and if you do not use the camera at all for about one month it becomes completely discharged. In this case, be sure to charge this rechargeable button battery before using the camera. However, even if this rechargeable button battery is not charged, you can still use the camera as long as you do not record the date and time.

Charging method

Connect the camera to a wall outlet (mains) with the AC power adaptor, or install a charged battery pack, and leave the camera for 24 hours or more with the POWER switch set to OFF.

On “Memory Sticks”

“Memory Stick” is a new compact, portable and versatile IC recording medium with a data capacity that exceeds a floppy disk. “Memory Stick” is specially designed for exchanging and sharing digital data among “Memory Stick” compatible products. Because it is removable, “Memory Stick” can also be used for external data storage.

There are two types of “Memory Sticks”: general “Memory Sticks” and “MagicGate Memory Sticks” that are equipped with the MagicGate* copyright protection technology.

You can use both types of “Memory Stick” with your camera. However, because your camera does not support the MagicGate standards, data recorded with your camera is not subject to MagicGate copyright protection.

* MagicGate is copyright protection technology that uses encryption technology.

Notes

- Do not remove the “Memory Stick” while reading or writing data.
- Data may be damaged if:
 - you remove the “Memory Stick” or turn off your camera while reading or writing data.
 - you use the “Memory Stick” in a location subject to the effects of static electricity or noise.
- Do not attach any other material than the supplied label on the labeling position.
- Attach the label so that it does not stick out from the proper attachment location.
- When you carry or store the “Memory Stick,” put it in its supplied case.
- Do not touch the terminals of a “Memory Stick” with your hand or a metal object.
- Do not strike, bend or drop the “Memory Stick.”
- Do not disassemble or modify the “Memory Stick.”
- Do not allow the “Memory Stick” to get wet.

“Memory Stick”,  MEMORY STICK™, “MagicGate Memory Stick” and  are trademarks of Sony Corporation.

“MagicGate” and **MAGICGATE** are trademarks of Sony Corporation.

About “InfoLITHIUM” battery pack

What is the “InfoLITHIUM” battery pack?

The “InfoLITHIUM” battery pack is a lithium-ion battery pack that has functions for communicating information related to operating conditions between your camera and the AC power adaptor.

The “InfoLITHIUM” battery pack calculates the power consumption according to the operating conditions of your camera, and displays the remaining battery time in minutes.

Charging the battery pack

- Be sure to charge the battery pack before you start using your camera.
- We recommend charging the battery pack in an ambient temperature of between 10°C to 30°C (50°F to 86°F) until the FULL indicator appears, indicating that the battery pack is fully charged. If you charge the battery pack outside of this temperature range, you may not be able to efficiently charge the battery pack.
- After charging is completed, disconnect the AC power adaptor from the DC IN jack on your camera or remove the battery pack.

Effective use of the battery pack

- Battery performance decreases in low-temperature surroundings. So, the time that the battery pack can be used is shorter in cold places. We recommend the following to use the battery pack longer:
 - Put the battery pack in a pocket close to your body to warm it up, and insert it in your camera immediately before you start taking shots.
- Frequently using the LCD panel or frequently operating the zoom wears out the battery pack faster.

- Be certain to turn the POWER switch to off when not taking shots or playing back on your camera.
- We recommend having spare batteries handy for two or three times the expected shooting time, and make trial shots before taking the actual shots.
- Do not expose the battery pack to water. The battery pack is not water-resistant.

Remaining battery time indicator

- If the power goes off although the battery remaining indicator indicates that the battery pack has enough power to operate, charge the battery pack fully again so that the indication on the battery remaining indicator is correct. Note, however, that the correct battery indication sometimes will not be restored if it is used in high temperatures for a long time or left in a fully charged state, or the battery pack is frequently used. Regard the remaining battery time indication as the approximate shooting time.

How to store the battery pack

- If the battery pack will not be used for a long time, use up the battery pack after fully charging it once per year. Remove the battery pack from your camera, then store it in a dry, cool place. This is to maintain the battery pack’s functions.
- To use the battery pack up on your camera, leave the POWER switch to on in slide show playback mode until the power goes off.

Battery life

- The battery life is limited. Battery capacity decreases little by little as you use it more and more, and as time passes. When the battery operating time is shortened considerably, a probable cause is that the battery pack has reached the end of its life. Please buy a new battery pack.
- The battery life varies according to how it is stored and operating conditions and environment for each battery pack.

Using your camera abroad

Power sources

You can use your camera in any country or area with the supplied battery charger within 100 V to 240 V AC, 50/60 Hz. Use a commercially available AC plug adaptor [a], if necessary, depending on the design of the wall outlet (mains) [b].

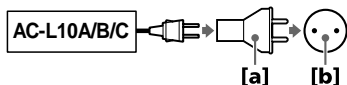

SECAM system

Bulgaria, Czech Republic, France, Guiana, Hungary, Iran, Iraq, Monaco, Poland, Russia, Slovak Republic, Ukraine, etc.

Watching the playback picture on TV

If you want to view the playback picture on a TV, you need a TV having a video input jack and a video connecting cable.

The color system of the TV must be the same as that of your digital still camera. Check the following list:

NTSC system

Bahama Islands, Bolivia, Canada, Central America, Chile, Columbia, Ecuador, Jamaica, Japan, Korea, Mexico, Peru, Surinam, Taiwan, the Philippines, the U.S.A., Venezuela, etc.

PAL system

Australia, Austria, Belgium, China, Denmark, Finland, Germany, Great Britain, Holland, Hong Kong, Italy, Kuwait, Malaysia, New Zealand, Norway, Portugal, Singapore, Spain, Sweden, Switzerland, Thailand, etc.

PAL-M system





Brazil



PAL-N system







Argentina, Paraguay, Uruguay



Troubleshooting

If you experience trouble with your camera, first check the following items. Should your camera still not operate properly after you have made these checks, press the reset button located on the bottom. (If you press the reset button, the date and time setting is cleared.) Should your camera still not operate properly, consult your Sony dealer or local authorized Sony service facility. **If code displays (C:□□:□□) appear on the LCD screen, the self-diagnosis display function is working (page 91).**

Symptom	Cause and/or Solution
Your camera does not work.	<ul style="list-style-type: none"> • You are not using an “InfoLITHIUM” battery pack. → Use an “InfoLITHIUM” battery pack (page 10). • The battery level is low (the  indicator appears on the LCD screen). → Charge the battery pack (page 11). • The AC power adaptor is not connected securely. → Connect it firmly to the DC IN jack of your camera and a wall outlet (mains) (pages 11, 14). • The built-in microcomputer is not working properly. → Disconnect and then reconnect all power sources after one minute. Then turn the power on by sliding the POWER switch and check that the camera works properly. Press the reset button located on the bottom using a sharp-pointed object.
Your camera cannot record images.	<ul style="list-style-type: none"> • You cannot record images while charging the flash. • The mode dial is set to  or SET UP. → Set it to , S, A, M, SCN or  (pages 19, 26). • No “Memory Stick” has been inserted into your camera. → Insert a “Memory Stick” (page 17). • The write-protect tab on the “Memory Stick” is set to LOCK. → Set it to the recording position.
The LCD screen does not light when the power is turned on.	<ul style="list-style-type: none"> • The power was turned off with the LCD screen set to OFF the last time the camera was used. → The camera retains the settings from the last time it was used. If you turn the power off with the LCD screen set to OFF, the LCD is still set to OFF the next time you turn the power on.

Symptom	Cause and/or Solution
The picture is out of focus.	<ul style="list-style-type: none"> • Your camera is not in macro recording mode when you shoot a subject that is within 50 cm (19 3/4 inches) from the lens. → Set the macro recording mode (page 58). • The LANDSCAPE mode of the SCENE SELECTION function is selected. → Cancel the function. • The focus preset is selected. → Cancel the function (page 58). • [CONVERSION LENS] is set to [ON]. → Set it to [OFF] (page 77).
The resizing function does not work.	<ul style="list-style-type: none"> • You cannot resize moving images, text images, Clip Motion and uncompressed images.
Images recorded in TEXT mode are blurry.	<ul style="list-style-type: none"> • Light is not striking the subject evenly. → Adjust so that the lighting strikes the subject evenly.
You cannot record images in TEXT mode.	<ul style="list-style-type: none"> • The mode dial is set to . → Set the mode dial to .
You cannot display a print mark.	<ul style="list-style-type: none"> • You cannot display print marks on moving images, text images and Clip Motion images.
The picture is noisy.	<ul style="list-style-type: none"> • Your camera is placed near a TV or other equipment that uses strong magnets. → Move your camera away from the TV, etc.
The picture is too dark.	<ul style="list-style-type: none"> • You are shooting a subject with a light source behind the subject. → Adjust the exposure (page 59). • The brightness of the LCD screen is too low. → Adjust the brightness of the LCD screen (page 77).

Symptom	Cause and/or Solution
The flash does not work.	<ul style="list-style-type: none"> • The flash is set to  . → Set the flash to auto (no indicator) or  (page 24). • The camera is in one of the following SCENE SELECTION modes: TWILIGHT or LANDSCAPE. → Cancel the SCENE SELECTION function (page 51) or set the flash to  . • The mode dial is set to , SETUP or  (MPEG MOVIE). → Set it to  . • [MODE] (REC MODE) is set to [BURST2] in the menu settings. → Set it to other modes.
The date and time are recorded incorrectly.	<ul style="list-style-type: none"> • The date and time are not set correctly. → Set the correct date and time (page 15).
Vertical streaks appear when you are shooting a very bright subject.	<ul style="list-style-type: none"> • The smear phenomenon is happening. → This is not a malfunction.
The battery life is short.	<ul style="list-style-type: none"> • You are recording/playing back images under extremely cold temperatures. • The battery pack is not charged enough. → Charge the battery pack fully. • The battery pack is dead. → Replace the battery pack with a new one (page 81).
The battery remaining indicator is incorrect. Or sufficient battery remaining indicator is displayed but the power runs out soon.	<ul style="list-style-type: none"> • You have used the camera for a long time in an extremely hot or an extremely cold location. • The battery pack is dead. → Replace the battery pack with a new one (page 81). • The battery pack is discharged. → Install a charged battery pack (pages 10, 11). • A deviation has occurred in the remaining battery time. → Fully charge the battery pack (page 11).
Nothing appears in the display window or the indicators flash during charging.	<ul style="list-style-type: none"> • The AC power adaptor is disconnected. → Firmly connect the power cord to the wall outlet (page 14). • The battery pack is not installed correctly. → Install the battery pack correctly (page 10). • Charging is completed.

Symptom	Cause and/or Solution
You cannot charge the battery.	<ul style="list-style-type: none"> The camera is turned on. → Turn the camera off (page 11).
The POWER ON/OFF (CHG) indicator flashes.	<ul style="list-style-type: none"> The battery pack is not installed correctly. → Install the battery pack correctly (page 10). The battery pack has malfunctioned. → Contact your Sony dealer or local authorized Sony service facility.
The zoom does not work.	<ul style="list-style-type: none"> [CONVERSION LENS] in the setup setting is set to [ON]. → Set it to [OFF] (page 77). The zoom cannot be used when recording a moving image with [MOVING IMAGE] set to [MPEG MOVIE].
Digital zoom does not function.	<ul style="list-style-type: none"> The digital zoom cannot be used when recording a moving image with [MOVING IMAGE] set to [MPEG MOVIE], or the LCD screen is OFF. [DIGITAL ZOOM] is set to [OFF]. → Set [DIGITAL ZOOM] to [ON] in the menu settings.
Your camera cannot play back images.	<ul style="list-style-type: none"> The mode dial is set to , , M, A, S, SCN or SET UP. → Set it to  (pages 28, 29).
The image and sound are interfered by noise when you play back an image on a personal computer.	<ul style="list-style-type: none"> You are playing back the file directly from the “Memory Stick.” → Copy the file to the hard disk of the personal computer and then play back the file from the hard disk (page 36).
The image cannot be played back on a personal computer.	<ul style="list-style-type: none"> → Consult the personal computer or software manufacturer.
Your camera cannot delete an image.	<ul style="list-style-type: none"> The image is protected. → Cancel the protection (page 68).
The power turns off suddenly.	<ul style="list-style-type: none"> If you do not operate the camera for about three minutes while the power is on, the camera turns off automatically to prevent wearing down the battery (page 20). → Turn on the camera. The battery is discharged. → Replace it with a charged battery.



Symptom	Cause and/or Solution
The image does not appear on the TV screen.	<ul style="list-style-type: none"> The video output signal setting of your camera is incorrect. → Change the setting (page 77).
A file error occurs when you play back a file.	<ul style="list-style-type: none"> The image size is larger than 2048×1536. → Use an image size of 2048×1536 or smaller.
The picture is monochrome (black and white).	<ul style="list-style-type: none"> The camera is set to TEXT mode. → Cancel TEXT mode (page 55). P. EFFECT is set to B&W mode. → Cancel B&W mode (page 61).
The lens does not retract even when the power is turned off.	<ul style="list-style-type: none"> The battery is discharged. → Replace it with a fully charged battery or use the AC power adaptor.
Your personal computer does not recognize your camera.	<ul style="list-style-type: none"> The battery level is low. → Use the AC power adaptor (page 14). The camera is turned off. → Turn on the camera. The USB cable is not connected firmly. → Disconnect the USB cable, and connect it again firmly. Make sure that “USB MODE” is displayed on the LCD screen (pages 33, 35). The USB connectors on your personal computer are connected to other equipment besides the keyboard, the mouse, and your camera. → Disconnect the USB cables except for the ones connected to the keyboard, the mouse, and your camera. The USB driver is not installed. → Install the USB driver (page 33). [USB CONNECT] is set to [PTP] in the setup settings. → Set it to [NORMAL] (page 77). Since the camera is connected to a computer with the USB cable before installing the USB driver, the drive is not recognized by the computer. → Delete the drive which is not recognized, then install the USB driver. For details, see the procedure on page 88.
No function works though the power is on.	<ul style="list-style-type: none"> → Remove the battery pack, then install it again after about one minute. If the function still do not work, press the reset button located on the bottom using a sharp-pointed object. (If you press the reset button, the date and time setting is cleared.)

Reinstall the USB driver when using Windows 98, Windows 98SE, Windows Me and Windows 2000 Professional

Perform all steps without skipping.



- 1 Turn on your computer and allow Windows to load.**
- 2 Connect the USB jack on the camera and the computer with the supplied USB cable.**
- 3 Insert a “Memory Stick”.**
- 4 Connect the AC power adaptor to your camera and then to a wall outlet (mains), and turn on the power of your camera.**
- 5 Open “Device Manager” on Windows.**

For Windows 98, Windows 98SE and Windows Me users:

- ① Open [Control Panel] from [ My Computer], then double-click [System].
- ② “System properties” is displayed. Click the [Device Manager] tab located at the top.
- ③ Click [ Sony DSC] in [ Other devices], then click the [Delete (E)] button located at the lower-right corner.

For Windows 2000 Professional users:



* Log in with the permission of administrator.

- ① Open [Control Panel] from [ My Computer], then double-click [System].
 - ② “System properties” is displayed. Click the [Hardware] tab located at the top, then click the [Device Manager (D)] button.
 - ③ Click [View] in [Device Manager], then click [Devices by type (E)].
 - ④ Right-click [ Sony DSC] in [ Other devices], then click [Delete (E)].
- 6 After the message appears to verify that you delete the device, click “OK.”**
 - 7 Turn off the camera, disconnect the USB cable, and restart the computer.**
 - 8 Install the USB driver in the supplied CD-ROM to the computer following the procedure on page 33.**

Warning and notice messages

Various messages appear on the LCD screen. Check the corresponding descriptions in the following list.

Message	Meaning
NO MEMORY STICK	No “Memory Stick” has been inserted.
SYSTEM ERROR	Turn the power off and on again.
MEMORY STICK ERROR	<ul style="list-style-type: none">• The inserted “Memory Stick” cannot be used with your camera, or is damaged.• The “Memory Stick” is not inserted correctly.
FORMAT ERROR	Failed to format the “Memory Stick.”
MEMORY STICK LOCKED	The write-protect tab on the “Memory Stick” is set to the LOCK position.
NO MEMORY SPACE	The capacity of the “Memory Stick” is full, and you cannot record or copy images.
NO FILE	No image has been recorded on the “Memory Stick.”
FILE ERROR	An error occurred while playing back the image.
FILE PROTECT	The image is protected against erasure.
for “InfoLITHIUM” battery only	The battery is not the “InfoLITHIUM” type.
NOT ENOUGH MEMORY	The images you want to copy are too big to copy with your camera.
COPY ERROR	Copying was not performed correctly, or the “Memory Stick” was removed during copying.
DIRECTORY ERROR	A directory with the same name already exists on the “Memory Stick.”
IMAGE SIZE OVER	You are playing back an image of a size that cannot be played back with your camera.
INVALID OPERATION	You are playing back a file that was created on equipment other than your camera.

Message	Meaning
	<p>The battery level is low or zero. Depending on the conditions of use or the type of battery pack, the indicator may flash even though there is still 5 to 10 minutes of remaining battery time left.</p>
LENS CAP ATTACHED	The lens cap is still attached to the lens.
CANNOT DIVIDE	<ul style="list-style-type: none"> • The file is not long enough to be divided. • The file is not a moving image.
	<p>The amount of light is not sufficient or the shutter speed is too slow. (Mount the camera on a tripod or otherwise secure the camera in place.)</p>
TURN THE POWER OFF AND ON AGAIN	A malfunction occurs on the lens.

Self-diagnosis display

Your camera has a self-diagnosis display. This function displays the camera condition on the LCD screen with a combination of a letter and four digits of numbers. If this occurs, check the following code chart. The code informs you of the camera's current condition. The last two digits (indicated by □□) will differ depending on the state of the camera.

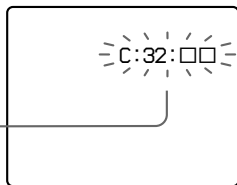

Self-diagnosis display

- C:□□:□□
You can reverse the camera malfunction yourself.
- E:□□:□□
Contact your Sony dealer or local authorized Sony service facility.

First three digits	Cause and/or Corrective Action
C:32:□□	<ul style="list-style-type: none">• There is trouble with your camera's hardware or zooming function. → Turn the power off and on again.
C:13:□□	<ul style="list-style-type: none">• The camera cannot read or write data on the "Memory Stick." → Re-insert the "Memory Stick" several times.• An unformatted "Memory Stick" is inserted. → Format the "Memory Stick" (page 76).• The inserted "Memory Stick" cannot be used with your camera, or is damaged. → Insert a new "Memory Stick" (page 17).
E:61:□□ E:91:□□	<ul style="list-style-type: none">• A camera malfunction that you cannot reverse has occurred. → Contact your Sony dealer or local authorized Sony service facility and inform them of the 5-digit service code. (example: E:61:10)

If you are unable to solve the problem even after trying the corrective actions a few times and when the camera is not reset even if you press the reset button located on the bottom, contact your Sony dealer or local authorized Sony service facility.

When a self-diagnosis display appears

The error display appears on the display window (page 93).

Specifications

System

Image device

8.93 mm (1/1.8 type) color
CCD

Lens

3× zoom lens
f = 7 – 21 mm (9/32 – 27/32
inches)

(34 – 102 mm (1 3/8 – 4 1/8
inches) when converted into a
35 mm still camera)

F = 2.0 – 2.5

Exposure control

Automatic exposure, Shutter
speed priority, Aperture
priority, Manual exposure

White balance

Automatic, Indoor, Outdoor,
One-push

Data system

Movie: MPEG1

Still: JPEG, GIF (in TEXT
mode, Clip Motion), TIFF

Audio with still image:
MPEG1 (Monaural)

Recording medium

“Memory Stick”

Flash

Recommended recording
distance (ISO is set to AUTO):
0.3 m to 3.0 m (11 7/8 inches
to 9 feet 10 1/8 inches)

Output connector

A/V OUT (Monaural)

Minijack

Video: 1 V_{p-p}, 75 Ω,
unbalanced, sync negative
Audio: 327 mV (at a 47 kΩ
load)

Output impedance: 2.2 kΩ

USB jack

mini-B

ACC (Accessory) jack

Minijack

LCD screen

Used LCD panel

4.6 cm (1.8 type) TFT (Thin
Film Transistor active matrix)
drive

Total number of dots

123 200 (560×220) dots

General

Used battery pack

NP-FM50

Power requirements

7.2 V

Power consumption

(during recording)

3.0 W

Operation temperature

0°C to 40°C

(32°F to 104°F)

Storage temperature

–20°C to +60°C

(–4°F to +140°F)

Maximum dimensions

117×71×64 mm

(4 5/8×2 7/8×2 5/8 inches)

(w/h/d)

Mass

Approx. 462 g (1 lb)

(including battery pack NP-
FM50, “Memory Stick,”
shoulder strap and lens cap
etc.)

Built-in microphone

Electret condenser microphone

Built-in speaker

Dynamic speaker

AC-L10A/B/C

AC power adaptor

Power requirements

100 to 240 V AC, 50/60 Hz

Rated output voltage

DC 8.4 V, 1.5 A in operating
mode

Operation temperature

0°C to 40°C (32°F to 104°F)

Storage temperature

–20°C to +60°C

(–4°F to +140°F)

Maximum dimensions

125×39×62 mm

(5×1 9/16×2 1/2 inches)

(w/h/d)

Mass

Approx. 280 g (10 oz)

NP-FM50 battery pack

Used battery

Lithium ion battery

Maximum voltage

DC 8.4 V

Nominal voltage

DC 7.2 V

Capacity

8.5 Wh (1 180 mAh)

Accessories

A/V connecting cable (1)

NP-FM50 battery pack (1)

AC-L10A/B/C AC power

adaptor (1)

Power cord (1)

USB cable (1)

Lens cap (1)

Lens cap strap (1)

Shoulder strap (1)

“Memory Stick” (8 MB) (1)

CD-ROM (USB driver

SPVD-004) (1)

Operating Instructions (1)

Design and specifications are
subject to change without
notice.

Display window indicators

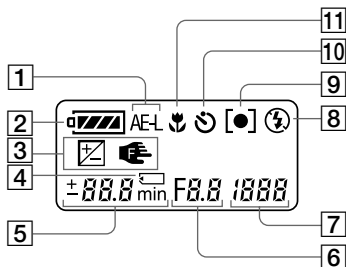



- 1 AE lock indicator
- 2 Battery remaining indicator
- 3 EV indicator/Focus lock indicator
- 4 “Memory Stick” mark
- 5 Remaining number of recordable images indicator (+999 is displayed for 999 or more images)/EV level indicator/Focus distance indicator/Battery usable time indicator (displayed only during charging)/Minutes indicator for the remaining recordable time of moving images
- 6 Aperture value indicator/Seconds indicator for the remaining recordable time of moving images
- 7 Shutter speed indicator
USB indicator
Error display
Err: Some kind of misoperation has occurred. Check the self-diagnosis display on the LCD screen (page 91) and take the appropriate corrective action.
LENS: A problem has occurred with lens drive. Turn the camera on and off several times, and if the problem persists, contact your Sony dealer or authorized Sony service facility.
- 8 Flash mode indicator
- 9 Spot light-metering indicator
- 10 Self-timer indicator
- 11 Macro mode indicator

LCD screen indicators

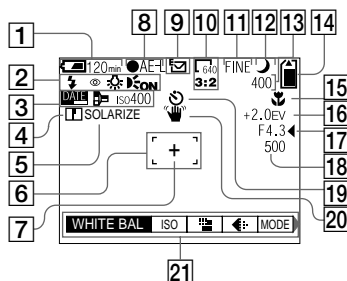

The indicators during recording still images

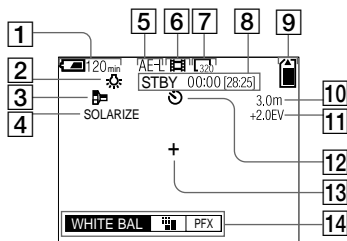

- | | | | |
|----|--|----|---|
| 1 | Battery remaining indicator | 12 | Mode dial indicator |
| 2 | Flash mode/red eye reduction/
white balance/AF illuminator
indicator | 13 | Remaining number of
recordable images indicator/
Self-diagnosis function
indicator |
| 3 | Date/time/conversion lens/ISO
number indicator | 14 | Remaining memory capacity
indicator |
| 4 | Sharpness indicator | 15 | Macro  /focus mode 
indicator/Focus preset value |
| 5 | Picture effect indicator | 16 | EV level indicator |
| 6 | AF frame | 17 | Aperture value indicator |
| 7 | Spot light-metering cross hair | 18 | Shutter speed indicator |
| 8 | AE/AF lock indicator | 19 | Self-timer indicator |
| 9 | Recording mode indicator | 20 | Light amount warning indicator |
| 10 | Image size indicator | 21 | Menu and guide menu |
| 11 | Image quality indicator | | Pressing MENU switches the
menu on/off. |

The indicators during recording moving images



- | | |
|---|--|
| 1 Battery remaining indicator | 9 Remaining memory capacity indicator |
| 2 White balance indicator | 10 Macro  /focus mode  indicator/Focus preset value |
| 3 Conversion lens indicator | 11 EV level indicator |
| 4 Picture effect indicator | 12 Self-timer indicator |
| 5 AE lock indicator | 13 Spot light-metering cross hair |
| 6 Recording mode indicator | 14 Menu and guide menu |
| 7 Image size indicator | Pressing MENU switches the menu on/off. |
| 8 Recording time [maximum recordable time] indicator/
Self-diagnosis function indicator | |

When playing back still images

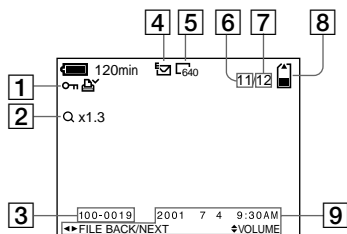

- | | |
|--------------------------------|--|
| 1 Protect/print mark indicator | 7 Number of stored images in "Memory Stick" |
| 2 Zoom scaling indicator | 8 Remaining memory capacity indicator |
| 3 File name | 9 Recording date of the playback image/menu and guide menu |
| 4 Recording mode indicator | |
| 5 Image size indicator | |
| 6 Image number | |

When playing back moving images

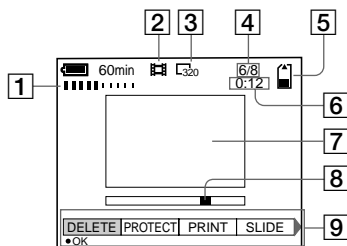

- | | |
|--|-----------------------|
| 1 VOL. (Volume) indicator | 6 Counter |
| 2 Recording mode indicator | 7 Playback image |
| 3 Image size indicator | 8 Play bar |
| 4 Image number/number of stored images in "Memory Stick" | 9 Menu and guide menu |
| 5 Remaining memory capacity indicator | |

Index

A

- Adjusting the exposure ... 59
- AE (Auto Exposure) 20
- AE lock 49
- Aperture priority mode ... 50
- Auto power-off
function 20
- Auto red-eye
reduction 24, 76

B

- Battery pack
battery life 12
- charging 11
- installing 10
- battery remaining
indicator 94
- BEEP 77
- BURST 52

C

- Charging the battery
pack 11
- Cleaning 79
- Clip Motion 56
- Control button 18, 41
- Conversion lens 77
- COPY 71

D

- DELETE 67
- Digital zoom 22
- Display window
indicators 93
- DPOF 72

E

- Editing
COPY 71
- DELETE 67
- PROTECT 68
- E-MAIL 53
- Enlarging a part of the still
image 64

F

- File name 38
- FILE NUMBER 76
- FLASH LEVEL 24, 44
- Focus preset 58
- Focusing 58
- FORMAT 76

G

- GIF 39, 55, 56

I

- Image
Deleting 67
- Print mark 72
- Protect 68
- Size 47
- INDEX screen 63
- "InfoLITHIUM" battery
pack 10

J

- Jog dial 42
- JPEG 19, 39

L

- LCD screen 94
- LCD screen indicators 94

M

- Macro recording 58
- "Memory Stick"
copying image 71
- formatting 76
- inserting 17
- Number of recordable
images 48, 53-57
- Menu 41
- MOBILE mode 56
- Mode dial 18, 40
- Moisture condensation ... 79
- Moving images
playing back 29
- recording 26
- MPEG 26, 39

N

- NTSC system 82
- Number of recordable
images
Clip Motion 57
- E-mail mode 53
- Image size 48
- TEXT mode 55
- TIFF mode 56
- VOICE mode 54

P

- PAL system 82
- Picture effect 61
- Playing back
INDEX screen 63
- moving images 29
- Slide show 65
- still images 28
- Power supply
AC power adaptor 14
- battery pack 11
- PRINT MARK 72
- PROTECT 68

Q

- Quick Review 21

R

- REC MODE 44
- Recording
Clip Motion 56
- E-mail mode 53
- images in macro 58
- moving images 26
- still images 19
- TEXT mode 55
- TIFF mode 56
- VOICE mode 54
- with the flash 24
- RESIZE 70
- ROTATE 66

S

- SCENE SELECTION 51
- SECAM system 82
- Self-diagnosis display 91
- Self-timer 23, 27
- SET UP 76
- Setting date and time 15
- SHARPNESS 45
- Shutter speed priority
mode 50
- Single display 63
- SLIDE SHOW 65
- Spot light-metering 62
- Still images
playback 28
- recording 19

T

- TEXT 55
- TIFF 39, 56
- TV color system 82

U

- USB 33
- Using your camera
abroad 82

V

- Viewing images
on a TV screen 66
- using a personal
computer 31
- VOICE 54

W

- Warning and notice
messages 89
- WHITE BALANCE 60

Z

- Zoom 22

<http://www.world.sony.com/>

Sony Corporation Printed in Japan



306818712