

- ◆ **Automotive multimedia playback system**
- ◆ **True color TFT LCD with touch-screen**

Car Video, Audio and Navigation System User manuals

In the use of this product, please read this manual and keep for future reference. to avoid any injury or accident, please read the notice of this manual in details before you install the product



Thank you for choosing the car audio-visual navigation system of this company!

When you use this product, please read all the information attached with it, this manual is introduced all the functions of audio-visual navigation system,so that you use to facilitate the process easier. Through it, you can obtain information about products introduction, operation methods, make sure the operation is more convenience.

The display picture example of manual referenced may be a little different from the actual picture.

The display contents of this manual may be a little different with the actual content.

If any parameters change when Products continue to update and upgrade their functions, will be added to make without notice. Any problem please check the details with the agent, thank you for your support and cooperation!

The information of this manual protected by copyright, any part of it without company prior written permission is not permitted in any way to copy and photocopy. The Company reserves the final explanation about three guarantees warrant and relative information in this manual.

Safety Notes.....	01	TV setting.....	13
Pre-installation notes	02	Analog TV setting.....	13
System installation.....	03	DVB-T(optional).....	14
other notice.....	04	Radio fuction operation.....	20
Fast Guide for Buttons on Main Unit.....	07	Bluetooth fuction operation.....	21
Description of Buttons on Remote Control.....	08	IPOD function.....	23
Operation of turn on and turn off the player.....	09	AUX in.....	23
The main menu.....	09	GPS fuction operation.....	23
DVD basic operation.....	10	System setting.....	30
DVD system setting.....	11	Picture-in-picture feature.....	33
Virtual CD driver setting.....	12	Two zone setting.....	33
USB setting.....	12	Connection.....	35
Picture capture to be DVD starting logo function.....	12	Troubleshooting.....	36
SD setting.....	13	Product specification.....	37

 Safety Notes

In order to avoid any injury or property damage of the user or other persons, please be sure to read in details and abide the following notice item.

- 1) read the Manual
- 2) take good care of the Manual for future use.
- 3) to comply with all the warning and notice of this manual.
- 4) to comply with all operating instructions.
- 5) regarding the power supply, please refer what the manual stated.
- 6) the installation and wiring distribution of this product needs specialized skills and experience. To ensure safety, commissioned by professional technicians for installation and wiring.
- 7) there is no any parts attached with the products for user to repair and replace, please ask the professional technician with qualification of maintenance to repair and replace.
- 8) Do not plug any ventilation cooling vents, the local shell holes and other openings are for ventilation of heat. In order to ensure machine works stable and reliable, long service life, not to plug the hole cooling, ventilation environment must be maintained to avoid overheating the machine caused by smoking, fire or other danger.
- 9) heat source should be avoided and products will be not installed on local exposure to direct sunlight, high temperature areas; to be away from heat sources, such as heating, heaters, heat or have other things (including amplifiers).
- 10) should avoid water or moist, do not let this machine being exposed to rain or moisture in the environment (as when rain and car washing) to avoid the internal machinery of the short circuit caused the fire, electric shock or other danger.
- 11) before cleaning machines have to shut down power, and then wipe panel Do not use volatile chemicals (such as gasoline or thinner) to clean panel.

12) to prevent foreign matter or liquid into the inside of the machine , do not insert the foreign body from the cooling hole or other opening into the machine. If you insert foreign bodies may cause electric shock, machine parts within a short circuit caused the fire, such as the risk of electric shock.

13) How to install the machines, do not install the unit to the truck, frame, tripod, bracket or table without the manufacturer's recommendations, should be installed on the install fittings which come with machines. When used in the car, pay more attention to firm the installation of this machine, avoid the machine falling down because of the sudden brake and resulting in personal injury.

14) Don't operate the machine in the event of rain or lightning for a long time, have to cut off the machine power.

15) Appear in the following situations, please turn off the local power supply in time, and contact with professional technician.

- a. When the power cord or plug damaged.
- b. When the machines were splashed with liquid or when the entry of foreign matter;
- c. when the machine has been rained or moisture attack;
- d. when the machine crashed from a height or as a result of abnormal operation or unreasonable damage caused.

16) LCD: do not let the machine decline to avoid LCD screen fragmentation, if so, when the outflow of liquid crystal, do not touch the liquid crystal, so as not to be harmed. Do not heat the liquid crystal display or scratching LCD with sharp objects, touch panel is also susceptible to scratching. The effective pixel of LCD screen is more than 99.99 percent, but 0.01 percent of the pixels could not be lighten normally.

17) The Manual of instructions and icons just to explain the functions, there may be a little different with actual operation, the user should follow the actual operation.

Before the operation

law, do not use other function as purposes expect navigation when driving.

※In some areas, drivers or other people in car, it is illegal to watch the images of the display.

Pre-installation notes

※products of the manufacturers recommend that you do not install or repair their navigation systems by yourself. Installation and maintenance of the product may cause you in danger of electric shock or other, for all installation and maintenance operations of this navigation system please entrusted to the service personnel authorized by manufacturer.

※prohibiting use the following dangerous installing way and location:

1.when the car in a sudden stop may cause injury on the driver and passengers.

2.to avoid the possibility that impede the operation of the vehicle drivers, such as the driver front seat or the floor near the steering wheel, stick shift.

※in the dashboard panel or before open the hole from faceplate, make sure that the rear space. Be careful, not to damage the fuel cable, brake cable, electrical components, power lines or cable communications.

※in the use of screws, please ensure that they are not contact with any electrification down-lead. Vibration may have damaged wire or insulation skin and lead to a short circuit or other damage to the vehicle.

※ In order to ensure proper installation,use the standard method of installation of the required components. If you use any non-standard components,this product can be internal damage or loose components, leading to damage of the Product.

※If the GPS antenna may lead to the winding column or stick shift that would be very dangerous. Please ensure that the installation of the product will not disturb driving.

※Please ensure that all leading cable will not be caught by the doors

or sliding framework in the seat, so as not to cause a short circuit.

※after finish the installation of navigation systems, please check vehicles and other equipment is correct.

※some governments may prohibit or restrict to install or use of the system in the vehicle. Please comply with all the rules related to the application of laws and regulations. on using, installation and operation of the navigation system

※This product will be installed in the position between the driver's seat and passenger seat in order not avoid any damage on the unit by driver and passenger when the car suddenly brake.

※Never install this product on the dashboard, door or columniation and girder, and the position the air bag expanding out and nearby, Please refer to your vehicle owner's manual to find out the area front airbags expanding

※Do not install this product on the location may prevent the vehicles, including airbags, pillows and any operating system performance.

※prevent electromagnetic interference: In order to avoid Electromagnetic interference, please try to stay away from the following components of this product, cable or other lead.

-FM, AM antenna and its lead

-GPS antenna and its lead

And you should arrange every leads to stay away from each other, not make it colligation or cross-banding together. EMI will increase the possibility of showing wrong location.

System installation

1.the installation of voltage

a.this product use for the vehicle with 12V battery and negative end. Before the installation, check the battery voltage.

b.In order to avoid short-circuit system, installed prior to the proposed removal of the negative battery terminal.

c.can not cross the fuse of this product directly to the battery then on.

.2.

d.Do not connect this product power cord directly to other power-line circuits.

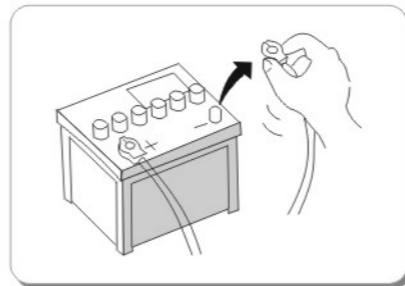

2.the installation of mainframe

a.First of all, take the original host vehicle out.

b.remove the install bracket and screws and keep it.

c.firm the bracket through the screws on the navigation system mainframe

d.fix all the cables according to the hose diagram

e.install the navigation system in right position and then screw the bracket of the original car to fix it well.

Note: do not damage or dirty the instrument appearances.

3.the installation of GPS antenna

To install the antenna in the inner of the car(on the rear shell),please try to make the metal plate stick on the horizontal lever so that the GPS antenna towards the window. GPS antenna will be placed on the metal plate. (GPS antenna fixed by magnetic.)

.3.

Before the operation

Notice: the metal plate have powerful glutinosity to leave the impress when you remove it.

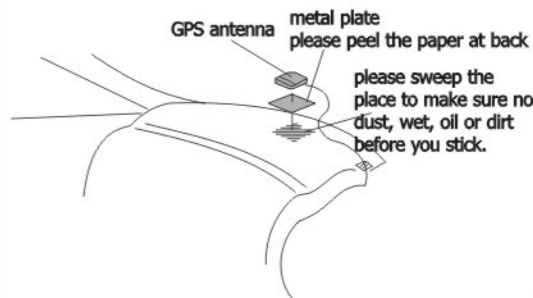

NOTE:

Paste in the metal plates, should not be cut it into small pieces. Some models of vehicles does not allow glass windows GPS satellite signal penetration. At this point, the GPS antenna should be installed on the outside of the vehicle.

To install an external antenna (in the car body)

GPS antenna will be placed in a level position as far as possible, such as roof or cover suitcase Department. (By a fixed magnetic body.)

Before the operation

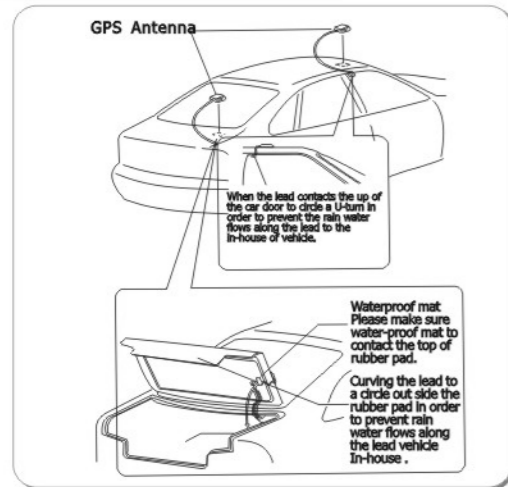

failure, as well as the use of pollution around the danger.

1. Please put the batteries in the remote after confirm the + and-of batteries.
2. Please use the batteries we suggested.
3. Please change the exhausted batteries in time for your better use.
4. Please take the batteries out, if you don't want to use the remote for a long time.
5. Bind up depleted batteries with adhesive tape or store them in a plastic bag for insulation in storage.
6. Never charge, short-circuit, dismantle, deform and heat the batteries or throw them into fire or water and make them contact with any metallic object
7. Never place batteries or remote control loaded with batteries in the surroundings at high temperature including an enclosed vehicle with doors and windows closed, trunk or a place in the direct sunshine and adjacent to a heater.
8. Keep batteries away from children. And sent to the hospital immediately if they swallow down any battery.

Cautions about Batteries

1. Type of Battery: lithium battery
 2. Operation Life: approx. 1 year (under indoor temperature) in normal operation
 3. While disposing batteries, make sure to observe the local regulations on depleted batteries.
- Treatments for battery electrolyte leakage are presented below:
1. Wipe off the electrolyte residue inside the battery compartment and put in new batteries.
 2. When the leaked electrolyte attaches to the human body or skin, rinse it off with water.
 3. If the electrolyte enters your eyes, do not rub with hands but rinse with water and then go through the medical treatment.

.4.

Other notice

The operation and maintenance of remote control
Do not put remote control on the dashboard, the steering wheel or sun-baked place, especially in the summer as the high temperature will lead to deformation of the remote control.
When the car stopped in the sun-baked place, the remote control should be placed on storage boxes or sunproof area. Under direct sunlight, the signal from the remote control may not be correct to receive by the machine. Therefore, please put remote control near the front panel of sensors. on the proper use of batteries if the battery used properly, due to rupture and leakage of electrolyte and cause fever, fire, injury or

Before the operation

Emergency Treatment:

In order to prevent life or property damages to the user or others, please immediately turn the power off and deliver it back to the nearest maintenance center or automobile stereo system dealer for assistance in the case of any foregoing abnormality.

Battery Installation

1. Take out the battery holder.
Push and press the point A along the direction shown by the arrow and draw out the battery holder at the point B.
2. Put the battery into the battery holder.
3. Insert the battery holder back to the original place.

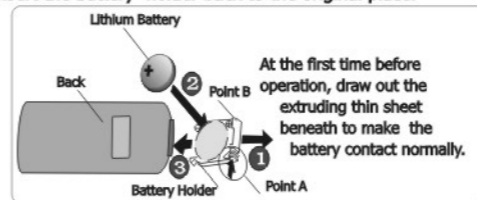

The DVD Disk

The DVD player can play DVD disk which have marked format as following:



DVD player can not play the disk which the region code is not compatible. (DVD player is full region code)

.5.

The maintenance of the DVD player

Please use the conventional circular disk, not to insert irregular, non-circular disk, otherwise these disks may be stuck inside the DVD player, or the DVD player may not correctly play.
Please check before playing on the disk if there is cracks, scratches or curly. Such discs may not play and lead to product failure. Do not use this type of disc. Using disc, do not touch the recording surface (non-printed surface)
Please put the disk in the box if it's not in use.
Please don't put the disk far away from the direct sunlight and high temperature place.
Please don't put the label, write, paint on the disk surface, or use chemicals on the disk.
Please use soft dry cloth to clean the disk from the centre to outside. the DVD player is likely to be internal components moisture if the car using central heating. The dew may cause DVD player can not work properly. So please stop the unit about 1 hour to make the unit clean and dry, if you find the fault like that. And clean the moisture on the disk with soft cloth.

The DVD may be disrupted if the car running on a bumpy road.
DVD disk
Regarding some disks, maybe can not use the some special function. Maybe can not play some disks.
DVD digital multi-functional disk (also known as "Digital Versatile Disc" or "Digital Video Disc") is a popular optical disc storage media format. Its main uses are video and data storage. Most DVDs are of the same dimensions as compact discs (CDs) but store more than six times as much data.
DVD Menu
DVD can show couple of titles, the title menu. Besides, DVD title menu can make some kinds of items shown, the sub-menu came out during

Basic Operation

the playing, the Dolby Digital and PCM audio, caption, language changed according to the software.

While the unit plays DVD-R/DVD-RW disks, it only plays video format (under video mode), not play the PC files. DVD-R/DVD-RW disks recorded may not play properly due to the property of disk, scratches or dirt on disks or dew on the lens of unit. Disk recorded on personal PC maybe not worked properly, it depends on the setup and environment of the application format, therefore please use a proper format of recording.

CD-R/CD-RW Disk

The DVD player only plays completed CD-R/CD-RW Disk.

CD disks recorded on personal PC recorded may not play properly due to the property of disk, scratches or dirt on disks or dew on the lens of unit. Disk recorded on personal PC maybe not worked properly, it depends on the setup and environment of the application format, therefore please use a proper format of recording.

CD-R/CD-RW maybe not worked properly under direct sunlight or being in high temperature storage place in the car.

The DVD player can not worked properly with Recorded CD-R/CD-RW Disk's title and information data. (under Audio data CD-DA)

You will wait a little long time for CD-RW Disk comparing to traditional CD or CD-R.

Please look at the notice before using CD-R/CD-RW.

Files are compatible with Id3 label Version 1.0 and Version 1.1 formats to show special editions (headers of disks), Track (Track headers) and authors (Track performers).

Only when MP3 files at the frequencies of 32, 44.1 and 48KHZ are played can enhancement function be effective (16, 22.05, 24, 32, 44.1, 48KHZ can be playable). The acoustics of MP3 files can usually be improved after the increase in bit rates. This player is able to play recorded voice at the playing bit rates of 8KBPS to 320KBPS. In order for

.6.

you to enjoy considerable acoustics, we recommend that you use the disks recorded at 128KBPS or higher.

MP3 Files (CD-ROM)

MP3 is a kind of audio compact method, which should be brought into Audio level 3 in the MPEG standard. The audio compact method has already been in the depth of personal computers as a standard mode. MP3 can compact original audio data to 10% of its initial size and to keep the voice in high quality. This means that about 10 Track CDs can be recorded on a CD-R disk or CD-RW disk. In this case, there is no need to constantly change CD disks for playing for a long time. This player allows the playing of MP3 files on CD-ROM, CD-R and CD-RW disks as well as the content of any disks compatible with ISO9660 Levels 1 and 2 and ROMEO and JOLIEY file system.

It can play the disks recorded compatible in multiple sections. MP3 files are incompatible with the transmission of data written in groups. The maximum number of characters that can be displayed as names of files is 32 characters (calculated from the first character). The maximum number that can be displayed as the name of a folder is 32 characters. If a file is recorded in the ROMEO and JOLIET file system, it can display 32 characters only. When a disk with MP3 files and audio data (CD-DA), for example, CD-EXTRA and MIXED-MODE CD, they can switch between MPEG and CD-DA to play these two types of discs. The selection sequence of playing and other folders being operated will become the writing order used by writing software. Therefore, the sequence expected by the playing time can not be in conflict with the actual playing. However, some software permits the setup of playing sequence. Important

When one MP3 file is named, please add the corresponding file extension name (MP3). This player will play the files with the extension name (.MP3) as MP3 files. To prevent noise and failure, please do not use such an extension name for non MP3 files.

Fast Guide for Buttons on Main Unit

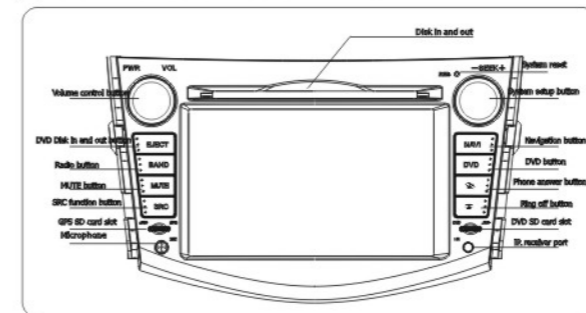

[Volume control button]

Turn the button to right to increase the volume and turn left to decrease the volume from 0-40, long press to turn on or turn off the machine.

[DVD Disk in and out button]

The player will automatically login DVD mode when you insert the disk, and automatically reject the disk if you press this button, when the player is on.

[Band Radio Button]

Press BAND to start the player and directly login radio mode when the player is off. Press BAND to login radio or switch FM1, FM2, FM3 and AM when the player is on.

[MUTE Button]

Press to switch from mute to non-mute.

[SRC Function Button]

Press this button to turn on the player and login SRC menu when the player is off. Press to switch over DVD, V-CDC, USB, Card, TV, Radio, Bl-

.7.

Basic Operation

uetooth, Ipod, AUX, GPS, Turn off, Key sound, Key color, Day-Night Mode, Set-up and Exit when the player is on. Press for 3 seconds to turn off the player.

[IR Receiver Port]

Do not shelter this window to avoid failure operation of the remote.

[System Setup Button]

Press this button to login system setup mode, repeating press to login Audio-Setup, Video-Setup, Usual-Setup, Touch emendation, Information, Next page, Last page, DVD logo, Test setup, Function setup, System setup and Steering wheel control setup.

[Navigation Button]

Press NAVI to turn on the player and directly login GPS mode when the player is off. Press NAVI to login GPS mode when the player is on. Press NAVI to exit the navigation function and back to the interface before when you are in the interface of navigation. Long press NAVI to setup from Normal to Multi.

[DVD Button]

Press DVD to turn on the player and directly login DVD mode when the player is off. Press DVD to login DVD menu when player is on.

[Reviver Button]

Press this button to receive the coming call under the Bluetooth function.

[Hang Up Button]

Press this button to finish the calling under the Bluetooth interface.

[System Reset Button]

Press this button return to factory setup.

[Power Button]

Long press this button to turn on the player when the player is off; Long press this button to turn off the player when the player is on.

[Display Angle decrease Button]

Press this button decrease the display angle. (This button is of no effect with the fixed panel model.)

Basic Operation

[Display Angle Increase Button]

Press this button increase the display angle.(This button is of no effect with the fixed panel model)

[Lcd Panel In and out Button]

Press this button to control the LCD panel shrink.(This button just effect with the one din model)

Description of Buttons on Remote Control

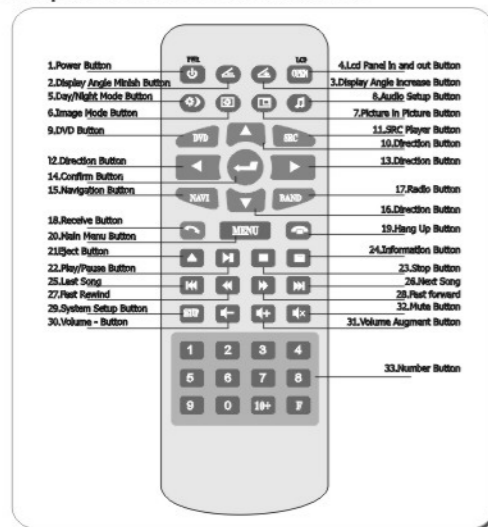

- [Power Button] Press this button to turn on the player when the player is off; press this button to turn off the player when the player is on.
- [Display Angle Minish Button] This button is of no effect with the fixed

panel model.

- [Display Angle Increase Button] (This button is of no effect with the fixed panel model).
- [Lcd Panel In and out Button] This button just effect with the one din model).
- [Day/Night Mode Button] Short press to switch the Day Mode and the Night Mode.
- [Image Mode Button] Short press this button for different image mode setup, brightness, contrast, hue from 0-40.
- [Picture in Picture Button] Short press to display picture in picture function interface.
- [Audio Setup Button] Short press for individuated Audio setup.
- [DVD Button] Short press to login DVD player.
- [Direction Button] Up
- [SRC Player Button] Press this button for the main menu.
- [Direction Button] To left
- [Direction Button] To right
- [Confirm Button]
- [Navigation Button] Short press enter the interface of GPS ;long press exit GPS.
- [Direction Button] Down
- [Radio Button] Short press enter the radio function. short press consecutive to switch FM1, FM2, FM3 and AM.
- [Receive Button] In the interface of Bluetooth, after match with the mobile phone, press this button to receive coming call.
- [Hang Up Button] In the interface of Bluetooth, after match with the mobile phone, press this button to finish the calling.
- [Main Menu Button] This menu is the second grade menu, touch this button to pause when it's playing and enter the interface for choosing the segment, it lists all the content of the disk, you can choose the segment that you want by yourself.
- [Eject Button] The disk come out after press this button.

- [Play/Pause Button] Put the disk in and press it then start to play, and press the key again to stop playing.
- [Stop Button] Press this button to stop playing.
- [Information Button] Short press this button to display the information like the title and sequence number of segment about the playing program.
- [Last Song] Short press one time for repeat playing the current song ,short press twice return to last song.
- [Next Song] Short press to play next song.
- [Fast Rewind] Short press for fast rewind playing.
- [Fast forward] Short press for fast forward playing.
- [System Setup Button] Short press to enter the system setup.
- [Volume - Button] Short press to decrease the volume.
- [Volume Augment Button] Short press to augment the volume.
- [Mute Button] Short press for switch Mute and non-mute.
- [Number Button] Number from 0-10.

Operation for Turn on and Turn off the player

Short press the SRC button on front panel of the player or the remote control when the player is off state; Long press the button of SRC to turn off the player when the player is on .

The Main Menu

When the player is power on, short press the button of SRC on panel or on remote control to enter the main menu, same as follow:



.9.

Basic Operation

There are 17 function buttons on the main menu, same as follow:

- [DVD] Using high-definition color digital panel, with high resolution 800 x480, it's performed very well both in color saturation, color and color revert, and in response, and the color is more high fidelity when in video and GPS navigation .The unit can play the disk of DVD/VCD/CD/MP3/MPEG/CD-R/WMA/JPEG format.
- [V-CDC] Access the disk music file to the memorizer of the unit through the DVD player ,the capability of the memorizer can keep playing for 7.5 hours, that nearly same as the time as playing six ordinary disks.
- [USB] After connect with USB equipment, touch the USB icon to play the file, can play WMV/AVI/MPEG/MP3/MP4/JPEG format of file.
- [Card] After insert the SD card , touch the SD icon to play the file ,can play WMV/AVI/MPEG/MP3/MP4/JPEG format of file.
- [TV] Touch the icon enter the TV function with the TV signal, can support the CMMB, DVB-T, DMB-TH.
- [Radio] Touch the icon enter the radio function , more sensitive digital frequency with stronger and more steady signal , can storage 32 station of AM/FM.
- [Bluetooth] DVD unit supply Bluetooth for hand free call function, if your mobile phone with Bluetooth function, it can connect to DVD unit realize hands free call.
- [IPOD] Connect with IPOD player, touch IPOD icon enter the IPOD function.
- [AUX] It is effective when there is external video input.
- [GPS] Touch the GPS icon enter the GPS function.
- Setup Button: User can setup the Video ,Audio, Time etc...
- Exit Button: Exit from the main menu. Turn off Button.
- Key-Sound button : Press this button to open / close the Key-Sound.
- Key-Color Button: Press this button to change the color of the key.
- Day-Night Mode Button : Press this button to adjust the brightness of the screen , the unit acquiescence the mode is Day mode, the scr-

Basic Operation

Screen is more bright, press this button change to the Night mode, the screen is more dark.

Switch for Spectrum

DVD Basic Operation

After insert the disk, the interface change to DVD automatically, on other interface, press DVD button on faceplate or the icon on the main menu to enter the DVD function; touch the blank area of the screen will appear upper and nether menu as below:



Annotation for every button as below:

- Touch this button enter to the main menu;
- Touch one time to open PIP function, touch again to close PIP function.
- Touch this button to set the output of back area monitor.
- Touch this button exit the interface of DVD setup

.10.

Adjust the volume and mute.

This menu is the second grade menu, touch this button to pause when it's playing and enter the interface for choosing the segment, it lists all the content of the disk, you can choose the segment that you want by yourself.

Touch to play the last song or segment.

Touch to play the next song or segment.

Touch this button to stop playing DVD.

When the unit with disk, touch this button to playing, and touch this button to pause or stop playing; at the state of pause and stop, touch this button to continue playing.

Touch this button to enter the DVD setup.

press this button back to DVD setting menu.

Reject button: press this button to reject the disk in the unit.

Press this button to show current playing title and serial number of program.

press this button to play backward.

press this button to play forward.

When the unit reading the multi-language disk, press this button to switch the word title.

Press this button to show current playing title and serial number of program

When the unit reading the multitrack disk, press this button to switch the track.

Press this button to repeat under playing mode.

Press this button to pick the picture to be unit starting logo when the unit reading the picture.

Playback control, that is, interactive features and high-precision still images two functions. Through the menu screen displayed on the realization of human-computer dialogue, free from the menu screen out static or animated images, but also out and retrieve

quickly to make a more user-friendly;

DVD system setting button, login DVD setting menu.

Press this button to show/turn off the underlined cursor key button.

Press this button to move up, down, left and right to choose segment and songs, press button to confirm, start to play chose segment;

Press this button to show/shut digital board keyboard.

Press digital keyboard to choose song to play under DVD mode.

DVD system setting

Under dvd setting menu, press to login DVD setting menu, there are 4 kinds of DVD setting: normal setting loudspeaker setting, default setting, password setting, detail as followi ng:

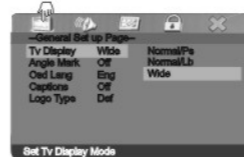

Set Tv Display Mode



Set Angle Mark

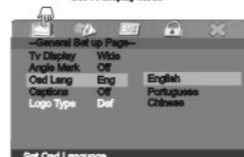

Set Osd Language

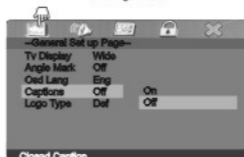

Closed Caption

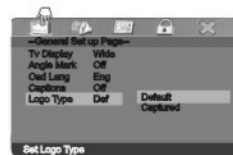

Set Logo Type



Set Downmix Mode



Preferred Audio Language

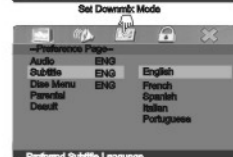

Preferred Subtitle Language

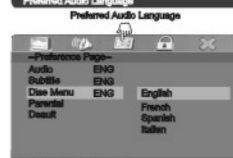

Preferred Menu Language

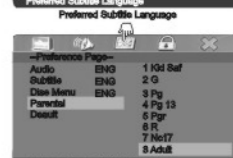

Preferred Parental Control



Load Factory Setting

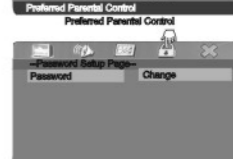

Change Password

(The default setting will be work without disk, there maybe some difference of DVD setting with different unit, therefore please process according to real unit.)

.11.

Basic Operation

Basic Operation

Virtual CD driver setting

Under main menu, press this button to login virtual cd driver as following picture. Please check the function of button as following:



1 2 3 4 5 virtual disk icon Real disk icon

Favorite Mute, switch from mute to non-mute

voice adjust Backward Forward Previous

Next random playing cycle playing play/ stop

Delete normal compress rapid compress

Setting:

1. Inject the CD disk under virtual CD driver. The system will change to virtual CD driver menu;
2. Copy the CD file to virtual CD driver, please use normal compress or rapid compress;
3. When the virtual CD playing, the file can be played or deleted by control button;
4. If the virtual CD driver can not compress by reason of song compressing problem, please login preference page of setup menu to press 1"8"6"0, then login USB format menu. There are tips during and after formatting

.12.

USB setting

The file to play in the USB, insert the USB equipment to the USB slot correctly, the unit login USB menu automatically, playing menu as following, touch USB blank menu to show button.



It's same function and setting as DVD menu. The unit support hot-plugging.

Picture capture to be DVD starting logo function

The function workable only connecting to USB and SD, reading picture or mp4. The picture format is JPG, resolution from 720*500 to 1M.

1. When you see your favorite picture or mp4, press stop, then the picture stop as following picture



2. Press next page, login setting menu 2, as following picture.



3. press, then press enter into the DVD menu interface, it shows as the following:



Touch the opening menu, this menu will appear a sub-menu, choose user image and close the DVD menu settings (touch X).
4. Touch, captured function will be paused by the system.



When wait capture logo..... disappear, the current capture picture is successful finished.

.13.

Basic Operation

SD setting

The file to play in the SD, insert the SD card to the SD slot correctly, the unit login SD menu automatically, playing menu as following, touch SD blank menu to show button. It's same function and setting as USB function. the unit support hot-plugging.

TV setting

You can choose analog TV or DVB-T in your unit.

Analog TV setting

Touch TV icon in main menu login TV mode, the menu as following:



Button function and setting as following:

Volume adjust and mute switch.

Setting button, press this button login setting menu, to set the image system companion system, setting as following:



Image system: press left/right to choose your own TV system, the image are: AL/NTSC/SECAM/PAL-M/PAL-N.

Basic Operation

Companion system : press to choose your own companion system, companion are : BG/DK/M/N. there are different companion system relevant to its image system.

Image system: NTSC/PAL-M ; companion system is M.

Image system: SECAM companion system is BG/DK

Image system: PAL-N companion system is N

Button to previous channel.

button to next channel

frequency button, press this button to show keyboard, with it to input frequency.

Search button, press this button starting to search TV channel, the menu as following picture:



.14.



The unit will store searched channel, as most as 100 channel. The unit stop search if touch the panel, the unit show No.1 channel after it's ready. The unit can store 100channel mostly, if the receiving effect is not good, please check if the tv antenna have been connected well. As the low signal or drive fast, the tv receiving effect is not well, it's normal, not the unit problem.

Channel button, press this button to show channel keyboard, input the channel number to watch your love channel.

DVB-T (optional)

Touch TV icon in main menu login TV mode, the menu as following:



Button function and setting:

Up, down, left , right button; confirm button.

Volume adjust and mute switch.

Multi-functional color button: press corresponding button according to the screen shows to act function.

DVB-T.program channel directory, press this button to show

program's channel. Time and date, also can show the booking program.

Press this button to show keyboard , press keyboard to choose channel.

Back, back to previous program.

Favorite, login or quit your favorite channel program list, switch by channel +/-.

Channel info button, login or quit info of DVB-T program.

Menu button, login or quit menu setting.

Info button, view program information.

Quit button, quit current setting, back to previous setting.

Channel search button

The screen shows No Channel as following, when first time login DVB-T



Please set the search mode and country system first. Press menu button login menu setting. The screen shows four icons, installation, system, channel list, preferences. Press to choose icon, the chosen icon become big and light as following picture.



Choose the installation icon to confirm , then login installation menu, it offers two way search : search automatically and search by hand.

.15.

Basic Operation

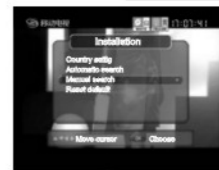

Press or button to login next menu, press button back to main menu, press button quit menu, press or button more up and down to choose menu, then press to confirm.

Country and area

Please choose the country or area by installation menu. The default is England,. After login installation menu, press or button to show country and area list, press button to choose your country.



Search automatically

Press or button to choose auto search function, then press button login auto search menu to search automatically, it takes some minutes to search the channel.



Basic Operation

The gauge bar shows the rate of process during the auto search. Press button **[STOP]** to stop; press **[OK]** or **[EXIT]** button to save and quit menu. If search complete, but without stored information, please press button **[EXIT]** to quit, and then reset the parameter to search again. It shows the stored program at left side after search end, then save and quit menu. Search by hand.

Press **[OK]** or **[EXIT]** button to set search by hand, press **[OK]** button to login search menu, press **[OK]** or **[EXIT]** button to choose channel or frequency, press **[OK]** button to login press **[OK]** or **[EXIT]** button to change searched channel and **[OK]** confirm; press **[OK]** or **[EXIT]** button to choose search button, then press **[OK]** button to start searching, check as following picture.



Press **[OK]** button to save the program stored after search.

Notice:

Please wait till the search end, if stop the search, please press **[STOP]** button. If the search stop and complete, the unit would save and playing the program searched; if your love channel not exist after the search complete, please re-search according to your new search criteria; or you can enjoy the DVB-T, during the install the guide, press **[OK]** button to save input information, then press **[EXIT]** quit the installation. If you quit the installation before installation complete, it may lead to problem with program watching. Please set your receiver by installation menu. Default setting

Under installation, press **[OK]** or **[EXIT]** button to choose default setting, then press **[OK]** to confirm. Press **[OK]** or **[EXIT]** button to choose ok or cancel, press **[OK]** button to confirm, press ok to default setting, press cancel to cancel

current setting. Check as following picture:

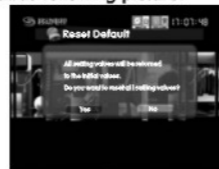

Back to default menu setup, get back the receiver setup to the factory setup, please pay attention that when you reset the default, all the information will be deleted, such as channel, menu, configure and so on. Scan shortcuts

On the first time you press scan shortcut key enter in language selection menu, press **[OK]** or **[EXIT]** key and **[OK]** key to select the menu language. As following picture:



On the second time you press scan shortcut key and enter in area selection, press **[OK]** or **[EXIT]** key and **[OK]** key to confirm the searching area; on the third time press scan shortcut key will appear renew default menu, select **[OK]** key or **[EXIT]** key enter in auto scan menu and start to search the channels. The future operation is same as above.

Basic operation

The basic operation analyze the switch channel, voice control, program viewing basic characters.

channel switch

.16. press **[OK]** or **[EXIT]** key to switch to next channel, press **[EXIT]** key to open

the digital keyboard, switch to favorite channel directly through this keyboard, or you can switch channels by program guidance, for the locked channel, there is an interface with black background for pass code, once you enter the pass code (default pass code 0000), you can watch this channel program as normal.

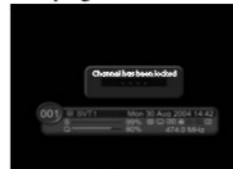

Program reports

when you are going to watch the program information, press **[INFO]** key, press **[EXIT]** key to hide the information menu. Information menu will show the current channel no., name, time, and signal strength and quality of signal and current frequency, you can read the details latest program reports, press **[INFO]** key to display the current channel details information, as following picture show to you:

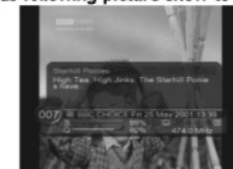

E-program guides

The guidance display the channels for each program, date, time, as following picture show to you:

Basic Operation



Note: press **[EXIT]** key enter in program guides menu interface, press **[EXIT]** key to exit e-program guides menu, some local program suppliers are not going to support this kind of service, that may cause the menu is unavailable.

Program information guidance

You can see all the programs information through the program guidance, press **[INFO]** key enter in program guidance information window, press **[EXIT]** key to switch channel, date, program window, and press **[OK]** or **[EXIT]** key in the program window to choose next or last program information. In the channel window, press **[OK]** or **[EXIT]** key to move to another channel, select your favorite program and press **[OK]** to confirm and you can watch the selected program as usual. Press **[INFO]** key to watch the current program details information.

E-TXT TV

E-TXT TV program guidance display the channels, date, time and information on the program. Note: press **[INFO]** key enter in and display the TXT menu, press **[EXIT]** or **[EXIT]** key exit TXT TV information, if the current supplier do not support the TXT TV, press **[EXIT]** to show no available information, press **[INFO]** key again to hide this information, press **[OK]** or **[EXIT]** key to go to next page, as the following picture:

.17.

Basic Operation



Parameter setup

Note: you can operate child-locked control/ menu language/ AV control methods/ other setup. The system default menu language is English, press **ENTER** key enter in main menu, press **DOWN** key to select preferences menu, press **RIGHT** key enter in preferences menu.

Language setup

press **UP** or **DOWN** key to set the language setting, as following picture show to you:



Press **ENTER** key or **RIGHT** key to display the language list.



Press **DOWN** key to select the language you want, press **ENTER** key to save and exit.

Enter in preferences menu, press **UP** or **DOWN** key, to select AV control, press **ENTER** key to display the optional item, press **UP** or **DOWN** key to change video output system/ format/ comparison, press **ENTER** key to confirm, press **ENTER** key to exit, as following picture show to you:



Other setup

Enter preferences menu, press **UP** or **DOWN** button to select other setup menu, and then press **ENTER** button to display the selection, press **UP** or **DOWN** button to setup OSD time, color and menu transparency, press **ENTER** key to confirm the amendment. Press **ENTER** key to exit, as the following picture display:



Parental control

Enter parameter preferences menu, press **UP** or **DOWN** key to select Parental control, and then press **ENTER** key to display the password, default password is 0000 or **UP** **UP** **UP** **UP**, same as the following picture:



.18.

Basic Operation

After you enter the password and screen will come to next setup page, same as following picture, you can change the setup view level or change the password on the setup page.



system setup

You can check the system situation and signal situation, press **ENTER** key enter in main menu interface, press **DOWN** key to select the system parameter, press **RIGHT** key to enter in the menu, refer to the following picture:



To show the system status

system parameter menu, press **LEFT** or **RIGHT** key to select the system menu, press **ENTER** key enter in system menu, press **LEFT** or **RIGHT** key to select system parameter menu, **ENTER** key confirm the operation, the screen will display the current system status, refer to the following picture:



To show signal status

In the system menu, press **LEFT** or **RIGHT** key to select signal status menu, press **ENTER** key enter in signal status display menu, the first line display the status of the signal strength, the second line display the status of signal quality, as the following picture:



Channel list

Channel list menu can edit channel and set your favorite channel, select channel list icon, press **ENTER** key and enter the password according to the instruction in the menu (default password is 0000 or **UP** **UP** **UP** **UP**) and then enter channel list menu, as following picture display:



Edit the channel

Enter in the channel list menu, press **UP** or **DOWN** key to select edit channel menu, press **ENTER** key to the interface, as following picture show you:



.19.

Basic Operation

Red key is lock/unlock, green key is for unlock, yellow key is delete, blue key is edit, set the function according to those colorful keys in the interface.

Edit favorite channel list

Enter in channel list menu, press or key to select your favorite channel menu, press key enter in setup interface:



And then you can edit your favorite channel list, press or key to select the channel, press red key to add channels to the favorite list, press green key to make an order for the channel, blue key assist or key to move the TV program, press or key to select TV program list or favorite list, press key to exit.

The favorite channel list operation

When you already add some channel to the favorite channel list, exit the menu status, press key, press or key to switch the TV program or favorite channel list, between them, press or key to switch.



.20.

Radio function operation

Touch main menu radio icon, or press remote or the BAND key in the faceplate, enter in radio menu, listen AM/FM1/FM2 TV program, radio menu is shown as following picture:



Functions and operation instruction for each key:

- Band selection key, press this key, the band can be switch between AM/FM1/FM2/FM3.
- Scan key: press this key to search the channels automatically, and be saved after scan.
- Spectrum key, press this key to enter in Spectrum menu.



Strip spectrum display



- Punctuate spectrum display
- Mute key, press this key to switch to mute or non-mute.

Volume bar, touch this volume bar left side to decrease the volume, touch the right side to increase the volume, or to control the volume from the remote control or main menu.

RDS function, RDS is available only on Europe countries. AF key, instead of the frequency table, AF table send each transmitter information of the same program to same area or near by, the receiver saved the table information and shorten the searching time, this is very useful for the receiving the removal signal. TA key, the distinguish of traffic notice, to show if the traffic notice is sending or not, and the receiver switch the traffic notice on the TV program automatically, when the traffic notice finish playing, the TV program will back to the status as before. PTY key, program type, is a code for program type, transmit with each program, and to show which type the current program is among the 31 types program, Receiver receive and record this similar type program according to this code.

Limited adjusted key, half-auto search from high frequency or low frequency.

search the channel from up and down.

Touch the channel middle area of this circle, the digital channel menu will appear, as following picture



.21.

Basic Operation



- Exit key, press this key exit the digital channel menu interface.
- Delete key, delete the digital entered.
- Confirm key, enter the digital channel, press this key to confirm the information, digital key is from 0 to 9.

Attention: when it is in scan channel automatically, press any key to stop the scan. This unit can be saved for 32 channels.

Bluetooth function operation

This system offer Bluetooth communication function, if your mobile is with Bluetooth function, it can be connected with DVD and answer the phone by Bluetooth, touch the Bluetooth icon in the main menu to enter Bluetooth interface, as the following picture show to you. the operation and function information for each key is as follow:



Bluetooth setup

First of all confirm your Bluetooth function is available, touch the icon in the Bluetooth main menu, display Bluetooth setup interface as the up-right side picture:

Basic Operation



Press this key to connect the signal with mobile phone, the information frame in the interface will display the pairing code: 0000, when system and mobile signal was connected, the mobile will show connect to device mobile select YES and enter the pass code 0000.

Press this key to exit the pairing.

Press this key, the system will connect with mobile automatically.

Press this key, the system will start connect with mobile.

Press this key, the system will disconnect with mobile.

Press this key, when there is calling, the system will answer the phone automatically.

Calling

After it is successful connection between system and mobile. You can dial the no. through mobile or press key back to Bluetooth main menu, dial the no. with this digital keyboard in the menu, and then press key, after the phone is connected successfully, the system will switch the mobile audio to our DVD audio system, you can hear the calling voice through the speaker in the car.

Answer the phone

When there is calling, no matter what mode you are operating, the current mode will change to Bluetooth menu automatically. And change to voice to calling rings, in the same time, the information frame will show calling no. and you can press key or key to answer or hang off. Touch digital keyboard area key can switch the

.22.

calling voice from car DVD to mobile.

Hang off

Press key to finish the conversation, exit Bluetooth interface and back to the status before switch.

Press key can switch between mute or non-mute, press volume bar, left side is to decrease the volume, right side is to increase the volume.

press key to switch to spectrum diagram interface.

Review communication record

press key, to switch to communication record interface, as following picture display, can review the called no., answered no., non-answer telephone no., and phone book.



Bluetooth playback

press key, to switch to Bluetooth audio playback interface, the condition is that there is A2DP function in the mobile, the interface as following picture:



- ◀ Last track button.
- ▶ Next track button.
- ⏸ Playing/pause key.
- ⏹ stop key.
- ⏪ Bluetooth system volume + key.
- ⏩ Bluetooth system volume - key.

IPOD function

Connect the IPOD from the IPOD port in the unit, touch the main menu IPOD icon, the system will enter in IPOD menu 1, select the songs and enter in IPOD menu 2, as following picture:



IPOD menu 1



IPOD menu 2

.23.

Basic Operation

key function as following:

- ⏮ press it one time or twice to repeat play the current tracks or segment, press twice continuous this button to play last track or segment.
- ⏭ press this key to play next track or segment.
- ⏪ Back control.
- ⏩ Forward control.
- ⏸ press this key start playing, and press key to pause playing when it is in playing mode.
- ⏮ Press this key to back play list menu.
- ⏭ Random playing.
- ⏮ Cycle playing.

AUX IN

When connect outside audio/video signal source, click aux in icon, enter in outside video interface.



AUX function can display and monitor outside audio/video signal, but could not control the outside signal. When there is no video signal in, click aux in icon and will be show the signal connection information.

GPS function operation (Optional)

This function is available on when the GPS chipset installed inside. Touch the main menu interface NAVI icon, or touch NAVI key or press NAVI button, the system will be enter into GPS mode.

The notice before navigation operation

First please confirm the correct connection of satellite antenna. On one period after you turn on the radio, the satellite antenna will receive satellite signal, update the inside messages and works as normal after

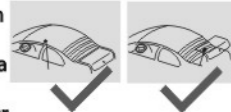

Basic Operation

few minutes. Please make sure all the vehicle position is not under bridge or on the tunnel or near high building so that affect the receiving of signal. Drivers should finish the DVD setting in advance, or should messengers handle the operation of DVD. Save operation is the important thing to guarantee drivers, messengers and other people on safety. This product is easily to be operated through the touch screen, touch key or remote control, the details operation method is decided by the media entertainment host.

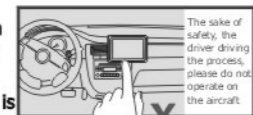
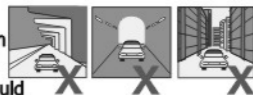

MAP
Because of the fast developing of city or country traffic roads construction, the traffic management information of city streets and traffic establishment changes very often, The GPS

Software Company will keep updating the e-maps, please check the update information from GPS Software Company in time. The guiding routes may be different with the live traffic control status because of the traffic rules changes or temporary traffic control. Please drive according to the actual roads status, traffic controls and rules.

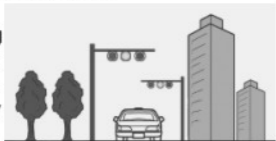

Navigation

Due to the some changes happen on the real time roads traffic sometimes, the navigation routes the system guided only for driver's reference. For example: when driver is familiar with the area, it is better that driver choose the routes he's familiar instead



of the routes navigation system offered.

TEMPERATURE

The normal working temperature range is from -10°C to +55°C, if the temperature is over to this range, the radio could not work as normal. Please try to get the temperature back to normal working range, so that the radio can work as normal

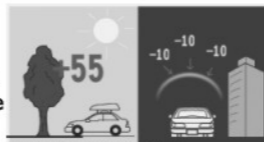

ANTI-SHOCK

This products was designed to be anti-shock, when you drives as usual the radio was not affected by the shaking of the car, to make sure the products in use for a long time as normal, do not turn on the radio when you drives in bad roads situation.



SATELLITE SIGNAL RECEIVING

This system can always receive at least 8 satellite signals. usually, if only receive 3 or 4 satellite signals, the navigation system can calculate the correct position of vehicle. But sometimes when you meet some bad weather or the vehicle parking in the high building. This situation will affect the signal receiving result.

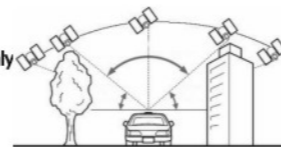

ABOUT ERROR

when the system receive satellite signal as normal, the standard satellite orientation system wrap is about 7 miles, when vehicle drives in the parallel roads, there is still error although the navigation system amend the error automatically. even it will show the vehicle position is not in the right road but on the other parallel road nearby.

☐ Main Function

A. GPS Navigation function: Provide SD card with GPS software by users.

B. Music Media player: Support mp3/wma/wav.

C. Video player: Support more than 19 kinds of format like mp4/mpeg/mpg/asf/wmv/mov/avi/3gp/3g2/k3g/m4v/mqv/wm/divx/mkv/ogm/vwx/mlv/mpv, support appending and deleting files, adjust the rate of progress, time display, pause, full-screen display.

D. Digital book: Text read for TXT format. User can enter the page No. to choose the page freely.

E. Picture browse: Support the format like bmp, jpg, gif, png for picture browse. Support picture blowup, dwindle and lantern slide display.

F. Setup: Including GPS Navigation set, GPS monitor set, common use set, emendation for touch screen and system set. Basal setting is for language, time, skin, switch effect, volume and keystroke tone.

2. Touch Screen

A. Click one time: Click the screen one time.

B. Click two times: Click the screen two times fast.

C. Drag: Clicked and then drag.

Notice: Any acuity and crude object shall scrape the touch screen.

3. SD Card Memory Card

It is with SD card slot in machine, you can put GPS navigation software, Multi-Media file in SD card.

A. Please confirming the right location of SD card slot when you insert in the SD card. SD card is in card slot exact after you heard a tick sound.

B. After you pushed the card lightly then the card will pop-up automatically when you want take out the SD card.

C. Please keep the machine power off when you insert in and take out the SD card.

D. Don't take out the SD card when using, it will make the data foul-up.

☐ Operation Instruction

1. Emendation for Touch Screen

Press NAVI on the panel, or touch GPS icon on main menu, or press GPS on the remote control. Show as follows:

Basic Operation



Touch icon , enter into the following menu



Click the icon of , enter the interface of touch screen emendation, according the hint from the screen to long press the center of the cursor till the cursor move to the top left corner, and then emendate the cursor in below left position, below right position, top right position take turns. It will enter the emendation interface automatic if the emendation was failing; it will show OK on screen if the emendation was succeeded. Click anywhere of the screen to save and exit the emendation. The system will memorize the result of the emendation after the emendation finished even power off, no need emendate the screen every time when turn on the machine, it is emendated before shipment.

2. GPS Navigation Setup

A. Instruction of Gps Navigation software setting

Insert the SD card with navigation software

Operate on this interface as below after the system on

.25.

.24.

Basic Operation



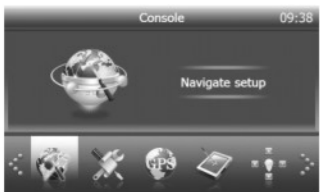

Touch icon , enter into the following menu :



Touch icon , enter into the following menu :



Touch icon , select procedure, Touch icon , or click the file name twice, Customer can select start whether run navigation software automatically, System can run the GPS software when the GPS startup. Finish the setup of the path, touch , exit, and back to the main menu.

.26.

B. Function Navigation software

Please touch , enter the following menu:



Touch icon , enter to GPS Monitor, reference the following photo

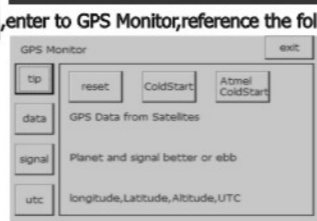

Notice: Operation method of Navigation software please reference the instruction of Navigation software.

3. Music player

See the following menu



Touch icon , enter to Music player menu, reference the following photo.



Touch icon , select the music file storage path, then enter to the following menu



A. Select one music file

Select one music file for playing, Touch icon , for one time, or touch file name twice, then return to music list, see the following photo:

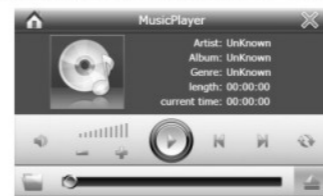

















Touch icon , start play the music file, reference the following photo

.27.

Basic Operation



B. Check all music files

Touch icon , for one time, Touch icon , for one time, turn to music playing menu. Touch icon  to append more music files.  Means start playing.  Means pause.  Means next one,  means last one. Touch  to increase the volume. Touch  to minish the volume.  Means voice normal.  Means mute. Touch  to delete files. Touch  go to last page, touch  go to next page. Touch  turn to Main menu. the content of the current page will be save automatically. Touch  to exit music playing menu.

4. Video player

the operation of player as the same as the music player.



5. Electric Book

Under the control menu, reference the following photo:



Basic Operation





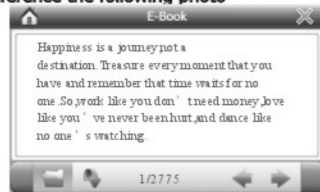

Touch icon , choose the path for the file storage, Select the file for play. Touch  for one time, or click the file name twice, enter into the Electric book, reference the following photo



Click , customer can input datas, means you can input the pages you want to read, reference the following photo:



Click the number on the screen.
Click  delete the datas you have input.  is backspace key. Click  return to the main menu of electric book.  Means next page, .28.

 Mean last page. Click  return to the main menu, the content of current page can save automatic.  Mean exit.

6. Picture

Under the control menu, reference the following photo













Click icon , enter into the pictures browser.



Click icon , choose the path of the files storage, reference the following photo:





Click  for one time, or touch the file name twice, the file will show on the screen.  means blowup the picture,  means reduce the picture.  means circumscribe the picture 360 degrees.  To last picture.  To next picture.  Means the pictures playing as lantern slide.  means full screen.  return to the main menu, the content of current page can save automatic.  Means exit.

7. Usual setup

Including setup for language, volume, key-stroke volume, time, skin, switch impact.

Under the control menu, Click , Click , enter the usual setup menu, reference the following photo:



Click  or , change the Navigation language. Include simplified Chinese, complicated Chinese, German, French, Spanish, Dutch, Hungarian, Czechic, Danish, Norwegian, Swedish, Portuguese, Italian, Finnish, Romanian, Russian, Polish, English.

Touch icon  to setup the volume

Basic Operation



 To increase volume,  to decrease,  means mute.

Touch  enter into Key-stroke volume setup menu.



Touch  enter into time setup menu



Touch  enter into switch impact setup menu

Basic Operation



8. Screen setup

At the main menu, Touch ,enter into the following menu



Touch ,enter into the following menu

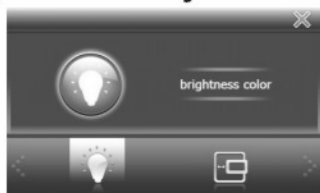

Touch ,enter into brightness /color setup menu, Touch to adjust the position.

9. System setup

At the main menu, Touch icon ,enter into the following menu

.30.



Touch icon ,enter into the system setup menu

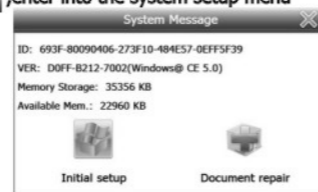

System Settings

Pressing the main interface setting button ,using panel key or remote control MENU, enter the System Setting interface, the interface in the system settings can be set up for audio,video settings,normal used settings,touch correction,information,startup screen,detection settings, feature settings,system settings,steering wheel settings which are personalized 10 settings, the interface is showing below graph:



Audio settings

The effects of sound much more depends on the high sound and hybrid bass. All kinds of music and vocal music programs will be more fair-sounding in the different sound lever combinations of the treble and bass sounds.the use of left and right stereo channels as well as before and after the sound level to maintain an optimal balance is also very important. By the audio settings button, enter the audio settings I nterface as below:



User adjust value of treble,tenor,bass.Setting the system to pop, rock, classical, standard four audio mode, you can choose your favorite mode to adjust the high or low values for personalized settings. Press separately to adjust the speaker balance of voice before and after, left and right. When user press every time, the yellow ball will move toward the corresponding one unit.According to the next page button on the top of interface to enter the audio settings page2. It is as the following diagram. You can adjust the volume of DVD. tv, radio and so on respectively.



Basic Operation

Video settings

Press key enter into the video settings page. The system provides three models such as soft, standard and bright. You can set up brightness, contrast and hue value respectively by the key. video settings interface is as follows:



Normal used settings

Pressing button to enter the normal used interface.Press the buttons for normal used settings. The detailed interface is as follows:



Touch-screen

Press button to enter the touch-screen interface, follow the on-screen prompt to press long cursor position according to the Center until the cursor move to the up-left corner of correction. Following by the lower-left corner, lower right corner, upper right corner of the location respectively. If the correction is not successful it will re-enter the interface automatically. If the correction is successful, display will show "OK", click on any point on the touch screen to save calibration and exit the calibration interface. The system will correct the results of

.31.

Basic Operation

memory after touch screen calibration. When power is down it will not lost the memory. The user do not have to have to calibrate when power is on every time, the factory has a good correction before sending to the customer.



Information

Press button to display information interface. Displaying the voltage and help as follows:



In the System Settings page 1 press key to enter the system page 2, press key in the system setting page 2 to return to page 1.

Start screen

Enter the System Settings page 2, pressing key to enter the start screen setting page as following. The unit provides you with a wide range of standard models of cars for you to choose. According to the vehicle standard images, when the machine start next time, it will display the vehicle image which you ever choose on the screen.

.32.



Detection settings

Enter the detection settings interface used by the key. Setting the normal detection function by key. The interface is as follows:



Feature setting

Press key to enter the feature settings interface. Press key to set the volume of the navigation, camera reference cable, indicating still, speakers and other key functions. The interface is as follows:



System Settings

Press key to enter the system settings interface. Press key to set radio region, language, time correction, as well as set up reduction. The interface is as follows:



Steering wheel setting

Press key to enter the steering wheel interface. You can select your model of the steering wheel control in this interface.



Picture-in-picture feature

With picture-in-picture feature of the system, in radio, bluetooth, DVD, SD and so on interface can achieve the picture-in-picture playback. Here to illustrate radio to the picture-in-picture feature. In the radio interface, press key to return to the main menu selecting interface, press picture-in-picture button will appear picture-in-picture. The interface is as follows:

.33.

Basic Operation



Wherever the user touch Picture-in-picture screen, there will be a picture-in-picture control buttons as follows:



Signal source selection keys, these keys can choose picture-in-picture signal source

Last song / last channel button

Next song / next channel button

Play / Pause button

Click here to close the control keyboard, watching the screen normally. Exit the picture-in-picture interface. Clicked on the "open picture-in-picture" option once again will be ok.

Two zone settings

Press each function interface two zone setting key , entering into the control of back display screen as the following:

Basic Operation



Here can control the back display screen by the connecting of host machine. The back display (which can be accessed by audio) can connect DVD, USB, SD, TV, radio, camera and so on. The content of back display can be different with host displays contents. You can choose the signal source to the back display by keys

Two zone switch, this button can control the back display

Video control keys;

Last song / last channel button

Play / Pause button

Next song / next channel button

Connections

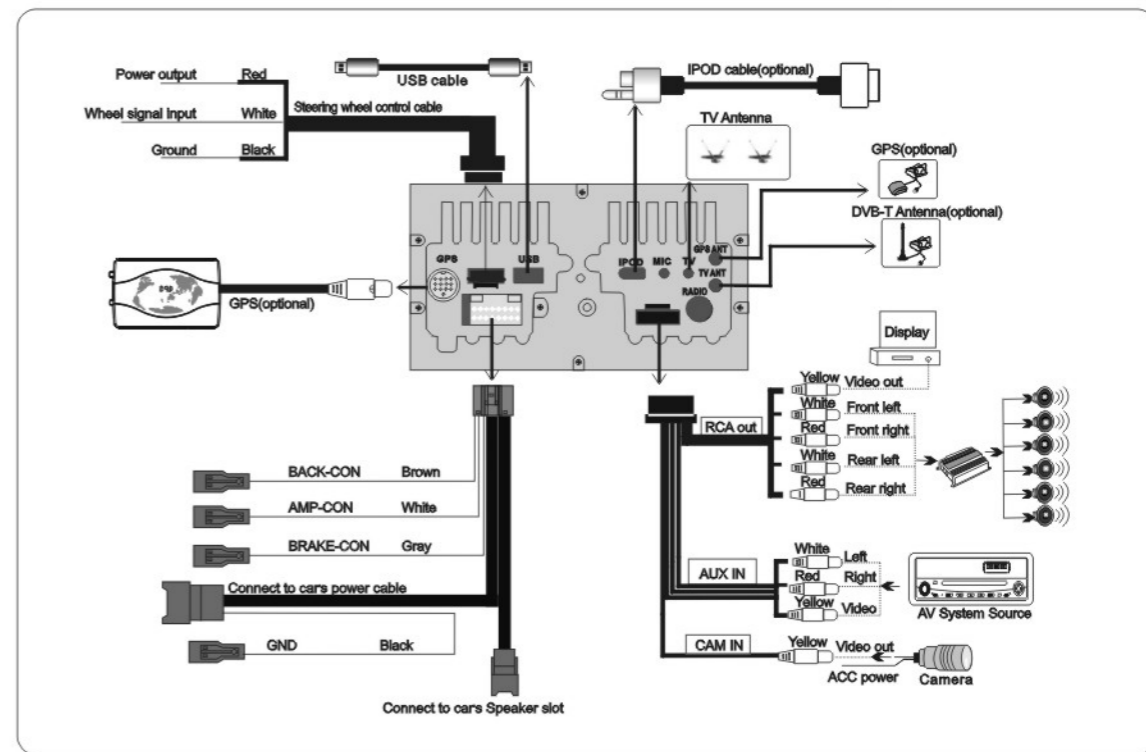

Phenomenon	Cause	Resolution (only for reference)
No power supply	Wrong connection between wires and connector.	Make sure again that all connections are made correctly.
	Broken fuse	Find out the reason behind the breakage of fuse and then replace it with identical new one.
	The built-in microprocessor is unable to work normally due to noise and other factors.	Press RESET to restore to the factory settings.
Failure of Remote Control	Low Battery	Replace with new batteries.
	Certain functions are forbidden under specific modes.	Enter the proper mode.
Unable to Play back Disk	The disk is dirty or incompatible with this player	Clean up the disk and check out the disk type. Insert a compatible disk into the player.
No Audio Output	The cable fails to be connected properly.	Rectify the cable connection.
No Increase in Volume	This player is playing back in slow motion or frame by frame.	It is normal in slow motion or frame by frame playback.
Failure of Specific Speaker	Incorrect audio setup	Configure speakers properly.
Defective Disk	Unable to Play back Disk	Change the disk for another one in good quality.
Parent Lockup Function is enabled.	Parent Lockup Information Displayed and Blocking any Operation	Deactivate the Parent Lockup Function.
Current DVD has no extra languages for selection.	Unable to Change Language (subtitle included)	No other choice if the DVD is recorded in one language.

Symptoms		
	You can only switch it over to the options as shown in the disk menu.	Use the disk menu for switchover.
No Subtitled Displayed	There is no subtitle recorded in the DVD. You can only switch it over to the options as shown in the disk menu.	If there are no subtitles recorded for the disk, then it is unable to show subtitles. Use the disk menu for switchover.
Failed to Play back According to Language in Audio and Subtitle Selected in the DVD Setup Menu Unable to switch over to another Viewing angle.	The current DVD has no audio or subtitle language in the DVD Setup menu. The current DVD has no a multi-viewing angle.	No choice is available in such a case.
Pictures are exceptionally vague/ distorted or dim in the playback.	You try to switch it over to another viewing angle but there are no multi-viewing angles recorded in the disk. The disk is protected by anti-duplication (Some disks may have such a function).	Switch to other viewing angles when the disk is recorded in a multiple-viewing angle. As this player is compatible with the analog anti-duplication system, some horizontal lines or other interference phenomena may pop on the screen when the disk with anti-duplication function is played back in this player. When happened, it has nothing wrong with the player itself.
No Image: PIC OFF is shown. When the Ignition switch is turned to the ON position(or to the ACC position), the player automatically switches on.	You fail to connect the manual brake wires or fail to turn on the manual brake.	Connect the manual brake wire and then turn on the manual brake. This is quite normal.

Product specifications

Product specification

Power:	12V DC (allowable range: 10.8-14.5V)
Grounding system:	Negative pole type

Mainframe :

Maximum consumption of current:	15A
Size (W*H*D):	258*154*180MM
Weight:	3.5kg

Display screen

Size/horizontal-vertical ratio:	6.2inch 7inch/16:9
Pixel:	336,960 (1440*234)
Type:	TFT active matrix
Color system:	Full system
Range of operating temperature:	-20℃ ~ +70℃
Range of storing temperature:	-30℃ ~ +80℃
Angle regulation:	0℃ ~ 50℃

Audio

Maximum output power:	45W*4
Load impedance:	4 Ω (allowable range: 4-8 Ω)
Advance output level/impedance:	4.0V/200 Ω
Encoder:	Linear PCM/Dolby digital/Dolby professional edit II/DTS

DVD player

System:	DVD audio, DVD video, VCD, CD, DTS CD and Mp3 system
Discs available:	DVD audio disk, DVD video disk, VCD, CD, DTS CD
Number of tracks:	2 (stereo), digital 6 tracks
MP3 encoding format:	MPEG-1 and 2 and Audio level 3
FM frequency modulator frequency range:	87.5~108.0 MHZ
Effective sensitivity:	10 DB(S/N: 30 DB)
AM modulator Frequency range:	531~1, 629KHZ(9KHZ)
Effective sensitivity:	30 DB (S/N: 20 DB)

Packing List

No	Name	Qty	Remarks
1	Mainframe	1	
2	Remote control	1	Battery included
3	Accessories Bag	1	
4	Power cord, etc	1	1 set
5	Tool for Mainframe	1	1 set
6	Operation instructions	1	
7	Touch pen	1	

Any possible change in product specification will not be notified particularly.