

HP Photosmart R740 series Digital Camera

English



i n v e n t

Legal and notice information

© Copyright 2007 Hewlett-Packard Development Company, L.P.

The information contained herein is subject to change without notice. The only warranties for HP products and services are set forth in the express warranty statements accompanying such products and services. Nothing herein should be construed as constituting an additional warranty. HP shall not be liable for technical or editorial errors or omissions contained herein.

Windows® is a U.S. registered trademark of Microsoft Corporation.



SD Logo is a trademark of its proprietor.



Disposal of waste equipment by users in private households in the European Union

This symbol on the product or on its packaging indicates that this product must not be disposed of with your other household waste. Instead, it is your responsibility to dispose of your waste equipment by handing it over to a designated collection point for the recycling of waste electrical and electronic equipment. The separate collection and recycling of your waste equipment at the time of disposal will help to conserve natural resources and ensure that it is recycled in a manner that protects human health and the environment. For more information about where you can drop off your waste equipment for recycling, please contact your local city office, your household waste disposal service or the shop where you purchased the product.

For future reference, enter the following information:

- Model number: _____
- Serial number: _____
- Purchase date: _____

Contents

1 Getting started	
Accessing the electronic User Guide.....	4
Camera top, side, and back	6
Camera front and bottom.....	7
2 Setting up your camera	
Charge the battery.....	8
Install the battery.....	8
Turn on the camera.....	9
Choose the language.....	9
Set the region.....	9
Set the date and time.....	9
Install and format an optional memory card.....	10
Install the software.....	11
Windows.....	11
Macintosh.....	12
3 Taking pictures and recording video clips	
Take a picture.....	13
Record a video clip.....	13
4 Reviewing and deleting images and video clips	
Review images and video clips.....	15
Delete an image.....	15
5 Transferring and printing images	
Transfer images.....	16
Print images from the camera.....	16
6 Camera quick reference.....	18

1 Getting started

This printed Quick Start Guide provides the information you need to get started using the essential features of your camera. For detailed information about camera features, see the electronic User Guide (see *Accessing the electronic User Guide* on page 4).

Quick Start Guide	Electronic User Guide
<p>This printed guide will help you to:</p> <ul style="list-style-type: none">• Start using your camera quickly• Install the HP Photosmart Software• Become familiar with your camera's basic features	<p>The electronic User Guide includes:</p> <ul style="list-style-type: none">• Descriptions of all the camera features• Battery information, including:<ul style="list-style-type: none">• Extending battery life• A description of the power indicator icons• Troubleshooting• Getting assistance from HP• Camera specifications

Accessing the electronic User Guide



The electronic User Guide is on the HP Photosmart Software CD.

To view the User Guide:

1. Insert the HP Photosmart Software CD into the CD drive of your computer.
2. Click **View User Guide** on the main page of the installation screen.

The electronic User Guide is also copied to your computer when you install the HP Photosmart Software. To view the User Guide after it has been installed on your computer:

- **On Windows:** Open the **HP Solution Center** and click help.
- **On Macintosh:** Open the **HP Device Manager** and select **Camera User Guide** from the **Information and Settings** pop-up menu.







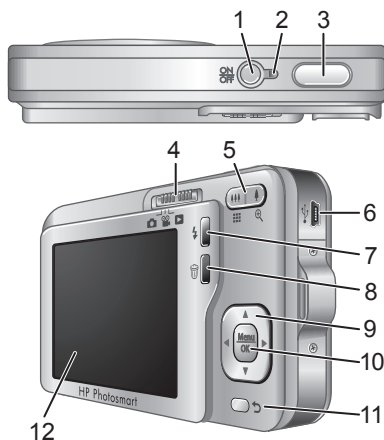

Getting assistance

- For tips and tools to help you use your camera more effectively, visit **www.hp.com**. From here, click on **Learn About: Digital Photography** (English Only).
- For product support, including firmware, software, and driver updates, visit **www.hp.com/support**.
- For help with the HP Photosmart Software, see the software's online help.

Camera top, side, and back



1	ON/OFF button.
2	Power light.
3	Shutter button.
4	selector—Switches between Picture Capture , Video Record , and Playback (see <i>Picture Capture</i> , <i>Video Record</i> , and <i>Playback</i> on page 18).
5	Zoom lever (Digital and Optical)—Accesses / Zoom while in Picture Capture or Video Record ; accesses Thumbnails and Magnify while in Playback .
6	USB connector.

7	 Flash button—Accesses the flash settings while in  Picture Capture . Settings are Auto, Auto Red-eye, Flash On, Flash Off.
8	 Delete button—Accesses the Delete function while in  Playback .
9	 and  buttons—Scroll through menus and images.
10	 button—Displays camera menus, selects options, and confirms actions.
11	 Back button—Returns you to a previous menu or view. Press and hold to back out of all menus.
12	Image Display.

Camera front and bottom

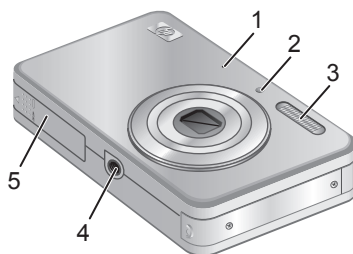

1	Microphone.
2	Self-Timer/Focus Assist light.
3	Flash.
4	Tripod mount.
5	Battery/Memory Card door.

2 Setting up your camera

Charge the battery

Before using the battery for the first time, fully charge it using the charger that came with your camera.

 **NOTE:** Your camera uses a rechargeable HP Photosmart LI40 battery (Q6277A). Do not charge any other battery in the charger.

1. Plug the charger into an electrical outlet, then insert the battery into the charger as shown.

The charger's Battery Charging light is orange while the battery is charging; the battery is fully charged when the light turns green (approximately 1.5 hours).

2. Remove the battery from the charger once it is fully charged.

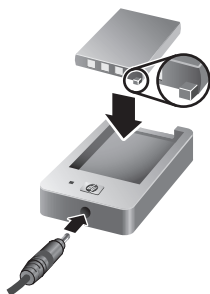

Install the battery

1. Open the Battery/Memory Card door by sliding the door latch as indicated on the Battery/Memory Card door.
2. Insert the battery in the larger slot, pushing the battery in until the latch catches.
3. Close the Battery/Memory Card door.

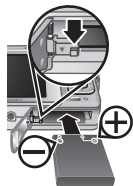

To remove the battery, move the battery latch as shown until the battery springs free.

Turn on the camera

To turn on the camera, press the ON/OFF button.

Choose the language

Use ▲▼◀▶ to choose the language that you want, then press $\frac{\text{Menu}}{\text{OK}}$.

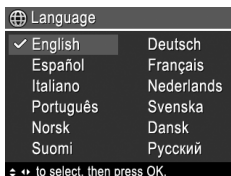

Set the region

Along with the language setting, the region setting determines the default date format.

Use ▲▼ to choose the region you want, then press $\frac{\text{Menu}}{\text{OK}}$.

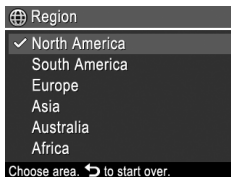

Set the date and time

Accurately setting the date and time will help you locate images once you have transferred them to your computer,

and will ensure that images are accurately marked if you use the date and time imprint feature.

1. Use ▲▼ to adjust the highlighted value.
2. Use ◀▶ to move to the other selections and repeat Step 1 until the date and time are set correctly.
3. Press $\frac{\text{Menu}}{\text{OK}}$ when the date, time, and format settings are correct, then press $\frac{\text{Menu}}{\text{OK}}$ again to confirm.

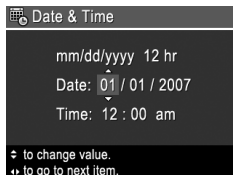

Install and format an optional memory card





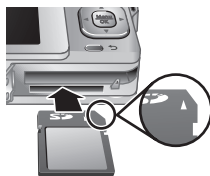







This camera supports standard, high speed, and high capacity Secure Digital (SD and SDHC) memory cards, 32MB to 8GB.

1. Turn off the camera and open the Battery/Memory Card door.
2. Insert the optional memory card in the smaller slot as shown. Make sure the memory card snaps into place.
3. Close the Battery/Memory Card door and turn on the camera.



 **NOTE:** When you turn on your camera with a memory card installed, the camera indicates the number of images you can store on the memory card at the current **Image Quality** setting. This camera supports storing a maximum of 2000 images on a memory card.

Always format new memory cards before first use. Formatting removes all images from the memory card, so make sure to transfer existing images before formatting.

1. With the camera turned on, slide    to .
2. Press  to display the  **Delete** menu.
3. Use   to select **Format Card**, then press .
4. Use   to select **Yes**, then press  to format the card.

Once you install a memory card, all new images and video clips are stored on the card, rather than in internal memory.

To use internal memory and view images stored there, turn the camera off, then remove the memory card.

Install the software

The HP Photosmart Software provides features for transferring images and video clips to your computer, as well as features for modifying stored images (remove red eyes, rotate, crop, resize, and more).

To install the HP Photosmart Software, your computer must meet the system requirements as stated on the camera packaging. To learn about Windows Vista support for your camera, see www.hp.com/go/windowsvista (English only).

If you have trouble installing or using the HP Photosmart Software, see the Hewlett-Packard Technical Support website for more information: www.hp.com/support.

Windows

1. Close all programs and temporarily disable any virus protection software.

2. Insert the HP Photosmart Software CD into the CD drive and follow the on-screen instructions. If the installation window does not appear, click **Start**, click **Run**, type **D:\Setup.exe**, where **D** is the letter of your CD drive, then click **OK**.
3. When the software has finished installing, re-enable virus protection software.

Macintosh

1. Insert the HP Photosmart Software CD into the CD drive.
2. Double-click the CD icon on the computer desktop.
3. Double-click the installer icon, then follow the on-screen instructions.

Once installation is complete and you have restarted your computer, **System Preferences** automatically opens to the **HP Photosmart Camera** settings. You may change settings so the HP Photosmart Software starts automatically when you connect your camera to your Macintosh (for more information, click the help button on the **HP Photosmart Camera** settings dialog).



3 Taking pictures and recording video clips

Slide to either to take pictures or to to record video clips.

Take a picture

You can take a picture when you are in **Picture Capture**.

1. Slide to .
2. Frame the subject in the Image Display.
3. Press the **Shutter** button halfway down to measure and lock the focus and exposure. The focus brackets in the Image Display turn solid green when focus is locked.
4. Press the **Shutter** button all the way down to take the picture.

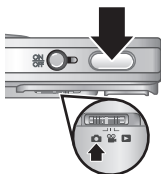

After you have taken a picture, the camera displays it briefly in the Image Display.

Record a video clip

You can record a video when you are in **Video Record**.

1. Slide to .
2. Frame the subject in the Image Display.
3. Press the **Shutter** button halfway down to measure focus and exposure. The focus brackets in the Image Display turn solid green when focus is locked.

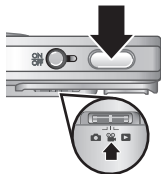









4. Press the **Shutter** button all the way down and release to begin recording video.
5. To stop recording video, press and release the **Shutter** button again.

After you have recorded a video clip, the camera displays it briefly in the Image Display.

4 Reviewing and deleting images and video clips

Review images and video clips











You can review images and video clips in  **Playback**.

1. Slide    to .
2. Use   to scroll through your images and video clips. To play a video clip, press  once the first screen of the clip appears on the Image Display.

 **NOTE:** To hear audio associated with video clips, transfer them to your computer.

Delete an image

You can delete individual images during  **Playback**:

1. Slide    to .
2. Use   to select an image or video clip.
3. Press  to display the  **Delete** menu.
4. Use   to select **This Image**, then press  **OK**.

5 Transferring and printing images

Transfer images

Use this procedure to transfer images and video clips to your computer.

 **NOTE:** Transferring a large number of high-resolution images from a memory card to your computer may take up to two hours. When transferring a large number of images, be sure your camera batteries are fully charged or use an optional memory card reader.

1. Turn off the camera, then connect it to the computer using the USB cable that came with your camera.
2. Turn on the camera. When the Image Display indicates that the camera is connected to the computer, follow the instructions on the computer screen to transfer the images. If you have installed the HP Photosmart Software and need more information, see the Help feature in the HP Photosmart Software.

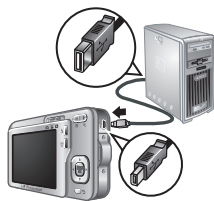

Print images from the camera

You can connect the camera to any PictBridge-certified printer to print images.

1. Check that the printer is turned on, there is paper in the printer, and there are no printer error messages.



2. Turn off the camera, then connect the camera and printer using the USB cable that came with your camera.

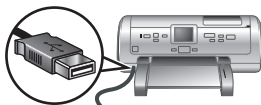

3. Turn on the camera.
4. When the camera is connected to the printer, the Image Display shows an image. Use ◀▶ to select the image you want to print.





















5. Press $\frac{\text{Menu}}{\text{OK}}$.
6. In the **Print Options** menu, select **Print this image now** to begin printing.
 displays on the selected image in the Image Display to indicate that the image is being printed.
7. After the printer has printed the image, disconnect the camera from the printer.

To learn about other printing options, see either the electronic User Guide or **? Camera Help** located in any menu.

6 Camera quick reference



Use this chapter as a quick reference to camera features. To learn more about these camera features, refer to the electronic User Guide or on-camera Help.







Picture Capture, Video Record, and Playback

-  **Picture Capture** allows you to frame pictures in the Image Display and take pictures. To activate  **Picture Capture**, slide    to .
-  **Video Record** allows you to frame videos in the Image Display and record videos. To activate  **Video Record**, slide    to .
-  **Playback** allows you review and delete images and video clips. To activate  **Playback**, slide    to .

Camera Menu







Menus allow you to adjust camera settings, work with images, and access camera help.

- Within a menu, use   to move to specific selections.
- To exit the menu, press  at any time.

 **Picture Capture Menu**—Allows you to adjust camera settings that affect the characteristics of future images you capture with your camera. To access this menu, slide    to , then press  Menu  OK. You can select from the following options:

- Shooting Mode (Auto, Close-up, Steady Photo, Theatre, Landscape, Portrait, Action, Night Portrait, Sunset)
- Self-Timer



- Image Quality
- Burst
- Date & Time Imprint
- Camera Setup
- Camera Help





 **Video Record Menu**—Allows you to adjust camera settings that affect the characteristics of future video clips you record with your camera. To access this menu, slide    to , then press  ^{Menu}/_{OK}. You can select from the following options:

- Self-Timer
- Camera Setup
- Camera Help





 **Playback Menu**—Allows you to work with images. To access this menu, slide    to , then press  ^{Menu}/_{OK}. You can select from the following options:

- Remove Red Eyes
- Design Gallery (Modify Color, Add Borders, Rotate, Crop)
- Photosmart Express (Print, Share, Buy Prints Online)
- Favorites
- View Slideshow
- Move Images to Card
- Camera Setup
- Camera Help

 **Camera Setup Menu**—Allows you to change the camera's behavior. To access this menu, press  ^{Menu}/_{OK} from

, , or , then select  **Camera Setup**. You can select from the following options:

- Display Brightness
- Camera Sounds
- Date & Time
- USB Configuration
- Language

? Camera Help Menu—Provides descriptions of camera features and picture-taking tips. To access this menu, press  from , , or , then select **? Camera Help**. You can select from the following options:

- Top Ten Tips
- Camera Accessories
- Camera Buttons
- Using Shooting Modes
- Using Design Gallery
- Using Photosmart Express
- Printing Images
- Recording Video Clips
- Reviewing Pictures and Video
- Tagging Images
- Deleting Images
- Transferring Images
- Managing Batteries
- Getting Assistance
- Tour Camera Features
- Camera Shortcuts
- About

Appareil photo numérique HP Photosmart série R740

Français



i n v e n t

Informations légales et remarques

© Copyright 2007 Hewlett-Packard Development Company, L.P.

Les informations contenues dans le présent document sont sujettes à modification sans préavis. Les seules garanties pour les produits et services HP sont énoncées dans les déclarations de garantie expresse accompagnant lesdits produits et services. Aucun élément du présent document ne saurait être interprété comme constituant une garantie supplémentaire. HP ne saurait être tenu pour responsable d'éventuelles erreurs ou omissions techniques ou rédactionnelles contenues dans le présent document.

Windows® est une marque déposée de Microsoft Corporation aux Etats-Unis.



est une marque commerciale de son propriétaire.



Mise au rebut des équipements usagés par les particuliers résidant au sein de l'Union européenne

Figurant sur le produit ou sur son emballage, ce symbole indique que vous ne devez pas jeter le produit avec vos déchets ménagers. Il vous incombe de déposer votre équipement usagé dans un centre de récupération des déchets spécialisé dans le recyclage des appareils électriques et électroniques. Le tri et le recyclage sélectifs de vos déchets contribuent à préserver les ressources naturelles et sont effectués de telle sorte que ni la santé de l'homme, ni l'environnement ne soient affectés. Pour plus d'informations sur les sites où vous pouvez déposer vos équipements usagés à des fins de recyclage, renseignez-vous auprès du service concerné à la mairie de votre lieu de résidence, du service de voirie ou du magasin où vous avez acheté votre produit.

Veillez noter les informations suivantes pour référence ultérieure :

- Numéro du modèle : _____
- Numéro de série : _____
- Date d'achat : _____

Sommaire

1	Prise en main	
	Accès au Guide de l'utilisateur au format électronique.....	5
	Dessus, flanc et arrière de l'appareil photo.....	6
	Façade et dessous de l'appareil photo.....	8
2	Préparation de votre appareil photo	
	Chargement de la batterie.....	9
	Installation de la batterie.....	10
	Mise en marche de l'appareil photo.....	10
	Choix de la langue.....	10
	Sélection de la région.....	11
	Réglage de la date et de l'heure.....	11
	Insertion et formatage d'une carte mémoire (en option).....	12
	Installation du logiciel.....	13
	Windows.....	13
	Macintosh.....	14
3	Prises de vue et enregistrement de clips vidéo	
	Prise de vue.....	15
	Enregistrement d'un clip vidéo.....	16
4	Visualisation et suppression des images et des clips vidéo	
	Visualisation des images et des clips vidéo.....	17
	Suppression d'une image.....	17
5	Transfert et impression d'images	
	Transfert d'images.....	18
	Impression d'images à partir de l'appareil photo.....	19
6	Référence rapide de l'appareil photo	20

1 Prise en main

Ce guide imprimé de prise en main rapide fournit les informations nécessaires à l'utilisation des principales fonctionnalités de votre appareil photo. Pour obtenir des informations détaillées sur l'ensemble de ses fonctionnalités, consultez le Guide de l'utilisateur au format électronique (voir *Accès au Guide de l'utilisateur au format électronique*, page 5).

Guide de prise en main rapide	Guide de l'utilisateur au format électronique
<p>Ce guide imprimé vous permettra :</p> <ul style="list-style-type: none">• D'utiliser votre appareil photo rapidement• D'installer le logiciel HP Photosmart• De vous familiariser avec les fonctions de base de l'appareil photo	<p>Le Guide de l'utilisateur au format électronique comprend :</p> <ul style="list-style-type: none">• Des descriptions de l'ensemble des fonctionnalités de l'appareil photo• Des informations relatives à la batterie, notamment :<ul style="list-style-type: none">• L'extension de son autonomie• Une description des icônes d'indication de charge• Résolution des problèmes• Obtenir une assistance auprès de HP

- Caractéristiques de l'appareil photo

Accès au Guide de l'utilisateur au format électronique



Le Guide de l'utilisateur au format électronique se trouve sur le CD HP Photosmart Software.

Pour consulter le Guide de l'utilisateur :

1. Insérez le CD HP Photosmart Software dans le lecteur de CD-ROM de votre ordinateur.
2. Cliquez sur **Afficher le Guide de l'utilisateur** dans la page principale de l'écran d'installation.

Le Guide de l'utilisateur au format électronique est également copié sur votre ordinateur lorsque vous installez le logiciel HP Photosmart. Pour vous assurer que le guide a bien été installé sur votre ordinateur :

- **Windows** : ouvrez le **Centre de solutions HP** et cliquez sur Aide.
- **Macintosh** : ouvrez le **Gestionnaire de périphériques HP** et sélectionnez **Guide de l'utilisateur** dans le menu contextuel **Informations et réglages**.

Obtenir une assistance

- Pour bénéficier de conseils et d'outils pour une utilisation plus efficace de votre appareil photo, consultez le site Web à l'adresse **www.hp.com**. Cliquez sur **Learn About: Digital Photography** (en anglais uniquement).
- Pour obtenir une assistance sur le produit, y compris les mises à jour du microprogramme, des logiciels et des pilotes, visitez le site **www.hp.com/support**.

- Si nécessaire, reportez-vous à l'aide en ligne du logiciel HP Photosmart.



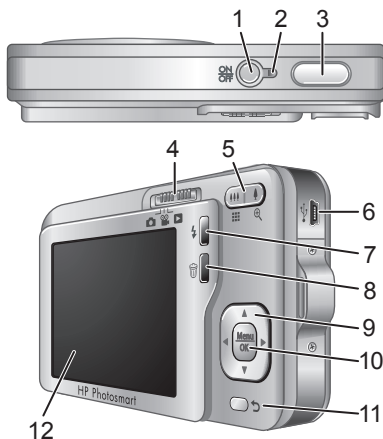









Dessus, flanc et arrière de l'appareil photo



Français

1	Bouton ON/OFF.
2	Voyant d'alimentation.
3	Déclencheur.
4	Sélecteur : permet de basculer entre les modes Capture d'images , Enregistrement vidéo et Lecture (voir <i>Capture d'images, enregistrement vidéo et lecture</i> , page 20).
5	Levier de Zoom (numérique et optique) : permet d'accéder au Zoom à partir du mode Capture d'images ou Enregistrement

6 Appareil photo numérique HP Photosmart série R740

	vidéo ; permet d'accéder aux boutons  Miniatures et  Aggrandissement à partir du mode  Lecture .
6	Connecteur USB.
7	 Flash : Permet d'accéder aux paramètres du flash lorsque l'appareil est en mode  Capture d'images . Les paramètres disponibles sont Flash auto, Anti-yeux rouges, Flash activé, Flash désactivé.
8	 Bouton Supprimer : permet d'accéder à la fonction Supprimer à partir du mode  Lecture .
9	Boutons   et   : Permettent de parcourir les menus et les images.
10	Bouton  ^{Menu} _{OK} : Permet d'afficher les menus de l'appareil photo, de sélectionner les options et de confirmer les actions.
11	 Bouton Retour : Revient au menu ou à la vue qui précède. Appuyez et maintenez la pression sur ce bouton pour remonter tous les niveaux de menu et les quitter.
12	Ecran.

Façade et dessous de l'appareil photo

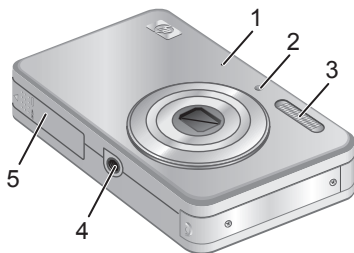

Français

1	Microphone.
2	Voyant du retardateur/de la mise au point.
3	Flash.
4	Filetage pour trépied.
5	Volet du compartiment de la carte mémoire/batterie.

2 Préparation de votre appareil photo

Chargement de la batterie

Avant d'utiliser la batterie pour la première fois, rechargez-la complètement à l'aide du chargeur fourni avec votre appareil photo.

 **Remarque** Votre appareil photo utilise une batterie lithium-ion rechargeable HP Photosmart LI40 (Q6277A). Ne rechargez aucun autre type de batterie dans le chargeur.

1. Branchez le chargeur sur une prise électrique, puis insérez la batterie dans le chargeur comme indiqué.

Lorsque le voyant de charge de la batterie est de couleur orange, la batterie est en cours de chargement. La batterie est complètement rechargée lorsque le voyant de charge devient vert (compter environ 1 heure 1/2).

2. Une fois la batterie complètement chargée, retirez-la du chargeur.

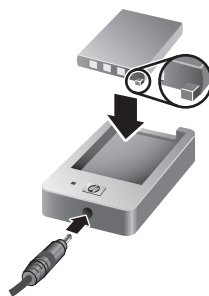

Installation de la batterie

1. Ouvrez le volet du compartiment de la batterie/carte mémoire en faisant glisser le loquet, comme indiqué sur le volet du compartiment.
2. Insérez la batterie dans le logement le plus large, puis enfoncez-la jusqu'à enclenchement du loquet.
3. Refermez le volet du compartiment piles/carte mémoire.



Pour retirer la batterie, déplacez le loquet comme indiqué, jusqu'à ce que la batterie se libère.

Mise en marche de l'appareil photo

Pour mettre l'appareil photo sous tension, appuyez sur le bouton ON/OFF.

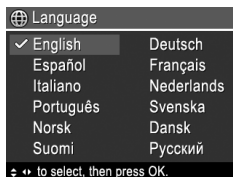

Choix de la langue

Utilisez ▲▼◀▶ pour sélectionner la langue de votre choix, puis appuyez sur ^{Menu}OK.



Sélection de la région

De même que le paramètre de langue, le paramètre de région détermine le format de date par défaut.

Utilisez ▲▼ pour sélectionner la région de votre choix, puis appuyez sur  .

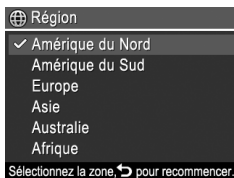



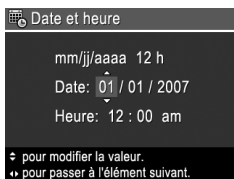

Réglage de la date et de l'heure

La définition correcte de la date et de l'heure permettra de trouver plus facilement les images une fois celles-ci transférées sur votre ordinateur. Elle garantira le marquage correct des images si vous utilisez la fonction d'inclusion de la date et de l'heure.

1. Utilisez ▲▼ pour mettre la valeur en surbrillance.
2. Utilisez ◀▶ pour passer aux autres choix et réitérez l'étape 1 jusqu'à ce que la date et l'heure soient correctement réglées.



3. Appuyez sur   lorsque les paramètres de date, d'heure et de format sont corrects, puis appuyez de nouveau sur   pour confirmation.

Insertion et formatage d'une carte mémoire (en option)





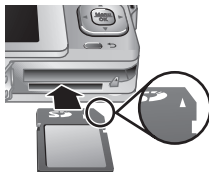



Cet appareil photo prend en charge les cartes mémoire Secure Digital (SD et SDHC) de 32 Mo à 8 Go (standard, haute vitesse et haute capacité).

1. Éteignez l'appareil photo et ouvrez le volet du compartiment de la batterie/carte mémoire.
2. Insérez la carte mémoire (en option) dans le logement le plus petit, comme illustré. Assurez-vous que la carte mémoire est bien en place.
3. Fermez le volet du compartiment de la batterie/carte mémoire et allumez l'appareil photo.



Remarque Lorsque vous mettez l'appareil photo sous tension alors qu'une carte mémoire est installée, l'appareil indique le nombre d'images pouvant être stockées sur la carte en fonction du paramètre **Qualité d'image** en cours. L'appareil permet de stocker jusqu'à 2 000 images sur une carte mémoire.

Formatez toujours les cartes mémoire avant leur première utilisation. Le formatage supprime toutes les images de la carte mémoire. Assurez-vous donc que vous avez bien effectué le transfert des images existantes avant le formatage.

1. L'appareil photo étant sous tension, positionnez le sélecteur    sur .
2. Appuyez sur  pour afficher le menu  **Supprimer**.
3. Utilisez   pour sélectionner **Formater la carte**, puis appuyez sur .

4. Utilisez ▲▼ pour sélectionner **Oui**, puis appuyez sur  pour formater la carte.

Une fois la carte mémoire installée, les nouvelles images et nouveaux clips vidéo ne sont plus stockés dans la mémoire interne, mais sur cette carte.

Pour utiliser la mémoire interne et visualiser les images qu'elle contient, éteignez d'abord l'appareil photo, puis retirez la carte mémoire.

Installation du logiciel

Le logiciel HP Photosmart permet non seulement de transférer des photos et des clips vidéo sur votre ordinateur, mais aussi de modifier les images stockées (correction de l'effet yeux rouges, rotation, recadrage, redimensionnement, etc.).

Pour que l'installation du logiciel HP Photosmart soit possible, votre ordinateur doit respecter la configuration requise décrite sur l'emballage de l'appareil photo. Pour connaître les conditions de prise en charge de votre appareil photo sous Windows Vista, voir www.hp.com/go/windowsvista (en anglais uniquement).

Si vous rencontrez des difficultés pour installer le logiciel HP Photosmart, consultez le site Web du centre d'assistance technique Hewlett-Packard pour plus d'informations : www.hp.com/support.

Windows

1. Fermez tous les programmes et désactivez temporairement tout logiciel antivirus.

2. Insérez le CD HP Photosmart Software dans le lecteur de CD-ROM et suivez les instructions à l'écran. Si la fenêtre d'installation ne s'affiche pas, cliquez sur **Démarrer**, puis sur **Exécuter** et saisissez **D:\Setup.exe** (où **D** correspond à la lettre désignant le lecteur de CD-ROM). Cliquez ensuite sur **OK**.
3. Une fois le logiciel installé, réactivez le logiciel antivirus.

Macintosh

1. Insérez le CD HP Photosmart Software dans le lecteur de CD-ROM de votre ordinateur.
2. Cliquez deux fois sur l'icône du CD-ROM située sur le bureau.
3. Cliquez deux fois sur l'icône d'installation et suivez les instructions qui s'affichent à l'écran.





Une fois l'installation terminée et après redémarrage de votre ordinateur, la fenêtre **Préférences système** s'ouvre automatiquement sur les paramètres de l'**appareil photo HP Photosmart**. Vous pouvez modifier les paramètres de sorte que le logiciel HP Photosmart démarre automatiquement dès que vous connectez l'appareil photo à votre Macintosh (pour plus d'informations, cliquez sur Aide dans la boîte de dialogue contenant les paramètres de l'**appareil photo HP Photosmart**).

3 Prises de vue et enregistrement de clips vidéo

Positionnez le sélecteur    sur  pour effectuer une prise de vue, ou sur  pour enregistrer des clips vidéo.

Prise de vue

Vous pouvez prendre des clichés lorsque vous vous trouvez en mode  **Capture d'images**.

1. Positionnez le sélecteur    sur .
2. Cadrez le sujet à l'écran.
3. Enfoncez le **déclencheur** à mi-course pour mesurer la mise au point et l'exposition. Les crochets de mise au point à l'écran apparaissent en vert lorsque la mise au point est verrouillée.
4. Enfoncez entièrement le **déclencheur** pour prendre la photo.



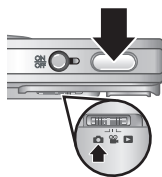

Une fois la prise de vue effectuée, l'appareil affiche brièvement l'image à l'écran.

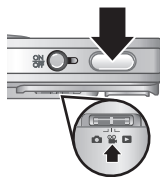

Enregistrement d'un clip vidéo

Vous pouvez enregistrer une vidéo lorsque vous vous trouvez en mode  **Enregistrement vidéo**.











1. Positionnez le sélecteur    sur .
2. Cadrez le sujet à l'écran.
3. Enfoncez le **déclencheur** à mi-course pour verrouiller la mise au point et l'exposition. Les crochets de mise au point à l'écran apparaissent en vert lorsque la mise au point est verrouillée.
4. Appuyez à fond sur le **déclencheur** et relâchez-le pour commencer l'enregistrement vidéo.
5. Pour mettre fin à l'enregistrement vidéo, appuyez de nouveau sur le **déclencheur**, puis relâchez-le.

Une fois l'enregistrement du clip vidéo effectué, l'appareil affiche brièvement celui-ci à l'écran.

4 Visualisation et suppression des images et des clips vidéo

Visualisation des images et des clips vidéo













Vous pouvez visualiser les images et les clips vidéo en mode  **Lecture**.

1. Positionnez le sélecteur    sur .
2. Utilisez les boutons   pour parcourir vos images et vos clips vidéo. Pour lire un clip vidéo, appuyez sur  dès que la première image du clip apparaît à l'écran.

 **Remarque** Pour écouter le son associé aux clips vidéo, transférez ceux-ci sur votre ordinateur.

Suppression d'une image

Vous pouvez supprimer les images une à une lorsque vous êtes en mode  **Lecture** :

1. Positionnez le sélecteur    sur .
2. Utilisez   pour sélectionner une image ou un clip vidéo.
3. Appuyez sur  pour afficher le menu  **Supprimer**.
4. Utilisez   pour sélectionner **Cette image**, puis appuyez sur  .

5 Transfert et impression d'images

Transfert d'images

Utilisez cette procédure pour transférer des images et des clips vidéo sur votre ordinateur.

 **Remarque** Le transfert d'un grand nombre d'images à résolution élevée entre une carte mémoire et votre ordinateur peut prendre jusqu'à deux heures. Lors du transfert d'un grand nombre d'images, assurez-vous que les batteries de l'appareil photo sont entièrement rechargées, ou utilisez un lecteur de cartes mémoire optionnelles.

1. Eteignez l'appareil photo, puis connectez-le à l'ordinateur à l'aide du câble USB fourni avec l'appareil.
2. Allumez l'appareil photo. Lorsque l'écran indique que l'appareil photo est connecté à l'ordinateur, suivez les instructions affichées sur l'ordinateur pour transférer les images. Si vous avez installé le logiciel HP Photosmart et avez besoin de davantage d'informations, consultez l'aide relative au logiciel HP Photosmart.

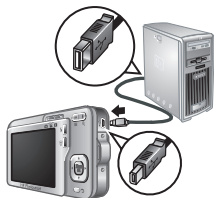



Impression d'images à partir de l'appareil photo

Vous pouvez connecter l'appareil photo à une imprimante compatible PictBridge pour imprimer des photos.

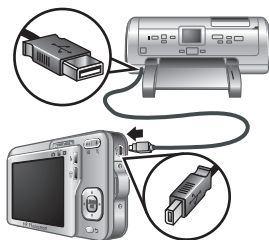

1. Vérifiez que l'imprimante est sous tension, qu'elle contient du papier et qu'elle n'affiche aucun message d'erreur.
2. Éteignez l'appareil photo, puis connectez-le à l'imprimante à l'aide du câble USB fourni avec l'appareil.
3. Allumez l'appareil photo.
4. Une fois l'appareil photo relié à l'imprimante, l'écran affiche une image. Utilisez les boutons ◀ ▶ pour sélectionner l'image à imprimer.
5. Appuyez sur Menu / OK.
6. Dans le menu **Options d'impression**, sélectionnez **Imprimer cette image maintenant** pour lancer l'impression.



L'icône  affiche à l'écran l'image sélectionnée pour indiquer qu'elle est en cours d'impression.

7. Une fois l'impression de l'image terminée, déconnectez l'appareil photo de l'imprimante.

Pour en savoir plus sur les autres options d'impression, consultez la version électronique du Guide de l'utilisateur ou la rubrique **? Aide** sur l'appareil photo accessible via tous les menus.

6 Référence rapide de l'appareil photo



Utilisez ce chapitre comme guide de référence rapide sur les fonctionnalités de l'appareil photo. Pour plus d'informations sur les fonctionnalités de cet appareil photo, consultez le Guide de l'utilisateur au format électronique ou l'aide de l'appareil photo.

Capture d'images, enregistrement vidéo et lecture

- La  **Capture d'images** vous permet de cadrer des images à l'écran. Pour activer le mode  **Capture d'images**, déplacez le sélecteur    sur .
- Le mode  **Enregistrement vidéo** vous permet de cadrer des vidéos à l'écran. Pour activer le mode  **Enregistrement vidéo**, déplacez le sélecteur    sur .
- La fonction  **Lecture** permet de visualiser et de supprimer les images et les clips vidéo. Pour activer le mode  **Lecture**, déplacez le sélecteur    sur .

Menus de l'appareil photo

Les menus vous permettent de paramétrer l'appareil photo, d'éditer des images et d'accéder à l'aide sur l'appareil.

- Dans le menu, utilisez   pour passer d'une sélection à une autre.
- Pour quitter le menu, appuyez à tout moment sur .





 **Menu Capture d'images** : Permet de régler les paramètres de l'appareil photo qui influent sur les caractéristiques de vos prises de vue ultérieures. Pour accéder à ce menu, déplacez le sélecteur    sur

 et appuyez sur $\frac{\text{Menu}}{\text{OK}}$. Vous pouvez choisir les options suivantes :

- Mode de prise de vues (Mode Auto, Macro, Anti-flou, Théâtre, Paysage, Portrait, Action, Portrait nuit, Coucher de soleil)
- Retardateur
- Qualité d'image
- Rafale
- Inclure date/heure
- Configuration
- Aide

 **Menu Enregistrement vidéo** : permet de régler les paramètres de l'appareil photo qui affectent les caractéristiques des enregistrements vidéo effectués avec cet appareil. Pour accéder à ce menu, déplacez le sélecteur    sur  et appuyez sur $\frac{\text{Menu}}{\text{OK}}$. Vous pouvez choisir les options suivantes :

- Retardateur
- Configuration
- Aide





 **Menu Lecture** : Permet de modifier les images. Pour accéder à ce menu, déplacez le sélecteur    sur  et appuyez sur $\frac{\text{Menu}}{\text{OK}}$. Vous pouvez choisir les options suivantes :

- Correction yeux rouges
- Galerie créative (Modifier couleur, Ajout bordures, Rotation, Recadrer)
- Photosmart Express (Impression, Partage, Commander tirages en ligne)
- Favoris

- Voir diaporama
- Dépl. images sur carte
- Configuration
- Aide

 **Menu Configuration** : Vous permet de modifier le comportement de l'appareil photo. Pour accéder à ce menu, appuyez sur  à partir du mode ,  ou , puis sélectionnez l'option  **Configuration**. Vous pouvez choisir les options suivantes :

- Luminosité écran
- Sons de l'appareil
- Date/Heure
- Configuration USB
- Langue

? Menu Aide : décrit les fonctions de l'appareil photo et fournit des conseils sur la prise de vue. Pour accéder à ce menu, appuyez sur  à partir du mode ,  ou , puis sélectionnez l'option **? Aide**. Vous pouvez choisir les options suivantes :

- 10 conseils
- Accessoires de l'appareil
- Boutons de l'appareil
- Modes de prise de vue
- Utilisation de la Galerie créative
- Utilisation de Photosmart Express
- Impression d'images
- Enreg. de clips vidéo
- Visualisation images et vidéos
- Étiquetage des images

- Suppression d'images
- Transfert d'images
- Gestion des batteries
- Obtenir de l'assistance
- Aperçu des fonctions de l'appareil
- Raccourcis de l'appareil photo
- À propos de

Français



Français

Fotocamera digitale
HP Photosmart serie R740

Italiano



i n v e n t

Note legali

© Copyright 2007 Hewlett-Packard Development Company, L.P.

Le informazioni contenute in questo documento sono soggette a modifica senza preavviso. Le uniche garanzie per i prodotti e i servizi HP sono definite nelle dichiarazioni di garanzia esplicita che accompagnano tali prodotti e servizi. Nulla di quanto dichiarato nel presente documento costituisce una garanzia aggiuntiva. HP non sarà ritenuta responsabile di eventuali omissioni o errori tecnici o editoriali qui contenuti.

Windows® è un marchio registrato di Microsoft Corporation negli Stati Uniti.



Il logo SD è un marchio del rispettivo titolare.

Smaltimento di apparecchiature dismesse da parte dei cittadini dell'Unione Europea



La presenza di questo simbolo sul prodotto o sulla sua confezione sta ad indicare che il prodotto non può essere smaltito tra i rifiuti generici. È responsabilità di ogni singolo cittadino smaltire il prodotto consegnandolo al centro di raccolta autorizzato più vicino a scopo di riciclo. La raccolta differenziata di apparecchiature elettriche ed elettroniche dismesse e il loro smaltimento a scopo di riciclo costituiscono una efficace misura di salvaguardia della salute e dell'ambiente. Per ulteriori informazioni sullo smaltimento/riciclo di tali apparecchiature, rivolgersi al proprio rivenditore o all'ente locale preposto.

Per riferimento in futuro, inserire le seguenti informazioni:

- Numero modello: _____
- Numero di serie: _____
- Data di acquisto: _____

Sommario

1	Informazioni preliminari	
	Accesso alla Guida d'uso elettronica.....	5
	Viste superiore, laterale e posteriore della fotocamera.....	6
	Viste anteriore e inferiore della fotocamera.....	7
2	Configurazione della fotocamera	
	Carica della batteria.....	9
	Installazione della batteria.....	10
	Accensione della fotocamera.....	10
	Scelta della lingua.....	10
	Impostazione della regione.....	10
	Impostazione della data e dell'ora.....	11
	Installazione e formattazione di una scheda di memoria opzionale.....	11
	Installazione del software.....	12
	Windows.....	13
	Macintosh.....	13
3	Foto e videoclip	
	Scatto delle foto.....	15
	Registrazione di videoclip.....	15
4	Visione e cancellazione di immagini e videoclip	
	Visione di immagini e videoclip.....	17
	Cancellazione di un'immagine.....	17
5	Trasferimento e stampa delle immagini	
	Trasferimento delle immagini.....	18
	Stampa delle immagini della fotocamera.....	18
6	Riferimento rapido per la fotocamera	20

1 Informazioni preliminari

Questa guida rapida fornisce le informazioni per poter iniziare ad utilizzare le funzioni di base della fotocamera. Per informazioni dettagliate sulle funzioni della fotocamera, consultare la Guida d'uso elettronica (vedere *Accesso alla Guida d'uso elettronica* a pagina 5).

Questa guida rapida	Guida d'uso elettronica
<p>Questa guida consente di:</p> <ul style="list-style-type: none">• Iniziare subito ad utilizzare la fotocamera• Installare il software HP Photosmart• Usare le funzioni base della fotocamera	<p>La Guida d'uso elettronica contiene:</p> <ul style="list-style-type: none">• Una descrizione di tutte le funzioni della fotocamera• Informazioni sulla batteria, tra cui:<ul style="list-style-type: none">• Ottimizzazione della durata della batteria• Una descrizione delle icone relative all'indicatore di alimentazione• Soluzione dei problemi• Informazioni per richiedere l'assistenza HP• Specifiche della fotocamera

Accesso alla Guida d'uso elettronica



La Guida d'uso elettronica è disponibile sul CD del software HP Photosmart.

Per visualizzare la Guida d'uso:

1. Inserire il CD del software HP Photosmart nell'unità CD del computer.
2. Fare clic su **Visualizza la Guida d'uso** nella pagina principale della schermata di installazione.

La Guida d'uso elettronica viene inoltre copiata sul computer quando si installa il software HP Photosmart. Per visualizzare la Guida d'uso dopo che è stata installata sul computer:

- **In Windows:** Aprire **Centro soluzioni HP** e fare clic sulla voce relativa alla guida.
- **In Macintosh:** Aprire **HP Device Manager** e selezionare **Guida d'uso** dal menu a comparsa **Informazioni e impostazioni**.







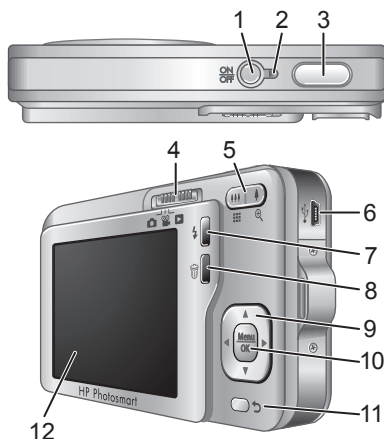



Assistenza e supporto

- Per suggerimenti e strumenti che permettano di ottimizzare l'utilizzo della fotocamera, visitare il sito Web all'indirizzo **www.hp.com**. Qui, fare clic su **Learn About: Digital Photography** (solo in inglese).
- Per il supporto del prodotto, inclusi gli aggiornamenti del firmware, del software e dei driver, visitare il sito Web all'indirizzo **www.hp.com/support**.
- Per le istruzioni sull'uso del software HP Photosmart, vedere la relativa guida elettronica.

Viste superiore, laterale e posteriore della fotocamera



1	Pulsante ON/OFF.
2	Spia di accensione.
3	Pulsante otturatore .
4	Selettore : consente di attivare le modalità Scatto , Registrazione e Riproduzione (vedere <i>Scatto</i> , <i>Registrazione</i> , <i>Riproduzione</i> a pagina 20).
5	Leva dello zoom (digitale e ottico): consente di accedere alla funzione / Zoom quando è attiva la modalità Scatto o Registrazione ; consente di accedere alle funzioni Mostra anteprime e Ingrandisci quando è attiva la modalità Riproduzione .

6	Connettore USB.
7	 Pulsante del flash : consente di accedere alle impostazioni del flash quando è attiva la modalità  Scatto . Le impostazioni disponibili sono Auto, Occhi rossi, Flash On, Flash Off.
8	 Pulsante di eliminazione : consente di accedere alla funzione Eliminare quando è attiva la modalità  Riproduzione .
9	  e   : consentono di scorrere i menu e le immagini.
10	Pulsante  : consente di visualizzare i menu della fotocamera, selezionare le opzioni e confermare le azioni.
11	 Pulsante Indietro : consente di tornare ad un menu o una vista precedente. Tenerlo premuto per uscire da tutti i menu aperti in sequenza.
12	Display LCD.

Viste anteriore e inferiore della fotocamera

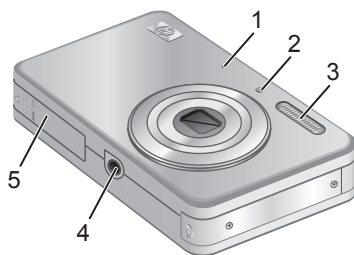

1	Microfono.
---	------------

2	Spia Autoscatto/Supporto messa a fuoco.
3	Flash.
4	Attacco treppiede.
5	Sportello del vano batteria/scheda di memoria.

Italiano

2 Configurazione della fotocamera

Carica della batteria

Prima di utilizzare la batteria per la prima volta, caricarla completamente usando il caricabatterie fornito con la fotocamera.

 **Nota** La fotocamera utilizza una batteria ricaricabile HP Photosmart LI40 (Q6277A). Non ricaricare altre batterie nel caricabatterie.

1. Collegare il caricabatterie a una presa elettrica, quindi inserirvi la batteria come indicato.

La spia di ricarica sul caricabatterie è accesa con luce arancione durante l'operazione di ricarica; quando la luce diventa verde significa che la batteria è completamente carica (l'operazione di ricarica dura circa 1,5 ore).

2. Rimuovere la batteria dal caricabatterie dopo che è stata caricata completamente.

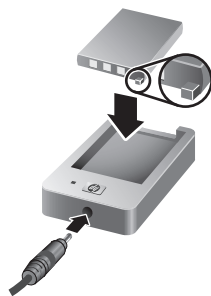

Installazione della batteria

1. Aprire lo sportello del vano batteria/
scheda di memoria facendo scorrere il
fermo come indicato sullo sportello.
2. Inserire la batteria nel vano più grande
e spingerla fino a quando non si blocca
in posizione.
3. Chiudere lo sportello del vano batteria/
scheda di memoria.

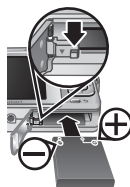

Per rimuovere la batteria, spostare il fermo come mostrato fino a quando la batteria non esce automaticamente.

Accensione della fotocamera

Per accendere la fotocamera, premere il pulsante ON/OFF.

Scelta della lingua

Utilizzare i pulsanti ▲▼ ◀▶ per
evidenziare la lingua desiderata e
quindi premere ^{Menu}_{OK}.

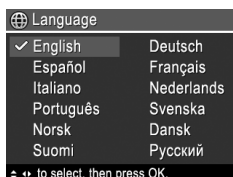

Impostazione della regione

Insieme all'impostazione di
Lingua, l'impostazione di
Regione determina il formato
predefinito per la data.

Utilizzare i pulsanti ▲▼ per
evidenziare la regione desiderata



e quindi premere $\frac{\text{Menu}}{\text{OK}}$.

Impostazione della data e dell'ora

Impostando con precisione data e ora, sarà più semplice individuare le immagini una volta caricate sul computer e, se si utilizza la funzione Inserimento di data e ora, le immagini risulteranno contrassegnate correttamente.

1. Utilizzare i pulsanti ▲▼ per regolare il valore evidenziato.
2. Utilizzare i pulsanti ◀▶ per passare alle altre selezioni e ripetere il passo 1 finché la data e l'ora non sono impostate correttamente.
3. Premere $\frac{\text{Menu}}{\text{OK}}$ quando le impostazioni di data, ora e formato sono corrette e quindi premere nuovamente $\frac{\text{Menu}}{\text{OK}}$ per confermare.

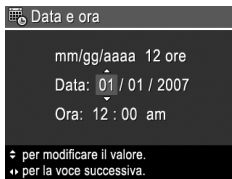

Installazione e formattazione di una scheda di memoria opzionale

Questa fotocamera supporta schede di memoria ad alta capacità Secure Digital (SD e SDHC), sia standard che ad alta velocità, da 32 MB a 8 GB.

1. Spegnerla fotocamera e aprire lo sportello del vano batteria/scheda di memoria.
2. Inserire la scheda di memoria opzionale nell'alloggiamento più piccolo, come mostrato nella figura. Accertarsi che la scheda di memoria scatti in posizione.
3. Chiudere lo sportello del vano batteria/scheda di memoria ed accendere la fotocamera.

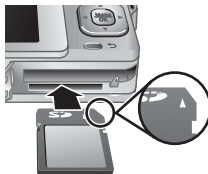



Nota Se si accende la fotocamera quando al suo interno è installata una scheda di memoria, la fotocamera indica il numero di immagini che è possibile memorizzare sulla scheda utilizzando l'impostazione corrente di **Qualità immag.** Con questa fotocamera è possibile memorizzare su una scheda un massimo di 2000 immagini.

Formattare sempre le nuove schede di memoria prima del primo utilizzo. La formattazione rimuove tutte le immagini dalla scheda di memoria, pertanto accertarsi che siano state trasferite prima di procedere con la formattazione.

1. Quando la fotocamera è accesa, spostare su .
2. Premere per visualizzare il menu **Eliminare**.
3. Utilizzare i pulsanti per selezionare **Formatta scheda** e poi premere .
4. Utilizzare i pulsanti per selezionare **Sì**, quindi premere per formattare la scheda.

Quando si installa una scheda di memoria nella fotocamera, tutte le nuove immagini e i videoclip vengono memorizzati sulla scheda e non nella memoria interna.

Per utilizzare la memoria interna e visualizzare le immagini ivi memorizzate, rimuovere la scheda di memoria.

Installazione del software

Il software HP Photosmart fornisce le funzioni per trasferire immagini e videoclip nel computer, nonché funzioni per modificare le immagini memorizzate (eliminare gli occhi rossi, ruotare, ritagliare e ridimensionare la foto e tanto altro ancora).



Per installare il software HP Photosmart, il computer deve soddisfare i requisiti di sistema indicati sulla confezione della fotocamera. Per maggiori informazioni sul supporto Windows Vista per la fotocamera, vedere www.hp.com/go/windowsvista (solo in inglese).

Se durante l'installazione o l'uso del software HP Photosmart si verificano dei problemi, visitare il sito Web per l'assistenza tecnica HP per richiedere maggiori informazioni: www.hp.com/support.

Windows

1. Chiudere tutti i programmi e disattivare temporaneamente eventuali software antivirus.
2. Inserire il CD del software HP Photosmart nell'unità CD e seguire le istruzioni visualizzate. Se non viene visualizzata la finestra di installazione, fare clic su **Start, Esegui**, digitare **D:\Setup.exe** (dove **D** è la lettera che corrisponde all'unità CD) e quindi fare clic su **OK**.
3. Terminata l'installazione del software, riattivare il software antivirus.

Macintosh





1. Inserire il CD del software HP Photosmart nell'unità CD.
2. Fare doppio clic sull'icona del CD sulla scrivania.
3. Fare doppio clic sull'icona del programma di installazione e seguire le istruzioni visualizzate.

Una volta completata l'installazione e riavviato il computer, **Preferenze di sistema** si apre automaticamente sulle impostazioni della **fotocamera HP Photosmart**. È possibile modificare le impostazioni in modo che il software HP Photosmart si avvii automaticamente quando si collega la fotocamera al

computer Macintosh (per maggiori informazioni, fare clic sul pulsante Aiuto nella finestra di dialogo per le impostazioni della **fotocamera HP Photosmart**).



Italiano

3 Foto e videoclip

Spostare   su  per scattare le foto oppure su  per registrare dei videoclip.

Scatto delle foto

È possibile scattare le foto quando è attiva la modalità  **Scatto**.

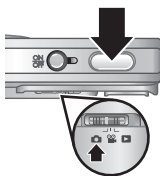

1. Spostare   su .
2. Inquadrare il soggetto nel display LCD.
3. Premere a metà il pulsante **otturatore** per misurare e bloccare la messa a fuoco e l'esposizione. Il quadro di messa a fuoco sul display LCD si accende con luce verde fissa quando la messa a fuoco è bloccata.
4. Premere fino in fondo il pulsante **otturatore** per scattare la foto.



Dopo lo scatto, la foto viene visualizzata brevemente sul display LCD.

Registrazione di videoclip

È possibile registrare un video quando è attiva la modalità  **Registrazione**.

1. Spostare   su .
2. Inquadrare il soggetto nel display LCD.

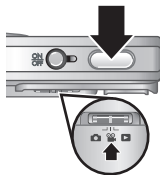







3. Premere a metà il pulsante **otturatore** per bloccare la messa a fuoco e l'esposizione. Il quadro di messa a fuoco sul display LCD si accende con luce verde fissa quando la messa a fuoco è bloccata.
4. Premere completamente il pulsante **otturatore** e rilasciarlo per iniziare la registrazione.
5. Per interrompere la registrazione, premere e rilasciare il pulsante **otturatore**.

Dopo la registrazione, il videoclip viene visualizzato brevemente sul display LCD.

4 Visione e cancellazione di immagini e videoclip

Visione di immagini e videoclip











In modalità  **Riproduzione** è possibile rivedere ed eliminare le immagini e i videoclip.

1. Spostare    su .
2. Usare   per scorrere foto e videoclip. Per riprodurre un videoclip, premere  quando sul display LCD compare il primo clip.

 **Nota** Per ascoltare l'audio associato ai videoclip, trasferirli sul computer.

Cancellazione di un'immagine

Quando è attiva la modalità  **Riproduzione** si possono eliminare singole immagini:

1. Spostare    su .
2. Usare   per selezionare un'immagine o un videoclip.
3. Premere  per visualizzare il menu  **Eliminare**.
4. Usare   per selezionare **Corrente**, quindi premere

Menu
OK

5 Trasferimento e stampa delle immagini

Trasferimento delle immagini

Applicare questa procedura per trasferire le immagini e i videoclip sul computer.

 **Nota** Il trasferimento di un numero notevole di immagini ad alta risoluzione da una scheda di memoria al computer potrebbe durare anche due ore. Quando si trasferisce un numero notevole di immagini, verificare che le batterie nella fotocamera siano cariche oppure utilizzare un lettore per schede di memoria opzionale.

1. Spegnerla fotocamera e poi collegarla al computer usando il cavo USB fornito con la fotocamera.
2. Accendere la fotocamera. Quando il display LCD indica che la fotocamera è collegata al computer, seguire le istruzioni visualizzate sul computer per trasferire le immagini. Se è stato installato il software HP Photosmart e sono necessarie maggiori informazioni, vedere la funzione della guida nel software HP Photosmart.



Italiano

Stampa delle immagini della fotocamera

Per stampare le foto, è possibile collegare la fotocamera a qualsiasi stampante certificata PictBridge.



1. Verificare che la stampante sia accesa, che la carta sia caricata e che non siano visualizzati messaggi di errore relativi alla stampante.
2. Spegnerla fotocamera e poi collegarla alla stampante usando il cavo USB fornito con la fotocamera. 
3. Accendere la fotocamera.
4. Quando la fotocamera è collegata alla stampante, sul display LCD compare un'immagine. Utilizzare ◀▶ per selezionare l'immagine che si desidera stampare. 
5. Premere $\frac{\text{Menu}}{\text{OK}}$.
6. Nel menu **Opzioni di stampa**, selezionare **Stampa questa immagine** per iniziare la stampa.
Sul display LCD, l'icona  compare sull'immagine selezionata ad indicare che è in corso la stampa della foto.
7. Terminata la stampa, scollegare la fotocamera dalla stampante.

Per maggiori informazioni sulle opzioni di stampa, vedere la Guida d'uso elettronica o la voce ?? disponibile in tutti i menu.

6 Riferimento rapido per la fotocamera



Usare questo capitolo come riferimento rapido alle funzioni della fotocamera. Per maggiori informazioni sulle funzioni della fotocamera, consultare la Guida d'uso elettronica o la guida nella fotocamera.

Scatto, Registrazione, Riproduzione

- La modalità  **Scatto** consente di inquadrare il soggetto sul display LCD e di scattare la foto. Per attivare la modalità  **Scatto**, spostare    su .
- La modalità  **Registrazione** consente di inquadrare il soggetto sul display LCD e di registrare il video. Per attivare la modalità  **Registrazione**, spostare    su .
- La modalità  **Riproduzione** consente di rivedere ed eliminare immagini e videoclip. Per attivare la modalità  **Riproduzione**, spostare    su .

Menu della fotocamera







I menu consentono di regolare le impostazioni della fotocamera, manipolare le immagini e accedere alla guida della fotocamera.

- All'interno di un menu, utilizzare   per spostarsi sulle opzioni desiderate.
- Per uscire dal menu, premere  in qualsiasi momento.







 **Menu Scatto:** consente di regolare le impostazioni della fotocamera che avranno effetto sulle foto che si scatteranno successivamente. Per accedere a questo

menu, spostare    su , quindi premere . È possibile scegliere tra le seguenti opzioni:

- Mod. scatto (Mod. automatica, Primo piano, Scatto stabile, Teatro, Panorama, Ritratto, Azione, Ritratto notturno, Tramonto)
- Autoscatto
- Qualità immag.
- Scatto continuo
- Inserimento di data e ora
- Configurazione
- ?







 **Menu Registrazione:** consente di regolare le impostazioni della fotocamera che avranno effetto sui videoclip che si registreranno successivamente. Per accedere a questo menu, spostare    su , quindi premere . È possibile scegliere tra le seguenti opzioni:

- Autoscatto
- Configurazione
- ?







 **Menu Riproduzione:** consente di utilizzare e manipolare le immagini. Per accedere a questo menu, spostare    su , quindi premere . È possibile scegliere tra le seguenti opzioni:

- Elimina occhi rossi
- Galleria degli effetti (Modifica colore, Aggiungi contorni, Ritaglia, Ruota)
- Photosmart Express (Stampa, Condividi, Acquisto stampe online)
- Preferiti
- Visualizza presentazione

- Sposta imm. su scheda
- Configurazione
- ?

 Menu **Configurazione**: consente di modificare il funzionamento della fotocamera. Per accedere a questo menu, premere  in modalità ,  o , quindi selezionare  **Configurazione**. È possibile scegliere tra le seguenti opzioni:

- Lumin. display
- Suoni fotocamera
- Data e ora
- Configurazione USB
- Lingua

 Menu **?**: fornisce le descrizioni delle funzioni della fotocamera e suggerimenti per scattare le foto. Per accedere a questo menu, premere  in modalità ,  o , quindi selezionare  . È possibile scegliere tra le seguenti opzioni:

- 10 utili suggerimenti
- Accessori
- Pulsanti fotocamera
- Uso delle modalità di scatto
- Uso della galleria degli effetti
- Uso di Photosmart Express
- Stampa immagini
- Registrazione videoclip
- Revisione foto e video
- Assegnazione dei tag alle immagini
- Cancellazione immagini

- Trasferimento immagini
- Manutenzione batterie
- Assistenza
- Demo delle funzioni della fotocamera
- Accesso rapido
- Info su

Italiano

Italiano

HP Photosmart R740- Digitalkameraserie



i n v e n t

Deutsch

Rechtliche Hinweise

© Copyright 2007 Hewlett-Packard Development Company, L.P.

Die Informationen in diesem Dokument können ohne vorherige Ankündigung geändert werden. Für HP Produkte und Dienste gelten nur die Gewährleistungen, die in den ausdrücklichen Gewährleistungserklärungen des jeweiligen Produkts bzw. Dienstes aufgeführt sind. Dieses Dokument gibt keine weiteren Gewährleistungen. HP haftet nicht für technische oder redaktionelle Fehler oder Auslassungen in diesem Dokument.

Windows® ist eine in den USA eingetragene Marke der Microsoft Corporation.

Das  SD-Logo ist eine Marke des entsprechenden Eigentümers.



Entsorgung von Altgeräten durch Benutzer in Privathaushalten in der EU

Dieses Symbol auf dem Produkt oder auf der Verpackung weist darauf hin, dass das Produkt nicht als Hausmüll entsorgt werden darf. Sie sind stattdessen dafür verantwortlich, Altgeräte bei der zuständigen Sammelstelle zum Recycling von Elektrogeräten und Elektronikzubehör abzugeben. Mülltrennung und das Recycling von Altgeräten schonen die natürlichen Ressourcen und stellen sicher, dass die Geräte in einer Art und Weise wiederverwertet werden, die die Gesundheit von Menschen und die Umwelt schützt. Weitere Informationen zu den Recycling-Sammelstellen für Ihre Altgeräte erhalten Sie bei der zuständigen Stelle der Stadtverwaltung, beim Entsorgungsunternehmen für Ihren Hausmüll oder in dem Geschäft, in dem das Produkt gekauft wurde.

Notieren Sie für zukünftige Nachfragen die folgenden Daten:

- Modellnummer: _____
- Seriennummer: _____
- Kaufdatum: _____

Inhalt

1 Erste Schritte	
Zugreifen auf das elektronische Benutzerhandbuch.....	5
Ober- und Rückseite sowie Seitenfläche der Kamera.....	6
Vorder- und Unterseite der Kamera.....	8
2 Einrichten Ihrer Kamera	
Aufladen der Akkus.....	9
Einsetzen der Akkus.....	9
Einschalten der Kamera.....	10
Auswählen der Sprache.....	10
Einstellen der Region.....	10
Einstellen von Datum und Uhrzeit.....	10
Einsetzen und Formatieren einer optionalen Speicherkarte.....	11
Installieren der Software.....	12
Windows.....	13
Macintosh.....	13
3 Aufnehmen von Bildern und Videoclips	
Aufnehmen von Bildern.....	15
Aufnehmen eines Videoclips.....	15
4 Betrachten und Löschen von Bildern und Videoclips	
Betrachten von Bildern und Videoclips.....	17
Löschen eines Bilds.....	17
5 Übertragen und Drucken von Bildern	
Übertragen von Bildern.....	18
Drucken von Bildern von der Kamera aus.....	19
6 Kurzreferenz für Kamerafunktionen.....	21

1 Erste Schritte

Diese gedruckte Kurzeinführung enthält alle notwendigen Informationen zur erstmaligen Verwendung der grundlegenden Funktionen der Kamera. Im elektronischen Benutzerhandbuch finden Sie detaillierte Informationen zu den Funktionen der Kamera (siehe „Zugreifen auf das elektronische Benutzerhandbuch“ auf Seite 5).

Kurzeinführung	Elektronisches Benutzerhandbuch
<p>Dieses gedruckte Handbuch behandelt folgende Themen:</p> <ul style="list-style-type: none">• Schnelle Inbetriebnahme der Kamera• Installieren der HP Photosmart-Software• Vorstellung der grundlegenden Kamerafunktionen	<p>Das elektronische Benutzerhandbuch behandelt folgende Themen:</p> <ul style="list-style-type: none">• Beschreibungen aller Kamerafunktionen• Informationen zu Batterien/Akkus, einschließlich:<ul style="list-style-type: none">• Verlängerung der Akku-/Batteriebetriebsdauer• Beschreibung der Stromversorgungssymbole• Fehlerbehebung• Unterstützung durch HP• Technische Daten der Kamera

Zugreifen auf das elektronische Benutzerhandbuch



Das elektronische Benutzerhandbuch befindet sich auf der HP Photosmart Software CD.

So zeigen Sie das Benutzerhandbuch an:

1. Legen Sie die HP Photosmart Software CD in das CD-Laufwerk Ihres Computers ein.
2. Klicken Sie auf der Hauptseite der Installationsanzeige auf **Benutzerhandbuch anzeigen**.

Das elektronische Benutzerhandbuch wird auf Ihren Computer kopiert, wenn Sie die HP Photosmart-Software installieren. Gehen Sie wie folgt vor, um sich das Benutzerhandbuch nach dessen Installation auf dem Computer anzeigen zu lassen:

- **Windows:** Öffnen Sie **HP Solution Center**, und klicken Sie auf die Hilfe.
- **Unter Macintosh:** Öffnen Sie den **HP Geräte-Manager**, und wählen Sie **Kamera-Benutzerhandbuch** im Popup-Menü **Informationen und Einstellungen** aus.

Unterstützung







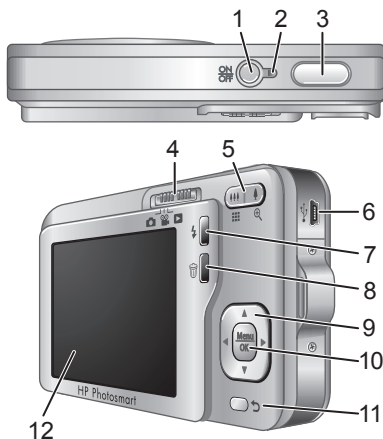







- Tipps und Tools zur effizienten Nutzung der Kamera finden Sie unter **www.hp.com**. Klicken Sie hier auf **Learn About: Digital Photography** (nur in englischer Sprache).
- Weitere Informationen zum Produktsupport einschließlich Firmware-, Software- und Treiberaktualisierungen finden Sie unter **www.hp.com/support**.

- Weitere Informationen zur HP Photosmart-Software finden Sie in der Onlinehilfe für die Software.

Ober- und Rückseite sowie Seitenfläche der Kamera



1	Taste ON/OFF
2	Netzkontrollleuchte
3	Auslöser
4	Wahlschalter - Dient zum Wechseln zwischen den Modi Bild aufnehmen , Video aufnehmen und Wiedergabe (siehe „Bildaufnahme, Videoaufnahme und Wiedergabe“ auf Seite 21).
5	Zoomhebel (digital und optisch) - Dient zum Zugriff auf die Zoom -Funktion, wenn sich die Kamera

	im Modus  Bild aufnehmen oder  Video aufnehmen befindet; dient zum Zugriff auf die Funktionen  Miniaturansicht und  Vergrößern , wenn sich die Kamera im Modus  Wiedergabe befindet.
6	USB-Anschluss
7	 Blitztaste - Dient zum Zugriff auf die Blitzeinstellungen, wenn sich die Kamera im Modus  Bild aufnehmen befindet. Folgende Einstellungen sind möglich: Autom. Blitz, Rote Augen, Blitz ein und Blitz aus.
8	Taste  Löschen - Dient zum Zugriff auf die Funktion Löschen im Modus  Wiedergabe .
9	Tasten   und   - Dienen zum Blättern durch Menüs und Bilder.
10	Taste  - Dient zum Anzeigen von Kameramenüs, Auswählen von Optionen und Bestätigen von Aktionen.
11	Taste  Zurück - Dient zum Zurückkehren zum vorherigen Menü oder zur vorherigen Ansicht. Halten Sie die Taste gedrückt, um alle Menüs zu verlassen.
12	Bildanzeige

Vorder- und Unterseite der Kamera

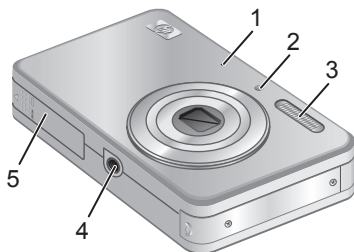

1	Mikrofon
2	Selbstauslöser/Fokus-Hilfslicht
3	Blitz
4	Stativhalterung
5	Klappe des Batterie-/Speicherkartenfachs

2 Einrichten Ihrer Kamera

Aufladen der Akkus

Laden Sie den Akku vollständig auf, bevor Sie diesen zum ersten Mal verwenden. Verwenden Sie dazu das Ladegerät, das mit der Kamera geliefert wurde.

 **Hinweis** Ihre Kamera funktioniert mit aufladbaren HP Photosmart LI40-Akkus (Q6277A). Laden Sie keine anderen Akkus mit dem Ladegerät auf.

1. Schließen Sie das Ladegerät an eine Netzsteckdose an, und setzen Sie dann den Akku wie dargestellt in das Ladegerät ein.

Während der Akku aufgeladen wird, leuchtet die Ladekontrollleuchte des Ladegeräts orangefarben; wenn die Kontrollleuchte grün leuchtet, ist der Akku vollständig aufgeladen (nach ca. 1,5 Std.).

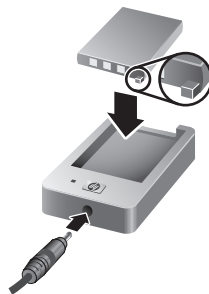

2. Nehmen Sie den Akku aus dem Ladegerät, sobald er vollständig aufgeladen ist.

Einsetzen der Akkus

1. Öffnen Sie die Klappe des Batterie-/Speicherkartenfachs, indem Sie die Verriegelung wie auf der Klappe dargestellt verschieben.
2. Setzen Sie den Akku in das größere Fach ein, und schieben Sie ihn hinein, bis die Verriegelung greift.



3. Schließen Sie die Klappe des Batterie-/Speicherkartenfachs.

Drücken Sie zum Herausnehmen des Akkus auf die Batterieverriegelung, bis der Akku herauspringt.

Einschalten der Kamera

Drücken Sie zum Einschalten der Kamera die Taste ON/OFF.

Auswählen der Sprache

Mit den Tasten ▲▼ ◀▶ wählen Sie die gewünschte Sprache aus. Drücken Sie anschließend die Taste ^{Menu}OK.

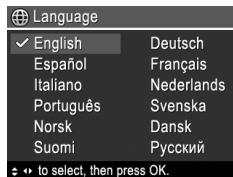

Einstellen der Region

Das Standarddatumsformat wird neben der Einstellung für die Sprache auch durch die Einstellung für die Region festgelegt.

Mit den Tasten ▲▼ wählen Sie die gewünschte Region aus.

Drücken Sie danach die Taste ^{Menu}OK.

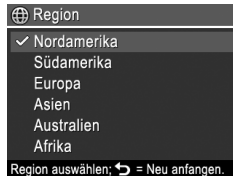

Einstellen von Datum und Uhrzeit

Eine genaue Einstellung des Datums und der Uhrzeit hilft Ihnen später, Bilder wieder zu finden, nachdem diese auf Ihren Computer übertragen wurden. Darüber hinaus wird so sichergestellt, dass die Bilder richtig gekennzeichnet

werden, wenn Sie die Funktion „Datums-/Zeitstempel“ verwenden.

1. Mit den Tasten ▲▼ passen Sie den jeweils markierten Wert an.
2. Mit den Tasten ◀▶ wechseln Sie zu den anderen Auswahlmöglichkeiten. Wiederholen Sie danach Schritt 1, bis das Datum und die Uhrzeit korrekt eingestellt sind.
3. Drücken Sie die Taste Menu / OK , sobald das Datum, die Uhrzeit und die Formateinstellungen korrekt sind. Drücken Sie danach erneut die Taste Menu / OK , um die Einstellungen zu bestätigen.

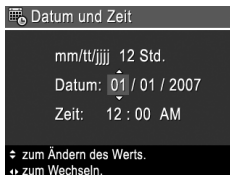

Einsetzen und Formatieren einer optionalen Speicherkarte

Diese Kamera unterstützt Secure Digital (SD und SDHC) Speicherkarten (Standard, High Speed und High Capacity) mit 32 MB bis 8 GB.



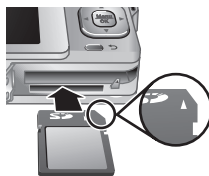











1. Schalten Sie die Kamera aus, und öffnen Sie die Klappe des Batterie-/Speicherkartenfachs.
2. Setzen Sie die optionale Speicherkarte in das kleinere Fach ein (siehe Abbildung). Stellen Sie sicher, dass die Speicherkarte einrastet.
3. Schließen Sie die Klappe des Batterie-/Speicherkartenfachs, und schalten Sie die Kamera ein.





Hinweis Wenn beim Einschalten der Kamera eine Speicherkarte eingesetzt ist, zeigt die Kamera an, wie viele Fotos sich bei der aktuellen Einstellung für die **Bildqualität** auf der Speicherkarte speichern lassen. Bei dieser Kamera können Sie maximal 2000 Bilder auf einer Speicherkarte speichern.

Formatieren Sie neue Speicherkarten stets vor dem ersten Einsatz. Durch die Formatierung werden alle Bilder von der Speicherkarte entfernt. Stellen Sie daher sicher, dass zuvor alle vorhandenen Bilder auf andere Datenträger übertragen werden.

1. Bringen Sie den Schalter    in die Position .
2. Drücken Sie die Taste , um das Untermenü  **Löschen** aufzurufen.
3. Wählen Sie mithilfe der Tasten   die Option **Speicherk. formatieren** aus. Drücken Sie danach die Taste  .
4. Wählen Sie mit den Tasten   die Option **Ja** aus. Drücken Sie danach die Taste  , um die Speicherkarte zu formatieren.

Wenn eine Speicherkarte eingesetzt ist, werden alle neuen Bilder und Videoclips nicht mehr im internen Speicher, sondern auf der Speicherkarte gespeichert.

Schalten Sie die Kamera aus, und nehmen Sie dann die Speicherkarte heraus, um den internen Speicher zu verwenden und alle dort gespeicherten Bilder anzuzeigen.

Installieren der Software

Die HP Photosmart-Software bietet Funktionen zum Übertragen von Bildern und Videoclips auf Ihren Computer sowie zum Bearbeiten gespeicherter Bilder

(u. a. Rote Augen entfernen, Drehen, Zuschneiden und Größe ändern).

Um die HP Photosmart-Software installieren zu können, muss Ihr Computer die Systemvoraussetzungen erfüllen, die auf der Verpackung der Kamera angegeben sind. Weitere Informationen zur Unterstützung Ihrer Kamera durch Windows Vista finden Sie unter **www.hp.com/go/windowsvista** (nur in englischer Sprache).

Sollten bei der Installation oder der Verwendung der HP Photosmart-Software Probleme auftreten, lesen Sie die Informationen auf der Website des technischen Supports von Hewlett-Packard unter **www.hp.com/support**.

Windows

1. Schließen Sie alle Programme, und deaktivieren Sie vorübergehend sämtliche Virenschutzsoftware.
2. Legen Sie die HP Photosmart Software CD in das CD-Laufwerk ein, und befolgen Sie die angezeigten Anweisungen. Wenn das Installationsfenster nicht angezeigt wird, klicken Sie auf **Start** und **Ausführen**. Geben Sie dann **D:\Setup.exe** ein (wobei **D** für den Buchstaben Ihres CD-Laufwerks steht). Klicken Sie danach auf **OK**.
3. Nach erfolgreicher Installation der Software müssen Sie die Virenschutzsoftware wieder aktivieren.

Macintosh

1. Legen Sie die HP Photosmart Software CD in das CD-Laufwerk ein.
2. Doppelklicken Sie auf dem Desktop auf das CD-Symbol.

3. Doppelklicken Sie auf das Symbol des Installationsprogramms, und befolgen Sie die angezeigten Anweisungen.





Nach Abschluss der Installation und Neustart des Computers wird automatisch das Fenster **Systemeinstellungen** angezeigt. Dieses Fenster enthält die Einstellungen für die **HP Photosmart-Kamera**. Sie können die Einstellungen so ändern, dass die HP Photosmart-Software automatisch gestartet wird, wenn Sie Ihre Kamera an den Macintosh anschließen. (Klicken Sie für weitere Informationen zu diesem Thema im Dialogfenster mit den Einstellungen für die HP Photosmart-Kamera auf die Option **Hilfe**.)

3 Aufnahmen von Bildern und Videoclips

Bringen Sie den Schalter    in die Position  oder , um Bilder oder Videoclips aufzunehmen.

Aufnehmen von Bildern

Sie können ein Bild aufnehmen, wenn sich die Kamera im Modus  **Bild aufnehmen** befindet.



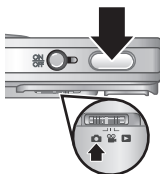

1. Bringen Sie den Schalter    in die Position .
2. Erfassen Sie das Motiv mit der Bildanzeige.
3. Drücken Sie den **Auslöser** halb herunter, um Belichtung und Fokus zu sperren. Die Fokusklammern in der Bildanzeige werden grün angezeigt, sobald der Fokus gesperrt ist.
4. Drücken Sie den **Auslöser** ganz herunter, um das Bild aufzunehmen.





Nach dem Aufnehmen eines Bilds erscheint dies kurz in der Bildanzeige.

Aufnehmen eines Videoclips

Sie können einen Videoclip aufnehmen, wenn sich die Kamera im Modus  **Video aufnehmen** befindet.

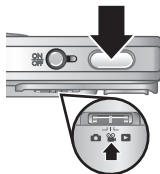
1. Bringen Sie den Schalter    in die Position .
2. Erfassen Sie das Motiv mit der Bildanzeige.











- 
- 
3. Drücken Sie den **Auslöser** zur Hälfte herunter, um den Fokus und die Belichtung zu messen. Die Fokuskammern in der Bildanzeige werden grün angezeigt, sobald der Fokus gesperrt ist.
 4. Drücken Sie den **Auslöser** ganz herunter, und lassen Sie diesen wieder los, um mit der Videoaufnahme zu beginnen.
 5. Drücken Sie erneut den **Auslöser** und lassen sie wieder los, um die Videoaufnahme anzuhalten.

Nach Aufnahme eines Videoclips erscheint dieser kurz in der Bildanzeige.

4 Betrachten und Löschen von Bildern und Videoclips

Betrachten von Bildern und Videoclips













Im Modus  **Wiedergabe** können Sie Bilder und Videoclips betrachten.

1. Bringen Sie den Schalter    in die Position .
2. Blättern Sie mit den Tasten   durch Ihre Bilder und Videoclips. Drücken Sie zum Abspielen eines Videoclips die , sobald das erste Bild des Videoclips in der Bildanzeige erscheint.

 **Hinweis** Wenn Sie auch den Ton von Videoclips hören möchten, übertragen Sie die Videoclips auf Ihren Computer.

Löschen eines Bilds

Im Modus  **Wiedergabe** können Sie Einzelbilder wie folgt löschen:

1. Bringen Sie den Schalter    in die Position .
2. Wählen Sie mit den Tasten   ein Bild oder einen Videoclip aus.
3. Drücken Sie die Taste , um das Untermenü  **Löschen** aufzurufen.
4. Wählen Sie mit den Tasten   die Option **Dieses Bild** aus. Drücken Sie danach die Taste  .

5 Übertragen und Drucken von Bildern

Übertragen von Bildern

Mit den folgenden Arbeitsschritten verschieben Sie Bilder und Videoclips auf Ihren Computer.

 **Hinweis** Wenn Sie eine große Anzahl an Bildern mit einer hohen Auflösung von einer Speicherkarte auf den Computer übertragen, kann dies bis zu zwei Stunden dauern. Wenn Sie viele Bilder übertragen, müssen die Akkus/die Batterien der Kamera vollständig aufgeladen sein. Alternativ dazu können Sie auch ein optionales Speicherkartenlesegerät verwenden.

1. Schalten Sie die Kamera aus, und schließen Sie diese mithilfe des USB-Kabels, das mit der Kamera geliefert wurde, an den Computer an.
2. Schalten Sie die Kamera ein. Wenn auf der Bildanzeige darauf hingewiesen wird, dass die Kamera mit dem Computer verbunden ist, befolgen Sie die Anweisungen auf dem Computerbildschirm, um die Bilder zu übertragen. Wenn die HP Photosmart-Software installiert ist und Sie weitere Informationen benötigen, lesen Sie die Informationen in der Hilfe der HP Photosmart-Software.

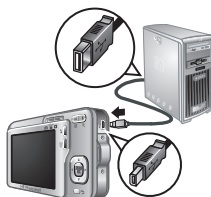

Drucken von Bildern von der Kamera aus

Sie können die Kamera zum Drucken von Bildern an einen beliebigen PictBridge-kompatiblen Drucker anschließen.



1. Vergewissern Sie sich, dass der Drucker eingeschaltet ist. Darüber hinaus muss Papier im Drucker eingelegt sein, und es dürfen keine Meldungen in Bezug auf Druckerfehler angezeigt werden.

2. Schalten Sie die Kamera aus, und schließen Sie die Kamera dann mithilfe des USB-Kabels, das mit der Kamera geliefert wurde, an den Drucker an.

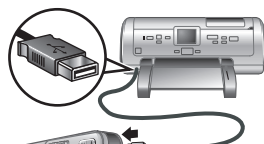

3. Schalten Sie die Kamera ein.



4. Wenn die Kamera mit dem Drucker verbunden ist, erscheint in der Bildanzeige ein Bild. Wählen Sie mit den Tasten ◀ ▶ das zu druckende Bild aus.

5. Drücken Sie die Taste ^{Menu} _{OK} .

6. Wählen Sie im Menü **Druckoptionen** die Option **Dieses Bild jetzt drucken aus**, um den Druckvorgang zu starten.

Das Symbol  erscheint in der Bildanzeige auf dem ausgewählten Bild. Dies zeigt an, dass das Bild gedruckt wird.

7. Trennen Sie die Kamera nach Drucken des Bilds vom Drucker.

Weitere Informationen zu den anderen Druckoptionen finden Sie im elektronischen Benutzerhandbuch oder in der **? Kamerahilfe**, auf die Sie in allen Menüs zugreifen können.

Deutsch



















20

HP Photosmart R740-Digitalkameraserie

6 Kurzreferenz für Kamerafunktionen



Das folgende Kapitel dient als Kurzreferenz für die Kamerafunktionen. Weitere Informationen zu diesen Kamerafunktionen finden Sie im elektronischen Benutzerhandbuch oder in der Onlinehilfe der Kamera.

Bildaufnahme, Videoaufnahme und Wiedergabe





- Im Modus  **Bild aufnehmen** können Sie Bilder mit der Bildanzeige erfassen und aufnehmen. Aktivieren Sie den Modus  **Bild aufnehmen**, indem Sie den Wahlschalter    in die Position  bringen.
- Im Modus  **Video aufnehmen** können Sie Videoszenen mit der Bildanzeige erfassen und Videoclips aufnehmen. Aktivieren Sie den Modus  **Video aufnehmen**, indem Sie den Wahlschalter    in die Position  bringen.
- In der  **Wiedergabe** können Sie Bilder und Videoclips anzeigen und löschen. Aktivieren Sie die  **Wiedergabe**, indem Sie den Wahlschalter    in die Position  bringen.

Kameramenüs







Mit diesen Menüs können Sie Kameraeinstellungen anpassen, mit Bildern arbeiten und auf die Kamerahilfe zugreifen.

- Innerhalb eines Menüs können Sie mithilfe der Tasten   spezifische Optionen auswählen.
- Zum Beenden eines Menüs können Sie jederzeit die Taste  drücken.







 **Menü „Bild aufnehmen“** - Dient zum Anpassen der Kameraeinstellungen, die sich auf die Eigenschaften der

Bilder auswirken, die Sie danach mit der Kamera aufnehmen. Greifen Sie auf dieses Menü zu, indem Sie den Wahlschalter    in die Position  bringen. Drücken Sie dann die Taste . Sie können eine der folgenden Optionen auswählen:

- Aufnahmemodus (Autom., Nahaufnahme, Stabile Aufnahme, Theater, Landschaft, Portrait, Action, Nachtportrait, Sonnenuntergang)
- Selbstauslöser
- Bildqualität
- Burst
- Datums-/Zeitstempel
- Kameraeinstellungen
- Kamerahilfe







Menü  **Video aufnehmen** - Dient zum Anpassen der Kameraeinstellungen, die sich auf die Eigenschaften der Videoclips auswirken, die Sie danach mit der Kamera aufnehmen. Greifen Sie auf dieses Menü zu, indem Sie den Wahlschalter    in die Position  bringen. Drücken Sie dann die Taste . Sie können eine der folgenden Optionen auswählen:

- Selbstauslöser
- Kameraeinstellungen
- Kamerahilfe





 **Menü „Wiedergabe“** - Dient zum Arbeiten mit Bildern. Greifen Sie auf dieses Menü zu, indem Sie den Wahlschalter    in die Position  bringen. Drücken Sie dann die Taste . Sie können eine der folgenden Optionen auswählen:

- Rote Augen entfernen

- Design-Galerie (Farbe ändern, Ränder hinzufügen, Drehen, Zuschneiden)
- Photosmart Express (Drucken, Share, Abzüge online kaufen)
- Favoriten
- Diashow anzeigen
- Bilder auf Karte verschieben
- Kameraeinstellungen
- Kamerahilfe

Menü  **Kameraeinstellungen** - Hier können Sie Änderungen am Kameraverhalten einstellen. Greifen Sie auf dieses Menü zu, indem Sie die Taste  drücken, wenn sich die Kamera im Modus ,  oder  befindet. Wählen Sie danach die Option  **Kameraeinstellungen** aus. Sie können eine der folgenden Optionen auswählen:

- Anzeigehelligkeit
- Kameratöne
- Datum/Zeit
- USB-Konfiguration
- Language (Sprache)

? Menü „Kamerahilfe“ - Enthält Beschreibungen der Kamerafunktionen und Tipps zum Aufnehmen von Bildern. Greifen Sie auf dieses Menü zu, indem Sie die Taste  drücken, wenn sich die Kamera im Modus ,  oder  befindet. Wählen Sie danach die Option **? Hilfe** aus. Sie können eine der folgenden Optionen auswählen:

- Top Ten-Tipps
- Kamerazubehör

- Kameratasten
- Aufnahmemodi verwenden
- Design-Galerie verwenden
- Photosmart Express verwenden
- Bilder drucken
- Videoclips aufnehmen
- Bilder und Video anzeigen
- Bilder kennzeichnen
- Bilder löschen
- Bilder übertragen
- Batterie-Management
- Unterstützung
- Kamerafunktionen kennen lernen
- Kamera-Kurztasten
- Info

Cámara digital HP Photosmart serie R740

Español



i n v e n t

Información legal y advertencias

© Copyright 2007 Hewlett-Packard Development Company, L.P.

La información que aparece en este documento está sujeta a cambios sin previo aviso. Las únicas garantías de los productos y servicios de HP se detallan en las declaraciones de garantía expresa que acompañan a dichos productos y servicios. Nada de lo que aquí se incluya se considerará como garantía adicional. HP no se hará responsable de los errores u omisiones técnicos o editoriales aquí contenidos.

Windows® es una marca registrada de Microsoft Corporation.



El logotipo SD es una marca comercial de su propietario.



Eliminación de desechos de equipamiento por parte de usuarios en domicilios particulares dentro de la Unión Europea:

Este símbolo en el producto o en su embalaje indica que no debe desecharlo con el resto de la basura de su domicilio. Bajo su responsabilidad, debería deshacerse de los desechos de equipamiento llevándolos a un punto de reciclaje de material eléctrico y equipos electrónicos. La recolección y reciclaje por separado de los desechos de equipamiento ayudará a conservar los recursos naturales y asegurará que se recicle de forma que proteja la salud y el medioambiente. Para más información acerca de dónde puede reciclar estos desechos, póngase en contacto con su ayuntamiento, con el servicio de eliminación de desechos o recogida de basuras, o con la tienda donde adquirió el producto.

Introduzca la siguiente información para referencias futuras:

- Número de modelo: _____
- Número de serie: _____
- Fecha de compra: _____

Contenido

1 Procedimientos iniciales	
Acceso a la Guía del usuario electrónica.....	5
Partes superior, lateral y posterior de la cámara	6
Partes frontal e inferior de la cámara.....	7
2 Instalación de la cámara	
Carga de la pila.....	9
Instalación de la pila.....	9
Encendido de la cámara.....	10
Elección del idioma.....	10
Selección de la región.....	10
Ajuste de la fecha y la hora.....	10
Instalación y formateo de una tarjeta de memoria opcional.....	11
Instalación del software.....	12
Windows.....	13
Macintosh.....	13
3 Toma de imágenes y grabación de videoclips	
Captura de una imagen.....	14
Grabación de un videoclip.....	14
4 Revisión y eliminación de imágenes y videoclips	
Revisión de imágenes y videoclips.....	16
Eliminación de una imagen.....	16
5 Transferencia e impresión de imágenes	
Transferencia de imágenes.....	17
Impresión de imágenes desde la cámara.....	17
6 Referencia rápida de la cámara.....	19

1 Procedimientos iniciales

Esta Guía de comienzo rápido proporciona la información necesaria para empezar a utilizar las funciones básicas de su cámara. Si desea información detallada sobre las funciones de la cámara, consulte la Guía del usuario electrónica (consulte *Acceso a la Guía del usuario electrónica* en la página 5).

Guía de comienzo rápido	Guía del usuario electrónica
<p>Esta guía impresa le ayudará a:</p> <ul style="list-style-type: none">• Empezar a utilizar la cámara rápidamente• Instalar el software HP Photosmart• Conocer las funciones básicas de su cámara	<p>La Guía del usuario electrónica incluye:</p> <ul style="list-style-type: none">• Descripciones de todas las funciones de la cámara• Información sobre la pila, como:<ul style="list-style-type: none">• Prolongación de la duración de la pila• Una descripción de los iconos del indicador de alimentación• Resolución de problemas• Obtención de asistencia de HP• Especificaciones de la cámara

Acceso a la Guía del usuario electrónica



La Guía del usuario electrónica está en el disco HP Photosmart Software CD.

Para ver la Guía del usuario:

1. Introduzca el HP Photosmart Software CD en la unidad de CD-ROM del equipo.
2. Haga clic en **Ver Guía del usuario** en la página principal de la pantalla de instalación.

También se guarda en su equipo la Guía del usuario electrónica al instalar el software HP Photosmart. Para ver la Guía del usuario tras instalarla en el equipo.

- **En Windows:** Abra el **Centro de soluciones HP** y haga clic en la ayuda.
- **En Macintosh:** Abra el **Administrador de dispositivos HP** y seleccione **Guía del usuario de la cámara** en el menú emergente **Información y configuración**.







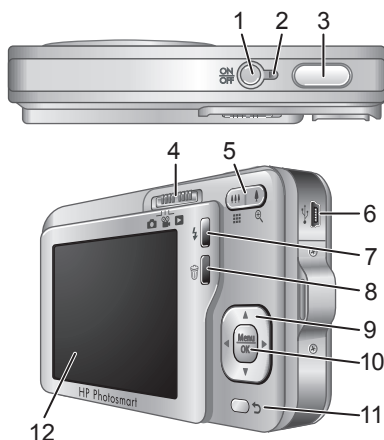



Obtención de asistencia

- Para ver sugerencias y herramientas que le ayuden a hacer un uso más efectivo de la cámara, visite **www.hp.com**. Desde allí, haga clic en **Learn About: Digital Photography** (sólo en inglés).
- Para obtener asistencia sobre productos, incluido firmware, software y actualizaciones de controladores, visite **www.hp.com/support**.
- Para obtener ayuda del software HP Photosmart, consulte la ayuda en línea.

Partes superior, lateral y posterior de la cámara



1	Botón ON/OFF.
2	Indicador luminoso de alimentación.
3	Botón del Disparador .
4	Selector : para cambiar entre Captura de imágenes , Grabación de vídeo y Reproducción (consulte <i>Captura de imágenes</i> , <i>Grabación de vídeo</i> y <i>Reproducción</i> en la página 19).
5	Palanca de Zoom (digital y óptico): da acceso a / Zoom mientras se encuentra en Captura de imágenes o Grabación de vídeo ; da acceso a Viñetas y a Ampliar mientras se encuentra en Reproducción .

6	Conector USB.
7	 Botón Flash : da acceso a los ajustes de flash desde el modo  Captura de imágenes . Los ajustes son Automático, Ojos rojos, Flash encendido, Flash apagado.
8	 Botón Eliminar : da acceso a la función Eliminar desde el modo  Reproducción .
9	Botones   y   : para desplazarse por las viñetas.
10	 <small>Menu</small> <small>OK</small> : muestra los menús de la cámara, selecciona opciones y confirma acciones.
11	 Botón Atrás : regresa a un menú o una vista anterior. Manténgalo presionado para retroceder por todos los menús.
12	Pantalla de imagen.

Partes frontal e inferior de la cámara

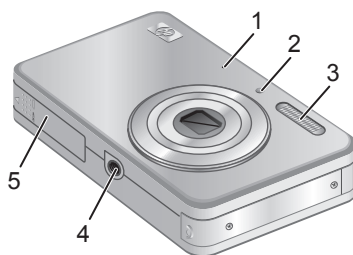

1	Micrófono.
---	------------

2	Indicador luminoso de temporizador automático/ ayuda de enfoque.
3	Flash.
4	Soporte para trípode.
5	Puerta de la pila/tarjeta de memoria.

2 Instalación de la cámara

Carga de la pila

Antes de usar la pila por primera vez, cárguela por completo mediante el cargador que se suministra con la cámara.

 **Nota** La cámara utiliza una pila recargable HP Photosmart LI40 (Q6277A). No cargue ninguna otra pila en el cargador.

1. Conecte el cargador a una toma de corriente e introduzca la pila en el cargador tal y como se muestra a continuación.

La luz del cargador que indica que la pila se está cargando se ilumina en naranja mientras se carga la pila; la pila está totalmente cargada cuando la luz se ilumina en verde (aproximadamente 1,5 horas).

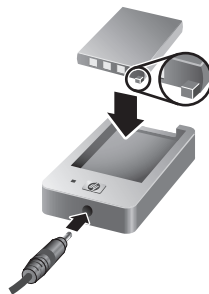

2. Retire la pila del cargador una vez que se cargue por completo.

Instalación de la pila

1. Abra la puerta de la pila/tarjeta de memoria deslizando el cierre tal y como se indica en la puerta.
2. Inserte la pila en la ranura más grande, empujándola hasta que el cierre quede enganchado.
3. Cierre la puerta de la pila/tarjeta de



memoria.

Para extraer la pila, desplace el cierre tal y como se muestra hasta que se suelte la pila.

Encendido de la cámara

Para encender la cámara, presione el botón ON/OFF.

Elección del idioma

Utilice ▲▼ y ◀▶ para elegir el idioma que desea y presione

Menu
OK .

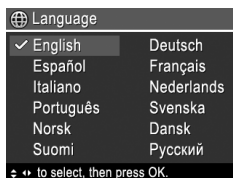

Selección de la región

Junto con el Idioma, el ajuste Región determina el formato de fecha predeterminado.

Utilice ▲▼ para elegir la región que desea y presione Menu OK .



Ajuste de la fecha y la hora

El ajuste preciso de la fecha y la hora le ayudará a localizar las imágenes una vez transferidas al equipo y le garantizará que las imágenes están correctamente

marcadas si utiliza la función de estampado de fecha y hora.

1. Utilice ▲▼ para ajustar el valor seleccionado.
2. Utilice ◀▶ para desplazarse a las otras selecciones y repita el Paso 1 hasta que la fecha y hora sean correctas.
3. Presione $\frac{\text{Menu}}{\text{OK}}$ cuando la fecha, hora y los ajustes de formato sean correctos y vuelva a presionar $\frac{\text{Menu}}{\text{OK}}$ para confirmarlo.

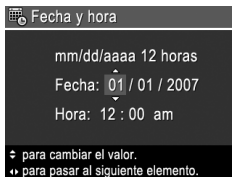

Instalación y formateo de una tarjeta de memoria opcional





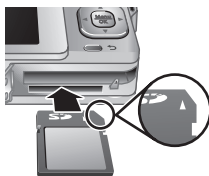







La cámara admite tarjetas de memoria Secure Digital estándar, de alta velocidad y de gran capacidad (SD y SDHC), de 32 MB a 8 GB.

1. Apague la cámara y abra la puerta de la pila/tarjeta de memoria.
2. Inserte la tarjeta de memoria opcional en la ranura más pequeña como se indica. Asegúrese de que encaja en su sitio.
3. Cierre la puerta y encienda la cámara.



 **Nota** Cuando se enciende la cámara con una tarjeta de memoria instalada, el dispositivo indica el número de imágenes que se pueden guardar en la tarjeta de memoria con el ajuste **Calidad de imagen** actual. Esta cámara puede guardar un máximo de 2.000 imágenes en una tarjeta de memoria.

Siempre se deben formatear las tarjetas de memoria nuevas antes de utilizarlas por primera vez. Al hacerlo, se eliminan todas las imágenes de la tarjeta. Asegúrese de transferir las imágenes que desee antes de formatear la tarjeta.

1. Con la cámara encendida, deslice   a .
2. Presione  para mostrar el menú  **Eliminar**.
3. Utilice   para seleccionar **Formatear tarjeta** y presione  .
4. Utilice   para seleccionar **Sí** y presione   para formatear la tarjeta.

Una vez instalada una tarjeta de memoria, se guardarán todas las imágenes y los videoclips nuevos en esa tarjeta, en lugar de almacenarlos en la memoria interna.

Para utilizar la memoria interna de la cámara y ver las imágenes guardadas en ella, apague la cámara y extraiga la tarjeta de memoria.

Instalación del software

El software HP Photosmart proporciona funciones para transferir imágenes y videoclips al equipo, además de funciones para modificar las imágenes almacenadas (suprimir ojos rojos, rotar, recortar, redimensionar, etc.).

Para instalar el software HP Photosmart, su equipo debe cumplir los requisitos del sistema tal y como se indica en el envoltorio de la cámara. Para averiguar si su cámara admite Windows Vista, consulte www.hp.com/go/windowsvista (sólo en inglés).

Si tiene dificultades para instalar o utilizar el software HP Photosmart, encontrará más información en el sitio Web de asistencia técnica de Hewlett-Packard: www.hp.com/support.

Windows

1. Cierre todos los programas y deshabilite temporalmente todo el software de protección contra virus.
2. Inserte HP Photosmart Software CD en la unidad de CD y siga las instrucciones en pantalla. Si no se abre la pantalla de instalación, en el menú **Inicio**, haga clic en **Ejecutar** y escriba **D:\Setup.exe**, donde **D** es la letra de la unidad de CD-ROM y, a continuación, haga clic en **Aceptar**.
3. Cuando se haya instalado el software, vuelva a habilitar el software de protección contra virus.

Macintosh

1. Inserte HP Photosmart Software CD en la unidad de CD.
2. Haga doble clic en el icono del CD en el escritorio del equipo.
3. Haga doble clic en el icono del instalador y, a continuación, siga las instrucciones mostradas en la pantalla.

Cuando haya finalizado la instalación y se haya reiniciado el equipo, se abrirán automáticamente las **Preferencias del sistema** con los ajustes de la **Cámara HP Photosmart**. Puede cambiar los ajustes para que el software HP Photosmart se inicie automáticamente cuando conecte la cámara a su equipo Macintosh (para obtener más información, haga clic en el botón de ayuda del cuadro de diálogo de los ajustes de la **Cámara HP Photosmart**).

3 Toma de imágenes y grabación de videoclips

Deslice a para tomar fotografías o a para grabar videoclips.

Captura de una imagen

Puede tomar una fotografía mientras está seleccionado el modo **Captura de imágenes**.

1. Deslice a .
2. Encuadre en la pantalla de imagen el sujeto que desee fotografiar.
3. Presione el botón del **Disparador** hasta la mitad de su recorrido para medir y bloquear el enfoque y la exposición. Los delimitadores de enfoque de la pantalla de imagen cambian a verde cuando el enfoque está bloqueado.
4. Presione el botón del **Disparador** hasta el final para tomar la imagen.

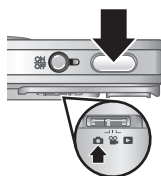

Después de tomar una fotografía, la cámara la muestra brevemente en la pantalla de imagen.

Grabación de un videoclip

Puede grabar un vídeo mientras está seleccionado el modo **Grabación de vídeo**.

1. Deslice a .
2. Encuadre en la pantalla de imagen el sujeto que desee fotografiar.

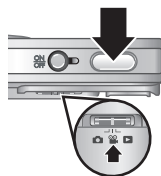









3. Presione el botón del **Disparador** hasta la mitad de su recorrido para medir el enfoque y la exposición. Los delimitadores de enfoque de la pantalla de imagen cambian a verde cuando el enfoque está bloqueado.
4. Presione el botón del **Disparador** hasta el fondo y suéltelo para empezar a grabar el vídeo.
5. Para detener la grabación del vídeo, presione y suelte el botón del **Disparador** nuevamente.

Después de grabar un videoclip, la cámara lo muestra brevemente en la pantalla de imagen.

4 Revisión y eliminación de imágenes y videoclips

Revisión de imágenes y videoclips











Puede examinar imágenes y videoclips en el modo de  **Reproducción**.

1. Deslice    a .
2. Utilice   para desplazarse por las imágenes o los videoclips. Para reproducir un videoclip, presione  cuando en la pantalla de imagen aparezca la primera imagen del clip.

 **Nota** Para escuchar el audio asociado a los videoclips, transfíralos a su equipo.

Eliminación de una imagen

Puede eliminar imágenes individuales durante la  **Reproducción**:

1. Deslice    a .
2. Utilice   para seleccionar una imagen o un videoclip.
3. Presione  para mostrar el menú  **Eliminar**.
4. Utilice   para seleccionar **Esta imagen** y presione

Menu
OK



5 Transferencia e impresión de imágenes

Transferencia de imágenes

Siga este procedimiento para transferir imágenes y videoclips al equipo.

 **Nota** La transferencia de un gran número de imágenes de alta resolución de una tarjeta de memoria al equipo puede llevar hasta dos horas. Si tiene que transferir un gran número de imágenes, asegúrese de que las pilas de la cámara están totalmente cargadas o utilice un lector de tarjeta de memoria opcional.

1. Apague la cámara y conéctela al equipo mediante el cable USB incluido con la cámara.
2. Encienda la cámara. Cuando la pantalla de imagen indique que la cámara está conectada al equipo, siga las instrucciones que aparecen en la pantalla del equipo para transferir las imágenes. Si ha instalado el software HP Photosmart y necesita más información, consulte la Ayuda del software HP Photosmart.

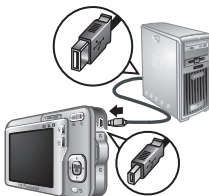

Impresión de imágenes desde la cámara

Puede conectar la cámara a cualquier impresora compatible con PictBridge para imprimir imágenes.



1. Compruebe que la impresora esté



encendida, que hay papel y que no hay mensajes de error en la impresora.

2. Apague la cámara y conéctela a la impresora mediante el cable USB incluido con la cámara.
3. Encienda la cámara.
4. La pantalla de imagen muestra una imagen cuando la cámara está conectada a la impresora. Utilice ◀▶ para seleccionar la imagen que desee imprimir.
5. Presione $\frac{\text{Menu}}{\text{OK}}$.
6. En el menú **Opciones de impresión**, seleccione **Imprimir esta imagen ahora** para iniciar la impresión.
 aparece en la imagen seleccionada en la pantalla de imagen para indicar que se está imprimiendo.
7. Cuando la impresora haya terminado de imprimir la imagen, desconecte la cámara de la impresora.

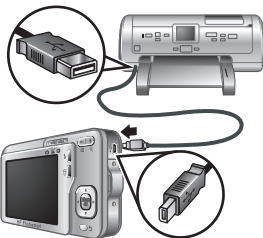



















Para obtener más información acerca de las otras opciones de impresión, consulte la Guía del usuario electrónica o bien la **? Ayuda de la cámara** en cualquiera de los menús.

6 Referencia rápida de la cámara



Utilice este capítulo como referencia rápida para las funciones de la cámara. Para obtener más información sobre estas funciones de la cámara, consulte la Guía del usuario electrónica o la Ayuda incluida en la cámara.

Captura de imágenes, Grabación de vídeo y Reproducción







-  **Captura de imágenes** le permite encuadrar imágenes en la pantalla de imagen y capturarlas. Para activar el modo  **Captura de imágenes**, deslice    a .
-  **Grabación de vídeo** le permite encuadrar vídeos en la pantalla de imagen y grabarlos. Para activar el modo  **Grabación de vídeo**, deslice    a .
-  **Reproducción** le permite examinar y eliminar imágenes y videoclips. Para activar el modo  **Reproducción**, deslice    a .

Menús de la cámara







Los menús le permiten seleccionar los ajustes de la cámara, trabajar con imágenes y acceder a la ayuda de la cámara.

- Dentro de un menú, utilice   para desplazarse a selecciones específicas.
- Para salir del menú, presione  en cualquier momento.







 **Menú Captura de imágenes:** le permite seleccionar ajustes de la cámara que afectan a las características de las futuras imágenes que capte con la cámara. Para

acceder a este menú, deslice    a , y, a continuación, presione  . Puede seleccionar las siguientes opciones:

- Modo de fotografía (Automático, Primer plano, Foto estable, Teatro, Paisaje, Retrato, Acción, Retrato nocturno, Puesta de sol)
- Temporizador automático
- Calidad imagen
- Ráfaga
- Estampado de fecha y hora
- Configuración de la cámara
- Ayuda de la cámara







 **Menú Grabación de vídeo:** le permite seleccionar ajustes de la cámara que afectan a las características de los futuros videoclips que grabe con la cámara. Para acceder a este menú, deslice    a , y, a continuación, presione  . Puede seleccionar las siguientes opciones:

- Temporizador automático
- Configuración de la cámara
- Ayuda de la cámara





 **Menú Reproducción:** le permite trabajar con imágenes. Para acceder a este menú, deslice    a , y, a continuación, presione  . Puede seleccionar las siguientes opciones:

- Eliminar ojos rojos
- Galería de diseño (Modificar el color, Agregar bordes, Rotar, Recortar)
- Photosmart Express (Imprimir, Compartir, Comprar copias en línea)

- Favoritos
- Ver presentación
- Cómo transferir imágenes a una tarjeta
- Configuración de la cámara
- Ayuda de la cámara

 **Menú Configuración de la cámara:** le permite cambiar el comportamiento de la cámara. Para acceder a este menú, presione  desde el modo , , o  y, a continuación, seleccione  **Configuración de la cámara**. Puede seleccionar las siguientes opciones:

- Brillo de pantalla
- Sonidos de cámara
- Fecha y hora
- Configuración USB
- Idioma

? Menú Ayuda de la cámara: ofrece descripciones de las funciones de la cámara y sugerencias para tomar fotografías. Para acceder a este menú, presione  desde el modo , , o  y, a continuación, seleccione **? Ayuda de la cámara**. Puede seleccionar las siguientes opciones:

- Diez mejores consejos
- Accesorios de la cámara
- Botones de la cámara
- Uso de modos de fotografía
- Uso de la Galería de diseño
- Utilización de Photosmart Express
- Impresión de imágenes
- Grabación de videoclips

- Revisión de imágenes y vídeo
- Etiquetado de imágenes
- Eliminación de imágenes
- Transferencia de imágenes
- Gestión de las pilas
- Cómo obtener asistencia
- Explicación de las funciones de la cámara
- Métodos abreviados cámara
- About (Acerca de)

HP Photosmart R740 series
digitale camera

Nederlands



i n v e n t

Wettelijke kennisgevingen

© Copyright 2007 Hewlett-Packard Development Company, L.P.

De informatie in dit document kan zonder voorafgaande kennisgeving worden gewijzigd. De enige garanties die gelden voor HP producten en diensten zijn de garanties die worden beschreven in de garantievoorwaarden behorende bij deze producten en diensten. Geen enkel onderdeel van dit document mag als extra garantie worden opgevat. HP aanvaardt geen aansprakelijkheid voor technische fouten of redactionele fouten, drukfouten of weglatingen in deze publicatie.

Windows® is een in de V.S. geregistreerd handelsmerk van Microsoft Corporation.



Het SD-logo is een handelsmerk van de desbetreffende eigenaar.



Het weggooien van apparatuur door gebruikers in privéhuishoudens in de Europese Unie

Dit symbool op het product of op de verpakking geeft aan dat dit product niet bij het gewone afval mag worden geworpen. In plaats hiervan dient u afgedankte apparatuur in te leveren bij een recycling/inzamelingspunt voor elektrische en elektronische apparatuur. De aparte inzameling en recycling van afgedankte apparatuur zorgt ervoor dat de natuurlijke hulpbronnen behouden blijven en dat de apparatuur zonder nadelige invloed op de gezondheid en het milieu voor hergebruik kan worden verwerkt. Neem contact op met de gemeentelijke reinigingsdienst of met de winkel waar u het product hebt aangeschaft voor meer informatie over locaties waar u oude apparatuur kunt achterlaten voor recycling.

Voer de volgende gegevens in als geheugensteun:

- Modelnummer: _____
- Serienummer: _____
- Datum van aanschaf: _____

Inhoudsopgave

1 Aan de slag	
De elektronische gebruikershandleiding raadplegen.....	5
Bovenkant, zijkant en achterkant van de camera.....	6
Voorkant en onderkant van de camera.....	7
2 De camera instellen	
De batterij opladen.....	9
De batterij plaatsen.....	9
De camera aanzetten.....	10
De taal kiezen.....	10
De regio instellen.....	10
Datum en tijd instellen.....	10
Een optionele geheugenkaart installeren en formateren.....	11
De software installeren.....	12
Windows.....	13
Macintosh.....	13
3 Foto's maken en videoclips opnemen	
Een foto maken.....	15
Een videoclip opnemen.....	15
4 Foto's en videoclips bekijken en verwijderen	
Foto's en videoclips bekijken.....	17
Een opname verwijderen.....	17
5 Opnames overbrengen en afdrukken	
Opnames overbrengen.....	18
Opnames afdrukken vanaf de camera.....	18
6 Beknopt overzicht van de camera	20

1 Aan de slag

Deze gedrukte introductiegids bevat de informatie die u nodig hebt om aan de slag te gaan met de voornaamste functies van uw camera. Zie de elektronische gebruikershandleiding voor gedetailleerde informatie over camerafuncties (*De elektronische gebruikershandleiding raadplegen op pagina 5*).

Introductiegids	Elektronische gebruikershandleiding
Aan de hand van deze gedrukte gids kunt u: <ul style="list-style-type: none">• Snel aan de slag gaan met uw camera• De HP Photosmart-software installeren• Vertrouwd raken met de belangrijkste functies van de camera	De elektronische gebruikershandleiding bevat: <ul style="list-style-type: none">• Beschrijvingen van alle camerafuncties• Batterijgegevens, waaronder:<ul style="list-style-type: none">• De werkingsduur van batterijen verlengen• Een beschrijving van de batterijstatus-indicators• Problemen oplossen• Hulp en ondersteuning van HP• Camerascpecificaties

De elektronische gebruikershandleiding raadplegen



U vindt de elektronische gebruikershandleiding op de HP Photosmart Software CD.

Zo kunt u de gebruikershandleiding bekijken:

1. Plaats de HP Photosmart Software CD in het cd-romstation van uw computer.
2. Klik op **Gebruikershandleiding bekijken** op de hoofdpagina van het installatiescherm.

De elektronische gebruikershandleiding wordt ook naar uw computer gekopieerd wanneer u de HP Photosmart-software installeert. Zo kunt u de gebruikershandleiding bekijken nadat deze op uw computer is geïnstalleerd:

- **In Windows:** Open **HP Solution Center** en klik op Help.
- **Macintosh:** Open **HP Apparaatbeheer** en selecteer **Gebruikershandleiding voor camera** in het pop-upmenu **Informatie en instellingen**.

Hulp en ondersteuning

- Ga naar **www.hp.com** voor tips en hulpmiddelen voor een effectiever gebruik van uw camera. Klik vervolgens op **Learn About: Digital Photography** (alleen Engels).
- Ga naar de website **www.hp.com/support** voor ondersteuning bij producten, waaronder updates van firmware, software en drivers.
- Raadpleeg de online help van de HP Photosmart-software voor hulp bij de software.

Bovenkant, zijkant en achterkant van de camera

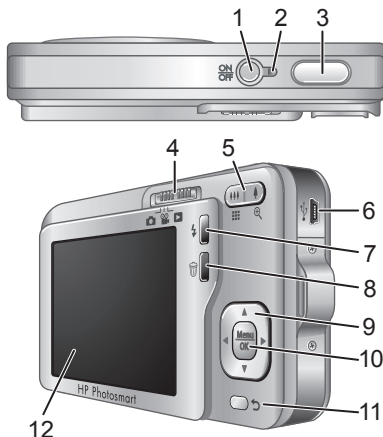

Nederlands

1	ON/OFF-knop.
2	Aan/uit-lampje.
3	Sluiterknop.
4	Schakelaar —Schakelt tussen Foto-opname , Video-opname en Weergave (zie <i>Foto-opname</i> , <i>Video-opname</i> en <i>Weergave</i> op pagina 20).
5	Knop In/Uitzoomen (digitaal en optisch)—Hiermee kunt u In/Uitzoomen terwijl de modus Foto-opname of Video-opname actief is; geeft toegang tot Miniaturen en Vergroten terwijl de modus Weergave actief is.

6	USB-aansluiting.
7	Knop Flitser —Voor het instellen van de flitser terwijl de modus Foto-opname actief is. Instellingen zijn Automatisch, Rode ogen, Flitser Aan, Flitser Uit.
8	Knop Verwijderen —Voor de functie Verwijderen in de modus Weergave .
9	Knoppen ▲▼ en ◀▶ —Voor het bladeren door menu's en opnames.
10	Knop Menu/OK —Voor het weergeven van cameramenu's, het selecteren van opties en het bevestigen van keuzen.
11	Knop Terug —Voor het terugkeren naar een vorig menu of een vorige weergave. Houd de knop ingedrukt om alle menu's te sluiten.
12	LCD-scherm.

Voorkant en onderkant van de camera

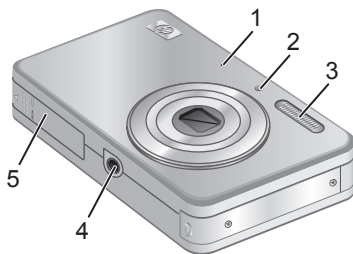

1	Microfoon.
---	------------

2	Lampje van zelfontspanner/focushulp.
3	Flitser.
4	Bevestigingspunt voor statief.
5	Klepje van vak voor batterij/geheugenkaart.

Nederlands

2 De camera instellen

De batterij opladen

Voordat u de batterij voor het eerst gebruikt, moet u deze helemaal opladen met de lader die bij de camera werd meegeleverd.

 **Opmerking** In de camera gebruikt u een oplaadbare HP Photosmart LI40-batterij (Q6277A). Laad geen andere batterijen in de lader op.

1. Sluit de lader aan op een stopcontact en plaats de batterij in de lader, zoals weergegeven.

Het batterij-oplaadlampje brandt oranje tijdens het opladen van de batterij; als het lampje groen wordt, is de batterij volledig opgeladen (dit duurt ongeveer 1,5 uur).

2. Haal de batterij uit de lader als hij helemaal is opgeladen.

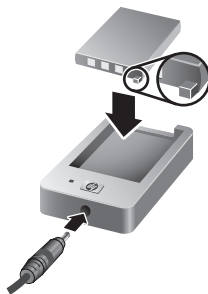

Nederlands

De batterij plaatsen

1. Open het vak voor de batterij/geheugenkaart door de vergrendeling ervan te verschuiven zoals op het klepje wordt aangegeven.
2. Plaats de batterij in de grootste sleuf en duw de batterij naar binnen totdat het ontgrendelingspalletje op zijn plaats klikt.
3. Sluit het vak voor de batterij/geheugenkaart.



U haalt de batterij uit de lader door het ontgrendelingspalletje weg te schuiven totdat de batterij los klikt.

De camera aanzetten

U zet de camera aan door op de ON/OFF-knop te drukken.

De taal kiezen

Kies de gewenste taal met ▲▼
◀▶ en druk op ^{Menu}OK.

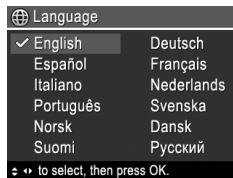

De regio instellen

De instellingen voor taal en regio bepalen samen de standaardinstelling voor de weergave van tijden en data.

Kies de gewenste regio met ▲▼ en druk op ^{Menu}OK.



Datum en tijd instellen

Als u de datum en tijd goed hebt ingesteld, kunt u uw opnames gemakkelijk terugvinden wanneer u ze naar de computer hebt overgebracht. Ook zorgt dit ervoor dat uw

foto's goed gemarkeerd worden als u datum- en tijdgegevens aan de foto's wilt toevoegen.

1. Pas de gemarkeerde waarde aan met ▲▼.
2. Ga naar de andere selecties met ◀▶ en herhaal stap 1 totdat de datum en tijd correct zijn ingesteld.
3. Druk op $\frac{\text{Menu}}{\text{OK}}$ wanneer de instellingen voor datum, tijd en indeling correct zijn. Druk vervolgens nogmaals op $\frac{\text{Menu}}{\text{OK}}$ om de keuze te bevestigen.



Een optionele geheugenkaart installeren en formatteren

Deze camera ondersteunt standaard SD-geheugenkaarten (Secure Digital) en SD-geheugenkaarten met een hoge snelheid en grote opslagcapaciteit (SDHC) van 32 MB tot 8 GB.

1. Zet de camera uit en open het vak voor de batterij/ geheugenkaart.
2. Plaats de optionele geheugenkaart in de kleinste sleuf zoals in de illustratie. Zorg ervoor dat de geheugenkaart vastklikt.
3. Sluit het vak voor de batterij/geheugenkaart en zet de camera aan.

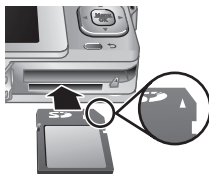

 **Opmerking** Als u de camera aanzet terwijl er een geheugenkaart is geïnstalleerd, toont de camera het aantal opnames dat u met de huidige ingestelde **Fotokwaliteit** nog op de geheugenkaart kunt opslaan. Met deze camera kunt u maximaal 2000 opnames op een geheugenkaart plaatsen.

U moet een nieuwe geheugenkaart altijd formatteren voordat u deze voor de eerste keer gebruikt. Bij het formatteren worden alle opnames van de geheugenkaart verwijderd, dus zorg ervoor dat u bestaande opnames hebt overgebracht voordat u de kaart formateert.

1. Schakel de camera in en schuif    naar .
2. Druk op  om het menu  **Verwijderen** weer te geven.
3. Selecteer met   de optie **Kaart formatteren** en druk op  .
4. Selecteer met   de optie **Ja** en druk op   om de kaart te formatteren.

Wanneer u een geheugenkaart hebt geïnstalleerd, worden alle nieuwe foto's en videoclips op de kaart opgeslagen in plaats van in het interne geheugen.

Als u het interne geheugen wilt gebruiken en opnames wilt weergeven die in het geheugen zijn opgeslagen, moet u de camera uitschakelen en de geheugenkaart verwijderen.

De software installeren

De HP Photosmart-software bevat functies voor het overbrengen van foto's en videoclips naar de computer en voor het aanpassen van opgeslagen opnames (verwijderen van rode ogen, draaien, bijsnijden, aanpassen van de grootte en meer).

Voor de installatie van HP Photosmart-software moet uw computer voldoen aan de systeemvereisten die worden vermeld op de verpakking van de camera. Informatie over ondersteuning voor uw camera in Windows Vista vindt u op www.hp.com/go/windowsvista (alleen Engels).

Als u bij het installeren of gebruiken van de HP Photosmart-software problemen ondervindt, kunt u voor meer informatie terecht op de website voor technische ondersteuning van Hewlett-Packard: www.hp.com/support.

Windows

1. Sluit alle programma's en schakel eventuele antivirussoftware tijdelijk uit.
2. Plaats de HP Photosmart Software CD in het cd-rom-station en volg de aanwijzingen op het scherm. Als het installatievenster niet verschijnt, doet u het volgende: klik op **Start** en op **Uitvoeren**, typ **D:\Setup.exe**, waarbij **D** staat voor de letter van het cd-rom-station, en klik op **OK**.
3. Wanneer de installatie van de software is voltooid, schakelt u de antivirussoftware weer in.

Macintosh

1. Plaats de HP Photosmart Software CD in het cd-rom-station.
2. Dubbelklik op het pictogram van het cd-rom-station op het bureaublad van de computer.
3. Dubbelklik op het pictogram van het installatieprogramma en volg de instructies op het scherm.

Wanneer de installatie is voltooid en u de computer opnieuw hebt opgestart, wordt automatisch het scherm **System Preferences** (Systeemvoorkeuren) geopend

met de instellingen van de **HP Photosmart-camera**. U kunt de instellingen zodanig wijzigen dat de HP Photosmart-software automatisch wordt gestart als u de camera op de Macintosh aansluit (klik voor meer informatie op de Help-knop in het dialoogvenster voor instellingen van de **HP Photosmart-camera**).

Nederlands

3 Foto's maken en videoclips opnemen

Schuif naar om foto's te maken of naar om videoclips te maken.

Een foto maken

U kunt een foto nemen als de camera zich in de modus **Foto-opname** bevindt.

1. Schuif naar .
2. Kader het onderwerp in op het LCD-scherm.
3. Druk de **sluiterknop** half in om de focus en belichting te meten en te vergrendelen. Het scherpstellingskader op het LCD-scherm wordt groen als de brandpuntafstand is vergrendeld.
4. Druk de **sluiterknop** helemaal in om de foto te maken.

Als u een foto hebt gemaakt, wordt deze kort weergegeven op het LCD-scherm.

Een videoclip opnemen

U kunt een video maken als de camera zich in de modus **Video-opname** bevindt.

1. Schuif naar .
2. Kader het onderwerp in op het LCD-scherm.

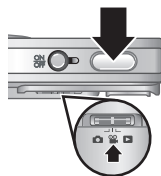
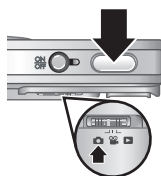

3. Druk de **sluiterknop** half in om de focus en belichting te meten. Het scherpstellingskader op het LCD-scherm wordt groen als de brandpuntsafstand is vergrendeld.
4. Druk de **sluiterknop** helemaal in en laat de knop vervolgens los om een video-opname te starten.
5. Om de opname van de video stop te zetten, drukt u de **sluiterknop** opnieuw in en laat u hem weer los.

Als u een videoclip hebt gemaakt, wordt deze kort weergegeven op het LCD-scherm.

4 Foto's en videoclips bekijken en verwijderen

Foto's en videoclips bekijken

U kunt foto's en videoclips bekijken in  **Weergave**.

1. Schuif    naar .
2. Blader met   door uw foto's en videoclips. Als u een videoclip wilt afspelen, drukt u op  wanneer het eerste beeld van de clip op het LCD-scherm te zien is.

 **Opmerking** Om het geluid dat bij de videoclips is opgenomen te kunnen horen, moet u ze naar uw computer overbrengen.

Een opname verwijderen

U kunt afzonderlijke opnames verwijderen in  **Weergave**:

1. Schuif    naar .
2. Selecteer met   een foto of videoclip.
3. Druk op  om het menu  **Verwijderen** weer te geven.
4. Selecteer met   de optie **Deze opname** en druk op  .

5 Opnames overbrengen en afdrukken

Opnames overbrengen

Met deze procedure kunt u foto's en videoclips naar uw computer overbrengen.

Nederlands

 **Opmerking** Het kan tot twee uur duren om een grote hoeveelheid opnames met hoge resolutie over te brengen van een geheugenkaart naar de computer. Zorg er bij het overbrengen van een grote hoeveelheid opnames voor dat de batterijen van de camera volledig opgeladen zijn. Gebruik anders een optioneel HP Photosmart-dock of een geheugenkaartlezer.

1. Zet de camera uit en sluit de camera en de computer op elkaar aan met de bij de camera geleverde USB-kabel.
2. Zet de camera aan. Als het LCD-scherm aangeeft dat de camera met de computer is verbonden, brengt u de opnames over aan de hand van de instructies op het computerscherm. Als u de HP Photosmart-software hebt geïnstalleerd en u hebt meer informatie nodig, raadpleegt u de Help bij de HP Photosmart-software.

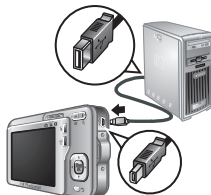

Opnames afdrukken vanaf de camera

U kunt vanaf uw camera foto's direct afdrukken op een met PictBridge compatibele printer.

1. Controleer of de printer aan staat, of er



papier in de printer is geplaatst en of er geen foutmelding op de printer wordt weergegeven.

2. Zet de camera uit en sluit de camera en de printer op elkaar aan met de bij de camera geleverde USB-kabel.

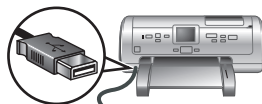

3. Zet de camera aan.

4. Als de camera met de printer is verbonden, wordt een opname weergegeven op het LCD-scherm. Selecteer met ◀▶ de opname die u wilt afdrucken.



5. Druk op $\frac{\text{Menu}}{\text{OK}}$.

6. Selecteer in het menu **Afdrukopties** de optie **Deze opname nu afdrucken** om te beginnen met afdrucken.

Op het LCD-scherm wordt  weergegeven om aan te geven dat de opname wordt afgedrukt.

7. Koppel de camera los van de computer als de opname is afgedrukt.

Informatie over andere afdrukopties vindt u in de elektronische gebruikershandleiding of in het menu **? Camera Help**. Deze optie bevindt zich in alle menu's.

6 Beknopt overzicht van de camera



In dit hoofdstuk kunt u in één oogopslag zien welke mogelijkheden u met de camera hebt. Meer informatie over deze functies vindt u in de elektronische gebruikershandleiding of in de Help op de camera.

Foto-opname, Video-opname en Weergave





- Met  **Foto-opname** kunt u foto's inkaderen op het LCD-scherm en foto's maken. Als u  **Foto-opname** wilt activeren, schuift u    naar .
- Met  **Video-opname** kunt u video's inkaderen op het LCD-scherm en video's opnemen. Als u  **Video-opname** wilt activeren, schuift u    naar .
- In de modus  **Weergave** kunt u foto's en videoclips bekijken en verwijderen. Om  **Weergave** te selecteren, schuift u    naar .

Menu's van de camera





Met de menu's kunt u camera-instellingen aanpassen, opnames bewerken en de Help-functie van de camera gebruiken.

- In een menu kunt u met   naar een bepaalde optie gaan.
- U kunt het menu op elk moment afsluiten door op  te drukken.





 **Menu Foto-opname**—Voor het aanpassen van camera-instellingen die van invloed zijn op de kenmerken van de opnames die u in het vervolg met de camera

maakt. Als u dit menu wilt openen, schuift u    naar  en drukt u op ^{Menu}_{OK}. U kunt kiezen uit de volgende opties:

- Opnamemodus (Automatisch, Close-up, Scherpe foto, Theater, Landschap, Portret, Actie, Nachtportret, Zonsondergang)
- Zelfontspanner
- Fotokwaliteit
- Burst
- Datum & tijd toevoegen
- Camera instellen
- Camera Help





 **Menu Video-opname**—Voor het aanpassen van camera-instellingen die van invloed zijn op de kenmerken van de videoclips die u in het vervolg met de camera maakt. Als u dit menu wilt openen, schuift u    naar  en drukt u op ^{Menu}_{OK}. U kunt kiezen uit de volgende opties:

- Zelfontspanner
- Camera instellen
- Camera Help





 **Menu Weergave**—Voor het bewerken van opnames. Als u dit menu wilt openen, schuift u    naar  en drukt u op ^{Menu}_{OK}. U kunt kiezen uit de volgende opties:

- Rode ogen verwijderen
- Ontwerpgalerie (Kleur wijzigen, Randen toevoegen, Draaien, Bijsnijden)
- Photosmart Express (Afdrukken, Delen, Afdrukken online kopen)
- Favorieten
- Diavoorstelling weergeven

- Opnames naar kaart
- Camera instellen
- Camera Help

 **Menu Camera instellen**—Voor het wijzigen van de werking van de camera. Als u dit menu wilt openen, drukt u op ^{Menu}OK vanuit , , of , en selecteert u vervolgens  **Camera instellen**. U kunt kiezen uit de volgende opties:

- Schermhelderheid
- Camerageluiden
- Datum & tijd
- USB-configuratie
- Taal

 **Menu Camera Help**—Voor beschrijvingen van functies en tips voor het gebruik van de camera. Als u dit menu wilt openen, drukt u op ^{Menu}OK vanuit , , of , en selecteert u vervolgens  **Camera Help**. U kunt kiezen uit de volgende opties:

- Toptien handigste tips
- Camera-accessoires
- Cameraknoppen
- Opnamemodi gebruiken
- Ontwerpgalerie gebruiken
- Photosmart Express gebruiken
- Foto's afdrukken
- Videoclips opnemen
- Foto's en video bekijken
- Opnames labelen
- Opnames verwijderen

- Opnames overbrengen
- Batterijbeheer
- Hulp en ondersteuning
- Overzicht camerafuncties
- Camerasneltoetsen
- Info

Nederlands



Nederlands



Câmera digital HP Photosmart série R740

Português



i n v e n t

Informações legais e avisos

© Copyright 2007 Hewlett-Packard Development Company, L.P.

As informações aqui contidas estão sujeitas a alterações sem aviso prévio. As únicas garantias para produtos e serviços da HP são as estabelecidas nas declarações de garantia expressa que acompanham tais produtos e serviços. Nenhuma informação aqui contida pode ser considerada como uma garantia adicional. A HP se isenta de responsabilidade por erros técnicos ou editoriais ou omissões aqui contidas.

Windows® é uma marca registrada da Microsoft Corporation nos Estados Unidos.



O logotipo SD é uma marca comercial de seu proprietário.



Descarte de equipamento residencial na União Européia

Este símbolo no produto ou na embalagem indica que ele não deve ser descartado juntamente com os demais lixos domésticos. É de sua responsabilidade o descarte do equipamento, levando-o a um local de coleta designado para a reciclagem de equipamentos elétricos e eletrônicos usados. A coleta e a reciclagem apropriadas de seu equipamento usado no momento do descarte ajudarão a conservar os recursos naturais e a garantir que a reciclagem se dará de maneira a proteger a saúde humana e o ambiente. Para mais informações sobre onde deixar seu equipamento para reciclagem, por favor, dirija-se à administração municipal, ao serviço de coleta de lixo ou à loja onde você adquiriu o produto.

Para referência futura, preencha as seguintes informações:

- Número do modelo: _____
- Número de série: _____
- Data de aquisição: _____

Conteúdo

1	Primeiros passos	
	Acessar a versão eletrônica do Guia do	
	Usuário.....	4
	Partes superior, lateral e traseira da câmera.....	6
	Partes frontal e inferior da câmera.....	7
2	Preparar a câmera	
	Carregar a bateria.....	9
	Colocar a bateria.....	9
	Ligar a câmera.....	10
	Escolher o idioma.....	10
	Definir a região.....	10
	Configurar data e hora.....	10
	Instalar e formatar cartão de memória	
	opcional.....	11
	Instalar o software.....	12
	Windows.....	13
	Macintosh.....	13
3	Tirar fotos e gravar clipes de vídeo	
	Tirar fotos.....	14
	Gravar um clipe de vídeo.....	14
4	Rever e excluir imagens e clipes de vídeo	
	Rever imagens e clipes de vídeo.....	16
	Excluir uma imagem.....	16
5	Transferir e imprimir imagens	
	Transferir imagens.....	17
	Imprimir imagens diretamente da câmera.....	17
6	Referência rápida da câmera	19

1 Primeiros passos

Este Guia de Início Rápido fornece as informações de que você precisa para começar a usufruir os principais recursos da câmera. Para obter informações detalhadas sobre os recursos da câmera, consulte a versão eletrônica do Guia do Usuário (*Acessar a versão eletrônica do Guia do Usuário* na página 4).

Guia de Início Rápido	Versão eletrônica do Guia do Usuário
<p>Este guia impresso irá ajudá-lo a:</p> <ul style="list-style-type: none">• Iniciar rapidamente o uso da câmera• Instalar o software HP Photosmart• Conhecer os recursos básicos da câmera	<p>O Guia do Usuário eletrônico inclui:</p> <ul style="list-style-type: none">• Descrições de todos os recursos da câmera• Informações sobre baterias, incluindo:<ul style="list-style-type: none">• Como prolongar a vida das baterias• Uma descrição dos ícones indicadores de alimentação• Solução de problemas• Como obter assistência da HP• Especificações da câmera

Português

Acessar a versão eletrônica do Guia do Usuário



A versão eletrônica do Guia do Usuário está no HP Photosmart Software CD.

Para visualizar o Guia do Usuário:

1. Insira o HP Photosmart Software CD na unidade de CD do computador.
2. Clique em **Ver o Guia do Usuário** na página principal da tela de instalação.

A versão eletrônica do Guia do Usuário também é copiada para o computador, ao se instalar o software HP Photosmart. Para visualizar o Guia do Usuário após ele ter sido instalado no computador:

- **Em ambiente Windows:** Abra a **Central de Soluções HP** e clique em Ajuda.
- **No Macintosh:** Abra o **Gerenciador de dispositivos HP** e selecione **Guia do Usuário da Câmera** no menu suspenso **Informações e configurações**.

Obter assistência



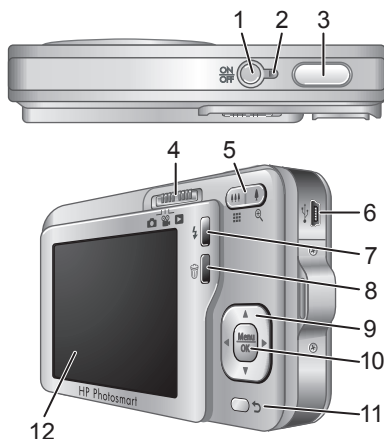

- Para obter dicas e ferramentas para auxiliar no uso mais eficiente da câmera, visite **www.hp.com**. Lá, clique em **Learn About: Digital Photography** (Saiba mais sobre: fotografia digital; apenas em inglês).
- Para obter suporte de produtos, incluindo atualizações de driver, firmware e software, visite **www.hp.com/support**.
- Para obter ajuda com o software HP Photosmart, veja a ajuda online do software.

Partes superior, lateral e traseira da câmera



Português

1	Botão ON/OFF.
2	Luz de alimentação
3	Botão Obturador .
4	Seletor — Alterna entre Capturar imagens , Gravar vídeo , e Reproduzir (veja <i>Capturar imagens</i> , <i>Gravar vídeo</i> e <i>Reproduzir</i> na página 19).
5	Controle de Zoom (digital e óptico) — Acessa Zoom nos modos Capturar imagens ou Gravar vídeo ; acessa Miniaturas e Ampliar no modo Reproduzir .
6	Conector USB.

7	 Botão Flash — Acessa as configurações de flash em  Capturar imagens . As configurações são: Flash automático, Olho vermelho, Flash lig. e Flash desl.
8	 Botão Excluir — Acessa a função Excluir em  Reproduzir .
9	Botões ▲▼ e ◀▶ — Percorrem os menus e as imagens.
10	Botão ^{Menu} _{OK} — Exibe menus da câmera, seleciona opções e confirma ações.
11	 Botão Voltar — Retorna para um menu ou exibição anterior. Mantenha pressionado para voltar todos os menus.
12	Visor de imagens

Partes frontal e inferior da câmera

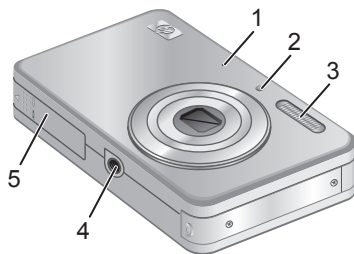

1	Microfone
2	Luz do Timer interno/Auxiliar de foco

3	Flash
4	Suporte para tripé.
5	Tampa da bateria/cartão de memória

Português

2 Preparar a câmara

Carregar a bateria

Antes de usar a bateria pela primeira vez, carregue-a completamente usando o carregador fornecido com a câmara.

 **Nota** A câmara usa uma bateria recarregável HP Photosmart LI40 (Q6277A). Não carregue nenhuma outra bateria no carregador.

1. Conecte o carregador a uma tomada elétrica e insira a bateria, como mostrado.

A luz de carregamento de bateria do carregador fica laranja enquanto a bateria está sendo carregada; a bateria estará totalmente carregada quando a luz ficar verde (cerca de uma hora e meia).

2. Tire a bateria do carregador quando ela estiver totalmente carregada.

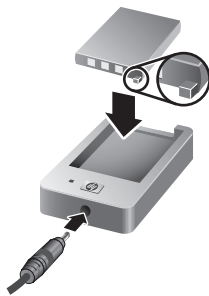

Colocar a bateria

1. Abra a tampa da bateria/cartão de memória deslizando a trava da tampa, conforme indicado.
2. Insira a bateria no slot maior, empurrando-a até que se encaixe.
3. Feche a tampa da bateria/cartão de memória.



Para tirar a bateria, movimente a trava até que ela se solte.

Ligar a câmera

Para ligar a câmera, pressione o botão ON/OFF.

Escolher o idioma

Use ▲▼◀▶ para escolher o idioma desejado e, a seguir, pressione $\frac{\text{Menu}}{\text{OK}}$.

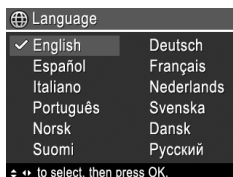

Definir a região

As configurações de idioma e região determinam o formato padrão da data.

Use ▲▼ para escolher a região desejada e pressione $\frac{\text{Menu}}{\text{OK}}$.



Configurar data e hora

Ajustar a data e hora corretamente auxiliará a localizar imagens após serem transferidas para o computador, além de assegurar que as imagens sejam corretamente

marcadas, se você usar o recurso de gravação de data e hora.

1. Use ▲▼ para ajustar o valor realçado.
2. Use ◀▶ para ir para outras seleções e repita a Etapa 1 até que a data e a hora estejam configuradas corretamente.
3. Pressione $\begin{matrix} \text{Menu} \\ \text{OK} \end{matrix}$ quando a data, hora e formato estiverem corretos, e pressione $\begin{matrix} \text{Menu} \\ \text{OK} \end{matrix}$ novamente para confirmar.

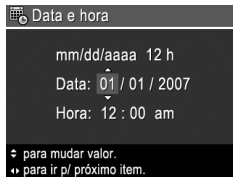

Instalar e formatar cartão de memória opcional

Essa câmera é compatível com cartões de memória padrão, de alta velocidade e de alta capacidade Secure Digital (SD e SDHC) de 32 MB a 8 GB.



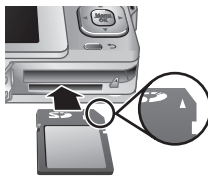











1. Desligue a câmera e abra a tampa da bateria/cartão de memória.
2. Insira o cartão de memória opcional no slot menor, como demonstrado. Verifique se o cartão de memória está encaixado.
3. Feche a tampa da bateria/cartão de memória e ligue a câmera.



Português

 **Nota** A câmera, quando ligada com um cartão de memória instalado, indica a quantidade de imagens que podem ser armazenadas no cartão com a configuração atual de **Qualidade da imagem**. Essa câmera agüenta o armazenamento de até 2.000 imagens em um cartão de memória.

Sempre formate novos cartões de memória antes de usá-los pela primeira vez. A formatação exclui todas as imagens do cartão de memória, portanto certifique-se de transferir as imagens já existentes antes da formatação.

1. Com a câmera ligada, deslize    para .
2. Pressione  para exibir o menu  **Excluir**.
3. Use   para selecionar **Formatar cartão** e pressione  .
4. Use   para selecionar **Sim** e pressione   para formatar o cartão.

Uma vez instalado um cartão de memória, todas as novas imagens e clipes de vídeo serão armazenados no cartão e não na memória interna.

Para usar a memória interna e exibir as imagens armazenadas, desligue a câmera e remova o cartão de memória.

Instalar o software

O software HP Photosmart oferece recursos para transferir imagens e clipes de vídeo para o computador, bem como recursos para modificar imagens armazenadas (corrigir olhos vermelhos, girar, cortar, redimensionar e muito mais).

Para instalar o software HP Photosmart, o computador deve atender aos requisitos de sistema descritos na

embalagem da câmera. Para saber mais sobre o suporte do Windows Vista à câmera, consulte www.hp.com/go/windowsvista (somente em inglês).

Se tiver problemas ao instalar ou usar o software HP Photosmart, consulte o site de suporte técnico da Hewlett-Packard para obter mais informações: www.hp.com/support.

Windows

1. Feche todos os programas e desative temporariamente o antivírus.
2. Insira o HP Photosmart Software CD na unidade de CD e siga as instruções da tela. Se a janela de instalação não for exibida, clique em **Iniciar**, a seguir, em **Executar**, digite **D:\Setup.exe**, em que **D** é a letra da unidade de CD, e clique em **OK**.
3. Quando a instalação terminar, reative o antivírus.

Macintosh

1. Insira o HP Photosmart Software CD na unidade de CD.
2. Na área de trabalho do computador, clique duas vezes no ícone do CD.
3. Clique duas vezes no ícone do instalador e siga as instruções da tela.

Quando a instalação estiver concluída e o computador tiver reiniciado, as **Preferências de sistema** exibirão automaticamente as configurações da **câmera HP Photosmart**. É possível alterar as configurações para que o software HP Photosmart inicie automaticamente quando você conectar a câmera ao Macintosh (para obter mais informações, clique no botão da ajuda na caixa de diálogo de configurações da **Câmera HP Photosmart**).

3 Tirar fotos e gravar clipes de vídeo

Deslize para para tirar fotos ou para para gravar clipes de vídeo.

Tirar fotos

Você poderá tirar fotos quando estiver em **Capturar imagens**.

1. Deslize para .
2. Enquadre o objeto no Visor de imagens.
3. Pressione o botão **Obturador** até a metade para medir e travar o foco e a exposição. Os colchetes do foco no Visor de imagens ficarão verdes quando o foco estiver travado.
4. Pressione o botão **Obturador** até o fim para tirar a foto.

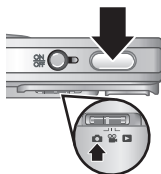

Depois de tirada, a foto aparece rapidamente no Visor de imagens.

Gravar um clipe de vídeo

Você pode gravar um vídeo quando estiver em **Gravar vídeo**.

1. Deslize para .
2. Enquadre o objeto no Visor de imagens.

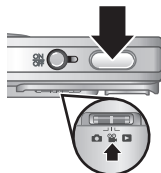





3. Pressione o botão **Obturador** até a metade para medir o foco e a exposição. Os colchetes do foco no Visor de imagens ficarão verdes quando o foco estiver travado.
4. Pressione o botão **Obturador** todo para baixo e o solte para iniciar a gravação do vídeo.
5. Para interromper a gravação do vídeo, pressione e solte o botão **Obturador** novamente.

Depois de gravado, o clipe de vídeo aparece rapidamente no Visor de imagens.

4 Rever e excluir imagens e clipes de vídeo

Rever imagens e clipes de vídeo













É possível examinar imagens e clipes de vídeo em **Reproduzir**.

1. Deslize    para .
2. Use   para percorrer imagens e clipes de vídeo. Para assistir um clipe de vídeo, pressione  quando a primeira tela do clipe aparecer no Visor de imagens.

 **Nota** Para ouvir o áudio associado a clipes de vídeo, transfira-os para o computador.

Excluir uma imagem

Você pode excluir imagens individuais enquanto estiver em **Reproduzir**:

1. Deslize    para .
2. Use   para selecionar uma imagem ou clipe de vídeo.
3. Pressione  para exibir o menu  **Excluir**.
4. Use   para selecionar **Esta Imagem** e pressione  Menu  OK.

5 Transferir e imprimir imagens

Transferir imagens

Use este procedimento para transferir imagens e cliques de vídeo para o computador.

 **Nota** A transferência de grande quantidade de imagens de alta resolução do cartão de memória para o computador pode levar até duas horas. Ao transferir grande quantidade de imagens, certifique-se de que as baterias da câmera estejam totalmente carregadas ou use um leitor de cartões de memória opcional.

1. Desligue a câmera e conecte-a ao computador, usando o cabo USB que a acompanha.
2. Ligue a câmera. Quando o Visor de imagens indicar que a câmera está conectada ao computador, siga as instruções na tela do computador para transferir as imagens. Se você tiver instalado o software HP Photosmart e precisar de mais informações, consulte o recurso da Ajuda no software HP Photosmart.

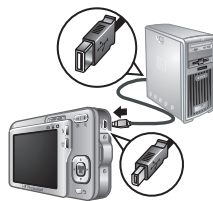

Imprimir imagens diretamente da câmera

Você pode conectar a câmera a qualquer impressora com o certificado PictBridge para imprimir imagens.



1. Verifique se a impressora está ligada, se

há papel e se não há mensagens de erro da impressora.

2. Desligue a câmera e conecte-a à impressora usando o cabo USB fornecido.

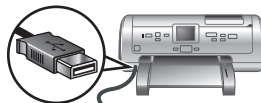

3. Ligue a câmera.

4. Quando a câmera estiver conectada à impressora, o Visor de imagens exibirá uma imagem. Use



◀▶ para selecionar a imagem que deseja imprimir.

5. Pressione $\frac{\text{Menu}}{\text{OK}}$.

6. No menu **Opções de impressão**, selecione **Imprimir esta imagem agora** para iniciar a impressão.

O  é exibido na imagem selecionada no Visor de imagens para indicar que a imagem está sendo impressa.



















7. Depois que a imagem tiver sido impressa, desconecte a câmera da impressora.

Para saber mais sobre outras opções de impressão, consulte a versão eletrônica do Guia do Usuário ou a **? Ajuda da câmera**, localizada em qualquer um dos menus.

6 Referência rápida da câmera



Use este capítulo como uma referência rápida aos recursos da câmera. Para saber mais sobre os recursos da câmera, consulte a versão eletrônica do Guia do Usuário ou a Ajuda da câmera.

Capturar imagens, Gravar vídeo e Reproduzir





-  **Capturar imagens** permite enquadrar fotos no Visor de imagens e tirar fotos. Para ativar  **Capturar imagens**, deslize    para .
-  **Gravar vídeo** permite enquadrar vídeos no Visor de imagens e gravar vídeos. Para ativar  **Gravar vídeo**, deslize    para .
-  **Reproduzir** permite examinar e excluir imagens e clipes de vídeo. Para ativar  **Reproduzir**, deslize    para .

Menus da câmera





Os menus permitem ajustar as configurações da câmera, trabalhar com imagens e acessar a ajuda da câmera.

- Em um menu, use   para ir até as seleções específicas.
- Para sair do menu, pressione  a qualquer momento.





 **Menu Capturar imagens** — Permite ajustar as configurações da câmera que afetam as características das futuras imagens capturadas com a câmera. Para

acessar esse menu, deslize    para  e pressione ^{Menu}OK . É possível selecionar as seguintes opções:

- Modo Fotografia (Automático, Close-up, Foto nítida, Teatro, Paisagem, Retrato, Ação, Retrato noturno, Pôr-do-sol)
- Timer interno
- Qualidade da imagem
- Disparo
- Gravação de data e hora
- Configurar
- Ajuda





 **Menu Gravar vídeo** — Permite ajustar as configurações da câmera que afetam as características dos futuros clipes de vídeo gravados com a câmera. Para acessar esse menu, deslize    para  e pressione ^{Menu}OK . É possível selecionar as seguintes opções:

- Timer interno
- Configurar
- Ajuda





 **Menu Reproduzir** — Permite trabalhar com as imagens. Para acessar esse menu, deslize    para  e pressione ^{Menu}OK . É possível selecionar as seguintes opções:

- Corrigir olhos vermelhos
- Galeria de projetos (Modificar cor, Adicionar bordas, Girar e Cortar)
- Photosmart Express (Imprimir, Compartilhar, Comprar impressões online)
- Favoritos
- Exibir apresentação de slides

- Mover imagens p/ cartão
- Configurar
- Ajuda

 **Menu Configurar** — Permite alterar o comportamento da câmera. Para acessar esse menu, pressione ^{Menu}OK em ,  ou  e selecione  **Configurar**. É possível selecionar as seguintes opções:

- Brilho do visor
- Sons da câmera
- Data e hora
- Configuração USB
- Idioma

 **Menu Ajuda** — Fornece descrições dos recursos da câmera e dicas de fotografia. Para acessar esse menu, pressione ^{Menu}OK em ,  ou  e selecione  **Ajuda**. É possível selecionar as seguintes opções:

- Dez melhores dicas
- Acessórios da câmera
- Botões da câmera
- Usar modos de fotografia
- Usar a Galeria de projetos
- Usar o Photosmart Express
- Imprimir imagens
- Gravar clipes de vídeo
- Rever fotos e vídeo
- Marcar imagens
- Excluir imagens
- Transferir imagens

- Gerenciar baterias
- Obter assistência
- Conhecer os recursos da câmera
- Atalhos da câmera
- Sobre





Português









- Printing Images (הדפסת תמונות)
- Recording Video Clips (הקלטת קטעי וידאו)
- Reviewing Pictures and Video (סקירת תמונות ווידאו)
- Tagging Images (סימון תמונות)
- Deleting Images (מחיקת תמונות)
- Transferring Images (העברת תמונות)
- Managing Batteries (טיפול בסוללות)
- Getting Assistance (קבלת סיוע)
- Tour Camera Features (הכרת מאפייני המצלמה)
- Camera Shortcuts (קיצורי דרך של המצלמה)
- About (אודות)

- Share (שיתוף), Print (הדפסה), Buy Prints Online (רכישת הדפסים באופן מקוון)
- Favorites (מועדפים)
- View Slideshow (הצגת מצגת שקופיות)
- Move Images to Card (העברת תמונות לכרטיס)
- Camera Setup (הגדרות מצלמה)
- Camera Help (עזרה של המצלמה)

Camera Setup Menu (תפריט הגדרות מצלמה)—מאפשר לך לשנות את אופן הפעולה של המצלמה. כדי לגשת לתפריט זה, לחץ על  ^{Menu} _{OK} (תפריט/אישור) מתוך ,  או . ולאחר מכן בחר ב-**Camera Setup** (הגדרות מצלמה). באפשרותך לבחור מתוך האפשרויות הבאות:

- Display Brightness (בהירות התצוגה)
- Camera Sounds (צלילי מצלמה)
- Date & Time (תאריך ושעה)
- USB Configuration (תצורת USB)
- Language (שפה)

Camera Help Menu ? (תפריט עזרה של המצלמה)—מספק תיאור של מאפייני המצלמה ועצות לצילום. כדי לגשת לתפריט זה, לחץ על  ^{Menu} _{OK} (תפריט/אישור) מתוך ,  או . ולאחר מכן בחר ב-**Camera Help** (עזרה של המצלמה). באפשרותך לבחור מתוך האפשרויות הבאות:

- Top Ten Tips (עשר העצות החשובות)
- Camera Accessories (אביזרי המצלמה)
- Camera Buttons (לחצני המצלמה)
- Using Shooting Modes (שימוש במצבי הצילום)
- Using Design Gallery (שימוש בגלריית העיצוב)
- Using Photosmart Express (שימוש ב-Photosmart Express)



הסט את ל-, ולאחר מכן לחץ על (תפריט/אישור). באפשרותך לבחור מתוך האפשרויות הבאות:

- Shooting Mode (מצב צילום) Auto (אוטומטי), Close-up (תקריב), Steady Photo (צילום יציב), Theatre (תיאטרון), Landscape (נוף), Portrait (דיוקן), Action (פעולה), Night Portrait (דיוקן בלילה), Sunset (שקיעה)
- Self-Timer (קוצב-זמן עצמי)
- Image Quality (איכות תמונה)
- Burst (צילום מתפרץ)
- Date & Time Imprint (הטבעת תאריך ושעה)
- Camera Setup (הגדרות מצלמה)
- Camera Help (עזרה של המצלמה)

Video Record Menu (תפריט הקלטת וידאו)—מאפשר לך לכוון את הגדרות המצלמה המשפיעות על המאפיינים של קטעי וידאו עתידיים שתקליט בעזרת המצלמה. כדי לגשת לתפריט זה, הסט את ל-, ולאחר מכן לחץ על (תפריט/אישור). באפשרותך לבחור מתוך האפשרויות הבאות:

- Self-Timer (קוצב-זמן עצמי)
- Camera Setup (הגדרות מצלמה)
- Camera Help (עזרה של המצלמה)

Playback Menu (תפריט הקרנה חוזרת)—מאפשר לך לעבוד עם תמונות. כדי לגשת לתפריט זה, הסט את ל-, ולאחר מכן לחץ על (תפריט/אישור). באפשרותך לבחור מתוך האפשרויות הבאות:

- Remove Red Eyes (הסרת עיניים אדומות)
- Design Gallery (גלריית עיצוב) Modify Color (שינוי צבע), Add Borders (הוספת גבולות), Rotate (סיבוב), Crop (חיתוך)



6 מדריך עזר מהיר למצלמה

היעזר בפרק זה כמדריך עזר מהיר למאפייני המצלמה. לקבלת מידע נוסף אודות מאפייני מצלמה אלה, עיין במדריך האלקטרוני למשתמש או בעזרה שבמצלמה.

לכידת תמונה, הקלטת וידאו והקרנה חוזרת

- מצב **Picture Capture** (לכידת תמונה) מאפשר לך לתחום תמונות בתצוגת התמונות ולצלם תמונות. להפעלת מצב **Picture Capture** (לכידת תמונה), הסט את  ל-  .
- מצב **Video Record** (הקלטת וידאו) מאפשר לך לתחום קטעי וידאו בתצוגת התמונות ולהקליט קטעי וידאו. להפעלת מצב **Video Record** (הקלטת וידאו), הסט את  ל-  .
- מצב **Playback** (הקרנה חוזרת) מאפשר לך לסקור ולמחוק תמונות וקטעי וידאו. להפעלת מצב **Playback** (הקרנה חוזרת), הסט את  ל-  .

תפריטי המצלמה

- התפריטים מאפשרים לך לכוון את הגדרות המצלמה, לעבוד עם תמונות ולגשת לעזרה של המצלמה.
- בתוך תפריט, השתמש ב-▲▼ כדי לעבור לפריטים ספציפיים.
 - כדי לצאת מתפריט, לחץ בכל עת על .
- Picture Capture Menu** (תפריט לכידת תמונה)—מאפשר לך לכוון את הגדרות המצלמה המשפיעות על המאפיינים של תמונות עתידיות שתצלם בעזרת המצלמה. כדי לגשת לתפריט זה,

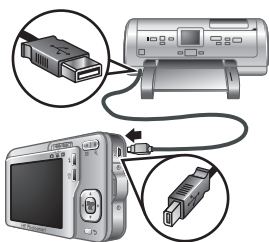

2. כבה את המצלמה ולאחר מכן חבר אותה למדפסת באמצעות כבל ה-USB המצורף למצלמה.
 3. הפעל את המצלמה.
 4. כאשר המצלמה מחוברת למדפסת, מוצגת תמונה בתצוגת התמונות. השתמש ב-◀▶ לבחירת התמונה שברצונך להדפיס.
 5. לחץ על **Menu** **OK** (תפריט/אישור).
 6. בתפריט **Print Options** (אפשרויות הדפסה), בחר **Print this image now** (הדפס תמונה זו כעת) כדי להתחיל בהדפסה.
 7. הסמל  מוצג על-גבי התמונה הנבחרת בתצוגת התמונות ומציין שהתמונה נמצאת בהדפסה.
 7. לאחר הדפסת התמונה, נתק את המצלמה מהמדפסת.
- לקבלת מידע אודות אפשרויות הדפסה נוספות, עיין במדריך האלקטרוני למשתמש או ב-**Camera Help ?** (עזרה של המצלמה) הזמינה בכל התפריטים.

5 העברה והדפסה של תמונות

העברת תמונות

השתמש בהליך זה להעברת תמונות וקטעי וידאו אל המחשב.

 הערה העברת מספר גדול של תמונות באיכות גבוהה מכרטיס זיכרון למחשב עשויה להימשך עד שעתיים. בעת העברת מספר גדול של תמונות, ודא שהסוללות טעונות במלואן או השתמש בקורא כרטיסי זיכרון אופציונלי.

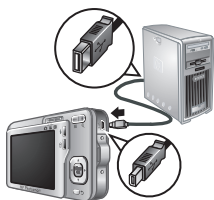

1. כבה את המצלמה ולאחר מכן חבר אותה למחשב בעזרת כבל ה-USB המצורף למצלמה.

2. הפעל את המצלמה. כאשר תצוגת התמונות מציינת שהמצלמה מחוברת למחשב, פעל בהתאם להוראות שעל-גבי מסך המחשב להעברת התמונות. אם התקנת את התוכנה HP Photosmart Software ונחוץ לך מידע נוסף, עיין במאפיין Help (עזרה) בתוכנה HP Photosmart Software.

הדפסת תמונות מהמצלמה

באפשרותך לחבר את המצלמה לכל מדפסת מאושרת-PictBridge לצורך הדפסת תמונות.

1. ודא שהמדפסת מופעלת, שיש בה נייר ושלא מופיעות הודעות שגיאה של המדפסת.









PictBridge

עזרה

4 סקירה ומחיקה של תמונות וקטעי וידאו

סקירת תמונות וקטעי וידאו











באפשרותך לסקור תמונות וקטעי וידאו במצב **Playback** (הקרנה חוזרת).

1. הסט את    ל-.
2. השתמש ב-  כדי לגלול בין התמונות ובין קטעי הווידאו. להפעלת קטע וידאו, לחץ על  כשהמסך הראשון של הקטע מופיע בתצוגת התמונות.

 הערה כדי להאזין לקטעי שמע המקושרים לקטעי וידאו, העבר אותם אל המחשב שברשותך.

מחיקת תמונה

באפשרותך למחוק תמונות נפרדות כרצונך במצב **Playback** (הקרנה חוזרת):





1. הסט את    ל-.
2. השתמש ב-  כדי לבחור תמונה או קטע וידאו.
3. לחץ על  כדי להציג את התפריט **Delete** (מחיקה).
4. השתמש ב-  לבחירת האפשרות **This Image** (תמונה זו) ולאחר מכן לחץ על   (תפריט/אישור).

4. לחץ לחיצה מלאה על לחצן **התריס** ושחרר אותו כדי להתחיל בהקלטה.

5. כדי לעצור את הקלטת הווידאו, לחץ שוב על לחצן **התריס** ושחרר אותו.

לאחר הקלטת קטע וידאו, המצלמה מציגה את הקטע למשך פרק זמן קצר בתצוגת התמונות.



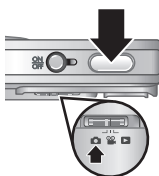

3 צילום תמונות והקלטת קטעי וידאו

הסט את    ל- כדי לצלם תמונות או ל- כדי להקליט קטעי וידאו.

צילום תמונה





באפשרותך לצלם תמונה כאשר המצלמה נמצאת במצב  **Picture Capture** (לכידת תמונה).



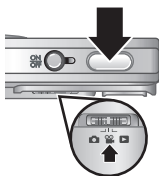

1. הסט את    ל-.
2. תחום את נושא הצילום בתצוגת התמונות.
3. לחץ לחיצה חלקית על לחצן **התריס** כדי למדוד ולנעול את המיקוד ואת החשיפה. תוחמי המיקוד בתצוגת התמונות מוצגים בצבע ירוק רציף כאשר המיקוד ננעל.
4. לחץ לחיצה מלאה על לחצן **התריס** על מנת לצלם את התמונה.

לאחר צילום תמונה, המצלמה מציגה אותה למשך פרק זמן קצר בתצוגת התמונות.

הקלטת קטע וידאו



באפשרותך להקליט וידאו כאשר המצלמה נמצאת במצב  **Video Record** (הקלטת וידאו).

1. הסט את    ל-.
2. תחום את נושא הצילום בתצוגת התמונות.
3. לחץ לחיצה חלקית על לחצן **התריס** כדי למדוד את המיקוד והחשיפה. תוחמי המיקוד בתצוגת התמונות מוצגים בצבע ירוק רציף כאשר המיקוד ננעל.

2. לחץ לחיצה כפולה על סמל התקליטור בשולחן העבודה.
3. לחץ לחיצה כפולה על סמל תוכנית ההתקנה, ולאחר מכן פעל בהתאם להוראות שעל-גבי המסך.

עם סיום ההתקנה ולאחר הפעלת המחשב מחדש, **System Preferences** (העדפות מערכת) נפתח באופן אוטומטי להגדרות של מצלמת **HP Photosmart Camera**. באפשרותך לשנות את ההגדרות כך שתוכנת HP Photosmart Software תופעל באופן אוטומטי בעת חיבור המצלמה ל-Macintosh שברשותך (לקבלת מידע נוסף, לחץ על לחצן העזרה בתיבת הדו-שיח של הגדרות המצלמה **HP Photosmart Camera**).

לאחר שתתקין כרטיס זיכרון, כל התמונות וקטעי הווידאו החדשים יאוחסנו בכרטיס במקום בזיכרון הפנימי.

על מנת להשתמש בזיכרון הפנימי ולהציג את התמונות המאוחסנות בו, כבה את המצלמה ולאחר מכן הסר את כרטיס הזיכרון.

התקנת התוכנה

תוכנת HP Photosmart Software מספקת מאפיינים להעברת תמונות וקטעי וידאו למחשב, כמו גם מאפיינים לשיפור תמונות מאוחסנות (הסרת עיניים אדומות, סיבוב, חיתוך, שינוי גודל ועוד).

כדי להתקין את התוכנה HP Photosmart Software, על המחשב לעמוד בדרישות המערכת המופיעות על אריזת המצלמה. כדי ללמוד אודות תמיכה ב-Windows Vista עבור המצלמה, בקר בכתובת www.hp.com/go/windowsvista (באנגלית בלבד).

אם אתה נתקל בבעיה בעת התקנה או שימוש בתוכנת HP Photosmart Software, בקר באתר האינטרנט של התמיכה הטכנית של Hewlett-Packard לקבלת מידע נוסף, בכתובת: www.hp.com/support.

Windows

1. סגור את כל התוכניות והשבת באופן זמני תוכנות להגנה מפני וירוסים.
2. הכנס את התקליטור HP Photosmart Software CD לכונן התקליטורים של המחשב, ופעל לפי ההוראות שעל-גבי המסך. אם חלון ההתקנה אינו מופיע, לחץ על **Start** (התחל), לחץ על **Run** (הפעלה), הקלד **D:\Setup.exe**, כאשר **D** הוא אות כונן התקליטורים, ולאחר מכן לחץ על **OK** (אישור).
3. עם סיום התקנת התוכנה, הפעל מחדש את תוכנות האנטי-וירוס.

Macintosh

1. הכנס את התקליטור HP Photosmart Software CD לכונן התקליטורים של המחשב.

לחץ שנית על  (תפריט/אישור) לאישור.

התקנה ואתחול של כרטיס זיכרון אופציונלי



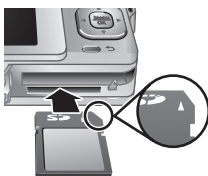







מצלמה זו תומכת בכרטיסי זיכרון (SD ו-SDHC) Secure Digital בטנדרטיים, בעלי מהירות גבוהה וקיבולת גדולה, בנפח 32MB עד 8GB.



1. כבה את המצלמה ופתח את דלת הסוללה/כרטיס הזיכרון.
2. הכנס את כרטיס הזיכרון האופציונלי לחריץ הקטן יותר, כמוצג באיור. ודא שכרטיס הזיכרון נכנס למקומו בנקישה.
3. סגור את דלת הסוללה/כרטיס הזיכרון והפעל את המצלמה.

 **הערה** כאשר אתה מפעיל את המצלמה עם כרטיס זיכרון מותקן, המצלמה מציינת את מספר התמונות שבאפשרותך לשמור בכרטיס הזיכרון בהתאם להגדרת **Image Quality** (איכות תמונה) הנוכחית. מצלמה זו תומכת באחסון של 2000 תמונות לכל היותר בכרטיס זיכרון.

הקפד תמיד לאתחל כרטיס זיכרון חדשים לפני השימוש הראשון. האתחול יסיר את כל התמונות מכרטיס הזיכרון, ולכן עליך להקפיד להעביר את התמונות הקיימות לפני האתחול.

1. כשהמצלמה מופעלת, הסט את   ל- .
2. לחץ על  כדי להציג את התפריט **Delete** (מחיקה).
3. השתמש ב-   לבחירת האפשרות **Format Card** (אתחול כרטיס) ולאחר מכן לחץ על  (תפריט/אישור).
4. השתמש ב-   לבחירה באפשרות **Yes** (כן) ולאחר מכן לחץ על  (תפריט/אישור) לאתחול הכרטיס.

הפעלת המצלמה

הפעלת המצלמה, לחץ על הלחצן ON/OFF (הפעלה/כיבוי).

בחירת השפה

השתמש ב-▲▼▶◀ לבחירת השפה
הרצויה ולאחר מכן לחץ על
(תפריט/אישור) ^{Menu} _{OK}.

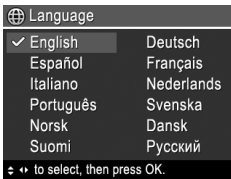

הגדרת המדינה/אזור

יחד עם הגדרת השפה, הגדרת
המדינה/אזור קובעת את תבנית
ברירת המחדל של התאריך.

השתמש ב-▲▼▶◀ לבחירת המדינה/
אזור הרצויים ולאחר מכן לחץ על
(תפריט/אישור) ^{Menu} _{OK}.

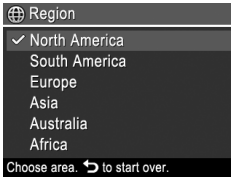

הגדרת התאריך והשעה

הגדרה מדויקת של תאריך ושעה תסייע לך לאתר תמונות לאחר
שתעביר אותן למחשב ותבטיח סימון מדויק של התמונות כאשר
תשתמש במאפיין הטבעת תאריך ושעה.



1. השתמש ב-▲▼▶◀ כדי לכוון את הערך המסומן.
2. השתמש ב-▶◀ כדי לעבור לאפשרויות האחרות וחזור על שלב 1 עד להגדרת התאריך והשעה כהלכה.
3. לחץ על (תפריט/אישור) ^{Menu} _{OK} כאשר הגדרות התאריך, השעה והתבנית נכונות, לאחר מכן

2 התקנת המצלמה

טעינת הסוללה

לפני השימוש הראשוני בסוללה, טען אותה במלואה באמצעות המטען המצורף למצלמה.

 הערה המצלמה שברשותך עושה שימוש בסוללת HP Photosmart LI40 נטענת (Q6277A). אין לטעון סוללה מסוג אחר במטען.



1. חבר את המטען לשקע חשמל ולאחר מכן הכנס את הסוללה למטען, כמוצג באיור.

נורית טעינת הסוללה של המטען מאירה בכתום כאשר הסוללה נמצאת בטעינה; כאשר הנורית מאירה בירוק (כ-1.5 שעות), הסוללה טעונה במלואה.

2. בסיום הטעינה, הסר את הסוללה מהמטען.

התקנת הסוללה



1. פתח את דלת הסוללה/כרטיס הזיכרון על-ידי החלקת תפס הדלת, כפי שמצוין על הדלת.

2. הכנס את הסוללה לחרוץ הרחב יותר, ודחוף אותה עד שהתפס יינעל.

3. סגור את דלת הסוללה/כרטיס הזיכרון.

להסרת הסוללה, הזז את תפס הסוללה כמוצג באיור עד שהסוללה תשתחרר.

מבזק.	3
תושבת חצובה.	4
דלת סוללה/כרטיס זיכרון	5

6	מחבר USB.
7	⚡ לחצן מבזק —לגישה להגדרות המבזק במצב Picture Capture (לכידת תמונה). ההגדרות הן Auto (אוטומטי), Red-eye (הסרת עיניים אדומות), Flash On (מבזק מופעל), Flash Off (מבזק כבוי).
8	🗑️ לחצן מחיקה —לגישה לפונקציה Delete (מחיקה) במצב Playback (הקרנה חוזרת).
9	הלחצנים ▲▼ ו-◀▶—לגלילה בין תפריטים ותמונות.
10	לחצן Menu/OK (תפריט/אישור)—להצגת תפריטי המצלמה, לבחירה באפשרויות ולאישור פעולות.
11	↶ לחצן הקודם —לחזרה לתפריט או לתצוגה הקודמים. לחץ לחיצה ממושכת ליציאה מכל התפריטים.
12	תצוגת תמונות.

חלקה הקדמי והתחתון של המצלמה

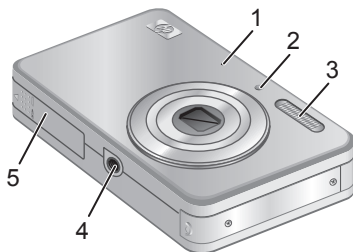

1	מיקרופון.
2	נורית קוצב-הזמן העצמי/עזרה למיקוד.

חלקה העליון, הצדדי והאחורי של המצלמה

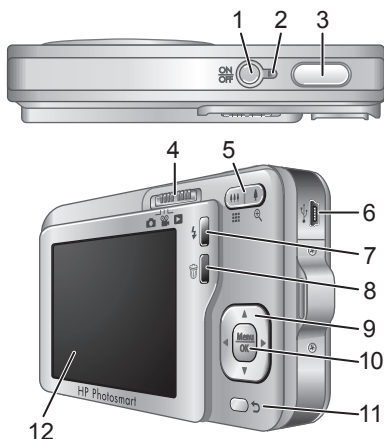

1	לחצן ON/OFF (הפעלה/כיבוי).
2	נורית הפעלה.
3	לחצן התריס.
4	בורר —למעבר בין Picture Capture (לקידת תמונה), Video Record (הקלטת וידאו) ו- Playback (הקרנה חוזרת) עיין בסעיף "לקידת תמונה, הקלטת וידאו והקרנה חוזרת" בעמוד 19).
5	מתג זום (דיגיטלי ואופטי) —לגישה לפונקציות (Zoom (זום) במצב Picture Capture (לקידת תמונה) או Video Record (הקלטת וידאו); לגישה לאפשרות Thumbnails (תמונות ממוזערות) ו- Magnify (הגדלה) במצב Playback (הקרנה חוזרת).
6	
7	
8	
9	
10	
11	
12	

המדריך האלקטרוני למשתמש יועתק למחשבך גם עם התקנת התוכנה HP Photosmart Software. כדי להציג את המדריך למשתמש לאחר שהותקן במחשב:

- **במערכת Windows:** פתח את **HP Solution Center** (מרכז הפתרונות של HP) ולחץ על Help (עזרה).
- **במחשב Macintosh:** פתח את **HP Device Manager** ובחר **Camera User Guide Information and Settings**.

קבלת סיוע

- לקבלת עצות וכלים שיסייעו לך להשתמש במצלמה באופן יעיל יותר, בקר בכתובת **www.hp.com**. בדף זה, לחץ על **Learn About: Digital Photography** (באנגלית בלבד).
- לקבלת תמיכה במוצר, לרבות עדכוני קושחה, תוכנה ומנהלי התקן, בקר בכתובת **www.hp.com/support**.
- לקבלת עזרה עבור התוכנה HP Photosmart Software, עיין בעזרה המקוונת של התוכנה.

1 תחילת העבודה

המדריך להפעלה מהירה' המודפס מספק את המידע הדרוש לך כדי להתחיל בעבודה ולהשתמש במאפיינים החשובים ביותר במצלמה. לקבלת מידע מפורט אודות מאפייני המצלמה, עיין במדריך האלקטרוני למשתמש (עיין בסעיף "גישה למדריך האלקטרוני למשתמש" בעמוד 4).

מדריך להפעלה מהירה	מדריך אלקטרוני למשתמש
מדריך מודפס זה יסייע לך בדברים הבאים:	המדריך האלקטרוני למשתמש כולל:
<ul style="list-style-type: none">למידה מהירה של תפעול המצלמההתקנת התוכנה HP Photosmart Softwareהכרת המאפיינים הבסיסיים של המצלמה	<ul style="list-style-type: none">תיאורים של כל מאפייני המצלמהמידע אודות הסוללות, לרבות:<ul style="list-style-type: none">הארכת חיי הסוללהתיאור הסמלים של מחוון החשמלפתרון בעיותקבלת עזרה מ-HPמפרטי המצלמה

גישה למדריך האלקטרוני למשתמש

המדריך האלקטרוני למשתמש נמצא על-גבי התקליטור HP Photosmart Software CD.



להצגת המדריך למשתמש:

1. הכנס את התקליטור HP Photosmart Software CD לכונן התקליטורים של המחשב.
2. לחץ על **View User Guide** (הצג את המדריך למשתמש) בדף הראשי של מסך ההתקנה.

תוכן עניינים

1 תחילת העבודה	1
4.....גישה למדריך האלקטרוני למשתמש	
6.....חלקה העליון, הצדדי והאחורי של המצלמה	
7.....חלקה הקדמי והתחתון של המצלמה	
2 התקנת המצלמה	2
9.....טעינת הסוללה	
9.....התקנת הסוללה	
10.....הפעלת המצלמה	
10.....בחירת השפה	
10.....הגדרת המדינה/אזור	
10.....הגדרת התאריך והשעה	
11.....התקנה ואתחול של כרטיס זיכרון אופציונלי	
12.....התקנת התוכנה	
12.....Windows	
12.....Macintosh	
3 צילום תמונות והקלטת קטעי וידאו	3
14.....צילום תמונה	
14.....הקלטת קטע וידאו	
4 סקירה ומחיקה של תמונות וקטעי וידאו	4
16.....סקירת תמונות וקטעי וידאו	
16.....מחיקת תמונה	
5 העברה והדפסה של תמונות	5
17.....העברת תמונות	
17.....הדפסת תמונות מהמצלמה	
6 מדריך עזר מהיר למצלמה	6

מידע משפטי והודעות

© Copyright 2007 Hewlett-Packard Development Company, L.P.

המידע הכלול במסמך זה נתון לשינויים ללא הודעה מוקדמת. האחריות הבלעדית למוצרים ולשירותים של HP מפורטת בהצהרת האחריות המפורשת הנלווית לאותם מוצרים ושירותים. אין לפרש דבר מן האמור במסמך זה כהענקת אחריות נוספת. חברת HP לא תישא באחריות לשגיאות או השמטות מסיבות טכניות או בעקבות עריכה במסמך זה.

Windows® הוא סימן מסחרי רשום בארה"ב של Microsoft Corporation.

הסמל SD הוא סימן מסחרי של בעליו. 

השלכת פסולת ציוד על-ידי משתמשים במשקי בית פרטיים באיחוד האירופי

סמל זה, כאשר הוא מופיע על המוצר או על אריזתו, פירושו שאסור להשליך את המוצר יחד עם שאר האשפה הביתית. במקום זאת, מתפקידך להשליך את פריטי הציוד המשומש הזה על-ידי הפקדתם בנקודות איסוף מיוחדות לצורך מיחזור של פריטי ציוד חשמליים ואלקטרוניים משומשים. האיסוף בנפרד והמיחזור של פריטי ציוד משומשים בעת השלכתם, יסייעו בשמירה על משאבים טבעיים ויבטיחו מיחזור באופן שיש בו כדי להגן על הבריאות ועל הסביבה. לפרטים נוספים על נקודות איסוף לפריטי ציוד משומשים המיועדים למיחזור, פנה אל הרשות המקומית, אל שירות השלכת האשפה הביתית, או אל החנות שבה רכשת את המוצר.

לצורך פניות עתידיות, מלא את הפרטים הבאים:

- מספר דגם: _____
- מספר סידורי: _____
- תאריך רכישה: _____

מצלמה דיגיטלית מסדרת
HP Photosmart R740

עברית



i n v e n t