

Fabricante	Fabricante	Manufacturer	Fabricant	Hersteller	TEKA	TEKA
Modelo	Modelo	Model	Modèle	Modell	HA-900	HA-935
Clase de eficiencia energética, en una escala que abarca de A (más eficiente) a G (menos eficiente).	Classe de eficiência energética, numa escala de A (eficiente) a G (ineficiente).	Energy efficiency class on a scale of A (more efficient) to G (less efficient).	Classement selon son efficacité énergétique sur une échelle allant de A (économe) à G (peu économe).	Energieeffizienzklasse auf einer Skala von A (niedriger Verbrauch) bis G (hoher Verbrauch).	B	B
Función de calentamiento.	Função de aquecimento.	Heating function.	Fonction chauffage.	Beheizung.		
Calentamiento convencional.	Convencional.	Conventional.	Classique.	Konventionelle Beheizung.		
Convección forzada.	Convecção forçada de ar.	Forced air convection.	Convection forcée.	Umluft / Heißluft.	←	←
Consumo de energía.	Consumo de energia.	Energy consumption.	Consommation d'énergie.	Energieverbrauch.		
Calentamiento convencional.	Convencional.	Conventional.	Classique.	Konventionelle Beheizung.	1,15 Kwh	1,15 Kwh
Convección forzada.	Convecção forçada de ar.	Forced air convection.	Convection forcée.	Umluft / Heißluft.	1,10 Kwh	1,13 Kwh
Volumen neto (litros).	Volume útil (litros).	Usable volume (litres).	Volume utile (litres).	Netto-volumen (liter).	69	69
Tipo: Pequeño Medio Grande	Tipo: Pequeno Médio Grande	Size: Small Medium Large	Type: Faible volume Volume moyen Grand volume	Typ: Klein Mittel Groß	←	←
Tiempo de cocción con carga normal.	Tempo de cozedura da carga-padrão.	Time to cook standard load.	Temps de cuisson en charge normale.	Kochzeit bei Standardbelastung.		
Calentamiento convencional.	Convencional.	Conventional.	Classique.	Konventionelle Beheizung.	43 min.	43 min.
Convección forzada.	Convecção forçada de ar.	Forced air convection.	Convection forcée.	Umluft / Heißluft.	43 min.	46 min.
Superficie de cocción.	Zona de cozedura.	Baking area.	Surface de cuisson.	Backfläche	1860 cm²	1860 cm²
Ruido (dB (A) re 1 pW).	Nível de ruído dB(A) re 1 pW.	Noise (dB (A) re 1 pW).	Bruit (dB (A) re 1 pW).	Geräusch (dB (A) re 1 pW).	47	47

Hoja de Características

Folha de Características

Feature List

Feuille de Caractéristiques

Datenblatt

HA-900/HA-935

116

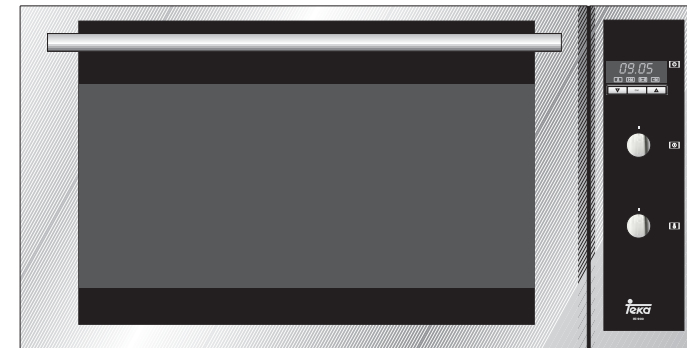

TEKA

Nuestra aportación a la protección del medio-ambiente: utilizamos papel reciclado.
 A nossa contribuição para a proteção do ambiente: utilizamos papel reciclado.
 Our contribution to environmental protection: we use recycled paper.
 Notre contribution à la protection de l'environnement : nous utilisons du papier recyclé.
 Unser Beitrag zum Umweltschutz: wir verwenden umweltfreundliches Papier.
 Cod.: 83172116/31721.16-001



Descripción del Horno

Modelo HA-900

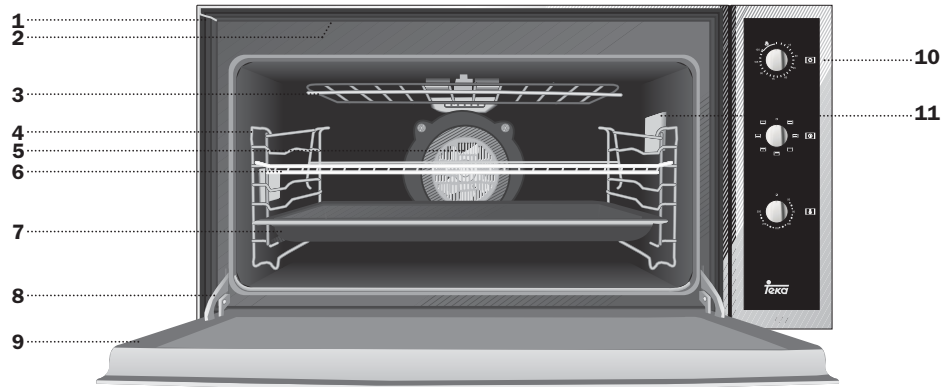

Modelo HA-935

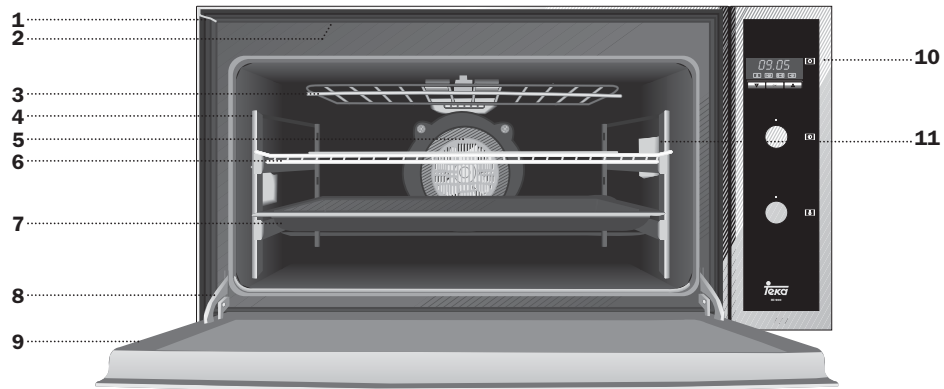

- | | | |
|--|--|----------------------|
| 1 Fijación al mueble | 4 Soportes Bandejas/
Guías Telescópicas | 8 Bisagra |
| 2 Salida de aire
de refrigeración | 5 Turbina | 9 Puerta |
| 3 Resistencia de Grill
Doble Abatible | 6 Parrilla | 10 Frontal de mandos |
| | 7 Bandeja de Asados | 11 Lámparas |

Frontal de Mandos

Modelo HA-900

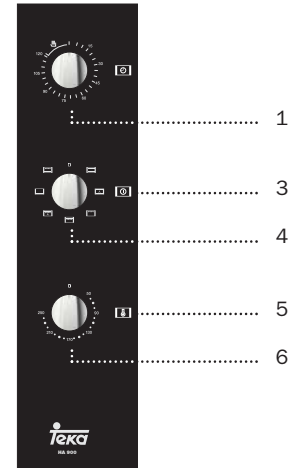

Modelo HA-935

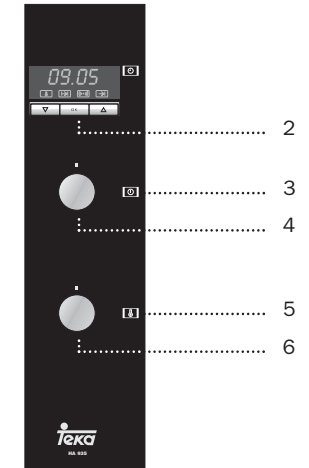

- 1 Mando temporizador minuterero.
- 2 Programador electrónico.
- 3 Piloto conexión horno.
- 4 Selector de funciones.

- 5 Piloto de calentamiento. Indica la transmisión de calor al alimento y se apaga al alcanzar la temperatura seleccionada.
- 6 Selector de temperaturas.

Modelo HA-900



Modelo HA-935



Desconexión del horno

Convencional

Se usa en bizcochos y tartas en los que el calor recibido debe ser uniforme y para que consigan una textura esponjosa.

Convencional con Turbina

Adecuado para asados y pastelería. El ventilador reparte de forma uniforme el calor en el interior del horno, reduciendo el tiempo y la temperatura de cocinado.

Grill

Gratinado y asado superficial. Permite el dorado de la capa exterior sin afectar al interior del alimento. Indicado para piezas planas como bistec, costillas, pescado, tostadas.

MaxiGrill

Permite el gratinado en mayores superficies que en Grill, así como una mayor potencia de gratinado, obteniendo un dorado del alimento de forma más rápida.

MaxiGrill con Turbina

Permite el asado uniforme al mismo tiempo que dora superficialmente. Ideal para parrilladas. Especial para piezas con gran volumen

como aves, caza,... Se recomienda colocar la pieza de carne sobre la parrilla del horno y la bandeja por debajo, para el escurrido de jugos o grasa.

Atención

Durante el uso de la función Grill, MaxiGrill o MaxiGrill con Turbina la puerta debe mantenerse cerrada.

Turbo

La turbina reparte el calor que proviene de una resistencia situada en la parte trasera del horno. Por la uniformidad de la temperatura que se produce, permite cocinar en 2 alturas al mismo tiempo.

Esta función también permite descongelar alimentos, colocando el selector de temperaturas en posición .

Solera

Calor sólo desde la parte inferior. Apropiado para calentar platos o levantar masas de repostería y afines.

Solera con Turbina

Distribuye el calor que proviene de la parte inferior del horno. Ideal para pasteles con relleno de mermelada o fruta, los cuales sólo requieren un aporte de calor inferior. Siempre es necesario un precalentamiento anterior.

Grill y Solera



Especial para asados. Puede usarse para cualquier pieza, independiente de su tamaño.

Nota

La lámpara permanece encendida en cualquier función de cocinado.

Modelo HA-900

Funcionamiento Manual del Horno

- 1 Gire el mando del temporizador hacia la izquierda hasta la posición .
- 2 Seleccione una temperatura y una función de cocinado.
- 3 Ponga los mandos en posición  para apagar el horno.

Funcionamiento Temporizado del Horno



Permite cocinar durante un tiempo previamente seleccionado. Para ello:

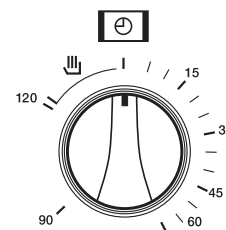



- 1 Elija la función y la temperatura de cocinado.
- 2 Gire el mando del temporizador, en el sentido de las agujas del reloj, hasta la posición "120" minutos y después gírelo en sentido inverso para seleccionar el tiempo de cocinado deseado.
- 3 Transcurrido el tiempo programado, sonará una señal acústica y el horno dejará de calentarse.
- 4 Ponga los mandos en posición  para apagar el horno.



Modelo HA-935

Puesta en Hora del Reloj Electrónico

Al conectar su horno, observará que en el reloj aparece parpadeando la indicación 00:00. Pulsando las teclas  ó  pondrá el reloj en hora; a continuación escuchará 2 beep seguidos como confirmación de la hora elegida.

Si desea modificar la hora, pulse las teclas  ó  hasta que parpadee la hora actual. A continuación pulse la tecla OK. Pulsando las teclas  ó  podrá modificar la hora. Finalmente escuchará 2 beep seguidos como confirmación del cambio realizado.

Funcionamiento Manual

Tras poner el reloj en hora, su horno está listo para cocinar. Seleccione una función de cocinado y una temperatura.

Durante el cocinado observará que el símbolo  se ilumina para indicar la transmisión de calor al alimento. Este símbolo se apaga cuando se alcanza la temperatura seleccionada.

Para apagar el horno, ponga los mandos en posición .

Funciones del Reloj Electrónico





Avisador: Genera una señal acústica al cabo del tiempo, para ello no es necesario que el horno esté cocinando.

Duración del Cocinado: Permite cocinar durante un tiempo seleccionado, a continuación el horno se apagará de forma automática.





Hora de Finalización del Cocinado: Permite cocinar hasta una hora establecida, a continuación el horno se apagará de forma automática.

Duración y Fin del Cocinado: Permite programar la duración y la hora de finalización del cocinado. Con esta función el horno se pondrá en marcha de forma automática a la hora necesaria para cocinar durante el tiempo seleccionado (Duración) y finalizando de forma automática a la hora que le hayamos indicado (Fin del Cocinado).

Programación del Avisador

- 1 Pulse la tecla  hasta que el símbolo  se ilumine. A continuación pulse la tecla OK.
- 2 Seleccione el tiempo tras el cual desea que el reloj avise, pulsando las teclas  ó .



3 Posteriormente sonarán 2 beep seguidos, se mostrará el tiempo restante hasta que el reloj avise y el símbolo  permanecerá parpadeando.



Si desea modificar el tiempo seleccionado, pulse la tecla OK de forma prolongada durante varios segundos hasta que aparezca la hora actual. Pulse la tecla  hasta que el símbolo  se ilumine, pulse la tecla OK, por último pulsando las teclas  ó  podrá modificarlo.

4 Transcurrido el tiempo, sonará una señal acústica y el símbolo  empezará a parpadear más deprisa.





5 Pulse cualquier tecla para detener la señal acústica.

Programación de la Duración del Cocinado

1 Pulse las teclas  ó  hasta que el símbolo  se ilumine. A continuación pulse la tecla OK.

2 Seleccione la duración, pulsando las teclas  ó .

3 Posteriormente sonarán 2 beep seguidos, se mostrará el tiempo restante hasta la finalización del cocinado y el símbolo  permanecerá iluminado.

Si desea modificar el tiempo seleccionado, pulse las teclas  ó  hasta que aparezca la hora actual y el símbolo  parpadee. A continuación pulse la tecla OK, por último pulsando las teclas  ó  podrá modificarlo.



4 Seleccione una función y una temperatura de cocinado.



5 Transcurrido el tiempo sonará una señal acústica, aparecerá **End** en la pantalla y el símbolo  parpadeará.

6 Pulse cualquier tecla para detener la señal acústica, encendiéndose el horno de nuevo.





7 Ponga los mandos en posición  para apagar el horno.

Programación de la Hora de Finalización del Cocinado

1 Pulse las teclas  ó  hasta que el símbolo  se ilumine. A continuación pulse la tecla OK.

2 Seleccione la hora de finalización del cocinado, pulsando las teclas  ó .

3 Posteriormente sonarán 2 beep seguidos, se mostrará el tiempo restante hasta la finalización del cocinado y el símbolo  permanecerá iluminado.

Si desea modificar el tiempo seleccionado, pulse las teclas  ó  hasta que aparezca la hora actual y el símbolo  parpadee. A continuación pulse la tecla OK, por último pulsando las teclas  ó  podrá modificarlo.



4 Seleccione una función y una temperatura de cocinado.



5 Transcurrido el tiempo sonará una señal acústica, aparecerá **End** en la pantalla y el símbolo  parpadeará.

6 Pulse cualquier tecla para detener la señal acústica, encendiéndose el horno de nuevo.



7 Ponga los mandos en posición  para apagar el horno.



Programación de la Duración y Fin del Cocinado



1 Pulse las teclas  ó  hasta que el símbolo  se ilumine. A continuación pulse la tecla OK.







2 Seleccione la duración, pulsando las teclas  ó .



3 Posteriormente sonarán 2 beep seguidos, se mostrará el tiempo restante hasta la finalización del cocinado y el símbolo  permanecerá iluminado.

4 Pulse las teclas  ó  hasta que el símbolo  se ilumine. A continuación pulse la tecla OK.

5 Seleccione la hora de finalización del cocinado, pulsando las teclas  ó .



6 Posteriormente sonarán 2 beep seguidos, aparecerá **Auto** en la pantalla y los símbolos  y  permanecerán iluminados. Su reloj está programado, quedando el horno desconectado.

Si desea modificar la duración, pulse las teclas  ó  hasta que aparezca la hora actual y el símbolo  parpadee. Si desea modificar la hora de finalización, pulse las teclas  ó  hasta que aparezca la hora actual y el símbolo  parpadee.

A continuación pulse la tecla OK, por último pulsando las teclas  ó  podrá modificar el valor seleccionado.

7 Seleccione una función y una temperatura de cocinado.

8 Cuando se alcance la hora de comienzo, el horno se pondrá en marcha y realizará el cocinado, mostrando el tiempo restante en la pantalla.

9 Alcanzada la hora de finalización, el horno se desconectará, sonará una señal acústica, aparecerá **End** en la pantalla y los símbolos  y  parpadearán.

10 Pulse cualquier tecla para detener la señal acústica, encendiéndose su horno de nuevo.

11 Ponga los mandos en posición  para apagar el horno.

Atención

En caso de un corte de suministro eléctrico, se borrará toda la programación de su reloj electrónico y aparecerá parpadeando la indicación 00:00 en el reloj. Deberá ponerlo en hora y programarlo de nuevo.



Descrição do Aparelho

Modelo HA-900

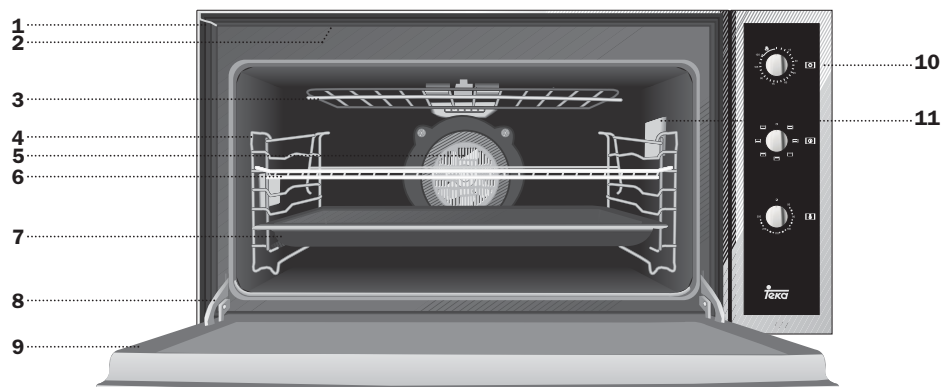

Modelo HA-935

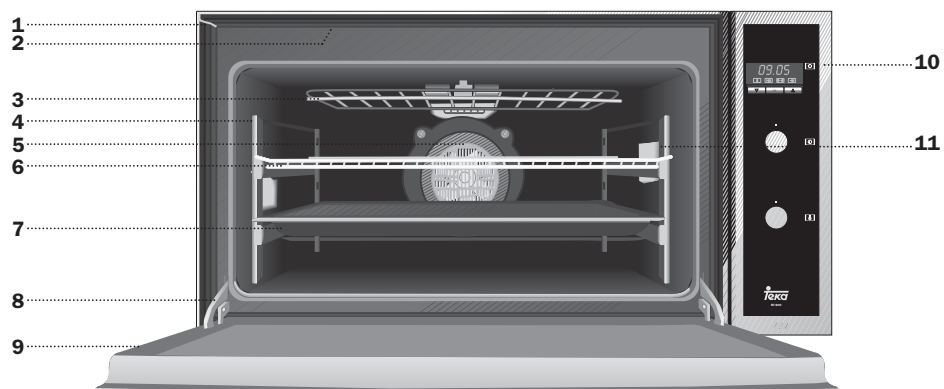

- | | | | | | |
|---|--------------------------------|---|--------------------------------------|----|--------------------|
| 1 | Fixação ao Móvel | 4 | Suporte Cromado/
Guia Telescópica | 8 | Dobradiça |
| 2 | Saída de ar
da Refrigeração | 5 | Turbina | 9 | Porta |
| 3 | Resistência do Grill | 6 | Grelha | 10 | Painel de Comandos |
| | | 7 | Bandeja para Assados | 11 | Lâmpadas |

Painel de Comandos

Modelo HA-900

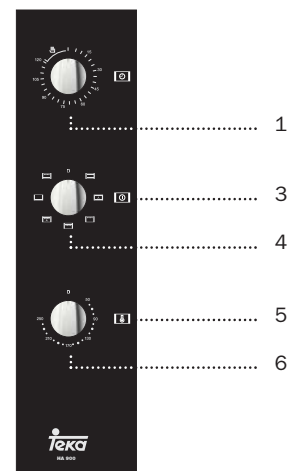

Modelo HA-935

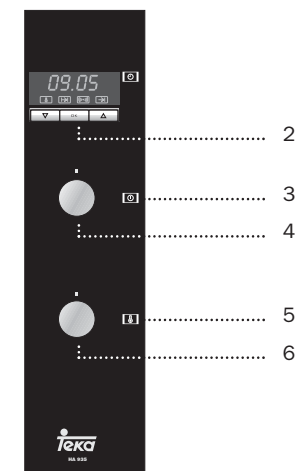

- 1 Comando temporizador de minutos.
- 2 Relógio electrónico.
- 3 Piloto de funcionamento do forno.
- 4 Selector de funções.

- 5 Piloto de aquecimento. Indica a transmissão de calor ao alimento e desliga-se quando o forno alcança a temperatura seleccionada.
- 6 Selector de temperatura.

Funções do Forno

Modelo HA-900



Modelo HA-935

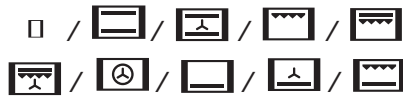

Desconexão do forno

Convencional

Usado em bolos e tartes nos quais o calor recebido deve ser uniforme para que adquiram uma textura esponjosa.

Convencional com Turbina

Adequado para assados e pastelaria. O ventilador reparte de forma uniforme o calor no interior do forno.

Grill

Gratina e assa superficialmente. Permite alourar a camada exterior sem afectar o interior do alimento. Indicado para pedaços planos como filetes, costelas, peixe, tostas.

MaxiGrill

Permite gratinar superfícies maiores que com o Grill, bem como gratinar com maior potência, alourando assim o alimento de forma mais rápida.

MaxiGrill com Turbina

Permite assar de modo uniforme ao mesmo tempo que aloura superficialmente. Ideal para churrascos. Especial para pedaços com grande

volume como aves, caça,... Recomenda-se colocar a porção de carne sobre a grelha do forno com a bandeja por baixo, para recolher os molhos ou gorduras.

Atenção

Durante o uso da função Grill, MaxiGrill ou MaxiGrill com Turbina deve-se manter a porta fechada.

Turbo

A turbina reparte o calor que provém de uma resistência situada na parte de trás do forno. Devido à uniformidade da temperatura produzida permite cozinhar em 2 alturas ao mesmo tempo.

Esta função permite a descongelação leve do alimentos. Para sua utilização coloque o selector de temperatura na posição

Resistência Inferior

Calor somente na parte inferior. Apropriado para aquecer pratos ou levantar massas de confeitaria e semelhantes.

Resistência Inferior com Turbina

Distribui o calor que provém da parte inferior do forno. Ideal para pastéis com recheio de geleia ou fruta, os quais só necessitam de calor na parte inferior. É sempre necessário realizar um pré-aquecimento.

Grill e Resistência Inferior

Especial para assados. Pode ser usado para qualquer porção, independente do seu tamanho.

Nota

A lâmpada permanece acesa em qualquer função de cozinhado.

Uso do Forno

Modelo HA-900

Funcionamento Manual do Forno

- 1 Rode o comando do temporizador para a esquerda até à posição
- 2 Seleccione uma temperatura e uma função de cozinhado.
- 3 Coloque os comandos na posição

Funcionamento Temporizado do Forno

Permite cozinhar durante um tempo previamente seleccionado. Para tal:

- 1 Escolha a função e a temperatura de cozinhado.
- 2 Rode o comando do temporizador no sentido dos ponteiros do relógio, até à posição "120" minutos e depois rode-o no sentido inverso para seleccionar o tempo de cozinhado pretendido.
- 3 Decorrido o tempo programado, ouvir-se-á um sinal acústico e o forno deixará de aquecer.
- 4 Coloque os comandos na posição

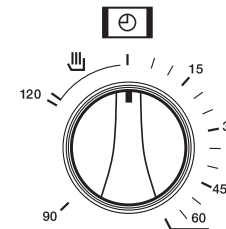

Modelo HA-935

Acerto do Relógio Electrónico

Ao ligar o forno, observará que, no relógio, aparece a piscar a indicação 00:00. Premindo as teclas ou acertará o relógio; a seguir ouvirá 2 beeps seguidos como confirmação da hora seleccionada.

Se desejar alterar a hora, prima as teclas ou até a hora actual começar a piscar. A seguir prima a tecla . Premindo as teclas ou poderá modificar a hora. Finalmente, ouvirá 2 beeps seguidos como confirmação da alteração realizada.

Funcionamento Manual

Depois de acertar o relógio, o forno está pronto para cozinhar. Seleccione uma função de cozinhado e uma temperatura.

Durante o cozinhado, o símbolo ilumina-se indicando que o forno está a transmitir calor ao alimento, e desliga-se quando é atingida a temperatura seleccionada.

Para desligar o forno, coloque os comandos na posição .

Funções do Relógio Electrónico

Avisador: Gera um sinal acústico ao fim de algum tempo, para tal, não é necessário que o forno esteja a cozinhar.

Duração do Cozinhado: Permite cozinhar durante um tempo seleccionado; de seguida, o forno desligar-se-á de forma automática.





Hora de Finalização do Cozinhado: Permite cozinhar até a uma hora estabelecida, de seguida, o forno desligar-se-á de forma automática.

Duração e Fim do Cozinhado: Permite programar a duração e a hora de finalização do cozinhado. Com esta função, o forno colocar-se-á em funcionamento de forma automática à hora necessária para cozinhar durante o tempo seleccionado (Duração), finalizando de forma automática à hora anteriormente indicada. (Fim do Cozinhado).

Programação do avisador

- 1 Prima a tecla até o símbolo se iluminar. De seguida, prima a tecla OK.
- 2 Seleccione o tempo após o qual deseja que o relógio avise, premindo as teclas ou .





3 Posteriormente ouvirá 2 beeps consecutivos, e será mostrado o tempo restante para o relógio avisar, o símbolo  permanecerá a piscar.



Se desejar alterar o tempo seleccionado, prima a tecla OK de forma prolongada até aparecer a hora actual. Prima a tecla  até o símbolo  se iluminar e prima a tecla OK; finalmente, poderá modificá-lo premindo as teclas  ou .

4 Decorrido o tempo, soará um sinal acústico e o símbolo  começará a piscar rapidamente.





5 Prima qualquer tecla para cessar o sinal acústico.

Programação da Duração do Cozinhado

1 Prima as teclas  ou  até o símbolo  se iluminar. De seguida, prima a tecla .

2 Seleccione a duração do cozinhado, premindo as teclas  ou .

3 Posteriormente ouvirá 2 beeps consecutivos, será mostrado o tempo restante até à finalização do cozinhado e o símbolo  permanecerá iluminado.

Se desejar alterar o tempo seleccionado, prima as teclas  ou  até que apareça a hora actual e o símbolo  pisque. De seguida, prima a tecla OK; finalmente, poderá modificá-lo premindo as teclas  ou .



4 Seleccione uma função e uma temperatura de cozinhado.



5 Decorrido o tempo soará um sinal acústico, aparecerá **End** no display e o símbolo  piscará.

6 Prima qualquer tecla para cessar o sinal acústico, o forno liga novamente.





7 Coloque os comandos na posição  para desligar o forno.

Programação da Hora de Finalização do Cozinhado

1 Prima as teclas  ou  até o símbolo  se iluminar. De seguida, prima a tecla OK.

2 Seleccione a hora de finalização do cozinhado, premindo as teclas  ou .

3 Posteriormente ouvirá 2 beeps consecutivos, será mostrado o tempo restante até à finalização do cozinhado e o símbolo  permanecerá iluminado.

Se desejar alterar o tempo seleccionado, prima as teclas  ou  até aparecer a hora actual e o símbolo  piscar. A seguir prima a tecla OK; finalmente, poderá modificá-lo premindo as teclas  ou .



4 Seleccione uma função e uma temperatura de cozinhado.



5 Decorrido o tempo soará um sinal acústico, aparecerá **End** no display e o símbolo  piscará.

6 Prima qualquer tecla para cessar o sinal acústico, o forno liga novamente.



7 Coloque os comandos na posição  para desligar o forno.



Programação da Duração e Fim do Cozinhado



1 Prima as teclas  ou  até o símbolo  se iluminar. A seguir prima a tecla OK.







2 Seleccione a duração do cozinhado, premindo as teclas  ou .



3 Posteriormente ouvirá 2 beeps seguidos, será mostrado o tempo restante até à finalização do cozinhado e o símbolo  permanecerá iluminado.

4 Prima as teclas  ou  até o símbolo  se iluminar. A seguir prima a tecla OK.

5 Seleccione a hora de finalização do cozinhado, premindo as teclas  ou .



6 Posteriormente ouvirá 2 beeps seguidos, aparecerá **Auto** no display e os símbolos  e  permanecerão iluminados. O relógio está programado e o forno desliga.

Se desejar alterar a duração, prima as teclas  ou  até aparecer a hora actual e o símbolo  piscar. Se desejar modificar a hora de finalização, prima as teclas  ou  até aparecer a hora actual e o símbolo  piscar.

A seguir prima a tecla OK; por último, poderá modificar o valor seleccionado premindo as teclas  ou .

7 Seleccione uma função e uma temperatura de cozinhado.

8 Quando se atinge a hora de início, o forno entrará em funcionamento e efectuará o cozinhado, mostrando o tempo restante no display.

9 Atingida a hora de finalização, o forno desligar-se-á, soará um sinal acústico, aparecerá **End** no display e os símbolos  e  piscarão.

10 Prima qualquer tecla para cessar o sinal acústico, o forno liga novamente.

11 Coloque os comandos na posição  para desligar o forno.

Atenção

No caso de um corte de fornecimento eléctrico, será eliminada toda a programação do relógio electrónico e aparecerá a indicação 00:00 a piscar no relógio. Deverá acertá-lo e programá-lo de novo.



Oven Description

Model HA-900

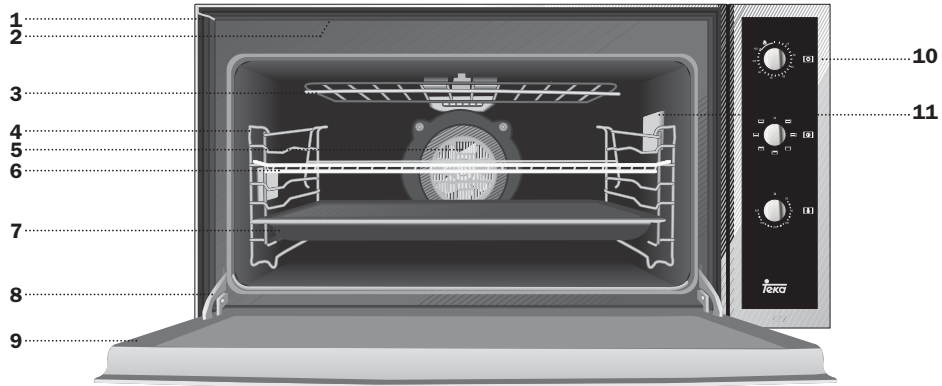

Model HA-935

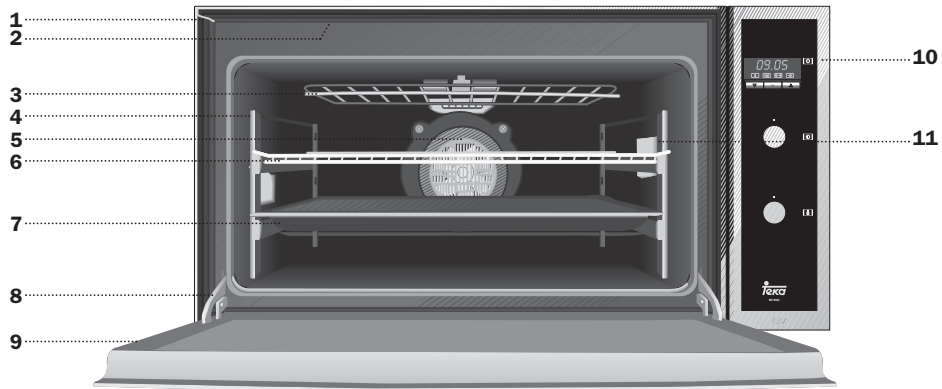

- | | | |
|--|-----------------|------------------|
| 1 Fixing to Unit | 5 Fan | 10 Control Panel |
| 2 Air Outlet | 6 Grid | 11 Light |
| 3 Fold-down Grill element | 7 Roasting Tray | |
| 4 Chromed Support/
Telescopic Guide | 8 Hinge | |
| | 9 Door | |

Control Panel

Model HA-900

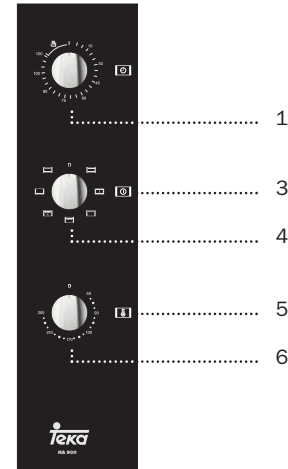

- 1 Minute timing switch.
- 2 Electronic timer.
- 3 Oven pilot light.
- 4 Function selector.

Model HA-935

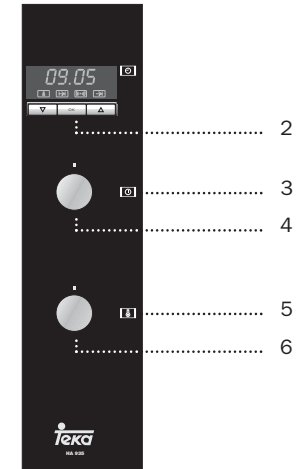

- 5 Heating indicator light. Indicates that heat is being passed to the food and it goes out when the set temperature is reached.
- 6 Temperature selector.

Oven Functions

Model HA-900



Model HA-935

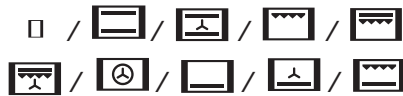

□ Switch off oven

Conventional

It is used for sponges and cakes where the heat received must be uniform to achieve a spongy texture.

Conventional with fan

Appropriate for roasts and cakes. The fan spreads the heat uniformly inside the oven.

Grill

For preparing dishes with superficial roasting. It allows the outer layer to be browned without affecting the inside of the food. Ideal for flat food, such as steaks, ribs, fish, toast.

MaxiGrill

Allows greater surfaces to be prepared, than with the grill, together with higher power reducing the time required for browning of the food.

MaxiGrill with fan

Allows uniform roasting at the same time as surface browning. Ideal for grills. Special for large volume pieces, such as poultry, game etc.

It is recommended to put the item on a rack with a tray beneath to collect the stock and juices.

Caution

While using the Grill, MaxiGrill or MaxiGrill with fan, the door must be kept closed.

Turbo

The fan distributes the heat produced by an element located at the rear of the oven. Due to the uniform heat distribution, it allows roasting and baking to take place at two heights at the same time.

This cooking mode allows defrosting of food. To do this, set the temperature selector to □ position.

Lower element

Heats only from beneath. Suitable for heating dishes and raising pastry and similar.

Lower element with fan

It distributes the heat from the lower part of the oven and is ideal for cakes with jam or fruit filling, which only require heating from beneath. Pre-heating is always necessary.

Grill and Lower element

Special for roasts. It can be used for any piece, whatever its size.

Note

The pilot light remains on in any cooking function.

Use of the Oven

Model HA-900

Manual use of the oven

- 1 Turn the timing switch to the left to the position .
- 2 Select a temperature and a cooking function.
- 3 Set the controls in position □ to switch off the oven.

Using the timer switch



Allows cooking during a pre-established time. To do this,

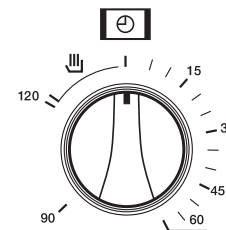



- 1 Select the function and the cooking temperature.
- 2 Turn the timer control clockwise as far as the position “120 minutes” and then turn it backwards to the required cooking period.
- 3 When the time has finished, there will be an acoustic signal and the oven will stop heating.
- 4 Set the controls to the position □ to switch off the oven.



Model HA-935



Setting the time on the Electronic Clock

When the oven is connected to the power supply, the indication 00:00 flash on the display. Press  or  to set the time on the clock. The clock beeps twice to confirm the selected time.

If you wish to modify the time, press  or  until the current time flash on the screen. Press . Then press  or  to modify the time. The clock beeps twice to confirm the modification.

Manual Operation

The oven is ready to be used when the clock has been set. Select a cooking function and a temperature.

When you begin cooking, symbol  lights up to indicate that the oven is heating the contents; the symbol  goes out when the selected temperature is reached.

Set the controls to □ to turn the oven off.

Functions of the Electronic Clock





Alarm: Creates an alarm signal when the period of time finishes; the oven does not need to be in use in order to use this function.

Cooking Time: To cook for a selected length of time; the oven turns itself off automatically when the time finishes.

End Cooking Time: To cook until a set time; the oven turns itself off automatically when the time finishes.

Cooking time and End Cooking Time: To cook for a selected length of time and end at a set time. When this function is set, the oven comes on automatically at the time required in order to cook for the set length of time (Cooking time) and end automatically at the indicated time (End Cooking Time).

Programming the Alarm

- 1 Press  until symbol  lights up. Press .
- 2 Set the period of time after which you wish the alarm to sound by pressing  or .

3 The clock beeps twice, the countdown to the alarm is displayed and symbol 🔔 flashes.

If you wish to modify the time set, press OK and keep it pressing in until the current time appears. Press △ until symbol 🔔 lights up permanently and press OK. Then use ▽ and △ to change the set time.

4 When the set period of time comes to an end, the alarm sounds and symbol 🔔 starts to flash faster.

5 Press any button to turn the alarm off.

Setting the Cooking Time

1 Press ▽ or △ until symbol ⏪ lights up. Press OK.

2 Select the period of time you wish to cook for by pressing ▽ or △.

3 The clock beeps twice, the countdown to the end of the cooking time is displayed and symbol ⏪ lights up permanently.

If you wish to modify the time set, press ▽ or △ until the current time appears and symbol ⏪ starts to flash. Press OK. The time can then be adjusted by pressing ▽ or △.

4 Select a cooking function and a temperature.

5 When the cooking time comes to an end, the alarm sounds, **End** is displayed on the screen and symbol ⏪ starts to flash.

6 Press any button to stop the alarm. The oven turns itself back on again.

7 Set the controls to 🔌 to turn the oven off.

Setting the End Cooking Time

1 Press ▽ or △ until symbol ⏩ lights up. Press OK.

2 Select the time you wish the cooking process to finish at by pressing ▽ or △.

3 The clock beeps twice, the countdown to the end of the cooking time is displayed and symbol ⏩ lights up permanently.

If you wish to modify the time set, press ▽ or △ until the current time appears and symbol ⏩ starts to flash. Press OK. The time can then be adjusted by pressing ▽ or △.

4 Select a cooking function and a temperature.

5 When the cooking time comes to an end, the alarm sounds, **End** is displayed on the screen and symbol ⏩ starts to flash.

6 Press any button to stop the alarm. The oven turns itself back on again.

7 Set the controls to 🔌 to turn the oven off.

Setting the Cooking Time and the End Cooking Time

1 Press ▽ or △ until symbol ⏪ lights up. Press OK.

2 Select the period of time you wish to cook for by pressing ▽ or △.

3 The clock beeps twice, the countdown to the end of the cooking time is displayed and symbol ⏪ lights up permanently.

4 Press ▽ or △ until symbol ⏩ lights up. Press OK.

5 Select the time you wish the cooking process to finish at by pressing ▽ or △.

6 The clock beeps twice, **Auto** is displayed on the screen and symbols ⏪ and ⏩ light up permanently. The clock is set and the oven remains off.

If you wish to modify the cooking time, press ▽ or △ until the current time appears and symbol ⏪ starts to flash. If you wish to modify the end cooking time, press ▽ or △ until the current time appears and symbol ⏩ starts to flash.

Press OK. The time selected can then be adjusted by pressing ▽ or △.

7 Select a cooking function and a temperature.

8 When the time to start cooking is reached, the oven starts up and the remaining time is displayed on the screen.

9 When the time to end cooking is reached, the oven turns itself off, the alarm sounds, **End** is displayed on the screen and symbols ⏪ and ⏩ start to flash.

10 Press any button to stop the alarm. The oven turns itself back on again.

11 Set the controls to 🔌 to turn the oven off.

Important

In the event of a power cut, all the electronic clock settings are deleted and the indication 00:00 flashes on the display. It is necessary to set the time and programme the clock again.



Description de L'Appareil

Modèle HA-900

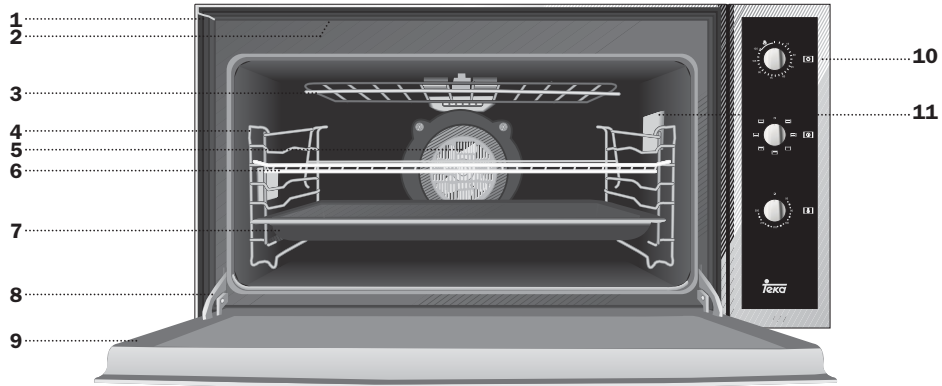

Modèle HA-935

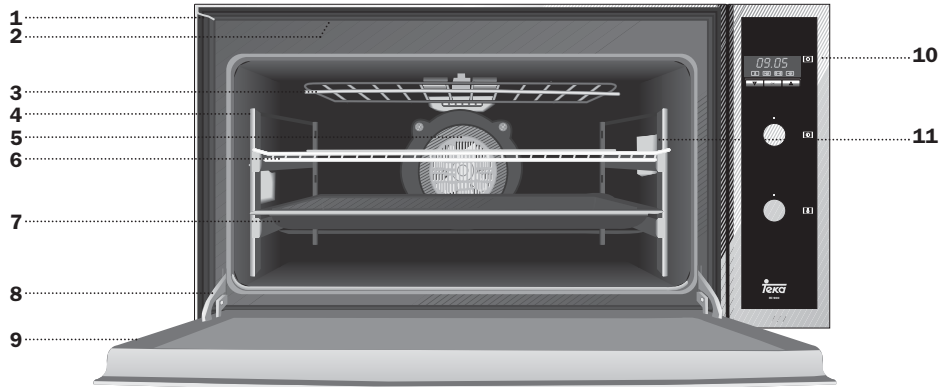

- | | | |
|---------------------------------------|---|-----------------------------------|
| 1 Fixation au Meuble | 4 Support Chromé/
Guide Téléscopique | 8 Charnière |
| 2 Sortie de l'air
de Réfrigération | 5 Turbine | 9 Porte |
| 3 Résistance du Grill
Abattable | 6 Grille | 10 Panneau Frontal de
Commande |
| | 7 Plateau pour Rôtis | 11 Lampe |

Panneau Frontal de Commande

Modèle HA-900

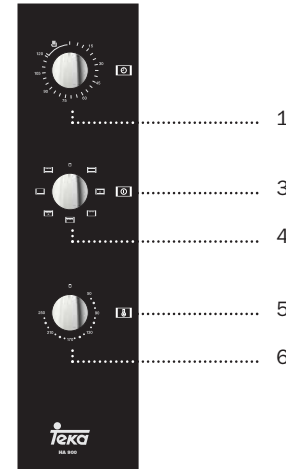

Modèle HA-935

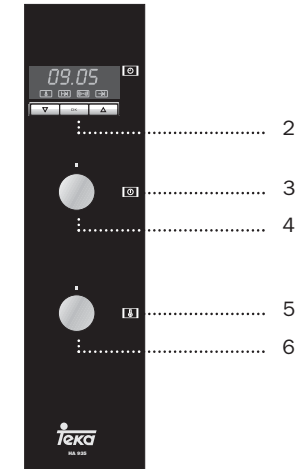

- 1 Commande de la minuterie.
- 2 Horloge électronique.
- 3 Voyant lumineux de connexion du four.
- 4 Sélecteur de fonctions.

- 5 Voyant lumineux de chauffage. Il indique que la chaleur est transmise à l'aliment et s'éteint quand la température choisie est atteinte.
- 6 Sélecteur de température.

Fonctions du Four

Modèle HA-900



Modèle HA-935



□ Arrêt du four

Conventionnel

Utiliser pour les gâteaux et les tartes qui doivent recevoir une chaleur uniforme et pour obtenir une texture moelleuse.

Conventionnel avec turbine

Recommandé pour les rôtis et la pâtisserie. Le ventilateur répartit la chaleur de façon uniforme à l'intérieur du four.

Grill

Pour gratiner et rôtir superficiellement. Permet de dorer la couche extérieure sans affecter l'intérieur de l'aliment. Indiqué pour les pièces plates telles que les beefsteaks, les côtelettes, les poissons, les toasts.

MaxiGrill

Permet de gratiner des surfaces plus grandes qu'avec le Grill avec une puissance pour gratiner supérieure, qui permet ainsi de dorer l'aliment de façon plus rapide.

MaxiGrill avec turbine

Permet en même temps de rôtir de façon uniforme et de dorer superficiellement. Idéal pour les grillades. Spécial pour les pièces volumineuses telles que les volailles, le gibier. Il est recommandé de placer la pièce de

viande sur la grille du four et la lèche-frite en-dessous pour recueillir les jus de cuisson ou la graisse.

Attention

Quand on utilise la fonction Grill, MaxiGrill ou MaxiGrill avec Turbine, la porte doit rester fermée.

Turbo

La turbine répartit la chaleur qui provient d'une résistance située à la partie arrière du four. Grâce à l'uniformité de la chaleur produite, on peut cuisiner à 2 hauteurs en même temps.

Cette fonction permet de décongeler doucement des mets. Pour l'utilisation, réglez le sélecteur des températures sur la position □.

Résistance inférieure

La chaleur provient seulement de la partie inférieure. Approprié pour réchauffer des plats ou faire lever des pâtes pour pâtisseries et analogues.

Résistance inférieure avec Turbine

Elle distribue la chaleur qui provient de la partie inférieure du four. Idéal pour les gâteaux fourrés avec de la confiture ou des fruits, qui requièrent seulement un apport de chaleur inférieur. Il est toujours nécessaire de préchauffer.

Grill et résistance inférieure

Spécial pour les rôtis. Peut être utilisé pour toutes sortes de pièces, indépendamment de leur volume.

Attention

La lampe reste allumée pendant toutes les fonctions de cuisson.

Maniement du Four

Modèle HA-900

Fonctionnement Manuel du Four

- 1 Tourner la commande de la minuterie vers la gauche jusqu'à la position .
- 2 Sélectionner une température et une fonction de cuisson.
- 3 Mettre les commandes sur la position □ pour éteindre le four.

Fonctionnement temporisé du four

Cela permet de cuisiner pendant un temps préalablement sélectionné. Pour cela:

- 1 Choisir la fonction et la température de cuisson.
- 2 Tourner la commande de la minuterie dans le sens des aiguilles d'une montre jusqu'à la position "120" minutes et la tourner ensuite en sens inverse pour sélectionner le temps de cuisson désiré.
- 3 Une fois passé le temps programmé, un signal acoustique se fera entendre et le four arrêtera de chauffer.
- 4 Mettre les commandes sur la position □ pour éteindre le four.

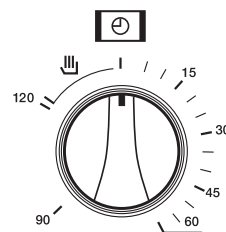

Modèle HA-935

Mise à l'heure de l'horloge électronique

Lorsque vous branchez votre four, vous observez que l'indication 00:00 clignotent dans l'horloge. Mettez l'horloge à l'heure à l'aide des touches ∇ ou ∆. Vous entendrez 2 bips consécutifs comme confirmation de la mise à l'heure.

Si vous souhaitez modifier l'heure, appuyez sur les touches ∇ ou ∆ jusqu'à ce que l'heure actuelle se mettent à clignoter. Appuyez ensuite sur la touche OK. À l'aide des touches ∇ ou ∆, vous pouvez alors modifier l'heure. Vous entendrez 2 bips consécutifs comme confirmation de la modification réalisée.

Fonctionnement manuel

Une fois l'horloge mise à l'heure, votre four est prêt à fonctionner. Sélectionnez une fonction de cuisson et une température.

Lors de la cuisson, le symbole  s'allume indiquant que le four est en train de transmettre de la chaleur à l'aliment et s'éteint lorsque la température sélectionnée est atteinte.

Pour éteindre le four, mettez les commandes sur la position □.

Fonctions de l'horloge électronique

Avertisseur: génère un signal acoustique à un moment donné; pour ce faire, il n'est pas nécessaire que le four soit allumé.

Durée de cuisson: permet de cuire pendant une durée sélectionnée, le four s'éteignant de façon automatique.





Heure de fin de cuisson: permet de cuire jusqu'à une heure définie, le four s'éteignant de façon automatique.

Durée et fin de cuisson: permet de programmer la durée et l'heure de fin de cuisson. Avec cette fonction, le four se mettra en marche de façon automatique à l'heure indiquée pour cuire pendant la durée sélectionnée (Durée) et s'éteindre de façon automatique à l'heure indiquée (Fin de cuisson).

Programmation de l'avertisseur

- 1 Appuyez sur la touche ∆ jusqu'à ce que le symbole  s'éclaire. Ensuite appuyez sur la touche OK.
- 2 Sélectionnez le temps au terme duquel vous souhaitez que l'horloge avertisse, en appuyant sur les touches ∇ ou ∆.





3 Postérieurement, 2 beep de suite sonneront, le temps restant jusqu'à ce que l'horloge avertisse apparaîtra et le symbole  clignotera.

Si vous souhaitez modifier le temps sélectionné, appuyez sur la touche OK de façon prolongée jusqu'à ce que l'heure actuelle apparaisse. Appuyez sur la touche  jusqu'à ce que le symbole  s'éclaire et appuyez sur la touche OK, finalement en appuyant sur les touches  ou  vous pourrez le modifier.

4 Une fois le temps écoulé, un signal acoustique sonnera et le symbole  commencera à clignoter plus vite.





5 Appuyez sur n'importe quelle touche pour arrêter le signal acoustique.

Programmation de la Durée de la Cuisson

1 Appuyez sur les touches  ou  jusqu'à ce que le symbole  s'allume. Appuyez sur la touche .

2 Sélectionnez la durée de la cuisson, en appuyant sur les touches  ou .

3 Postérieurement, 2 beep de suite sonneront, le temps restant jusqu'à la fin de la cuisson apparaîtra et le symbole  restera allumé.

Si vous souhaitez modifier le temps sélectionné, appuyez sur les touches  ou  jusqu'à ce que l'heure actuelle apparaisse et que le symbole  clignote. Ensuite appuyez sur la touche OK, et finalement en appuyant sur les touches  ou  vous pourrez le modifier.



4 Sélectionnez une fonction et une température de cuisson.



5 Une fois le temps écoulé, un signal acoustique sonnera, **End** apparaîtra sur l'écran et le symbole  clignotera.

6 Appuyez sur n'importe quelle touche pour arrêter le signal acoustique, le four s'allumant alors à nouveau.





7 Mettez les commandes sur la position  pour éteindre le four.

Programmation de l'Heure de Finalisation de la Cuisson

1 Appuyez sur les touches  ou  jusqu'à ce que le symbole  s'allume. Ensuite appuyez sur la touche OK.

2 Sélectionnez l'heure de finalisation de la cuisson, en appuyant sur les touches  ou .

3 Postérieurement, 2 beep de suite sonneront, le temps restant jusqu'à la finalisation de la cuisson apparaîtra et le symbole  restera allumé.

Si vous souhaitez modifier le temps sélectionné, appuyez sur les touches  ou  jusqu'à ce que l'heure actuelle apparaisse et que le symbole  clignote. Ensuite appuyez sur la touche OK, et finalement en appuyant sur les touches  ou  vous pourrez le modifier.



4 Sélectionnez une fonction et une température de cuisson.



5 Une fois le temps écoulé, un signal acoustique sonnera, **End** apparaîtra sur l'écran et le symbole  clignotera.

6 Appuyez sur n'importe quelle touche pour arrêter le signal acoustique, le four s'allumant alors à nouveau.



7 Mettez les commandes sur la position  pour éteindre le four.



Programmation de la Durée et Fin de la Cuisson



1 Appuyez sur les touches  ou  jusqu'à ce que le symbole  s'allume. Ensuite appuyez sur la touche OK.







2 Sélectionnez la durée de la cuisson, en appuyant sur les touches  ou .



3 Postérieurement, 2 beep de suite sonneront, le temps restant jusqu'à la fin de la cuisson apparaîtra et le symbole  restera allumé.

4 Appuyez sur les touches  ou  jusqu'à ce que le symbole  s'allume. Ensuite appuyez sur la touche OK.

5 Sélectionnez l'heure de finalisation de la cuisson, en appuyant sur les touches  ou .

6 Postérieurement 2 beep de suite sonneront, **Auto** apparaîtra sur l'écran et les symboles  et  resteront allumés. Votre horloge est programmée, le four étant alors déconnecté.



Si vous souhaitez modifier la durée, appuyez sur les touches  ou  jusqu'à ce que l'heure actuelle apparaisse et que le symbole  clignote. Si vous souhaitez modifier l'heure de finalisation, appuyez sur les touches  ou  jusqu'à ce que l'heure actuelle apparaisse et que le symbole  clignote.

Ensuite appuyez sur la touche OK, et finalement en appuyant sur les touches  ou  vous pourrez modifier la valeur sélectionnée.

7 Sélectionnez une fonction et une température de cuisson.

8 Quand l'heure de commencement sera atteinte, le four se mettra en marche et réalisera la cuisson, en montrant le temps restant sur l'écran.

9 Une fois atteinte l'heure de finalisation, le four se déconnectera, un signal acoustique

sonnera, **End** apparaîtra sur l'écran et les symboles  et  clignoteront.

10 Appuyez sur n'importe quelle touche pour arrêter le signal acoustique, le four s'allumant alors à nouveau.

11 Mettez les commandes sur la position  pour éteindre le four.

Attention

En cas de coupure de l'alimentation électrique, toute la programmation de votre horloge électronique sera effacée et l'indication 00:00 clignotera dans l'horloge. Vous devrez la mettre à l'heure et la programmer à nouveau.



Beschreibung des Gerätes

Modell HA-900

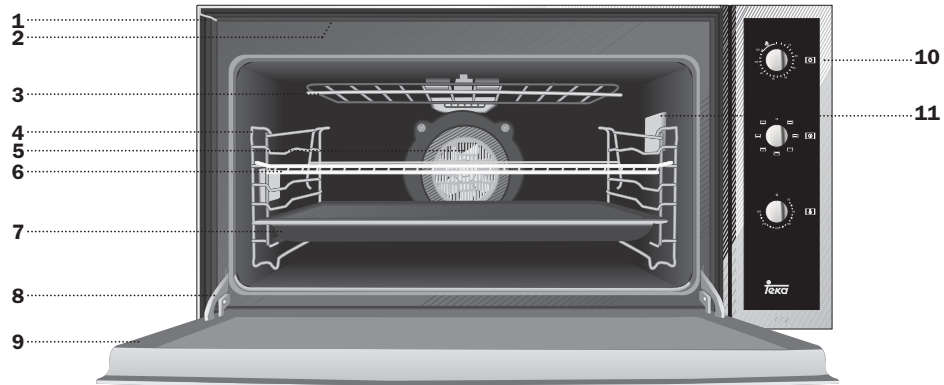

Modell HA-935

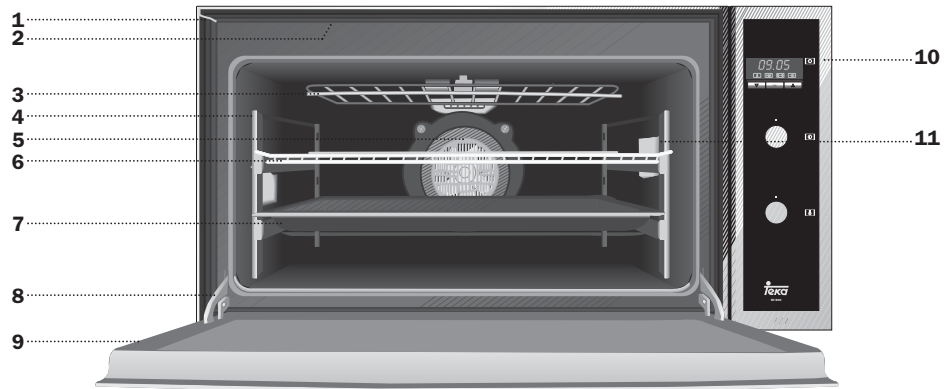

- | | | |
|---------------------------------|-----------------------------------|----------------|
| 1 Befestigung am
Küchenmöbel | 5 Ausziehbare Führungen
Lüfter | 9 Tür |
| 2 Kühlluftaustritt | 6 Rost | 10 Bedienfeld |
| 3 Schwenkbaren Grill | 7 Fettpfanne | 11 Beleuchtung |
| 4 Verchromte Halterung/ | 8 Scharnier | |

Bedienfeld

Modell HA-900

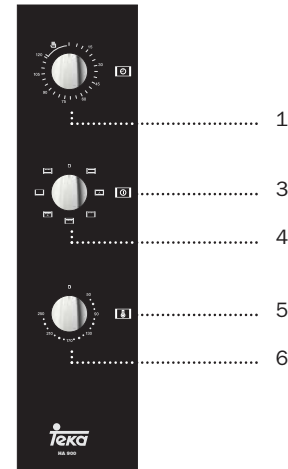

Modell HA-935

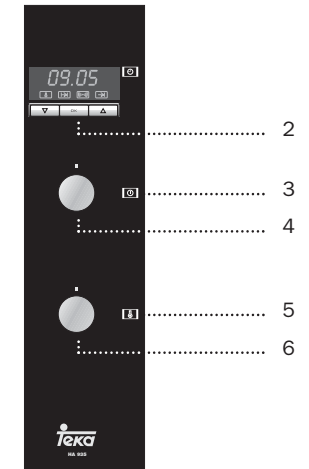

- 1 Bedienknopf der Zeitschaltuhr.
- 2 Elektronische Schaltuhr.
- 3 Kontrollleuchte Einschaltung Herd.
- 4 Funktionswahl.

- 5 Kontrollleuchte Heizen zeigt die Einschaltung der Heizelemente an und verlischt, wenn die eingestellte Temperatur erreicht ist.
- 6 Temperaturregler.

Funktionen des Herds

Modell HA-900



Modell HA-935

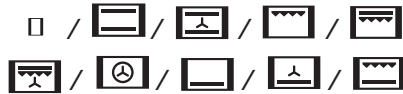

□ Ausschalten des Herds

Normal

Verwendung für Kuchen und Tortenböden, bei denen die Wärmeeinwirkung gleichmäßig sein muß, damit diese gut ausgehen.

Normal mit Umluft

Geeignet zum Braten und für Gebäck. Der Lüfter verteilt die Wärme gleichmäßig im Herd.

Grill

Gratinieren und Anbräunen. Gestattet das Anbräunen der Außenschicht, ohne das Innere der Nahrungsmittel zu beeinflussen. Geeignet für flache Stücke wie Beefsteak, Rippchen, Fisch, Toastbrot.

MaxiGrill

Grillen auf größerer Oberfläche und mit größerer Leistung als mit dem Grill, hierdurch erfolgt ein schnelleres Bräunen der Speisen.

MaxiGrill mit Umluft

Gestattet gleichzeitig ein gleichmäßiges Garen und Anbräunen der Oberfläche. Ideal zum Grillen. Besonders für große Stücke wie Geflügel, Wild usw. Es wird empfohlen, das Stück auf den Rost zu legen und die

Auffangschale darunter einzusetzen, um Bratensaft und Fett aufzufangen.

Achtung

Bei Benutzung der Funktionen Grill, MaxiGrill oder MaxiGrill mit Umluft muß die Herdtür geschlossen sein.

Turbo

Der Lüfter verteilt die von einem an der Rückseite des Herds angeordneten Heizwiderstand erzeugte Wärme. Auf Grund der erzeugten gleichmäßigen Temperaturverteilung ist ein Garen in 2 Etagen gleichzeitig möglich.

Wenn Sie den Temperaturregler auf null stellen, können Sie mit dieser Funktion die Nahrungsmittel auftauen.

Unterhitze

Es wird nur von der Unterseite Wärme zugeführt. Geeignet zum Anwärmen von Tellern, zum Aufgehen von Teigmassen oder für ähnliche Anwendungen.

Unterhitze mit Umluft

Verteilt die im Unterteil des Herds erzeugte Wärme. Ideal für Gebäck mit Marmeladen- oder Obstfüllung, bei denen eine Erwärmung von unten erfolgen muß. Der Herd muß immer vorgeheizt werden.

Grill und Unterhitze

Besonders geeignet zum Braten. Kann für Stücke mit beliebiger Größe eingesetzt werden.



Achtung

Die Beleuchtung ist bei allen Kochfunktionen eingeschaltet.

Bedienung des Herds

Modell HA-900

Manueller Betrieb des Herds

- 1 Drehen Sie den Drehknopf der Schaltuhr in die Stellung .
- 2 Wählen Sie eine Kochfunktion aus und stellen Sie die gewünschte Temperatur ein.
- 3 Zum Abschalten des Herds bringen Sie alle Bedienelemente in Stellung .

Betrieb des Herds mit Schaltuhr



Ermöglicht das Garen während einer vorher eingestellten Dauer. Hierzu gehen Sie bitte wie folgt vor:

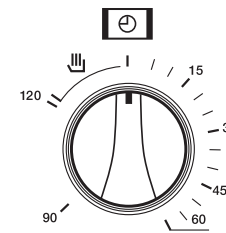



- 1 Wählen Sie eine Funktion aus und stellen Sie die gewünschte Temperatur ein.
- 2 Drehen Sie den Bedienknopf der Schaltuhr in Uhrzeigerichtung bis auf die Stellung "120 Minuten" und anschließend in entgegengesetzter Richtung bis zum Erreichen der gewünschten Garzeit.
- 3 Nach Ablauf der eingestellten Zeit ertönt ein akustisches Signal und der Herd wird abgeschaltet.
- 4 Zum Abschalten des Herds bringen Sie alle Bedienelemente in Stellung .



Modell HA-935

Stellen der elektronischen Schaltuhr

Nach dem Einschalten des Herds zeigt die elektronische Schaltuhr 00.00 an. Durch Betätigen der Tasten  oder  wird die Uhr gestellt; anschließend werden zwei kurze Signaltöne zur Bestätigung der eingestellten Uhrzeit abgegeben.

Zur Veränderung der eingestellten Uhrzeit betätigen Sie die Taste  oder  so oft, bis die aktuelle Uhrzeit blinken. Drücken Sie anschließend die Taste . Jetzt können Sie die Uhrzeit mit den Tasten  oder  einstellen. Nach Abschluss der Einstellung werden die Änderungen mit zwei kurzen Signaltönen bestätigt.

Manueller Betrieb

Nach dem Stellen der Uhr ist der Herd betriebsbereit. Wählen Sie  Garfunktion aus und stellen Sie die gewünschte Temperatur ein.

Zum Abschalten des Herds bringen Sie alle Bedienelemente in Stellung .

Funktionen der elektronischen Schaltuhr





Signalgeber: Sendet ein akustisches Signal nach Ablauf der eingestellten Zeit aus, der Herd muss hierzu nicht eingeschaltet sein.

Dauer des Garvorgangs: Gestattet das Garen während der eingestellten Zeit, anschließend wird der Herd automatisch abgeschaltet.





Endzeit des Garvorgangs: Gestattet das Garen bis zu der eingestellten Zeit, anschließend wird der Herd automatisch abgeschaltet.

Dauer und Ende des Garvorgangs: Mit Hilfe dieser Funktion können Sie die Dauer des Garvorgangs und die Uhrzeit einstellen, zu welcher dieser abgeschlossen sein soll. Mit dieser Funktion wird der Herd zum erforderlichen Zeitpunkt automatisch eingeschaltet, bleibt für die gewählte Dauer in Betrieb und schaltet sich automatisch zu der gewählten Endzeit aus (Ende des Garvorgangs).

Programmierung des Signalgebers







- 1 Betätigen Sie die Taste  bis das Symbol  aufleuchtet. Drücken Sie anschließend OK.
- 2 Stellen Sie mit den Tasten  oder  die Zeit ein, nach der die Schaltuhr das Signal abgeben soll.





- 3 Anschließend hören Sie zwei kurze Signaltöne, es wird die Restzeit bis zum Ertönen des akustischen Signals angezeigt und das Symbol  blinkt.



Wenn Sie die eingestellte Zeit verändern möchten, drücken Sie die Taste OK etwas länger, bis die aktuelle Zeit angezeigt wird. Betätigen Sie die Taste  bis das Symbol  aufleuchtet und drücken Sie dann OK, jetzt können Sie die eingestellte Zeit mit den Tasten  oder  verändern.

- 4 Nach Ablauf der eingestellten Zeit ertönt ein akustisches Signal und das Symbol  blinkt schneller.
- 5 Durch Betätigen einer beliebigen Taste wird das Signal abgestellt.







Programmierung der Garzeiten





- 1 Betätigen Sie die Taste  oder  bis das Symbol  aufleuchtet. Drücken Sie anschließend OK.
- 2 Stellen Sie mit den Tasten  oder  die gewünschte Garzeit ein.
- 3 Anschließend werden zwei kurze Signaltöne abgegeben, es wird die Restzeit bis zum Ablauf der Garzeit angezeigt und das Symbol  leuchtet ständig.

Drücken Sie Zur Einstellung der Zeit die Taste  oder  so oft, bis die aktuelle Zeit angezeigt wird und das Symbol  blinkt. Bestätigen Sie mit der Taste OK, mit  oder  können Sie die Zeit einstellen.

- 4 Wählen Sie eine Garfunktion aus und stellen Sie die gewünschte Temperatur ein.
- 5 Nach Ablauf der eingestellten Zeit ertönt ein akustisches Signal, auf dem Display wird **End** angezeigt und das Symbol  blinkt.
- 6 Betätigen Sie eine beliebige Taste zum Abstellen des Signaltons, hierdurch wird der Herd erneut eingeschaltet.
- 7 Zum Abschalten des Herds bringen Sie alle Bedienelemente in Stellung .









Programmierung der Uhrzeit für das Ende des Garvorgangs



- 1 Betätigen Sie die Taste  oder  bis das Symbol  aufleuchtet. Drücken Sie anschließend OK.
- 2 Stellen Sie die gewünschte Uhrzeit für die Beendigung des Garvorgangs mit den Tasten  und  ein.
- 3 Anschließend werden zwei kurze Signaltöne abgegeben, es wird die Restzeit bis zum Ablauf der Garzeit angezeigt und das Symbol  leuchtet ständig.



Drücken Sie zur Einstellung der Zeit die Taste  oder  so oft, bis die aktuelle Zeit angezeigt wird und das Symbol  blinkt. Bestätigen Sie mit der Taste OK, mit  oder  können Sie jetzt die Zeit einstellen.







- 4 Wählen Sie eine Garfunktion aus und stellen Sie die gewünschte Temperatur ein.
- 5 Nach Ablauf der eingestellten Zeit ertönt ein akustisches Signal, auf dem Display wird **End** angezeigt und das Symbol  blinkt.
- 6 Betätigen Sie eine beliebige Taste zum Abstellen des Signaltons, hierdurch wird der Herd erneut eingeschaltet.
- 7 Zum Abschalten des Herds bringen Sie alle Bedienelemente in Stellung .



Programmierung der Dauer der Garzeit und der Uhrzeit für dessen Beendigung.



- 1 Betätigen Sie die Taste  oder  bis das Symbol  aufleuchtet. Drücken Sie anschließend OK.
- 2 Stellen Sie mit den Tasten  oder  die gewünschte Garzeit ein.
- 3 Anschließend werden zwei kurze Signaltöne abgegeben, es wird die Restzeit bis zum Ablauf der Garzeit angezeigt und das Symbol  leuchtet ständig.
- 4 Betätigen Sie die Taste  oder  bis das Symbol  aufleuchtet. Drücken Sie anschließend OK.
- 5 Stellen Sie die gewünschte Uhrzeit für die

Beendigung des Garvorgangs mit den Tasten  und  ein.

- 6 Anschließend werden zwei kurze Signaltöne abgegeben, auf dem Display erscheint **Auto** und die Symbole  und  leuchten. Damit ist die Uhr programmiert, der Herd ist ausgeschaltet.

Drücken Sie Zur Einstellung der Garzeit die Taste  oder  so oft, bis die aktuelle Zeit angezeigt wird und das Symbol  blinkt. Drücken Sie Zur Einstellung der Endzeit die Taste  oder  so oft, bis die aktuelle Zeit angezeigt wird und das Symbol  blinkt.

Bestätigen Sie mit der Taste OK, mit  oder  können Sie die Zeit einstellen.

- 7 Wählen Sie eine Garfunktion aus und stellen Sie die gewünschte Temperatur ein.
- 8 Bei Erreichen der Uhrzeit für den Beginn des Garvorgangs schaltet sich der Herd ein und führt den Garvorgang während der eingestellten Zeitdauer aus, auf dem Display wird die Restzeit angezeigt.
- 9 Bei Erreichen der Endzeit schaltet sich der Herd ab, es ertönt ein akustisches Signal, auf dem Display wird **End** angezeigt und die Symbole  und  blinken.

- 10 Betätigen Sie eine beliebige Taste zum Abstellen des Signaltons, hierdurch wird der Herd erneut eingeschaltet.

- 11 Zum Abschalten des Herds bringen Sie alle Bedienelemente in Stellung .

Achtung

Bei einem Ausfall der elektrischen Stromversorgung wird die gesamte Programmierung der elektronischen Schaltuhr gelöscht, als Uhrzeit wird 00:00 blinkend angezeigt. Sie müssen diese anschließend stellen und erneut programmieren.

