

**TASCAM**  
TEAC Professional Division

# CD-VT1 MKII

## Portable CD Vocal Trainer

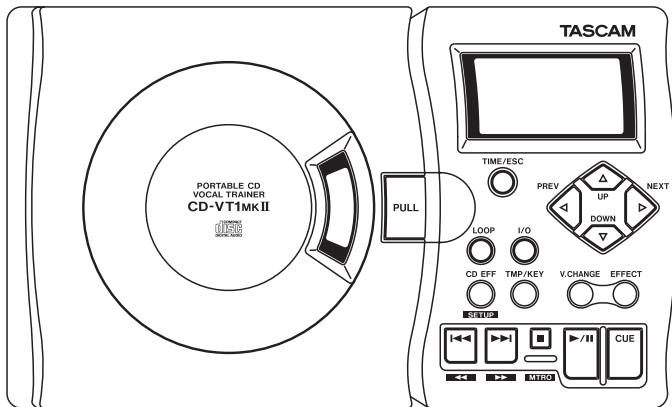

This appliance has a serial number located on the rear panel. Please record the model number and serial number and retain them for your records.

Model number \_\_\_\_\_

Serial number \_\_\_\_\_

**OWNER'S MANUAL (EN / F / D / I / E)**

## Important safety precautions



**CAUTION**  
RISK OF ELECTRIC SHOCK  
DO NOT OPEN



**CAUTION:** TO REDUCE THE RISK OF ELECTRIC SHOCK, DO NOT REMOVE COVER (OR BACK). NO USER-SERVICABLE PARTS INSIDE. REFER SERVICING TO QUALIFIED SERVICE PERSONNEL.



The lightning flash with arrowhead symbol, within an equilateral triangle, is intended to alert the user to the presence of uninsulated “dangerous voltage” within the product’s enclosure that may be of sufficient magnitude to constitute a risk of electric shock to persons.



**WARNING:** TO PREVENT FIRE OR SHOCK HAZARD, DO NOT EXPOSE THIS APPLIANCE TO RAIN OR MOISTURE.

FOR U.S.A.

TO THE USER

This equipment has been tested and found to comply with the limits for a Class B digital device, pursuant to Part 15 of the FCC Rules. These limits are designed to provide reasonable protection against harmful interference when the equipment is operated in a commercial environment. This equipment generates, uses, and can radiate radio frequency energy and, if not installed and used in accordance with the instruction manual, may cause harmful interference to radio communications. However, there is no guarantee that interference will not occur in a particular installation. If this equipment does cause harmful interference to radio or television reception, which can be determined by turning the equipment off and on, the user is encouraged to try to correct the interference by one or more of the following countermeasures.

- a) Reorient or relocate the receiving antenna
- b) Increase the separation between the equipment and receiver.
- c) Connect the equipment into an outlet on a circuit other from that to which the receiver is connected.
- d) Consult the dealer or an experienced radio/TV technician for help.

**CAUTION**

Changes or modifications to this equipment not expressly approved by TEAC CORPORATION for compliance could void the user’s authority to operate this equipment.

- 1 Read these instructions.
- 2 Keep these instructions.
- 3 Heed all warnings.
- 4 Follow all instructions.
- 5 Do not use this apparatus near water.
- 6 Clean only with dry cloth.
- 7 Do not block any ventilation openings. Install in accordance with the manufacturer's instructions.
- 8 Do not install near any heat sources such as radiators, heat registers, stoves, or other apparatus (including amplifiers) that produce heat.
- 9 Do not defeat the safety purpose of the polarized or grounding-type plug. A polarized plug has two blades with one wider than the other. A grounding type plug has two blades and a third grounding prong. The wide blade or the third prong are provided for your safety. If the provided plug does not fit into your outlet, consult an electrician for replacement of the obsolete outlet.
- 10 Protect the power cord from being walked on or pinched particularly at plugs, convenience receptacles, and the point where they exit from the apparatus.
- 11 Only use attachments/accessories specified by the manufacturer.
- 12 Use only with the cart, stand, tripod, bracket, or table specified by the manufacturer, or sold with the apparatus. When a cart is used, use caution when moving the cart/apparatus combination to avoid injury from tip-over.



- 13 Unplug this apparatus during lightning storms or when unused for long periods of time.
- 14 Refer all servicing to qualified service personnel. Servicing is required when the apparatus has been damaged in any way, such as power-supply cord or plug is damaged, liquid has been spilled or objects have fallen into the apparatus, the apparatus has been exposed to rain or moisture, does not operate normally, or has been dropped.
  - Do not expose this apparatus to drips or splashes.
  - Do not place any objects filled with liquids, such as vases, on the apparatus.
  - Do not install this apparatus in a confined space such as a book case or similar unit.
  - The apparatus draws nominal non-operating power from the AC outlet with its POWER switch in the off position.

### Safety Information

This product has been designed and manufactured according to FDA regulations "title 21, CFR, chapter 1, subchapter J, based on the Radiation Control for Health and Safety Act of 1968", and is classified as a class 1 laser product. There is no hazardous invisible laser radiation during operation because invisible laser radiation emitted inside of this product is completely confined in the protective housings. The label required in this regulation is shown here.

#### CAUTION

- DO NOT REMOVE THE PROTECTIVE HOUSING USING A SCREWDRIVER.
- USE OF CONTROLS OR ADJUSTMENTS OR PERFORMANCE OF PROCEDURES OTHER THAN THOSE SPECIFIED HEREIN MAY RESULT IN HAZARDOUS RADIATION EXPOSURE.
- IF THIS PRODUCT DEVELOPS TROUBLE, CONTACT YOUR NEAREST QUALIFIED SERVICE PERSONNEL, AND DO NOT USE THE PRODUCT IN ITS DAMAGED STATE.

Optical pickup: Type KSM-900AAA  
Manufacturer: SONY CORPORATION  
Laser output: <1 mW play on the objective lens  
Wavelength: 775—816 nm

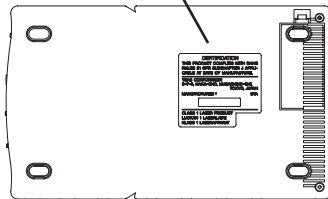

Handling of compact discs .....	6
About the power supply .....	7
Part names and functions .....	9
Making connections .....	12
Using the menu system .....	14
Using the CD player .....	16
Pitch and tempo changes .....	17
Using CD effects .....	18
Using built-in effects .....	19
Effect presets .....	20
Using the metronome / Using the oscillator .....	21
Changing your preferences for the CD-VT1MKII .....	22
Facts and figures (specifications) .....	23

## About this Manual:

When we refer to a key or connector or control on the CD-VT1MKII, the typeface looks like this: **PLAY**.

When we refer to items shown on the display, the typeface looks like this: MENU.

## Handling of compact discs

Observe the following:

- Always place compact discs in the tray with their label facing upward (compact discs can only be played on one side).
- To remove a disc from its storage case, press down on the center of the case, and lift the disc out, holding it carefully by the edges.



- Finger marks and dust should be carefully wiped off the disc's recorded surface with a soft cloth. Unlike conventional records, the compact disc has no grooves to collect dust and microscopic debris, so gently wiping with a soft cloth should remove most particles.
- Wipe in a straight motion from the inside to the outside of the

disc. Small dust particles and light stains will have absolutely no effect on reproduction quality.



- Never use such chemicals as record sprays, antistatic sprays or fluid, benzine or thinner to clean compact discs. Such chemicals will do irreparable damage to the disc's plastic surface.
- Discs should be returned to their cases after use to avoid serious scratches that could cause the laser pickup to "skip".
- Don't expose discs to direct sunlight or high humidity and temperature for extended periods. Long exposure to high temperature can warp the disc.

- Only use circular compact discs. Avoid using noncircular promotional, etc. discs.



- To keep the laser pickups clean, do not touch them. For the same reason, do not leave the disc tray open unnecessarily.
- The CD-VT1MKII cannot play unfinalized CD-R/RW discs. In addition, some finalized CD-R/RW discs may be unplayable on the CD-VT1MKII.

## Operation using batteries

Remove the cover of the battery compartment at the back of the CD-VT1MKII and insert four AA (SUM-3) batteries (not supplied) following the + and – markings inside the battery compartment.

### CAUTION

We strongly recommend the use of rechargeable Ni-MH batteries (alkaline batteries may also be used). Your CD-VT1MKII may not operate properly with batteries of other types.

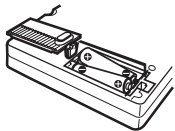

### WARNING

Misuse of batteries may cause leaks and explosions. Please carefully read and follow the instructions below:

### Notes on batteries

- When you are using the CD-VT1MKII with batteries, unplug the AC adapter.

- Make sure the batteries are inserted in the correct direction, according to the markings inside the battery compartment.
- Always use batteries of the same type, and replace all batteries together.
- Do not attempt to recharge batteries that are not rechargeable.
- If you are not going to use the CD-VT1MKII for longer than one month, remove the batteries.
- Do not throw batteries into water or fire. Do not disassemble batteries.
- If a battery leaks in the compartment, wipe the liquid away completely with a disposable cloth. Make certain no residue remains before inserting new batteries.

### Remaining battery charge level display

When the CD-VT1MKII is running on batteries, a rough indication of the remaining battery charge is displayed as

as the battery symbol as follows:

3 parts are lit 

There is plenty of battery charge left.

2 parts are lit 

Battery charge is approximately half.

1 part is lit 

Not much battery charge is left.

3 parts blink 

Battery charge is nearly gone. Replace with fully charged batteries.

### Length of battery life

- Ni-MH batteries: Approx. 4.5 hours
- Alkaline batteries: Approx. 1.5 hours

### Auto power-save

While using battery power, the CD player and CD functions of the CD-VT1MKII shut down automatically if any of the following conditions lasts more than 5 minutes: (the CD part of the display shows CD OFF).

*(continued on the next page)*

## About the power supply (Continued)

- Being in Stop mode
- CD drive cover is open
- No CD is loaded

To turn the CD player on, press the **PLAY** key.

### CAUTION

Because the CD-VT1MKII is equipped with special functions such as key change and effects, the battery life is shorter compared with standard portable CD players.

The length of battery life in CD-VT1MKII is affected by both the environment and the number of functions in use. Factors that affect battery life include temperature, humidity, the number of special functions used, and so on.

Under some circumstances, there may not be enough power in the batteries to power the CD-VT1MKII, despite the battery power indication on the display. If this happens, change the batteries, or use an AC adapter.

Always dispose of used batteries as recommended by your local authorities.

## Operation using an AC adapter

Connect a TASCAM PS-PS5 AC adapter (sold separately) to the **DC IN** jack at the back of the CD-VT1MKII.

Insert the plug of the AC adapter into a domestic AC power outlet. Make sure that the voltage of the outlet corresponds to that marked on the adapter.

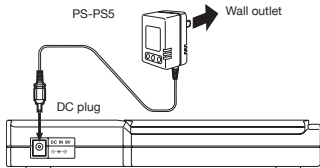

### WARNING

Use only a PS-PS5 AC adapter with your CD-VT1MKII. Using another type of AC adapter may damage your CD-VT1MKII.

### CAUTION

Remove the batteries before operating the CD-VT1MKII with an AC adapter. There is a possibility of slight noise if you use the unit

with an AC adapter while the batteries are inside. If you plug in an AC adapter but have forgotten to take out the batteries, turn the power off using the **POWER** switch, and take out the batteries. Likewise, turn the power off before you change between using the batteries and using the AC adapter.

Unplug the AC adapter from the domestic AC power outlet when you are not using the CD-VT1MKII.

Settings may not be properly saved if you turn the power off immediately after inserting a CD or changing settings. If settings are not saved properly, the system may not start with the last settings and instead will start using the default values.

## Switching the unit on and off

Use the **POWER** switch to turn the power to the whole unit on and off.





## Part names and functions

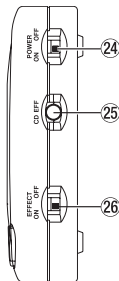
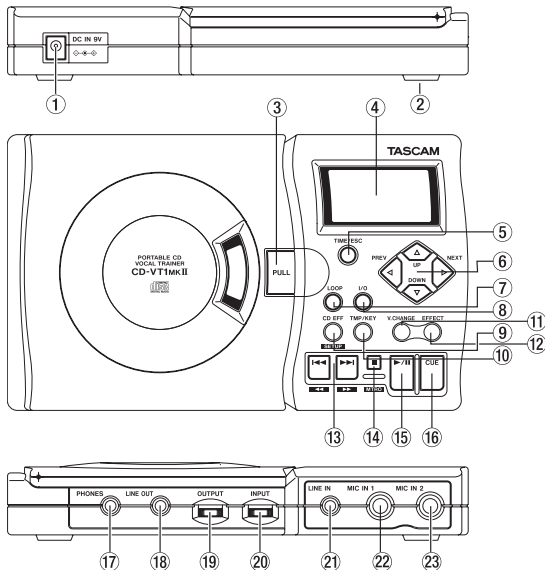

When there are two different words above and below the same key (e.g. **CD EFF** and **SETUP**), you use the key like this:

- To activate the function written above the key:  
Tap the key once
- To activate the function written below the key:  
Press and hold down the key

Press and hold down the key

For example, in the case of the **CD EFF/SETUP** key, the CD effects menu opens when you tap the key lightly and the Setup menu opens if you press and hold the key down.



## Part names and functions (Continued)

### 1) DC IN Jack

Use this jack to connect the DC plug of a TASCAM PS-PS5 AC adapter (sold separately).

### 2) Battery Compartment

Remove the battery compartment cover at the back of the CD-VT1MKII in order to insert 4 AA (SUM-3) batteries.

### 3) CD Drive Cover

To open, pull up the unlocking lever. Push down the cover and it will latch automatically.

### 4) Display

The CD-VT1MKII status is seen here.

### 5) TIME/ESC Key

- Use this key in the home display mode to change the way CD and track time is displayed.
- Use this key when you are in a menu mode in order to escape and return to the home display mode.

### 6) PREV, NEXT, UP, DOWN Keys

Use these keys to select menu items or

modify the setting values while in menu mode (See *Using the menu system*). You can also set the functions of the **UP** and **DOWN** keys in the home display mode (See *Changing your preferences*).

### 7) LOOP Key

Use this key to start the repeat (loop) mode.

### 8) I/O Key

Use this key to set the “IN point” and “OUT point” of the section of music that you want repeated (See *Using the CD player*).

### 9) CD EFF/SETUP Key

Use this key to enter the CD Effect menu and the Setup menu (See *Using the menu system*).

### 10) TMP/KEY Key

Use this key to enter the Tempo/Key menu (See *Using the menu system*).

### 11) V.CHANGE Key

Use this key to enter the Voice Change menu (See *Using built-in effects*).

### 12) EFFECT Key

Use this key to enter the Effect menu (See *Using built-in effects*).

### 13) Track Skip/Search Keys

[◀◀/|◀◀ ▶▶|▶▶▶]

Track Skip:

Use these keys to skip to the previous track or the next track.

- Press these keys while playing a CD to skip to the previous track or the next track.
- Pressing these keys while the CD is not playing allows you to choose the track you want to start. (To play, press the **PLAY** key.)

Search: Fast forward/Fast rewind

- Keep one of these keys pressed down while playing a CD to fast forward or fast rewind.
- The speed of the search increases if you continue to hold either of these keys pressed down.

### 14) STOP/MTRO Key [■]

Press this key to stop playback. Pressing and holding this key down activates the metronome menu (See *Using the metronome*).

### 15) PLAY/PAUSE Key [▶/||]

Use this key to start playing a CD.

While a CD is playing, you can pause playback by pressing this key. Press again to resume playing.

### 16) CUE Key

Use this key to return to the cue point (the point where playback last started). Use the Setup menu to choose a mode that the **CUE** key can perform (See *Changing your preferences*).

### 17) PHONES Jack

Connect your headphones here.

### 18) LINE OUT Jack

Use this port to connect the CD-VT1MKII to devices such as speakers with a built-in amplifier, a stereo system AUX input jack, a cassette tape recorder, or a CD recorder. You can hear

the results of the effects and key changes through devices connected here.

### 19) OUTPUT Control

Use this control to adjust the output level of the **PHONES** jack and the **LINE OUT** jack. This control adjusts the level of the two jacks together (the two jack levels cannot be adjusted separately).

### 20) INPUT Control

Use this control to adjust the input level of **MIC IN** jacks 1 and 2. This control adjusts the input level of **MIC IN 1** jack and **MIC IN 2** jack together (the levels of the two jacks cannot be adjusted separately).

### 21) LINE IN Jack

Use this stereo jack to connect external devices such as a synthesizer, cassette tape recorder, rack-mount effect unit, etc., to the CD-VT1MKII. This jack has no level control, so you must adjust the output level at the source device.

### 22) MIC IN 1 Jack

Connect a microphone to this jack.

### 23) MIC IN 2 Jack

Connect a microphone to this jack.

### 24) POWER Switch

This switch turns the power to the whole unit on and off.

### 25) CD EFF Switch

Use this switch to turn CD effects on and off.

### 26) EFFECT ON/OFF Switch

This switch turns the effector and voice change on and off. When this switch is ON, the display shows EFFECT.

## Making connections

### Connecting a microphone (MIC IN 1 / MIC IN 2)

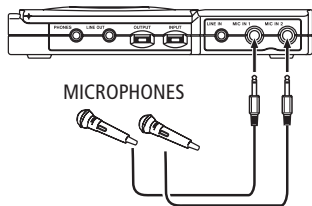

- Connect a microphone to either the **MIC IN 1** jack or the **MIC IN 2** jack. You can also connect microphones to both jacks and use them together.
- The **MIC IN** jacks (1 and 2) of the CD-VT1MKII accept unbalanced input signals. Use a ¼ inch mono phone plug.

### Adjusting the microphone level

Use the **INPUT** control to adjust the level of the input signal from the **MIC IN 1** and **MIC IN 2** jacks.

- The **INPUT** control adjusts the input level of **MIC IN 1** jack and **MIC IN 2** jack together (the levels of the two jacks cannot be adjusted separately).

### Adjusting the mix balance between microphone(s) and CD

Press and hold down the **CD EFF/ SETUP** key to open the Setup menu, and press either the **NEXT** or **PREV** key to choose **MIX**. You can set the mix balance using values between M (Mic) 10 – M1, 0, C (CD) 1 – C10.

### Inputting signals from external devices (LINE IN)

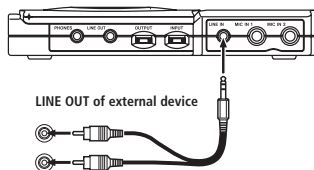

- The **LINE IN** jack accepts a stereo mini-jack plug (3.5mm).
- The input level at the **LINE IN** jack cannot be adjusted, so adjust the output level on the external device you have connected.

## Output to headphones and external devices

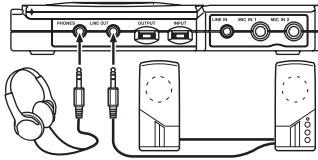

- Connect headphones to the **PHONES** jack.
- Use the stereo **LINE OUT** jack to connect the CD-VT1MKII to external devices, such as speakers with a built-in amplifier, AUX input jacks of a stereo system, cassette tape recorders, or CD recorders.

## Adjusting the output level

You can adjust the output level of **LINE OUT** and **PHONES** by using the **OUTPUT** control.

### NOTE

*The levels from both the **LINE OUT** and **PHONES** jacks are controlled together by the **OUTPUT** control and cannot be adjusted independently.*

*When you have a recording device connected to the **LINE OUT** jack, remember that the **OUTPUT** control affects the recording level.*

### NOTE

*When you are using the CD-VT1MKII with speakers and microphone(s), be careful to avoid feedback (howlround).*

# Using the menu system

## Entering the menu system

To enter the menu category of your choice, do the following:

- Effect menu

Tap the **EFFECT** key

- Voice Change menu

Tap the **V.CHANGE** key

- Setup menu (system setup)

Press and hold down the **CD EFF/SETUP** key

- Tempo/Key menu

Tap the **TMP/KEY** key



- CD Effect menu





Tap the **CD EFF/SETUP** key

- Metronome menu

Press and hold down the **STOP** key.

The menu then shows the menu category you select, reversed and blinking.

Menu Category	Menu Item	Values (default values are underlined)	Notes
EFFECT 	EFF	01-18	sets the number of the effect preset
	PAR	—	sets the effect parameter
VOICE CHANGE 	VCHG	DN, <u>OFF</u> , UP	sets the voice change function
SETUP 	MIX	M10 – M1, <u>Q</u> , C1 – C10	sets the mix balance between CD and input
	PLAY	<u>ALL</u> /SGL	selects all or single play
	CUE	<u>CUE</u> /FLS	selects the action of the <b>CUE</b> key
	UPDN	<u>MIX</u> , TMP, KEY, FIN	Sets the <b>UP/DOWN</b> key function in the home display mode
	CAL	435 – <u>440</u> – 445	sets base frequency (A4, unit: Hz)
	OSC	(OFF), <u>_C</u> – <u>_B</u> , C– <u>A</u> , B, <u>¯C</u> – <u>¯B</u> , (3 octaves)	sets the pitch of the oscillator

Menu Category	Menu Item	Values (default values are underlined)	Notes
TEMPO KEY 	TMP	VSA=OFF: -50 to +16 VSA=ON: -50, -32, -16, -12, -8, -4, <u>0</u> , +4, +8, +12, +16	sets the speed of CD playback in %
	VSA	<u>ON</u> /OFF	turns VSA on or off
	KEY	b6 - <u>0</u> - #6	sets key control in semitones
	FINE	-50 - <u>0</u> - +50	sets fine tuning (cent)
CD EFF  	CNCL	<u>ON</u> /OFF	turns vocal cancel function on or off
	PART	L10 - L1, <u>C</u> , R1 - R10	selects the stereo region reduced by the vocal cancel function
	RNGE	<u>MID</u> /ALL	selects the range reduced by the vocal cancel function
	MONO	<u>OFF</u> (stereo), L+R, L, R	selects mono monitor mode
	SPLT	<u>OFF</u> (mix), C-M, M-C	selects split monitor mode
METRONOME  	MTRON	(OFF), 40 - <u>120</u> - 220	sets tempo of metronome in BPM (Beats Per Minute)
	BEAT	<u>OFF</u> , 2 - 6	selects number of beats of the metronome

### Choosing menu items

Choose menu items in the selected menu category using the **PREV** and **NEXT** keys.



### Changing the setting values

Change the setting values using the **UP** and **DOWN** keys.



### Exiting the menu system

Press the **TIME/ESC** key to exit the menu system and go back to the home display mode.



## Using the CD player

The CD player in CD-VT1MKII works in much the same way as other CD players, with a few minor differences and special features.

### Playback

Press the **PLAY/PAUSE** key (▶/||) to start playback and to pause playback. Press the **STOP** key (■) to stop playback.

### Skipping between tracks and searching within tracks

Use the skip/search keys (◀◀/▶▶ and ▶▶1/▶▶) to move back and forward one track at a time.

Use these keys to search within the CD by pressing and holding the key for the direction that you want to search. By continuing to press, the search will speed up.

### Looping (track/disc)

Press the **LOOP** key to repeat a single track, or all tracks, according to the **PLAY** item in the Setup menu.

Setting	Repeat Mode
SGL	repeats a single current track. LOOP 1 appears on the display.
ALL	repeats the whole disc. LOOP appears on the display.

### Looping (In/Out points)

To repeat a particular section of a track, use the **I/O** key to set the start (IN) point of the loop, then use the **I/O** key to set the end (OUT) point.

- Pressing the **I/O** key during playback or paused playback sets the IN point. The I-O symbol blinks on the display.
- Pressing the **I/O** key again during playback or paused playback sets the OUT point. LOOP and I-O appear on the display. The section between the two points repeats seamlessly.
- To cancel an I/O loop, press the **LOOP** key. LOOP disappears from the display and the loop mode is canceled. Pressing the **LOOP** key again will restart the previously determined loop.

- Pressing the **I/O** key again clears the loop points.

### The CUE key

The **CUE** key has two functions that can be set in the Setup menu:

Setting	Function
CUE	playback pauses at the point where playback last started.
FLS	playback “flashes” automatically back to the last point—where playback started.

### Display

In the home display mode press the **TIME/ESC** key to change the time display between track elapsed time, track remaining time, and total remaining time of the CD.



There are four ways to change the way a CD is played back, using menu items in the Tempo Key menu: Tempo control (TMP), VSA (Variable Speed Audition) setup (VSA), Key control (KEY), and Fine tuning (FINE)

### Tempo control

Tempo control allows you to change the tempo of a track.

Press the **TMP/KEY** key to enter the Tempo Key menu, and select TMP by pressing either the **PREV** or **NEXT** key. TEMPO blinks on the display.

When VSA is ON (see below), the settings you can choose are: -50, -32, -16, -12, -8, -4, 0 (off), +4, +8, +12, and +16%. Press the **UP** or **DOWN** keys to set the value.

When VSA is OFF you can change the setting between -50 and +16% in 1% steps.

Press either the **UP** or **DOWN** key to set the tempo. When the tempo is set to a value other than zero, TEMPO shows in the home display mode.

### VSA

When VSA is ON, you can change the tempo without changing the key.

Press the **TMP/KEY** key to enter the Tempo Key menu, select VSA by pressing either the **PREV** or **NEXT** key. Press either the **UP** or **DOWN** key to choose either ON or OFF. TEMPO blinks on the display. When the VSA is set to ON, the letters VSA are shown in the display.

#### NOTE

*If the tempo control value is not set to 0 and you change VSA from OFF to ON, the tempo value will be automatically reset to a "VSA ON value." For example, if the value displayed is -33 when VSA is OFF, it will automatically be adjusted to -50 when you turn VSA ON.*

### Key control

Key control changes the key of the music up or down by six semitones.

Press the **TMP/KEY** key to enter the Tempo Key menu, and select KEY by pressing either the **PREV** or **NEXT** key. KEY blinks on the display. Press either the **UP** or **DOWN** key to set the value for the key. The range is  $\pm 6$  semitones

( $b6 - 0$  (off) -  $\#6$ ). When the key is set to a value other than zero, KEY shows in the home display mode.

### Fine tuning

Fine tuning changes the key of the music by cents (100 cents = 1 semitone). This allows you to make fine adjustments and allow for slight tuning differences between your instruments and the CD.

Press the **TMP/KEY** key to enter the Tempo Key menu, and select FINE by pressing either the **PREV** or **NEXT** key. KEY blinks on the display. Press either the **UP** or **DOWN** key to set the fine tuning value.

The range for adjustment is  $\pm 50$  cents ( $-50 - 0$  (off) -  $+50$ ). If the key control is set to  $\#6$ , however, the available range of fine tuning is between  $-50 - 0$ , and when it is set to  $b6$ , the fine tuning range is between  $0 - +50$ . When the fine tuning is set to a value other than zero, KEY shows in the home display mode.

*(continued on the next page)*

## Using CD effects

*(continued from the previous page)*

### CAUTION

If you set the key control to #6 while the fine tuning value is greater than 0, the fine tuning value is automatically reset to 0. Similarly, if you set the key control to ♭6 while the fine tuning value is less than 0, the fine tuning value is automatically reset to 0.

Also note that when key control or VSA is ON, you may find that the music played back has a “vibrato” feel. This is not a fault of the CD player – it is a natural result of the special effects.

## Using CD effects

### Turning CD effects on and off

Pressing the **CD EFF** switch at the side of the CD-VT1MKII turns on the CD effects: vocal cancel, mono monitor, split monitor. The CD EFF symbol is shown on the display when the switch is ON. Press the **CD EFF** switch again to turn off the CD effects.

### Vocal Cancel

The vocal cancel function reduces the volume of a chosen region of the stereo

image in a chosen frequency range.

### On / Off

Tap the **CD EFF/SETUP** key to enter the CD Effect menu, and choose CNCL to turn the vocal canceller on or off.

### Setting the stereo region to be reduced

Tap the **CD EFF/SETUP** key to enter the CD Effect menu, and choose PART to set the value of the localization to be reduced.

The value can be selected from L10 – L1, C, R1 – R10.

### Setting the frequency range to be reduced

Tap the **CD EFF/SETUP** key to enter the CD Effect menu, and choose RNGE to select either MID (mid range) or ALL (all range).

### NOTE

- You may not get the full effect of the vocal cancel function on some tracks.
- When the vocal cancel effect is on, the stereo sound of the CD playback may not seem quite as vivid.

## Mono monitor

Setting the monitor mode allows you to control the output signal between mono and stereo with alternate options for both.

Tap the **CD EFF/SETUP** key to enter the CD Effect menu, and select MONO by pressing either the **PREV** or **NEXT** key. Press either the **UP** or **DOWN** key to select from the following:

- L+R: outputs a mono signal, mixing the L (left) and R (right) channels.
- L: outputs the L channel signal only.
- R: outputs the R channel signal only.
- OFF: outputs normal stereo signal.

## Split monitor

Setting the split monitor mode allows you to split the CD output and the microphone(s) into left and right outputs.

*(continued on the next page)*

(continued from the previous page)

Tap the **CD EFF/SETUP** key to enter the CD Effect menu, and select **SPLIT** by pressing either the **PREV** or **NEXT** key. Press the **UP** or **DOWN** key to select from the following:

- C-M: outputs the sound of the CD from the left, and the sound of the microphone(s) from the right.
- M-C: outputs the sound of the microphone(s) from the left, and the CD sound from the right.
- OFF: outputs stereo mixed sound of CD and microphone(s) from left and right.

## Using built-in effects

The effector of the CD-VT1MKII consists of an effect library and a voice change function.

### Effect Library

There are 18 built-in preset effects. You can adjust the parameters for each of them.

### Voice Change function

The Voice Change function allows you to raise or lower the pitch of the sound input from the microphone(s) by 1 octave.

### Using the effector

1. Switch the **EFFECT ON/OFF** switch to ON.



2. Press the **EFFECT** key to open the Effect menu.



3. Select **EFF** using either the **PREV** or **NEXT** key.
4. Use either the **UP** or **DOWN** key to select the preset effect (01-18).
5. Select **PAR** by pressing either the **PREV** or **NEXT** key, then press either the **UP** or **DOWN** key to set the effect parameters (effect values).

6. Press the **TIME/ESC** key to exit the Effect menu. The parameters you have selected are automatically stored.

### Using the voice change

1. Switch the **EFFECT ON/OFF** switch to ON.
2. Press the **V.CHANGE** key to open the voice change menu.



3. Press either the **UP** or **DOWN** key to select from the following:
  - **UP**: raises the pitch of the sound from the microphone by 1 octave
  - **OFF**: the sound from the microphone is not affected
  - **DN**: lowers the pitch of the sound from the microphone by 1 octave
4. Press the **TIME/ESC** key to exit the voice change menu.

## Effect presets

Preset number	Preset name	Effect	Range of parameters
01	Pops 1	Large "pop" reverb sound 1	0–20
02	Pops 2	Large "pop" reverb sound 2	0–20
03	Pops 3	Large "pop" reverb sound 3	0–20
04	Rock 1	Lively "rock" reverb 1	0–20
05	Rock 2	Lively "rock" reverb 2	0–20
06	Rock 3	Lively "rock" reverb 3	0–20
07	Enka 1	Vibrato and echo 1 (enka)	0–20
08	Enka 2	Vibrato and echo 2 (enka)	0–20
09	Enka 3	Vibrato and echo 3 (enka)	0–20
10	Emphasis	Emphasizes "buried" vocals	0–20
11	Chorister	Detuned choral effect	0–20
12	Quivering Voice	Strong vocal vibrato	0–30
13	Screaming	Flanged vocal sound	0–30
14	Panning Vocal	Pans the voice between left and right channels	0–30
15	Shout	Distorted "shouting" vocal sound	0–20
16	Lo-Fi Vocal	Low-fidelity vocal sound	0–20
17	Megaphone	Vocal sound through a megaphone	0–99
18	Duet	Mixed duet in harmony	-17 – +17

## Using the metronome

The CD-VT1MKII has a built-in metronome.

To use the metronome, press and hold the **STOP** key to open the Metronome menu.



### Choosing the metronome tempo

1. Press either the **PREV** or **NEXT** key to select MTRO.
2. When the menu is first opened, the metronome sound is off. The metronome will begin generating the sound of beats at the previously set tempo when you press either the **UP** key or the **DOWN** key to set the tempo. Press once to change by one beat per minute; press and hold either the **UP** or **DOWN** key to fast forward or backward through the tempos. You can set the value between 40 and 220 BPM (beats per minute)

and you will hear the sound of metronome beats as soon as you set the value.

### Choosing the beats

1. Press either the **PREV** or **NEXT** key to select BEAT.
2. Select the rhythm (2 through 6 or OFF) by pressing either the **UP** or **DOWN** key. When you choose a rhythm you will notice that the first beat is a higher pitch and volume than the other beats. In the OFF setting, all beats are the same pitch and volume.

#### NOTE

*The metronome functions only when a CD is not being played back. If you start playing a CD while using the metronome, the metronome function stops automatically.*

### Using the oscillator

The CD-VT1MKII can output notes (sine waves) in the standard Western musical scale between C and B in a three octave range. Standard tuning frequency in this case is determined

by the setting in the CAL (calibration) function.

#### TIP

*This is a convenient feature to use when tuning an acoustic instrument, not connected to the CD-VT1MKII.*

1. Press down and hold the **CD EFF/SETUP** key to open the Setup menu.



2. Select OSC (oscillator) using either the **PREV** or **NEXT** key.
3. Press either the **UP** or **DOWN** key to select the pitch you like.

### Calibration

Usually, A4 (A above Middle C = standard tuning frequency) is tuned to 440 Hz. The CD-VT1MKII allows you to set A4 between 435Hz and 445Hz.

Press down and hold the **CD EFF/SETUP** key to open the Setup menu, select CAL (calibration) and set the value between 435 and 445 (Hz).

## Changing your preferences for the CD-VT1MKII

Use the Setup menu to make changes to the setup of the CD-VT1MKII.

To open the Setup menu, press and hold down the **CD EFF/SETUP** key.

Press either the **PREV** or **NEXT** key to select between menu items, and press either the **UP** or **DOWN** key to select values.

### Mix balance

This function allows you to adjust the mix balance between the microphone(s) sound and the CD sound.

Select **MIX** in the Setup menu, and select a value between **M (Mic) 10 – M1, 0, C (CD) 1 – C10**.

### CD playback mode

This function allows you to set the CD playback mode.

Select **PLAY** in the Setup menu, and set it to either **ALL** (plays all tracks) or **SGL** (plays a single track).

### UP key and DOWN key function

The function of the **UP** and **DOWN** keys when you are in the home display mode can be set so that they change the value of the menu item that you select. This can be a useful shortcut.

Select **UPDN** in the Setup menu, and select one of the four functions by pressing either the **UP** or **DOWN** key. Choose from the following list:

- MIX:** mix balance (See *Changing your preferences*)
- TMP:** CD playback tempo (See *Pitch and tempo changes*)
- KEY:** key control (See *Pitch and tempo changes*)
- FIN:** fine tuning (See *Pitch and tempo changes*)

### CUE key function

This function allows you to set the function of the **CUE** key.

Select **CUE** in the Setup menu, and set it to either **CUE** or **FLS (FLASH)**.

- CUE:** playback is paused at the last point where playback started.
- FLS:** playback starts automatically from the last point where playback started.

Disc types	8 cm single, 12 cm CD
AD/DA	16-bit
Nominal output level (LINE OUT)	-10 dBV
Maximum output level (LINE OUT) without distortion	0 dBV (1 Vrms)
Output impedance	1 k $\Omega$
Maximum output level (PHONES)	> 18mW (into 32 $\Omega$ )
Nominal input levels	
LINE IN	-10 dBV
MIC IN ( 1 / 2 )	-40 dBV
Voltage requirements	DC 9V (PS-PS5 AC adapter)
	AA batteries x 4 (NiMH or alkaline)
Power consumption	4W (PS-PS5 AC adapter)
Dimensions (w x d x h) including feet	232 x 138 x 40 (mm) / 9.1 x 5.4 x 1.6 (in)

Weight (excluding batteries)	620g / 1 lb, 6 oz.
CD playback characteristics	
Frequency response	20 Hz to 20 kHz $\pm$ 1.0 dB
Dynamic range	> 88 dB
S/N ratio	> 88 dB
THD	< 0.01%
Digital signal processing	32-bit

- Specifications and the appearance of the CD-VT1MKII may change without notice for improvement reasons.
- The illustrations in this manual may differ slightly from the actual product.

English

TEAC CORPORATION

3-7-3 Nakacho Musashino-shi Tokyo 180-8550 JAPAN  
+81-422-52-5082

[www.tascam.com](http://www.tascam.com)

Français

TEAC AMERICA, INC

7733 Telegraph Road Montebello CA 90640 USA  
+1-323-726-0303

[www.tascam.com](http://www.tascam.com)

Deutsch

TEAC CANADA LTD.

5939 Wallace Street Mississauga Ontario L4Z 1Z8 CANADA  
+1-905-890-8008

[www.tascam.com](http://www.tascam.com)

Italiano

TEAC MEXICO, S.A de C.V

Campesinos No. 184 Colonia Granjas Esmeralda, Delegacion Iztapalapa CP 09810 Mexico DF MEXICO  
+52-555-581-5500

[www.tascam.com](http://www.tascam.com)

Español

TEAC UK LIMITED

5 Marlin House, Croxley Business Park Watford Hertfordshire WD18 8TE UNITED KINGDOM  
+44-1923-438880

[www.tascam.co.uk](http://www.tascam.co.uk)

TEAC EUROPE GmbH

Bahnstrasse 12 65205 Wiesbaden-Erbenheim GERMANY  
+49-611-71580

[www.tascam.de](http://www.tascam.de)

TEAC FRANCE SA

17 Rue Alexis-de-Tocqueville CE 005 92182 Antony Cedex FRANCE  
+33-1-42-37-01-02

[www.tascam.fr](http://www.tascam.fr)

TEAC ITALIANA S.p.A.

Via C Cantu 11 20092 Cinisello Balsamo Milano ITALY  
+39-02-66010500

[www.teac.it](http://www.teac.it)