

Register your product and get support at  
[www.philips.com/welcome](http://www.philips.com/welcome)

22HFL3233D

26HFL3233D

32HFL3233D

42HFL3233D

---

EN User manual

**PHILIPS**



## Contact information

### België/ Belgique

0800 80 190 Gratis/Gratuit

ЧАТ [www.philips.com/support](http://www.philips.com/support)

### България

00800 11 544 24

### Česká republika

800 142 840 Bezplatný hovor

### Danmark

3525 8759 Lokalt opkald

ЧАТ [www.philips.com/support](http://www.philips.com/support)

### Deutschland

0800 000 7520 (kostenfrei)

ЧАТ [www.philips.com/support](http://www.philips.com/support)

### Ελλάδα

0 0800 3122 1280

Κλίση χωρίς χρέωση

### España

900 800 655 Teléfono local gratuito solamente para clientes en España

ЧАТ [www.philips.com/support](http://www.philips.com/support)

### Estonia

8000100288 kohalik kõne tariifi

### France

0805 025 510 numéro sans frais

ЧАТ [www.philips.com/support](http://www.philips.com/support)

### Hrvatska

0800 222778 free

### Ireland

South: 1 800 7445477

North: 0 800 331 6015

### Italia

800 088774 Numero Verde

### Қазақстан

+7 727 250 66 17 local

### Latvia

80002794 local

### Lithuania

880030483 local

### Luxemburg/Luxembourg

080026550

Ortsgespräch/Appel local

### Magyarország

06 80 018 189 Ingyenes hívás

### Nederland

0800 023 0076 Gratis nummer

### Norge

22 70 81 11 Lokalsamtale

### Österreich

0800 180 016

### Polska

00800 3111 318

### Portugal

0800 780 902 Chamada Grátis

### Россия

(495) 961 1111

8800 200 0880

(бесплатный звонок по России)

### România

0800-894910 Apel gratuit

0318107125 Apel local

### Србија

+381 114 440 841 Lokalni poziv

### Slovensko

0800 004537 Bezplatný hovor

### Slovenija

600 744 5477 lokalni klic

### Sverige

08 5792 9100 Lokalsamtal

### Suisse/Schweiz/Svizzera

0800 002 050

Schweizer Festnetztarif/ Tarif réseau fixe France

### Suomi

09 2311 3415 paikallispuhelu

### Türkiye

444 7 445

### United Kingdom

0800 331 6015 Toll Free

### Українська

0-800-500-697

This information is correct at the time of print. For updated information, see [www.philips.com/support](http://www.philips.com/support).

# Contents

---

<b>1</b>	<b>Notice</b>	<b>2</b>
----------	---------------	----------

---

<b>2</b>	<b>Important</b>	<b>4</b>
----------	------------------	----------

---

<b>3</b>	<b>Your TV</b>	<b>7</b>
	TV controls	7
	Remote control	8
	Remote control usage	9

---

<b>4</b>	<b>Use your TV</b>	<b>10</b>
	Switch your TV on	10
	Switch your TV to standby	10
	Switch your TV off	10
	Switch channels	11
	Watch connected devices	12
	Adjust TV volume	12
	Use teletext	13

---

<b>5</b>	<b>Use more of your TV</b>	<b>14</b>
	Access TV menus	14
	Add device to the home menu	14
	Rename devices from the home menu	14
	Remove devices from the home menu	15
	Change picture and sound settings	15
	Use the universal access menu	18
	Use advanced teletext features	18
	Use the Electronic Programme Guide	20
	Display the TV clock	20
	Use timers	21
	Lock unsuitable content	22
	Change language	23
	Play photos, music and videos on USB storage devices	24
	Listen to digital radio channels	25
	Update the TV software	26
	Change TV preferences	27
	Start a TV demo	28
	Reset the TV to factory settings	28

---

<b>6</b>	<b>Install channels</b>	<b>29</b>
	Automatically install channels	29
	Manually install analogue channels	30
	Manually install digital channels	30
	Rename channels	31
	Rearrange channels	31
	Hide channels	31
	Unhide channels	31
	Access CAM services	31

---

<b>7</b>	<b>Professional mode instruction</b>	<b>32</b>
	Introduction	32
	Benefits of Professional mode	32
	Professional Setup Remote control (optional)	32
	Activating the Professional mode setup menu	33
	Professional mode options	34

---

<b>8</b>	<b>Connect devices</b>	<b>42</b>
	Back connections	42
	Side connections	44
	Connect a computer	45
	Use a Conditional Access Module	46
	Use Philips EasyLink	46
	Use a Kensington lock	49

---

<b>9</b>	<b>Product information</b>	<b>50</b>
	Supported display resolutions	50
	Multimedia	50
	Tuner/Reception/Transmission	50
	Remote control	50
	Power	50
	Supported TV mounts	51
	Product specification	51

---

<b>10</b>	<b>Troubleshooting</b>	<b>52</b>
	General TV issues	52
	TV channel issues	52
	Picture issues	52
	Sound issues	53
	HDMI connection issues	53
	Computer connection issues	53
	Contact us	53

---

<b>11</b>	<b>Index</b>	<b>54</b>
-----------	--------------	-----------

# 1 Notice

2011 © Koninklijke Philips Electronics N.V. All rights reserved.

Specifications are subject to change without notice. Trademarks are the property of Koninklijke Philips Electronics N.V. or their respective owners. Philips reserves the right to change products at any time without being obliged to adjust earlier supplies accordingly. The material in this manual is believed adequate for the intended use of the system. If the product, or its individual modules or procedures, are used for purposes other than those specified herein, confirmation of their validity and suitability must be obtained. Philips warrants that the material itself does not infringe any United States patents. No further warranty is expressed or implied.

## Terms of warranty

- Risk of injury, damage to TV or void of warranty! Never attempt to repair the TV yourself.
- Use the TV and accessories only as intended by the manufacturer.
- The caution sign printed on the back of the TV indicates risk of electric shock. Never remove the TV cover. Always contact Philips Customer Support for service or repairs.



- Any operation expressly prohibited in this manual, or any adjustments and assembly procedures not recommended or authorised in this manual shall void the warranty.

## Pixel characteristics

This LCD product has a high number of colour pixels. Although it has effective pixels of 99.999% or more, black dots or bright points of light (red, green or blue) may appear constantly on the screen. This is a structural property of the display (within common industry standards) and is not a malfunction.

## Compliance with EMF

Koninklijke Philips Electronics N.V. manufactures and sells many products targeted at consumers which, like any electronic apparatus, in general have the ability to emit and receive electromagnetic signals.

One of Philips' leading Business Principles is to take all necessary health and safety measures for our products, to comply with all applicable legal requirements and to stay well within the Electro Magnetic Field (EMF) standards applicable at the time of producing the products.

Philips is committed to develop, produce and market products that cause no adverse health effects. Philips confirms that if its products are handled properly for their intended use, they are safe to use according to scientific evidence available today.

Philips plays an active role in the development of international EMF and safety standards, enabling Philips to anticipate further developments in standardisation for early integration in its products.

## Mains fuse (UK only)

This TV is fitted with an approved moulded plug. Should it become necessary to replace the mains fuse, this must be replaced with a fuse of the same value as indicated on the plug (example 10A).

- 1 Remove fuse cover and fuse.
- 2 The replacement fuse must comply with BS 1362 and have the ASTA approval mark. If the fuse is lost, contact your dealer in order to verify the correct type.
- 3 Refit the fuse cover.

## Copyright



® Kensington and Micro Saver are registered US trademarks of ACCO World corporation with issued registrations and pending applications in other countries throughout the world.



Manufactured under licence from Dolby Laboratories. Dolby and the double D symbol are trademarks of Dolby Laboratories.



HDMI, the HDMI logo and High-Definition Multimedia Interface are trademarks or registered trademarks of HDMI licensing LLC in the United States and other countries. All other registered and unregistered trademarks are the property of their respective owners.

# 2 Important

Read and understand all instructions before you use your TV. If damage is caused by failure to follow instructions, the warranty does not apply.

---

## Safety

### Risk of electric shock or fire!

- Never expose the TV to rain or water. Never place liquid containers, such as vases, near the TV. If liquids are spilt on or into the TV, disconnect the TV from the power outlet immediately. Contact Philips Consumer Care to have the TV checked before use.
- Never place the TV, remote control or batteries near naked flames or other heat sources, including direct sunlight. To prevent the spread of fire, keep candles or other flames away from the TV, remote control and batteries at all times.



- Never insert objects into the ventilation slots or other openings on the TV.
- When the TV is swivelled ensure that no strain is exerted on the power cord. Strain on the power cord can loosen connections and cause arcing.
- To disconnect the TV from the mains power; the power plug of the TV must be disconnected. When disconnecting the power; always pull the power plug, never the cord. Ensure that you have full access to the power plug, power cord and outlet socket at all times.

### Risk of short circuit or fire!

- Never expose the remote control or batteries to rain, water or excessive heat.
- Avoid force coming onto power plugs. Loose power plugs can cause arcing or fire.

### Risk of injury or damage to the TV!

- Two people are required to lift and carry a TV that weighs more than 25 kg or 55 lbs.
- When stand mounting the TV, use only the supplied stand. Secure the stand to the TV tightly. Place the TV on a flat, level surface that can support the combined weight of the TV and the stand.
- When wall mounting the TV, use only a wall mount that can support the weight of the TV. Secure the wall mount to a wall that can support the combined weight of the TV and wall mount. Koninklijke Philips Electronics N.V. bears no responsibility for improper wall mounting that result in accident, injury or damage.
- If you need to store the TV, disassemble the stand from the TV. Never lay the TV on its back with the stand installed.
- Before you connect the TV to the power outlet, ensure that the power voltage matches the value printed on the back of the TV. Never connect the TV to the power outlet if the voltage is different.
- Parts of this product may be made of glass. Handle with care to avoid injury and damage.

### Risk of injury to children!

Follow these precautions to prevent the TV from toppling over and causing injury to children:

- Never place the TV on a surface covered by a cloth or other material that can be pulled away.
- Ensure that no part of the TV hangs over the edge of the surface.
- Never place the TV on tall furniture (such as a bookcase) without anchoring both the furniture and TV to the wall or a suitable support.
- Educate children about the dangers of climbing on furniture to reach the TV.

### Risk of swallowing batteries!

- The product/remote control may contain a coin-type battery, which can be swallowed. Keep the battery out of reach of children at all times!

**Risk of overheating!**

- Never install the TV in a confined space. Always leave a space of at least 4 inches or 10 cm around the TV for ventilation. Ensure curtains or other objects never cover the ventilation slots on the TV.

**Risk of injury, fire or power cord damage!**

- Never place the TV or any objects on the power cord.
- Disconnect the TV from the power outlet and antenna before lightning storms. During lightning storms, never touch any part of the TV, power cord or antenna cable.

**Risk of hearing damage!**

- Avoid using earphones or headphones at high volumes or for prolonged periods of time.

**Low temperatures**

- If the TV is transported in temperatures below 5°C or 41°F, unpack the TV and wait until the TV temperature matches room temperature before connecting the TV to the power outlet.

**Screen care**

- Avoid stationary images as much as possible. Stationary images are images that remain on-screen for extended periods of time. Examples include: on-screen menus, black bars and time displays. If you must use stationary images, reduce screen contrast and brightness to avoid screen damage.
- Unplug the TV before cleaning.
- Clean the TV and frame with a soft, damp cloth. Never use substances such as alcohol, chemicals or household cleaners on the TV.
- Risk of damage to the TV screen! Never touch, push, rub or strike the screen with any object.
- To avoid deformations and colour fading, wipe off water drops as soon as possible.

**Temperature and humidity**

On rare occasions, depending on temperature and humidity, minor condensation can occur on the inside of the glass front. To prevent this, do not expose the TV to direct sunlight, heat or extreme humidity. If condensation occurs, it will disappear spontaneously after the TV has played for a few hours. The condensation moisture will not harm the TV or cause malfunction.

**Disposal of your old product and batteries**

Your product is designed and manufactured with high quality materials and components, which can be recycled and reused.



When this crossed-out wheeled bin symbol is attached to a product it means that the product is covered by the European Directive 2002/96/EC. Please inform yourself about the local separate collection system for electrical and electronic products.

Please act according to your local rules and do not dispose of your old products with your normal household waste.

Correct disposal of your old product helps to prevent potential negative consequences for the environment and human health.



Your product contains batteries covered by the European Directive 2006/66/EC, which cannot be disposed of with normal household waste. Please inform yourself about the local rules on separate collection of batteries because correct disposal helps to prevent negative consequences for the environment and human health.

---

## Environmental efforts

Philips continuously focuses on lowering the environmental impact of its innovative consumer products. We aim our efforts towards environmental improvements during manufacturing, reduction of harmful substances, energy-efficient use, end-of-life instructions and product recycling.

To access energy-efficient settings:

- 1 While you watch TV, press the green button on the remote control.
- 2 Select one of the following settings:
  - **[Energy saving]**: Picture settings that conserve the most energy.
  - **[Mute screen]**: If you only want to listen to audio from the TV, you can turn off the TV display. Other functions continue to operate normally.
  - **[Light sensor]**: The built-in ambient light sensor lowers the brightness of the TV screen when the surrounding light darkens.
  - **[Switch off unused sources]**: If you connect EasyLink-compliant devices, you can switch them off.







# 3 Hotel TV

Congratulations on your purchase, and welcome to Philips! To fully benefit from the support that Philips offers, register your TV at [www.philips.com/welcome](http://www.philips.com/welcome).

---

## TV controls

- ①  +/-: Adjust volume.
- ②  (Home): Access the home menu.
- ③ CH +/-: Switch channels.
- ④  Power: Switch the TV on or off.
- ⑤  Remote control sensor.

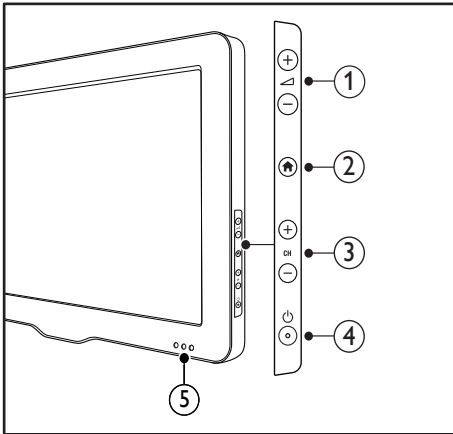

# Remote control

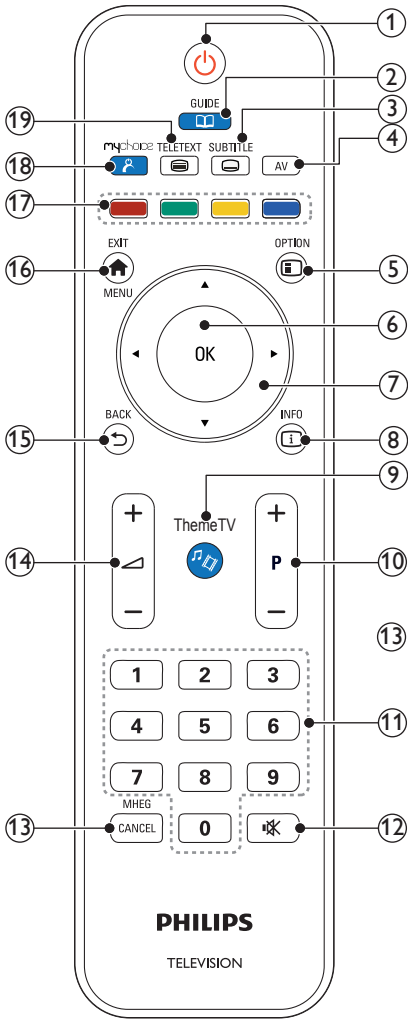

**22AV1104D**

- ① **⏻ (Standby-On)**
  - Switches the TV to standby if the TV is on.
  - Switches the TV to on if the TV is in standby.
- ② **📖 GUIDE**  
Switches to Electronic Program list.
- ③ **SUBTITLE**  
Launches the subtitle menu.
- ④ **AV**  
Selects connected devices.
- ⑤ **⌘ OPTIONS**  
Accesses options relating to the current activity or selection. (Some features are not available when PBS is set to on.)
- ⑥ **OK**
  - Confirms an entry or selection.
  - Press to display the channel grid, when watching TV.
- ⑦ **⏪ ⏩ (Navigation buttons)**  
Navigates through the menus.
- ⑧ **ℹ INFO**  
Displays program information, when available. If the information spans multiple pages, press **OPTIONS** to go to the next page.
- ⑨ **🎵 ThemeTV**  
Accesses options relating to Theme TV.
- ⑩ **P+/- (Programme +/-)**  
Switches to the next or previous channel. When the TV menu is on, this functions as Page Up / Down.
- ⑪ **0-9 (Numeric buttons)**  
Selects a channel or setting.
- ⑫ **🔇 (MUTE)**  
Mutes or restores audio output.
- ⑬ **MHEG / CANCEL**  
UK only: Cancels MHEG 5 function.
- ⑭ **🔊 +/- (Volume +/-)**  
Increases or decreases volume.

- ⑮ **↶ BACK**
- Returns to the previously viewed channel.
- ⑯ **🏠 MENU / EXIT**  
Toggles the main menu on or off.
- ⑰ **Colour buttons**
- Selects tasks or options.
  - When Professional mode is On, press to operate Multi remote control function.
  - While you watch TV, press the Green button to open Energy Saving option panel.
  - When you watch TV, press the Blue button to open On-Screen Clock display.
- ⑱ **👤 (MyChoice)**  
Opens MyChoice menu for entering authorized PIN code.
- ⑲ **TELETEXT**  
Toggles Teletext on or off.

---

## Remote control usage

When using the remote control, hold it close to the TV and point it at the remote control sensor. Make sure that the line-of-sight between the remote control and TV is not blocked by furniture, walls or other objects.

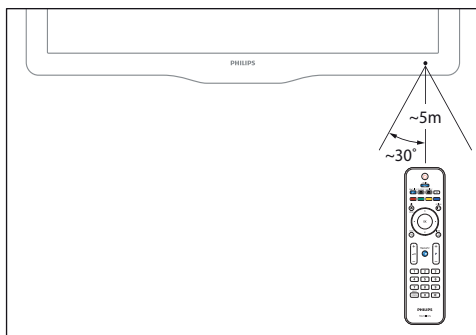

## 4 Use your TV

This section helps you perform basic TV operations.

---

### Switch your TV on

- Press the power switch on the TV.  
↳ There is a short delay before the TV responds.

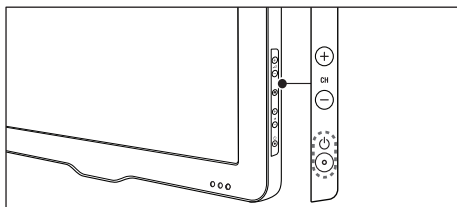

---

### If the TV is in standby

- Press  $\phi$  (Standby-On) on the remote control.

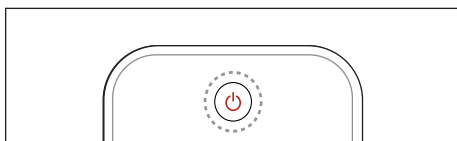

---

### Switch your TV to standby

- Press  $\phi$  (Standby-On) on the remote control again.  
↳ The remote control sensor on the TV switches to red.

## Switch channels

- Press **P+** or **P-** on the remote control.

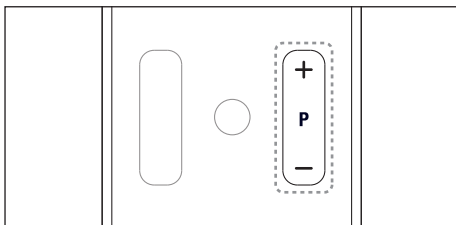

- Press **CH +/-** on the TV.

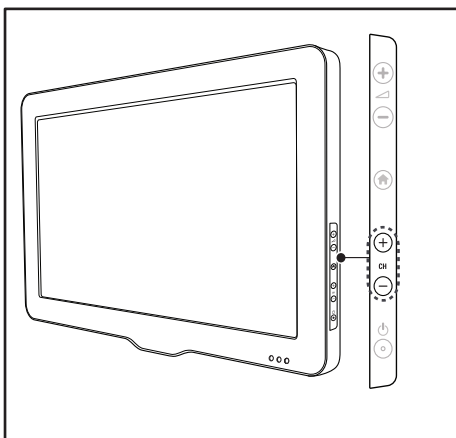

## Other ways to switch channels

- Enter a channel number using the **Numeric buttons**.
- Press **↩ (BACK)** on the remote control to return to the previous channel.

## View channel preview

You can view a preview of all available channels with the channel grid.

- Press **OK**.
  - ↳ The channel grid appears.
  - ↳ To preview a channel, select it.
  - ↳ To watch a channel, select it, then press **OK**.

## Watch connected devices

### Note

- Before you select a device as a source, switch the device on.

## Select a device from the source list

1 Press **AV**.

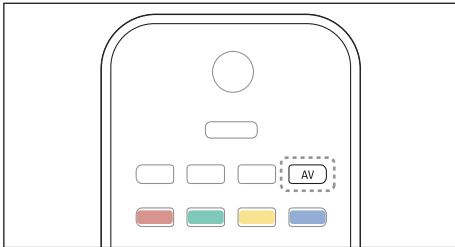

↳ The source list appears.

2 Press **▲▼** to select a device.

3 Press **OK** to confirm your choice.

↳ The TV switches to the selected device.

## Adjust TV volume

- Press **+/-** on the remote control.

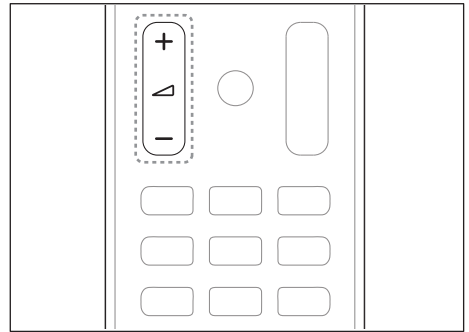

- Press **▲ +/-** on the TV.

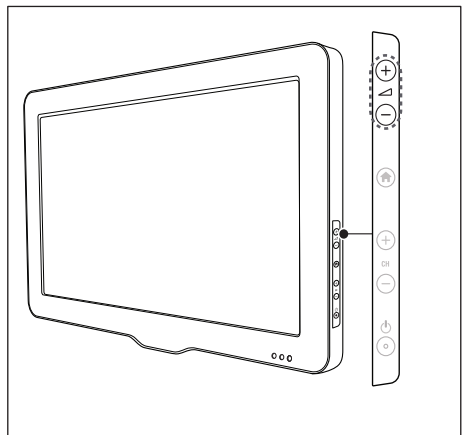

## To mute or unmute sound

- Press **🔇** to mute the sound.
- Press **🔇** again to restore the sound.

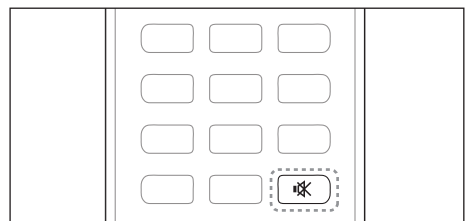

## Use teletext

1 Press **TELETEXT**.

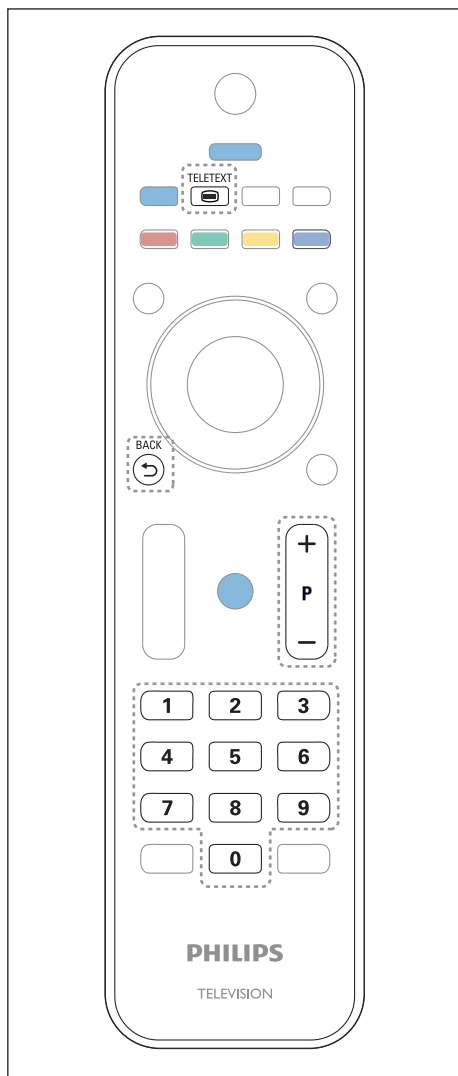

↳ The main index page appears.

- 2 Select a page with one of the following:
- Press the **Numeric buttons** to enter a page number.
  - Press **P +** or **P -** to view the next or previous page.
  - Press the **Colour buttons** to select a colour coded item.
  - Press **↶ (BACK)** to return to a previously viewed page.
- 3 Press **TELETEXT** to exit teletext.

### Note

- For UK users only: Some digital TV channels offer dedicated digital text services (for example, BBC1).

# 5 Use more of your TV

## Access TV menus

Menus help you to install channels, change picture and sound settings and access other features.

- 1 Press **⬆**.  
The menu screen appears.

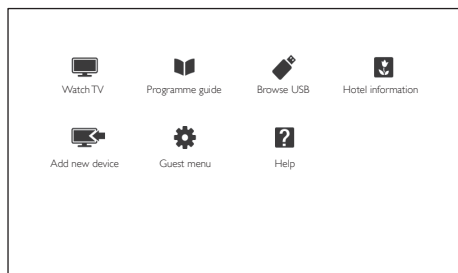

- 2 Select one of the following, then press **OK**.
  - **[Watch TV]**: If a source other than antenna is selected, switch back to the antenna source
  - **[Programme guide]**: Access the electronic programme guide.
  - **[Browse USB]**: If a USB device is connected, access the content browser.
  - **[Hotel information]**: Access the hotel's information.
  - **[Add new device]**: Add new devices to the home menu.
  - **[Guest menu]**: Access menus to change picture, sound and other settings.
  - **[Help]**: Access the TV tour.
- 3 Press **⬆** to exit.

## Add device to the home menu

After you connect a device, add it to the home menu.

- 1 Press **⬆**.
- 2 Select **[Add new device]**.
- 3 Follow the onscreen instructions to add the device to the home menu.
  - ↳ The device is displayed in the home menu.
- 4 To watch the device, switch it on, then select it in the home menu.
- 5 You can also select the device with the source button (see 'Select a device from the source list' on page 12).

## Rename devices from the home menu

After you add a new device to the home menu, you can rename it to your preference.

### Note

- The device name can be up to 16 characters long.

- 1 Press **⬆**.
- 2 Select a device to rename.
- 3 Press **☰** **OPTIONS**.
  - ↳ The options menu appears.
- 4 Select **[Rename device]**, then press **OK**.
- 5 To display the text input box, press **OK**.
- 6 For each character; select a character; then press **OK**.
  - To select uppercase letters, lowercase letters or symbols: In the row below the space key, select the respective key, then press **OK**.



- 7 When complete, select **[Done]**, then press **OK**.  
↳ The text input box closes.
- 8 In the rename device menu, select **[Done]**, then press **OK**.

---

## Remove devices from the home menu

If a device is no longer connected to the TV, remove it from the home menu.

- 1 Press **▲**.
- 2 Select a device to remove.
- 3 Press **≡** **OPTIONS**.
- 4 Select **[Remove device]**, then press **OK**.
- 5 Select **[Remove]**, then press **OK**.  
↳ The selected device is removed from the home menu.

---

## Change picture and sound settings

Change picture and sound settings to suit your preferences. You can apply pre-defined settings or change settings manually.

### Note

- While you watch TV or external devices, press **≡** **ADJUST**, then select **[Smart picture]** or **[Smart sound]** for quick access to picture and sound settings.

---

## Use settings assistant

Use the settings assistant to guide you through the picture and sound settings.

- 1 Press **▲**.
- 2 Select **[Guest menu]** > **[Quick picture and sound settings]**, then press **OK**.
- 3 Select **[Continue]**, then press **OK**.  
↳ The **[Settings assistant]** menu appears.
- 4 Follow the onscreen instructions to choose your preferred picture settings.

---

## Use smart picture

Use smart picture to apply pre-defined picture settings.

- 1 Press **▲**.
- 2 Select **[Guest menu]** > **[TV settings]** > **[Picture]** > **[Smart picture]**, then press **OK**.
- 3 Select one of the following settings, then press **OK**.
  - **[Personal]**: Apply your customised picture settings
  - **[Vivid]**: Rich and dynamic settings, ideal for daytime.
  - **[Natural]**: Natural picture settings.
  - **[Cinema]**: Ideal settings for movies.
  - **[Game]**: Ideal settings for games.
  - **[Energy saving]**: Settings that conserve the most energy.
  - **[Standard]**: Default settings that suit most environments and types of video.
  - **[Photo]**: Ideal settings for photos.
  - **[Custom]**: Customise and store your personal picture settings. Select **[Personal]** to apply these settings.

---

## Manually adjust picture settings

- 1 Press **▲**.
- 2 Select **[Guest menu] > [TV settings] > [Picture]** then press **OK**.
- 3 Select one of the following settings, then press **OK**.
  - **[Smart picture]**: Access predefined smart picture settings.
  - **[Reset]**: Reset to factory default settings.
  - **[Contrast]**: Adjust the intensity of backlight areas, while the video contents are kept unchanged.
  - **[Brightness]**: Adjust the intensity and details of dark areas.
  - **[Colour]**: Adjust colour saturation.
  - **[Sharpness]**: Adjust sharpness in the image.
  - **[Noise reduction]**: Filter and reduce noise in an image.
  - **[Tint]**: Adjust the colour balance in an image.
  - **[Custom tint]**: Customise tint setting. (Only available if **[Tint] > [Custom]** is selected)
  - **[Digital Crystal Clear] / [Pixel Plus] / [Pixel Plus HD]**: Fine-tune each pixel to match surrounding pixels. This setting produces a brilliant, high-definition image.
    - **[HD Natural Motion]**: For selected models. Minimise juddering effects and enhance picture smoothness.
    - **[100Hz Clear LCD] / [120Hz Clear LCD]**: For selected models. Reduce motion blurring and make picture clearer.
    - **[Advance sharpness]**: Enable superior picture sharpness.
    - **[Dynamic contrast]**: Enhance contrast. **[Medium]** setting is recommended.
    - **[Dynamic backlight]**: Adjust brightness of the TV backlight to match lighting conditions.
    - **[MPEG artifact reduction]**: Smooth out transitions on digital pictures. You can switch this feature on or off.

- **[Colour enhancement]**: Make colours more vivid and improve the details in bright colours. You can switch this feature on or off.
  - **[Gamma]**: For selected models. Adjust the midtone intensity in the picture. Black and white are not affected.
  - **[Light sensor]**: Adjust settings dynamically based on the current lighting conditions.
  - **[Picture format]**: Change the picture format.
  - **[Screen edges]**: Adjust the viewing area. (when set to maximum, you may see noise or the rough edge of an image).
- [Picture format]**, then press **OK**.

---

## Change picture format

- 1 Press **▲**.
- 2 Select **[Guest menu] > [TV settings] > [Picture] > [Picture format]**, then press **OK**.
- 3 Select a picture format, then press **OK**.

---

## Summary of picture formats

The following picture settings can be configured.

### Note

- Depending on the format of the picture source, some picture settings are not available.

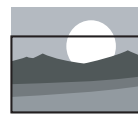

**[Auto fill]**: For selected models. Adjust the picture to fill the screen (subtitles remain visible). Recommended for minimal screen distortion but not for HD or PC.

---



**[Auto zoom]:** For selected models. Enlarge the picture to fill the screen. Recommended for minimal screen distortion but not for HD or PC.

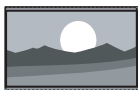

**[Super zoom]:** (Not for HD and PC mode.) Remove the black bars on the side of 4:3 broadcasts. There is minimal distortion.



**[4:3]:** Show the classic 4:3 format.



**[Movie expand 16:9]:** (Not for HD and PC mode.) Scale 4:3 format to 16:9.



**[Wide screen]:** Scale 4:3 format to 16:9.

## Use smart sound

Use smart sound to apply pre-defined sound settings.

- 1 Press **▲**.
- 2 Select **[Guest menu]** > **[TV settings]** > **[Sound]** > **[Smart sound]**, then press **OK**.
- 3 Select one of the following settings, then press **OK**.
  - **[Personal]:** Apply the settings that were customised in the sound menu.
  - **[Standard]:** Settings that suit most environments and types of audio.
  - **[News]:** Ideal settings for spoken audio, such as news.
  - **[Cinema]:** Ideal settings for movies.
  - **[Game]:** Ideal settings for games.
  - **[Drama]** : Ideal settings for drama programmes.
  - **[Sports]:** Ideal settings for sports programmes.

## Manually adjust sound settings

- 1 Press **▲**.
- 2 Select **[Guest menu]** > **[TV settings]** > **[Sound]**, then press **OK**.
  - ↳ The **[Sound]** menu appears.
- 3 Select one of the following settings, then press **OK**.
  - **[Smart sound]:** Access predefined smart sound settings.
  - **[Reset]:** Reset to factory default settings.
  - **[Clear sound]:** Enhance the sound clarity.
  - **[Bass]:** Adjust the bass level.
  - **[Treble]:** Adjust the treble level.
  - **[Surround]:** Switch on spatial sound.
  - **[Incredible Surround]:** (For selected models) Enhanced spatial sound for increased surround effect.
  - **[Headphone volume]:** (For models with headphones) Adjust headphone volume.
  - **[Auto volume levelling]:** Automatically reduce sudden volume changes, for example when switching channels.
  - **[Balance]:** Adjust the balance of the right and left speakers.
  - **[Digital output format]:** Select the type of digital audio output through digital audio output connector.
    - **[PCM]:** Convert non-PCM audio type to PCM format.
    - **[Multichannel]:** Output audio to the home theatre.

---

## Use the universal access menu

You can activate the universal access menu during the first installation. Once enabled, you can quickly access the visually impaired and hearing impaired menus when watching TV or external devices.

- 1 While you watch TV, press **≡ OPTIONS**.  
↳ The TV options menu appears.
- 2 Select **[Universal access]**, then press **OK**.
- 3 Select one of the following options, then press **OK**.
  - **[Hearing impaired]**: Enable or disable hearing impaired subtitles.
  - **[Visually impaired]**: Some digital TV channels broadcast special audio adapted for people who are visually impaired. The normal audio is mixed with extra commentary. Use the colour buttons to select the options:
    - **Red ([Off])**: Turn off visually impaired audio.
    - **Green ([Speakers])**: Hear visually impaired audio from speakers only
    - **Yellow ([Headphone])**: Hear visually impaired audio from headphones only.
    - **Blue ([Speaker + headphone])**: Hear visually impaired audio from both speakers and headphone.
  - **[Mixed volume]**: Adjust the volume of visually impaired audio.
  - **[Key beep]**: Switch on audio feedback when buttons are pressed on the remote control or TV.



### Tip

- Press the colour buttons on the remote control to enter the options.

---

## Use advanced teletext features

---

### Access the teletext options menu

Access the teletext features through the teletext options menu.

- 1 Press **TELETEXT**.  
↳ The teletext screen appears.
- 2 Press **≡ OPTIONS**.  
↳ The teletext options menu appears.
- 3 Select one of the following options, then press **OK**.
  - **[Freeze page] / [Unfreeze page]**: Freeze/unfreeze the current page.
  - **[Dual screen] / [Full screen]**: Switch between full screen and dual screen teletext.
  - **[T.O.P. overview]**: Switch on Table of Pages teletext broadcasts
  - **[Enlarge] / [Normal view]**: Switch between enlarged and normal view of teletext pages.
  - **[Reveal]**: Hide or reveal hidden information on a page, such as solutions to riddles or puzzles.
  - **[Cycle subpage]**: If subpages are available, automatically display each subpage in sequence.
  - **[Languages]**: Select a language for teletext.

---

### Select teletext subpages

A teletext page can contain several subpages. Subpages are displayed next to the main page number.

- 1 Press **TELETEXT**.  
↳ The teletext screen appears.
- 2 Press **P+** or **P-** to select a teletext page.
- 3 Press **◀** or **▶** to enter a subpage.

---

## Select T.O.P. teletext broadcasts

Jump from one subject to another without entering page numbers with Table Of Pages (T.O.P.) teletext broadcasts. T.O.P. teletext broadcasts are available on selected TV channels.

- 1 Press **TELETEXT**.  
↳ The teletext screen appears.
- 2 Press **☰ OPTIONS**.
- 3 Select **[T.O.P. overview]**, then press **OK**.  
↳ The T.O.P. overview appears.
- 4 Select a subject.
- 5 Press **OK** to view the page.

---

## Use Teletext 2.5

Teletext 2.5 offers more colours and better graphics than normal teletext. If Teletext 2.5 is broadcast by a channel, it is switched on by default.

- 1 Press **▲**.
- 2 Select **[Guest menu] > [TV settings] > [Preferences] > [Teletext 2.5]**.
- 3 Select **[On]** or **[Off]**, then press **OK** to confirm.

---

## Use the Electronic Programme Guide

The programme guide is an on-screen guide available for digital channels. It allows you to:

- View a list of digital programmes being broadcast
- View upcoming programmes
- Group programmes by genre
- Set reminders when programmes start
- Setup preferred programme guide channels

---

### Switch on EPG

- 1 Press **▲**.
- 2 Select **[Programme guide]**, then press **OK**.  
↳ The programme guide appears displaying information about the scheduled programmes.

 **Note**

- Programme guide data is available only in selected countries and can take some time to load.

---

### Change programme guide options

You can set or clear reminders, change the day, and access other useful options in the programme guide options menu.

- 1 Press **▲**.
- 2 Select **[Programme guide]**, then press **OK**.
- 3 Press **≡** **OPTIONS**.  
↳ The programme guide menu appears.
- 4 Select one of the following options, then press **OK**.
  - **[Change day]**: Set the programme guide day.
  - **[Show info]**: Display programme information.
  - **[Search by genre]**: Search TV programmes by genre.

- **[Acquire EPG data]**: Update the latest programme guide information.

- 5 Press **↵** to exit the EPG menu.

---

## Display the TV clock

You can display a clock on the TV screen. The clock displays the current time using time data received from your TV service operator.

---

### Set the TV clock manually

In some countries, you need to set TV clock manually.

- 1 Press **▲**.
- 2 Select **[Guest menu]** > **[TV settings]** > **[Preferences]** > **[Clock]**.
- 3 Select **[Auto clock]**, then press **OK**.
- 4 Select **[Manual]**, then press **OK**.
- 5 Select **[Time]** or **[Date]**, then press **OK**.
- 6 Press the **Navigation buttons** to set the time or date.
- 7 Select **[Done]**, then press **OK**.
- 8 Press **▲** to exit.

 **Note**

- If your selected country supports digital broadcast, the clock displays the time data from your TV service operator as priority.

---

### Display the TV clock

- 1 While you watch TV, press the Blue button.

 **Note**

- To disable the clock, repeat the procedure.

## Change the clock mode

- 1 Press **▲**.
- 2 Select **[Guest menu]** > **[TV settings]** > **[Preferences]** > **[Clock]** > **[Auto clock]**.
- 3 Select **[Automatic]** or **[Manual]**, then press **OK**.

## Change the time zone

### Note

- This option is only available if you select **[Auto clock]** > **[Automatic]** (in countries with clock transmission data).

- 1 Press **▲**.
- 2 Select **[Guest menu]** > **[TV settings]** > **[Preferences]** > **[Clock]** > **[Time zone]**.
- 3 Select your time zone.
- 4 Press **OK** to confirm.

## Use daylight saving

### Note

- This option is only available if you select **[Auto clock mode]** > **[Manual]**.

- 1 Press **▲**.
- 2 Select **[Guest menu]** > **[TV settings]** > **[Preferences]** > **[Clock]** > **[Daylight saving]**, then press **OK**.
- 3 Select **[Standard time]** or **[Daylight saving time]**, then press **OK**.

## Use timers

You can set timers to switch the TV to standby at a specified time.

### Tip

- Set the TV clock before you use timers.

## Automatically switch the TV to standby (sleep timer)

Sleep timer switches the TV to standby after a pre-defined duration.

### Tip

- You can switch off your TV earlier or reset the sleep timer during the countdown.

- 1 Press **▲**.
- 2 Select **[Guest menu]** > **[TV settings]** > **[Preferences]** > **[Sleep timer]**.  
↳ The **[Sleep timer]** menu appears.
- 3 Select a value between zero and 180 minutes.  
↳ If you select zero, the sleep timer switches off.
- 4 Press **OK** to switch on the sleep timer.  
↳ The TV switches to standby after the specified time.

---

## Lock unsuitable content

You can prevent your children from watching certain programmes or channels by locking the TV controls.

---

### Set or change code

- 1 Press **▲**.
- 2 Select **[Guest menu] > [Channel settings] > [Child lock]**.
- 3 Select **[Set code]** or **[Change code]**.  
↳ The **[Set code] / [Change code]** menu appears.
- 4 Enter your code using the **Numeric buttons**.  
↳ Follow the on-screen instructions to create or change your PIN code.



#### Tip

- If you forget your code, enter '8888' to override any existing codes.

---

### Lock or unlock one or more channels

- 1 Press **▲**.
- 2 Select **[Guest menu] > [Channel settings] > [Child lock] > [Channel lock]**.  
↳ A list of channels is displayed.
- 3 Select the channel that you want to lock or unlock, then press **OK**.  
↳ The first time you lock or unlock a channel, you are prompted to enter your PIN code.
- 4 Enter your code and press **OK**.  
↳ If the channel is locked, a lock icon is displayed.
- 5 Repeat the process to lock or unlock more channels.

- 6 To activate the locks, switch the TV on and off.  
↳ When you switch channels with **P - or P +**, the locked channels are skipped.  
↳ When you access the locked channels from the channel grid, you are prompted to enter your PIN code.

---

### Set parental ratings

Some digital broadcasters rate their programmes according to age. You can set your TV to display only programmes with age ratings lower than your child's age.

- 1 Press **▲**.
- 2 Select **[Guest menu] > [Channel settings] > [Child lock] > [Parental rating]**.  
↳ A code setup screen appears.
- 3 Enter your code using **Numeric buttons**.  
↳ The rating menu appears.
- 4 Select an age rating, then press **OK**.
- 5 Press **▲** to exit.



## Change language

Depending on your broadcaster, you can change the audio language, subtitle language, or both, for a TV channel.

Multiple audio languages, subtitles, or both, are broadcast through teletext or DVB-T digital broadcasts. Dual sound broadcasts: With digital broadcasts, you can select a subtitle language.

### Change menu language

- 1 Press **▲**.
- 2 Select **[Guest menu] > [TV settings] > [Preferences] > [Menu language]**, then press **OK**.
- 3 Select a language, then press **OK**.

### Change audio language

You can choose an audio language if it is available from your broadcaster. For digital channels, multiple languages may be available. For analogue channels, two languages may be available.

- 1 While you watch TV, press **☰ OPTIONS**.
- 2 For digital channels, select **[Audio language]**, select the language, then press **OK**.
- 3 For analogue channels, select **[Dual I-II]**, select either language, then press **OK**.

## Show or hide subtitles

- 1 While you watch TV, press **SUBTITLE**.
- 2 Select one of the following, then press **OK**.
  - **[Subtitles on]**: Always display subtitles.
  - **[Subtitles off]**: Never display subtitles.
  - **[On during mute]**: When audio is muted, display subtitles.



#### Note

- Repeat this procedure to enable subtitles on each analogue channel.
- Select **[Subtitles] > [Subtitles off]** to disable subtitles.

## Select a subtitle language in digital channels



#### Note

- When you select a subtitle language in a digital TV channel as described below, the preferred subtitle language set in the installation menu is temporarily overruled.

- 1 While you watch TV, press **☰ OPTIONS**.
- 2 Select **[Subtitle language]**, then press **OK**.
- 3 Select a subtitle language.
- 4 Press **OK** to confirm.

---

## Play photos, music and videos on USB storage devices

### Caution

- Philips is not responsible if the USB storage device is not supported, nor is it responsible for damage or loss of data from the device.

Connect a USB storage device to play photos, music or videos stored on it.

- 1 Switch on the TV.
- 2 Connect the USB device to the USB port on the side of your TV.
- 3 Press **▲**.
- 4 Select **[Browse USB]**, then press **OK**.  
↳ The USB browser appears.

---

### View photos

- 1 In the USB browser, select **[Picture]**, then press **OK**.
- 2 Select a photo or a photo album, then press **OK** to view the photo enlarged to fill the TV screen.
  - To view the next or previous photo, press **◀▶**.
- 3 To return, press **↩**.

---

### View a slide show of your photos

- 1 When a full screen image of a photo is displayed, press **OK**.  
↳ A slide show begins from the selected photo.
- Press the following buttons to control play:
  - **OK** to pause, resume play.
  - **◀** or **▶** to play the previous or next photo.
  - **EXIT** to stop.
- To return, press **↩**.

---

### Change slide show settings

- 1 While you view a slide show, press **≡** **OPTIONS**.  
↳ The slide show options menu is displayed.
- 2 Select one of the following, then press **OK**.
  - **[Start/Stop slideshow]**: Start or stop slideshow.
  - **[Slideshow transitions]**: Set the transition from one picture to the next.
  - **[Slideshow frequency]**: Select the display time for each photo.
  - **[Repeat] / [Play once]**: View the pictures in the folder once only, or repeatedly.
  - **[Shuffle off] / [Shuffle on]**: View the pictures in sequential order, or at random.
  - **[Rotate image]**: Rotate photo.
  - **[Show info]**: Display the picture name, date, size and next picture in the slide show.
- 3 To return, press **↩**.

### Note

- **[Rotate image]** and **[Show info]** appear only when the slideshow is paused.

---

### Listen to music

- 1 In the USB browser, select **[Music]**, then press **OK**.
- 2 Select a music track or album, then press **OK** to play.
- 3 Press the following buttons to control play:
  - **OK** to pause, resume play.
  - **◀** or **▶** to play the previous or next photo.
  - **EXIT** to stop.

---

## Change music settings

- While you play music, press **≡ OPTIONS** to access one of the following settings, then press **OK**.
  - **[Stop playback]**: Stop music play.
  - **[Repeat]**: Play a song once or repeatedly.
  - **[Shuffle on] / [Shuffle off]**: Play songs in sequence or at random.
  - **[Show info]**: Display the file name.

---

## Watch video

- 1 In the USB browser, select **[Video]**, then press **OK**.
- 2 Press **OK** to play.
- 3 Press the following buttons to control play:
  - **OK** to pause, resume play.
  - **◀** or **▶** to play the previous or next photo.
  - **EXIT** to stop.

---

## Change video settings

- While you play video, press **≡ OPTIONS** to access one of the following settings, then press **OK**.
  - **[Stop playback]**: Stop video play.
  - **[Repeat]**: Play once or repeatedly.
  - **[Full screen] / [Small Screen]**: View the video stretched to fill the screen, or view it in its native picture format.
  - **[Shuffle on] / [Shuffle off]**: Play in sequence or at random.
  - **[Show info]**: Display the file name.

---

## View a slideshow with music

You can view a picture slide show with background music.

- 1 Select an album of songs.
- 2 Press **OK**.
- 3 Press **↵** to return to the USB content browser.
- 4 Select an album of pictures.
- 5 Press **OK**.
  - ↳ The slideshow begins.
- 6 To exit, press **↵**.

---

## Disconnect a USB storage device



### Caution

- Follow this procedure to avoid damage to your USB storage device.

- 1 Press **↵** to exit the USB browser.
- 2 Wait for five seconds, then disconnect the USB storage device.

---

## Listen to digital radio channels

- 1 Press **OK**.
  - ↳ The channel matrix menu is displayed.
- 2 Press **≡ OPTIONS**, then select **[Select list] > [Radio]**.
  - ↳ The radio channel grid appears.
- 3 Select a radio channel and press **OK** to listen.

---

## Update the TV software

Philips continuously tries to improve its products and we recommend that you update the TV software when updates are available.

---

### Ways to update the TV software

You can update the TV software in one of the following ways:

- A: with a USB storage device,
- B: when prompted through digital broadcasts, or
- C: after being prompted through digital broadcasts.
- D: using SmartInstall.

---

### A: Update with a USB device

To update with a USB storage device, you need:

- An empty USB flash drive. The USB flash drive must be FAT or DOS-formatted. Do not use a USB hard drive.
- A computer with Internet access
- An archive utility that supports the ZIP file format (for example, WinZip® for Microsoft® Windows® or StuffIt® for Macintosh®).

---

### Step 1: Check the current software version

- 1 Press **▲**.
- 2 Select **[Guest menu] > [Software settings] > [Current software info]**.  
↳ The current software information is displayed.
- 3 Write down the software version number.
- 4 To return, press **OK**.
- 5 To exit, press **↩**.

---

### Step 2: Download and update the latest software version

- 1 Connect a USB storage device.
- 2 Press **▲**.
- 3 Select **[Guest menu] > [Update software]**.
- 4 Follow the instructions to load a file onto your USB storage device.
- 5 Connect the USB storage device to your computer; then double-click the file.  
↳ A Web page is launched.
- 6 Follow the instructions in the Web page.
  - If the current software version matches the latest software update file, you do not need to update your TV software.
  - If the current software version is smaller than the latest software update file, download the latest software update file to the root directory of your USB device.
- 7 Disconnect the USB storage device from the computer.

---

### Step 3: Update the TV software

- 1 Connect your USB storage device to the TV.  
↳ The TV detects the USB flash drive and starts to scan for software version.
- 2 If a message prompts you to update the software, follow the on-screen instructions to update the TV software.
- 3 If the message is not displayed, continue with the following steps:
- 4 Press **▲**.
- 5 Select **[Guest menu] > [Software settings] > [Local updates]**.
- 6 Select the file that you downloaded, then press **OK** to update the TV software manually.
- 7 Follow the on-screen instructions to complete the update.
- 8 To exit, press **↩**.

## B: Update when prompted through digital broadcasts

If you receive digital broadcasts (DVB-T), your TV can automatically receive software updates. When your TV receives a software update, it will prompt you to update the TV software.

- 1 Press **▲**.
- 2 Select **[Guest menu] > [Software settings] > [Announcement]**.
- 3 If a message appears to prompt you to update your software, follow the instructions to start the update.
  - ↳ The TV restarts after the software update is complete.
- 4 If you do not want to update the software, select **[Guest menu] > [Software settings] > [Clear announcement]**, then press **OK**.



### Note

- If you skip the update, you can update it manually later (see 'C: Check for updates through digital broadcasts' on page 27).

## C: Check for updates through digital broadcasts

You can check if there are updates available through digital broadcasts.

- 1 Press **▲**.
- 2 Select **[Guest menu] > [Software settings] > [Check on major updates]**.
- 3 If an update is available, follow the on-screen instructions to start the update.
  - ↳ The TV restarts after the software update is complete.

## Change TV preferences

Use the preferences menu to customise your TV settings.

- 1 Press **▲**.
- 2 Select **[Guest menu] > [TV settings] > [Preferences]**.
- 3 Select one of the following, then press **OK**.
  - **[Menu language]**: Select a menu language.
  - **[Sleep timer]**: Switch the TV to standby after a pre-defined duration.
  - **[Location]**: Optimise TV settings for your location - home or shop.
  - **[E-sticker]**: (For shop mode only) Switch the e-sticker on or off.
  - **[Volume bar]**: Display the volume bar when you change the volume.
  - **[Auto switch off]**: To conserve energy, set the TV to switch to standby automatically after a period of inactivity.

This TV is also designed with other energy efficiency settings. If there is no user interaction (such as pressing a remote control button or a control on the front panel) for four hours, the TV will automatically switch to standby.

- **[Channel information size]**: Change the type of information that is displayed when you switch channels.
- **[Universal access]**: Enable or disable the universal access menu.
- **[Key beep]**: Enable audio feedback when you press buttons on the remote control or TV.
- **[Audio out delay]**: Automatically sync the image on your TV to the audio from a connected home theatre.
- **[TV position]**: Apply the best settings for your TV based on how it is mounted.
- **[Teletext 2.5]**: Enable or disable Teletext 2.5. (For digital TV)
- **[Clock]**: Display or remove the time from the TV, and set clock options.

---

## Start a TV demo

You can use demonstrations to better understand the features of your TV. Some demos are not available on certain models. Available demos are displayed in the menu list.

- 1 While you watch TV, press **▲**.
- 2 Select **[Guest menu] > [Watch demo]**, **OK**.
- 3 Select a demo and press **OK** to view it.
- 4 To exit, press **↶**.

---

## Reset the TV to factory settings

You can restore the default picture and sound settings of your TV. The channel installation settings remain the same.

- 1 Press **▲**.
- 2 Select **[Guest menu] > [TV settings] > [Factory settings]**, then press **OK**.
- 3 If you are prompted to enter a code, enter the child-lock code (see 'Set or change code' on page 22).  
↳ A confirmation message is displayed.
- 4 Press **OK** to confirm.

---

## Reset the TV to Virgin Install settings

You can restore to the initial Out-of-the-box settings of your TV. All channel installation will be removed as well.

- 1 Press **▲**.
- 2 Select **[Guest menu] > [TV settings] > [Reinstall TV]**, then press **OK**.
- 3 Press **OK** to confirm.

## 6 Install channels

The first time you set up your TV, you are prompted to select a menu language and to install TV and digital radio channels (if available). Afterwards, you can re-install and fine tune channels.

---

### Automatically install channels

You can search and store channels automatically.

#### Note

- If you have not set the child lock code, you may be prompted to set the code (see 'Set or change code' on page 22).

---

#### Step 1: Select your menu language

- 1 Press **▲**.
- 2 Select **[Guest menu]** > **[TV settings]** > **[Preferences]** > **[Menu language]**, then press **OK**.
- 3 Select a language, then press **OK**.

---

#### Step 2: Search for channels

When the TV was switched on for the first time, a full installation of channels was performed. You can run this full installation again to set your language, country, and install all available TV channels.

#### Note

- For selected models, some options are different.

- 1 Press **▲**.
- 2 Select **[Guest menu]** > **[Search for channels]**, then press **OK**.
- 3 Select **[Reinstall channels]**, then press **OK**.  
↳ The country menu is displayed.
- 4 Select your country, then press **OK**.  
↳ The network menu is displayed.
- 5 Select the network, then press **OK**.
  - **[Antenna]**: For free-to-air antenna or digital DVB-T channels.
  - **[Cable]**: For cable or digital DVB-C channels.
- 6 Follow the onscreen instructions to select other options, if any.  
↳ The start menu for channel search is displayed.
- 7 Select **[Start]**, then press **OK**.  
↳ All available channels are stored.
- 8 To exit, press **OK**.

---

#### Update the channel list

You can enable automatic update of channels when your TV is in standby mode. The channels stored in your TV are updated every morning according to the channel information in the broadcast.

- 1 Press **▲**.
- 2 Select **[Guest menu]** > **[Channel settings]** > **[Channel installation]** > **[Automatic channel update]**.
- 3 Select **[On]** to enable the automatic update or select **[Off]** to disable it.
- 4 To return, press **↶**.

---

## Manually install analogue channels

You can search and store analogue TV channels one at a time.

### Note

- If you have not set the child lock code, you may be prompted to set the code (see 'Set or change code' on page 22).

---

### Step 1: Select your system

#### Note

- If your system settings are correct, skip this step.

- 1 Press **▲**.
- 2 Select **[Guest menu] > [Channel settings] > [Channel installation] > [Analogue: Manual antenna installation] > [System]**, then press **OK**.
- 3 Select the correct system for your country or region, then press **OK**.

---

### Step 2: Search and store channels

- 1 Press **▲**.
- 2 Select **[Guest menu] > [Channel settings] > [Channel installation] > [Analogue: Manual antenna installation] > [Find channel]**, then press **OK**.
  - If you know the three-digit frequency of the channel, enter it.
  - To search, select **[Search]**, then press **OK**.
- 3 When the channel is found, select **[Done]**, then press **OK**.
  - To store the channel as a new number, select **[Store as new channel]**, then press **OK**.
  - To store the channel as the previously selected channel, select **[Store current channel]**, then press **OK**.

---

### Step 3: Fine-tune channels

- 1 Press **▲**.
- 2 Select **[Guest menu] > [Channel settings] > [Channel installation] > [Analogue: Manual antenna installation] > [Fine-tune]**, then press **OK**.
- 3 Press **▲▼** to fine-tune the channel.

---

## Manually install digital channels

You can search and store digital TV channels one at a time.

### Note

- If you have not set the child lock code, you may be prompted to set the code (see 'Set or change code' on page 22).

- 1 Press **▲**.
- 2 Select **[Guest menu] > [Channel settings] > [Channel installation] > [Digital: Reception test] > [Find channel]**, then press **OK**.
- 3 Press the **Numeric buttons** to enter the channel frequency.
- 4 Select **[Search]**, then press **OK**.
- 5 When the correct channel is located, select **[Store]**, then press **OK**.
- 6 To exit, press **↶**.

### Note

- If the reception is poor, reposition your antenna and repeat the procedure.
- If you receive the channel with DVB-C, select **[Symbol rate mode] > [Automatic]**, unless your cable provider supplies you with a specific symbol rate value.



## Rename channels

You can rename channels. The name appears when you select the channel.

- 1 While you watch TV, press **OK**.  
↳ The channel matrix menu is displayed.
- 2 Select the channel to rename.
- 3 Press **≡ OPTIONS**.  
↳ The channel options menu is displayed.
- 4 Select [**Rename channel**], then press **OK**.
- 5 To display the text input box, press **OK**.
- 6 For each character, select a character; then press **OK**.
  - To select uppercase letters, lowercase letters or symbols: In the row below the space key, select the respective key, then press **OK**.
- 7 When complete, select [**Done**], then press **OK**.  
↳ The text input box closes.
- 8 In the rename channel menu, select [**Done**], then press **OK**.

## Rearrange channels

After you install channels, you can rearrange the order in which they appear.

- 1 While you watch TV, press **OK**.  
↳ The channel matrix menu is displayed.
- 2 Press **≡ OPTIONS**.  
↳ The channel options menu appears.
- 3 Select [**Reorder**], then press **OK**.
- 4 Select the channel to rearrange, then press **OK**.  
↳ The selected channel is highlighted.
- 5 Move the highlighted channel to its new location, then press **OK**.
- 6 Press **≡ OPTIONS**.
- 7 Select [**Done reordering**], then press **OK**.

## Hide channels

To prevent unauthorised access to channels, hide them from the channel list.

- 1 While you watch TV, press **OK**.  
↳ The channel matrix menu is displayed.
- 2 Select the channel to hide.
- 3 Press **≡ OPTIONS**.  
↳ The channel options menu is displayed.
- 4 Select [**Hide channel**], then press **OK**.  
↳ The channel is marked as hidden.

## Unhide channels

To prevent unauthorised access to channels, hide them from the channel list.

- 1 While you watch TV, press **OK**.  
↳ The channel matrix menu is displayed.
- 2 Press **≡ OPTIONS**.  
↳ The channel options menu is displayed.
- 3 Select [**Show hidden channels**], then press **OK**.  
↳ The hidden channels are displayed.
- 4 Select the channel to unhide, then press **≡ OPTIONS**.
- 5 Select [**Unhide channel**], then press **OK**.  
↳ The channel is no longer marked as hidden.  
↳ You can access the hidden channel.
- 6 To exit, press **↩**.

## Access CAM services

- 1 Insert and activate the CAM (see 'Insert and activate a CAM' on page 46).
- 2 Press **≡ OPTIONS**.
- 3 Select [**Common interface**].  
↳ Applications provided by the digital TV service operator are displayed.



### Note

- This menu option is available only if the CAM is inserted and activated correctly.

# 7 Professional mode instruction

## Introduction

Included in this TV is a special functional mode that allows the TV to be configured for commercial application. This feature is called Professional mode (PBS mode).

This section has been designed to help install and operate this TV in Professional mode. Before reading this section, please read section 3 to 6 to set the basic functionality of this TV.

## Benefits of Professional mode

This TV is specially designed to operate in Professional Mode. Professional Mode offers the following benefits:



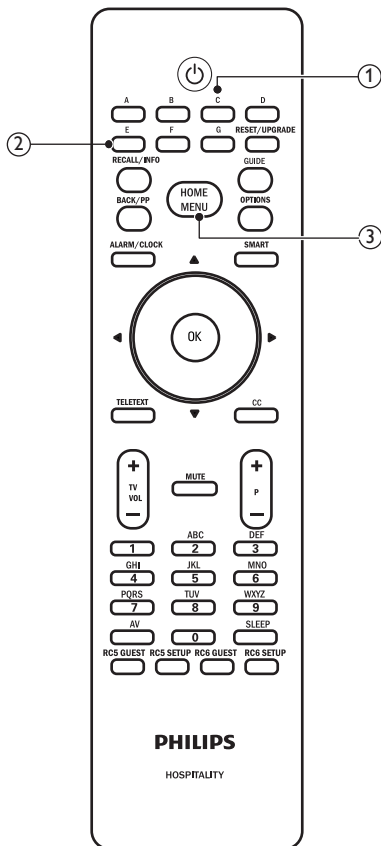

- Access to the **[Consumer Menu]** can be blocked. This prevents users (e.g. guests) from deleting or changing channel settings and / or modifying picture and sound settings. This ensures that TVs are always set up correctly.
- A switch-on volume and channel can be selected. After switching on, the TV will always start on the specified volume level and channel.
- The maximum volume level of the TV can be limited in order to prevent disturbance to other guest.
- Channels can be blocked (Video only).
- The TV local buttons **VOLUME +/-**, **P/CH +/-** and **🏠 (Home)** can be locked.
- Screen information can be suppressed.

## Professional Setup Remote control (22AV8573, optional)



---

## Activating the Professional mode setup menu

- 1 Switch on the TV and select a TV channel.
- 2 Press the following buttons to access Professional mode setup menu:
  - [3,1,9,7,5,3+  (MUTE)] on Guest remote control.
  - HOME MENU on Professional setup remote control. (select RC5 SETUP.)
- 3 Press     on the remote control to select and change any of the settings.
- 4 When done, select [Store] > [Confirm] to save changes.  
Press EXIT to exit without saving.
- 5 For Professional mode settings to take effect, you must restart the TV mains power.

## Professional mode options

This paragraph describes the functionality of each item in the Professional mode setup menu.

Layer 1	Layer 2	Layer 3
PBS settings	PBS mode	Off/On
	Room ID	Action
	Consumer setup	Action
	Channel setup	Action
	USB to TV	Action
	TV to USB	Action
	Reset	Action
Switch on setting	Switch on channel	[List of channels]
	Switch on vol	0 - max
	Max volume	0 - max
	Switch on picture format	Auto fill/Auto zoom/ Super Zoom/ 4:3/ Unscaled/ Subtitle zoom/ Movie expand 14:9/ Movie expand 16:9/ Wide screen
	Power on	On/ Standby/ Last status
	Smart power	Off/On
Welcome message	Display message	Off/On
	Line 1	Edit
	Line 2	Edit
	Clear	Action
	Message Time-out	20 Sec/ 25 Sec/ 30 Sec
Welcome logo	Display logo	Off/On
	USB to TV	Action
Hotel information	Display information	Off/On
	USB to TV	Action
Control settings	Local KB lock	Off/ On/ All
	RC lock	Off/ On
	OSD display	Off/ On
	High security	Off/ On
	Auto scart	Off/ On/ Power on scart
	HDMI-CEC in	Off/ On
	USB break-in	Off/ On
	Enable teletext	Off/ On
	Enable MHEG	Off/ On
	Enable EPG	Off/ On
	Enable subtitle	Off/ On/ On during mute
	Enable USB	Off/ On
	Blue mute	Off/ On
	Digit timeout	0.5 - 9.9 seconds
Selectable AV	{List of selectable external channels}	

Layer 1	Layer 2	Layer 3
Clock setup	Download program	All available channels
	Country Selection	[List of countries]
	Time offset	-12 to 12 hours
Speaker settings	TV speaker enable	Off/ On
	Independent main speaker mute	Off/ On
	Default main speaker volume*	0 to 60
Installation	Blank channel	All available channels
	Auto channel update	Off/ On
	Auto software update	Off/ On
	Skip scrambled signals	Off/ On
	Multi remote control	Blue/ Green/ Yellow/ Red/ off
	MyChoice	Off/ On
	ThemeTV	Off/ On/ Startup
MyChoice setup	R0	Pay TV channel list
	R1	All available channels
ThemeTV Configuration	TTV1 Name	Action
	TTV2 Name	Action
	TTV3 Name	Action
	TTV4 Name	Action
	TTV5 Name	Action
	TTV6 Name	Action
ThemeTV Channel Setup	TTV1	All available channels
	TTV2	All available channels
	TTV3	All available channels
	TTV4	All available channels
	TTV5	All available channels
	TTV6	All available channels
Store	Action	Confirm/ Cancel
* Applicable if Independent main speaker mute is selected as "On"		

---

## PBS settings

### [PBS mode]

Enables / disables the Professional mode.

- **[On]:** All settings in the Professional mode Setup menu are in effect.
- **[Off]:** The TV operates as a normal (consumer) TV.

### [Room ID]

Sets the room ID.

### [Channel setup]

A shortcut to enter the channel list, and an option to change order, rename and hide channels.

### [Consumer setup]

A shortcut to enter the full TV menu. This allows the installers to do all the TV setup settings.

### [USB to TV]

Loads the TV configuration data (including the video, audio, channel table, and Professional mode settings) from a USB device to the TV set.

### [TV to USB]

Loads the TV configuration data (including the video, audio, channel Table, and Professional mode settings) from the TV set to a USB device.

### [Reset]

Selects **[Yes]** to reset all settings in Professional mode to factory default.

---

## Switch on setting

### [Switch on channel]

When the guest switches the TV on, it will play at the specified channel.

### [Switch on vol]

When the guest switches the TV on, it will play at the specified volume level.

### [Max volume]

This option specifies the maximum allowable volume level of the TV.

### [Switch on picture format]

Sets available picture format when the TV is switched on.



#### Note

- If the picture format is not supported with the activated source, **[Auto format]** detection is applied.

### [Power on]

The power on function allows the TV to enter a specific mode (**[On]**, **[Standby]**, or **[Last status]**) of operation after the mains power is activated.

- **[On]:** When set, the TV will always turn on after the mains power is activated.
- **[Standby]:** When set, the TV will always turn to standby after the mains power is activated.
- **[Last status]:** When set, the TV will always turn to the last status (either On or Standby) whenever the mains power is activated.

### [Smart power]

Adjusts the picture backlight to achieve the following power saving mode.

- **[Off]:** Smart power is disabled. (**[Custom]** mode is applied).
- **[On]:** Smart power is enabled.

## Welcome message

The Welcome message function allows the TV to show a customized greeting to the hotel guest whenever the TV is switched on. This helps to personalize the hotel experience for guests. The Welcome message can consist of 2 lines of text, with each line containing a maximum of 20 alphanumeric characters. Use ▲▼◀▶ on the remote control to compose the Welcome message of press **OK** to open the OSD keyboard.



### Note

- Welcome message is always disabled if you select **[Control settings] > [OSD display] > [Off]**.
- **[Display message]:** Selects **[On]** to activate the welcome message.
- **[Line 1]:** Sets the characters of the first line message.
- **[Line 2]:** Sets the characters of the second line message.
- **[Clear]:** Clear the settings in Line 1 and Line 2.
- **[Message Time-out]:** Sets the period of time to display the welcome message on the screen when TV is turned on from standby / Off.

## Welcome logo

- **[Display logo]:** Selects **[Off]** to deactivate the logo.
- **[USB to TV]:** Loads the logo from a USB device to the TV set.

## Hotel information

- **[Display information]:** Selects **[On]** to display home information.
- **[USB to TV]:** Loads the home information from a USB device to the TV set.

## Control settings

### [Local KB lock]

- **[Off]:** The TV local buttons will function normally.
- **[On]:** The TV local buttons except **⏻ POWER** are locked.
- **[All]:** All TV local buttons are locked, including **⏻ POWER**.

### [RC lock]

Disables the operation of the Guest remote control.

- **[Off]:** All buttons on Guest remote control will function normally.
- **[On]:** All buttons on the Guest remote control are disabled. (It is still possible to enter the Professional setup menu by pressing **[3, 1, 9, 7, 5, 3 + MUTE]**).

### [OSD display]

Sets this function to show or hide screen information.

- **[Off]:** Screen information is suppressed.
- **[On]:** Normal screen information is displayed.

### [High security]

- **[Off]:** Professional mode setup menu can be accessed by both Guest remote control (Press **[3, 1, 9, 7, 5, 3 + MUTE]**) and the Professional setup remote control (Press **M button**)
- **[On]:** Professional mode setup menu can only be accessed by the Professional setup remote control.

### [Auto scart]

Enables auto scart switching or break-in Professional mode.

- **[Off]:** Disables auto scart switching or break-in Professional mode.
- **[On]:** Enables auto scart switching or break-in Professional mode.
- **[Power on scart]:** Sets scart source as power on / off button. When the connected scart source is turned on / off, the TV enters to on / standby mode simultaneously

### [HDMI-CEC in]

HDMI-CEC (Philips EasyLink) enables one- touch play and one touch standby between HDMI-CEC compliant devices.

#### Note

- Before activating HDMI-CEC in function, make sure the HDMI-CEC compliant devices are turned on.
- Selects **[EasyLink]** > **[On]** first before enabling **[HDMI-CEC in]** in Professional mode.
- Refer to page 46 "Use Philips EasyLink" for more details about HDMI-CEC function.

- **[Off]:** Disables HDMI-CEC feature in Professional mode.
- **[On]:** Enables HDMI-CEC feature in Professional mode.

### [USB break-in]

Enables or disables USB break-in feature in Professional mode.

- **[Off]:** When USB is plugged in, the **[Multimedia]** menu will not appear automatically, but users can access **[Multimedia]** menu from the **[Consumer setup]** menu.
- **[On]:** When USB is plugged in, the **[Multimedia]** menu appears automatically.

### [Enable teletext]

- **[Off]:** Disables teletext in Professional mode.
- **[On]:** Enables teletext in Professional mode.

### [Enable MHEG] (For UK only)

- **[Off]:** Disables MHEG in Professional mode.
- **[On]:** Enables MHEG in Professional mode.

### [Enable EPG]

- **[Off]:** Disables EPG in Professional mode.
- **[On]:** Enables EPG in Professional mode.

### [Enable subtitle]

- **[Off]:** Closes subtitles in Professional mode.
- **[On]:** Displays subtitles in Professional mode.
- **[On during mute]:** Displays subtitles when audio being muted.

### [Enable USB]

- **[Off]:** Disables USB multimedia function in Professional mode. (Software update functions normally).
- **[On]:** USB multimedia functions normally in Professional mode.

#### Note

- Refer to page 24 "Play photos, music and videos on USB storage devices" for more details about USB multimedia function.

### [Blue mute]

Sets the background colour when there is no signal on TV.

- **[Off]:** The background colour is set to black.
- **[On]:** The background colour is set to blue.



### [Digit timeout]

Defines the time interval between numeric buttons when users press digits on the remote control. The duration is from 0.5 to 9.9 seconds. When the digit is pressed, the timer refreshes.

### [Selectable AV]

Allows the installer to define which external sources to be displayed on the source list when pressing **AV** button on the Guest remote control. Only the sources marked **[X]** appear in the source list.

## Clock setup

### [Download program]

Allows the installer to define which channel to download to set the clock.

### [Country selection]

Allows the installer to define which country to set the clock.

### [Time offset]

Allows the installer to define the hours to offset.





## Speaker settings

### [TV speaker enable]

- **[Off]:** Disables the TV speaker. The headphone volume functions normally.
- **[On]:** The TV speaker is enabled. (Default setting).

### [Independent main speaker mute]

This option only appears when you select **[TV speaker enable] > [On]**.

- **[Off]:** Press  (MUTE) or  +/- on the Guest remote control will affect both the TV speaker and the headphone volume (Default setting).
- **[On]:** Press  (MUTE) or  +/- on the Guest remote control will affect the TV speaker volume only. The headphone volume functions normally.



### Note

- If the TV speaker is muted independently, press  +/- on the Guest remote control will only affect the headphone volume.

### [Default main speaker volume]

Only appears when you select **[Independent main speaker mute] > [On]**. Users can set the TV speaker and headphone volume to a certain level as the default setting. This option can avoid sudden high-volume when TV speaker is turned on again from independently mute.

---

## Installation

### [Blank channel]

The Blank channel function disables the display of video on the TV, but does not affect the audio output. This function can be used for audio applications (example: music-only channels, and so on) which do not necessarily require the display of video.

- 1 Enters the **[Blank channel]**, the list of all channels appear.
- 2 Selects one or more channels and press **OK** to mark.
- 3 The channels marked with **[X]** will not display video on the TV.

### [Auto channel update]

Enables automatic channel update.

### [Auto software update]

Enables automatic channel updating.

### [Skip scrambled signals]

- **[Off]**: Allows scrambled channels in the channel list.
- **[On]**: Skips the scrambled channels in the channel list.

### [Multi remote control]

Guest remote control supports up to four televisions operating in one room without interference from each other's remote controls. Each TV and the Guest remote control can be set to match each others.

- 1 Enters **[Multi remote control]** and designate one colour (**Blue / Green / Yellow / Red**) to the TV. Selects **[Off]** to disable **[Multi remote control]** function.
- 2 Sets the Guest remote control to the corresponding colour by pressing **▲MENU** and one of the colour buttons simultaneously for more than 4 seconds.
- 3 The Guest remote control can operate the TV with the corresponding colour.

### Note

- EXAMPLE: Press **▲MENU** and **Red button** simultaneously on the Guest remote control for more than 4 seconds to operate the TV with **[Red]** colour selected in **[Multi remote control]** menu.
- Guest remote control will be set to default **Blue colour** after replacing batteries.

### [MyChoice]

- **[Off]**: Disables MyChoice function.
- **[On]**: **[MyChoice]** appears in the Guest home menu. Press **▲MENU > [MyChoice]** and enters authorized PIN code to watch MyChoice channels.

### [ThemeTV]

- **[Off]**: Disables ThemeTV function.
- **[On]**: Enables ThemeTV function.
- **[Startup]**: Enables ThemeTV function at TV startup.

---

## MyChoice setup

This function allows you to customized MyChoice channel list.

- 1 Enters **[MyChoice setup]** in the Professional setup menu.
- 2 Sets MyChoice channels from the following TV channel lists:
  - **[R0]**: List of MyChoice channels and normal channels. Channels marked with **[X]** can only be watched after pressing authorized PIN code.
  - **[R1]**: List of all available channels. Unmark MyChoice channels to prevent users from watching full MyChoice channels via Guest remote control.



### Note

- All non-MyChoice channels are listed in **[R1]**.
- Before pressing authorized PIN code, **[R1]** is the default channel list everytime you start the TV mains power.
- When using MyChoice, clock time signal is mandatory.

---

## ThemeTV Configuration

This function allows you to name up to 6 ThemeTV channel groups (page 35).

---

## ThemeTV Channel setup

This function allows you to add channels to any one of the ThemeTV channel groups (page 35).

---

## Store settings

In the Professional setup menu, select **[Store]** > **[Confirm]** to save the changes.



### Note

- Restarts the TV mains power for the changes to take effect.

# 8 Connect devices

This section describes how to connect devices with different connectors. For the location of these connectors on your TV, see the quick start guide. More examples of connections with other devices are provided in the Quick Start Guide.

## Note

- You can use different types of connectors to connect a device to your TV.

## Tip

- After connection, for easy access to your device, add it to the home menu: press **Home**, then select **[Add new device]**.

## Back connections

### 1 TV ANTENNA

Signal input from an antenna, cable or satellite.

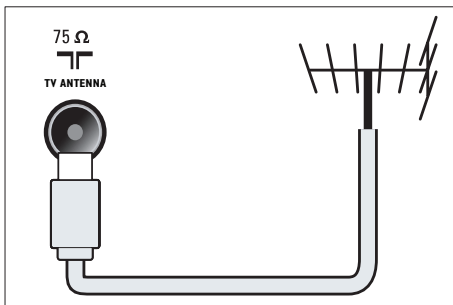

### 2 EXT 1 (RGB and CVBS)

Analogue audio and video input from analogue or digital devices such as DVD players or game consoles.

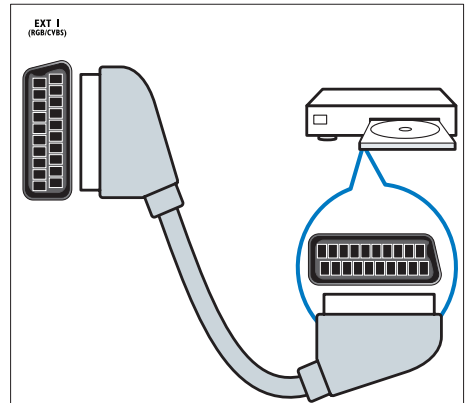

### 3 DIGITAL AUDIO OUT

Digital audio output to home theatres and other digital audio systems.

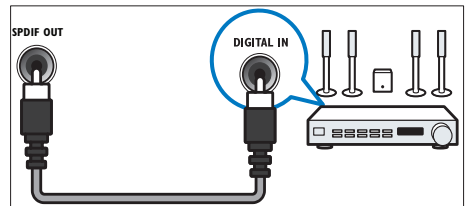

### 4 SERV. U

For use by service personnel only.

### ⑤ PC IN (VGA and AUDIO IN)

Audio and video input from a computer.

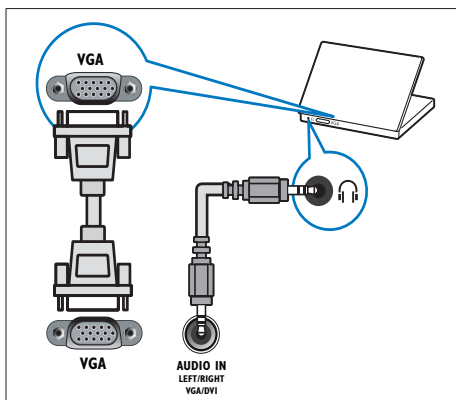

### ⑦ HDMI 2 (For selected models)

Digital audio and video input from high-definition digital devices such as Blu-ray players.

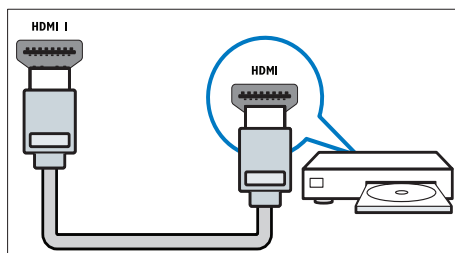

Connections via DVI or VGA require an additional audio cable (see 'Connect a computer' on page 45).

### ⑥ HDMI 1 ARC

Digital audio and video input from high-definition digital devices such as Blu-ray players. Also outputs TV audio to other EasyLink-compliant devices, such as home theatre systems.

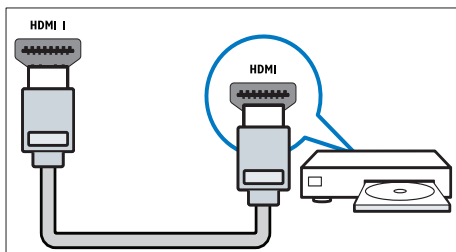

Connections via DVI or VGA require an additional audio cable (see 'Connect a computer' on page 45).

### ⑧ EXT 2 (Y Pb Pr and AUDIO L/R)

Analogue audio and video input from analogue or digital devices such as DVD players or game consoles.

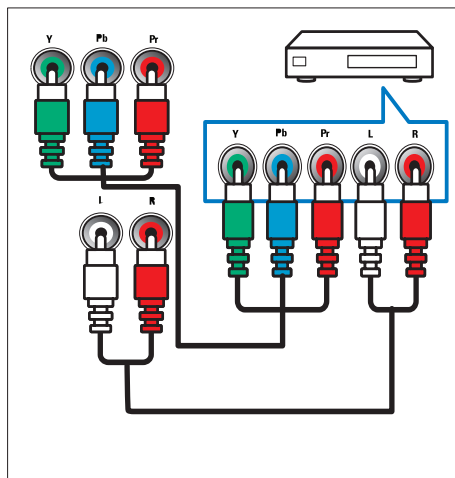

## Side connections

### ① AUDIO L/R

Audio input from analogue devices connected to VIDEO.

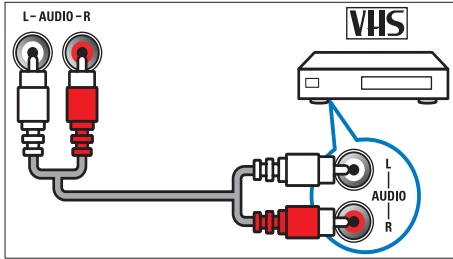

### ② VIDEO

Composite video input from analogue devices such as VCRs.

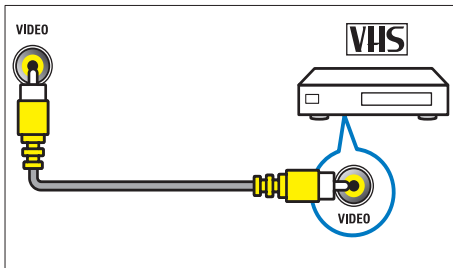

### ③ USB

Data input from USB storage devices.

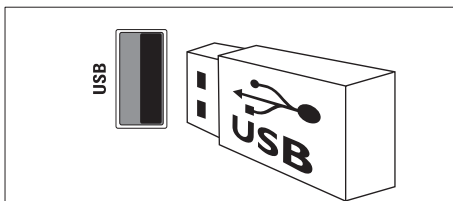

### ④ HDMI

Digital audio and video input from high-definition digital devices such as Blu-ray players.

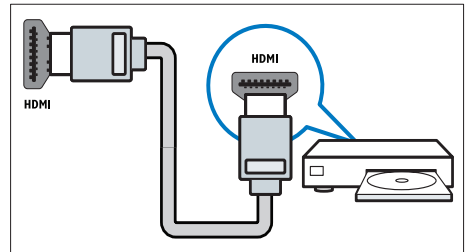

### ⑤ (Headphone)

Stereo audio output to headphones or earphones.

### ⑥ COMMON INTERFACE

Slot for a Conditional Access Module (CAM).

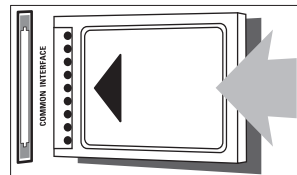

## Connect a computer

Before you connect a computer to the TV

- Set the screen refresh rate on your computer to 60Hz.
- Select a supported screen resolution on your computer.

Connect a computer with one of the following connectors:

### Note

- Connections via DVI or VGA require an additional audio cable.

- HDMI cable

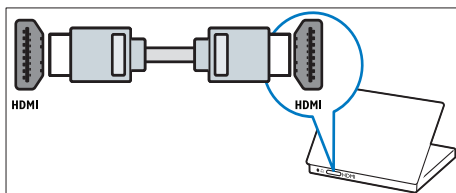

- DVI-HDMI cable

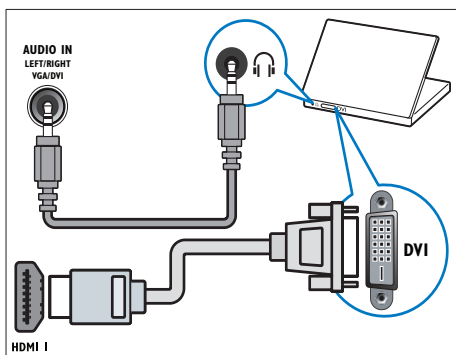

- HDMI cable and HDMI-DVI adaptor

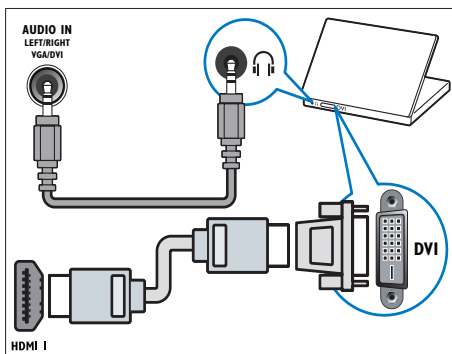

- VGA cable

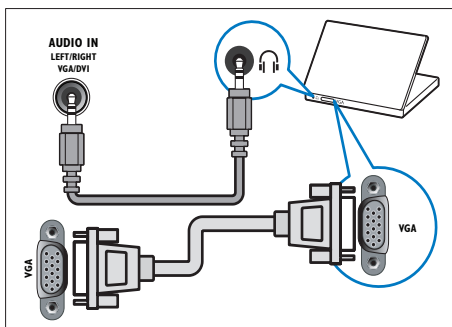

## Use a Conditional Access Module

A Conditional Access Module (CAM) is provided by digital TV service operators to decode digital TV channels.

### Note

- Refer to the documentation from your service operator on how to insert a smart card into the Conditional Access Module.
- Refer to the documentation from your service operator if their CAM card is compatible with this TV.

## Insert and activate a CAM

### Caution

- Be sure to follow the instructions described below. Wrong insertion of a CAM may damage both the CAM and your TV.

- 1 Switch off the TV and disconnect it from the power outlet.
- 2 Following the directions printed on the CAM, gently insert the CAM into the **COMMON INTERFACE** at the side of the TV.

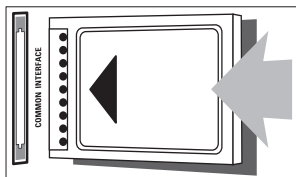

- 3 Push the CAM in as far as it will go.
- 4 Reconnect the TV to the power outlet.
- 5 Turn on the TV and wait for the CAM to be activated. This may take several minutes. Do not remove the CAM from the slot when in use — this action deactivates digital services.

## Access CAM services

- 1 Insert and activate the CAM (see 'Insert and activate a CAM' on page 46).
- 2 Press **≡** **OPTIONS**.
- 3 Select **[Common interface]**.
  - ↳ Applications provided by the digital TV service operator are displayed.

### Note

- This menu option is available only if the CAM is inserted and activated correctly.

## Use Philips EasyLink

Get the most out of your HDMI-Consumer Electronic Control (CEC) compliant devices with Philips EasyLink enhanced control features. If your HDMI-CEC compliant devices are connected through HDMI, you can control them at the same time with your TV remote control.

To enable Philips EasyLink, you need to:

- Connect at least two HDMI-CEC compliant devices through HDMI
- Configure each HDMI-CEC compliant device properly
- Switch on EasyLink

### Note

- The EasyLink-compliant device must be switched on and selected as the source.
- Philips does not guarantee 100% interoperability with all HDMI CEC devices.



## Switch on or off EasyLink

When you play an HDMI-CEC compliant device, the TV switches on from standby, and switches to the correct source.

### Note

- If you do not intend to use Philips EasyLink, switch it off.

- 1 Press **▲**.
- 2 Select **[Setup] > [TV settings] > [EasyLink] > [EasyLink]**.
- 3 Select **[On]** or **[Off]**, then press **OK**.

## Use one-touch play

- 1 After you switch on EasyLink, press play on your device.
  - ↳ The TV automatically switches to the correct source.

## Use one-touch play control

If you connect multiple HDMI-CEC devices that support this setting, all such devices respond to the play control buttons on this TV remote control.

### Caution

- This is an advanced setting. Devices that do not support this setting will not respond to the TV remote control.

- 1 Press **▲**.
- 2 Select **[Setup] > [TV settings] > [EasyLink] > [EasyLink remote control]**.
- 3 Select **[On]** or **[Off]**, then press **OK**.

## Use one-touch standby

When you press **⏻** on the TV remote control, the TV and all HDMI-CEC compliant devices switch to standby mode.

- 1 Press **⏻** (**Standby-On**) on the TV's or device's remote control.
  - ↳ The TV and all connected HDMI devices switch to standby.

## Set TV speakers to EasyLink mode

If you connect an HDMI-CEC compliant device that includes speakers, you can choose to hear the TV from those speakers instead of the TV speakers.

When you play content from an EasyLink compliant home theatre, if you want to mute the TV speakers automatically, turn on EasyLink mode.

If the connected device is HDMI Audio Return Channel (ARC) compliant, and you connect the device through an HDMI ARC connector, you can output TV audio through the HDMI cable. You do not need an additional audio cable.

- 1 Make sure that the EasyLink-compliant device is connected through an HDMI ARC connector (see 'Back connections' on page 32).
- 2 Select **[Setup] > [TV settings] > [EasyLink] > [TV speakers]**.
- 3 Select one of the following, then press **OK**.
  - **[Off]**: Switch off TV speakers.
  - **[On]**: Switch on TV speakers.
  - **[EasyLink]**: Stream TV audio through the connected HDMI-CEC device. Switch the TV audio to the connected HDMI-CEC audio device through the adjust menu.
  - **[EasyLink autostart]**: Turn off TV speakers automatically and streams TV audio to the connected HDMI-CEC audio device.

### Note

- To mute the TV speakers, select **[TV speakers] > [Off]**.

## Select speaker output with Adjust menu

If **[EasyLink]** or **[EasyLink autostart]** are selected, access the adjust menu to switch the TV audio.

- 1 While you watch TV, press **⏸ ADJUST**.
- 2 Select **[Speaker]**, then press **OK**.
- 3 Select one of the following, then press **OK**:
  - **[TV]**: On by default. Stream TV audio through TV and the connected HDMI-CEC audio device until the connected device switches to system audio control. TV audio is then streamed through the connected device.
  - **[Amplifier]**: Stream audio through the connected HDMI-CEC device. If system audio mode is not enabled on the device, audio continue to stream from the TV speakers. If **[EasyLink autostart]** was enabled, the TV prompts the connected device to switch to system audio mode.

---

## Maximise display for subtitled video

Some subtitles can create a separate subtitle bar under the video, which limits the video display area. After you switch on auto subtitle shift, the subtitles display over the video image, which maximises the video display area.

- 1 Press **⬆**.
- 2 Select **[Setup] > [TV settings] > [EasyLink] > [Auto subtitle shift] > [On]**, then press **OK**.

---

## Retain picture quality

If your TV picture quality is affected by the picture-processing features of other devices, switch on Pixel Plus Link.

- 1 Press **⬆**.
- 2 Select **[Setup] > [TV settings] > [EasyLink] > [Pixel Plus Link] > [On]**, then press **OK**.

---

## Hear TV audio through another device

If you connect an EasyLink-compliant device that has speakers, you can get the most out of those speakers if you listen to TV audio through them.

If the connected device is HDMI-ARC compliant, and you connect the device through an HDMI ARC connector, you can output TV audio through the HDMI cable. You will not need an additional audio cable.

- 1 Make sure that the EasyLink-compliant device is connected through an HDMI ARC connector (see 'Back connections' on page 32).
- 2 Press **⬆**.
- 3 Select **[Setup] > [TV settings] > [EasyLink] > [HDMI1 - audio out]**, then press **OK**.
- 4 Select one of the following, then press **OK**.
  - **[On]**: Hear the TV audio through the connected EasyLink device. You cannot hear the TV audio through the TV speakers or through devices connected through the digital audio out connector.
  - **[Off]**: Hear the TV audio through the TV speakers, or through a device connected through the digital audio out connector.
- 5 Control playback with the TV remote control play buttons.

---

## Switch all EasyLink devices to standby

To save electricity, you can switch all unused EasyLink-compliant devices to standby.

- 1 Press the **green** button.
- 2 Select **[Switch off unused sources]**, then press **OK**.
  - ↳ All connected EasyLink devices are switched to standby.

---

## Use a Kensington lock

There is a Kensington security slot at the back of the TV. Prevent theft by looping a Kensington lock between the slot and a permanent object, such as a heavy table.

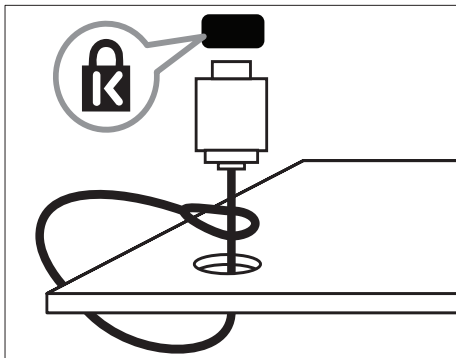

# 9 Product information

Product information is subject to change without notice. For detailed product information, go to [www.philips.com/support](http://www.philips.com/support).

---

## Supported display resolutions

### Computer formats

- Resolution - refresh rate:
  - 640 × 480 - 60 Hz
  - 800 × 600 - 60 Hz
  - 1024 × 768 - 60Hz
  - 1280 × 720 - 60Hz
  - 1280 × 768 - 60Hz
  - 1280 × 1024 - 60 Hz
  - 1360 × 768 - 60Hz
  - 1680 × 1050 - 60Hz (For Full HD only)
  - 1920 × 1080 - 60 Hz (For Full HD only)

### Video formats

- Resolution - refresh rate:
  - 480i - 60 Hz
  - 480p - 60 Hz
  - 576i - 50Hz
  - 576p - 50 Hz
  - 720p - 50 Hz, 60 Hz
  - 1080i - 50 Hz, 60 Hz
  - 1080p - 24Hz, 25Hz, 30Hz, 50Hz, 60Hz.

---

## Multimedia

- Supported storage device: USB (Only FAT or FAT 32 USB storage devices are supported)
- Supported multimedia file formats:
  - Images: JPEG
  - Audio: MP3
  - Video: MPEG 2/MPEG 4, H.264

---

## Tuner / Reception / Transmission

- Antenna input: 75ohm coaxial (IEC75)
- DVB: DVB Terrestrial, DVB-C\*, DVB-T, MPEG4
- TV system: DVB COFDM 2K/8K; PAL I, B/G, D/K; SECAM B/G, D/K, L/L'
- Video playback: NTSC, SECAM, PAL
- Tuner Bands: Hyperband, S-channel, UHF, VHF

\*For selected models

---

## Remote control

- Type: 22AV1104D/10
- Batteries: 2 × AAA (LR03 type)

---

## Power

- Mains power: 220-240V, 50-60Hz
- Standby power: < 0.3W
- Ambient temperature: 5 to 40 degrees Celsius
- For power consumption, see the product specifications at [www.philips.com/support](http://www.philips.com/support).

The power rating stated on the product typeplate is the power consumption for this product during normal household use (IEC 62087 Ed.2). The maximum power rating, stated between brackets, is used for electrical safety (IEC 60065 Ed. 7.2).

## Supported TV mounts

To mount the TV, purchase a Philips TV mount or a compatible TV mount.



### Warning

- Follow all instructions provided with the TV mount. Koninklijke Philips Electronics N.V. bears no responsibility for improper TV mounting that results in accident, injury or damage.

Before you mount, perform these steps:

- To prevent damage to cables and connectors, leave a clearance of at least 2.2 inches or 5.5cm from the back of the TV.
- For selected models, remove the wall mount plugs from the back of the TV.
- Make sure that your mounting bolts follow these specifications:

TV screen size (inches)	Required pitch (mm)	Required mounting bolts
42	300 × 200	4 × M6 (10 mm)
32	200 × 200	4 × M6 (10 mm)
26	75 × 75	4 × M4 (10 mm)
22	75 × 75	4 × M4 (10 mm)

## Product specification

Design and specifications are subject to change without notice.

### 42HFL3233D

- Without TV stand
  - Dimension (WxHxD): 1018 × 635 × 83 (mm)
  - Weight: 11.54 kg
- With TV stand
  - Dimension (WxHxD): 1018 × 683 × 236.4 (mm)
  - Weight: 14.05 kg

### 32HFL3233D

- Without TV stand
  - Dimension (WxHxD): 787.5 × 505.1 × 80.5 (mm)
  - Weight: 8.3 kg
- With TV stand
  - Dimension (WxHxD): 787.5 × 545.3 × 221.4 (mm)
  - Weight: 9.5 kg

### 26HFL3233D

- Without TV stand
  - Dimension (WxHxD): 637 × 411 × 51.4 (mm)
  - Weight: 5.36 kg
- With TV stand
  - Dimension (WxHxD): 637 × 447 × 170 (mm)
  - Weight: 5.66 kg

### 22HFL3233D

- Without TV stand
  - Dimension (WxHxD): 526 × 343 × 49.4 (mm)
  - Weight: 3.7 kg
- With TV stand
  - Dimension (WxHxD): 526 × 369 × 149 (mm)
  - Weight: 3.9 kg

# 10 Troubleshooting

This section describes commonly encountered issues and accompanying solutions.

---

## General TV issues

### The TV does not switch on:

- Disconnect the power cable from the power outlet. Wait for one minute then reconnect it.
- Check that the power cable is securely connected.

### The remote control is not working properly:

- Check that the remote control batteries are correctly inserted according to the +/- orientation.
- Replace the remote control batteries if they are flat or weak.
- Clean the remote control and TV sensor lens.

### The standby light on the TV blinks red:

- Disconnect the power cable from the power outlet. Wait until the TV cools down before reconnecting the power cable. If the blinking reoccurs, contact Philips Consumer Care.

### You forgot the code to unlock the TV lock feature

- Enter '8888'.

### The TV menu is in the wrong language.

- Change the TV menu to your preferred language.

### When turning the TV on/off/to standby, you hear a creaking sound from the TV chassis:

- No action is required. The creaking sound is normal expansion and contraction of the TV as it cools down and warms up. This does not impact performance.

### Cannot remove 'e-sticker' banner displayed on the TV.

- To remove the logos and images, set the location of your TV to home.
  1. Press **▲**.
  2. Select **[Guest menu] > [TV settings] > [Preferences] > [Location]**.
  3. Select **[Home]** and press **OK**.

---

## TV channel issues

### Previously installed channels do not appear in the channel list:

- Check that the correct channel list is selected.

### No digital channels were found during the installation:

- Check that the TV supports DVB-T, DVB-T Lite or DVB-C in your country.

### Some channels are not automatically installed on my TV:

- During installation, make sure that you select the country where you are installing the TV.

---

## Picture issues

### The TV is on, but there is no picture:

- Check that the antenna is properly connected to the TV.
- Check that the correct device is selected as the TV source.

### There is sound but no picture:

- Check that the picture settings are correctly set.

### There is poor TV reception from an antenna connection:

- Check that the antenna is properly connected to the TV.
- Loudspeakers, unearthed audio devices, neon lights, high buildings and other large objects can influence reception quality. If possible, try to improve the reception quality by changing the antenna direction or moving devices away from the TV.

- If reception on only one channel is poor, fine tune this channel.

#### **There is poor picture quality from connected devices:**

- Check that the devices are connected properly.
- Check that the picture settings are correctly set.

#### **The TV did not save your picture settings:**

- Check that the TV location is set to the home setting. This mode offers you the flexibility to change and save settings.

#### **The picture does not fit the screen; it is too big or too small:**

- Try using a different picture format.

#### **The picture position is incorrect:**

- Picture signals from some devices may not fit the screen correctly. Check the signal output of the device.

---

## Sound issues

### **There is a picture but sound quality is poor:**



#### **Note**

- If no audio signal is detected, the TV automatically switches the audio output off — this does not indicate malfunction.

- Check that all cables are properly connected.
- Check that the volume is not set to 0.
- Check that the sound is not muted.

### **There is a picture but the sound quality is poor:**

- Check that the sound settings are correctly set.

### **There is a picture but sound comes from one speaker only:**

- Verify that sound balance is set to the centre.

---

## HDMI connection issues

### **There are problems with HDMI devices:**

- Note that HDCP (High-bandwidth Digital Content Protection) support can delay the time taken for a TV to display content from a HDMI device.
- If the TV does not recognise the HDMI device and no picture is displayed, try switching the source from one device to another and back again.
- If there are intermittent sound disruptions, check that output settings from the HDMI device are correct.
- If you use an HDMI-to-DVI adapter or HDMI-to-DVI cable, check that an additional audio cable is connected to **AUDIO IN** (mini-jack only).

---

## Computer connection issues

### **The computer display on the TV is not stable:**

- Check that your PC uses the supported resolution and refresh rate.
- Set the TV picture format to unscaled.

---

## Contact us

If you cannot resolve your problem, refer to the FAQs for this product at [www.philips.com/support](http://www.philips.com/support).

If the problem remains unresolved, contact Philips Consumer Care in your country as listed in the Addendum.



#### **Warning**

- Do not attempt to repair the product yourself. This may cause severe injury, irreparable damage to your product or void your warranty.



#### **Note**

- Make a note of your TV model and serial number before you contact Philips. These numbers are printed on the back of the TV and on the packaging.

# 11 Index

---

<b>A</b>	
age rating	22
analogue channels	
language, change	23
audio language	23

---

<b>C</b>	
<b>CAM</b>	
enable	46
Insert	46
care	5
channels	
channel list	11
favourites	19
hide or unhide	19
install (automatic)	29
rearrange	31
rename	31
reorder	31
switch	11
update	29
child lock	22
clock	20
common interface	46
computer, see PC	45
Conditional Access Module	46
connect	
connect device	42
connect, PC	45
connect, USB	24
connectors	42, 44
controls	7

---

<b>D</b>	
demo	28
devices	
add	14
watch	12
digital channels	
digital radio	25
language, change	23
subtitles	23

---

dimensions	51
display, wallpaper	22

---

<b>E</b>	
<b>EasyLink</b>	
control devices, from TV remote	47
enable	47
hear from other speakers	
automatically	47
manually	48
picture quality, retain	48
subtitled video, maximise view	48
switch to standby, all devices	48
<b>Electronic Programme Guide</b>	20
<b>environmental care</b>	
end of use	5
recycle	5
while you watch TV	6
<b>EPG, menu</b>	20

---

<b>F</b>	
<b>factory settings</b>	28

---

<b>H</b>	
HDMI	42, 44
HDMI ARC	42
hearing impaired	18
high-definition (HD), content	42, 44
home menu	14
home mode	27

---

<b>I</b>	
<b>install</b>	
install channels	
install channels (automatic)	29

---

<b>K</b>	
kensington lock	49



---

<b>L</b>	
language	
audio	23
menu	23
subtitles	23
location, home or shop	27

---

<b>M</b>	
multimedia	24
multimedia, play files	24
mute TV speakers	48

---

<b>P</b>	
PC, display resolutions	50
picture format	16
picture settings	16
Pixel Plus link	48
position the TV	27
power	50
professional mode instruction	32

---

<b>R</b>	
recycle	5
reinstall TV	29
remote control	
onscreen	47
overview	8
rename channels	31
reorder channels	31

---

<b>S</b>	
screen care	5
screen saver	22
settings	
assistant	15
picture	16
sound	17
shop mode	27
sleeptimer	21
smart picture	15
smart sound	17

---

software	
digital broadcast update	27
version	26
sound settings	17
specifications	50
standby	10
subtitle, language	23
subtitles	23
switch	10
switch TV on or off	10

---

<b>T</b>	
teletext	
dual screen	18
enlarge	18
subpages	18
Table Of Pages	19
teletext 2.5	19
troubleshoot	52

---

<b>U</b>	
universal access	18

---

<b>V</b>	
visually impaired	18
volume	12

---

<b>W</b>	
wall mount	51

---

