

User Manual
Manuel de l'utilisateur
Guía del usuario

26PFL5302D
26PFL5322D
32PFL5322D
32PFL5332D
37PFL5332D
42PFL5332D
42PFP5332D
42PFP5342D
50PFP5332D
50PFP5342D

 Thank you for choosing Philips.
Need help fast?

Read your Quick Use Guide and/or Owner's Manual first for quick tips that make using your Philips product more enjoyable.

If you have read your instructions and still need assistance, you may access our online help at www.philips.com/usasupport or call **1-888-PHILIPS (744-5477)** while with your product (and Model / Serial number)

 Philips vous remercie de votre confiance.
Besoin d'une aide rapide?

Les Guide d'utilisation rapide et Manuel de l'utilisateur regorgent d'astuces destinées à simplifier l'utilisation de votre produit Philips. Toutefois, si vous ne parvenez pas à résoudre votre problème, vous pouvez accéder à notre aide en ligne à l'adresse www.philips.com/usasupport ou formez le **1-800-661-6162 (Francophone)** **1-888-PHILIPS (744-5477)** (English speaking) **Veillez à avoir votre produit à portée de main** (et model / serial nombre)

 Gracias por escoger Philips
Necesita ayuda inmediata?

Lea primero la Guía de uso rápido o el Manual del usuario, en donde encontrará consejos que le ayudarán a disfrutar plenamente de su producto Philips. Si después de leerlo aún necesita ayuda, consulte nuestro servicio de asistencia en línea en www.philips.com/usasupport o llame al teléfono **1-888-PHILIPS (744-5477)** y tenga a mano el producto (y número de modelo / serie)

Quick Use Guide Inside!
Guide d'usage Rapide Incluse!
Guía de Uso Rápido Incluida!

For Customer Use / À l'usage du client / Para Uso del Cliente

AE: Enter below the Serial No. which is located on the rear of the cabinet. Retain this information for future reference.

FR: Entrez ci-dessous le numéro de série qui se trouve à l'arrière du boîtier du dispositif. Conservez ces informations pour référence ultérieure.

ES: Escriba a continuación el N° de serie, el cual se encuentra en la parte posterior del gabinete. Guarde esta información para referencia futura.

Model / Modèle / Modelo : _____

Serial / Série / Serie: _____

PHILIPS

English

Français

Español

26PFL5302D

26PFL5322D

32PFL5322D

32PFL5332D

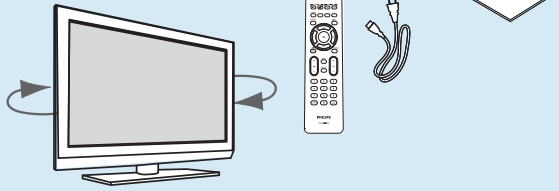

26PFL5302D

26PFL5322D

32PFL5322D

32PFL5332D

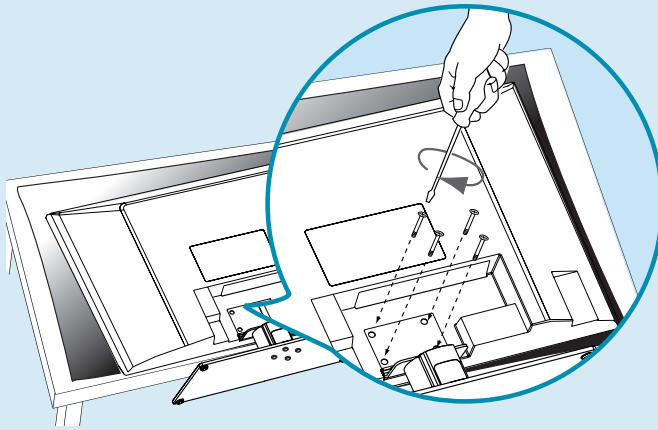
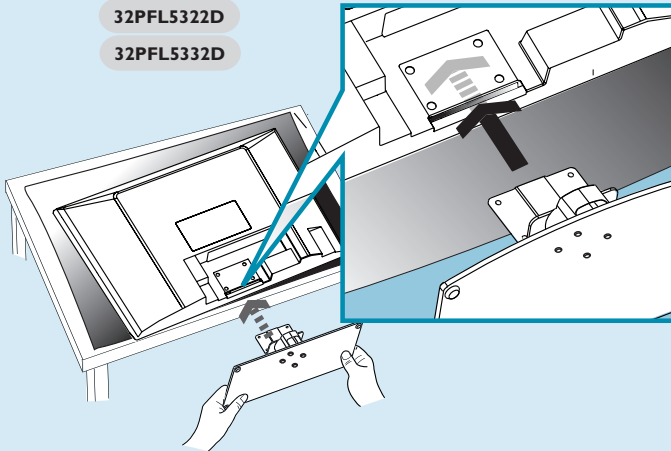

37PFL5332D

42PFL5332D

42PFP5332D

42PFP5342D

50PFP5332D

50PFP5342D

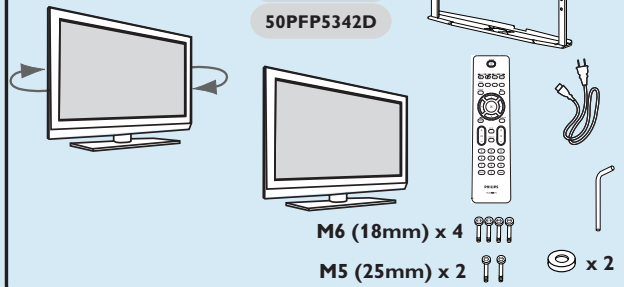

37PFL5332D

42PFL5332D

42PFP5332D

42PFP5342D

50PFP5332D

50PFP5342D

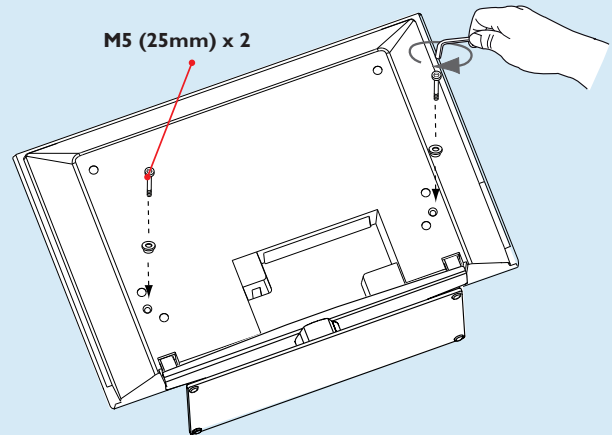
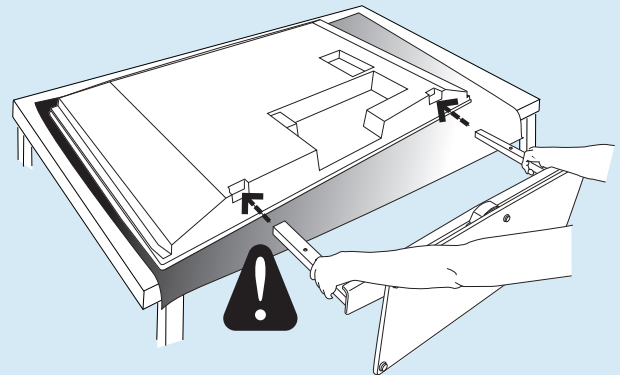
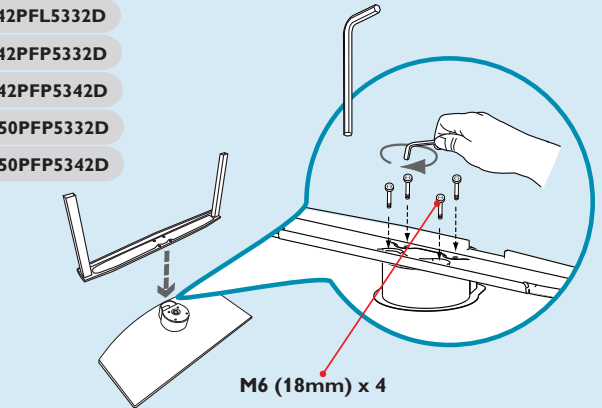





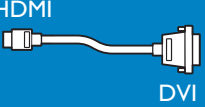

No wall mounting bracket provided.
Montage pour mur non inclus.
Montaje para pared no incluido.

How to make the optimal connection (These cables are not provided with the set.)

Comment réaliser une bonne connexion (Ces câbles ne sont pas fournis avec votre téléviseur.)

Cómo realizar la mejor conexión (Estos cables no se proporcionan con el aparato.)

   <p>HDMI</p> <p>DVI-I</p> <p>Audio</p>	<p>Best HDMI</p> <p>High-Definition Multimedia Interface provides an uncompressed, all-digital audio/video connection. (Please use a certified HDMI cable no longer than 15m).</p> <p>HDMI to DVI-I Converter cable</p> <p>Devices with only a DVI connection can be connected with a DVI to HDMI convertor cable. You must connect the Right (Red) and Left (White) audio connectors of AV1 of the TV to the audio output connectors of the device.</p>	<p>Supérieure HDMI</p> <p>L'interface HDMI (High-Definition Multimedia Interface) propose une connexion décompressée audio/vidéo entièrement numérique. HDMI propose l'ultimale connexion (Veuillez utiliser un câble HDMI certifié).</p> <p>HDMI vers DVI-I</p> <p>Câble de convertisseur</p> <p>Les dispositifs dotés seulement d'une connexion DVI peuvent être raccordés à l'aide d'un câble de convertisseur DVI vers HDMI. Vous devez raccorder les connecteurs audio droit (rouge) et gauche (blanc) AV1 du téléviseur aux connecteurs de sortie audio du dispositif.</p>	<p>La mejor HDMI</p> <p>La interfaz multimedia de alta definición (HDMI, por sus siglas en inglés) proporciona una conexión de audio/video completamente digital sin comprimir. La HDMI proporciona la mejor conexión (Sírvasse utilizar un cable HDMI certificado).</p> <p>De HDMI a DVI-I</p> <p>Cable convertidor</p> <p>Los dispositivos que sólo cuentan con una conexión DVI se pueden conectar con un cable convertidor de DVI a HDMI. Debe conectar los conectores de audio derecho (rojo) e izquierdo (blanco) de AV1 del TV a los conectores de salida de audio del dispositivo.</p>
	<p>Better Component Video input</p> <p>Provides superior picture quality by separating the green, blue and red luminance signals. Typically used with red/white audio cables.</p>	<p>Excellente Entrée vidéo composant</p> <p>Fournit une qualité d'image supérieure en séparant les signaux de luminance vert, bleu et rouge. Utilisée généralement avec les câbles audio rouge/blanc. Remarque: l'entrée vidéo composant apparaît sur le tableau de connexions comme YPbPr.</p>	<p>Mejor Entrada de video componente</p> <p>Proporciona calidad de imagen superior al separar las señales de luminancia verde, azul y roja. Se usa normalmente con cables de audio rojo/blanco. Nota: La entrada de video componente se muestra en el panel de conexión como YPbPr.</p>
	<p>Good S-Video</p> <p>Supplies a better picture than RF and Composite connections. Used with red/white audio cables.</p>	<p>Bonne S-Video</p> <p>Fournit une meilleure image que les connexions RF et composite. Utilisée avec les câbles audio rouge/blanc.</p>	<p>Buena S-Video</p> <p>Brinda una mejor imagen que las conexiones RF y compuestas. Se usa con cables de audio rojo/blanco.</p>
	<p>Basic Composite Audio/Video</p> <p>Separate video (yellow) and audio (red/white) cables that provide a basic connection from the cable box and other devices. Note: The color of audio inputs may differ, e.g. red/white or red/black.</p>	<p>De base Audio/Vidéo Composite</p> <p>Câbles vidéo (jaune) et audio (rouge/blanc) séparés fournissant une connexion de base à partir du boîtier de connexion et autres dispositifs. Remarque: La couleur des entrées audio peut varier, par ex. rouge/blanc ou rouge/noir.</p>	<p>Básica Audio/Video Compuesto</p> <p>Cables de video (amarillo) y audio (rojo/blanco), que proporcionan una conexión básica de la caja de cable y otros dispositivos. Nota: El color de las entradas de audio puede diferir, por ej., rojo/blanco o rojo/negro.</p>
	<p>Good Basic</p> <p>RF cable (Digital Antenna/cable)</p> <p>RF cable (Analog Antenna/cable)</p> <p>Provides a connection for both audio and video. (Reception vary by location.)</p>	<p>Bonne De base</p> <p>Câble RF (Antenne/Câble Numérique)</p> <p>Câble RF (Antenne/Câble Numérique)</p> <p>Fournit une connexion de base pour l'antenne ou le service et la vidéo.</p>	<p>Buena Básica</p> <p>Cable RF (Antena/Cable Digital)</p> <p>Cable RF (Antena/Cable Análogo)</p> <p>Proporciona una conexión de antena o cable básica.</p>

1a

AE: Set-Top Box to TV
FR: Boîtier de décodage vers téléviseur
ES: De la caja superior o caja de cable al TV

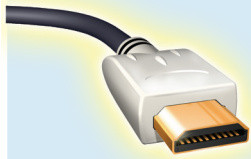

HDMI

OR/OU/O



RF

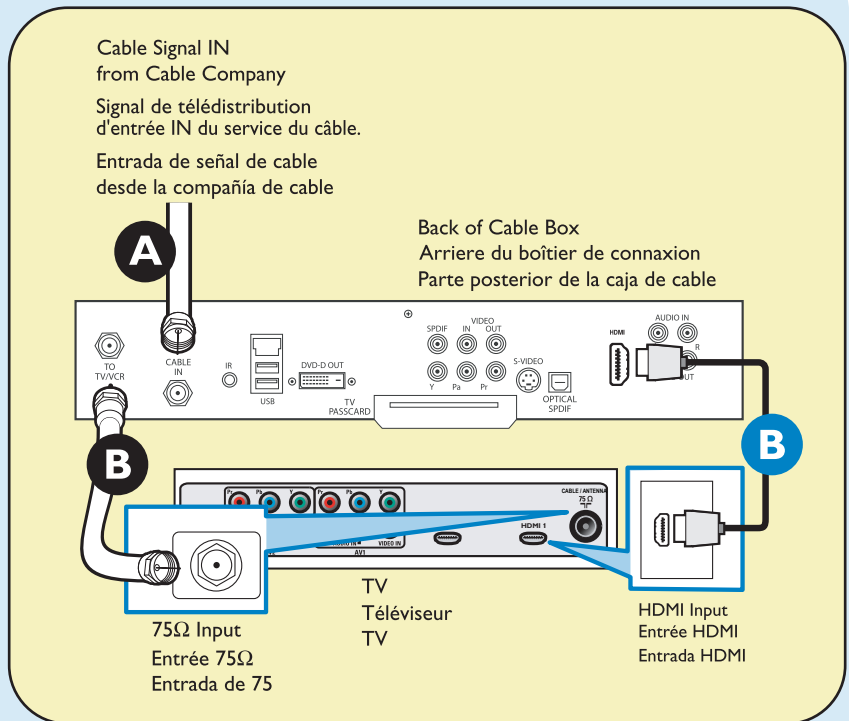

Details refer to page 21.
/Détails, consultez le page 21.
/Para detalles, consulte la pag. 21.

1b

AE: Set-Top Box to TV
FR: Boîtier de décodage vers téléviseur
ES: De la caja superior o caja de cable al TV



Component Video Input
/Entrée vidéo composant
/Entrada de video
componente

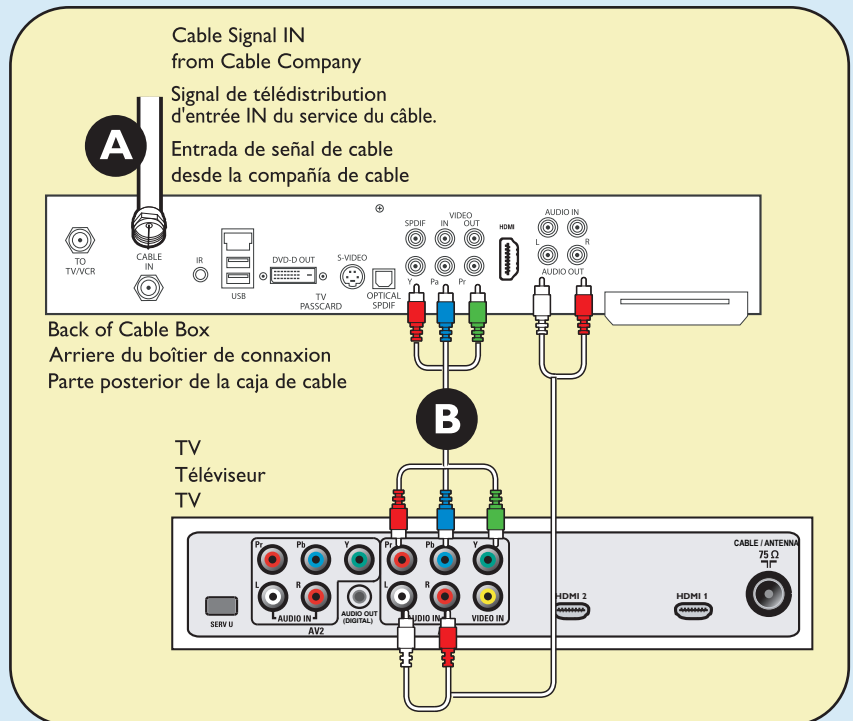

Details refer to page 21.
/Détails, consultez le page 21.
/Para detalles, consulte la pag. 21.

2a

AE: Progressive Scan DVD Player/Recorder to TV
FR: Lecteur DVD/Enregistreur DVD vers le téléviseur
ES: Del reproductor o grabador de DVD al TV

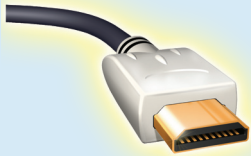

HDMI

Details refer to page 22.
/Détails, consultez le page 22.
/Para detalles, consulte la pag. 22.

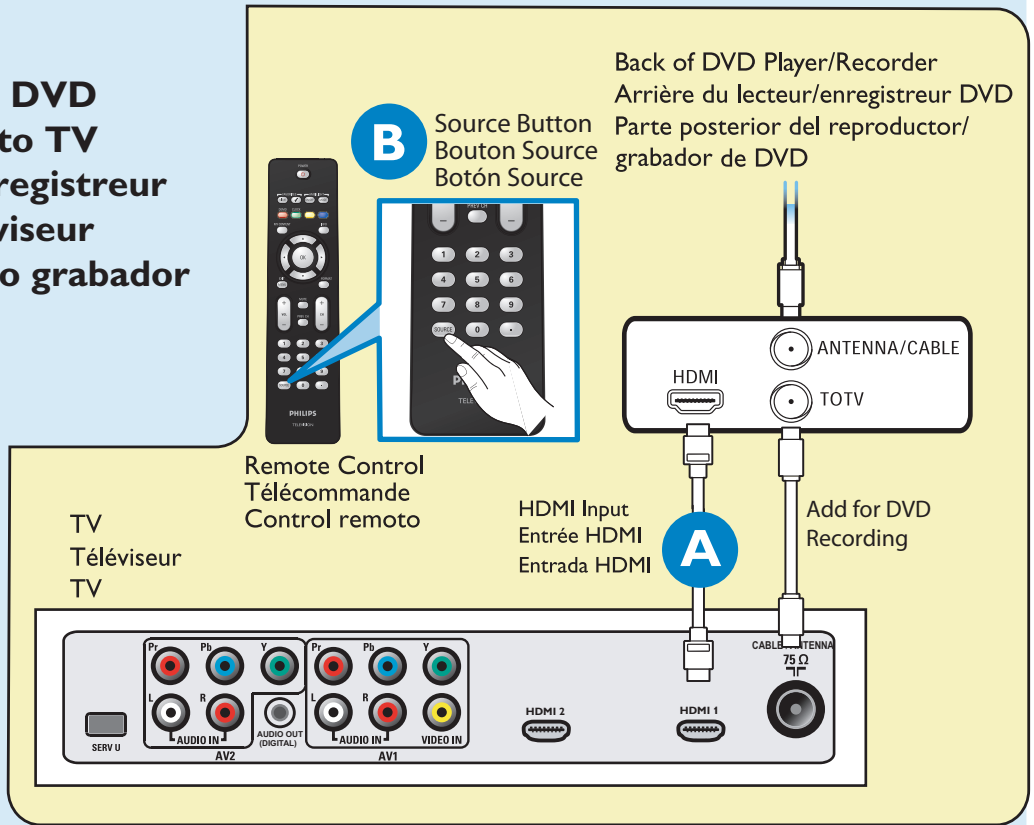

2b

AE: Progressive Scan DVD Player/Recorder to TV
FR: Lecteur DVD ou Enregistreur vers le téléviseur
ES: Del reproductor o grabador de DVD al TV

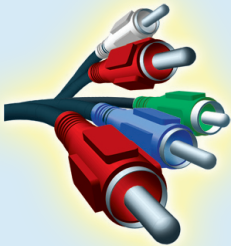

Component Video Input
/Entrée vidéo composant
/Entrada de video componente

Details refer to page 22.
/Détails, consultez le page 22.
/Para detalles, consulte la pag. 22.

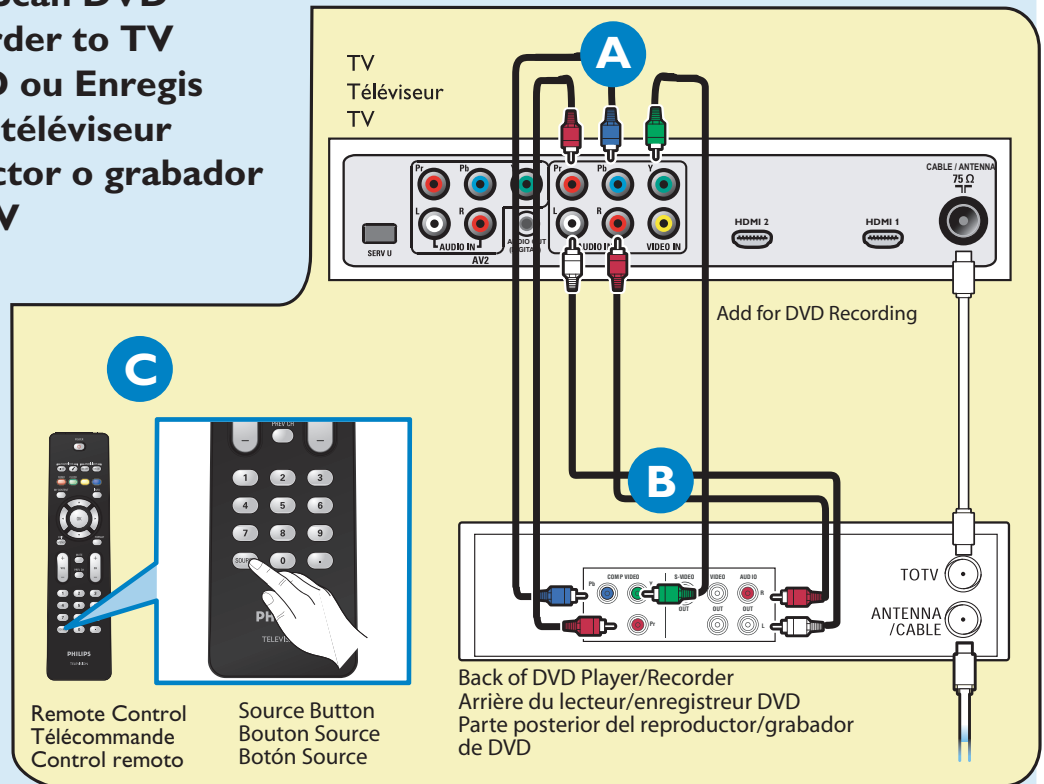

3

AE: DVD Player/Recorder/VCR to TV

FR: Lecteur DVD/Enregistreur DVD/Magnétoscope vers le téléviseur

ES: Del reproductor/grabador de DVD/VCR al TV

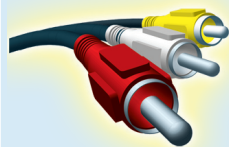

Composite Audio-video
/Audio-Vidéo composite
/Audio-Video compuesto



Remote Control
Télécommande
Control remoto

Source Button
Bouton Source
Botón Source

Back of TV
Arrière du
Téléviseur
Parte posterior
del TV

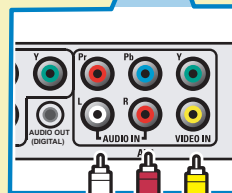
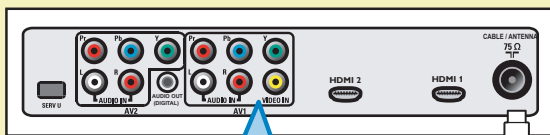

Add for DVD
Recording

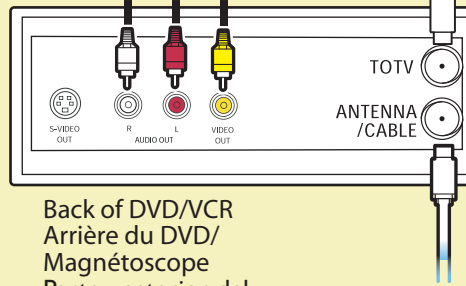

Back of DVD/VCR
Arrière du DVD/
Magnétoscope
Parte posterior del
DVD/VCR

Details refer to page 22.
/Détails, consultez le page 22.
/Para detalles, consulte la pag. 22.

4

AE: Video Camera /Games Console to TV

FR: Caméra vidéo/Console de jeux vers téléviseur

ES: De la cámara de video/ Consola de juegos al TV

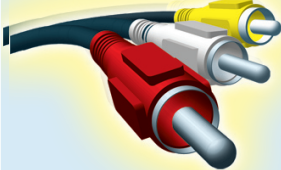

Composite Audio-video
/Audio-Vidéo composite
/Audio-Video compuesto

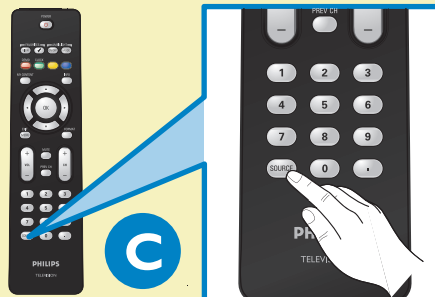

Remote Control
Télécommande
Control remoto

TV Side Jack Panel
/Tableau de connexions
du téléviseur
/Panel de enchufes del
TV

Source Button
Bouton Source
Botón Source

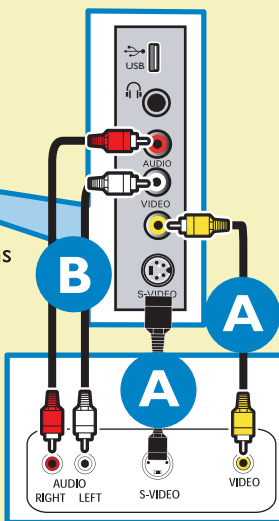
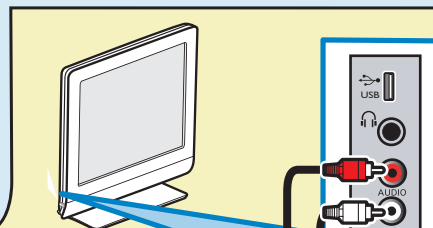

Video Camera Jack Panel
/Panneau de connexions
de la caméra vidéo
/Panel de enchufes de la
cámara de video



Details refer to page 23.
/Détails, consultez le page 23.
/Para detalles, consulte la pag. 23.

For First time Installation, refer to page 5. For USB/headphone and Digital Surround receiver details, refer to page 23.
/Pour l'Installation pour la première fois, consultez le page 5. Pour des détails d'USB/Audifono, consultez le page 23.
/Para Instalación por primera vez, vea pag. 5. Para detalles de USB/Audifono, consulte la pag. 23.

**Return your Product Registration Card or register online at
www.philips.com/usasupport today to get the very most from your purchase.**

Registering your model with PHILIPS makes you eligible for all of the valuable benefits listed below, so don't miss out. Complete and return your Product Registration Card at once, or register online at www.philips.com/usasupport to ensure:

***Proof of Purchase**

Returning the enclosed card guarantees that your date of purchase will be on file, so no additional paperwork will be required from you to obtain warranty service.

***Product Safety Notification**

By registering your product, you'll receive notification - directly from the manufacturer - in the rare case of a product recall or safety defect.

***Additional Benefits**

Registering your product guarantees that you'll receive all of the privileges to which you're entitled, including special money-saving offers.

PHILIPS

Congratulations on your purchase, and welcome to the "family!"

Dear PHILIPS product owner:

Thank you for your confidence in PHILIPS. You've selected one of the best-built, best-backed products available today. We'll do everything in our power to keep you happy with your purchase for many years to come.

As a member of the PHILIPS "family," you're entitled to protection by one of the most comprehensive warranties and outstanding service networks in the industry. What's more, your purchase guarantees you'll receive all the information and special offers for which you qualify, plus easy access to accessories from our convenient home shopping network.

Most importantly, you can count on our uncompromising commitment to your total satisfaction.

All of this is our way of saying welcome - and thanks for investing in a PHILIPS product.

P.S. To get the most from your PHILIPS purchase, be sure to complete and return your Product Registration Card at once, or register online at:

www.philips.com/usasupport

Know these
safety symbols



 This "bolt of lightning" indicates uninsulated material within your unit may cause an electrical shock. For the safety of everyone in your household, please do not remove product covering.

 The "exclamation point" calls attention to features for which you should read the enclosed literature closely to prevent operating and maintenance problems.

WARNING: To reduce the risk of fire or electric shock, this apparatus should not be exposed to rain or moisture and objects filled with liquids, such as vases, should not be placed on this apparatus.

CAUTION: To prevent electric shock, match wide blade of plug to wide slot, fully insert.

ATTENTION: Pour éviter les choc électriques, introduire la lame la plus large de la fiche dans la borne correspondante de la prise et pousser jusqu'au fond.

For Customer Use

Enter below the Serial No. which is located on the rear of the cabinet. Retain this information for future reference.

Model No. _____

Serial No. _____

PHILIPS

Visit our World Wide Web Site at <http://www.philips.com/usasupport>

IMPORTANT SAFETY INSTRUCTIONS

Read before operating equipment

1. Read these instructions.
2. Keep these instructions.
3. Heed all warnings.
4. Follow all instructions.
5. Do not use this apparatus near water.
6. Clean only with a dry cloth.
7. Do not block any of the ventilation openings. Install in accordance with the manufacturers instructions.
8. Do not install near any heat sources such as radiators, heat registers, stoves, or other apparatus (including amplifiers) that produce heat.
9. Do not defeat the safety purpose of the polarized or grounding-type plug. A polarized plug has two blades with one wider than the other. A grounding type plug has two blades and third grounding prong. The wide blade or third prong are provided for your safety. When the provided plug does not fit into your outlet, consult an electrician for replacement of the obsolete outlet.
10. Protect the power cord from being walked on or pinched particularly at plugs, convenience receptacles, and the point where they exit from the apparatus.
11. Only use attachments/accessories specified by the manufacturer.
12.  Use only with a cart, stand, tripod, bracket, or table specified by the manufacturer, or sold with the apparatus. When a cart is used, use caution when moving the cart/apparatus combination to avoid injury from tip-over.
13. Unplug this apparatus during lightning storms or when unused for long periods of time.
14. Refer all servicing to qualified service personnel. Servicing is required when the apparatus has been damaged in any way, such as power-supply cord or plug is damaged, liquid has been spilled or objects have fallen into apparatus, the apparatus has been exposed to rain or moisture, does not operate normally, or has been dropped.
15. This product may contain lead or mercury. Disposal of these materials may be regulated due to environmental considerations. For disposal or recycling information, please contact your local authorities or the Electronic Industries Alliance: www.eiae.org.
16. **Damage Requiring Service** - The appliance should be serviced by qualified service personnel when:
 - A. The power supply cord or the plug has been damaged; or
 - B. Objects have fallen, or liquid has been spilled into the appliance; or

- C. The appliance has been exposed to rain; or
 - D. The appliance does not appear to operate normally or exhibits a marked change in performance; or
 - E. The appliance has been dropped, or the enclosure damaged.
17. **Tilt/Stability** - All televisions must comply with recommended international global safety standards for tilt and stability properties of its cabinets design.
 - Do not compromise these design standards by applying excessive pull force to the front, or top, of the cabinet which could ultimately overturn the product.
 - Also, do not endanger yourself, or children, by placing electronic equipment/toys on the top of the cabinet. Such items could unsuspectingly fall from the top of the set and cause product damage and/or personal injury.
 18. **Wall or Ceiling Mounting** - The appliance should be mounted to a wall or ceiling only as recommended by the manufacturer.
 19. **Power Lines** - An outdoor antenna should be located away from power lines.
 20. **Outdoor Antenna Grounding** - If an outside antenna is connected to the receiver, be sure the antenna system is grounded so as to provide some protection against voltage surges and built up static charges. Section 810 of the National Electric Code, ANSI/NFPA No. 70-1984, provides information with respect to proper grounding of the mats and supporting structure grounding of the lead-in wire to an antenna-discharge unit, size of grounding connectors, location of antenna-discharge unit, connection to grounding electrodes and requirements for the grounding electrode. See Figure below.
 21. **Objects and Liquid Entry** - Care should be taken so that objects do not fall and liquids are not spilled into the enclosure through openings.
 - a) Warning: To reduce the risk of fire or electric shock, this apparatus should not be exposed to rain or moisture and objects filled with liquids, such as vases should not be placed on this apparatus.
 22. **Battery Usage CAUTION** - To prevent battery leakage that may result in bodily injury, property damage, or damage to the unit:
 - Install all batteries correctly, with + and - alignment as marked on the unit.
 - Do not mix batteries (old and new or carbon and alkaline, etc.)
 - Remove batteries when the unit is not used for a long time.

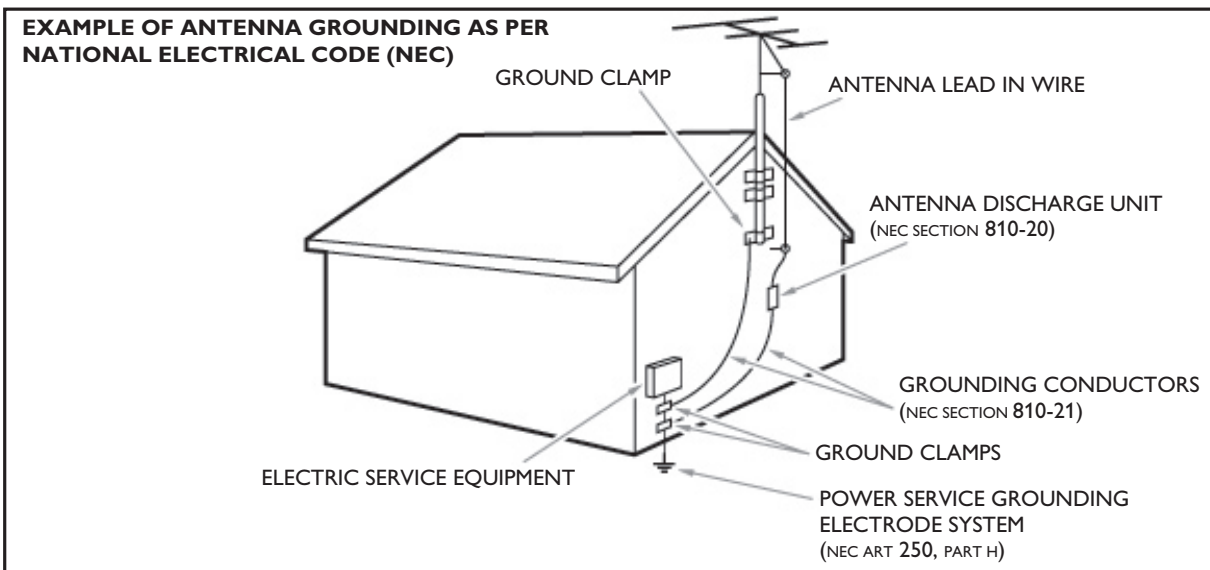

Note to the CATV system installer: this reminder is provided to call the CATV system installer's attention to Article 820-40 of the NEC that provides guidelines for proper grounding and, in particular, specifies that the cable ground shall be connected to the grounding system of the building, as close to the point of cable entry as practical.

Contents

A Guide to Digital TV	2	- Channel lock	15
Preparation	2	- TV ratings lock.....	15
First time installation	5	- Movie ratings lock	16
Use of the remote control	6	- Region ratings lock	16
Control Buttons on the TV	7	- Set/Change PIN.....	16
TV settings	8	- On timer	17
Settings assistant	8	Installation menu	17
Standard settings.....	8	Select the menu language	17
To use the menus	9	Channel menu	17
Introduction.....	9	Store TV channels	17
How to navigate through the TV menus	9	Installation update.....	18
Demo	9	Weak channel installation	18
Picture menu	10	Installation mode.....	18
- Contrast	10	Uninstall channels.....	18
- Brightness	10	Preferences menu	18
- Color	10	- Location.....	18
- Tint	10	- OSD.....	19
- Sharpness	10	- Show emergency alerts (EAS).....	19
- Color temperature.....	10	- Download rating table.....	19
- Custom color temperature.....	10	Connections	20
- Pixel Plus	10	Clock	20
- Dynamic contrast.....	11	- Auto clock mode.....	20
- DNR (Digital Noise Reduction).....	11	- Auto clock channel	20
- MPEG artifact reduction.....	11	- Time - Day	20
- Color enhancement.....	11	- Time zone	20
- Active Control.....	11	- Daylight saving	20
- Picture format.....	11	Reset AV settings	21
Sound menu	12	Software upgrade	21
- Equalizer	12	Connect Accessory Devices	21
- Volume	12	Set Top Box to TV	21
- Balance	12	Progressive Scan DVD Player/Recorder to TV	22
- Digital Audio Language.....	12	DVD Player/DVD Recorder/VCR to TV	22
- Alternate audio.....	12	Video Camera/Games Console to TV	23
- Mono/Stereo.....	12	Side connections - USB/Headphone.....	23
- Sound mode.....	12	Digital Surround receiver	23
- Headphone volume	12	Multimedia browser	24
- AVL (Automatic Volume Leveler)	12	Multimedia Browser menu.....	24
- Delta volume.....	12	Record with your recorder	25
- Auto surround.....	12	Record a TV program.....	25
Features menu	13	To select connected devices	25
- Closed captions	13	Troubleshooting Tips	26
- Caption service.....	13	Tips	27
- Digital caption service.....	13	Glossary	28
- Digital caption options	14	Specifications	29
- Sleep timer	14	Annex 1 - Philips TV software upgrade with portable memory	31
Favorite list	15	Annex 2 - Philips TV Slideshow Format with background music	33
Child lock menu	14	Annex 3 - Philips TV USB	35
- Lock after	15		

Care of the screen
See *Tips*, p. 28.



End of life directives

Philips is paying a lot of attention to produce environmentally-friendly products in green focal areas. Your new TV contains materials which can be recycled and reused. At the end of its life specialized companies can dismantle the discarded TV to concentrate the reusable materials and to minimize the amount of materials to be disposed off. Please ensure you dispose off your old TV according to local regulations.

Recycling
The materials used in your set are either reusable or can be recycled. To minimise environmental waste, specialist companies collect used appliances and dismantle them after retrieving any materials that can be used again (ask your dealer for further details).



Warning concerning stationary images on the TV screen *(only for Plasma Displays)*

A characteristic of Plasma Display Panels is that displaying the same image for a long time can cause a permanent after-image to remain on the screen. This is called phosphor burn in.

Normal use of the TV should involve the showing of pictures that contain constantly moving and changing images that fill the screen.

Please refer to pg 27 for details.

THIS IS NOT INCLUDED IN THE PHILIPS LIMITED WARRANTY.

A Guide to Digital TV

What is Digital Television (DTV)?

Digital Television (DTV) is relatively new type of broadcasting that promises to transform television viewing into a whole new experience. Digital technology is used to capture images and sound to deliver a better picture quality. DTV technology is also capable of multicasting and interactive capabilities.

There are many levels of digital television quality. The most common are:

Standard Definition TV (SDTV)

SDTV is the basic level of quality display and resolution for both analog and digital. Transmission of SDTV can be in the traditional (4:3) or widescreen (16:9) format.

Enhanced Definition TV (EDTV)

EDTV is better in picture quality than analog television. The formats for EDTV are 480p widescreen (16:9) or traditional (4:3). EDTV is in the middle range quality between SDTV and HDTV.

High Definition TV (HDTV)

HDTV has the highest quality for digital broadcast formats. Its resolution is widescreen format (16:9). Combined with digitally enhanced sound technology, HDTV sets new standards for sound and picture quality in television.

DTV is by far a more flexible and efficient technology than the analog broadcast system. Analog broadcasts can only provide one program at a time. Digital television can broadcast a high definition program or more than one standard definition program at the same time. This is often referred to as "multicasting". Digital television can also give you interactive video and data services through a single digital channel.

Preparation

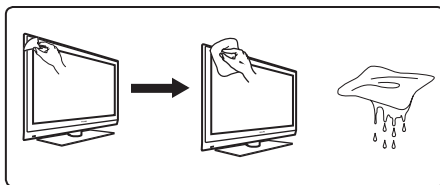

Note : Use only a soft cloth to clean the front of the TV.

Do not insert the power plug in a wall socket before all connections are made.

Place the TV on a solid surface or place the TV on the supplied stand. For the mounting instructions of the stand, see the Cover Page. For ventilation, leave at least 4" to 6" free all around the TV. Do not place the TV on a carpet. To prevent any unsafe situations, no naked flame sources, such as lighted candles, should be placed in the vicinity. Avoid heat, direct sunlight and exposure to rain or water. The equipment shall not be exposed to dripping or splashing.

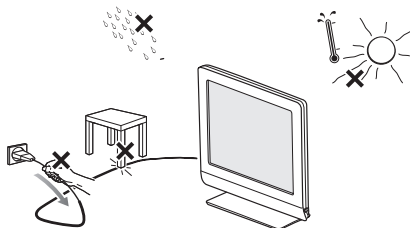

Mounting the TV on the wall

This TV is compatible with the VESA wall mounting standard. Please contact your local electronics retailer for a VESA compliant bracket to wall mount this TV.



Caution: Installing the TV requires special skill that should only be performed by qualified personnel. You should not attempt to do the work yourself. Philips bears no responsibility for improper mounting or mounting that results in accident or injury.

1 Basic connections to the TV

Your integrated digital TV automatically decodes and displays the four basic DTV picture resolution standards.

- SDTV (Standard Definition TV) are broadcast as 480i (480-line interlaced) or 480p (480-line progressive scan) video.
- HDTV (High-Definition TV) are broadcast either in the 1080i or 720p formats, always with a widescreen picture.

Note: Progressive scan video (p) is more like that you see in a movie theater. Images are much more distinct and free of flicker, and motion is smoother.

Next to analog NTSC broadcast reception, your TV has an integrated High Definition TV tuner which receives, decodes and displays terrestrial ATSC and unscrambled cable (QAM) signals.

HDTV quality is only reproduced when a broadcaster or cable provider broadcasts HDTV signals.

There are 2 ways to get HDTV content:

- via cable,
- via antenna.

Note: This drawing is used wherever you can connect cable or antenna.

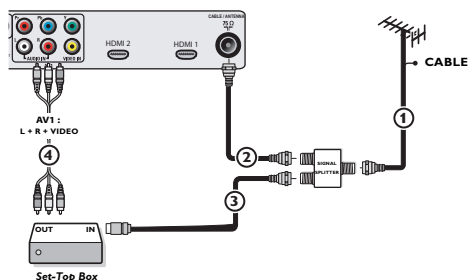
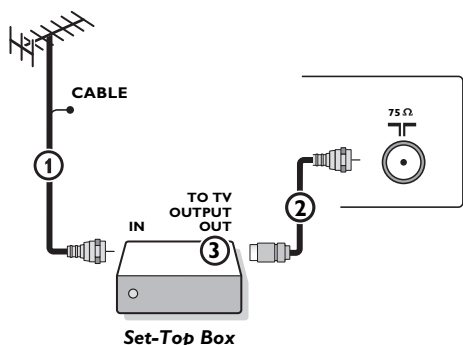
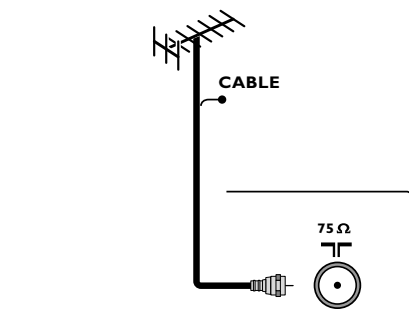

Watching Cable TV programs that don't require the cable box

Since you've connected the cable TV signal directly to the TV's tuner, you can also watch the unscrambled programs by simply tuning to the desired channel. You must first use Autoprogram, however, to store channels in the TV's memory. See page 18.

Note: This connection will supply stereo sound to the TV if it is being broadcast by the station you are watching.

- Cable TV

Connect the cable TV signal to the CABLE/ANTENNA 75 Ω jack at the bottom of the TV. See page 18 for details on using Autoprogram to store channels in the TV's memory.

Note: this connection will supply stereo sound to the TV if it is being broadcast by the station you are watching.

- Cable box with RF IN/OUT

- Connect the incoming cable TV signal to the cable IN jack ① on the back of the cable box.
- Connect a coaxial cable (not supplied) from the TO TV jack on the back of the cable box to the CABLE/ANTENNA 75 Ω jack ② at the bottom of the TV.
Note: Your cable box may have a different label for the TO TV jack, such as OUTPUT or OUT.
- Set the OUTPUT CH switch ③ of the cable box to CH 3 or 4 (whichever is correct for your cable box), then tune the TV to the corresponding channel. Once tuned, change channels at the cable box, not the TV.

Note: This connection will not supply stereo sound to the TV. The reason is that the RF output on a cable box - labeled TO TV, OUT or OUTPUT for example - will not send a stereo signal to the tuner (VHF/UHF) input on a TV.

- Cable box with A/V outputs

- Connect the incoming cable TV signal ① to a signal splitter (not supplied). The signal splitter enables you to avoid having to use the TO TV jack on the back of the cable box. This jack will not supply stereo sound to the TV.
Note: Your cable box may have a different label for the TO TV jack, such as OUTPUT or OUT.
- Connect a coaxial cable (not supplied) to a connector on the signal splitter and to the CABLE/ANTENNA 75 Ω jack ② on the TV.
- Connect another coaxial cable (not supplied) to a connector on the signal splitter and to the cable IN jack ③ on the back of the cable box.
- Connect A/V cables (not supplied) to the VIDEO and AUDIO L and R outputs on the back of the cable box and to the AV2 video (labeled VIDEO) and AUDIO (labeled L and R) jacks ④ on the back of the TV.
- To view programs from your cable box, first press the SOURCE button on the remote control.
- Press the cursor down or up buttons until the AV2 signal source is selected.
- Press the OK button to confirm your selection. The AV2 input source becomes current for the viewing of cable TV programs through your cable box.

Note: If your cable box Audio/Video outputs will not supply video and stereo audio to the TV, you will need to make the connection shown above in the example "Cable box with RF IN/OUT".

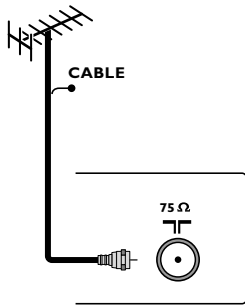

- **Cable box with S-Video, component video (YPbPr) or HDMI connectors**

See Connect Accessory Devices, p. 22.

- **Antenna**

Via antenna you can watch whatever DTV programs being broadcast in your area for free.

If you're not sure what HDTV programming is available in your area, contact your local content provider or your local electronics store retailer.

Broadcasters are in the middle of a transition from analog to digital TV. This means that a given broadcaster will have two channels on the air, one analog and one digital.

Connect the incoming antenna signal to the **CABLE/ANTENNA 75 Ω**

⏏ jack at the bottom of the TV. See page 18 for details on using Autoprogram to store channels in the TV's memory.

Note: This connection will supply stereo sound to the TV if it is being broadcast by the station you are watching.

- **Direct Broadcast Satellite (DBS)**

Satellite systems offer many of the same premium channels as cable systems, and often at a lower price. To get these channels, you'll need to install a small dish antenna outside.

There are 2 main DBS systems: DirecTV & DishNetwork. These systems require separate, proprietary set top receiver boxes to decode their signals and send them to your digital TV set. These boxes may include a digital TV tuner for off-air DTV broadcasts.

Satellite broadcasters also provide major local channels, depending on the market in which you live.

DBS also provides service in areas not covered by cable because they are in rural areas or other areas not passed by a cable line.

DBS also allows you to watch pay-per-view events.

- 2 Before installing your TV or before hanging it on the wall, connect all your accessory devices. See p. 22.
- 3 Refer to the bottom of the set for the correct operation voltage. Insert the power cord in the wall socket.
Consult your local dealer if your mains supply is different. To prevent damaging the mains (AC) cord which could cause a fire or electric shock, do not place the TV on the cord.
- 4 Remote control:
Insert the 2 batteries supplied (Type R6-1,5V). Be sure the (+) and (-) ends of the batteries line up correctly (inside of case is marked.)
The batteries supplied do not contain the heavy metals mercury and cadmium. Please check on how to dispose of exhausted batteries according to local regulations.
- 5 Turn the TV on:
Press the power switch (⏏) at the side of the TV. You may also press **+CH-** or **POWER** button on the remote control.
The TV can take up to 15 seconds to power up.
A blue indicator light on the front of the TV lights up.

First time installation

Note: **The first time** (and only the first time) you turn on your set you see an installation introduction screen. The **Installation procedure** consists of a series of screens that guide you through the process.

- 1 After an introduction screen, you are asked to select a language of the TV's on-screen-menus. (The text of the header and the info on screen continuously change language.)
- 2 Press the cursor up/down to highlight your language.
- 3 Press the **OK** button.
- 4 Follow the on-screen instructions to proceed.

Part 1: TV installation

(Please skip this section if you have no cable connected to the Antenna input of the TV.)

Note - The TV will take approximately 10-15 seconds to start up.

- 1 Select the desired **Language** and press the green button "**Next**".
- 2 Select **Cable** or **Antenna** in the Installation mode and press the green button "Next".
- 3 Auto Installation may take **20 to 40 minutes** depending on the number of channels that are transmitted by the cable provider or broadcaster.
- 4 When the TV is not receiving any signal from the antenna/cable, the message **CHANNEL NOT AVAILABLE** will appear on the TV screen. When no transmission is received from the broadcaster, a **BLANK SCREEN** will appear on the TV screen.
Note - The TV will go on to standby after 10 minutes. Press the **POWER** button on the remote control to on the TV.
- 5 You will not be able to receive pay channels when using direct antenna/cable connection to the television.
- 6 When the Set-top box is connected to the television using coaxial cable, it is necessary to auto-program the television for the single channel (3 or 4) that the Set-top box outputs and change the channels at the Set-top Box (using the set-top remote control) to view the program. Refer to the manual for more details.
Note - The newly installed channels maybe sorted in a different sequence on this TV. Please key using the CH +/- buttons to get to know the new channel. Also you can use the OK key to see the list of channels.
- 7 When the Set-top box is connected to the television using one of the AV connections (AV 1/ AV 2/ HDMI 1/ HDMI 2), select that input source (using the Source button) to view the programs and change the channels at the Set-top Box (using the set-top box remote control) to view the program.

Part 2: Settings assistant

By means of several split screens/full screens you are prompted to select your preferred picture and sound settings, to finally arrive at a complete setting which satisfies you.

- 1 Press the green color button on your remote control to enter the **Settings assistant** menu.
- 2 Select your **Location** with the cursor up/down and press the green color button.
If you choose **Shop** it will skip the Settings assistant. The TV parameters for Picture and Sound will then be set to predefined fixed settings. Press the green color button again to proceed.
If you choose **Home** it will display the Settings assistant.
- 3 Use the cursor left/right to each time select your preferred screen.
- 4 Press the green color button to each time confirm your selection and to jump to the following screen.
The following items will be presented sequentially. In the header it is mentioned how many screens have been completed and how many screens there are in total. The Settings assistant will step sequentially through the following settings: Picture and Sound.
- 5 Press the green color button once to store all the settings and to return to the TV installation menu.
Note: When you skip or stop the Settings Assistant, then the Standard settings Philips selected for you will be chosen.
- 6 Press the red color button to finish the First time installation procedure and to display the first stored TV channel.

Use of the remote control

Note: For most buttons pressing a button once will activate the function. Pressing a second time will de-activate it. When a button enables multiple options, a small list will be shown. Press repeatedly to select the next item in the list. The list will be removed automatically after 6 seconds or press **OK** to remove immediately.

POWER

Press to turn on/off the TV from or to standby mode.

The TV is never powered off completely unless it is physically unplugged.

DEMO Demo menu on/off

See p. 9.

Color buttons

When functions attached to the color buttons, the color buttons are shown on screen.

OPTION

To select the Audio Language, Closed Captions, Picture format, Equalizer and Clock.

OK

- to activate a setting
- to display the list of channels stored (according to the selection made in the Installation mode (Antenna or Cable), p. 18.
- starts playing content in the Home Multimedia Browser application, p. 25.

MENU

Settings menu on/off, see p. 9.
Exit menu from sub-menu.

VOL (Volume)

Press + or - to adjust the volume.

MUTE

Turn off or on sound.

SOURCE

Press this button repeatedly to select the source - **AV 1, AV 2, HDMI 1, HDMI 2, SIDE** or **TV** when in TV mode, according to where you connected the accessory devices (p. 21).

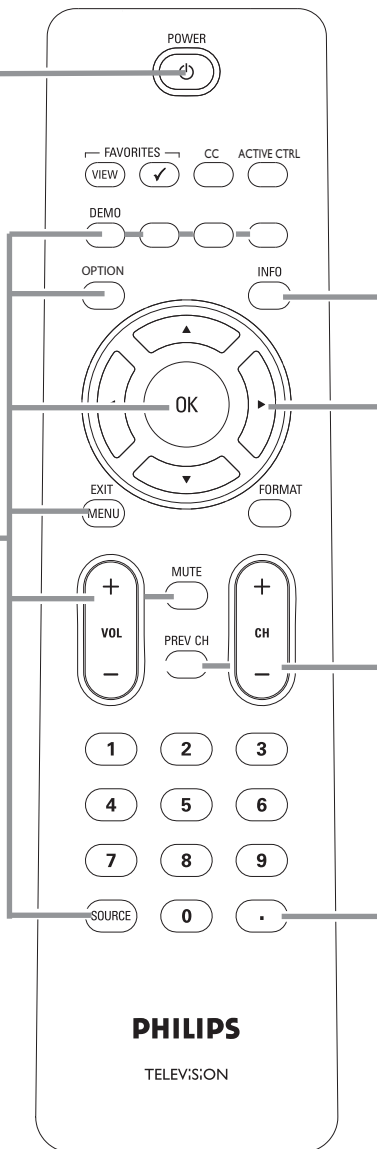

Cursor buttons

Press the cursor buttons up/down, left/right to navigate through the menus.

CH Channel selection

- To browse through the TV channels.
- To select between Antenna or Cable TV channels, first make your selection in the Settings menu, see, p. 17.

Note: You don't have to start the installation again once you have searched for and stored the available TV channels.

PREV CH

Press to alternate between the currently viewed channel and the previously viewed channel.

Press the dot (.) for digital channels.

INFO

Display information: Press to display (when available) information about the selected TV channel and program or accessory device. The quality and accuracy of the information on the information banner are transmitted from broadcasters. You may see a difference in broadcast time if the broadcaster is from a different time zone area.

Display clock: Select to activate/deactivate the clock display on the screen.

To be continued.

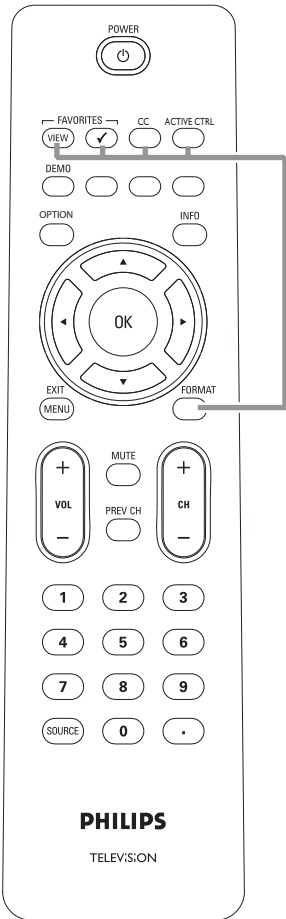

FORMAT

Press this button to summon a list of available display formats (depending on the receiving signal). This lets you choose the display format of your preference.
 Press this button repeatedly to select another picture format: Automatic, Super Zoom, 4:3, Movie expand 14:9, Movie expand 16:9, Wide screen.

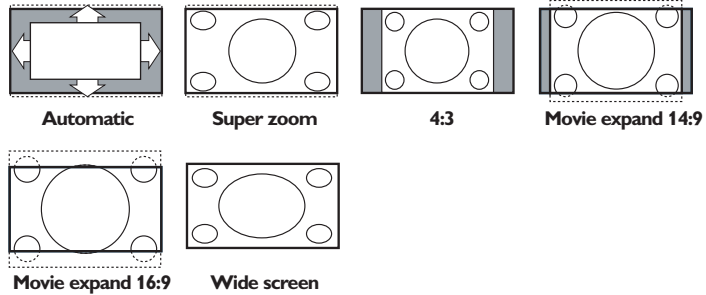

Automatic makes the picture fill the screen as much as possible.
 Super zoom removes the black bars on the sides of 4:3 programs with minimal distortion.
 When in Movie expand 14:9, Movie expand 16:9 or Super zoom picture format, you can make subtitles visible with the cursor up/down.

Note: With HD sources not all screen formats will be available.

FAVORITES

- **VIEW** To display a list of all channels marked as favorite (incl. subchannels).
- ✓ No function.

CC (Closed captions)

Select **On** or **Off** to activate/de-activate Closed captions. See p. 13.

ACTIVE CONTROL

The TV continues measures and corrects all incoming signals in order to provide the best picture possible. Select **On** or **Off** to activate/de-activate Active control.

Control Buttons on the TV

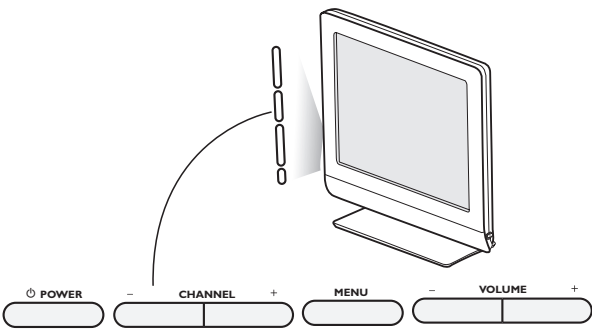

Should your remote be lost or broken you can still change some of the basic settings with the buttons on your TV.
 Press the power switch to switch the TV on.

- Press:
- the + **VOLUME** - button to adjust the volume.
 - the + **CHANNEL** - buttons to select the TV channels or sources.

The **MENU** button can be used to summon the Settings menu without the remote control.

- Use:
- the + **VOLUME** - buttons to select left/right menu items and the + **CHANNEL** - buttons to select up/down menu items.

TV settings

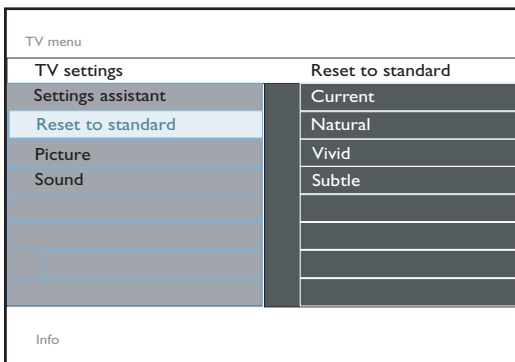
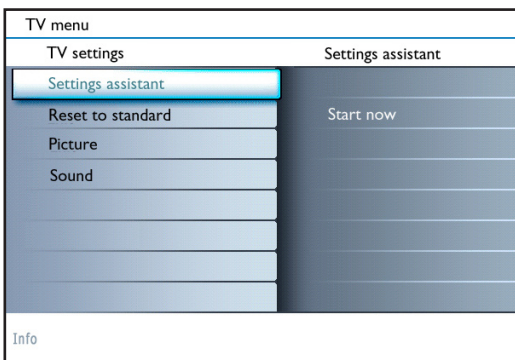
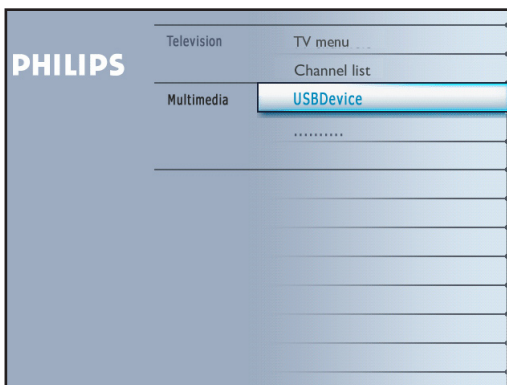

Settings assistant

Each time you have made a selection, press the green color button to confirm your selection.

- 1 Select **Settings assistant** and press the cursor right.
 Note: By means of several split screens/full screens you are prompted to select your preferred picture, sound and ambilight settings to finally arrive at a complete setting which satisfies you.
 See *First time installation*, p. 5.
- 2 Press the green color button to return to the TV menu again.

Reset to standard

This allows you to reset your settings for viewing and listening to predefined factory settings.

- 1 Select **Reset to standard** and press the cursor right.
 A menu appears which allows you to select one of the standard settings for viewing and listening.
Current: shows your current settings for viewing and listening.
Natural: allows you to set your picture and sound settings to the recommended standard values. In most cases this will give the best balanced viewing experience.
Vivid: allows you to set your picture and sound settings to rich values, making use of the TV capabilities to its full extend.
Subtle: allows you to set your picture and sound settings to the purest representation of the original source content.
- 2 Press the green color button to store the selected setting.

To use the menus

Introduction

A lot of guiding instructions, help texts and messages will be displayed on your TV when using the menus or when trying to execute an action. Please, follow the instructions and read the help text which are being displayed on the specific item highlighted. The color buttons refer to different actions which may be executed depending on the activated device. Press the corresponding color button on the remote control to perform the required action.

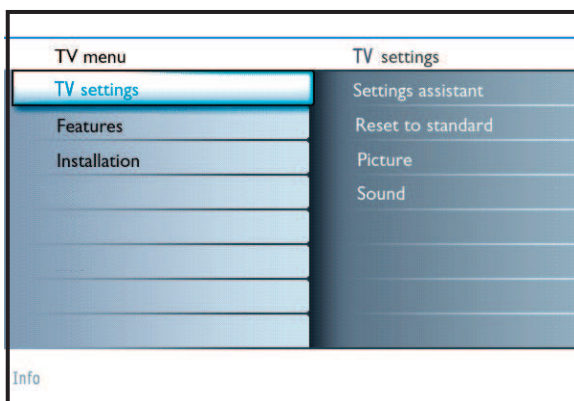

How to navigate through the TV menu

The TV menu allows you to access and change settings and preferences.

- Press the **MENU** button on the remote control to summon the TV menu.
 - On the left panel the highlight can be set on a menu item with the cursor up/down. The right panel shows the content of the highlighted menu item in the left panel.
Note: Sometimes not all the menu items are visible on the screen. Use the cursor down to reveal all items.
 - Use the cursor right to enter the right panel. The content of the right panel is moved to the left panel and the right panel shows the content of the newly highlighted item in the left panel.
Note: In some cases it is important that the picture can be watched while adjusting the settings. This means that when the highlight is on the right side panel, the other menu items hide away. When the cursor left is pressed again, the hidden menu items re-appear and the highlight moves to the left panel.
- Press the cursor left to go one menu level up again.
 - Press the **OK** button on the highlighted item to activate and to dismiss the menu.
 - Press the **MENU** button again to exit the Settings menu.
Note: The menu is also dismissed by pressing one of the color buttons (if present) referring to certain actions which may be executed.

Demo

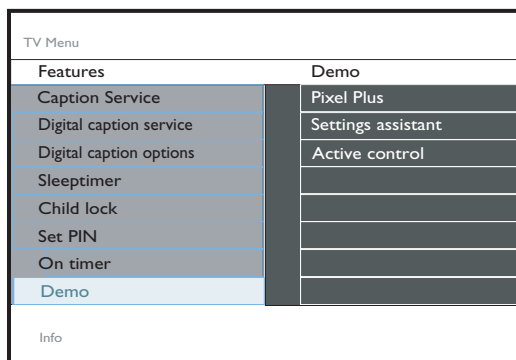

The **Demo** menu allows the user to get an idea of the features that are part of the television.

- 1 Select **Demo** in the Features menu and press the cursor right.
- 2 Highlight a desired demo with the cursor up/down.
- 3 Press **OK** to start playing the highlighted demo. Press the red color button to stop the function. Press the red color button again to exit the demo and to return to TV mode.

Note: The selected demo is played once.

The demos require no user interaction except for starting the demo.

Picture menu

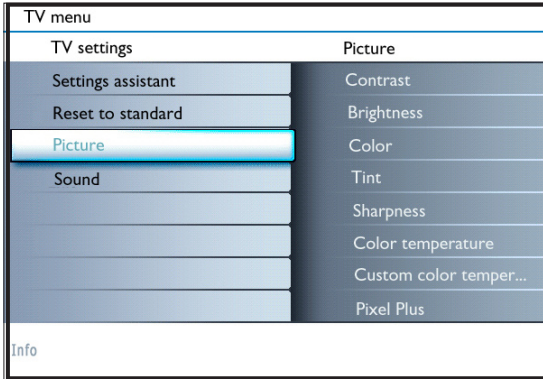
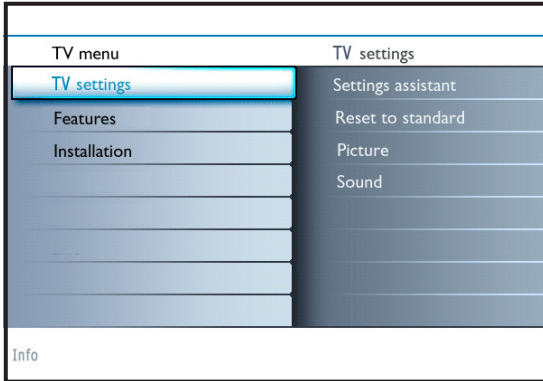

Press the **MENU** button on the remote control to summon the TV menu. The TV menu gives you an overview of the menus you can select.

Note: Depending on the input signal, one or more menu items may not be selectable.

Picture menu

Note: Some menu items are not available in case of HD sources.

- 1 Press the cursor right to select **Picture**.
- 2 Press the cursor right again to enter the Picture menu.
- 3 Select the menu items with the cursor up/down.
- 4 Adjust the settings with the cursor left/right or enter the list of submenu items with the cursor right. Select a submenu item with the cursor up/down.

Contrast

This will adjust the intensity of bright parts in the picture but keep the dark parts unchanged.

Brightness

This will adjust the light output of the complete picture, which will mainly affect the darker areas of the picture.

Color

This will adjust the saturation level of the colors to suit your personal preference.

Tint

Allows you to select the color mix (hue) of the picture.

Sharpness

This will adjust the sharpness of fine details in the picture.

Color temperature

This will increase or decrease **Warm** (red) and **Cool** (blue) colors to suit personal preferences.

Select **Cool** to give the white colors a blue tint, **Normal** to give the white colors a neutral, **Warm** to give the white colors a red tint.

Custom color temperature *(only when Color temperature is set to Custom)*

Fine tunes the white point (**WP**) and black level (**BL**) of the picture.

- 1 Select **Custom color temperature** and press the cursor right.
- 2 Use the cursor buttons to select and adjust the settings of:
 - R-WP**: allows you to customize the color temperature by adjusting the red whitepoint of the picture.
 - G-WP**: allows you to customize the color temperature by adjusting the green whitepoint of the picture.
 - B-WP**: allows you to customize the color temperature by adjusting the blue whitepoint of the picture.
 - R-BL** : allows you to customize the color temperature by adjusting the red blacklevel of the picture.
 - G-BL** : allows you to customize the color temperature by adjusting the green blacklevel of the picture.
- 3 Use the color button to reset to the predefined settings.
- 4 Press the cursor left to return to the Picture menu.

Pixel Plus

for everyday viewing, Pixel Plus is the most ideal setting, as it fully processes the image to make every single pixel the best it can be, improving contrast, sharpness, picture depth, and color reproduction and brilliance from every source, including High Definition.

TV menu TV settings	
Picture	Active Control
Custom color temperature	Off
Pixel Plus	On
Dynamic contrast	
DNR	
MPEG artifact reduction	
Color enhancement	
Active control	
Picture Format	

Info

Dynamic contrast

Automatically makes the contrast in the darker and the brighter picture areas more noticeable as the image on the screen changes.

Normally select **Maximum**. It may be preferred to select **Minimum**, **Medium**, **Maximum** or **Off**.

- ❶ Press the cursor right to enter the list.
- ❷ Select one of the settings with the cursor up/down.
- ❸ Press the cursor left to return to the picture menu.

DNR (Digital Noise Reduction)

Automatically filters out and reduces the image noise and improves picture quality when receiving weak video signals.

- ❶ Press the cursor right to enter the list.
- ❷ Select **Off**, **Minimum**, **Medium** or **Maximum** according to the image noise.
- ❸ Press the cursor left to return to the picture menu.

MPEG artifact reduction

MPEG artifact reduction On smoothens the transitions on digital content.

- ❶ Select **On** or **Off**.

Color enhancement

When activated, this feature automatically controls green enhancement and blue stretch. It makes the colors more vivid.

- ❶ Press the cursor right.
- ❷ Select **Off**, **Minimum**, **Medium** or **Maximum** in order to activate/de-activate Color enhancement with the cursor right.

Active Control

The TV continuously measures and corrects all incoming signals in order to provide the best picture possible.

- ❶ Select **Active Control**.
- ❷ Press the cursor right to enter the list of Active Control values.
- ❸ Press the cursor right repeatedly to select the Active Control values **Off** or **On**. The picture settings are being optimized continuously. Those menu items can not be selected.
- ❹ Press the **OK** button or wait for the time out to dismiss the Active Control display.

Picture format

This menu item performs the same as the **FORMAT** button on the remote control. See Use of the remote control, p. 6.

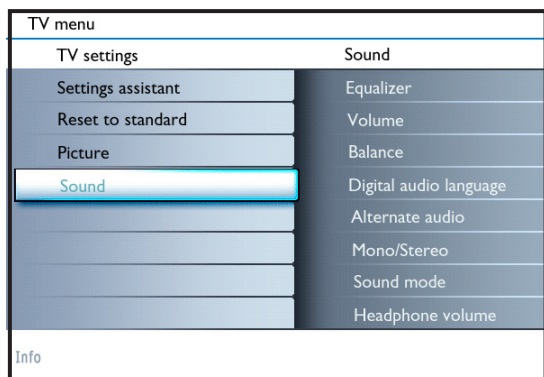

Sound menu

- 1 Select **Sound** in the TV Settings menu.
- 2 Press the cursor right to enter the sound menu.
- 3 Select the menu items with the cursor up/down and adjust the settings with the cursor left/right.
Remember, control settings are at normal mid-range levels when the bar scale is entered.

Equalizer

Allows you to change the frequency response of the sound to match your personal taste.

Volume

This will adjust the sound output level.

Balance

This will adjust the output of the right and left speakers to obtain the best stereo reproduction for your listening position.

Digital audio language *(only selectable with digital broadcast signals)*

This allows you to select your language preference in case of multilingual audio track programs if available with digital broadcast signal.

Note: The default language for the digital channels is the installed menu language.

Alternate audio *(only selectable with analog broadcast signals)*

This gives you the possibility to swap between the Main and Second audio Program (SAP) when it is available.

Mono/Stereo

This selects, per TV channel, Mono or Stereo sound when analog stereo broadcasts are available.

Sound mode

This selects the modes for stereo or surround sound reproduction dependent on the broadcast signals or signals from external inputs received.

Headphone volume

This controls the level of sound through the headphones.

AVL (Automatic Volume Leveler) *(only available with analog broadcast and non-Digital signals)*

This automatically reduces the volume differences between channels and programs, providing a more constant overall level. This will also reduce the dynamics of sound.

Delta volume

This allows you to correct for any permanent volume differences between TV channels or external sources.

Auto surround

Sometimes the broadcaster transmits special signals for Surround sound encoded programs. The TV automatically switches to the best surround sound mode when **Auto surround** is switched **On**.

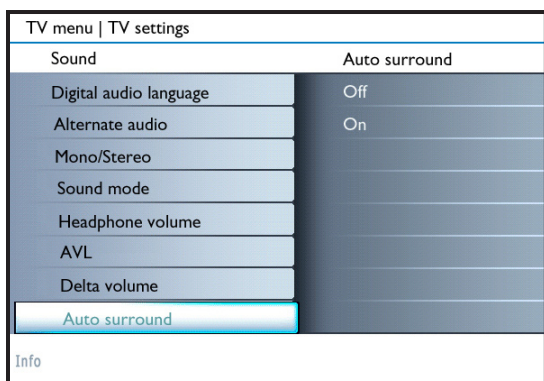

Manufactured under license from Dolby Laboratories. 'Dolby' and the double-D symbol are trademarks of Dolby Laboratories.

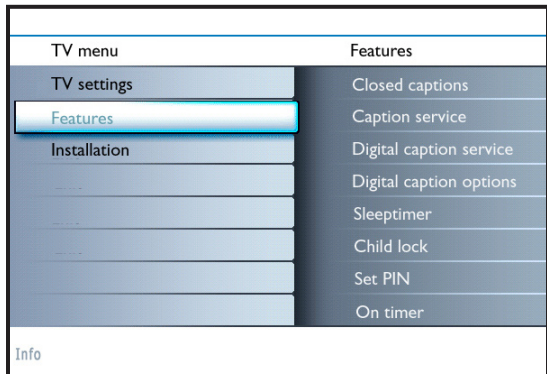

Note: The captions do not always use correct spelling and grammar. Not all TV programs and product commercials are made for broadcast with Closed Caption information included. Refer to your area's TV program listings for the TV channels and times of Closed Caption shows. The captioned programs are usually noted in the TV listings with service marks such as 'CC'.

Features menu

- ❶ Select **Features** in the TV menu.
- ❷ Press the cursor right to enter the features menu.
- ❸ Select the menu items with the cursor up/down and adjust the settings with the cursor left/right.

Closed captions

This displays the transmitted CC- or CS-text on the screen according to your chosen CC or CS service in the **caption service**. This text can either be permanently displayed (assuming that the service is available in the broadcast) or only when mute is active.

- ❶ Press the cursor right after having selected Closed captions.
- ❷ Select **On**, **Off** or **On during mute**.

Caption service

This allows you to select the Closed Captions service levels of analog broadcasting to be displayed.

Closed Captioning allows you to read the voice content of television programs on the TV screen. Designed to help the hearing impaired, this feature uses on-screen 'text boxes' to show dialogue and conversations while the TV program is in progress. Captions will appear on the screen during captioned broadcasts.

- ❶ Select **Captions service**.
- ❷ Press the cursor right.
- ❸ Select the desired Caption service:
 - **CC 1, 2, 3 or 4**
Dialogue (and descriptions) for the action on the captioned TV program shows on screen. Usually **CC 1** is the most used. **CC 2** may be used for alternate languages if they are being transmitted.
 - **T 1, 2, 3 or 4**
Often used for channel guide, schedules, bulletin board information for Closed Captions programs, news, weather informations or stock market reports. Not all Caption services are necessarily being used by a TV channel during the transmission of a Closed Caption program.
- ❹ See Closed Caption in the TV, **Features menu**, *see above*, to turn the Caption service **On** or **Off**.

Note: This television provides display of television closed captioning conforming with the EIA-608 standard and in accordance with Sections 15.119 of the FCC rules.

How to switch on.

To switch **ON** the closed caption feature, go to feature ==> closed caption and select 'On' or 'On during mute'.

If you connect your set-top box via HDMI or component video input, you cannot select closed caption through the TV. You can select closed caption through the set-top box only.

Digital caption service

This allows you to configure the way you choose to view the digital captioning. Select one of the digital service channels made available by the caption provider. There are 6 standard services. Service 1 is designated as the Primary Caption Service. This service contains the verbatim, or near-verbatim captions for the primary language being spoken in the accompanying program audio. Service 2 is designated as the Secondary Language Service. This service contains captions in a secondary language which are translations of the captions in the primary Caption Service. The other service subchannels are not pre-assigned. It is up to the discretion of the individual caption provider to utilize the remaining service channels.

TV menu	
Features	Digital caption options
Closed captions	Reset to default
Caption service	Size
Digital caption service	Style
Digital caption options	Text color
Sleeptimer	Text opacity
Child lock	Background color
Change PIN	Background opacity
On timer	Edge type
Info	

Digital caption options

This allows you to modify how digital captions are displayed on your TV. Select from the following options to change the visual characteristics of your TV's digital captioning.

- Reset to default**
 Select this option to reset the digital caption options back to the captions provider default settings.
 Press the **OK** button to confirm.
- Size**
 Select this option to select the size of caption display according to your own preference.
 Select **Default (Automatic)**, **Small**, **Standard** or **Large** and press the **OK** button to confirm.
- Style**
 Select this option to select the font style of caption display according to your own preference.
 Select **Default**, **Monospaced serif**, **Serif**, **Monospaced sans serif**, **Sans serif**, **Casual**, **Cursive** or **Small caps...**
- Text**
 Select this option to select the text color or the opacity of the text box of caption display according to your own preference.
 Select a color and one of the opacity options.
- Background**
 Select this option to select the character background color or one of the background opacity options of caption display according to your own preference.
 Select a color and one of the opacity options.
- Edge**
 Select this option to select the edge color or type options of caption display according to your own preference.
 Select a color and one of the type options.

Sleeptimer

This sets a time period after which the TV automatically turns to standby.

- 1 Select **Sleeptimer**.
- 2 Press the cursor right.
- 3 Select a value with the cursor up/down. The list will have values from **0** to **180 minutes**.
 When **0** is selected, the sleeptimer is turned off.
 You can always turn off your TV earlier or select another time set.

Child lock menu

TV menu	
Features	Child lock
Closed captions	Lock after
Caption service	Channel lock
Digital caption service	TV ratings lock
Digital caption options	Movie ratings lock
Sleeptimer	
Child lock	
Set PIN	
On timer	
Info	

Child lock menu

This menu can control special functions for the TV channels.

- 1 Select **Child lock** in the Features menu with the cursor up/down.
- 2 Press the cursor right to enter the child lock menu.
- 3 You will be summoned to enter your PIN (See below). Follow the instructions on screen.

Set/Change PIN

- 1 Select **Set** or **Change PIN** with the cursor down.
- 2 If no PIN-code exists yet, the menu item is set to **Set PIN**. Follow the instructions on screen.
 If a PIN-code has previously been entered, the menu item is set to **Change PIN**. Follow the instructions on screen.
 All number combinations from 0000 to 9999 are valid numbers.
- 3 The **Menu preferences menu** reappears with a message confirming that the PIN has been created.

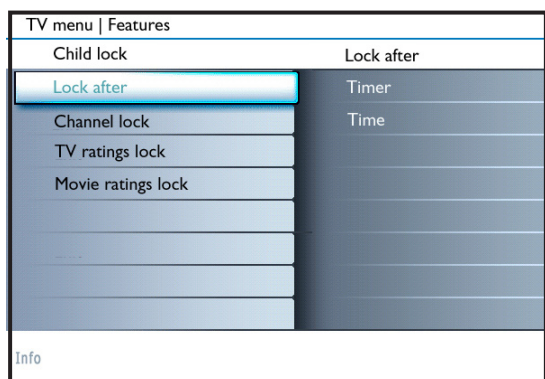

Lock after

Note: Lock after is only selectable if time is known. See Clock menu, p. 21.

This allows you to prevent the viewing of the channels after a selectable time delay. Locked channels can still be tuned, but the picture is blanked and the audio is muted.

- ❶ Press the cursor right and select **Timer** or **Time**.
- ❷ Select **Time/Timer** and press the cursor right. This allows you to set the time after which the lock is set.
- ❸ Select **AM** or **PM** to select the correct period of the day.
- ❹ Enter the time with the digit or the cursor buttons and press **OK** to confirm.

Channel lock

This allows you to completely lock a certain TV channel or external source. Select the channels or subchannels you want to lock and press **OK** to confirm.

TV ratings lock

Your TV is equipped with a V-chip. This allows you to control access to individual programs based on their movie and TV ratings. All settings apply to all AV inputs, except HDMI. The program content advisory data are sent by the broadcaster or program provider.

- ❶ Select **TV ratings lock** with the cursor down.
- ❷ Press the cursor right to enter the list.
- ❸ Select an age-based TV rating with the cursor up/down, and enter, if present, the list with content-based ratings with the cursor right, and select one content-based rating.
- ❹ Press **OK** to activate/de-activate the selected rating.
- ❺ Select another content-based rating if you like and press **OK** again.

You need only enter your PIN-code once while the menu is active.

You can lock/unlock any number of ratings on the list without re-entering your code.

Each ratings item has a box-graphic in front of it to indicate whether or not programs carrying that rating are currently locked:

- box with a 'X': all items in the contents-based list are locked as well;
- empty box: the item is unselected;
- box with a '/': some content-based ratings are selected/unselected.

When **All** has been selected, all items in the age-based and in the contents-based lists are locked.

If, while **All** is selected, any other item, either an age-based or content-based item, is unselected, then **All** is automatically unselected.

None is the selection for items that either have no rating information or have a rating of **None**. Both will be locked.

When an item on the age-based list is selected, all items below that item of the same group are locked as well.

When you select a content-based rating, all identical content-based ratings in the younger age-based categories are also selected.

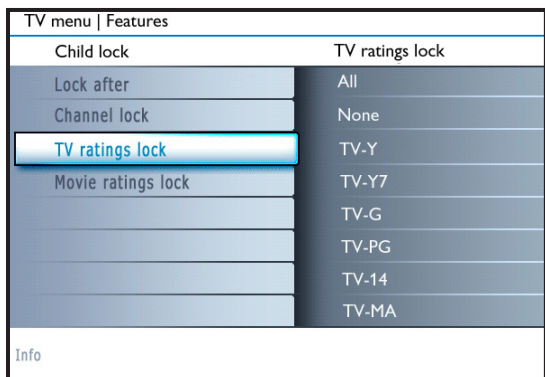

Age-based Rating	Content-based Rating
All	none
None	none
TV-Y	none
TV-Y7	(FV) Fantasy Violence
TV-G	none
TV-PG	(D) Dialog (L) Language (S) Sex (V) Violence
TV-14	(D) Dialog (L) Language (S) Sex (V) Violence
TV-MA	(L) Language (S) Sex (V) Violence

TV-Y appropriate for children of all ages with themes and elements suitable for children aged 2-6

TV-Y7 programs designed for children age 7 and older

TV-Y7-FV programs include fantasy violence more intense than other programs in the TV-Y7 category

TV-G programs suitable for all ages. These programs contain little or no violence, no strong language and little or no sexual dialogue or situations

TV-PG programs contain elements that some parents may find unsuitable for younger children and which may need parental guidance. The program may contain moderate violence, sexual dialogue and/or situations and some strong language.

TV-14 programs contain elements that may not be suitable for children under 14 years of age. These programs include one or more of the following: intense violence, intense sexual situations, suggestive dialogue and strong language.

TV-MA programs are designed to be viewed by adults and may be unsuitable for children under the age of 17. These programs may contain graphic violence, explicit sexual activity and/or crude or indecent language.

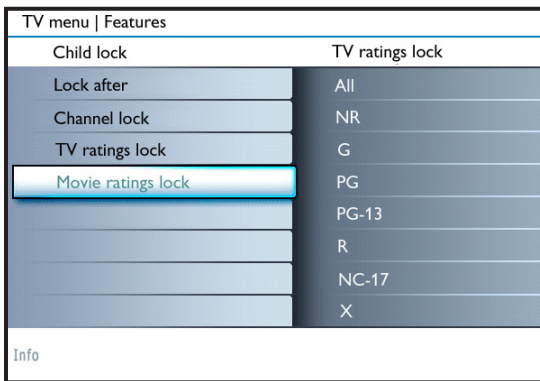

- NR** not rated
- G** movies with a mild content, suitable for all ages
- PG** movies for which parental guidance is recommended. They may contain a few racy or violent scenes or maybe some bad language
- PG-13** movies for which parental guidance may be recommended if under age 13
- R** restricted. The movies usually contain offensive sex or bad language and may be unsuitable for children under the age of 17. Parental guidance or permission needed.
- NC-17** even with parental permission, forbidden under age 17. More offensive sex, violence or bad language.
- X** movies which generally focus on sex, violence and/or bad language. Also known as pornography.

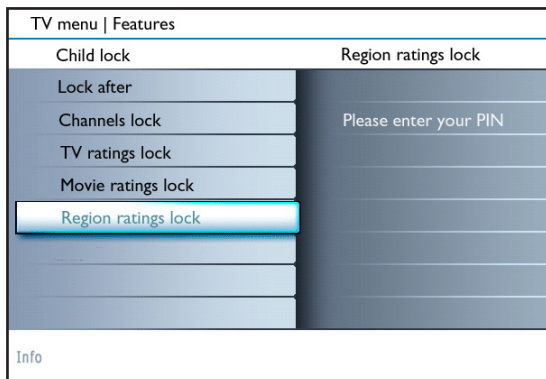

Movie ratings lock

This function allows you to control access to individual movies based on their MPAA ratings (Motion Picture Association of America).

- 1 Select **Movie ratings lock** with the cursor down.
- 2 Press the cursor right to enter the list.
- 3 Select a movie rating with the cursor up/down.
- 4 Press **OK** to activate/de-activate the selected rating.

Each rating item has a box-graphic in front of it to indicate whether or not programs carrying that rating are currently locked:

- box with a 'X': movies with this rating are locked;
- empty box: movies with this rating are unlocked.

When **All** has been selected, all items on the movie ratings list become selected. (All movies are locked.)

If, while **All** is selected, any other item is unselected, then **All** is automatically unselected.

When **NR** has been selected, no other item is selected.

When any other item has been selected, all ratings below are selected as well, thus all movies with those ratings will be locked.

Region ratings lock

This function allows you to control access to digital programs based on downloaded Region Ratings.

- 1 Select **Region ratings lock** with the cursor down.
- 2 Press the cursor right to enter the list.
- 3 Select a Region rating with the cursor up/down, and enter, if present, the list with content-based ratings with the cursor right, and select one content-based rating.
- 4 Press **OK** to activate/de-activate the selected rating.
- 5 Select another content-based rating if you like and press **OK** again.

Each ratings item has a box-graphic in front of it to indicate whether or not programs carrying that rating are currently locked:

- box with a 'X': all items in the contents-based list are locked as well;
- empty box: the item is unselected;
- box with a '/': some content-based ratings are selected/unselected.

Set/Change PIN

- 1 Select **Set** or **Change PIN** with the cursor down.
- 2 If no PIN-code exists yet, the menu item is set to **Set PIN**. Follow the instructions on screen.
If a PIN-code has previously been entered, the menu item is set to **Change PIN**. Follow the instructions on screen.
All number combinations from 0000 to 9999 are valid numbers.
- 3 The **Menu preferences menu** reappears with a message confirming that the PIN has been created.

Note: - From now on, every week, your TV will automatically switch to the selected channel, on the selected day, at the selected time, until the On timer function is switched off again.
- Only one On timer can be set.

On timer (applicable for off-air channels only)

From standby, this automatically switches the TV to the specified channel number, at a specified time.

- ❶ Select **On timer**.
- ❷ Press the cursor right to enter the On timer menu.
- ❸ Select **Timer** and press the cursor right.
- ❹ Select **On**.
- ❺ Select **Channel** and then the TV channel you want your TV to switch to on a selected time and day.
- ❻ Select **Day** and then a day of the week or select **Daily**.
- ❼ Select **Time** and enter the time with the digit keys or with the cursor up/down.
- ❽ Press the **OK** key to activate.
- ❾ Press the cursor left to return to the Features menu or press the **MENU** key to switch off the menu.

Installation menu

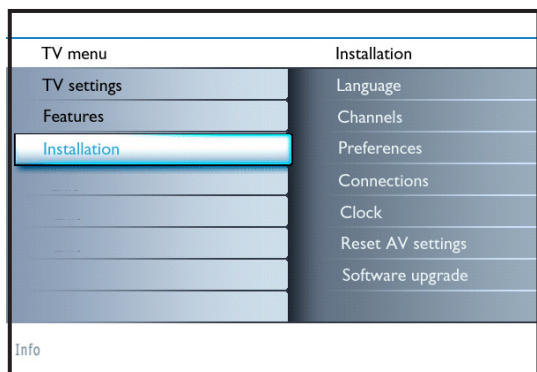

Select the menu language

- ❶ Press the **MENU** button on the remote control.
- ❷ Use the cursor down to select **Installation** in the TV menu.
- ❸ Use the cursor right to enter the Installation menu.
- ❹ Select **Language** and enter the list of available languages with the cursor right.
- ❺ Select your language with the cursor up/down and press the **OK** button to confirm your selection.
- ❻ Proceed with the Installation menu.

Channel menu

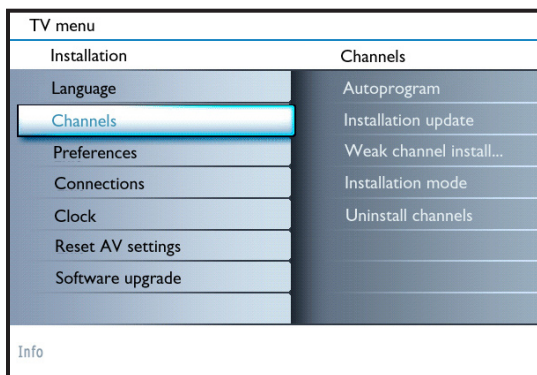

Store TV channels

- ❶ Select **Channels** in the Installation menu.
- ❷ Use the cursor right to enter the Channels menu.
- ❸ Select **Autoprogram** in the Channels menu.
- ❹ Use the cursor right to enter the Autoprogram menu.
- ❺ Press the **OK** button.
- ❻ Select **Cable** or **Antenna** in the Installation mode.

When **Antenna** is selected, the TV will detect antenna signals and will search for antenna TV (NTSC and ATSC) channels available in your local area.

When **Cable** is selected, the TV will detect cable company supplied signals and will search for cable TV (NTSC, ATSC, QAM modulated) channels available in your area.

Make sure that registration with your cable TV provider and connection of equipment are completed.

- ❼ Press the green button "**Next**" on the remote control.
Note: All channels must be unlocked in order to autoprogram. If requested, enter your PIN code to unlock all channels. See Set/Change PIN, p. 17.
- ❽ Press the green button "**Start**" to start autoprogramming.
The menu screen disappears and the progress of autoprogramming is displayed. The progress bar indicates the number of analog and digital TV channels found.

When Autoprogramming is complete, a message appears confirming the completion. Press the red button "Finish" and the TV returns to the Installation menu.

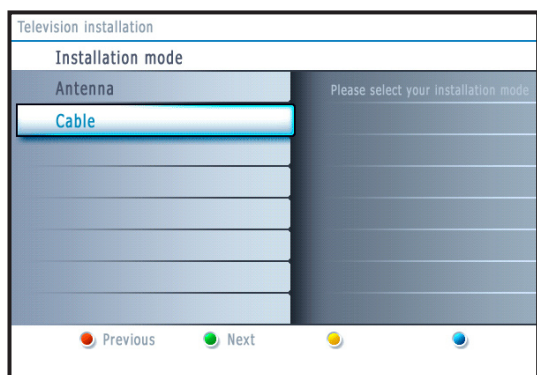

Notes:

- When you have locked TV channels while initiating autoprogram, a message appears asking to enter your PIN code in order to complete autoprogramming.
- When interrupted, the updated channel information is retained as well as the not yet updated old channel information.
- Background autoprogramming occurs only when the TV is tuned on.
- Channel information of an ATSC channel is updated only for the ATSC channel currently tuned.
- If an NTSC channel is tuned, then in Background Autoprogramming the TV shall scan all the possible ATSC frequencies and update information.
- Weak channel installation : This allows you to manually tune weak ATSC channels in order to adjust the antenna and thus optimize signal quality for that channel. (See Installation menu, Weak channel installation, p. 19.)
- Once you have searched for the available Antenna as well as the Cable TV channels, they are stored in the memory.

Note: Digital Channel selection delay

Due to the tuning complexity of subchannel digital programming, the time to select and view a digital channel may take slightly longer than what the viewer is normally accustomed to (as compared to analog channel programs).

Digital channel broadcasts contain program and system data information that must be processed before the channel selection can be displayed.

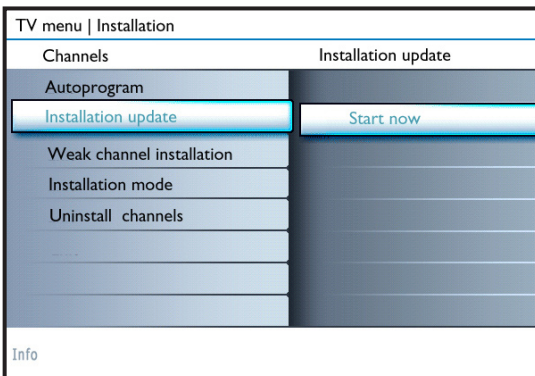

Channel tuning

Available channels:

- Cable (analog NTSC or digital QAM): max. from 1 to 125
- Antenna (analog NTSC or digital ATSC): max. from 2 to 69

If a tuned channel is not yet in the master channel map, the TV will attempt to tune the channel and it will be added to the map.

If the channel is not acquired, a message will appear that the channel is not available.

When you tune an audio-only digital subchannel, a display appears with the message **Audio only**.

Note: Subchannel selections

- The new standards employed with digital broadcasting make it possible to receive multiple program channels under a single major channel number which can be selected by pressing the digit remote control direct-access channel number entry.
- The number of channels shown at installation includes paid channels but you may not be able to see all of them unless you sign up with cable TV operators.

Important:

After the installation of the TV channels has been done, always make a selection in the Installation menu between Antenna or Cable whether you want to watch Antenna TV channels or Cable TV channels.

If you make use of a signal splitter do not forget to put the switch in the corresponding position.

Installation update (only with Digital TV broadcasting)

This allows you to automatically tune to and update all available digital channels.

- Notes:
- this will not reinstall uninstalled channels;
 - digital channels that are not encountered any longer will be removed;
 - new channels found will not be added to any favorite list;
 - already installed channels will not be renumbered.

Weak channel installation

This enables you to do a weak ATSC digital channel installation. This is only available for TV channels installed via an antenna connection (see p. 4).

- 1 If a certain channel you expect to see is not tuned or is weak, you can install it manually. Call your local broadcasting station to know what channel its being transmitted on.
- 2 Select that channel in the displayed list of TV channels (in the antenna mode).
- 3 The signal strength is displayed and updated continuously as you rotate the antenna.

Installation mode

This allows you to select the already stored terrestrial or cable TV channels. Choose for Antenna or Cable whether these signals are present.

Uninstall channels

This allows you to uninstall a stored channel so that it is no longer possible to tune to. This also allows you to reinstall an earlier uninstalled channel.

- 1 Select the channel you want to uninstall.
- 2 Press the green color button to uninstall the selected channel. The uninstalled channel is indicated in the list by an icon in front of the uninstalled channel.
- 3 Press the green color button again to reinstall the uninstalled channel.

Note : Uninstalled channels are not reinstalled during an installation update.

Preferences menu

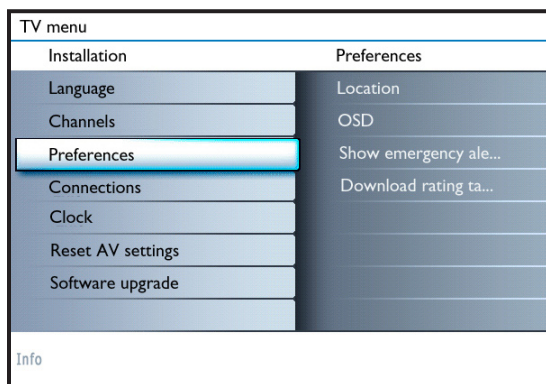

Note: Emergency Alert Signalling is not possible:
 - when content browsing;
 - with analogue video sources.

Notes:
 - You always have the possibility to remove the message from the screen.
 - The message display will overlap whatever menu element or other message is on the screen.

Preferences

- 1 Press the **MENU** button.
- 2 Select **Installation** with the cursor down and press the cursor right to select the **Preferences** menu.

Location

This allows you to select the location of your TV. If you choose for Shop it will result in fixed settings of picture and sound. The location Home will give full flexibility to change any predefined settings for picture and sound.

OSD

- 1 Select **OSD**.
- 2 Press the cursor right to select **Normal** or **Minimum**.
Normal to activate the continuous display of the channel number (for max. 10 minutes) and extended display of TV channel and program information on screen. E.g. information on the main or auxiliary program, input signal quality of connected accessory devices, the display format, sound mode, availability of Closed Caption service, the audio language, the rating, sleeptimer setup.
Minimum to activate the display of reduced channel information.

Note: When Closed Captions is switched on, continuous display of the channel number and clock is not possible. Volume indication bar will not be visible.

Show emergency alerts (EAS)

This allows you to select the alert priority level of the information disseminated by the cable operator. The standard SCTE18 defines an Emergency Alert signalling method for use by cable TV systems to signal emergencies to digital devices such as digital set-top boxes, digital TVs and digital VCRs.

The Emergency alert signalling scheme defined in the standard allows a cable operator to disseminate emergency alert information related to state and local-level emergencies and warnings in a cost-effective and efficient way, while minimizing disruption of programming.

An Emergency alert message will have one of the following priorities: **Low**, **Medium**, **High** or **Maximum**.

The Emergency alert message with priority **High** or **Maximum** will always be presented. **Low** or **Medium** will be present or ignored depending on the selected setting.

Important: When the TV clock is undefined (See Clock, p. 21), the Emergency Alerts will be ignored.

The Emergency Alert message display will contain following information:

- The Emergency Alert text
- The start time + date
- The end time + date.

- 1 Select **Show Emergency Alerts** in the Menu preferences menu.
- 2 Press the cursor right and select one of the Emergency alerts options:
 - Always, when you always want the Emergency alert messages to be displayed when available;
 - Skip low priority, when you want the messages with low level to be ignored;
 - Skip low/medium priority, when you only want the messages with high priority to be displayed.

Important: If you have forgotten your PIN!

- ❶ Select **Change PIN** in the Menu preferences menu and press the cursor right.
- ❷ Press the cursor right to enter the overriding PIN code **0-7-1-1**.
- ❸ Press the cursor again and enter a new personal 4-digit PIN code. The previous code is erased and the new PIN-code is stored.

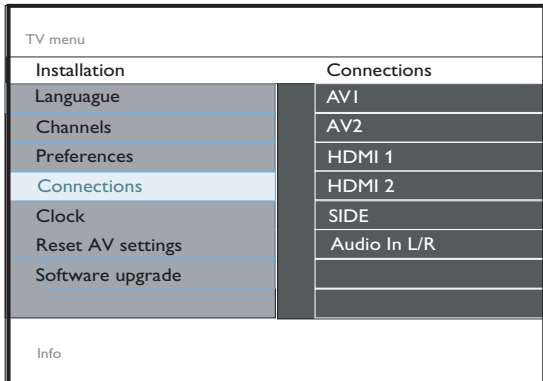

- Note: - Adjusting the clock is necessary for the correct working of Lock after (See Child lock menu, p. 16) features.
- Closed captioning will not be displayed when the clock is being displayed. Press the clock key again to switch off the clock if you want to see closed caption.

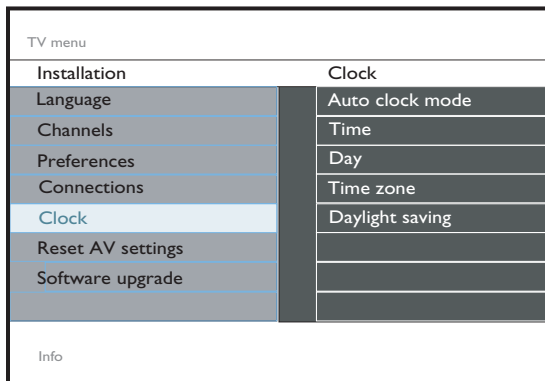

Most of the TV channels do not transmit clock information. There are a few cable channels who do but they are at the end of the channel ring. There is no clock transmission in antenna channels. In such cases, either clock extraction takes a long time, or there is no clock.

Download rating table

This allows you to add region ratings lock options next to your current ones.

- ❶ Select **Download rating table** with the cursor down.
- ❷ Press the cursor right to enter the list. You are asked to enter your code. (see page 17). If the code is correct, you can choose to on/off to download the rating table.
- ❸ Select on/off to download the rating table.
- ❹ Press **OK** to activate/de-activate the selection.

Note: - Before activating, please ensure regional ratings are broadcasted.

Connections

This menu allows you to name/label the accessory devices you have connected to the external inputs/outputs.

- ❶ Select **Connections** in the Installation menu.
- ❷ Press the cursor right to enter the list of types of devices connected to the selected input.
- ❸ Select the accessory device with the cursor up/down.

When you select **AV1, AV2, HDMI 1, HDMI 2, Side** or **Audio in L/R**, a list appears allowing you to identify which type of accessory device is attached to this input.

Note : If the accessory device has DVI output only, use a DVI to HDMI adapter cable to connect to the HDMI connector. You need to also connect the audio cable to **L** and **R AUDIO** jacks. Next, go to **Menu => TV menu => Installation => Connections => Audio in L/R => AV1**.

Clock

This allows you to use your TV as a clock.

Auto clock mode

- ❶ Select **Clock** in the TV menu.
- ❷ Press the cursor right to select the **Auto clock mode**.
- ❸ Press the cursor right to instruct the TV to get the time automatically or manually.

Auto clock channel (only available when Auto clock mode is set to Automatic)

With the cursor buttons, select the channel number where time can be found by the TV. Typically time can be found on PBS as well as some other channels.

Note: If Manual has been selected in the Auto clock mode, the Auto clock channel menu item can not be selected.

Time - Day (only available when Auto clock mode is set to Manual)

With the cursor buttons, select and enter the correct time and day. If **Auto clock mode Manual** has been selected, and no clock search has been done, the system will keep the entered time and day.

Time zone (only available when Auto clock mode is set to Automatic)

This function allows you to select your local time zone. Broadcasted time information will correct the clock display for your local time.

- ❶ Select **Time zone** with the cursor down.
- ❷ Press the cursor right to select your local time zone.

Daylight saving (only available when Auto clock mode is set to Automatic)

Daylight saving time is automatically set by specially broadcasted signals. This menu item allows you to disable the automatic setting of daylight saving time. This is useful if you live in an area or state where daylight saving is not applied, but you receive channels from other areas where daylight saving signals are broadcasted.

- ❶ Select **Daylight saving** with the cursor down.
- ❷ Press the cursor right to select **Automatic** for automatic clock correction for daylight saving time, based on specially broadcasted signals.
- ❸ Select **Off** to disable automatic clock correction based on the specially broadcasted signals.

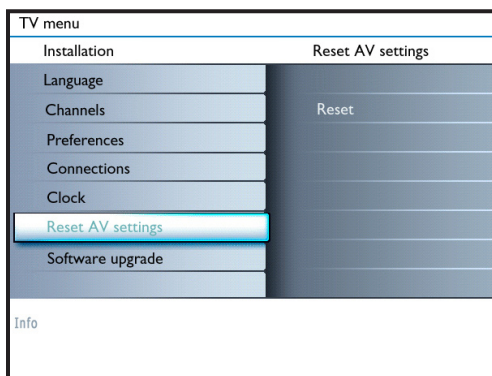

Reset AV settings

This function allows you to reset most of the picture and sound settings to their predefined factory states.

- ❶ Select **Reset AV settings** with the cursor down.
- ❷ Press the cursor right.
- ❸ Press the **OK** button to erase settings and reset them to their default values.

Software upgrade

This menu allows you to upgrade your TV software using a USB device.

USB upgrade

It is possible to initiate an upgrade procedure from a USB portable memory. The memory device must be filled with the appropriate upgrade image (and structure) which can be found on the www.philips.com/usasupport website. How to upload a new software version on your portable memory device, see Annex 1, p. 31.

Connect Accessory Devices

1a Set Top Box to TV

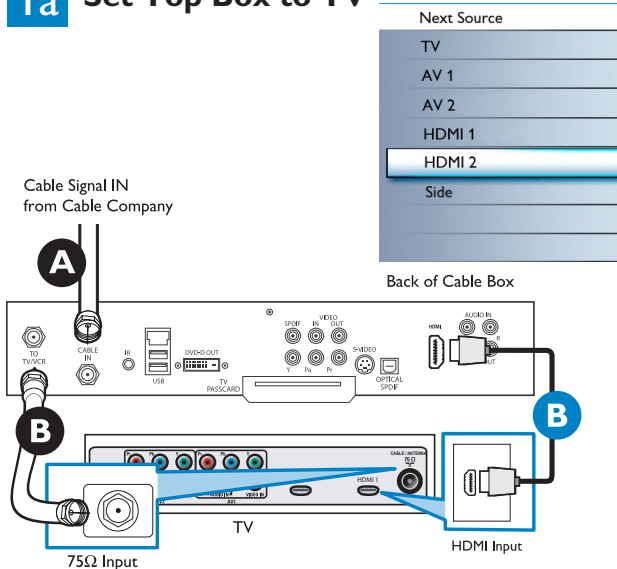

Using HDMI

- ❶ Connect RF cable from wall to input at back of the cable box. Set output switch on set-top box to CH 3 or 4 and tune TV to same channel.
In some cases, cable box will automatically tune to channel 3 or 4. Just change channels until picture appears.
- ❷ Connect cable box to TV using HDMI cable.
*Note : If the accessory device has DVI output only, use a DVI to HDMI adapter cable to connect to the HDMI connector. You need to also connect the audio cable to **L** and **R AUDIO** jacks. Next, go to **Menu => TV menu => Installation => Connections => Audio in L/R => AV1.***

Using RF Cable

- ❶ Connect RF cable from wall to input at the back of the cable box.
- ❷ Use second RF to connect the cable box to the TV's antenna input.
This connection gives mono sound. For stereo sound use also composite audio/video connection (Refer to panel 3).

1b Set-Top Box to TV

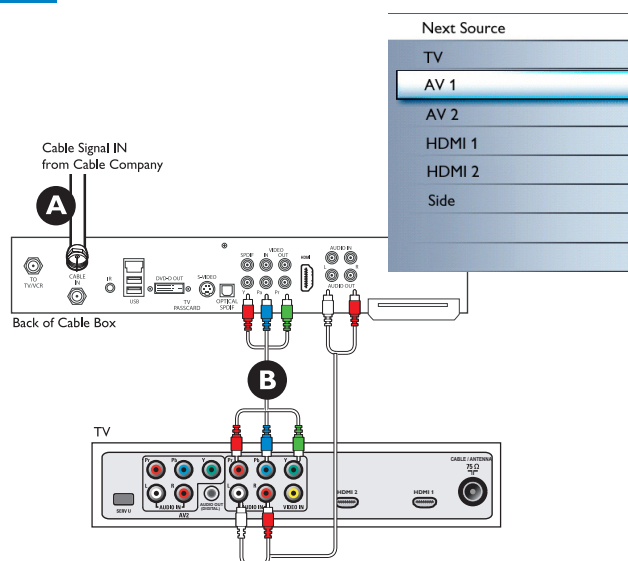

Using Component Video Input

- ❶ Connect Component Video cable to input at back of the cable box.
- ❷ Turn on TV and DVD Player/DVD recorder. Press CH+ or CH- on remote control to tune to the video supplied by AV2.

Insert a prerecorded DVD into DVD player/DVD recorder and press PLAY to verify correct connection.

2a Progressive Scan DVD Player or DVD Recorder to TV

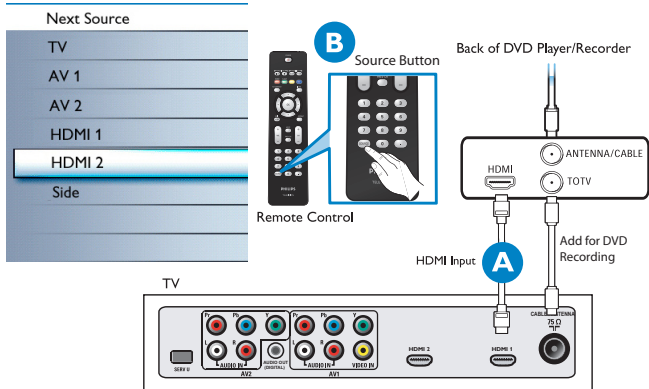

Using HDMI

- Connect DVD player/DVD recorder to the TV using HDMI cable.
- Turn on TV and DVD Player/DVD recorder. Press CH+ or CH- on remote control to tune to the video supplied by HDMI.

Insert a prerecorded DVD into DVD player/DVD recorder and press PLAY to verify correct connection.

2b Progressive Scan DVD Player/Recorder to TV

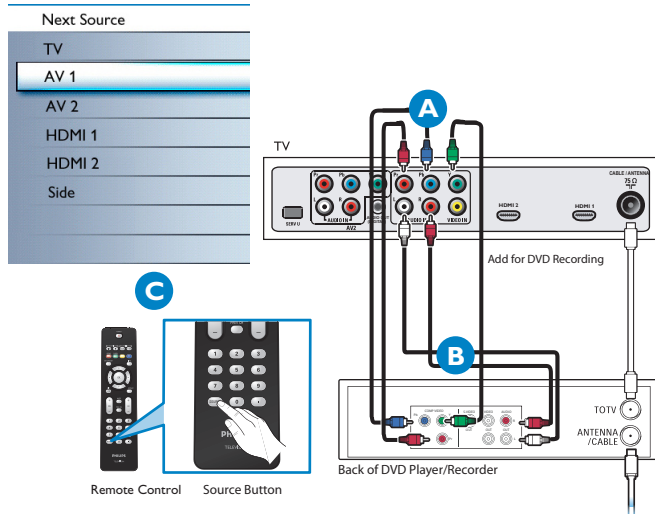

Using Component Video Input (YPbPr)

- Insert Component Video connectors into their corresponding jacks on both DVD player/DVD recorder and TV (Y, Pb and Pr).
- Connect red/white audio cables into the audio output jacks on DVD player/DVD recorder and audio AV inputs on TV.
- Turn on TV and DVD Player/DVD recorder. Press AV on remote control until the connected source appears on TV screen.

Insert a pre-recorded DVD into DVD player/DVD recorder and press PLAY to verify correct connection.

3 DVD Player/DVD Recorder/VCR to TV

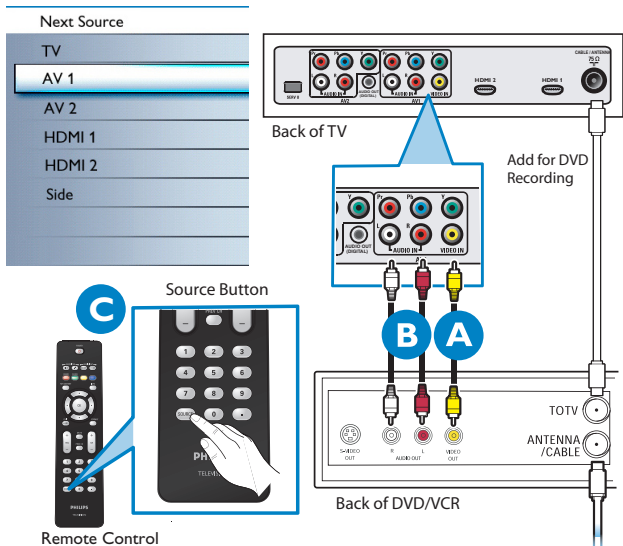

Using composite audio-video

- Connect composite video cable to Video input on back of TV and Video output on the back of DVD/VCR player or recorder.
- Connect audio cables (red/white) to audio AV inputs on back of TV and Audio outputs on back of DVD/VCR player or recorder.
- Turn on TV and DVD/VCR player or recorder. Press **SOURCE** button on the remote control until AV1 or AV2 appears on TV screen.

Insert pre-recorded videotape/DVD into DVD/VCR player or recorder and press PLAY to verify correct connection.

Next, go to **Menu** => **TV menu** => **Installation** => **Connections** => **Audio in L/R** => **AV1**.

4 Video Camera/Games Console to TV

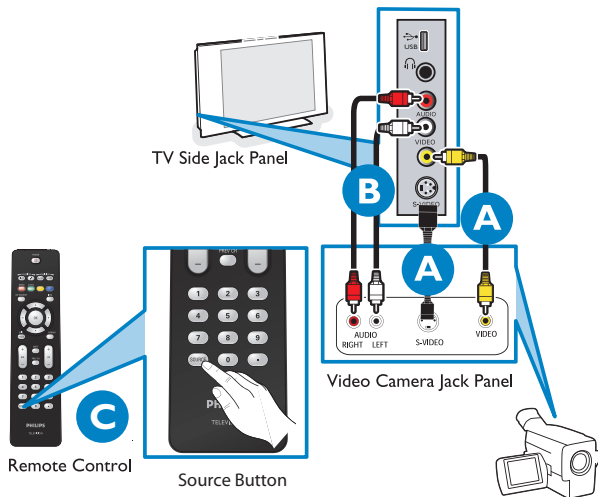

Using Composite Audio/Video Input

- A** Connect the video cable (yellow) from the video output on camera (or other device) to the video input (yellow) located on the side of TV.
OR
Connect S-video cable to S-video input on side of TV and to the output.
- B** Connect audio cables (red/white) from audio outputs on device to audio inputs (red/white) on the side of the TV.
- C** *Tip: For mono devices, connect only white audio cable from device's audio output to white audio input on the side of TV.*
Turn on the TV and the device. Press the **SOURCE** button on the remote control until **SIDE** appears on TV screen.
Press **PLAY** on the device to verify connection.
Note: Interference will occur when S-video and Composite audio/video are connected.

Side connections - USB/Headphone



Headphone

- 1 Insert the plug into the headphone socket as shown.
- 2 Press the **MUTE** button on the remote control to switch off the internal loudspeakers of the TV.
The headphone impedance must be between 8 and 4000 Ohm. The headphone socket has a 3.5 mm jack.
In the Sound menu select **Headphone volume** to adjust the headphone volume.

Viewing content from a USB device

Inserting a USB device

Note: USB devices are not supplied with this TV.

Insert a USB device in the **USB** connector at the side of the TV. When a USB device is inserted, the Multimedia browser menu is displayed automatically, see further.

Removing the USB device

- 1 First switch off the menu. To do so, navigate to the Multimedia browser menu and press the **MENU** button to exit the menu.
- 2 Remove the USB device.

Digital Surround receiver

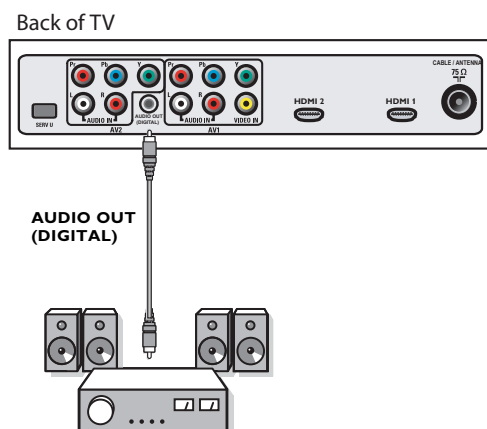

Connect a Digital MultiChannel Surround receiver to the **AUDIO OUT (DIGITAL)** connector at the bottom of the TV.

The TV can output Digital audio via the **AUDIO OUT (DIGITAL)** connector to an external amplifier or receiver.

If your amplifier or receiver has a matching connector for Digital Audio In, you can connect it with a single cable to the TV's **AUDIO OUT (DIGITAL)**.

See Connect Accessory Devices, p. 22.

Multimedia browser

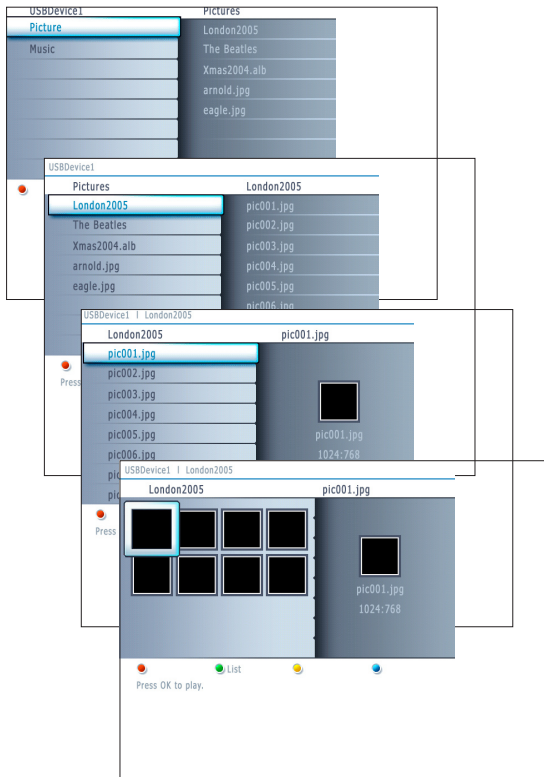
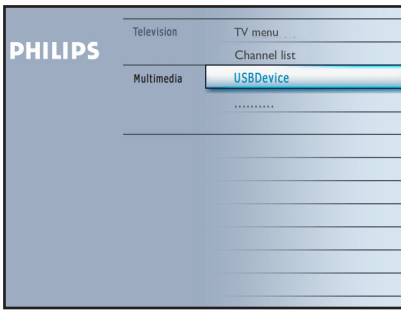

Notes:

- **Your TV supports slide shows with background music.** See Annex 2, p. 33.
- The playback will continue to play even if temporarily switched to browser screens. The audio will be stopped when another song starts playing, or when the end has been reached.
- Progressive JPEG files are not supported.
- The length of the files should not exceed 128 characters.
- Do not use a dot "." in folder naming.
- More technical remarks can be found in Annex 3, p. 35.

Following icons may appear:

- folder
- pictures
- music
- self made playlist/album

Multimedia browser lets you display pictures or play audio files stored on a USB device.

The Multimedia browser application is invoked from the main menu (press the **MENU** button) by selecting the USB device and pressing the cursor right.

Notes:

- Following file formats can be reproduced:
 - For pictures: JPEG
 - For audio: MP3, MP3 Pro
- Only FAT/DOS-formatted memory devices are supported.
- If your digital camera is not supported, make sure your camera is switched on and verify if its configuration settings are correct (see the manual of your camera).
- Philips cannot be responsible if your USB device is not supported.

Multimedia Browser menu

- 1 Insert a USB device.
- 2 Select the USB device under Multimedia with the cursor up/down. The Multimedia browser will allow the user to browse content stored on the inserted USB device. Press the cursor right.
- 3 The 2-panel browser will be shown with the left panel containing the content types (Music, Picture). The right panel will display the content that is available of the selected content type.
- 4 Press the cursor up/down to select a content type and press the cursor right to enter the content.
- 5 Press the cursor up/down to select a file or a directory.

Note: Press the green color button to display all the image files in the current directory as thumbnails when browsing pictures. Press the green button again to display the image files in a list.
- 6 In case a **file** is selected, press the **OK** button to display a picture file or to play an audio file. In case a directory, album or playlist is selected, press the cursor right to enter the content or press the **OK** button to start a slide show or a playback of the files present in the directory, album or playlist.
- 7 Press the cursor left to keep music playing and switch back to the Multimedia menu.
- 8 Press one of the color buttons on the remote control to perform the corresponding function mentioned at the bottom of the screen. The blue color button can be used to let the color re-appear.
- 9 To stop playing content, press the **MENU** button on the remote control.

- Note : - It may work with certain memory devices but not with most camera devices.
 - USB devices are not supplied with this for TV. Use a USB device which is less than 25mm wide for best connection.

Function buttons at the bottom of the screen

- Details** to display a description of the selected file or directory;
- Transitions** to select if a transition during a slide show should be applied;
- Slide time** to select the duration a picture will be displayed in a slide show;
- Rotate** to rotate a picture;
- Repeat one/all** to repeat the playback of a music file;
- Shuffle** to shuffle music collections in a random way;

Record with your recorder

Record a TV program

You can record a TV program using your recorders tuner without affecting your TV.

- 1 Select the channel number on your recorder.
- 2 Set your recorder to record.
See the handbook for your recorder.

Switching channel numbers on your TV does not disturb recording !

To select connected devices

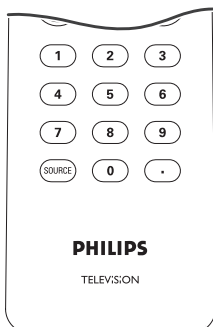

- 1 Press the **SOURCE** button repeatedly or select **Connections** in the Settings menu (see p. 21) to select **AV1, AV2, HDMI 1, HDMI 2, Side or TV**, according to where you connected your devices.
- 2 Press the cursor up/down.
- 3 Press **OK**.

Regulatory Notices - Federal Communications Commission Notice

This equipment has been tested and found to comply with the limits for a Class B digital device, pursuant to part 15 of the FCC Rules. These limits are designed to provide reasonable protection against harmful interference in a residential installation. This equipment generates, uses, and can radiate radio frequency energy and, if not installed and used in accordance with the instructions, may cause harmful interference to radio communications.

However, there is no guarantee that interference will not occur in a particular installation. If this equipment does cause harmful interference to radio or television reception, which can be determined by turning the equipment off and on, the user is encouraged to try to correct the interference by one or more of the following measures:

Reorient or relocate the receiving antenna.

Increase the separation between the equipment and the receiver.

Connect the equipment into an outlet on a circuit different from that to which the receiver is connected.

Consult the dealer or an experienced radio or television technician for help.

Modifications -

The FCC requires the user to be notified that any changes or modifications made to this device that are not expressly approved by Philips Consumer Electronics may void the user's authority to operate the equipment.

Cables -

Connections to this device must be made with shielded cables with metallic RFI/EMI connector hoods to maintain compliance with FCC Rules and Regulations.

Canadian notice -

This Class B digital apparatus meets all requirements of the Canadian Interference-Causing Equipment Regulations.

Avis Canadien -

Cet appareil numérique de la classe B respecte toutes les exigences du Règlement sur le matériel brouilleur du Canada.



Kensington Security Slot (if present)

Your TV is equipped with a Kensington Security Slot, to prevent it from getting stolen.

An anti-theft Kensington lock has to be purchased separately.

The Kensington lock is a plastic-coated steel cable with a lock. One end has to be fixed to the opening of the TV and locked with a special key. The other end is attached to a fixed point.

® Kensington and MicroSaver are registered US trademarks of ACCO World Corporation with issued registrations and pending applications in other countries throughout the world. All other registered and unregistered trademarks are the property of their respective owners.

Troubleshooting Tips

Symptoms	Possible Causes	What you should do
No display on screen	<ul style="list-style-type: none"> Faulty power supply TV's Power not turned on TV go to standby after 10min without video. Faulty aerial and cable Wrong source selected. 	<ul style="list-style-type: none"> Check whether power cord is properly connected into the mains socket. If there is still no power, disconnect plug. Wait for 60 seconds and re-insert plug. Turn on TV again. Press the POWER key on the TV and wait for 10-15sec. Press the POWER key on the remote control. Check whether euroconnector cables or aerial sockets are properly connected. Check whether the source is correctly selected. Press Source button to enter Source list and select the correct source.
Poor reception (snowish picture and noise)	<ul style="list-style-type: none"> Faulty antenna connection Weak transmission 	<ul style="list-style-type: none"> Faulty antenna connection
Reddish picture in AV1/2	<ul style="list-style-type: none"> Wrong setting of DVD player 	<ul style="list-style-type: none"> Set the DVD player to the correct output video format.
No sound	<ul style="list-style-type: none"> Zero volume level Sound muted Wrong audio selection 	<ul style="list-style-type: none"> Try increasing volume. (You will not see the volume indication if OSD set to minimum) Check that the sound is not muted. Aim remote control directly at sensor on front of TV. Press MENU => TV menu => Installation => Connections => Audio in L/R => select AV1
Sound interference	<ul style="list-style-type: none"> Electrical appliances interference 	<ul style="list-style-type: none"> Try turning off any electrical appliances, for example, hairdryer, vacuum cleaner that are in use.
Interference lines seen on S-Video	<ul style="list-style-type: none"> Wrong detection of signal 	<ul style="list-style-type: none"> Check whether power cord is properly connected Press the +CH- key on the remote control and do a channel up followed by a channel down. Make sure no composite video are connected on the same AV input.
Intermittent or flickering picture on in HDMI	<ul style="list-style-type: none"> * HDCP (see glossary) authentication failed 	<ul style="list-style-type: none"> Noise is displayed if the connected digital equipment's (DVD player or set-up box) *HDCP authentication failed. Check user manual for the digital equipment you are connecting. Use a HDMI compliant cable. Try unplugging the HDMI cable and replugging it back.
Black bar on top and bottom of screen in PC mode	<ul style="list-style-type: none"> PC refresh rate too high 	<ul style="list-style-type: none"> Change PC refresh rate to 60 Hz.
Picture position adjustment	<ul style="list-style-type: none"> Slight differences in output signals from different brands and types of HD sources 	<ul style="list-style-type: none"> When displaying a High Definition signal from the YPbPr inputs or HDMI input, if necessary, you can adjust the picture position to the center of the screen with the cursor left/right or up/down buttons on the remote control.
Occasional appearance black spots on the screen (LCD TV only)	<ul style="list-style-type: none"> Characteristic of liquid crystal panel 	<ul style="list-style-type: none"> This symptom is not a problem. The liquid crystal panel is built with very high and precision technology giving you the fine picture details. Occasionally, a few non-active pixels may appear on the screen as a fixed point of red, blue, green or black. Note that this does not affect the performance of the set.
PC modes do not work	<ul style="list-style-type: none"> Wrong connections Wrong source selected. Wrong display resolution 	<ul style="list-style-type: none"> Check whether connections are correct. Check whether the source is correctly selected. Press Source button to enter Source list and select the correct source. Check whether you have configured the computer on a compatible display resolution.
TV not responding to Remote control	<ul style="list-style-type: none"> Wrong polarity of batteries Flat batteries. 	<ul style="list-style-type: none"> Check if the remote control is in TV mode. Check if the blue led blink when using remote control. Check polarity of the batteries. Try changing the batteries.
Unable to understand the language on screen to operate set	<ul style="list-style-type: none"> Wrong language selected accidentally 	<ul style="list-style-type: none"> Press the MENU key to exit menu from screen. Press the MENU key to enter main menu and press OK key. Use the cursor down to select the third item on the main menu. Press the cursor right key twice to enter into the next menu level and the cursor up and down key to select correct language. Press the OK key confirm selection.
No sound from PC		<ul style="list-style-type: none"> Check AUDIO IN connections.
AVL not working	<ul style="list-style-type: none"> AVL does not work when the input signal is AC3. AVL does not work when the DVD disk is Dolby Digital encoded. 	<ul style="list-style-type: none"> Nothing

If your problem is not solved

Turn your TV off and then on again once.

Never attempt to repair a defective TV yourself.

Check with your dealer or call a TV technician.

Telephone number Philips Customer

Care Center: 1-888-PHILIPS (744-5477)

Please, have the Model and Product number which you can find at the back of your television set ready, before calling.

Tips

Care of the screen

Do not touch, push or rub or strike the screen with anything hard as this may scratch, mar or damage the screen permanently. Do not rub the screen with chemically treated cloths.

Do not touch the surface with bare hands or greasy cloth (some cosmetics are detrimental to the screen). Unplug the TV before cleaning the screen.

When the surface becomes dusty, please wipe gently with absorbent cotton or other soft materials like chamois soaks.

Do not use acetone, toluene and alcohol because they cause chemical damage. Do not use liquid cleaners or aerosol cleaners. Wipe off saliva or water drops as soon as possible. Their long time contact with the screen causes deformations and color fading.

Plasma display characteristics

This Plasma display is designed to be used at altitudes up to 6562 ft above sea level (and/or local air pressure equal or above 800 hPa). Operating this set at higher altitude (lower air pressure) is possible. However, at high altitudes (or local air pressure equal or below 800 hPa) the picture on this display may become unstable and picture performance can deteriorate. In addition, the plasma display may produce a humming sound in these conditions.

These possible adverse effects relate to the altitude and are common of all plasma displays. Once the set is brought below approx 6562 ft (and/or local air pressure equal or above 800 hPa) its function will most likely return to normal.

Note: Transportation at high altitudes has no negative effect on the set or picture performance.

How to dispose of batteries?

The batteries supplied do not contain the heavy metals mercury and cadmium. Nevertheless in many areas batteries may not be disposed of with your household waste. Please ensure you dispose of batteries according to local regulations.

Examples of stationary images (this is not an all-inclusive list, you may encounter others in your viewing):

- **TV and DVD menus:** listings of DVD disk content;
- **Black bars:** when black bars appear at the left and right side of the screen, it is recommended to change to a picture format so that the picture fills the entire screen;
- **TV channel logo:** present a problem if they are bright and stationary. Moving or low-contrast graphics are less likely to cause uneven aging of the screen;
- **Stock market stickers:** presented at the bottom of the TV screen;
- **Shopping channel logos and pricing displays:** bright and shown constantly or repeatedly in the same location on the TV screen. Examples of still pictures also include logos, computer images, time display, teletext and images displayed in 4:3 mode, static images or characters, etc.

Notes:

- reduce contrast and brightness when viewing
- once burn-in occurs it will never disappear completely.

Glossary

- DVI** (Digital Visual Interface) : A digital interface standard created by the Digital Display Working Group (DDWG) to convert analog signals into digital signals to accommodate both analog and digital monitors.
- VGA** (Video Graphics Array) : a common standard graphics display system for PCs.
- RGB signals** : These are the three video signals, Red Green Blue, which make up the picture. Using these signals improves picture quality.
- S-VHS signals** : These are 2 separate Y/C video signals from the S-VHS and Hi-8 recording standards. The luminance signals Y (black and white) and chrominance signals C (colour) are recorded separately on the tape. This provides better picture quality than with standard video (VHS and 8 mm) where the Y/C signals are combined to provide only one video signal.
- NICAM sound** : Process by which digital sound can be transmitted.
- 16:9** : Refers to the ratio between the length and height of the screen. Wide screen televisions have a ratio of 16/9, conventional screen TV sets have a ratio of 4/3.
- HDMI** (High-Definition Multimedia Interface) : Provides an uncompressed, all digital audio/video interface between the TV and any HDMI-equipped audio/video component, such as set-top box, DVD player and A/V receiver. HDMI supports enhanced or high-definition video plus two-channel digital audio.
- System** : Television pictures are not broadcast in the same way in all countries. There are different standards: BG, DK, I, and LL'. The System setting (p. 5) is used to select these different standards. This is not to be confused with PAL or SECAM colour coding. PAL is used in most countries in Europe, Secam in France, Russia and most African countries. The United States and Japan use a different system called NTSC. The inputs EXT1 and EXT2 are used to read NTSC coded recordings.
- HDCP** (High-bandwidth Digital-Content Protection) : A specification developed by Intel for protecting digital entertainment that uses the DVI interface. HDCP encrypts content the transmission of digital content between the video source or transmitter such as a computer, DVD player or set-top box and the digital display or receiver such as a monitor, television or projector.
- YPbPr** : The analog component video signal.

Specifications

	26PFL5302D	26PFL5322D	32PFL5322D	32PFL5332D
PICTURE / DISPLAY Aspect ratio Picture Display Picture Enhancement	16 : 9 Progressive Scan 3/2 - 2/2 motion pull down Active Control Auto Picture (6 modes) Color, Contrast, Sharpness Control	16 : 9 Progressive Scan 3/2 - 2/2 motion pull down Active Control Auto Picture (6 modes) Color, Contrast, Sharpness Control	16 : 9 Pixel Plus Progressive Scan 3/2 - 2/2 motion pull down Active Control Auto Picture (6 modes) Color, Contrast, Sharpness Control	16 : 9 Pixel Plus Progressive Scan 3/2 - 2/2 motion pull down Active Control Auto Picture (6 modes) Color, Contrast, Sharpness Control
SOUND Output Power (RMS) Sound Enhancement Sound System	2 x 10W Auto Sound Virtual Dolby Surround			
CONVENIENCE	Auto Program Closed Captioning Full text Sleeptimer			
ON SCREEN DISPLAY LANGUAGES	English, French, Spanish			
CONNECTIVITY Bottom	AV1 : Audio L/R input, Composite Video input (CVBS), Component Video input (YPbPr) AV2 : Audio L/R input, Component Video input (YPbPr), HDMI 1/ HDMI 2 SPDIF output (Digital Only)			
Side	Headphone output Audio L/R input, Composite Video input (CVBS) S-Video input USB			
WEIGHT & DIMENSIONS : Weight (incl. Packaging) : Weight (excl. Packaging) : Carton Dimension (WxDxH) : Product Dimension (WxDxH) : screen size :	37.4 lbs 28.6 lbs 33.1" x 22.5" x 8.0" 26.8" x 21.1" x 7.9" 26" / 66cm	37.4 lbs 28.6 lbs 33.1" x 22.5" x 8.0" 26.8" x 21.1" x 7.9" 26" / 66cm	46.2 lbs 39.8 lbs 34.2" x 24.8" x 11.4" 31.7" x 24" x 8.3" 32" / 80cm	72.6 lbs 57 lbs 38.9" x 12.9" x 28.3" 36.7" x 11.3" x 27.1" 37" / 94cm
POWER CONSUMPTION : STANDBY POWER CONSUMPTION :	125 W <1 W	125 W <1 W	150 W <1 W	150 W <1 W
VOLTAGE : CONSUMPTION :	100 - 250 V~ 50 / 60 Hz	100 - 250 V~ 50 / 60 Hz	100 - 250 V~ 50 / 60 Hz	100 - 250 V~ 50 / 60 Hz

Specifications

	37PFL5332D	42PFL5332D	42PFP5332D/42PFP5342D	50PFP5332D/50PFP5342D
PICTURE / DISPLAY Aspect ratio Picture Display Picture Enhancement	16 : 9 Pixel Plus Progressive Scan 3/2 - 2/2 motion pull down Active Control Auto Picture (6 modes) Color, Contrast, Sharpness Control	16 : 9 Pixel Plus Progressive Scan 3/2 - 2/2 motion pull down Active Control Auto Picture (6 modes) Color, Contrast, Sharpness Control	16 : 9 Pixel Plus Progressive Scan 3/2 - 2/2 motion pull down Active Control Auto Picture (6 modes) Color, Contrast, Sharpness Control	16 : 9 Pixel Plus Progressive Scan 3/2 - 2/2 motion pull down Active Control Auto Picture (6 modes) Color, Contrast, Sharpness Control
SOUND Output Power (RMS) Sound Enhancement Sound System	2 x 15W Auto Sound Virtual Dolby Surround			
CONVENIENCE	Auto Program Closed Captioning Full text Sleeptimer			
ON SCREEN DISPLAY LANGUAGES	English, French, Spanish			
CONNECTIVITY Bottom	AV1 : Audio L/R input, Composite Video input (CVBS), Component Video input (YPbPr) AV2 : Audio L/R input, Component Video input (YPbPr), HDMI 1/ HDMI 2 SPDIF output (Digital Only)			
Side	Headphone output Audio L/R input, Composite Video input (CVBS) S-Video input USB			
WEIGHT & DIMENSIONS : Weight (incl. Packaging) : Weight (excl. Packaging) : Carton Dimension (WxDxH) : Product Dimension (WxDxH) : screen size :	72.6 lbs 57 lbs 38.9" x 12.9" x 28.3" 36.7" x 11.3" x 27.1" 37" / 94cm	88 lbs 70.4 lbs 46.4" x 32.2" x 12.9" 41.2" x 30.1" x 10.4" 42" / 107cm	88 lbs 70.4 lbs 46.4" x 32.2" x 12.9" 41.2" x 30.1" x 10.4" 42" / 107cm	138.6 lbs 124.3 lbs 52.3" x 35.9" x 14.8" 49.2" x 34.5" x 4.2" 50" / 127cm
POWER CONSUMPTION : STANDBY POWER CONSUMPTION : VOLTAGE : CONSUMPTION :	185 W <1 W 110 - 250 V~ 50 / 60 Hz	245 W <1 W 110 - 240 V~ 50 / 60 Hz	400 W <1 W 110 - 240 V~ 50 / 60 Hz	500 W <1 W 110 - 240 V~ 50 / 60 Hz

Introduction

Philips offers software upgrade capability for your TV using USB portable memory. After you have completed a software upgrade, your TV will typically perform better.

What improvements are made depends on the upgrade software you are using as well as the software your TV contained before the upgrade.

You can execute the software upgrade procedure yourself.

Be aware that the content of this document is addressing technical or software skilled users.

Preparing a portable memory for software upgrade

For the procedure you will require:

- A personal computer with web browsing capability.
- An archive utility that supports the ZIP-format (e.g. WinZip for Windows or StuffIt for Mac OS).
- A preferably empty USB memory stick.

Note: Only FAT/DOS-formatted portable memory is supported.

New software can be obtained from your dealer or can be downloaded from the www.philips.com/usasupport website:

- 1 Go to www.philips.com/usasupport using the web browser on your PC.
- 2 Follow the procedure to find the information and the software related to your TV.
- 3 Select the latest software upgrade file and download it to your PC.
- 4 Decompress the ZIP-file and copy the file "autorun.upg" to the root directory of the USB portable memory.

Note: Only use software upgrades that can be found on the www.philips.com/usasupport web site.

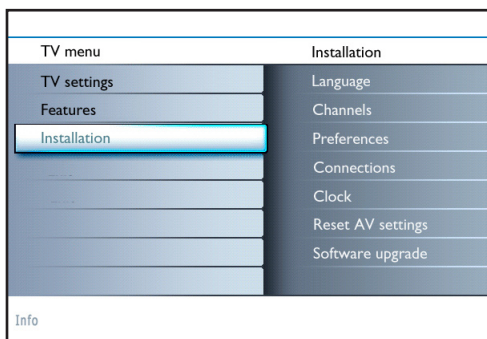

Verifying the version of the TV software

Before starting the software upgrade procedure, it is advised to check what the current TV software is.

- 1 Select **Software Upgrade** in the Installation menu.
- 2 Press the cursor right.
The Software Upgrade menu moves to the left panel.
- 3 Select **Current Software Info** to observe the version and the description of the current software.

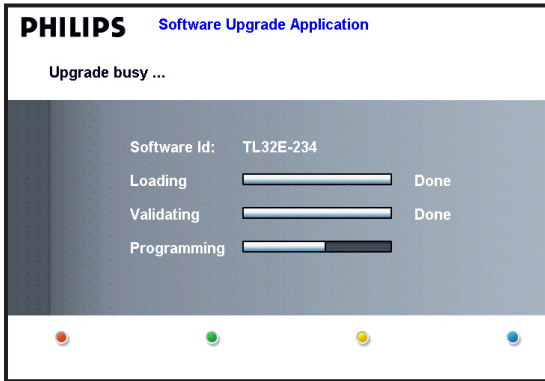

Automatic software upgrade procedure

For an automatic software upgrade copy the “autorun.upg” file in the root directory of the USB portable memory.

- ❶ Power off your TV and remove all memory devices.
- ❷ Insert the USB portable memory that contains the downloaded software upgrade.
- ❸ Switch on your TV with the power switch  at the right side of the TV.
- ❹ At startup the TV will scan the USB portable memory until it finds the update content. The TV will automatically go to the upgrade mode. After a few seconds it will display the status of the upgrade procedure.

Warning:

- You are not allowed to remove the USB portable memory during the software upgrade procedure!
 - In case of a power drop during the upgrade procedure, don't remove the USB portable memory from the TV. The TV will continue the upgrade as soon as the power comes back.
 - If you try to upgrade to a software version lower than the current version, a confirmation will be asked. Downgrading to older software should only be done in case of real necessity.
 - If an error occurs during the upgrade you should retry the procedure or contact your dealer.
- ❺ When the software upgrade was successful, remove the USB portable memory and restart your TV with the power switch  at the right side of the TV.

Your TV will start up with the new software.

Note: Once the upgrade is finished use your PC to remove the TV software from your USB portable memory.

Manual software upgrade procedure

For a manual software upgrade copy the “autorun.upg” file in a directory called “Upgrades” located in the root of the USB portable memory.

- ❶ Insert the portable memory that contains the downloaded software upgrade.
- ❷ The TV will automatically start the content browser menu. Exit the menu by pressing the **MENU** key.
- ❸ Select **Software Upgrade** in the Installation menu. Go to **Local upgrades**. The TV will list all compatible images available on the USB portable memory and display the data for each selected upgrade image.
- ❹ Select the correct upgrade image and press the red color button to start the upgrade. Your TV will restart and will automatically go to the upgrade mode. After a few seconds it will display the status of the upgrade procedure.

Warning:

If you try to upgrade to a software version equal or lower than the current version, a confirmation will be asked. Downgrading to older software should only be done in case of real necessity.

- ❺ When the software upgrade was successful, remove the USB portable memory and restart your TV with the power switch  at the right side of the TV. Your TV will start up with the new software.

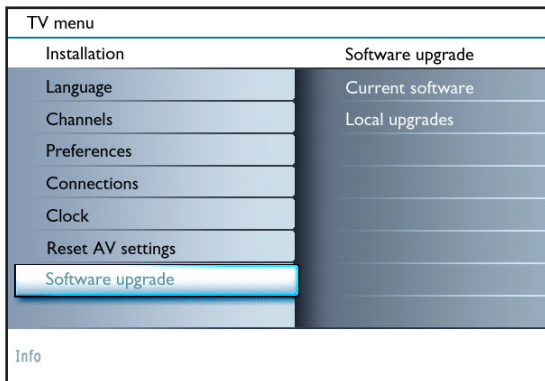

Annex 2 - Philips TV Slideshow Format with background music

Notes:

- The latest version of this document can be found on the Philips support website (www.philips.com/usasupport). Use the type number of your TV (e.g. 32PFL7332D/37) to find this documentation and other related files.
- Philips can't be held responsible for any problems that may occur as a result of the content in this document. Errors reported to Philips will be adapted and published on the Philips support website as soon as possible.

Introduction

This document explains how to make a Philips slideshow file with background audio. Be aware that the content of this document is addressing technical or software skilled users. To start the slideshow open the slideshow file in the Home network Browser of your TV.

- 1 Press the **MENU** button on the remote control after having inserted a USB device and switched on the TV.
- 2 Go to where you stored the slideshow file (.alb) on your portable memory.
- 3 Select the slideshow file and press the **OK** button to start the slide show.
- 4 To stop a slide show, press the **■** button.

General Rules

- The slideshow will use plain ASCII XML syntax to allow the creation and editing of the slideshow files using simple tools.
- All references to network content must be based on the global address of the content.
- Content on a Portable Memory (PM) doesn't have a global address; as a result content from a PM can never be referenced from a slideshow not stored on the PM itself.
- To maintain portability, a slideshow stored on a PM should **ONLY** reference content on the same PM. Referencing global addresses can result in inconsistencies if the PM is used on a non-networked CE device. The latter is however not forbidden, it is only a recommendation.
- It is preferable that URL's referencing PM content are based on a relative path starting from the directory where the slideshow is stored. This path includes the device or drive name of the PM.
An absolute path to content will also be supported.
 - relative path: pictures\test1.jpg, tamper.jpg, ..\new\bird.jpg, ...
 - absolute path: USB1:\pictures1\foo_bar.jpg, C:\f1.jpg, \organization.jpg, ...

General Format

The format and syntax below should be used to create the slideshow file (simple ascii text) with the extension .alb (.ALB)

Examples: slshow1.alb, summer_holiday_2004.ALB, test.alb, ...

The following syntax should be used to create the text file:

```
<?xml version="1.0" encoding="ISO-885h9-1" ?>
<philips-slideshow version="1.0" >
  <title>Title of the slideshow</title>
  <audio>audio_url</audio>
  <slide-duration>30</slide-duration>
  <slides>
    <slide>slide_1_url</slide>
    <slide>slide_2_url</slide>
    <slide>slide_3_url</slide>
    <slide>slide_4_url</slide>
    <slide>slide_5_url</slide>
    <slide>slide_6_url</slide>
    ...
    <slide>slide_N-1_url</slide>
    <slide>slide_N_url</slide>
  </slides>
</philips-slideshow>
```

Supported XML-tags

The following table gives a description of the XML syntax.

Tag Name	Use	Description
<i>philips-slideshow</i>	mandatory	Philips slideshow signature including the version.
<i>title</i>	optional	The title of the playlist.
<i>audio</i>	optional	The audio-URL following this tag will define the music playing in the background during the slideshow. A single song or playlist (.m3u & .pls) are the only valid audio references. Other reference will not result in any audio playback. If a single song is referenced the song will be repeated forever. If a playlist is referenced the playlist will be played in sequence with a repeat at the end of the playlist.
<i>slide-duration</i>	optional	The default display time (in 0,1 second) of a slide. The TV application isn't obliged to support this tag. The TV application can force the use of one or multiple predefined display times.
<i>slides</i>	mandatory	Identifies the slides to show.
<i>slide</i>	optional	Identifies the URL of the individual slide.

Examples:

See on this CD in the directory Files/Slideshow/....

Copy the directory with the slideshow files to your portable memory.

```
<?xml version="1.0" encoding="ISO-885h9-1" ?>
<philips-slideshow version="1.0" >
  <title>Philips AlbumFile</title>
  <audio>Music\Nature.mp3</audio>
  <slide-duration>50</slide-duration>
  <slides>
    <slide>Images\Image01.jpg</slide>
    <slide>Images\Image02.jpg</slide>
    <slide>Images\Image03.jpg</slide>
    <slide>Images\Image04.jpg</slide>
    <slide>Images\Image05.jpg</slide>
    <slide>Images\Image06.jpg</slide>
    <slide>Images\Image07.jpg</slide>
    <slide>Images\Image08.jpg</slide>
    <slide>Images\Image09.jpg</slide>
    <slide>Images\Image10.jpg</slide>
    <slide>Images\Image11.jpg</slide>
    <slide>Images\Image12.jpg</slide>
  </slides>
</philips-slideshow>
```

Notes:

- The latest version of this document can be found on the Philips support website (www.philips.com/usasupport).
- The software of your TV is upgradeable. If you have problems first check if you have the latest software installed on your TV. The latest software, together with instructions, can be found on the Philips support website.
Use the type number of your TV (e.g. 32PFL7332D/37) to find this documentation and other related files.
- Philips can't be held responsible neither for any errors in the content of this document nor for any problems as a result of the content in this document. Errors reported to Philips will be adapted and published on the Philips support website as soon as possible.

Digital Content Issues

- Only FAT (DOS) formatted (initialized) portable memory is supported. Errors in this formatting can result in unreadable content. If such problems appear try to re-format the card. Be aware that formatting the card will also delete all the content on it (pictures, music, ...).
- The following file types are supported: .jpg, .jpeg, .mp3, .alb, .m3u and .pls.
- Only linear JPEG picture formats are supported. Progressive JPEG and JPEG2000 encodings are not supported.
- The length of a filename or directory name is limited to the length specified by the FAT12/16/32 file systems.
- Max. levels of nested directories is 19.
- Never use the supported file type extensions (.jpg, .jpeg, .mp3, .alb, .m3u and .pls) as extensions for directories as these directories will be treated as corrupted files.
- The MP3 decoder does not support MPEG1 Layer 1 or Layer 2 playback.
- MP3 Pro files can be played with normal MP3 quality.
- The access and response time of the content on a device can differ depending on the type or brand of the device.
- The access and response time of the content on a device will decrease the more unsupported or corrupted files are on the device.

Digital Camera Issues

If a USB connection between your digital camera and the TV isn't working, you can try the solutions below to resolve your problem.

- Make sure your digital camera is switched on and verify if the configuration of your digital camera is correct (see the manual of your digital camera for more information).
- Some digital cameras allow you to switch off the USB interface. Make sure that the USB interface is switched on before connecting to the TV.
- If you have a digital camera with only internal memory (no removable memory) you can try to copy the content manually to a USB memory device (e.g. Philips KEY product) using a personal computer.
- Some digital cameras allow you to switch between PTP (Picture Transfer Protocol) or "PC Link" and USB Mass Storage or "PC Drive". Make sure that you select USB Mass Storage or "PC Drive" on your digital camera.
- If your camera supports different interface settings be sure to try them one by one or contact the reseller of your camera to find out the correct setting.

USB Memory Device Issues

- Devices connected to the USB port of your TV must be "Mass Storage Class" compliant. If your device (digital camera, MP3 player, portable harddisk, ...) is not "Mass Storage Class" compliant it will not be detected by the content browser of the TV.
- The following subsets of the Mass Storage Class specification are supported:
 - The implementation of the TV is based on the "Universal Serial Bus Mass Storage Class Specification Overview" (v1.2, June 23, 2003) including all documents referenced by the document. The document can be found on the USB standardisation website (www.usb.org).
 - Full support of the USB Mass Storage Class Bulk-Only Transport (bInterfaceProtocol = 50h).
 - Full support of SubClass Code = 05h; SFF-8070i spec.
 - Full support of SubClass Code = 06h; SCSI transparent command set.
- For large USB memory devices, when you are in the Content Browser, it may take a long time before you can access your files.
- When using a USB portable harddisk: Due to the high power consumption of the harddisk, it is advised to use the external power supply of the portable harddisk to guarantee proper working under all conditions.

PHILIPS LIMITED WARRANTY

ONE (1) YEAR

WARRANTY COVERAGE:

PHILIPS warranty obligation is limited to the terms set forth below.

WHO IS COVERED:

Philips warrants the product to the original purchaser or the person receiving the product as a gift against defects in materials and workmanship as based on the date of original purchase ("Warranty Period") from an Authorized Dealer. The original sales receipt showing the product name and the purchase date from an authorized retailer is considered such proof.

WHAT IS COVERED:

The Philips warranty covers new products if a defect arises and a valid claim is received by Philips within the Warranty Period. At its option, Philips will either (1) repair the product at no charge, using new or refurbished replacement parts, or (2) exchange the product with a product that is new or which has been manufactured from new, or serviceable used parts and is at least functionally equivalent or most comparable to the original product in Philips current inventory, or (3) refund the original purchase price of the product.

Philips warrants replacement products or parts provided under this warranty against defects in materials and workmanship from the date of the replacement or repair for ninety (90) days or for the remaining portion of the original product's warranty, whichever provides longer coverage for you. When a product or part is exchanged, any replacement item becomes your property and the replaced item becomes Philips' property. When a refund is given, your product becomes Philips' property.

Note: Any product sold and identified as refurbished or renewed carries a ninety (90) day limited warranty.

Replacement product can only be sent if all warranty requirements are met. Failure to follow all requirements can result in delay.

WHAT IS NOT COVERED - EXCLUSIONS AND LIMITATIONS:

This Limited Warranty applies only to the new products manufactured by or for Philips that can be identified by the trademark, trade name, or logo affixed to it. This Limited Warranty does not apply to any non-Philips hardware product or any software, even if packaged or sold with the product. Non-Philips manufacturers, suppliers, or publishers may provide a separate warranty for their own products packaged with the bundled product.

Philips is not liable for any damage to or loss of any programs, data, or other information stored on any media contained within the product, or any non-Philips product or part not covered by this warranty. Recovery or reinstallation of programs, data or other information is not covered under this Limited Warranty.

This warranty does not apply (a) to damage caused by accident, abuse, misuse, misapplication, or non-Philips product, (b) to damage caused by service performed by anyone other than Philips or Philips Authorized Service Location, (c) to a product or a part that has been modified without the written permission of Philips, or (d) if any Philips serial number has been removed or defaced, or (e) product, accessories or consumables sold "AS IS" without warranty of any kind by including refurbished Philips product sold "AS IS" by some retailers.

This Limited Warranty does not cover:

- Shipping charges to return defective product to Philips.
- Labor charges for installation or setup of the product, adjustment of customer controls on the product, and installation or repair of antenna systems outside of the product.
- Product repair and/or part replacement because of improper installation, connections to improper voltage supply, abuse, neglect, misuse, accident, unauthorized repair or other cause not within the control of Philips.
- Damage or claims for products not being available for use, or for lost data or lost software.
- Damage occurring to product during shipping.
- A product that requires modification or adaptation to enable it to operate in any country other than the country for which it was designed, manufactured, approved and/or authorized, or repair of products damaged by these modifications.
- A product used for commercial or institutional purposes (including but not limited to rental purposes).
- Product lost in shipment and no signature verification receipt can be provided.
- Failure to operate per Owner's Manual.

TO OBTAIN ASSISTANCE IN THE U.S.A., PUERTO RICO, OR U.S. VIRGIN ISLANDS...

Contact Philips Customer Care Center at:
1-888-PHILIPS (1-888-744-5477)

TO OBTAIN ASSISTANCE IN CANADA...

1-800-661-6162 (French Speaking)
1-888-PHILIPS (1-888-744-5477) - (English or Spanish Speaking)

REPAIR OR REPLACEMENT AS PROVIDED UNDER THIS WARRANTY IS THE EXCLUSIVE REMEDY FOR THE CONSUMER. PHILIPS SHALL NOT BE LIABLE FOR ANY INCIDENTAL OR CONSEQUENTIAL DAMAGES FOR BREACH OF ANY EXPRESS OR IMPLIED WARRANTY ON THIS PRODUCT. EXCEPT TO THE EXTENT PROHIBITED BY APPLICABLE LAW, ANY IMPLIED WARRANTY OF MERCHANTABILITY OR FITNESS FOR A PARTICULAR PURPOSE ON THIS PRODUCT IS LIMITED IN DURATION TO THE DURATION OF THIS WARRANTY.

Some states do not allow the exclusions or limitation of incidental or consequential damages, or allow limitations on how long an implied warranty lasts, so the above limitations or exclusions may not apply to you.

This warranty gives you specific legal rights. You may have other rights which vary from state/province to state/province.



Specifications are subject to change without notice
Trademarks are the property of Koninklijke Philips Electronics N.V. or their respective owners
2005 © Koninklijke Philips Electronics N.V. All rights reserved

www.philips.com



Smart Hotel (BDS) Mode Instructions

❶ Introduction

Thank you for purchasing this Philips television set.

Included in this television is a special functional mode that allows the TV to be configured for hospitality or commercial applications. This feature is called Smart Hotel Mode.

This addendum has been designed to help install and operate this TV in Smart Hotel Mode.

The basic functionality of this TV is described in the LCD TV User Manual, available online at <http://www.hospitality.philips.com>. If you experience any difficulty programming the channels into this set, please download and read the User Guide first, and follow its instructions to set-up and program the TV, before continuing with the rest of this addendum.



Please initiate the channel installation process immediately after the TV is switched on and connected to your source (Cable or Antenna) for the first time. Doing so will ensure that you have the correct and latest channel map for your location, and overwrite the channel map the TV shipped with, which is a normal outcome of our quality assurance testing.

❷ The benefits of Smart Hotel Mode

This TV is specially designed to operate in Smart Hotel Mode. Smart Hotel Mode offers the following benefits:

- Access to the user menu can be blocked. This prevents users (e.g. guests) from deleting or changing channel settings and/or modifying picture and sound settings. Picture and sound can only be controlled via pre-programmed Smart Settings and buttons on the remote control. This ensures that TVs are always set up correctly.
- A *switch-on volume* and *channel* can be selected. After switching on, the TV will always start on the specified channel and volume level.
- The maximum volume level of the TV can be limited in order to prevent guest disturbance.
- Channels can be blanked (Video only)
- The television keys VOLUME +/-, CHANNEL +/- and MENU can be blocked.
- On Screen Display information can be suppressed.

❸ Activating the Smart Hotel (BDS) Mode Setup menu

Follow these simple steps to access and activate the BDS Mode Setup menu:

1. Switch on the television and select a TV channel
2. On the remote control, press keys: **[3, 1, 9, 7, 5, 3, MUTE]**
3. The **BDS MODE SETUP MENU** becomes visible
4. Use the cursor keys to select and change any of the following settings:

Function	Possible selections
BDS MODE	ON /OFF/INSTALL
LOCAL KEYBOARD LOCKED	ON/OFF
REMOTE CONTROL LOCKED	ON/OFF
OSD DISPLAY	ON/OFF
SWITCH ON VOLUME	0-100
MAXIMUM VOLUME	0-100
SWITCH ON CHANNEL	0..125, EXTERNAL SOURCES
HIGH SECURITY MODE	ON/OFF
POWER ON	ON/STANDBY
DISPLAY MESSAGE	ON/OFF
WELCOME MESSAGE	>
USB BREAK IN	ON/OFF
BLANK CHANNEL	ON/OFF
CHANNEL TABLE	ON/OFF
STORE	>
SMARTLOADER TO TV	LOAD
TV TO SMARTLOADER	LOAD

5. Select “**STORE**” and press **[CURSOR RIGHT], [CURSOR RIGHT]** to save the settings and then press **[MENU]** to exit BDS Mode setup.
6. For BDS Mode settings to take effect, you must turn the TV set Off, then back On.

ⓘ **BDS Mode Functions**

This paragraph describes the functionality of each item in the BDS Mode Setup menu.

BDS MODE

- ON** This enables the BDS Mode. When BDS Mode is ON:
- The user menu is blocked.
 - All settings of the BDS Mode Setup menu are in effect.
- OFF** This disables the BDS Mode. When BDS Mode is OFF:
- The TV operates as a normal (consumer) TV
- INSTALL** This option allows Auto-Installation (in consumer mode) to work in tandem with Channel Table settings. When BDS Mode is set to INSTALL:
- The Auto-Install function of the TV will work (in consumer mode) according to the Channel Table setting in the BDS Mode Setup menu.

LOCAL KEYBOARD LOCKED

- ON** The television keys VOLUME +/- , CHANNEL +/- and MENU are blocked.
- OFF** The television keys VOLUME +/- , CHANNEL +/- and MENU function normally

REMOTE CONTROL LOCKED

- ON** Standard Remote Control keys are disabled.
- OFF** All Remote Control keys will function normally.

OSD DISPLAY

- ON** Normal screen information is displayed (e.g. channel information)
- OFF** Screen information is suppressed (except for some VGA input, if present)

SWITCH ON VOLUME

When the user switches the TV ON, it will play at the specified volume level.

Note: "SWITCH ON VOLUME" cannot exceed the MAXIMUM VOLUME level. Whenever the BDS Mode Setup menu is accessed, the current volume level is reset to the SWITCH ON VOLUME level.

MAXIMUM VOLUME

This option specifies the maximum allowable volume level of the TV.

SWITCH ON CHANNEL

When the user powers on the TV, it will tune to the channel specified by this setting. The switch on channel is selected from a list of installed channels.

HIGH SECURITY MODE

- ON** This allows access to the BDS Mode Setup Menu via the special BDS Setup Remote only.
- OFF** This allows access to the BDS Mode Setup Menu via BDS Setup Remote or via normal Remote Control (using a special key code sequence).

POWER ON

The Power On function allows the TV to enter a specific mode of operation (On or Standby) after the mains power is activated.

- ON** When set, the TV will always turn ON after the mains power is enabled.
- STANDBY** When set, the TV will always turn to STANDBY after mains power is enabled

DISPLAY MESSAGE

- ON** Enables display of the Welcome Message for 30 seconds after the TV set is turned on
- OFF** Disables the display of the Welcome Message.

If OSD DISPLAY is set to OFF, then the Welcome Message is automatically disabled.

WELCOME MESSAGE

The Welcome Message function allows the TV to show a customized greeting to the hotel guest whenever the TV is switched on. This helps to personalize the hotel experience for guests.

The Welcome Message can consist of 2 lines of text, with each line containing a maximum of 20 alphanumeric characters. Use the arrow keys of the Remote Control to compose the Welcome Message.

To enable the display of the Welcome Message, the DISPLAY MESSAGE option must be ON

USB BREAK IN

When enabled, this function allows easy access and navigation to any USB device attached to the USB connector on the TV set (when BDS Mode is ON).

- ON** Automatically displays a menu allowing easy navigation of the contents of any USB device whenever it is plugged into the USB connector of the TV set.
- OFF** Disables the menu display from automatically appearing whenever any USB device is plugged into the USB connector of the TV set. However, the contents of the USB device can still be accessed manually.

BLANK CHANNEL

The Blank Channel function disables the display of video on the TV, but does not affect the audio output. This function can be used for audio applications (example: music-only channels, and so on) which do not necessarily require the display of video.

- ON** The current channel is blanked (Video only)
- OFF** The current channel is not blanked (this is the Default setting)

BLANK CHANNEL can be set for every channel. Use [**CH+** / **CH-**] to visit all the channels and set the desired status per channel. The channel number is visible in the top left corner.

CHANNEL TABLE

- ON** The TV set will process the Channel Table (PSIP) information when BDS Mode is On. This may also result in background channel installation updates to the TV (when available).
- OFF** Disables the use of the Channel Table (PSIP) information when TV channel auto installation is performed. The BDS Mode option must also be set to "Install" before auto installation is triggered.

Note: If CHANNEL TABLE = OFF during TV channel installation, it is possible that channels carrying Emergency Alert System (EAS) signals may not be installed. The TV installer must verify that the EAS signal is available on any one (or more) of the channels that are successfully installed on the TV.

This TV supports the cloning of picture and configuration settings from one TV set to another, via any standard USB Memory storage device. Follow these steps to clone the TV settings:

1. Use a PC to create a folder called "Repair" in your USB Memory device.
2. Plug the USB Memory device into the USB Connector jack on the TV set
3. From the BDS Mode Setup Menu, select **TV TO SMARTLOADER** (if copying the settings from the TV to the USB Memory device) or **SMARTLOADER TO TV** (if copying the settings from the USB Memory device to the TV)

TV TO SMARTLOADER

LOAD Makes a copy of the TV Configuration data (including the Video, Audio, Channel Table, and BDS Mode settings) and stores it on any USB Memory device.

SMARTLOADER TO TV

LOAD Clones the TV Configuration data (including the Video, Audio, Channel Table, and BDS Mode settings) from any USB Memory device to the TV.

Specifications are subject to change without notice
Trademarks are property of Koninklijke Philips Electronics N.V. or their respective owners.
2007 © Koninklijke Philips Electronics N.V. All rights reserved.