

**AKZM 833**

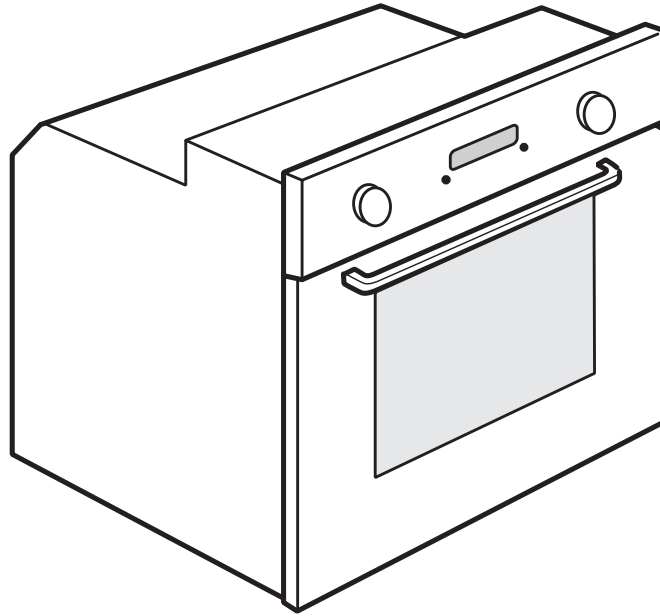

**EN**

**User and maintenance manual**

**FR**

**Manuel d'utilisation et d'entretien**

The Whirlpool logo consists of a stylized swirl icon above the word "Whirlpool" in a bold, sans-serif font. A thin, curved line loops around the bottom of the word.

**SENSING THE DIFFERENCE**



## IMPORTANT SAFETY INSTRUCTIONS

### **YOUR SAFETY AND THAT OF OTHERS IS PARAMOUNT**

This manual and the appliance itself provide important safety warnings, to be read and observed at all times.



This is the danger symbol, pertaining to safety, which alerts users to potential risks to themselves and others. All safety warnings are preceded by the danger symbol and the following terms:



#### **DANGER**

Indicates a hazardous situation which, if not avoided, will cause serious injury.



#### **WARNING**

Indicates a hazardous situation which, if not avoided, could cause serious injury.

All safety warnings give specific details of the potential risk present and indicate how to reduce risk of injury, damage and electric shock resulting from improper use of the appliance. Carefully observe the following instructions:

- The appliance must be disconnected from the power supply before carrying out any installation work.
- Installation and maintenance must be carried out by a qualified technician, in compliance with the manufacturer's instructions and local safety regulations. Do not repair or replace any part of the appliance unless specifically stated in the user manual.
- Power cable replacement must be carried out by a qualified electrician. Contact an authorized service centre.
- Regulations require that the appliance is earthed.
- The power cable must be long enough for connecting the appliance, once fitted in its housing, to the main power supply.
- For installation to comply with current safety regulations, an all-pole disconnect switch with minimum contact gap of 3 mm must be utilized.
- Do not use multiple plug adaptors if the oven is fitted with a plug.
- Do not use extension leads.
- Do not pull the power supply cable.
- The electrical components must not be accessible to the user after installation.
- If the surface of the induction plate is cracked, do not use it and switch off the appliance to avoid the possibility of electric shock (only for models with induction function).

- Do not touch the appliance with any wet part of the body and do not operate it when barefoot.
- This appliance is designed solely for use as a domestic appliance for cooking food. No other type of use is permitted (e.g.: heating rooms). The Manufacturer declines all responsibility for inappropriate use or incorrect setting of the controls.
- This appliance can be used by children from 8 years and above and persons with reduced physical, sensory or mental capabilities or lack of experience and knowledge if they have been given supervision or instruction concerning use of the appliance in a safe way and understand hazards involved. Children shall not play with the appliance. Cleaning and user maintenance shall not be made by children without supervision.
- The accessible parts of the appliance may become very hot during use. Young children should be kept away from the appliance and supervised to ensure that they do not play with it.
- The appliance and its accessible parts become hot during use. Care should be taken to avoid touching heating elements. Children less than 8 years old shall be kept away, unless continuously supervised.
- During and after use, do not touch the heating elements or interior surfaces of the appliance - risk of burns. Do not allow the appliance to come into contact with cloths or other flammable materials until all the components have cooled sufficiently.
- At the end of cooking, exercise caution when opening the appliance door, letting the hot air or steam exit gradually before accessing the oven. When the appliance door is shut, hot air is vented from the aperture above the control panel. Do not obstruct the vent apertures.
- Use oven gloves to remove pans and accessories, taking care not to touch the heating elements.
- Do not place flammable materials in or near the appliance: a fire may break out if the appliance is inadvertently switched on.
- Do not heat or cook sealed jars or containers in the appliance. The pressure that builds up inside might cause the jar to explode, damaging the appliance.
- Do not use containers made of synthetic materials.

- Overheated oils and fats catch fire easily. Always remain vigilant when cooking foods rich in fat and oil.
- Never leave the appliance unattended during food drying.
- If alcoholic beverages are used when cooking foods (e.g. rum, cognac, wine), remember that alcohol evaporates at high temperatures. As a result, there is a risk that vapours released by the alcohol may catch fire upon coming into contact with the electrical heating element.
- Never use steam cleaning equipment.
- Do not touch the oven during the pyrolysis cycle. Keep children away from the oven during the pyrolysis cycle (only for ovens with Pyrolysis function).
- Only use the temperature probe recommended for this oven.
- Do not use harsh abrasive cleaners or sharp metal scrapers to clean the oven door glass since they can scratch the surface, which may result in shattering of the glass.
- Ensure that the appliance is switched off before replacing the lamp to avoid the possibility of electric shock.
- Do not use aluminium foil to cover food in the cooking vessel (only for ovens with cooking vessel supplied).
- Use protective gloves to perform all unpacking and installation operations.

### **Scrapping of household appliances**

- This appliance is manufactured with recyclable or reusable materials. Dispose of it in accordance with local waste disposal regulations. Before scrapping, cut off the power supply cable.
- For further information on the treatment, recovery and recycling of household electrical appliances, contact your competent local authority, the collection service for household waste or the store where you purchased the appliance.

## **INSTALLATION**

After unpacking the oven, make sure that it has not been damaged during transport and that the oven door closes properly. In the event of problems, contact the dealer or your nearest After-sales Service. To prevent any damage, only remove the oven from its polystyrene foam base at the time of installation.

### **PREPARING THE HOUSING UNIT**

- Kitchen units in contact with the oven must be heat resistant (min 90°C).
- Carry out all cabinet cutting work before fitting the oven in the housing and carefully remove all wood chips and sawdust.
- After installation, the bottom of the oven must no longer be accessible.
- For correct appliance operation, do not obstruct the minimum gap between the worktop and the upper edge of the oven.

### **ELECTRICAL CONNECTION**

Make sure the power voltage specified on the appliance dataplate is the same as the mains voltage. The dataplate is on the front edge of the oven (visible when the door is open).

- Power cable replacement (type H05 RR-F 3 x 1.5 mm<sup>2</sup>) must be carried out by a qualified electrician. Contact an authorized service centre.

## **GENERAL RECOMMENDATIONS**

### **Before use:**

- Remove cardboard protection pieces, protective film and adhesive labels from accessories.
- Remove the accessories from the oven and heat it at 200° for about an hour to eliminate the smell and fumes from the insulating materials and protective grease.

### **During use:**

- Do not place heavy objects on the door as they could damage it.
- Do not cling to the door or hang anything from the handle.
- Do not cover the inside of the oven with aluminium foil.
- Never pour water into the inside of a hot oven; this could damage the enamel coating.
- Never drag pots or pans across the bottom of the oven as this could damage the enamel coating.
- Make sure that the electrical cables of other appliances do not touch hot parts of the oven or become trapped in the door.
- Do not expose the oven to atmospheric agents.

## **SAFEGUARDING THE ENVIRONMENT**

### **Disposal of packing material**

The packing material is 100% recyclable and is marked with the recycle symbol (♻️). The various parts of the packing must therefore be disposed of responsibly and in full compliance with local authority regulations governing waste disposal.

### **Scrapping the product**

- This appliance is marked in compliance with European Directive 2002/96/EC, Waste Electrical and Electronic Equipment (WEEE).
- By ensuring this product is disposed of correctly, you will help prevent potential negative consequences for the environment and human health, which could otherwise be caused by inappropriate waste handling of this product.
- The symbol  on the product or on the accompanying documentation indicates that it should not be treated as domestic waste but must be taken to an appropriate collection centre for the recycling of electrical and electronic equipment.

### **Energy saving**

- Only pre-heat the oven if specified in the cooking table or your recipe.
- Use dark lacquered or enamelled baking moulds as they absorb heat far better.
- Switch the oven off 10/15 minutes before the set cooking time. Food requiring prolonged cooking will continue to cook even once the oven is switched off.

## **DECLARATION OF CONFORMITY (C E)**

- This oven, which is intended to come into contact with foodstuffs, complies with European Regulation (C E) n.1935/2004 and has been designed, manufactured and sold in conformity with the safety requirements of the "Low Voltage" directive 2006/95/CE (which replaces 73/23/CEE and subsequent amendments), the protection requirements of "EMC" 2004/108/CE.

## **TROUBLESHOOTING GUIDE**

### **The oven does not work:**

- Check for the presence of mains electrical power and if the oven is connected to the electrical supply.
- Turn off the oven and restart it to see if the fault persists.

### **The door will not open:**

- Turn off the oven and restart it to see if the fault persists.
- **Important:** during self-cleaning, the oven door will not open. Wait until it unlocks automatically (see paragraph "Cleaning cycle of ovens with pyrolysis function").

### **The electronic programmer does not work:**

- If the display shows the letter "F" followed by a number, contact your nearest After-sales Service. Specify in this case the number that follows the letter "F".

## AFTER-SALES SERVICE

### **Before calling the After-Sales Service:**

1. See if you can solve the problem yourself with the help of the suggestions given in the "Troubleshooting guide".
2. Switch the appliance off and back on again to see if the fault persists.

**If after the above checks the fault still occurs, get in touch with the nearest After-sales Service.**

Always specify:

- a brief description of the fault;
- the type and exact model of the oven;
- the service number (number after the word Service on the rating plate), located on the right hand edge of the oven cavity (visible when the oven door is open). The service number is also indicated on the guarantee booklet;
- your full address;
- your telephone number.

**SERVICE** 0000 000 00000



If any repairs are required, please contact an authorised **After-sales Service** (to guarantee that original spare parts will be used and repairs carried out correctly).

## CLEANING



### **WARNING**

- **Never use steam cleaning equipment.**
- **Only clean the oven when it is cool to the touch.**
- **Disconnect the appliance from the power supply.**

### **Oven exterior**

**IMPORTANT: do not use corrosive or abrasive detergents. If any of these products accidentally comes into contact with the appliance, clean immediately with a damp cloth.**

- Clean the surfaces with a damp cloth. If it is very dirty, add a few drops of washing up detergent to the water. Finish off with a dry cloth.

### **Oven interior**

**IMPORTANT: do not use abrasive sponges or metallic scrapers or scourers. Over time, these can ruin enamelled surfaces and the oven door glass.**

- After every use, allow the oven to cool then clean it preferably while it is still warm in order to remove built-up dirt and stains caused by food residues (e.g. food with a high sugar content).
- Use proprietary oven detergents and follow the manufacturer's instructions to the letter.
- Clean the door glass with a suitable liquid detergent. The oven door can be removed to facilitate cleaning (see MAINTENANCE).
- The top heating element of the grill (see MAINTENANCE) can be lowered (some models only) to clean the roof of the oven.

**N.B.: during prolonged cooking of foods with a high water content (e.g. pizza, vegetables, etc.) condensation may form on the inside of the door and around the seal. When the oven is cold, dry the inside of the door with a cloth or sponge.**

### **Accessories:**

- Soak the accessories in water with washing up detergent immediately after use, handling them with oven gloves if still hot.
- Food residues can be easily removed using a brush or sponge.

### **Cleaning the rear wall and catalytic side panels of the oven (if present):**

**IMPORTANT: do not use corrosive or abrasive detergents, coarse brushes, pot scourers or oven sprays which could damage the catalytic surface and ruin its self-cleaning properties.**

- Operate the oven empty with the fan-assisted function at 200°C for about one hour
- Next, leave the appliance to cool down before removing any food residue with a sponge.

### **Cleaning cycle of ovens with pyrolysis function (if present):**



### **WARNING**

- **Do not touch the oven during the pyrolysis cycle.**
- **Keep children away from the oven during the pyrolysis cycle.**

This function burns off spatters produced inside the oven during cooking at a temperature of approx. 500°C. At this high temperature, the deposits turn into a light ash which can be easily wiped away with a damp cloth, when the oven is cool. Do not select the pyrolysis function after every use, only when the oven is very dirty or produces smoke or fumes while preheating or cooking.

- If the oven is installed below a hob, make sure that all burners or electric hotplates are switched off during the self-cleaning (pyrolysis) function.

- Remove all accessories before running the pyrolysis function.
- For optimum cleaning of the oven door, remove the worst soiling with a damp sponge before using the pyrolytic function. The appliance is equipped with 2 pyrolysis functions:
  1. Energy-saving cycle (PYRO EXPRESS/ECO): which consumes approximately 25% less energy than the standard cycle. Select it at regular intervals (after cooking meat on 2 or 3 consecutive occasions).
  2. Standard cycle (PYRO): which is suitable for cleaning a very dirty oven.
- In any case, after a certain number of uses and depending on how dirty the oven is, a message on the oven display advises you to run a self-cleaning cycle.

**N.B.: during the pyrolysis function, the oven door will not open; it will remain locked until the temperature inside the oven has returned to an acceptably safe level.**

## MAINTENANCE

### WARNING

- Use safety gloves.
- Ensure the oven is cold before carrying out the following operations.
- Disconnect the oven from the power supply.

## REMOVING THE DOOR

### To remove the door:

1. Open the door fully.
2. Lift the catches and push them forwards as far as they will go (fig. 1).
3. Close the door as far as it will go (A), lift it up (B) and turn it (C) until it is released (D) (fig. 2).

### To refit the door:

1. Insert the hinges in their seats.
2. Open the door fully.
3. Lower the two catches.
4. Close the door.

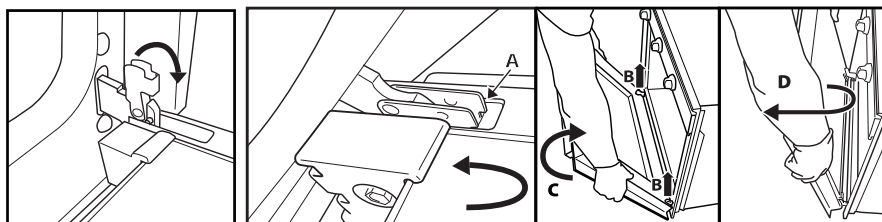

Fig. 1

Fig. 2

## MOVING THE TOP HEATING ELEMENT (SOME MODELS ONLY)

1. Remove the side accessory holder grilles (Fig. 3).
2. Pull the heating element out a little (Fig. 4) and lower it (Fig. 5).
3. To reposition the heating element, lift it up, pulling it slightly towards you, making sure it comes to rest on the lateral supports.

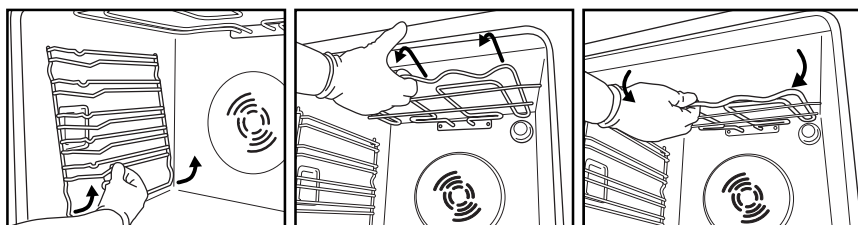

Fig. 3

Fig. 4

Fig. 5

## REPLACING THE OVEN LAMP

### To replace the rear lamp (if present):

1. Disconnect the oven from the power supply.
2. Unscrew the lamp cover (Fig. 6), replace the lamp (see note for lamp type) and screw the lamp cover back on.
3. Reconnect the oven to the power supply.

### To replace the side lamp (if present):

1. Disconnect the oven from the power supply.
2. Remove the side accessory holder grilles, if present (Fig. 3).
3. Use a screwdriver to prise off the lamp cover (Fig. 7).
4. Replace the lamp (see note for lamp type) (Fig. 8).
5. Reposition the lamp cover, pushing it on firmly until it snaps into place (Fig. 9).



6. Refit the side accessory holder grilles.
7. Reconnect the oven to the power supply.

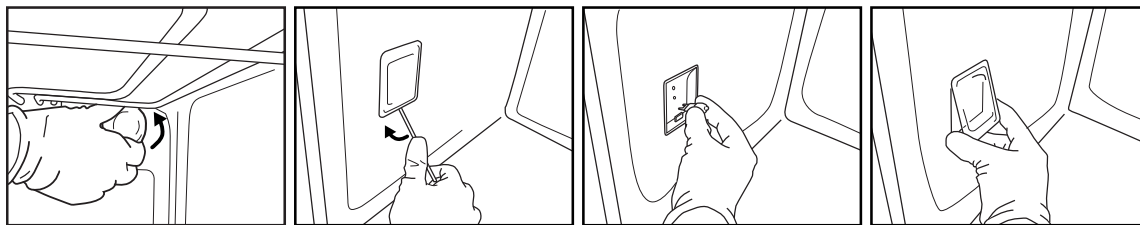

Fig. 6

Fig. 7

Fig. 8

Fig. 9

**N.B.:**

- Only use 25-40W/230V type E-14, T300°C incandescent lamps, or 20-40W/230 V type G9, T300°C halogen lamps.
- The lamp used in the appliance is specifically designed for electrical appliances and is not suitable for household room illumination (Commission Regulation (EC) No 244/2009).
- Lamps are available from our After-sales Service.

**IMPORTANT:**

- **If using halogen lamps, do not handle with bare hands since fingerprints can damage them.**
- **Do not use the oven until the lamp cover has been repositioned.**

# INSTRUCTIONS FOR OVEN USE

FOR ELECTRICAL CONNECTION, SEE THE PARAGRAPH ON INSTALLATION

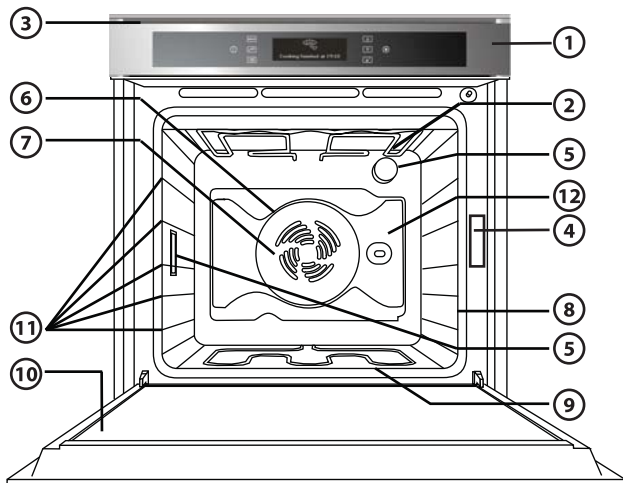

1. Control panel
2. Upper heating element/grill
3. Cooling fan (not visible)
4. Dataplate (not to be removed)
5. Light
6. Circular heating element (not visible)
7. Fan
8. Turnspit (if present)
9. Lower heating element (not visible)
10. Door
11. Position of shelves (the number of shelves is indicated on the front of the oven)
12. Rear wall

## **N.B.:**

- During cooking, the cooling fan may switch on at intervals in order to minimise energy consumption.
- At the end of cooking, after the oven has been switched off, the cooling fan may continue to run for a while.
- When the oven door is opened during cooking, the heating elements switch off.

## **ACCESSORIES SUPPLIED**

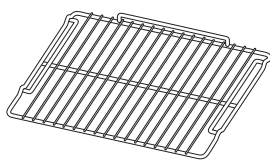

Fig. A

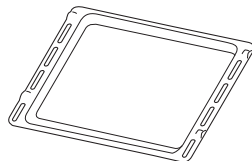

Fig. B

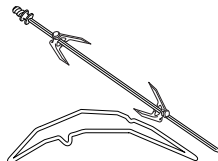

Fig. C



Fig. D

- A. WIRE SHELF:** the wire shelf can be used to grill food or as a support for pans, cake tins and other ovenproof cooking receptacles.
- B. DRIP TRAY:** the drip tray is designed to be positioned under the wire shelf in order to collect fat or as an oven tray for cooking meat, fish, vegetables, focaccia, etc.
- C. TURNSPIT:** for uniform roasting of large pieces of meat and poultry.
- D. CELLULOSE CLOTH:** to be used for the STARCLEAR™ cleaning cycle.  
**IMPORTANT:** Only use the cellulose cloth provided.

**The number of accessories may vary according to which model is purchased.**

## **ACCESSORIES NOT SUPPLIED**

Other accessories can be purchased separately from the After-sales Service.

## INSERTING WIRE SHELVES AND OTHER ACCESSORIES IN THE OVEN

The wire shelf and other accessories are provided with a locking mechanism to prevent their unintentional removal.

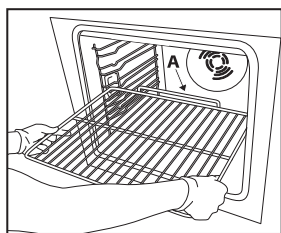

Fig. 1

1. Insert the wire shelf horizontally, with the raised part "A" upwards (Fig. 1).
2. Angle the wire shelf when it reaches the locking position "B" (Fig. 2).

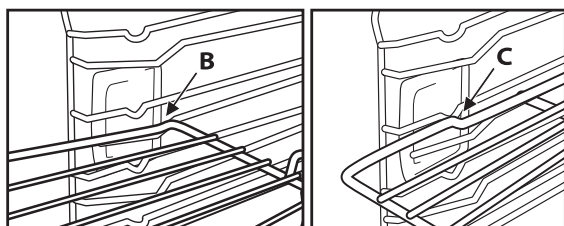

Fig. 2

Fig. 3

3. Return the wire shelf to the horizontal position and push it in fully to "C" (Fig. 3).
4. To remove the wire shelf proceed in reverse order.

The other accessories, like the drip tray and baking tray, are inserted in exactly the same way. The protrusion on the flat surface enables the accessories to lock in place.

## CONTROL PANEL DESCRIPTION



**TOUCH KEYS:** to use, simply touch the corresponding symbol (a light touch is all that is required).

⓪ On/Off (when you press on / off button to turn off the oven an acoustic signal will sound, this sound can not be disabled)

MENU to access the main MENU or return to the start screen

☆ to access the 10 most used functions

⏪ to return to the previous screen

⬆️ ⬆️ to browse the functions/options and change pre-set values

✓ to select and confirm settings

▶️ to start cooking

## LIST OF FUNCTIONS

After switching on the oven, press button ⓪ and the display will show the following instructions.

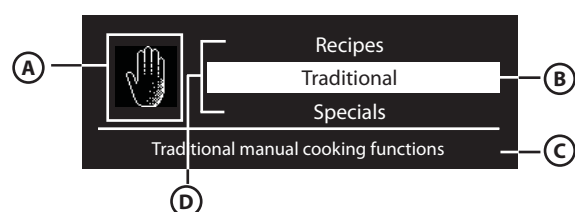

- A. Symbol for highlighted function
- B. Highlighted function can be selected by pressing ✓
- C. Description of highlighted function
- D. Other available and selectable functions.

## DETAILS OF FUNCTION

After selecting the desired function, press button and the display will show further options and related details.



To move between different areas, use buttons and : the cursor moves to the adjustable values, following the order described above. Press to select the value, adjust it using and confirm by pressing button .

## USING THE APPLIANCE FOR THE FIRST TIME - LANGUAGE SELECTION AND SETTING THE TIME

For correct use of the oven, when it is switched on for the first time you will have to select the desired language and set the correct time.

Proceed as follows:

1. Press : the display will show the list of the first three available languages.
2. Press buttons and to scroll down the list.
3. When the desired language is highlighted, press to select it.  
After language selection, the display will flash 12:00.
4. Set the time using buttons and . To scroll through the numbers more quickly, keep the button pressed.
5. Confirm your setting by pressing : the display will show the list of functions.

## SELECTING COOKING FUNCTIONS



1. If the oven off press button ; the display will show the cooking functions.
2. To browse the various possibilities, press buttons : the selectable function is highlighted in white in the centre of the display.  
**N.B.: for the list and description of functions, see the specific table at page 14 and at page 15.**
3. Select the function by pressing button : the cooking settings are shown on the display. If the pre-set values are those desired, press the start button , otherwise proceed as indicated above to change them.

## SETTING THE TEMPERATURE/OUTPUT OF THE GRILL

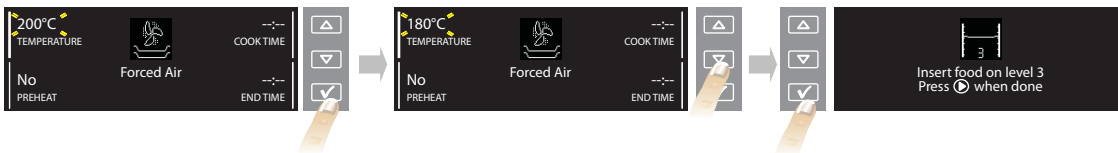

To change the temperature or output of the grill, proceed as follows:

1. Check that the cursor is positioned next to the temperature value (zone 1); press button to select the parameter to be changed: the temperature values flash.
2. Use buttons to change to the desired value.
3. Press button to confirm and then press . The display indicates which shelf food should be placed on.
4. Press to start cooking.  
The set temperature can also be changed during cooking by following the same procedure.
5. At the end of cooking, the end of cooking message is displayed. At this point the oven can be switched off by pressing , or cooking can be prolonged by pressing . When switched off, the display shows the cooling bar which indicates the temperature inside the oven.

## PREHEATING THE OVEN

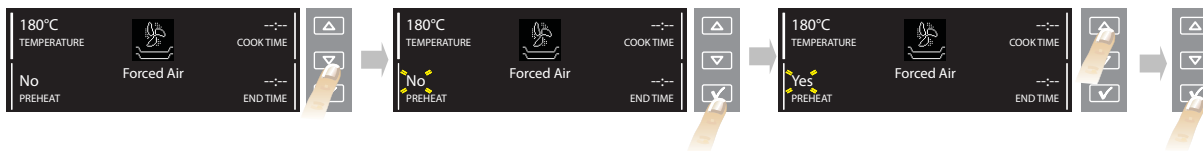

If you wish to preheat the oven before inserting food, change the oven's default selection as follows:

1. Using buttons  and , move the cursor to preheating.
2. Press button  to select the setting: "No" flashes on the display.
3. To change the setting, press  or : "Yes" appears on the display.
4. To confirm your choice, press button .

## FAST PREHEATING

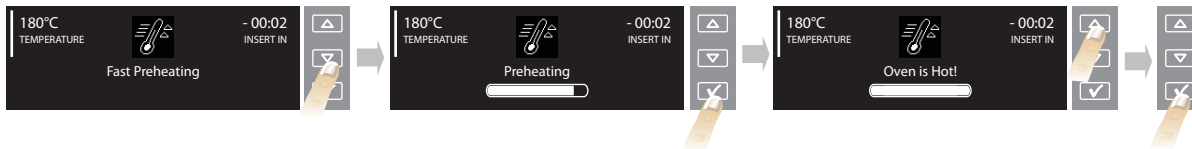

If you wish to preheat the oven quickly before inserting food, change the oven's default selection as follows:

1. Select the fast preheating function using buttons  .
2. Confirm by pressing : the settings are shown on the display.
3. If the proposed temperature is that desired, press , otherwise proceed as described in previous paragraphs to change it. An acoustic signal will sound when the oven has reached the set temperature. At the end of preheating, the oven automatically selects the conventional function .
4. If you wish to set a different cooking function, press  and select the desired function.

## SETTING COOKING TIME

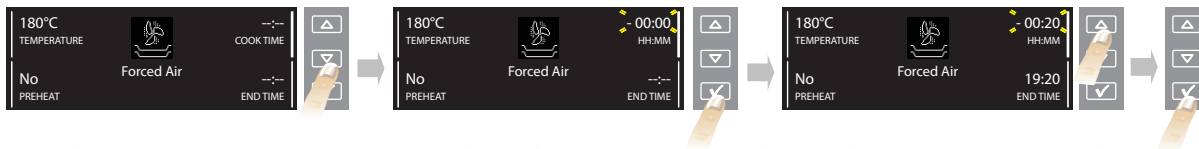

This function can be used to cook food for a set length of time, from a minimum of 1 minute to the maximum time allowed by the selected function, after which the oven switches off automatically.

1. To select the function, position the cursor next to "COOK TIME" using buttons  .
2. Press button  to select the setting; "00:00" flashes on the display.
3. Change the value using buttons  and  to display the desired cooking time.
4. Confirm the selected value by pressing button .

## BROWNING

At the end of cooking, with certain functions, the display indicates the possibility of browning the surface of your dish. This function can only be used when cooking time has been set.

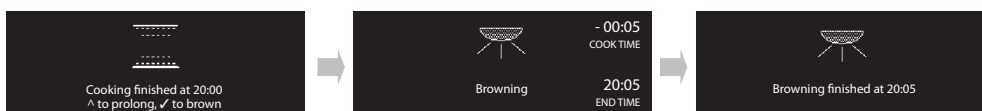

At the end of cooking time, the display shows " ^ to prolong, ✓ to brown". Press button , and the oven starts a 5 minute browning cycle. This function can only be used once after cooking.

## SETTING END OF COOKING TIME / DELAYED START

The end of cooking time can be set, delaying the start of cooking by up to a maximum of 23 hours and 59 minutes. This can only be done once cooking time has been set. **This setting is only possible when pre-heating is not required for the selected function.**

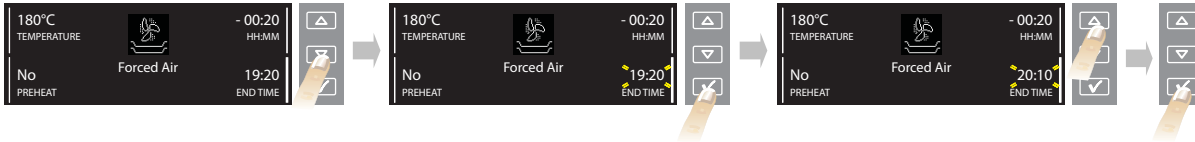

After setting cooking time, the display shows the end of cooking time (for example 19:20). To delay the end of cooking time, and thus also the cooking start time, proceed as follows:

1. Position the cursor next to the end of cooking time using buttons  .
2. Press button  to select the setting: the end of cooking time flashes.
3. To delay the end of cooking time, use buttons  and  to set the desired value.
4. Confirm the selected value by pressing button .
5. Press button . The display indicates which shelf food should be placed on.
6. Press button  to activate the function. The oven will start cooking after a period of time calculated so as to finish cooking at the set time (for example, in the case of a dish which requires a cooking time of 20 minutes, if the end of cooking time is set to 20:10, the oven will begin cooking at 19:50).

**N.B.: During the interval before cooking starts, the oven can in any case be switched on by pressing button .**

**At any time during cooking, set values (temperature, grill setting, cooking time) using buttons   and button  as described in previous paragraphs.**

## TIMER

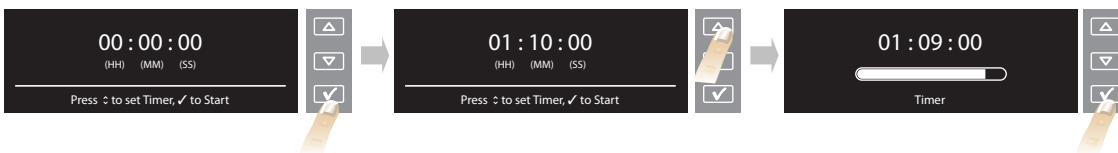

This function can be used only with the oven switched off and is useful, for example, for monitoring the cooking time of pasta. The maximum time which can be set is 1 hour 30 minutes.

1. With the oven switched off, press button : the display will show "00:00:00".
2. Press buttons  and  to select the desired time.
3. Press button  to start the countdown. When the set time has elapsed, the display will show "00:00:00" and an acoustic signal will sound. At this point the time can be prolonged, proceeding as described above, or the timer can be deactivated by pressing button  (the time of day will be shown on the display).

## RECIPES

Thanks to “Sixth sense” technology, the oven offers 30 pre-set recipes with ideal cooking temperatures. Simply follow the recipe as regards ingredients and the method of preparation. Then, proceed as follows:

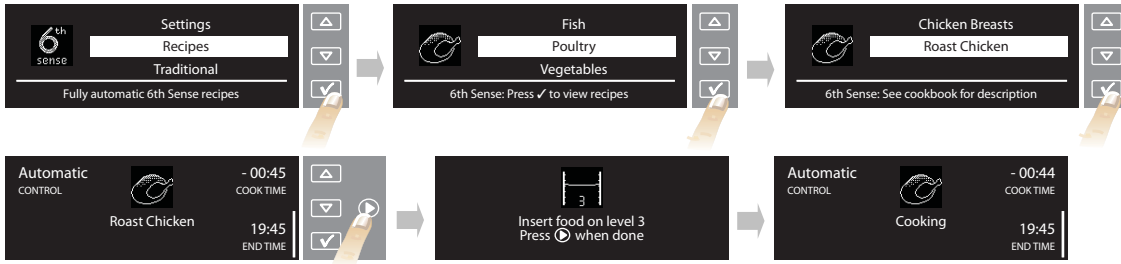

1. Select “RECIPES” using buttons and confirm with .
2. Select the dish to be cooked from the proposed list.
3. Confirm the selected dish using button .
4. Select the desired recipe using buttons .
5. Confirm by pressing : the display shows the approximate cooking time.
6. Put the food in the oven and press button . The display indicates which shelf food should be placed on.
7. Press button to start cooking. To delay the start of cooking, see the relevant paragraph.

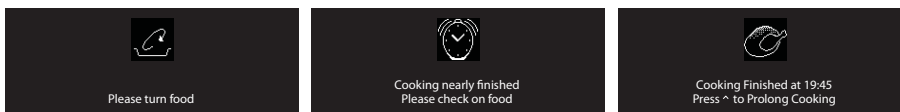

**N.B.: Some dishes must be turned or stirred half way through cooking: the oven will emit an acoustic signal and the display will indicate what action is required.**

**The initial cooking time displayed is merely for guidance: it can be prolonged automatically during cooking.**

Shortly before cooking time finishes, the oven prompts you to check that the food is cooked to your satisfaction. If it is not, extra time can then be added manually using the buttons .

## SHORTCUTS

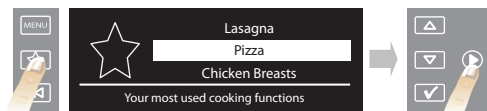

1. Press button : the display shows the 10 most used functions.
2. To scroll down the list, use buttons .
3. Press to select the desired function.
4. To change the settings of the selected function, proceed as shown in the previous paragraphs.





## SETTINGS

1. To change some display settings, select “SETTINGS” from the main menu using buttons .
2. Confirm by pressing : the display shows which settings can be changed (language, volume of acoustic signal, display brightness, time, energy saving function).
3. Select the setting you wish to change using buttons .
4. Press button to confirm.
5. Follow the instructions of the display to change the settings.
6. Press button ; a message appears on the display confirming your selection.

**N.B.:** When the oven is switched off, if the ECOMODE (Energy saving) function is selected (ON), the display switches off after a few seconds, showing the clock. To view information on the display and switch the light on again, just press any keys or turn one of the knobs. During a cooking function if the ECOMODE is activated the cavity lamp will be switched off after 1 minute of cooking and reactivated for each user interaction. If, on the other hand, the function is not selected (OFF), after a few minutes the display is merely dimmed.

## KEY-LOCK

This function can be used to lock the control panel buttons.

To activate it, press  and  at the same time for at least 3 seconds. If activated, the functions of the buttons are locked and the display shows a message and the symbol . This function can also be activated during cooking. To deactivate it, repeat the above procedure. When the key-lock function is activated, the oven can be switched off using button .



## STARCLEAN™ CLEANING CYCLE

To keep the oven in best condition, carry out the **STARCLEAN™** cleaning cycle after each use. The cycle takes 35 minutes, including a cooling stage, and must be carried out as follows:

For the description of this function, see the chapter CLEANING and the functions table on page 14.

1. Proceed with oven cold.
2. Wet the cellulose cloth provided under running water and wring it out so that it does not drip.
3. Open the oven door and remove the enamelled accessories.
4. Cover the bottom of the oven completely with the cellulose cloth.
5. Distribute 350 ml of water evenly on the cellulose cloth. A smaller or greater amount of water could compromise proper functioning of the cycle.
6. Close the oven door.

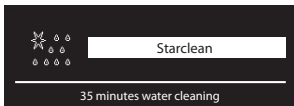

To start the oven cleaning cycle, proceed as follows:

1. Select STARCLEAN™ from the main menu with the buttons  and .

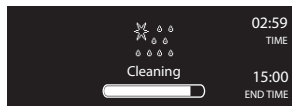
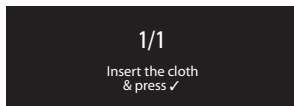

2. Press button , the display shows:



3. Press button : the help message appears, press button  to confirm and the cleaning cycle starts. **IMPORTANT: To prevent steam coming out, do not open the door during the cycle.**

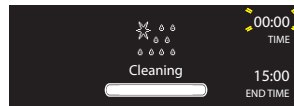

4. At the end of the cycle, remove the cellulose cloth and eliminate any residual water in the oven.
5. Then start cleaning using a sponge, moistened with hot water (cleaning could be compromised if delayed by more than 15 minutes).











### Particularly stubborn grime







To eliminate particularly stubborn grime, repeat the STARCLEAN™ cycle and add a few drops of neutral detergent while removing the grime.



## FUNCTION DESCRIPTION TABLE



















### MAIN MENU







	<b>SETTINGS</b>	Setting the display (language, time, brightness, volume of acoustic signal, energy saving function).
	<b>RECIPES</b>	Selecting 30 different pre-set recipes (see enclosed recipe booklet). The oven automatically sets the optimum cooking temperature, function and time. It is important to follow the instructions given in the recipe book regarding preparation, accessories and which oven shelf to use.
	<b>STARCLEAN™</b>	To eliminate the dirt created by cooking by means of a low temperature cycle. The combined action of the special enamel and the water released by the cellulose cloth during the cycle facilitates removal of grime. Activate the function when the oven is cold.
	<b>TRADITIONAL</b>	see TRADITIONAL FUNCTIONS.
	<b>SPECIALS</b>	see SPECIAL FUNCTIONS.
<b>TRADITIONAL FUNCTIONS</b>		
	<b>FAST PREHEATING</b>	To preheat the oven rapidly.
	<b>CONVENTIONAL</b>	To cook any kind of dish on one shelf only. Use the 3rd shelf. To cook pizza, savoury pies and sweets with liquid fillings, use the 1st or 2nd shelf. The oven does not have to be preheated.
	<b>GRILL</b>	To grill steak, kebabs and sausages; to cook vegetables au gratin and toast bread. Place food on the 4th or 5th shelf. When grilling meat, use the drip tray to collect the cooking juices. Position it on the 3rd/4th shelf, adding approx. half a litre of water. The oven does not have to be preheated. During cooking the oven door must remain closed.
	<b>TURBO GRILL</b>	To roast large joints of meat (legs, roast beef, chickens). Position the food on the middle shelves. Use the drip tray to collect the cooking juices. Position it on the 1st/2nd shelf, adding approx. half a litre of water. The oven does not have to be preheated. During cooking the oven door must remain closed. With this function you can also use the turnspit, if provided.
	<b>FORCED AIR</b>	To cook a variety of food requiring the same cooking temperature on several shelves (maximum three) at the same time (e.g.: fish, vegetables, cakes). This function can be used to cook different foods without odours being transferred from one food to another. Use the 3rd shelf to cook on one shelf only, the 1st and 4th to cook on two shelves, and the 1st, 3rd and 5th to cook on three shelves. The oven does not have to be preheated.
	<b>CONVECTION BAKE</b>	To cook meat and pies with liquid filling (savoury or sweet) on a single shelf. Use the 3rd shelf. The oven does not have to be preheated.

<b>SPECIAL</b>		
	<b>DEFROST</b>	To speed up defrosting of food. Place food on the middle shelf. Leave food in its packaging in order to prevent it from drying out on the outside.
	<b>KEEP WARM</b>	For keeping just-cooked food hot and crisp (e.g: meat, fried food or flans). Place food on the middle shelf. The function will not activate if the temperature in the oven is above 65°C.
	<b>RISING</b>	For optimal rising of sweet or savoury dough. To safeguard the quality of proving, the function will not activate if the temperature in the oven is above 40°C. Place the dough on the 2nd shelf. The oven does not have to be preheated.
	<b>CONVENIENCE</b>	Cooking ready meals kept at room temperature or from refrigerated cabinets (biscuits, liquid cake mixtures, muffins, first courses and bakery products). This function gently cooks all food quickly; it can also be used to reheat cooked food. Follow the instructions on the food packaging. The oven does not have to be preheated.
	<b>MAXI COOKING</b>	To cook large joints of meat (above 2.5 kg). Use the 1st or 2nd shelves, depending on the size of the joint. The oven does not have to be preheated. It is advisable to turn the meat over during cooking, to obtain even browning on both sides. It is preferable to baste the meat every now and again so that it does not become too dry.
	<b>FROZEN FOOD</b>	<b>Lasagne</b>
		<b>Pizza</b>
		<b>Strudel</b>
		<b>French Fries</b>
		<b>Bread</b>
	<b>Custom</b>	The temperature can be set from 50 to 250°C to cook other types of product.
	<b>ECO FORCED AIR</b>	To cook stuffed roasts and meat in pieces on one shelf. This function uses discontinuous, delicate fan assistance, which prevents excessive drying of foods. In this ECO function the light remains off during cooking and can be temporarily switched on again by pressing the confirm button. In order to maximize energy efficiency, it is advisable not to open the door during cooking. It is advisable to use 3rd level. The oven does not have to be preheated.

## COOKING TABLE















Recipe	Function	Pre-heating	Shelf (from bottom)	Temp. (°C)	Time (min)	Accessories and notes
Leavened cakes		-	2/3	160-180	30-90	Cake tin on rack
		-	1-4	160-180	30-90	Level 4: cake tin on rack Level 1: cake tin on rack
Filled pies (cheesecake, strudel, apple pie)		-	3	160-200	35-90	Drip-tray / baking tray or cake tin on rack
		-	1-4	160-200	40-90	Level 4: cake tin on rack Level 1: cake tin on rack
Biscuits/Tartlets		-	3	170-180	20-45	Drip-tray or baking tray
		-	1-4	160-170	20-45	Level 4: rack Level 1: drip-tray or baking tray
		-	1-3-5	160-170	20-45*	Level 5: pan on rack Level 3: pan on rack Level 1: drip-tray or baking tray
Choux buns		-	3	180-200	30-40	Drip-tray or baking tray
		-	1-4	180-190	35-45	Level 4: pan on rack Level 1: drip-tray or baking tray
		-	1-3-5	180-190	35-45*	Level 5: pan on rack Level 3: pan on rack Level 1: drip-tray or baking tray
Meringues		-	3	90	110-150	Drip-tray or baking tray
		-	1-4	90	140-160	Level 4: pan on rack Level 1: drip-tray or baking tray
		-	1-3-5	90	140-160*	Level 5: pan on rack Level 3: pan on rack Level 1: drip-tray or baking tray
Bread / Pizza / Focaccia		-	1/2	190-250	15-50	Drip-tray or baking tray
		-	1-4	190-250	20-50	Level 4: pan on rack Level 1: drip-tray or baking tray
		-	1-3-5	190-250	25-50*	Level 5: pan on rack Level 3: pan on rack Level 1: drip-tray or baking tray
Savoury pies (vegetable pie, quiche lorraine)		-	3	180-190	40-55	Cake tin on rack
		-	1-4	180-190	45-70	Level 4: cake tin on rack Level 1: cake tin on rack
		-	1-3-5	180-190	45-70*	Level 5: cake tin on rack Level 3: cake tin on rack Level 1: drip-tray or baking tray + cake tin

Recipe	Function	Pre-heating	Shelf (from bottom)	Temp. (°C)	Time (min)	Accessories and notes
<b>Vols-au-vent / Puff pastry savouries</b>		-	3	190-200	20-30	Drip-tray or baking tray
		-	1-4	180-190	20-40	Level 4: pan on rack Level 1: drip-tray or baking tray
		-	1-3-5	180-190	20-40*	Level 5: pan on rack Level 3: pan on rack Level 1: drip-tray or baking tray
		-				
<b>Lasagna / Baked pasta / Cannelloni / Flans</b>		-	3	190-200	45-55	Pan on rack
<b>Lamb / Veal / Beef / Pork 1 Kg</b>		-	3	190-200	80-110	Drip-tray or pan on rack
<b>Chicken / Rabbit / Duck 1 Kg</b>		-	3	200-230	50-100	Drip-tray or pan on rack
<b>Turkey / Goose 3 Kg</b>		-	2	190-200	80-130	Drip-tray or pan on rack
<b>Baked fish / en papillote (fillet, whole)</b>		-	3	180-200	40-60	Drip-tray or pan on rack
<b>Stuffed vegetables (tomatoes, courgettes, aubergines)</b>		-	2	180-200	50-60	Pan on rack
<b>Toast</b>		-	5	High	3-6	Rack
<b>Fish fillets / steaks</b>		-	4	Medium	20-30	Level 4: rack (turn food halfway through cooking) Level 3: drip-tray with water
<b>Sausages / Kebabs / Spare ribs / Hamburgers</b>		-	5	Medium-High	15-30	Level 5: rack (turn food halfway through cooking) Level 4: drip-tray with water
<b>Roast chicken 1-1.3 Kg</b>		-	2	Medium	55-70	Level 2: rack (turn food two thirds of the way through cooking) Level 1: drip-tray with water
		-	2	High	60-80	Level 2: turnspit (if present) Level 1: drip-tray with water
<b>Roast beef rare 1 Kg</b>		-	3	Medium	35-45	Pan on rack (turn food two thirds of the way through cooking if necessary)
<b>Leg of lamb / Shanks</b>		-	3	Medium	60-90	Drip-tray or pan on rack (turn food two thirds of the way through cooking if necessary)
<b>Baked potatoes</b>		-	3	Medium	45-55	Drip-tray or baking tray (turn food two thirds of the way through cooking if necessary)
<b>Vegetables au gratin</b>		-	3	High	10-15	Pan on rack
<b>Lasagna &amp; Meat</b>		-	1-4	200	50-100*	Level 4: pan on rack Level 1: drip-tray or pan on rack

Recipe	Function	Pre-heating	Shelf (from bottom)	Temp. (°C)	Time (min)	Accessories and notes
<b>Meat &amp; Potatoes</b>		-	1-4	200	45-100*	Level 4: pan on rack
						Level 1: drip-tray or pan on rack
<b>Fish &amp; Vegetables</b>		-	1-4	180	30-50*	Level 4: pan on rack
						Level 1: drip-tray or pan on rack
<b>Complete meal: Tart (Level 5) / Lasagna (Level 3) / Meat (Level 1)</b>		-	1-3-5	190	40-120*	Level 5: pan on rack
						Level 3: pan on rack
						Level 1: drip-tray or pan on rack
<b>Frozen pizza</b>		-	3	Auto	10-15	Drip-tray / baking tray or rack
		-	1-4	Auto	15-20	Level 4: pan on rack
		-	1-3-5	Auto	20-30	Level 5: pan on rack
		-	1-3-5	Auto	20-30	Level 3: drip-tray or baking tray
		-	1-3-5	Auto	20-30	Level 1: pan on rack
		-	1-3-4-5	Auto	20-30	Level 5: pan on rack
		-	1-3-4-5	Auto	20-30	Level 4: drip-tray or baking tray
		-	1-3-4-5	Auto	20-30	Level 3: drip-tray or baking tray
<b>Filled roast meats</b>		-	3	200	80-120*	Drip-tray or pan on rack
<b>Meat cuts (rabbit, chicken, lamb)</b>		-	3	200	50-100*	Drip-tray or pan on rack

\* Cooking time is approximate. Food can be removed from the oven at different times depending on personal preference.

**Table of Tested Recipes (in compliance with IEC 50304/60350:2009-03 and DIN 3360-12:07:07)**

Recipe	Function	Pre-heating	Shelf (from bottom)	Temp. (°C)	Time (min)	Accessories and notes
<b>IEC 60350:2009-03 § 8.4.1</b>						
Shortbread		-	3	170	15-30	Drip tray / baking tray
		-	1-4	160	20-35	Shelf 4: baking tray Shelf 1: drip tray
<b>IEC 60350:2009-03 § 8.4.2</b>						
Small cakes		-	3	170	25-35	Drip tray / baking tray
		-	1-4	160	30-40	Shelf 4: baking tray Shelf 1: drip tray
<b>IEC 60350:2009-03 § 8.5.1</b>						
Fatless sponge cake		-	2	170	30-40	Cake tin on wire shelf
<b>IEC 60350:2009-03 § 8.5.2</b>						
Two apple pies		-	2/3	185	70-90	Cake tin on wire shelf
		-	1-4	175	75-95	Shelf 4: cake tin on wire shelf Shelf 1: cake tin on wire shelf
<b>IEC 60350:2009-03 § 9.1.1</b>						
Toast**		-	5	High	3-6	Wire shelf
<b>IEC 60350:2009-03 § 9.2.1</b>						
Burgers**		-	5	High	18-30	Shelf 5: wire tray (turn food halfway through cooking) Shelf 4: drip tray with water
<b>DIN 3360-12:07 § 6.5.2.3</b>						
Apple cake, yeast tray cake		-	3	180	35-45	Drip tray / baking tray
		-	1-4	160	55-65	Shelf 4: baking tray Shelf 1: drip tray
<b>DIN 3360-12:07 § 6.6</b>						
Roast pork		-	2	170	110-150	Shelf 2: drip tray
<b>DIN 3360-12:07 annex C</b>						
Flat cake		-	3	170	40-50	Drip tray / baking tray
		-	1-4	160	45-55	Shelf 4: baking tray Shelf 1: drip tray

The cooking table suggests the ideal functions and temperatures to ensure the best results with all recipes. If you wish to cook on one shelf only using the fan-assisted function, place food on the third shelf and select the temperature recommended for the "FORCED AIR" function on more than one shelf.

**The indications in the table are without use of the runners. Do the tests without the runners.**

\*\* When grilling food, it is advisable leave a space of 3-4 cm from the front edge of the grill to facilitate removal

#### **Energy efficiency class (according to EN50304)**

To do the test, use the dedicated table

#### **Energy consumption and preheating time**

Select the function and do the test only with the "Preheating" option activated ("Preheating yes").

#### **Control Accuracy test**

Select the function and do the test only with the "Preheating" option deactivated (when preheating is activated, the oven control intentionally creates an oscillation of the temperature profile).

## RECOMMENDED USE AND TIPS

### How to read the cooking table

The table indicates the best function to use for any given food, to be cooked on one or more shelves at the same time. Cooking times start from the moment food is placed in the oven, excluding pre-heating (where required). Cooking temperatures and times are purely for guidance and will depend on the amount of food and type of accessory used. Use the lowest recommended values to begin with and, if the food is not cooked enough, then move on to higher values. Use the accessories supplied and preferably dark coloured metal cake tins and oven trays. You can also use pans and accessories in pyrex or stoneware, but bear in mind that cooking times will be slightly longer. To obtain best results, carefully follow the advice given in the cooking table for the choice of accessories (supplied) to be placed on the various shelves.

### Cooking different foods at the same time

Using the "FORCED AIR" function, you can cook different foods which require the same cooking temperature at the same time (for example: fish and vegetables), using different shelves. Remove the food which requires less cooking time and leave food which requires longer cooking time in the oven.

### Desserts

- Cook delicate desserts with the conventional function on one shelf only. Use dark coloured metal cake tins and always position them on the wire shelf supplied. To cook on more than one shelf, select the forced air function and stagger the position of the cake tins on the shelves, aiding optimum circulation of the hot air.
- To check whether a raising cake is cooked, insert a wooden toothpick into the centre of the cake. If the toothpick comes out clean, the cake is ready.
- If using non-stick cake tins, do not butter the edges as the cake may not rise evenly around the edges.
- If the cake "sinks" during cooking, set a lower temperature the next time, perhaps reducing the amount of liquid in the mixture and mixing more gently.
- For sweets with moist fillings (cheesecake or fruit pies) use the "CONVECTION BAKE" function". If the base of the cake is soggy, lower the shelf and sprinkle the bottom of the cake with breadcrumbs or biscuit crumbs before adding the filling.

### Meat

- Use any kind of oven tray or pyrex dish suited to the size of the piece of meat being cooked. For roast joints, it is best to add some stock to the bottom of the pan, basting the meat during cooking for added flavour. When the roast is ready, let it rest in the oven for another 10-15 minutes, or wrap it in aluminium foil.
- When you want to grill meat, choose cuts with an even thickness all over in order to achieve uniform cooking results. Very thick pieces of meat require longer cooking times. To prevent the meat from burning on the outside, lower the position of the wire shelf, keeping the food farther away from the grill. Turn the meat two thirds of the way through cooking.

To collect the cooking juices it is advisable to place a drip-tray with half a litre of water directly under the grill on which the meat is placed. Top-up when necessary.

### Turnspit (only in some models)

Use this accessory to evenly roast large pieces of meat and poultry. Place the meat on the spit rod, tying it with string if chicken, and check that it is secure before inserting the rod in the seat located on the front wall of the oven and resting it on the respective support. To prevent smoke and to collect cooking juices, it is advisable to place a drip-tray with half a litre of water on the first level. The rod has a plastic handle which must be removed before starting to cook, and used at the end of cooking to avoid burns when taking the food out of the oven.

### Pizza

Lightly grease the trays to ensure the pizza has a crispy base. Scatter the mozzarella over the pizza two thirds of the way through cooking.

### Rising function

It is always best to cover the dough with a damp cloth before placing it in the oven. Dough proving time with this function is reduced by approximately one third compared to proving at room temperature (20-25°C). Proving time for a 1 Kg batch of pizza dough is around one hour.





Printed in Italy  
02/2012

**5019 300 00543**

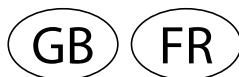

Whirlpool is a registered trademark of Whirlpool, USA