



SAMSUNG

Quick Start Manual

WB550/560



For more information, refer to the User Manual included on the supplied **CD-ROM**.

This Quick Start Manual has been specially designed to guide you through the basic functions and features of your device. Please read the Quick Start Manual and User Manual carefully to ensure safe and correct use.

ENG / GER / FRE / SPA / ITA / DUT / POR

Contents



Health and safety information.....	2	2
Camera layout	4	8
Setting up your camera	5	
Unpacking	5	7
Inserting the battery and memory card	6	15
Charging the battery	6	14
Turning on your camera	7	18
Selecting options	7	40
Capturing photos or videos	8	20
Playing files	9	56
Transferring files to a PC (Windows)	10	98
Specifications	11	105

Health and safety information



Warnings

Do not use your camera near flammable or explosive gases and liquids

Do not use your camera near fuels, combustibles, or flammable chemicals. Do not store or carry flammable liquids, gases, or explosive materials in the same compartment as the camera or its accessories.

Keep your camera away from small children and pets

Keep your camera and all accessories out of the reach of small children and animals. Small parts may cause choking or serious injury if swallowed. Moving parts and accessories may present physical dangers as well.

Prevent damage to subjects' eyesight

Do not use the flash in close proximity (closer than 1m/3 ft) to people or animals. Using the flash too close to your subject's eyes can cause temporary or permanent damage.

Handle and dispose of batteries and chargers with care

- Use only Samsung-approved batteries and chargers. Incompatible batteries and chargers can cause serious injuries or damage to your camera.
- Never place batteries or cameras on or in heating devices, such as microwave ovens, stoves, or radiators. Batteries may explode when overheated.



Cautions

Handle and store your camera carefully and sensibly

- Do not allow your camera to get wet—liquids can cause serious damage. Do not handle your camera with wet hands. Water damage to your camera can void your manufacturer's warranty.
- Avoid using or storing your camera in dusty, dirty, humid, or poorly-ventilated areas to prevent damage to moving parts and internal components.

- Exercise caution when connecting cables or adapters and installing batteries and memory cards. Forcing the connectors, improperly connecting cables, or improperly installing batteries and memory cards can damage ports, connectors, and accessories.
- Do not insert foreign objects into any of your camera's compartments, slots, or access points. This type of damage may not be covered by your warranty.

Protect batteries, chargers, and memory cards from damage

- Avoid exposing batteries or memory cards to very cold or very hot temperatures (below 0° C/32° F or above 40° C/104° F). Extreme temperatures can reduce the charging capacity of your batteries and can cause memory cards to malfunction.
- Prevent memory cards from making contact with liquids, dirt, or foreign substances. If dirty, wipe the memory card clean with a soft cloth before inserting in your camera.

Camera layout

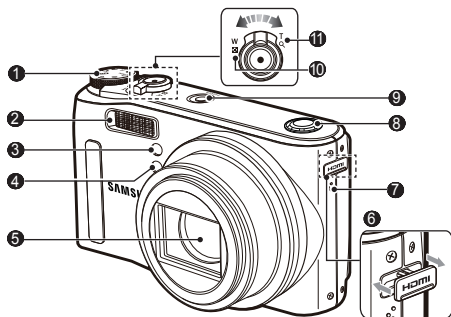

- 1 Mode dial
- 2 Flash
- 3 AF sensor/Self-timer lamp
- 4 Remote control sensor
- 5 Lens
- 6 HDMI connection terminal
- 7 Microphone
- 8 Speaker
- 9 POWER button
- 10 Zoom W Lever (Thumbnail)
- 11 Zoom T Lever (Digital zoom)

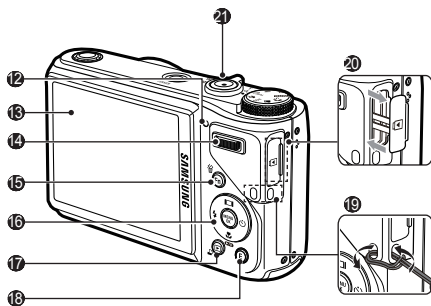

- 12 Camera status lamp
- 13 LCD monitor
- 14 Command Lever
- 15 Fn / Delete button
- 16 5-function button
- 17 Play mode /Print button
- 18 E (Effect) button
- 19 Camera strap
- 20 USB / AV / DC terminal
- 21 Shutter button

Setting up your camera

Unpacking



Camera



AC adapter/
USB cable



Rechargeable battery



Strap

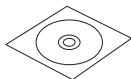

Software CD-ROM
(User manual included)



Quick Start Manual

Optional accessories



Camera case



Memory cards



Remote control

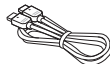

HDMI cable

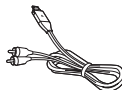

A/V cable

Setting up your camera

Inserting the battery and memory card

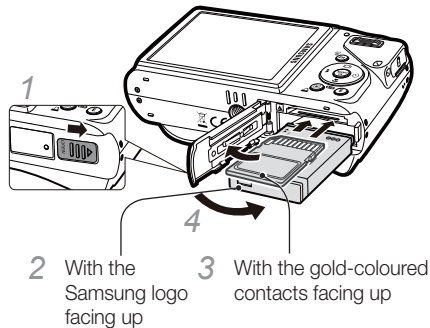

▼ Removing the battery

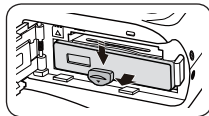

▼ Removing the memory card

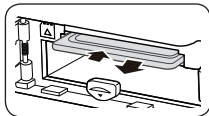

Push gently until the card disengages from the camera and then pull it out of the slot.

Charging the battery

Before using the camera for the first time, you must charge the battery.

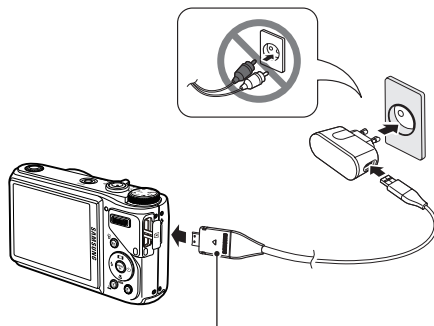

Indicator light

- Red: Charging
- Green: Fully charged

Turning on your camera

- 1 Press **[POWER]**.
 - The initial setup screen appears.

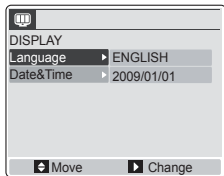

- 2 Press **[↶]**.
- 3 Press **[■]** or **[⬇]** to select a language and press **[OK]**.
- 4 Press **[■]** or **[⬇]** to select **Date & Time** and press **[↶]**.
- 5 Press **[⚡]** or **[↶]** to select an item.
- 6 Press **[■]** or **[⬇]** to change the number or select another date format and press **[OK]**.

Selecting options

- 1 In Shooting mode, press **[Fn]**.
- 2 Use the navigation buttons to scroll to an option or menu.

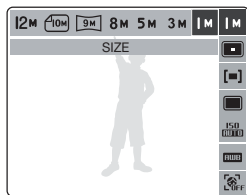

- To move left or right, press **[⚡]** or **[↶]**.
 - To move up or down, press **[■]** or **[⬇]**.
- 3 Press **[OK]** to confirm the highlighted option or menu.
 - Press **[Fn]** again to go back to the previous menu.

Capturing photos or videos

Taking a photo

- 1 Rotate the mode dial to **AUTO**.
- 2 Align your subject in the frame.
- 3 Press **[Shutter]** halfway down to focus automatically.
 - A green frame means the subject in focus.

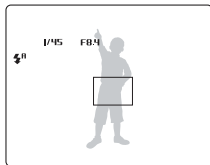

- 4 Press **[Shutter]** all the way down to take the photo.

Recording a video

- 1 Rotate the mode dial to **📹**.
- 2 Align your subject in the frame.
- 3 Press **[Shutter]**.
 - Press **[🛑]** to pause or resume.
- 4 Press **[Shutter]** again to stop the recording.

Note

Number of photos by resolution (for 1 GB SD)

	Resolution	Super fine	Fine	Normal
12M	4000 x 3000	147	285	404
10M	3984 x 2656	168	314	442
9M	3968 x 2232	203	368	529
8M	3264 x 2448	212	375	538
5M	2592 x 1944	334	558	780
3M	2048 x 1536	524	790	1,049
1M	1024 x 768	1,449	1,645	1,845

These figures are measured under Samsung's standard conditions and may vary depending on shooting conditions and camera settings.

Playing files

Viewing photos

- 1 Press [▶].
- 2 Press [⚡] or [⌛] to scroll through files.
 - Press and hold to view files quickly.

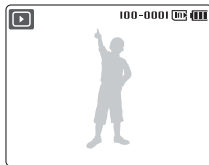

Viewing videos

- 1 Press [▶].
- 2 Press [🌸].

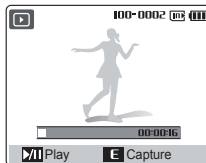

- 3 Use the following buttons to control playback.



Scan backward



Pause or resume playback



Scan forward

[Command Lever]

left or right

Adjust the volume level

Transferring files to a PC (Windows)

- 1 Insert the installation CD in a CD-ROM drive and follow the onscreen instructions.
- 2 Connect the camera to the PC with the USB cable.

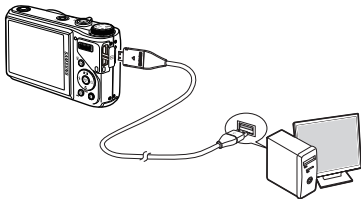

- 3 Turn on the camera.
- 4 On your PC, select **My Computer** → **Removable Disk** → **DCIM** → **100SSCAM**.
- 5 Select the files you want and drag or save them to the PC.

Disconnecting safely (for Windows XP)



Click



Click

Specifications

Image sensor	<ul style="list-style-type: none"> Type: 1/2.33" (approx. 1.09 cm) CCD Effective pixels: approx. 12.2 mega-pixels Total pixels: approx. 12.4 mega-pixels
Lens	<ul style="list-style-type: none"> Focal length: Schneider lens f = 4.2 - 42.0 mm (35 mm film equivalent: 24 - 240 mm) F-stop range: F3.3 (W) - F5.8 (T)
Display	3.0" QVGA TFT LCD (230,000 pixel)
Focusing	TTL auto focus (Multi-AF, Center AF, Manual Focus, Selection AF, Face Detection AF)
Shutter speed	<ul style="list-style-type: none"> Auto: 1/8 ~ 1/1,500 sec Program: 1 ~ 1/1,500 sec Manual: 16 ~ 1/1,500 sec Nightscene: 8 ~ 1/1,500 sec Firework: 4 sec
Storage	<ul style="list-style-type: none"> Internal memory: approx. 21 MB External memory (Optional): SD card (up to 4 GB guaranteed), SDHC card (up to 8 GB guaranteed), MMC Plus (Up to 2GB guaranteed, 4bit 20MHz) <p>Internal memory capacity may not match these specifications.</p>
DC power input connector	20 pin
Rechargeable battery	Lithium-ion battery (SLB-10A, 1,050 mAh)
Dimensions (W x H x D)	105 x 61.4 x 36.5 mm
Weight	225 g (without battery and memory card)
Operating temperature	0 - 40° C
Operating humidity	5 - 85 %

Inhalt



Hinweise zu Sicherheit und Gesundheit	2	2
Aufbau der Kamera	4	8
Inbetriebnahme der Kamera	5	
Auspacken	5	7
Akku und Speicherkarte einsetzen	6	15
Akku aufladen	6	14
Kamera einschalten	7	18
Optionen auswählen	7	40
Fotos und Videos aufnehmen	8	20
Dateien wiedergeben	9	56
Dateien auf einen PC (Windows) übertragen	10	98
Technische Daten	11	105

Hinweise zu Sicherheit und Gesundheit



Warnungen

Verwenden Sie die Kamera nicht in der Nähe von leicht entzündlichen oder explosionsgefährdeten Gasen oder Flüssigkeiten

Verwenden Sie die Kamera nicht in der Nähe Kraftstoffen, brennbaren Materialien oder entzündlichen Chemikalien. Lagern und transportieren Sie entzündliche Flüssigkeiten, Gase oder explosive Materialien nicht am selben Platz, an dem sich die Kamera oder ihr Zubehör befindet.

Halten Sie Kleinkinder und Haustiere von Ihrer Kamera fern

Achten Sie darauf, dass die Kamera und sämtliches Zubehör nicht in die Reichweite kleiner Kinder oder Haustiere gelangen. Kleine Teile können zum Ersticken oder schweren Verletzungen beim Verschlucken führen. Auch bewegliche Teile und Zubehörteile können Gefahren darstellen.

Verhindern Sie Augenschäden bei aufgenommenen Lebewesen

Verwenden Sie den Blitz nicht zu nahe (nicht näher als 1 m) an den Augen von Menschen und Tieren. Wenn der Blitz zu nahe bei den Augen eingesetzt wird, kann dies zu vorübergehenden oder dauerhaften Sehschäden führen.



Behandeln und entsorgen Sie Akkus und Ladegeräte mit Sorgfalt

- Verwenden Sie nur von Samsung zugelassene Akkus und Ladegeräte. Inkompatible Akkus und Ladegeräte können schwere Verletzungen bzw. Schäden an der Kamera verursachen.
- Legen Sie weder Akkus noch die Kamera auf oder in Heizgeräte wie Mikrowellen, Öfen oder Heizkörper. Die Akkus können dadurch überhitzen und explodieren!



Achtung

Behandeln und lagern Sie die Kamera sorgfältig und vernünftig

- Lassen Sie Ihre Kamera nicht nass werden
– Flüssigkeiten können schwere Schäden hervorrufen. Fassen Sie die Kamera nicht mit nassen Händen an. Wasser beschädigt die Kamera und kann zum Erlöschen der Herstellergarantie führen.
- Bewahren Sie die Kamera nicht in staubigen, schmutzigen, feuchten oder schlecht belüfteten Bereichen auf, damit die beweglichen Teile und inneren Komponenten keinen Schaden nehmen.

- Wenden Sie Sorgfalt an, wenn Sie Kabel oder Adapter anschließen oder Akkus oder Speicherkarten einsetzen. Gewaltames Einstecken von Steckern, falsche Verbindungskabel oder unsachgemäß eingesetzte Akkus und Speicherkarten können Anschlüsse, Steckverbinder und Zubehörteile beschädigen.
- Stecken Sie keine Fremdkörper in die Fächer, Steckplätze oder Zugangspunkte der Kamera. Schäden dieser Art werden unter Umständen nicht von der Garantie abgedeckt.

Schützen Sie Akkus, Ladegeräte und Speicherkarten vor Beschädigung

- Setzen Sie Akkus und Speicherkarten keinen sehr niedrigen oder sehr hohen Temperaturen aus (unter 0 °C oder über 40 °C). Extreme Temperaturen können die Ladekapazität von Akkus reduzieren und Fehlfunktionen von Speicherkarten verursachen.
- Vermeiden Sie Kontakt von Speicherkarten mit Flüssigkeiten, Schmutz oder Fremdkörpern. Wenn die Speicherkarte verschmutzt ist, reinigen Sie sie vor dem Einsetzen in Ihre Kamera mit einem weichen Tuch.

Aufbau der Kamera

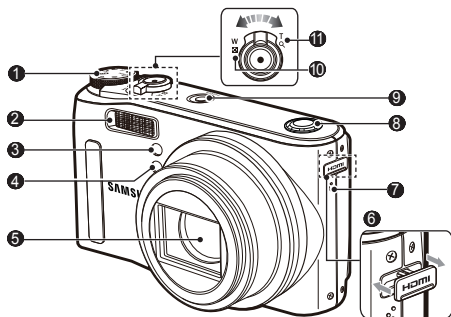

- 1 | Betriebsarten-Einstellrad
- 2 | Blitz
- 3 | AF-Sensor / Selbstauslöser-Lampe
- 4 | Fernbedienungssensor
- 5 | Objektiv
- 6 | HDMI-Anschluss
- 7 | Mikrofon
- 8 | Lautsprecher
- 9 | POWER-Taste
- 10 | Zoom-W-Hebel (Miniaturansicht)
- 11 | Zoom-T-Hebel (Digitalzoom)

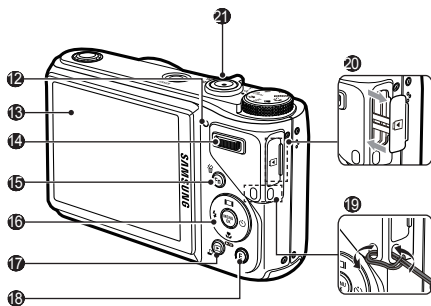

- 12 | Kamerastatuslampe
- 13 | LCD-Monitor
- 14 | Befehlshebel
- 15 | Fn / Löschtaste
- 16 | Steuerkreuz
- 17 | Wiedergabemodus- / Druck-Taste
- 18 | E-Taste (Effekt)
- 19 | Trageschleufe
- 20 | USB / AV / DC-Anschluss
- 21 | Auslöser

Inbetriebnahme der Kamera

Auspacken



Kamera



Netzteil/USB-Kabel



Akku



Trageriemen

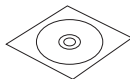

Software CD-ROM
(einschließlich
Benutzerhandbuch)



Kurzanleitung

Optionales Zubehör



Kameratasche



Speicherkarten



Fernbedienung

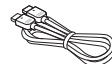

HDMI-Kabel

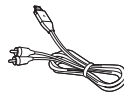

AV-Kabel

Inbetriebnahme der Kamera

Akku und Speicherkarte einsetzen

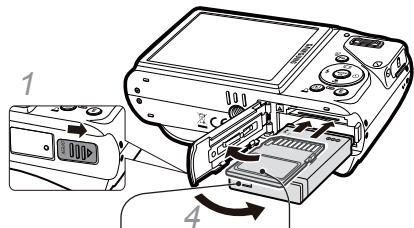

2 Mit dem Samsung-Logo nach obenweisend

3 Mit den goldfarbenen Kontakten nach obenweisend

▼ Akku entnehmen

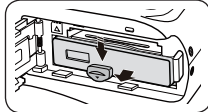

▼ Speicherkarte entnehmen

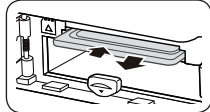

Drücken Sie vorsichtig gegen die Speicherkarte, so dass sie ausrastet, und ziehen Sie sie dann aus dem Speicherkarteneinschub.

DE-6

Akku aufladen

Bitte laden Sie den Akku unbedingt auf, bevor Sie die Kamera verwenden.

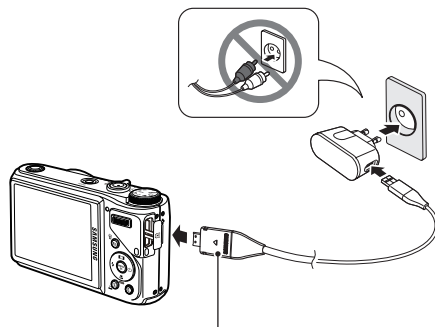

Anzeigelämpchen

- Rot: Aufladen
- Grün: Voll aufgeladen

Kamera einschalten

- 1 Drücken Sie **[POWER]**.
 - Der anfängliche Setup-Bildschirm wird angezeigt.

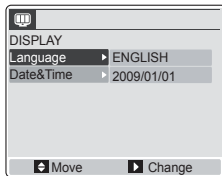

- 2 Drücken Sie **[↶]**.
- 3 Drücken Sie **[|■|]** oder **[⬇️]**, um eine Sprache auszuwählen, und drücken Sie **[OK]**.
- 4 Drücken Sie **[|■|]** oder **[⬇️]**, um **Date & Time** auszuwählen, und drücken Sie **[↶]**.
- 5 Drücken Sie **[⚡]** oder **[↶]**, um ein Element auszuwählen.
- 6 Drücken Sie **[|■|]** oder **[⬇️]**, um die Zahl zu verändern oder ein anderes Datumsformat auszuwählen, und drücken Sie **[OK]**.

Optionen auswählen

- 1 Drücken Sie im Aufnahmemodus **[Fn]**.
- 2 Benutzen Sie die Navigationstasten, um zu einer Option oder einem Menü zu blättern.

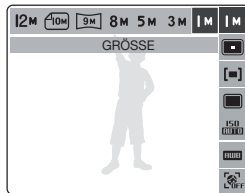

- 3 Drücken Sie **[OK]**, um die ausgewählte Option bzw. das Menü zu bestätigen.
 - Drücken Sie zur Bewegung nach rechts oder links **[↶]** oder **[↷]**.
 - Drücken Sie zur Bewegung nach oben oder unten **[|■|]** oder **[⬆️]**.
- 3 Drücken Sie **[OK]**, um die ausgewählte Option bzw. das Menü zu bestätigen.
 - Drücken Sie **[Fn]** erneut, um zum vorherigen Menü zurückzukehren.

Fotos und Videos aufnehmen

Fotografieren

- 1 Drehen Sie den Modus-Wählschalter auf **AUTO**.
- 2 Richten Sie Ihr Motiv im Rahmen aus.
- 3 Drücken Sie **[Auslöser]** zur Hälfte, um automatisch zu fokussieren.
 - Ein grüner Rahmen bedeutet, dass das Motiv scharfgestellt ist.

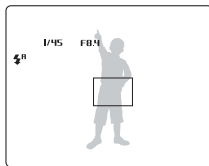

- 4 Drücken Sie **[Auslöser]** ganz, um das Foto zu erstellen.

Video aufzeichnen

- 1 Drehen Sie den Modus-Wählschalter auf **📹**.
- 2 Richten Sie Ihr Motiv im Rahmen aus.
- 3 Drücken Sie **[Auslöser]**.
 - Drücken Sie **[👆]**, um anzuhalten oder fortzufahren.
- 4 Drücken Sie **[Auslöser]** erneut, um die Aufnahme zu beenden.

Hinweis

Anzahl Fotos je nach Auflösung (für 1 GB SD)

	Auflösung	Superfein	Fein	Normal
12M	4000 x 3000	147	285	404
10M	3984 x 2656	168	314	442
9M	3968 x 2232	203	368	529
8M	3264 x 2448	212	375	538
5M	2592 x 1944	334	558	780
3M	2048 x 1536	524	790	1,049
1M	1024 x 768	1,449	1,645	1,845

Diese Zahlen wurden unter den Standardbedingungen von Samsung gemessen und können sich je nach Aufnahmebedingungen und Kameraeinstellungen unterscheiden.

Dateien wiedergeben

Fotos anzeigen

- 1 Drücken Sie [▶].
- 2 Drücken Sie [⚡] oder [⏪], um durch die Dateien zu blättern.
 - Halten Sie die Taste gedrückt, um die Dateien schnell anzuzeigen.

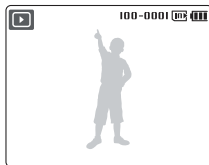

Videos anzeigen

- 1 Drücken Sie [▶].
- 2 Drücken Sie [👤].

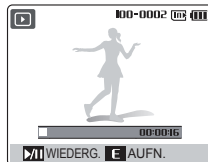

- 3 Steuern Sie die Wiedergabe mit folgenden Symbolen.

[⚡]	Rückwärtssuche
[👤]	Wiedergabe unterbrechen oder fortsetzen
[⏪]	Vorwärtssuche
Drücken Sie den Befehlshebel nach links oder rechts	Lautstärke einstellen

Dateien auf einen PC (Windows) übertragen

- 1 Legen Sie die Installations-CD in ein CD-ROM-Laufwerk ein und führen Sie die angezeigten Anweisungen aus.
- 2 Schließen Sie die Kamera mit dem USB-Kabel an den PC an.

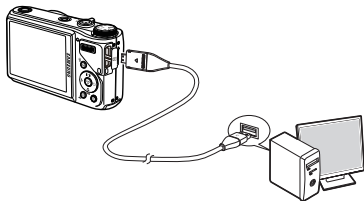

- 3 Schalten Sie die Kamera ein.
- 4 Wählen Sie auf Ihrem PC **Arbeitsplatz** → **Wechseldatenträger** → **DCIM** → **100SSCAM**.
- 5 Wählen Sie die gewünschten Dateien und ziehen oder speichern Sie sie auf den PC.

Sicheres Abtrennen (unter Windows XP)



Technische Daten

Bildsensor	<ul style="list-style-type: none">• Typ: 1/2,33" (ca. 1,09 cm) CCD• Effektive Pixel: ca. 12,2 Megapixel• Gesamtpixel: ca. 12,4 Megapixel
Objektiv	<ul style="list-style-type: none">• Brennweite: Samsung-Objektiv $f = 4,2 - 42,0$ mm (35-mm-Film-Äquivalent: 24 - 240 mm)• Blendenwertbereich: F3,3 (W) - F5,8 (T)
Display	3,0" QVGA TFT LCD (230.000 Pixel)
Scharfeinstellung	TTL autofokus (Multi-AF, Mitten-AF, Manueller Fokus, Auswahl AF, Gesichtserkennung AF)
Verschlusszeit	<ul style="list-style-type: none">• Automatik: 1/8 ~ 1/1.500 s• Programm: 1 ~ 1/1.500 s• Manuell: 16 ~ 1/1.500 s• Nacht: 8 ~ 1/1.500 s• Feuerwerk: 4 s
Speicher	<ul style="list-style-type: none">• Interner Speicher: ca. 21 MB• Externer Speicher (optional): SD-Karte (bis zu 4 GB garantiert), SDHC-Karte (bis zu 8 GB garantiert), MMC Plus (bis zu 2GB garantiert, 4bit 20MHz) Die interne Speicherkapazität kann von diesen Angaben abweichen.
Gleichstrom-Eingangsanschluss	20-polig
Akku	Lithium-Ionen-Akku (SLB-10A, 1.050 mAh)
Abmessungen (B x H x T)	105 x 61,4 x 36,5 mm
Gewicht	225 g (ohne Akku und Speicherkarte)
Betriebstemperatur	0 - 40 °C
Luftfeuchtigkeit während des Betriebs	5 - 85 %

Sommaire

Informations relatives à la santé et à la sécurité	2	2
Présentation de l'appareil photo	4	8
Assemblage de votre appareil photo	5	7
Contenu du coffret	5	
Insertion de la batterie et de la carte mémoire	6	15
Chargement de la batterie.....	6	14
Mise en route de l'appareil	7	18
Sélection des options	7	40
Prise de vues photo ou vidéo	8	20
Lecture de fichiers	9	56
Transfert de fichiers vers un PC (Windows)	10	98
Caractéristiques	11	105

Informations relatives à la santé et à la sécurité



Avertissements

N'utilisez pas l'appareil photo à proximité de gaz et de liquides inflammables ou explosifs

N'utilisez pas l'appareil à proximité de combustibles ou de produits chimiques inflammables. Ne transportez et ne stockez jamais de liquides inflammables, de gaz ou de matériaux explosifs dans le même emplacement que l'appareil ou ses accessoires.

Ne laissez pas l'appareil photo à la portée d'enfants en bas âge et d'animaux domestiques

Tenez l'appareil, ses pièces et ses accessoires, hors de portée des enfants en bas âge et des animaux. L'ingestion de petites pièces peut provoquer un étouffement ou des blessures graves. Les parties détachables et les accessoires représentent également un danger.

Évitez d'endommager la vue des sujets photographiés

N'utilisez pas le flash trop près (moins d'un mètre) des personnes et des animaux. L'utilisation du flash trop près des yeux du sujet peut provoquer des lésions temporaires ou permanentes.

Utilisez les batteries et les chargeurs avec précaution et respectez les consignes de recyclage

- Utilisez uniquement des batteries et des chargeurs Samsung. L'utilisation de batteries et de chargeurs incompatibles peut provoquer des blessures graves ou endommager votre appareil.
- Ne posez jamais les batteries ou l'appareil à l'intérieur ou au-dessus d'un dispositif chauffant, tel qu'un four à micro-ondes, une cuisinière ou un radiateur. En cas de surchauffe, les batteries risquent d'exploser.



Attention

Manipulez et stockez votre appareil avec soins

- Évitez tout contact avec des liquides qui risqueraient d'endommager sérieusement votre appareil photo. N'utilisez pas l'appareil avec les mains mouillées. L'eau peut endommager votre appareil photo et entraîner l'annulation de la garantie du fabricant.
- Évitez d'utiliser et de stocker votre appareil dans un endroit poussiéreux, sale, humide ou mal ventilé afin de ne pas endommager ses composants internes.

- Lors du branchement des cordons et du chargeur et de l'insertion des batteries et des cartes mémoire, agissez prudemment. Enfoncer les cordons avec force ou sans précaution et insérer les batteries et les cartes mémoire de manière incorrecte peut endommager les prises et les accessoires.
- N'introduisez pas de corps étrangers dans les compartiments, les logements ou les ouvertures de l'appareil photo. Les dysfonctionnements qui s'en suivraient ne seront pas couverts par votre garantie.

Protégez les batteries, les chargeurs et les cartes mémoire

- Évitez d'exposer les batteries et les cartes mémoire à des températures extrêmes (inférieures à 0 °C / 32 °F ou supérieures à 40 °C / 104 °F). Les températures extrêmes peuvent réduire les capacités de chargement des batteries et provoquer des dysfonctionnements des cartes mémoire.
- Évitez tout contact des cartes mémoire avec des liquides, de la poussière ou des corps étrangers. Si la carte mémoire est sale, nettoyez-la avec un chiffon doux avant de l'introduire dans l'appareil photo.

Présentation de l'appareil photo

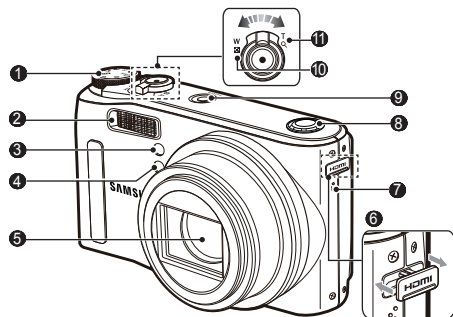

- 1 Molette de réglage
- 2 Flash
- 3 Capteur de mise au point / Voyant Retardateur
- 4 Capteur télécommande
- 5 Objectif
- 6 HDMI connection terminal
- 7 Microphone
- 8 Haut-parleur
- 9 Interrupteur de marche/arrêt
- 10 Levier Zoom W (Aperçu)
- 11 Levier Zoom T (Zoom numérique)

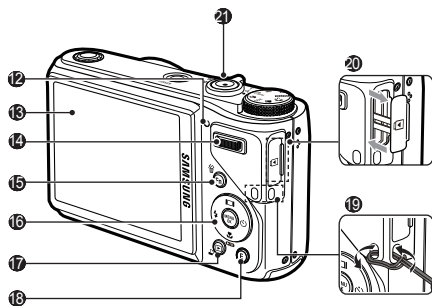

- 12 Voyant d'état de l'appareil photo
- 13 Ecran LCD
- 14 Levier de commande
- 15 Touche Fn/Supprimer
- 16 Touche multifonction
- 17 Mode de lecture / Touche Impression
- 18 Touche E (Effet)
- 19 Dragonne
- 20 USB / AV / CC / Ecouteurs
- 21 Déclencheur

FR-4

Assemblage de votre appareil photo

Contenu du coffret



Appareil photo



Adaptateur secteur/
Câble USB



Batterie rechargeable



Dragonne

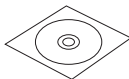

CD-ROM
(Manuel d'utilisation inclus)



Manuel de démarrage
rapide

Accessoires en option



Etui de l'appareil photo



Cartes mémoire



Télécommande

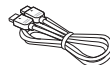

Câble HDMI



Câble audio/vidéo

Assemblage de votre appareil photo

Insertion de la batterie et de la carte mémoire

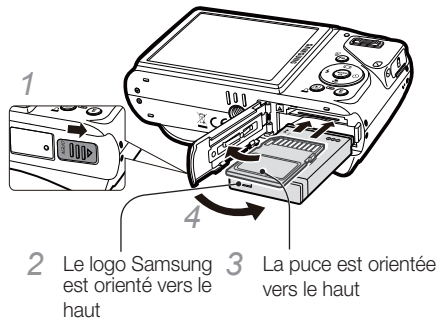

▼ Retrait de la batterie

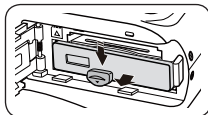

▼ Retrait de la carte mémoire

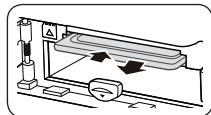

Appuyez doucement jusqu'à ce que la carte soit éjectée de sa trappe, puis retirez-la entièrement.

Chargement de la batterie

Assurez-vous de charger la batterie avant d'utiliser l'appareil photo.

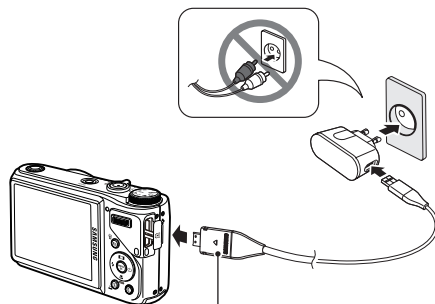

Voyant lumineux

- Rouge : en charge
- Vert : rechargé

Mise en route de l'appareil

- 1 Appuyez sur [POWER].
 - L'écran d'installation s'affiche.

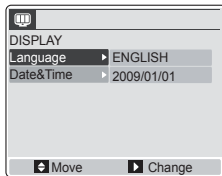

- 2 Appuyez sur [OK].
- 3 Appuyez sur [Left] ou sur [Up] pour sélectionner une langue, puis appuyez sur [OK].
- 4 Appuyez sur [Left] ou sur [Up] pour sélectionner **Date & Time**, puis appuyez sur [OK].
- 5 Appuyez sur [Left] ou sur [Up] pour sélectionner une option.
- 6 Appuyez sur [Left] ou sur [Up] pour changer de chiffre ou sélectionnez un autre format de date et appuyez sur [OK].

Sélection des options

- 1 En mode Prise de vue, appuyez sur [Fn].
- 2 Utilisez les touches de navigation pour atteindre une option ou un menu.

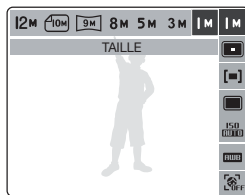

- 3 Pour confirmer le menu ou l'option en surbrillance, appuyez sur [OK].
 - Appuyez de nouveau sur [Fn] pour revenir au menu précédent.
- Pour vous déplacer à gauche ou à droite, appuyez sur [Left] ou [Right].
 - Pour vous déplacer en haut ou en bas, appuyez sur [Up] ou [Down].

Prise de vues photo ou vidéo

Prise de vues

- 1 À l'aide de la molette de réglage, choisissez le mode **AUTO**.
- 2 Cadrez le sujet à photographier.
- 3 Appuyez à mi-course sur le déclencheur pour une mise au point automatique.
 - Un cadre vert signifie que le sujet est mis au point.

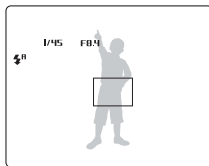

- 4 Appuyez à fond sur le déclencheur pour prendre la photo.

Filmer une séquence vidéo

- 1 À l'aide de la molette de réglage, choisissez le mode **📹**.
- 2 Cadrez le sujet à photographier.
- 3 Appuyez sur le déclencheur.
 - Appuyez sur [👆] pour marquer une pause ou reprendre.
- 4 Appuyez de nouveau sur le déclencheur pour arrêter l'enregistrement.

Remarque

Nombre de photos en fonction de la résolution (pour une carte SD de 1 Go)

	Résolution	Maximale	Élevée	Normale
12M	4000 x 3000	147	285	404
10M	3984 x 2656	168	314	442
9M	3968 x 2232	203	368	529
8M	3264 x 2448	212	375	538
5M	2592 x 1944	334	558	780
3M	2048 x 1536	524	790	1,049
1M	1024 x 768	1,449	1,645	1,845

Ces chiffres proviennent des mesures effectuées par Samsung dans des conditions normales. Ils peuvent varier en fonction des paramètres et des conditions de prise de vue.

Lecture de fichiers

Visionner des photos

- 1 Appuyez sur [▶].
- 2 Appuyez sur [⚡] ou sur [⌚] pour parcourir les fichiers.
 - Maintenez votre doigt appuyé pour un défilement rapide des fichiers.

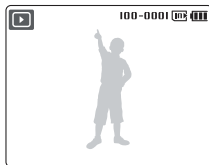

Affichage des vidéos

- 1 Appuyez sur [▶].
- 2 Appuyez sur [🌸].



- 3 Utilisez les touches suivantes pour contrôler la lecture.

[⚡]	Retour arrière
[🌸]	Mettre en pause ou reprendre après une pause
[⌚]	Avance rapide
Poussez le levier de commande vers la gauche ou la droite.	Réglage du niveau sonore

Transfert de fichiers vers un PC (Windows)

- 1 Insérez le CD d'installation dans un lecteur de CD-ROM, puis suivez les instructions qui s'affichent.
- 2 Branchez l'appareil au PC à l'aide du câble USB.

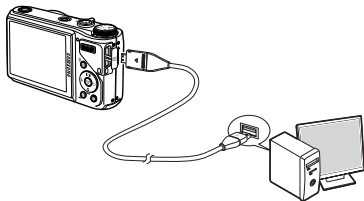

- 3 Allumez l'appareil photo.
- 4 Sur votre ordinateur, sélectionnez **Poste de travail** → **Disque amovible** → **DCIM** → **100SSCAM**.
- 5 Sélectionnez les fichiers de votre choix, puis copiez-les ou déplacez-les sur l'ordinateur.

Débranchement en toute sécurité (pour Windows XP)



Caractéristiques

Capteur d'images	<ul style="list-style-type: none">Type : CCD 1/2,33" (environ 1,09 cm)Pixels effectifs : Environ 12,2 mégapixelsNombre total de pixels : Environ 12,4 mégapixels
Objectif	<ul style="list-style-type: none">Distance focale : Objectif Samsung f= 4,2 - 42,0 mm (équivalent à un film 35 mm : 24 - 240 mm)Plage d'ouverture de l'objectif : F3,3 (W) - F5,8 (T)
Écran	QVGA TFT LCD 3,0" (230 000 pixels)
Mise au point	TTL mise au point automatique (Mise au p. multi, Mise au p. centre, Mise au point manuelle, Mise au point sélection, AF détection des visages)
Vitesse d'obturation	<ul style="list-style-type: none">Auto : 1/8 ~ 1/1 500 s.Programme : 1 ~ 1/1 500 s.Manuel : 16 ~ 1/1 500 s.Nuit : 8 ~ 1/1 500 s.Feux artificiels : 4 s.
Stockage	<ul style="list-style-type: none">Mémoire interne : Environ 21 MoMémoire externe (en option) : Carte SD (jusqu'à 4 Go garanti), carte SDHC (jusqu'à 8 Go garanti), MMC Plus (jusqu'à 2 Go garantis, 4 bits 20 MHz) <p>La capacité de la mémoire interne peut varier par rapport à ces caractéristiques.</p>
Connecteur d'alimentation CC	20 broches
Batterie rechargeable	Batterie lithium-ion (SLB-10A, 1 050 mAh)
Dimensions (l x h x p)	105 x 61,4 x 36,5 mm
Poids	225 g (sans la batterie ni la carte mémoire)
Température de fonctionnement	0 - 40°C
Humidité de fonctionnement	5 - 85 %

Contenido

Información sobre salud y seguridad	2	2
Diseño de la cámara	4	8
Configuración de la cámara	5	
Desembalaje	5	7
Insertar la batería y la tarjeta de memoria	6	15
Cargar la batería.....	6	14
Encender la cámara	7	18
Selección de opciones	7	40
Captura de fotografías o vídeos.....	8	20
Reproducción de archivos ...	9	56
Transferencia de archivos a un ordenador (para Windows) ...	10	98
Especificaciones	11	105

Información sobre salud y seguridad



Advertencias

No utilice la cámara cerca de líquidos y gases explosivos o inflamables

No utilice la cámara cerca de carburantes, combustibles o sustancias químicas inflamables. No almacene ni transporte líquidos inflamables, gases o materiales explosivos en el mismo compartimento en el que están la cámara o los accesorios.

Mantenga la cámara alejada del alcance de los niños y las mascotas

Mantenga la cámara y todos los accesorios fuera del alcance de los niños y los animales. Es posible que se traguen las piezas más pequeñas y, como consecuencia, se asfixien o sufran graves lesiones. Los accesorios y las piezas móviles también pueden causar daños físicos.

Evite dañar la vista del sujeto

No utilice el flash si está a una proximidad inferior a 1m de las personas o los animales. Si utiliza el flash cuando está demasiado cerca de los ojos del sujeto, puede producirle daños temporales o permanentes.

Utilice y deseche las baterías y los cargadores con cuidado

- Utilice únicamente baterías y cargadores aprobados por Samsung. Las baterías y los cargadores incompatibles pueden producirle graves lesiones o causar daños a la cámara.
- Nunca coloque las baterías o las cámaras dentro de dispositivos conductores de calor, como hornos de microondas, estufas o radiadores, ni sobre ellos. Las baterías pueden explotar si se recalientan.



Precauciones

Utilice y guarde la cámara con cuidado y de manera prudente

- No permita que la cámara se moje, ya que los líquidos pueden causarle graves daños. No manipule la cámara si tiene las manos mojadas. Si se producen daños en la cámara a causa del agua, se puede anular la garantía del fabricante.
- No utilice ni guarde la cámara en áreas en las que haya polvo, suciedad, humedad o poca ventilación, a fin de evitar daños en las partes móviles o en los componentes internos.

- Tenga cuidado al conectar los cables y los adaptadores y al instalar las baterías y las tarjetas de memoria. Si ejerce demasiada fuerza sobre los conectores, conecta de manera inapropiada los cables o instala de manera inadecuada las baterías y las tarjetas de memoria, puede dañar los puertos, los conectores y los accesorios.
- No inserte objetos extraños en ningún compartimento, ranura o punto de acceso de la cámara. Es posible que la garantía no cubra este tipo de daños.

Proteja las baterías, los cargadores y las tarjetas de memoria contra daños

- No exponga las baterías o las tarjetas de memoria a temperaturas demasiado bajas o demasiado altas (inferiores a 0 °C/32 °F o superiores a 40 °C/104 °F). Las temperaturas extremas pueden reducir la capacidad de carga de las baterías y generar un funcionamiento defectuoso de las tarjetas de memoria.
- Evite que las tarjetas de memoria entren en contacto con líquidos, suciedad o sustancias extrañas. Si la tarjeta de memoria se ensucia, límpiela con un paño suave antes de insertarla en la cámara.

Diseño de la cámara

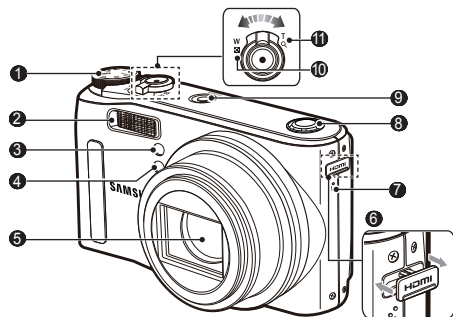

- 1 | Dial de modos
- 2 | Flash
- 3 | Lámpara del sensor AF / Disparador automático
- 4 | Sensor del mando a distancia
- 5 | Lente
- 6 | Terminal de conexión HDMI
- 7 | Micrófono
- 8 | Altavoz
- 9 | Botón POWER(Encendido)
- 10 | Palanca W de zoom (Miniatura)
- 11 | Palanca T de zoom (zoom digital)

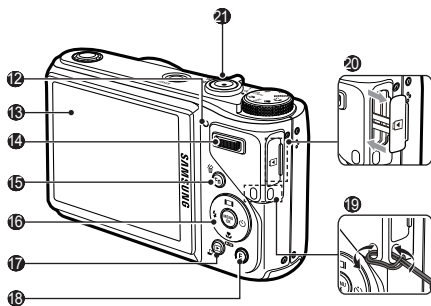

- 12 | Lámpara de estado de la cámara
- 13 | Monitor LCD
- 14 | Palanca de comando
- 15 | Botón Fn / Delete
- 16 | Botón de 5 funciones
- 17 | Botón de modo de reproducción / Imprimir
- 18 | Botón E (Efectos)
- 19 | Correa de la cámara fotográfica
- 20 | Terminal USB / AV / CC
- 21 | Botón Obturador

ES-4

Configuración de la cámara

Desembalaje



Cámara



Fuente de alimentación /
Cable USB



Batería recargable



Correa

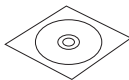

CD-ROM del software
(incluye el manual del usuario)



Manual de inicio rápido

Accesorios opcionales



Estuche para la
cámara



Tarjetas de memoria



Control remoto

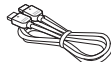

Cable HDMI

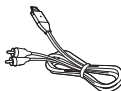

Cable AV

Configuración de la cámara

Insertar la batería y la tarjeta de memoria

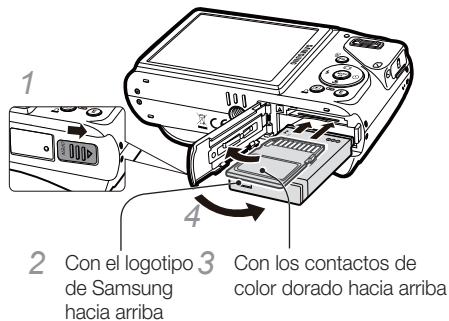

2 Con el logotipo de Samsung hacia arriba

3 Con los contactos de color dorado hacia arriba

▼ Quitar la batería

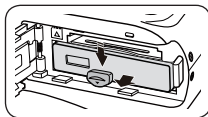

▼ Quitar la tarjeta de memoria

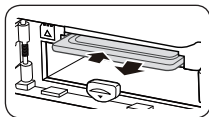

Ejerza una leve presión hasta que la tarjeta se desprenda de la cámara y, luego, retirela de la ranura.

Cargar la batería

Cargue la pila antes de utilizar la cámara.

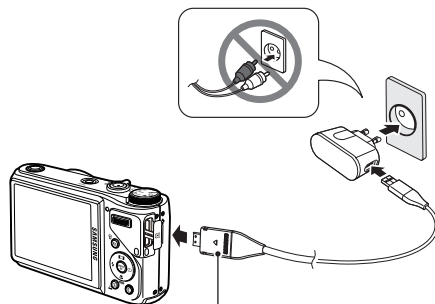

Luz indicadora

- Rojo: cargándose
- Verde: completamente cargada

Encender la cámara

- 1 Pulse [POWER].
 - Aparecerá la ventana de configuración inicial.

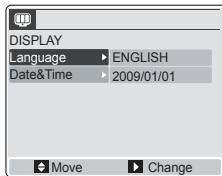

- 2 Pulse [OK].
- 3 Pulse [Left] o [Up] para seleccionar un idioma y pulse [OK].
- 4 Pulse [Left] o [Up] para seleccionar **Date & Time** y pulse [OK].
- 5 Pulse [Left] o [OK] para seleccionar un elemento.
- 6 Pulse [Left] o [Up] para cambiar el número o seleccionar otro formato de fecha y pulse [OK].

Selección de opciones

- 1 En el modo de disparo, pulse [Fn].
- 2 Utilice los botones de navegación para desplazarse hacia una opción o hacia un menú.

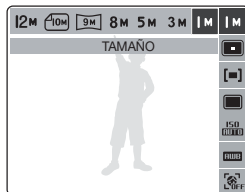

- Para desplazarse hacia la izquierda o hacia la derecha, pulse [Left] o [Right].
 - Para desplazarse hacia arriba o hacia abajo, pulse [Up] o [Down].
- 3 Pulse [OK] para confirmar la opción o el menú resaltados.
 - Pulse [Fn] nuevamente para regresar al menú anterior.

Captura de fotografías o vídeos

Tomar una fotografía

- 1 Gire el selector de modos hasta **AUTO**.
- 2 Alinee el sujeto en el marco.
- 3 Pulse [**Obturador**] hasta la mitad para utilizar el enfoque automático.
 - Si aparece un cuadro verde, significa que el sujeto está enfocado.

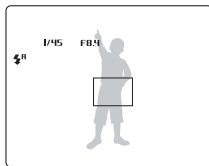

- 4 Pulse completamente [**Obturador**] para tomar la fotografía.

Grabar un vídeo

- 1 Gire el selector de modos hasta **📹**.
- 2 Alinee el sujeto en el marco.
- 3 Pulse [**Obturador**].
 - Pulse [**👁️**] para pausar o reanudar.
- 4 Pulse [**Obturador**] nuevamente para detener la grabación.

Nota

Cantidad de fotografías por resolución (para SD de 1GB)

	Resolución	Superfina	Fina	Normal
12M	4000 x 3000	147	285	404
10M	3984 x 2656	168	314	442
9M	3968 x 2232	203	368	529
8M	3264 x 2448	212	375	538
5M	2592 x 1944	334	558	780
3M	2048 x 1536	524	790	1,049
1M	1024 x 768	1,449	1,645	1,845

Estas son medidas tomadas en condiciones estándar, establecidas por Samsung, y pueden variar según las condiciones de disparo y la configuración de la cámara.

Reproducción de archivos

Ver fotografías

- 1 Pulse [▶].
- 2 Pulse [⚡] o [⌂] para desplazarse por los archivos.
 - Mantenga la tecla pulsada para ver los archivos rápidamente.

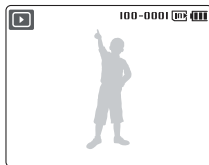

Ver vídeos

- 1 Pulse [▶].
- 2 Pulse [👁].



- 3 Utilice los siguientes botones para controlar la reproducción.



Permite retroceder.



Permite pausar o reanudar la reproducción.



Permite avanzar.

Pulse la palanca de comando hacia la izquierda o hacia la derecha

Permite ajustar el nivel de volumen.

Transferencia de archivos a un ordenador (para Windows)

- 1 Inserte el CD de instalación en la unidad de CD-ROM y siga las instrucciones que aparezcan en la pantalla.
- 2 Conecte la cámara a su PC con el cable USB.

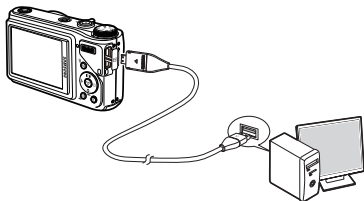

- 3 Encienda la cámara.
- 4 En el ordenador, seleccione **Mi PC** → **Disco extraíble** → **DCIM** → **100SSCAM**.
- 5 Seleccione los archivos que desee y arrástrelos o guárdelos en el ordenador.

Desconectarse de manera segura (para Windows XP)



Haga clic



Haga clic

Especificaciones

Sensor de imagen	<ul style="list-style-type: none">• Tipo: 1/2,33" (aprox. 1,09 cm) CCD• Píxeles reales: aproximadamente 12,2 megapíxeles• Píxeles totales: aproximadamente 12,4 megapíxeles
Lente	<ul style="list-style-type: none">• Distancia focal: Lente Samsung f= 4,2 - 42,0 mm (equivalente en película de 35 mm: de 24 a 240 mm)• Rango de apertura del objetivo: F3,3 (W) y F5,8 (T)
Pantalla	3,0" QVGA TFT LCD (230.000 píxeles)
Enfoque	Enfoque automático TTL (Multi AF, AF Central, Enfoque Manual, Selección AF, Reconocimiento del Rostro AF)
Velocidad del obturador	<ul style="list-style-type: none">• Auto: 1/8 ~ 1/1.500 s• Programa: 1 ~ 1/1.500 s• Manual: 16 ~ 1/1.500 s• Nocturno: 8 ~ 1/1.500 s• Fuegos Artif.: 4 s
Almacenamiento	<ul style="list-style-type: none">• Memoria interna: aprox. 21 MB• Memoria externa (opcional): tarjeta SD (hasta 4 GB garantizados), tarjeta SDHC (hasta 8 GB garantizados), MMC Plus (hasta 2GB garantizados, 4bit 20MHz) <p>Es posible que la capacidad de la memoria interna no coincida con estas especificaciones.</p>
Conector de entrada de CC	20 pines
Batería recargable	Batería de litio (SLB-10A, 1.050 mAh)
Dimensiones (alto x ancho x profundidad)	105 x 61,4 x 36,5 mm
Peso	225 g (sin la batería ni la tarjeta de memoria)
Temperatura de funcionamiento	entre 0 y 40 °C
Humedad de funcionamiento	5 - 85 %

Contenuto

Informazioni sulla salute e la sicurezza	2	2
Layout fotocamera	4	8
Preparazione della fotocamera	5	7
Apertura dell'imballaggio	5	7
Inserimento della batteria e della scheda di memoria	6	15
Come caricare la batteria	6	14
Come accendere la fotocamera	7	18
Selezione delle opzioni	7	40
Cattura di foto o video	8	20
Riproduzione di file	9	56
Trasferimento di file ad un PC (Windows)	10	98
Specifiche	11	105

Informazioni sulla salute e la sicurezza



Avvertimenti

Non utilizzate la fotocamera in prossimità di gas e liquidi infiammabili o esplosivi

Non utilizzare la fotocamera vicino a carburanti, combustibili o altre sostanze chimiche infiammabili. Non conservare o non trasportare liquidi infiammabili, gas o esplosivi nello stesso scomparto in cui si trova la fotocamera o i relativi accessori.

Tenete la fotocamera lontano da bambini e piccoli animali

Tenete la fotocamera e tutti gli accessori fuori dalla portata di bambini piccoli e animali. Se ingoiate, le parti piccole possono provocare soffocamento o gravi lesioni. Anche le parti e accessori mobili possono rappresentare un pericolo fisico.

Come prevenire lesioni alla vista del soggetto

Non usare il flash molto vicino (più vicino di 1 m) a persone o animali. L'uso del flash vicino agli occhi del soggetto può provocare danni temporanei o permanenti.

Maneggiate e smaltite con cura le batterie e i caricabatterie

- Utilizzare solo batterie e caricabatterie approvati da Samsung. Batterie e caricabatterie incompatibili possono provocare ferite o danni seri alla fotocamera.
- Non posizionate mai batterie o fotocamere sopra o all'interno di dispositivi di riscaldamento come microonde, forni o radiatori. Le batterie surriscaldate rischiano di esplodere.



Attenzione

Maneggiare e smaltire la fotocamera con attenzione e delicatamente

- Evitare che sulla fotocamera vengano versati liquidi poiché ciò può provocare danni seri. Non maneggiare la fotocamera con le mani bagnate. Eventuali danni provocati dall'acqua alla fotocamera possono invalidare la garanzia del produttore.
- Evitare di utilizzare o di conservare la fotocamera in aree polverose, sporche, umide o poco ventilate per evitare danni alle parti mobili e ai componenti interni.

- Far attenzione quando si collegano i cavi o adattatori e quando si installano le batterie e schede di memoria. Forzando i connettori, collegando i cavi in modo incorretto o installando le batterie e le schede di memoria non secondo la norma, si rischia di causare danni alle porte, ai connettori e agli accessori.
- Non inserite oggetti estranei negli scomparti, slot o punti di accesso della fotocamera. Questo tipo di danno non è coperto dalla garanzia.

Proteggere le batterie, i caricabatteria e le schede di memoria da eventuali danni

- Non esporre le batterie o schede di memoria a temperature estremamente fredde o calde (al di sotto di 0° C o al di sopra di 40° C). Le temperature estreme possono ridurre la capacità di carica delle batterie e causare malfunzionamento delle schede di memoria.
- Evitare che le schede di memoria entrino in contatto con liquidi, sporco o altre sostanze. Pulite la scheda di memoria, se sporca, con un panno morbido prima di inserirla nella fotocamera.

Layout fotocamera

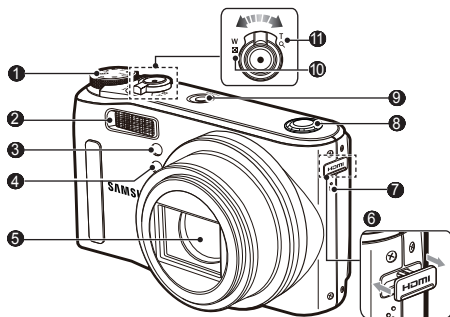

- 1 | Ghiera Selezione Modalità
- 2 | Flash
- 3 | Sensore AF / Spia autoscatto
- 4 | Sensore telecomando
- 5 | Obiettivo
- 6 | Terminale di connessione HDMI
- 7 | Microfono
- 8 | Altoparlante
- 9 | Pulsante POWER
- 10 | Pulsante di zoom W (Zoom Wide, Grandangolo, Miniature)
- 11 | Pulsante di zoom T (Zoom Tele, Zoom Digitale)

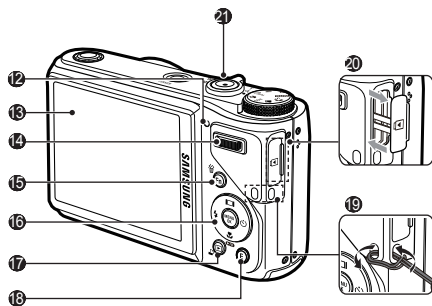

- 12 | Spia di stato della fotocamera
- 13 | Monitor LCD
- 14 | Leva comando
- 15 | Pulsante Fn / Elimina
- 16 | Pulsante a 5 funzioni
- 17 | Pulsante modalità Riproduzione / Stampa
- 18 | Pulsante E (Effetto)
- 19 | Cordoncino
- 20 | Terminale USB / AV / DC
- 21 | Pulsante Otturatore

Preparazione della fotocamera

Apertura dell'imballaggio



Fotocamera



Adattatore CA/Cavo USB



Batteria ricaricabile



Tracolla

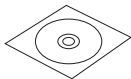

CD-ROM del software
(Manuale dell'utente)



Guida rapida

Accessori opzionali



Custodia fotocamera



Schede di memoria



Telecomando

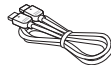

Cavo HDMI

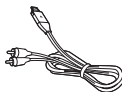

Cavo AV

Preparazione della fotocamera

Inserimento della batteria e della scheda di memoria

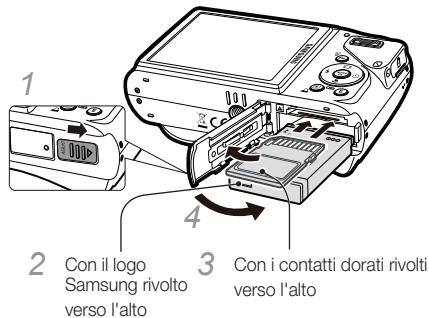

▼ Come rimuovere la batteria

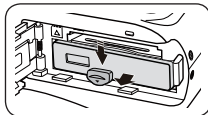

▼ Come rimuovere la scheda di memoria

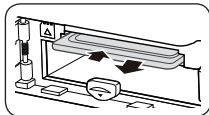

Spingete la scheda con delicatezza in modo da liberarla dalla fotocamera, quindi estraetela dallo slot.

Come caricare la batteria

Non dimenticare di ricaricare la batteria prima di usare la fotocamera.

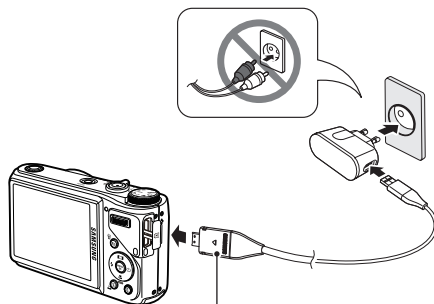

Spia indicatrice

- Rosso: in ricarica
- Verde: carica completa

Come accendere la fotocamera

- 1 Premete **[POWER]**.
 - Compare la schermata iniziale di installazione.

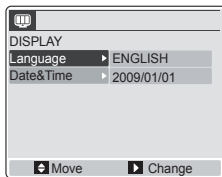

- 2 Premete **[OK]**.
- 3 Premete **[M]** o **[Up]** per selezionare una lingua e premete **[OK]**.
- 4 Premete **[M]** o **[Up]** per selezionare **Date & Time** e premete **[OK]**.
- 5 Premete **[Fn]** o **[OK]** per selezionare un elemento.
- 6 Premete **[M]** o **[Up]** per cambiare il numero o selezionare un altro formato di data e premete **[OK]**.

Selezione delle opzioni

- 1 Nella modalità di scatto, premete **[Fn]**.
- 2 Utilizzate i tasti di spostamento per scorrere in un menu o un'opzione.

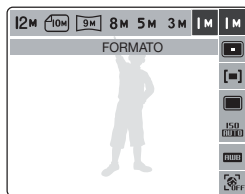

- Per spostarvi a sinistra o a destra, premete **[Fn]** o **[OK]**.
 - Per spostarvi in alto o in basso, premete **[M]** o **[Up]**.
- 3 Premete **[OK]** per confermare l'opzione o il menu evidenziato.
 - Premete **[Fn]** per tornare al menu precedente.

Cattura di foto o video

Scattare una foto

- 1 Ruotate la ghiera di selezione su **AUTO**.
- 2 Allineate il soggetto al riquadro.
- 3 Premete parzialmente [**Otturatore**] per eseguire la messa a fuoco automatica.
 - Un riquadro verde indica che il soggetto è messo a fuoco.

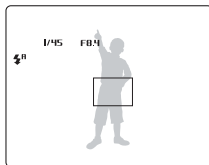

- 4 Premete completamente [**Otturatore**] per scattare una foto.

Registrazione di un video

- 1 Ruotate la ghiera di selezione su **MOV**.
- 2 Allineate il soggetto al riquadro.
- 3 Premete [**Otturatore**].
 - Premete [**Stop**] per interrompere temporaneamente o riprendere.
- 4 Premete nuovamente [**Otturatore**] per interrompere la registrazione.

Nota

Numero di foto per risoluzione (per SD da 1 GB)

	Risoluzione	S. fine	Fine	Normale
12M	4000 x 3000	147	285	404
10M	3984 x 2656	168	314	442
9M	3968 x 2232	203	368	529
8M	3264 x 2448	212	375	538
5M	2592 x 1944	334	558	780
3M	2048 x 1536	524	790	1,049
1M	1024 x 768	1,449	1,645	1,845

Questi valori sono misurati in condizioni standard Samsung e possono variare in base alle condizioni di scatto e alle impostazioni della fotocamera.

Riproduzione di file

Visualizzazione delle fotografie

- 1 Premete [▶].
- 2 Premete [⚡] o [⏸] per scorrere i file.
 - Per visualizzare rapidamente i file, tenete premuto.

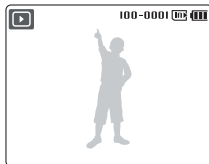

Visualizzazione dei video

- 1 Premete [▶].
- 2 Premete [🌸].

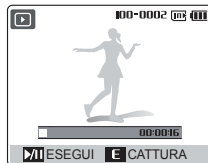

- 3 Utilizzate i tasti seguenti per controllare la riproduzione.

[⚡]	Cerca indietro
[🌸]	Mette in pausa o riprende la riproduzione
[⏸]	Cerca avanti
Premete la leva di comando verso sinistra o destra	Regola il livello del volume

Trasferimento di file ad un PC (Windows)

- 1 Inserite il CD di installazione in un'unità CD-ROM ed eseguite le istruzioni sullo schermo.
- 2 Collegate la fotocamera al PC con il cavo USB.

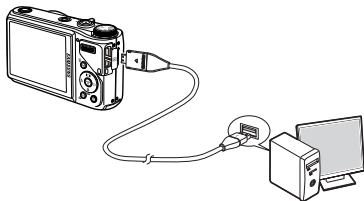

- 3 Accendete la fotocamera.
- 4 Sul PC selezionate **Risorse del computer** → **Disco rimovibile** → **DCIM** → **100SSCAM**.
- 5 Selezionate e trascinate i file desiderati o salvateli sul PC.

Disconnessione sicura (per Windows XP)



Specifiche

Sensore immagini	<ul style="list-style-type: none">• Tipo: 1/2,33" (ca. 1,09 cm) CCD• Pixel effettivi: ca. 12,2 mega pixel• Pixel totali: ca. 12,4 mega pixel
Obiettivo	<ul style="list-style-type: none">• Lunghezza focale: Obiettivo Samsung f = 4,2 - 42,0 mm (equivalente per pellicola 35 mm: 24 - 240 mm)• Intervallo apertura diaframma: F3,3 (W) - F5,8 (T)
Display	3,0" QVGA TFT LCD (230.000 pixel)
Messa a fuoco	Autofocus TTL (AF multiplo, AF centrato, Messa a fuoco manuale, Selezione AF, AF per il riconoscimento dei volti)
Velocità otturatore	<ul style="list-style-type: none">• Auto: 1/8 ~ 1/1.500 sec.• Programm: 1 ~ 1/1.500 sec.• Manuale: 16 ~ 1/1.500 sec.• Notte: 8 ~ 1/1.500 sec.• Fuochi Art.: 4 sec.
Memoria	<ul style="list-style-type: none">• Memoria interna: circa 21 MB• Memoria esterna (opzionale): Scheda SD (fino a 4 GB garantiti), Scheda SDHC (fino a 8 GB garantiti), MMC Plus (fino a 2GB garantiti, 4bit 20MHz) <p>È possibile che la capacità della memoria interna non corrisponda a queste caratteristiche tecniche.</p>
Presenza di ingresso alimentazione in CC	20 pin
Batteria ricaricabile	Batteria agli ioni di litio (SLB-10A, 1.050 mAh)
Dimensioni (L x A x P)	105 x 61,4 x 36,5 mm
Peso	225 g (senza batteria e scheda di memoria)
Temperatura di esercizio	0 - 40° C
Umidità di esercizio	5 - 85 %

Inhoudsopgave

Informatie over gezondheid en veiligheid	2	2
Camera-indeling	4	8
Uw camera gereedmaken voor gebruik	5	
Uitpakken	5	7
De batterij en geheugenkaart plaatsen	6	15
De batterij opladen	6	14
De camera inschakelen	7	18
Opties selecteren	7	40
Foto's en video's maken	8	20
Bestanden afspelen	9	56
Bestanden overzetten naar een pc (Windows)	10	98
Specificaties	11	105

Informatie over gezondheid en veiligheid



Waarschuwingen

Gebruik de camera niet dichtbij ontvlambare of explosieve gassen en vloeistoffen

Gebruik de camera niet in de buurt van brandstoffen, brandbare stoffen of ontvlambare chemicaliën. Bewaar geen ontvlambare vloeistoffen, gassen en explosief materiaal in dezelfde ruimte als de camera of de accessoires van de camera.

Houd de camera buiten het bereik van kleine kinderen en huisdieren

Houd de camera en alle bijbehorende onderdelen en accessoires buiten het bereik van kleine kinderen en huisdieren. Kleine onderdelen vormen verstikkingsgevaar of kunnen schadelijk zijn wanneer zij worden ingeslikt. Bewegende onderdelen en accessoires kunnen ook fysiek gevaar opleveren.

Voorkom schade aan het gezichtsvermogen bij gefotografeerde personen of dieren

Gebruik de flitser van de camera niet vlakbij (op minder dan 1m afstand van) de ogen van mensen of dieren. Gebruik van de flitser dicht bij de ogen van mens of dier kan tot tijdelijke of permanente schade aan het gezichtsvermogen leiden.

Behandel batterijen en oplader voorzichtig en voer deze af volgens de voorschriften

- Gebruik alleen door Samsung goedgekeurde batterijen en opladers. Niet-compatibele batterijen en opladers kunnen ernstig letsel of schade aan de camera veroorzaken.
- Leg batterijen of camera's nooit in of op verwarmingsapparaten, zoals een magnetron, kachel of radiator. Batterijen kunnen exploderen als ze te heet worden.



Voorzichtig

De camera voorzichtig en verstandig behandelen en opslaan

- Zorg ervoor dat de camera niet nat wordt. Het toestel kan door vloeibare stoffen ernstig beschadigen. Raak de camera niet aan met natte handen. De garantie van de fabrikant is niet van toepassing op waterschade aan het toestel.
- Gebruik of bewaar de camera niet in stoffige, vuile, vochtige of slecht-geventileerde gebieden om schade aan bewegende en interne onderdelen te voorkomen.

- Wees voorzichtig bij het aansluiten van snoeren en adapters en het plaatsen van batterijen en geheugenkaarten. Door het forceren van aansluitingen, het niet op de juiste manier aansluiten van snoeren of het niet op de juiste manier plaatsen van batterijen en geheugenkaarten kunnen poorten, aansluitingen en accessoires beschadigd raken.
- Steek geen vreemde voorwerpen in de compartimenten, sleuven en toegangspunten van de camera. Dit soort schade valt mogelijk niet onder de garantie.

Bescherm batterijen, opladers en geheugenkaarten tegen schade

- Vermijd blootstelling van batterijen of geheugenkaarten aan zeer lage of zeer hoge temperaturen (onder 0° C of boven 40° C). Door extreme temperaturen kan de capaciteit van batterijen verminderen en kunnen geheugenkaarten minder goed werken.
- Voorkom dat geheugenkaarten in contact komen met vloeistoffen, vuil of vreemde stoffen. Veeg, indien nodig, de geheugenkaart met een zachte doek schoon alvorens u de kaart in de camera plaatst.

Camera-indeling

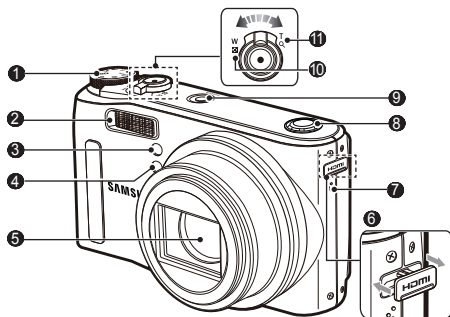

- 1 | Functiekeizer
- 2 | Flitser
- 3 | AF sensor / Zelfontspanner
- 4 | Sensor voor afstandsbediening
- 5 | Lens
- 6 | HDMI-aansluiting
- 7 | Microfoon
- 8 | Luidspreker
- 9 | POWER-knop
- 10 | Zoom W-knop (Miniatuurmodus)
- 11 | Zoom T-knop (Digitale zoom)

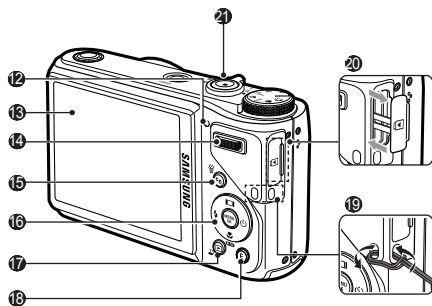

- 12 | Camerastatuslampje
- 13 | LSC-scherm
- 14 | Commandoknop
- 15 | Knop Fn / verwijderen
- 16 | Knop voor 5 functies
- 17 | Knop Afspeelmodus / Printen
- 18 | Knop E (effecten)
- 19 | Camerakoord
- 20 | USB / AV / DC aansluiting
- 21 | Sluiter knop

Uw camera gereedmaken voor gebruik

Uitpakken



Camera



AC-adaptor/USB-kabel



Oplaadbare batterij



Polslus

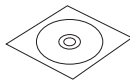

Software-cd-rom (met gebruikershandleiding)



Snelstartgids

Optionele accessoires



Camera-etui



Geheugenkaarten



Afstandsbediening

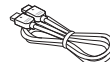

HDMI-kabel



A/V-kabel

Uw camera gereedmaken voor gebruik

De batterij en geheugenkaart plaatsen

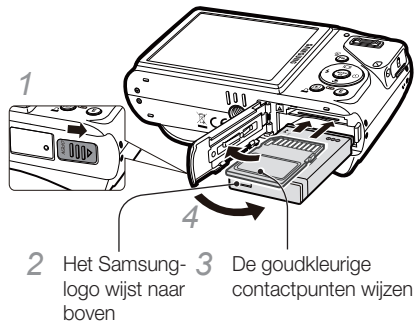

▼ De batterij verwijderen

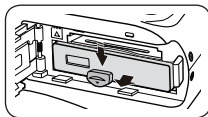

▼ De geheugenkaart verwijderen

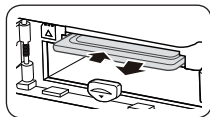

Duw voorzichtig tegen de kaart totdat deze loskomt uit de camera en trek de kaart vervolgens uit de sleuf..

De batterij opladen

Zorg ervoor dat u de batterij oplaadt voordat u de camera gebruikt.

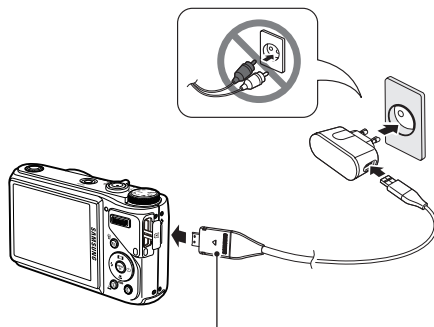

Indicatielampje

- Rood: Bezig met opladen
- Groen: Volledig opgeladen

De camera inschakelen

- 1 Druk op **[POWER]**.
 - Het scherm voor de eerste installatie verschijnt.

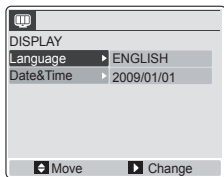

- 2 Druk op **[OK]**.
- 3 Druk op **[Left]** of **[Up]** om een taal te selecteren en druk vervolgens op **[OK]**.
- 4 Druk op **[Left]** of **[Up]** om **Date & Time** te selecteren en druk vervolgens op **[OK]**.
- 5 Druk op **[Left]** of **[OK]** om een onderdeel te selecteren.
- 6 Druk op **[Left]** of **[Up]** om het getal te wijzigen of een andere datumnotatie te selecteren en druk vervolgens op **[OK]**.

Opties selecteren

- 1 Druk in de opnamemodus op **[Fn]**.
- 2 Gebruik de navigatieknoppen om naar een optie of menu te scrollen.

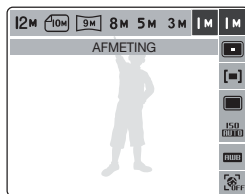

- Druk op **[Left]** of **[OK]** om naar links of rechts te gaan.
 - Druk op **[Left]** of **[Up]** om omhoog of omlaag te gaan.
- 3 Druk op **[OK]** om de gemarkeerde keuze te bevestigen.
 - Druk op **[Fn]** om naar het vorige menu terug te gaan.

Foto's en video's maken

Een foto nemen

- 1 Draai de modusdraaiknop naar **AUTO**.
- 2 Kadreer het onderwerp.
- 3 Druk [**Ontspanknop**] half in om automatisch scherp te stellen.
 - Een groen kader betekent dat het onderwerp scherp in beeld is.

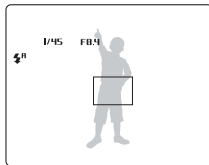

- 4 Druk [**Ontspanknop**] helemaal in om de foto te maken.

Een video opnemen

- 1 Draai de modusdraaiknop naar **📹**.
- 2 Kadreer het onderwerp.
- 3 Druk op [**Ontspanknop**].
 - Druk op [**👤**] als u de opname wilt onderbreken of hervatten.
- 4 Druk nogmaals op [**Ontspanknop**] om de opname te stoppen.

Opmerking

Aantal foto's per resolutie (voor SD van 1 GB)

	Resolutie	Superhoog	Hoog	Normaal
12M	4000 x 3000	147	285	404
10M	3984 x 2656	168	314	442
9M	3968 x 2232	203	368	529
8M	3264 x 2448	212	375	538
5M	2592 x 1944	334	558	780
3M	2048 x 1536	524	790	1,049
1M	1024 x 768	1,449	1,645	1,845

Deze waarden zijn gemeten onder standaardcondities en kunnen variëren afhankelijk van opnameomstandigheden en camera-instellingen.

Bestanden afspelen

Foto's weergeven

- 1 Druk op [▶].
- 2 Druk op [⚡] of [⏮] om door de bestanden te scrollen.
 - Houd de knop ingedrukt om bestanden snel te bekijken.

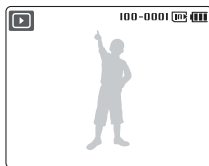

Video's bekijken

- 1 Druk op [▶].
- 2 Druk op [👉].

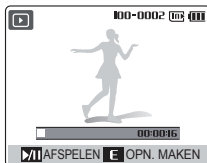

- 3 Gebruik de volgende knoppen voor de bediening.

[⏮]	Achteruit spoelen
[👉]	Het afspelen onderbreken of hervatten
[⏭]	Vooruit spoelen
Duw de bedieningshendel naar links of rechts.	Het volume regelen

Bestanden overzetten naar een pc (Windows)

- 1 Plaats de installatie-cd in een cd-romstation en volg de aanwijzingen op het scherm.
- 2 Sluit de camera met de USB-kabel aan op de pc.

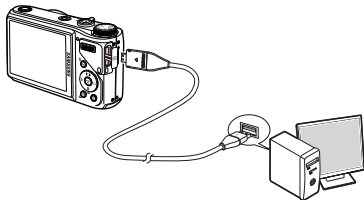

- 3 Schakel de camera in.
- 4 Selecteer op de pc **Deze computer** → **Verwisselbare schijf** → **DCIM** → **100SSCAM**.
- 5 Selecteer de gewenste bestanden en sleep ze naar de pc, of sla ze daarnaartoe op.

Veilig loskoppelen (voor Windows XP)

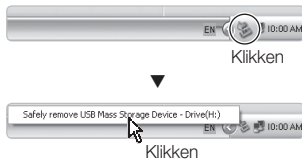

Specificaties

Beeldsensor	<ul style="list-style-type: none">• Type: 1/2,33 inch (circa 1,09 cm) CCD• Effectieve pixels: circa 12,2 megapixel• Totaalaantal pixels: circa 12,4 megapixel
Lens	<ul style="list-style-type: none">• Brandpuntsafstand: Samsung-lens $f = 4,2 - 42,0$ mm (35-mm equivalent: 24 - 240 mm)• Diafragma bereik: $f/3,3$ (G) - $f/5,8$ (T)
Scherm	3,0" QVGA TFT LCD (230.000 pixel)
Scherpstelling	TTL automatisch scherpstellen (Multi-AF, Centrum-AF, Handmatige scherpstelling, Keuze AF, Gezichtsherkenning AF)
Sluittijd	<ul style="list-style-type: none">• Auto: 1/8 ~ 1/1.500 seconde• Programma: 1 ~ 1/1.500 seconde• Handmatig: 16 ~ 1/1.500 seconde• Nacht: 8 ~ 1/1.500 seconde• Vuurwerk: 4 seconde
Opslag	<ul style="list-style-type: none">• Intern geheugen: circa 21 MB• Extern geheugen (optioneel): SD-kaart (max. 4 GB gegarandeerd), SDHC-kaart (max. 8 GB gegarandeerd), MMC Plus (max. 2 GB gegarandeerd, 4bit 20MHz) <p>De interne geheugen capaciteit kan van deze specificaties afwijken.</p>
DC-stroom-aansluiting	20-pins
Oplaadbare batterij	Lithium-ionbatterij (SLB-10A, 1.050 mAh)
Afmetingen (B x H x D)	105 x 61,4 x 36,5 mm
Gewicht	225 g (zonder batterij en geheugenkaart)
Bedrijfstemperatuur	0 - 40 °C
Bedrijfsluchtvochtigheid	5 - 85 %

Sumário

Informações de saúde e segurança	2	2
Layout da câmera	4	8
Configurando sua câmera ...	5	
Desembalando	5	7
Inserindo a bateria e o cartão de memória	6	15
Carregando a bateria.....	6	14
Ligando a câmera	7	18
Selecionando opções	7	40
Capturando fotos ou vídeos	8	20
Reproduzindo arquivos	9	56
Transferindo arquivos para um PC (Windows)	10	98
Especificações	11	105

Informações de saúde e segurança



Avisos

Não use sua câmera próximo a gases e líquidos inflamáveis ou explosivos

Não use a câmera próximo a combustíveis ou produtos químicos inflamáveis. Não armazene nem transporte líquidos inflamáveis, gases ou materiais explosivos no mesmo compartimento que a câmera ou seus acessórios.

Mantenha a câmera longe do alcance de crianças pequenas e animais domésticos

Mantenha sua câmera e todos os seus acessórios longe do alcance de crianças pequenas e animais. As peças pequenas poderão causar asfixia ou ferimentos graves se forem ingeridas. As partes móveis e os acessórios também podem representar perigos físicos.

Evite danos à visão de pessoas e animais

Não use o flash muito próximo (a menos de 1 m) de pessoas ou animais. A utilização do flash muito próximo aos olhos de pessoas ou animais poderá causar danos temporários ou permanentes.

Manipule e descarte baterias e carregadores com cuidado

- Use somente baterias e carregadores aprovados pela Samsung. Baterias e carregadores incompatíveis podem causar ferimentos graves ou danos à sua câmera.
- Jamais coloque baterias ou câmeras em dispositivos de aquecimento, como fornos de microondas, fornos ou radiadores. As baterias poderão explodir se forem superaquecidas.



Cuidados

Manipule e armazene sua câmera com cuidado

- Não molhe a câmera. Líquidos poderão causar sérios danos. Não manipule sua câmera com as mãos molhadas. Danos causados à câmera por água podem invalidar a garantia do fabricante.
- Evite usar ou armazenar sua câmera em locais empoeirados, sujos, úmidos ou com pouca ventilação para evitar danos às partes móveis e aos componentes internos.

- Tenha cuidado ao conectar cabos ou adaptadores e ao instalar baterias e cartões de memória. Forçar os conectores, conectar cabos incorretamente ou instalar baterias e cartões de memória de forma inadequada poderá causar danos a portas, conectores e acessórios.
- Não insira objetos estranhos em nenhum dos compartimentos, slots ou pontos de acesso da câmera. Esse tipo de dano pode não ser coberto pela sua garantia.

Proteja as baterias, os carregadores e os cartões de memória contra danos

- Evite expor as baterias ou os cartões de memória a temperaturas muito frias ou quentes (abaixo de 0 °C/32 °F ou acima de 40 °C/104 °F). Temperaturas extremas podem reduzir a capacidade de carga das baterias e provocar o funcionamento incorreto dos cartões de memória.
- Evite que os cartões de memória entrem em contato com líquidos, sujeira ou substâncias estranhas. Se o cartão de memória estiver sujo, limpe-o com um pano macio antes de colocá-lo na câmera.

Layout da câmera

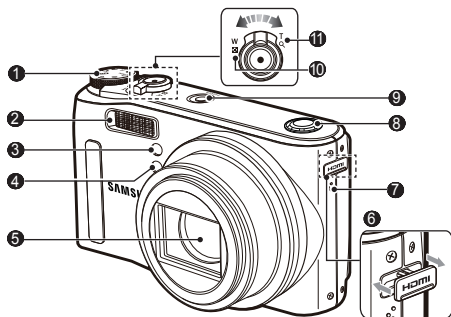

- 1 Seletor de modo
- 2 Flash
- 3 Sensor AF / Lâmpada do Temporizador
- 4 Sensor do controle remoto
- 5 Lente
- 6 Terminal de conexão HDMI
- 7 Microfone
- 8 Alto-falante
- 9 Botão POWER
- 10 Alavanca de zoom W (Miniatura)
- 11 Alavanca de zoom T (Zoom digital)

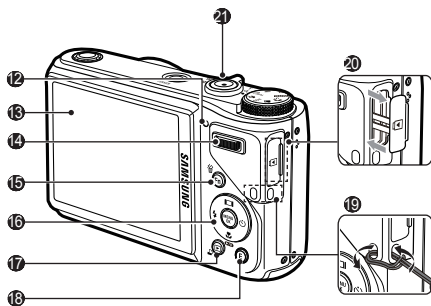

- 12 Luz de status da câmera
- 13 Monitor LCD
- 14 Alavanca de comando
- 15 Botão Fn / Apagar
- 16 Botão de 5 funções
- 17 Modo de reprodução / Botão de Impressão
- 18 Botão E (Efeitos)
- 19 Correia da câmera
- 20 Terminal USB / AV / CC
- 21 Botão do obturador

PT-4

Configurando sua câmera

Desembalando



Câmera



Adaptador CA/Cabo USB



Bateria
recarregável



Alça



CD-ROM de software
(Manual do Usuário incluído)



Manual de Início Rápido

Acessórios opcionais



Capa



Cartões de memória



Controle remoto

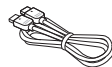

Cabo HDMI

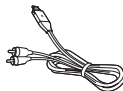

Cabo AV

Configurando sua câmera

Inserindo a bateria e o cartão de memória

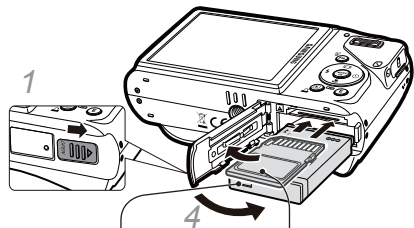

2 Com o logotipo da Samsung voltado para cima

3 Com os contatos dourados voltados para cima

▼ Removendo a bateria

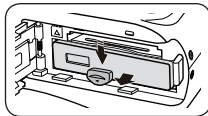

▼ Removendo o cartão de memória

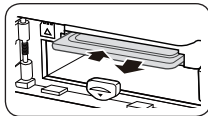

Pressione gentilmente o cartão até que ele seja liberado. Em seguida, puxe-o para fora do slot.

PT-6

Carregando a bateria

Certifique-se de recarregar a bateria antes de usar a câmera.

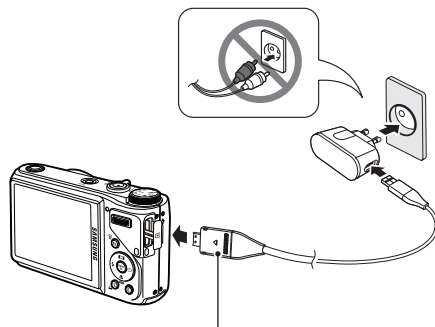

Indicador luminoso

- Vermelho: carregando
- Verde: carga máxima

Ligando a câmara

- 1 Pressione [POWER].
 - A tela de configuração inicial é exibida.

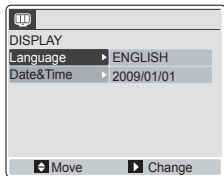

- 2 Pressione [OK].
- 3 Pressione [Left] ou [Up] para selecionar um idioma e pressione [OK].
- 4 Pressione [Left] ou [Up] para selecionar **Date & Time** e pressione [OK].
- 5 Pressione [Left] ou [Up] para selecionar um item.
- 6 Pressione [Left] ou [Up] para alterar o número ou selecionar outro formato de data e pressione [OK].

Selecionando opções

- 1 No modo Fotografia, pressione [Fn].
- 2 Use os botões de navegação para rolar para uma opção ou para um menu.

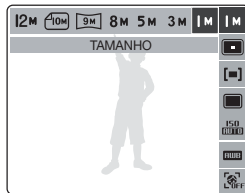

- Para ir para a esquerda ou para a direita, pressione [Left] ou [Right].
 - Para ir para a cima ou para baixo, pressione [Up] ou [Down].
- 3 Pressione [OK] para confirmar a opção ou o menu realçado.
 - Pressione [Fn] novamente para voltar para o menu anterior.

Capturando fotos ou vídeos

Tirando uma foto

- 1 Gire o disco de seleção de modo para **AUTO**.
- 2 Alinhe o objeto no quadro.
- 3 Pressione [**Obturador**] até a metade do curso para focalizar a imagem automaticamente.
 - Um quadro verde significa que o objeto foi focalizado.

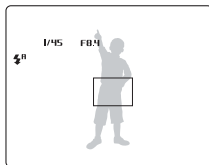

- 4 Pressione [**Obturador**] até o final para tirar a foto.

Recording a video

- 1 Gire o disco de seleção de modo para **📹**.
- 2 Alinhe o objeto no quadro.
- 3 Pressione [**Obturador**].
 - Pressione [**👆**] para pausar ou continuar.
- 4 Pressione [**Obturador**] novamente para parar a gravação.

Observação

Número de fotos por resolução (para SD de 1 GB)

	Resolução	Super fino	Fino	Normal
12M	4000 x 3000	147	285	404
10M	3984 x 2656	168	314	442
9M	3968 x 2232	203	368	529
8M	3264 x 2448	212	375	538
5M	2592 x 1944	334	558	780
3M	2048 x 1536	524	790	1,049
1M	1024 x 768	1,449	1,645	1,845

Estes valores foram medidos nas condições padrão da Samsung e podem variar em função das condições em que as fotos são tiradas e das configurações da câmera.

Reproduzindo arquivos

Exibindo fotos

- 1 Pressione [▶].
- 2 Pressione [⚡] ou [⌂] para percorrer os arquivos.
 - Pressione e mantenha pressionado para exibir os arquivos rapidamente.

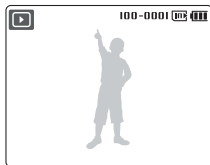

Exibindo vídeos

- 1 Press [▶].
- 2 Press [👤].

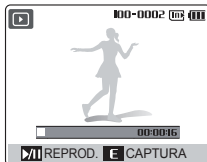

- 3 Use os botões a seguir para controlar a reprodução.

[⏮]	Retroceder
[⏸]	Pausar ou retomar a reprodução
[⏭]	Avançar
Pressione a alavanca de comando para a esquerda ou para a direita	Ajustar o nível de volume

Transferindo arquivos para um PC (Windows)

- 1 Insira o CD de instalação em uma unidade de CD-ROM e siga as instruções exibidas na tela.
- 2 Conecte a câmera ao PC com o cabo USB.

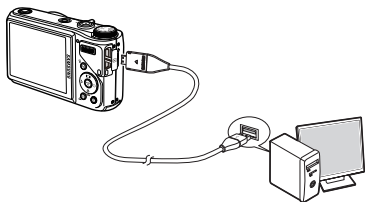

- 3 Ligue a câmera.
- 4 Em seu PC, selecione **Meu computador** → **Disco removível** → **DCIM** → **100SSCAM**.
- 5 Selecione os arquivos desejados e arraste-os ou salve-os no PC.

Desconectando com segurança (Windows XP)



Clique



Clique

Especificações

Sensor de imagens	<ul style="list-style-type: none">• Tipo: CCD de 1/2,33" (aprox. 1,09 cm)• Pixels efetivos: aprox. 12,2 megapixels• Total de pixels: aprox. 12,4 megapixels
Lente	<ul style="list-style-type: none">• Comprimento focal: Lente Samsung f = 4,2 - 42,0 mm (equivalente a filme de 35 mm: 24 - 240 mm)• Faixa de F-stop: F3,3 (M) - F5,8 (T)
Tela	3,0" QVGA TFT LCD (230.000 pixel)
Foco	Foco automático TTL (Multi-AF, AF central, Foco manual, Acompanhamento de AF, Reconhecimento da Face AF)
Velocidade do obturador	<ul style="list-style-type: none">• Auto: 1/8 ~ 1/1.500 s.• Programa: 1 ~ 1/1.500 s.• Manual: 16 ~ 1/1.500 s.• Noite: 8 ~ 1/1.500 s.• Fogo Art.: 4 s.
Armazenamento	<ul style="list-style-type: none">• Memória interna: aprox. 21 MB• Memória externa (Opcional): Cartão SD (até 4 GB garantidos), Cartão SDHC (até 8 GB garantidos), MMC Plus (até 2 GB garantidos, 20MHz de 4 bits) <p>A capacidade da memória interna pode não atender a estas especificações.</p>
Conector de entrada de alimentação CC	20 pinos
Bateria recarregável	Bateria de íons de lítio (SLB-10A, 1.050 mAh)
Dimensões (L x A x P)	105 x 61,4 x 36,5 mm
Peso	225 g (sem a bateria e o cartão de memória)
Temperatura de operação	0 - 40 °C
Umidade de operação	5 - 85 %



MEMO

A series of 12 horizontal dashed lines for writing.



MEMO

A series of horizontal dashed lines for writing a memo.





Please refer to the warranty that came with your product
or visit our website <http://www.samsungcamera.com/>
for after-sales service or inquiries.



AD68-03939A (1.1)