

# playmobil®

## 4858



**WARNING:**  
CHOKING HAZARD

Contains a small ball and small parts.  
Not for children under 3 years.

"Ne concerne que les USA"



Wichtige Unterlagen, bitte sorgfältig aufbewahren!  
Important documents keep carefully!  
Documents importants conservez avec soin!  
Belangrijke documenten, bewaar deze zorgvuldig!

1

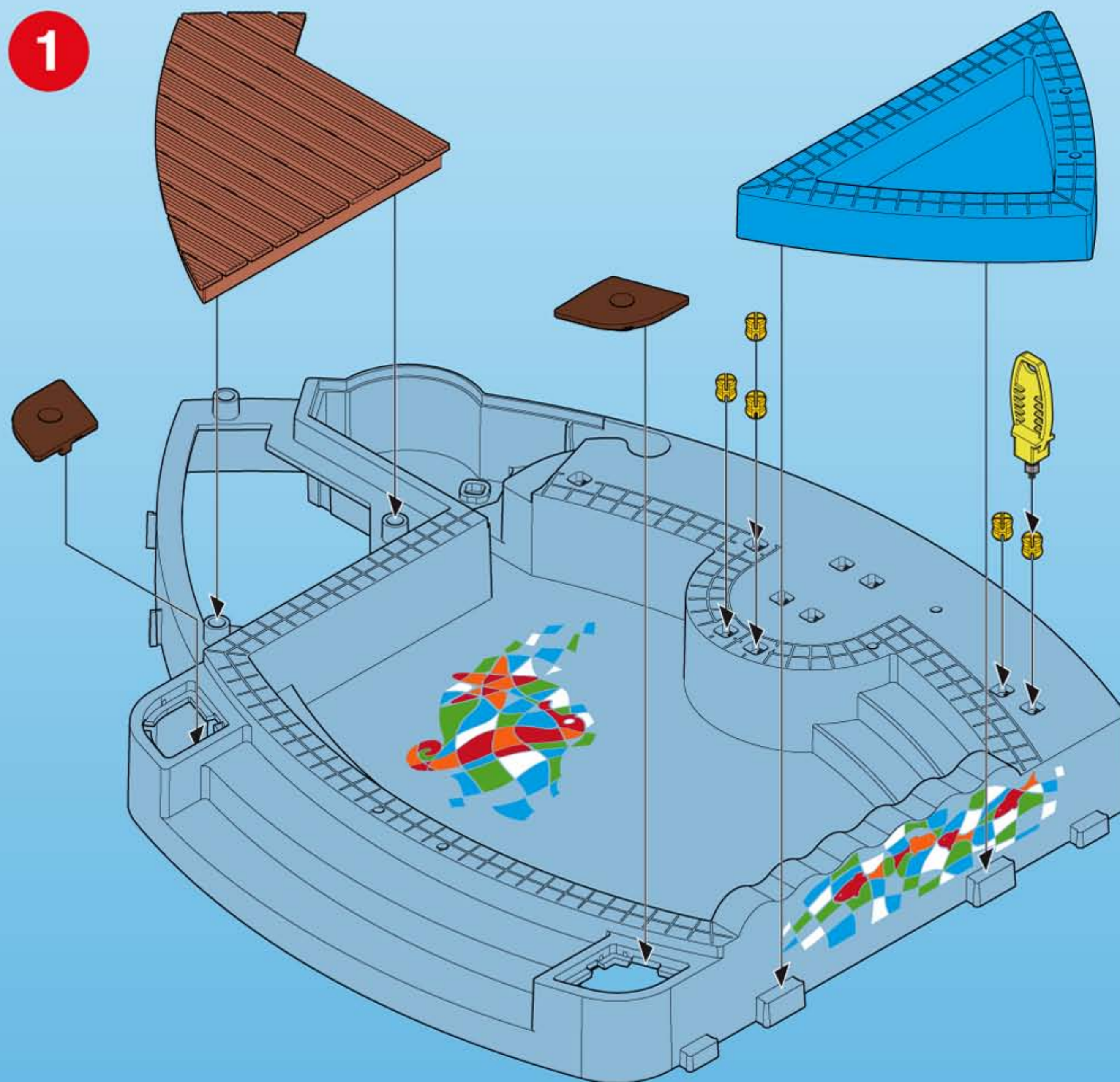

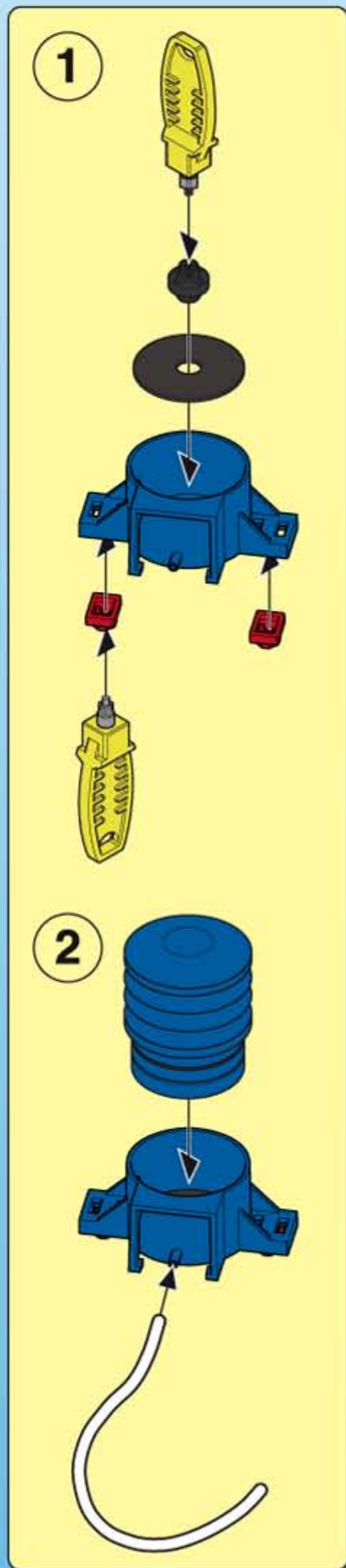

**2**

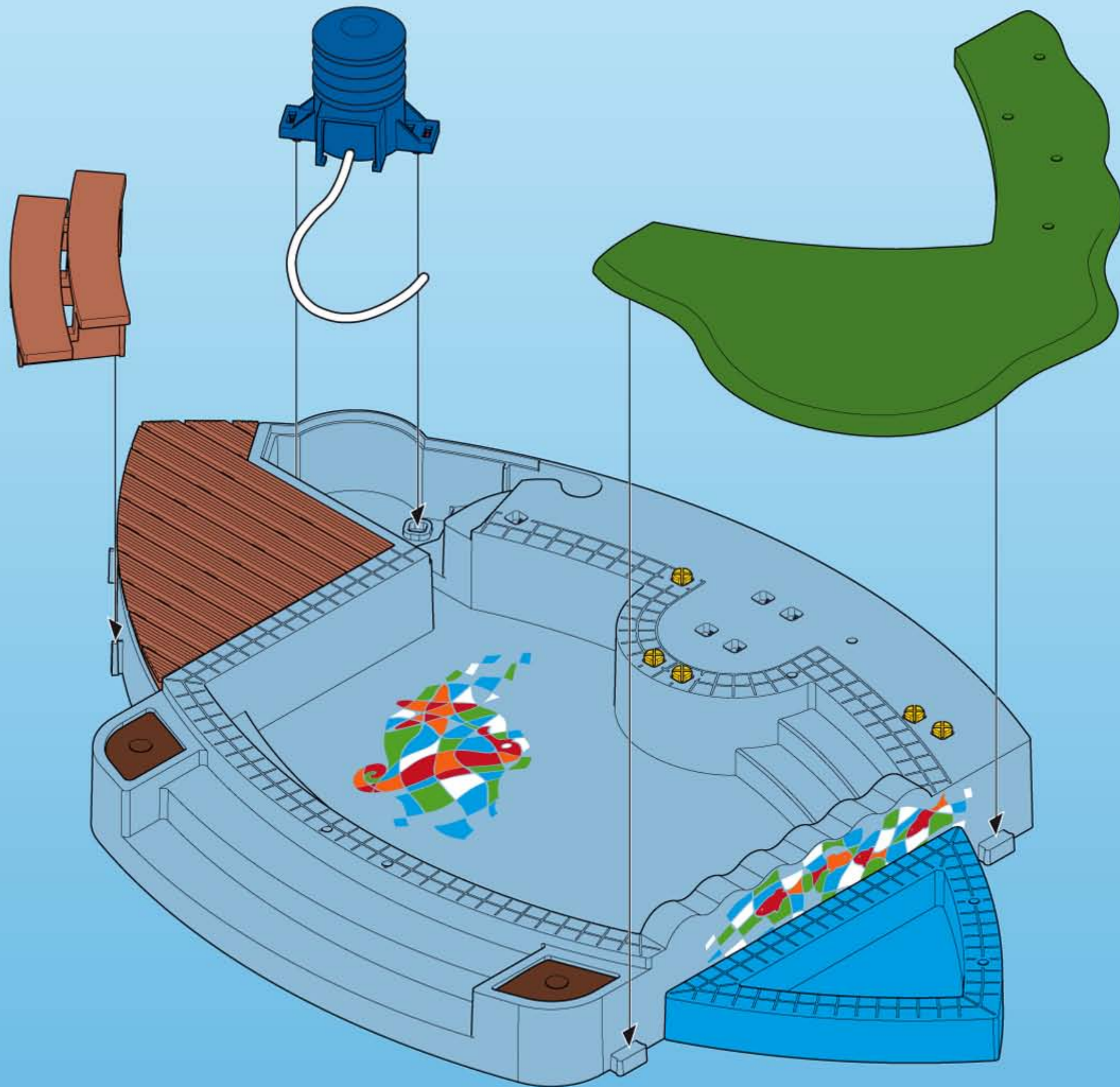

3

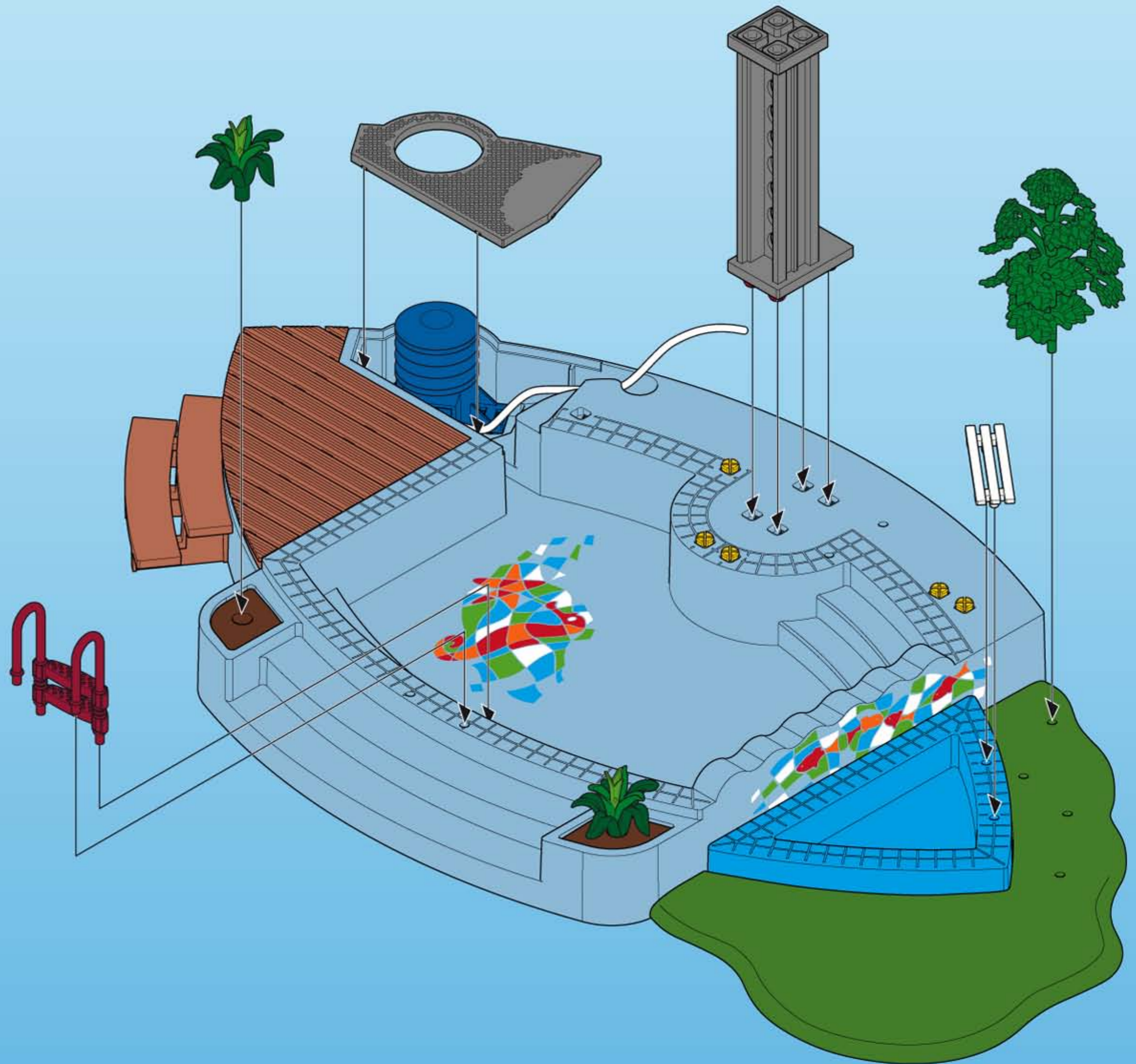
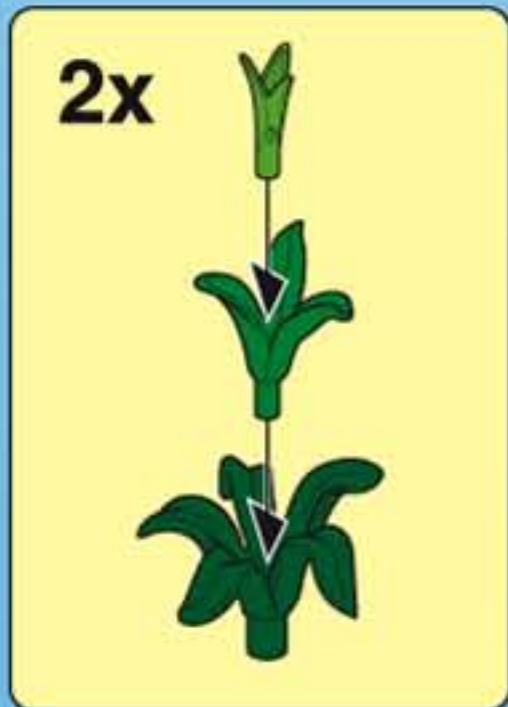
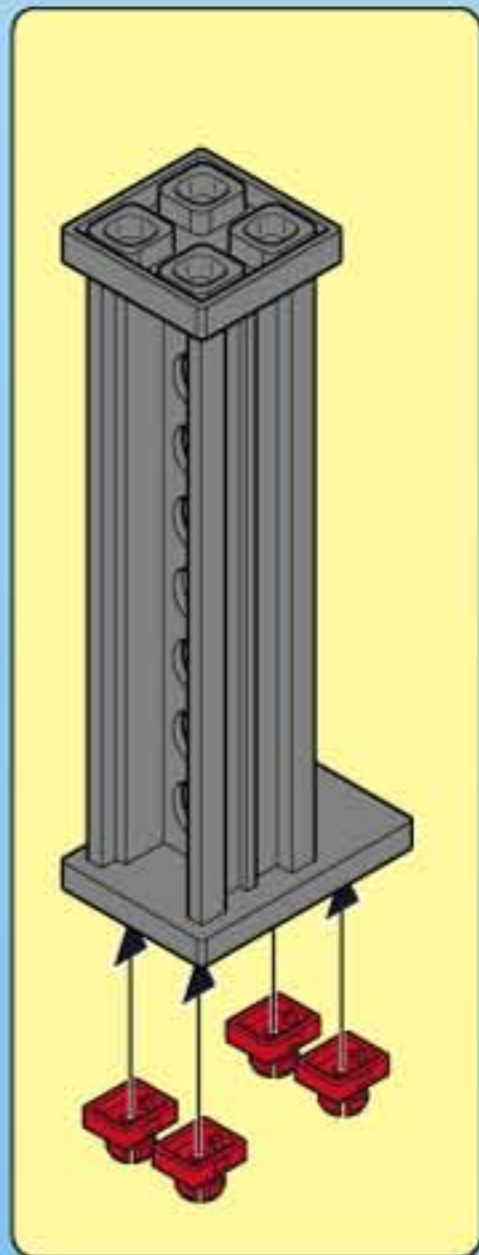
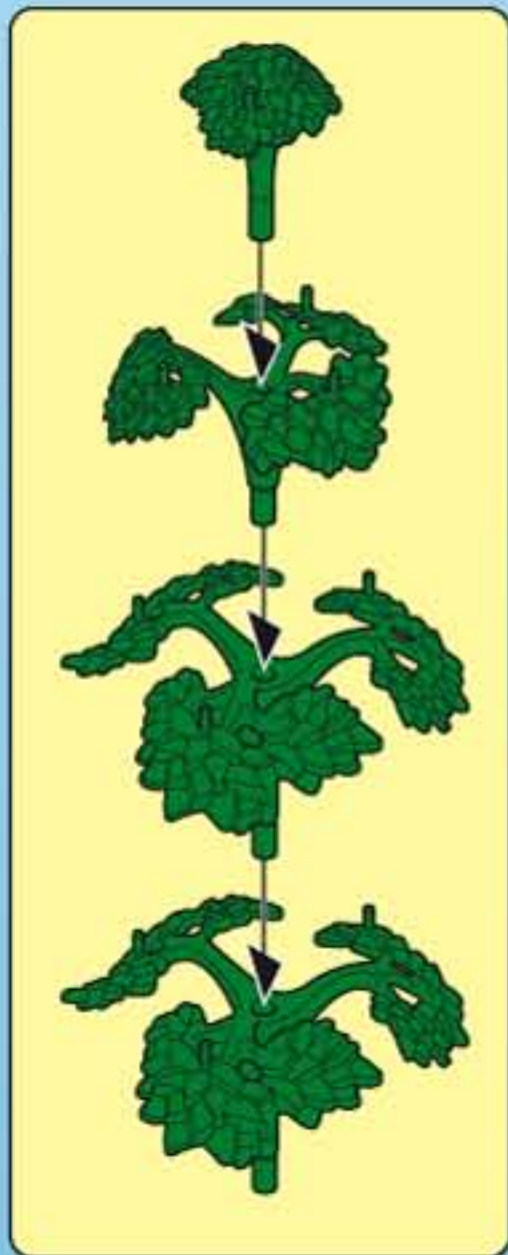
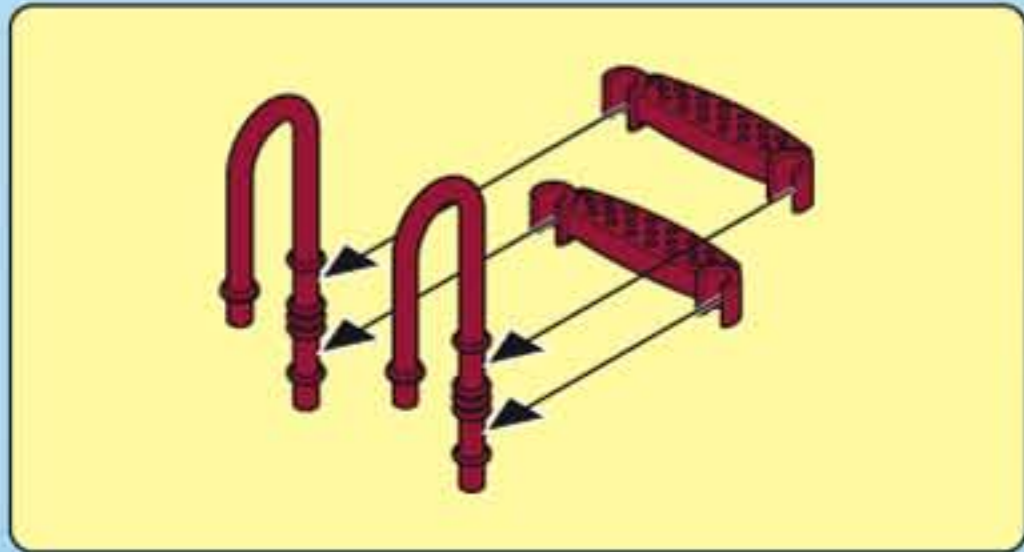

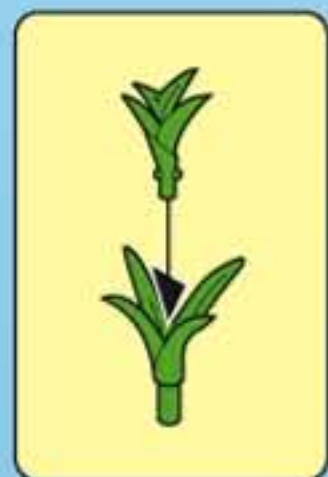
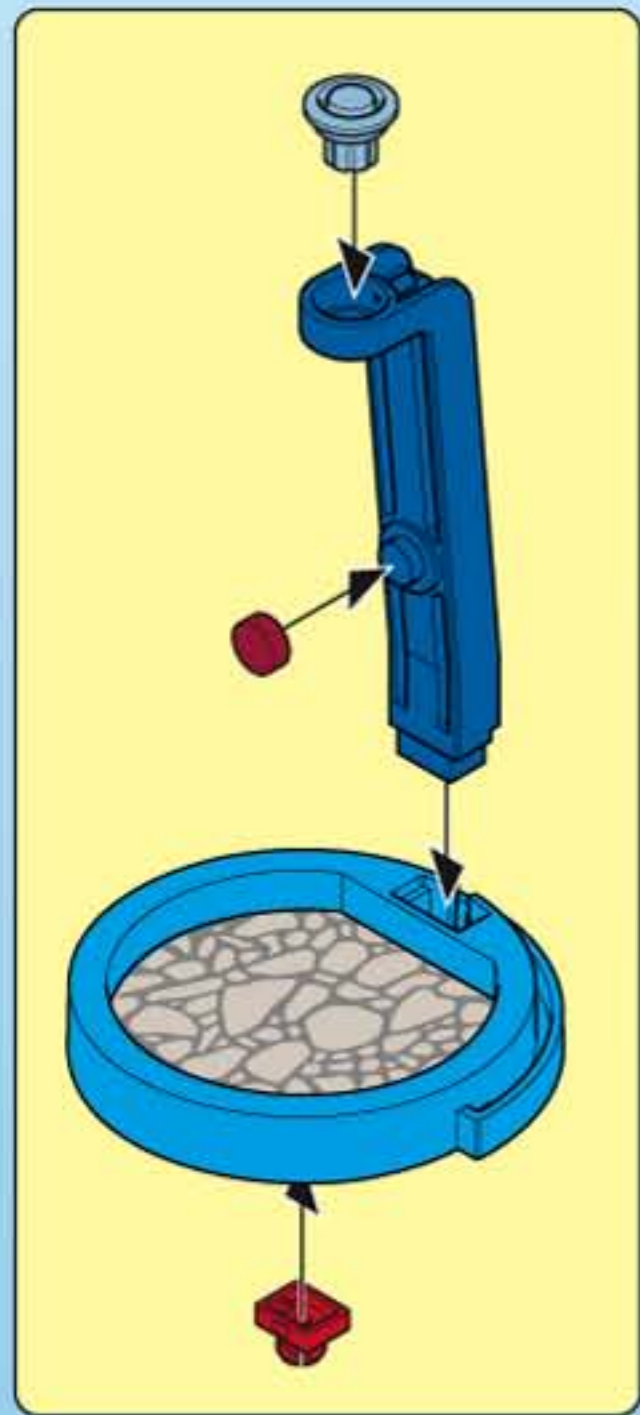

4

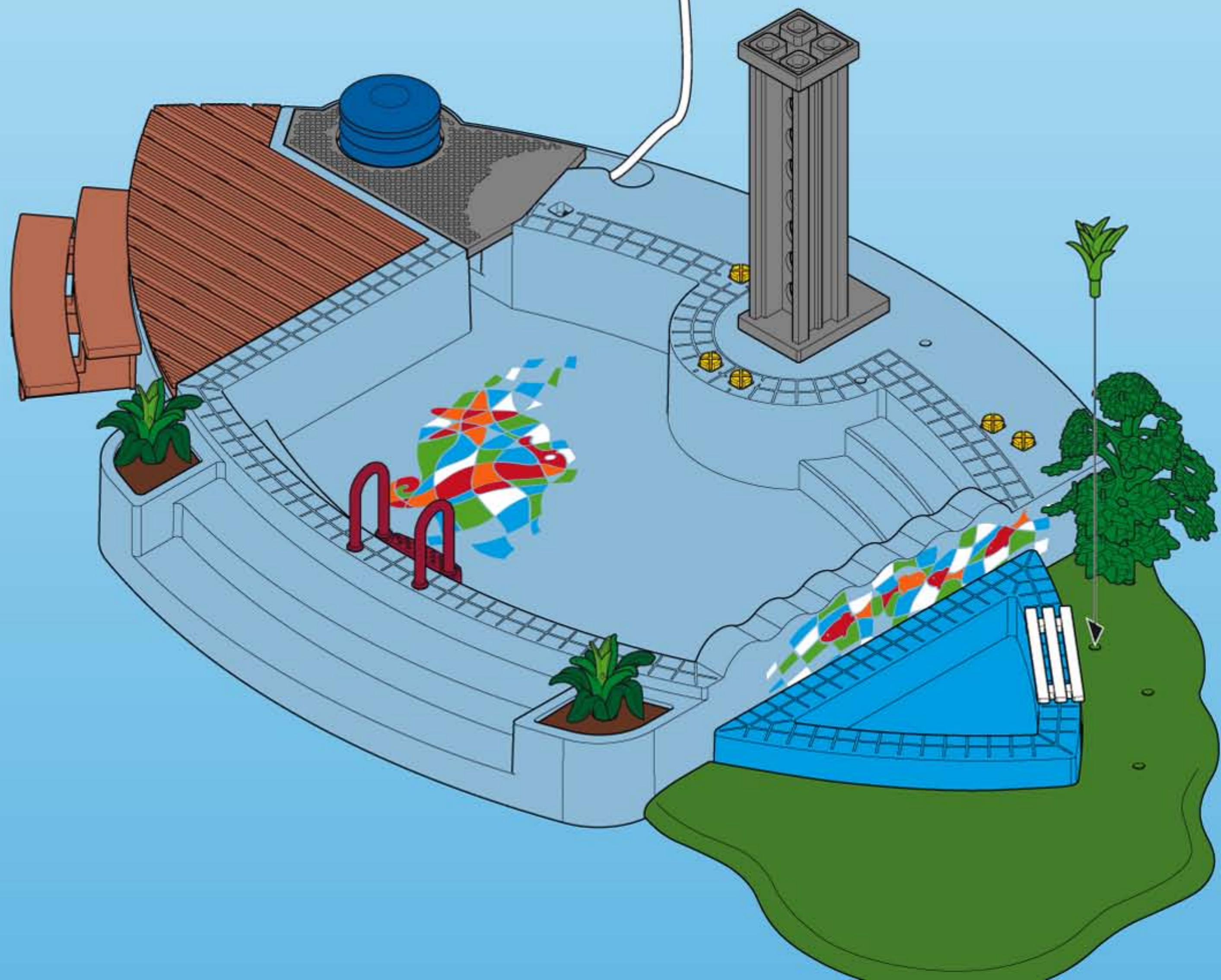
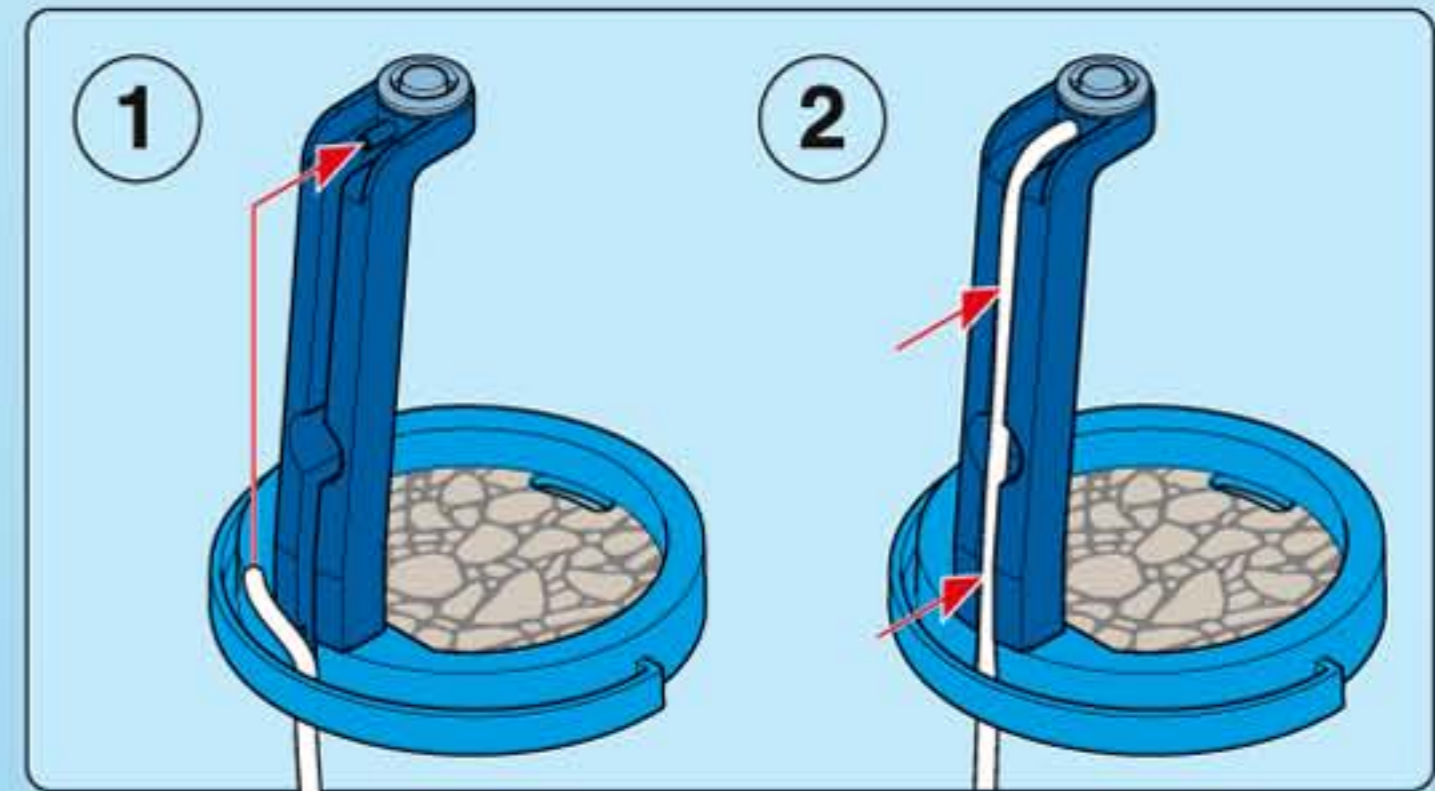

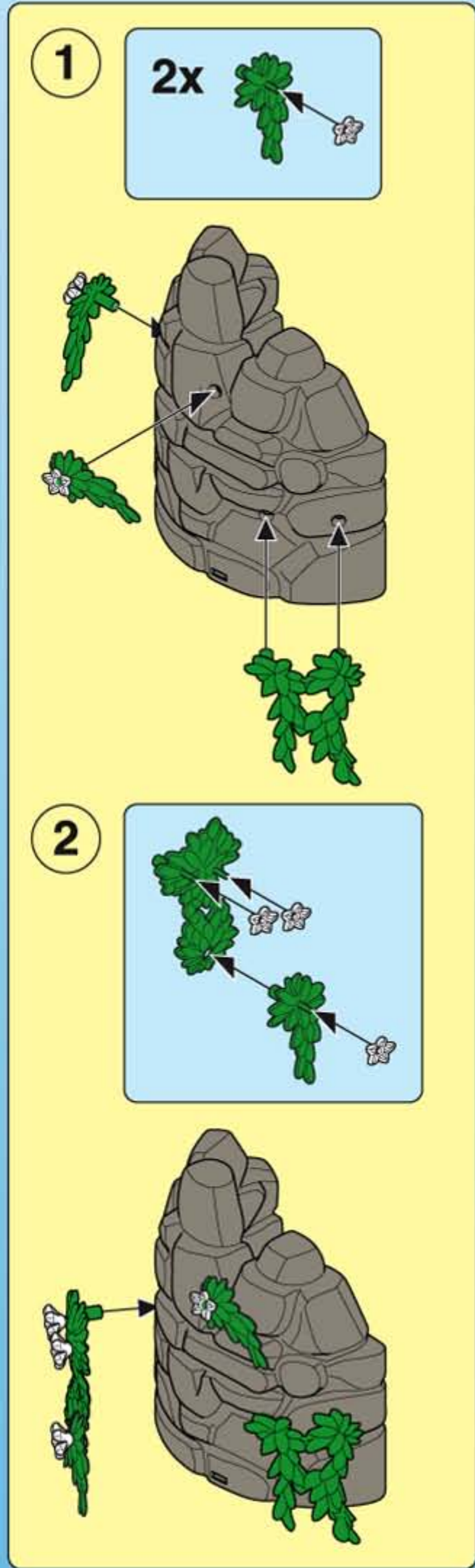

**5**



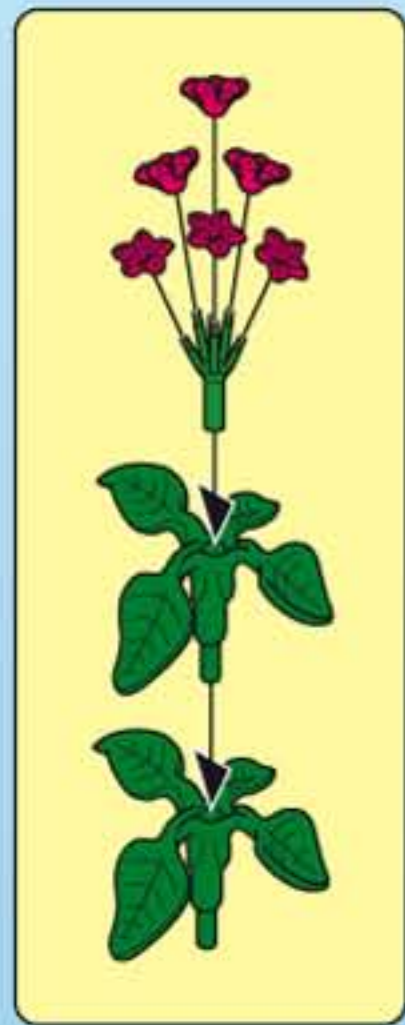

6



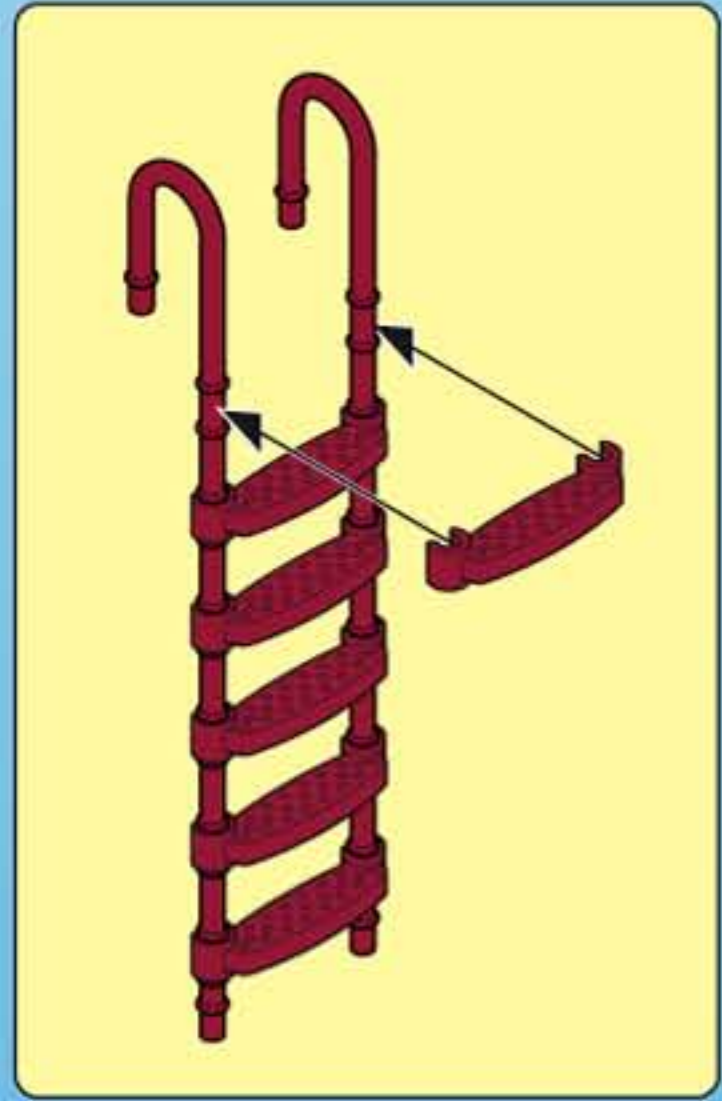
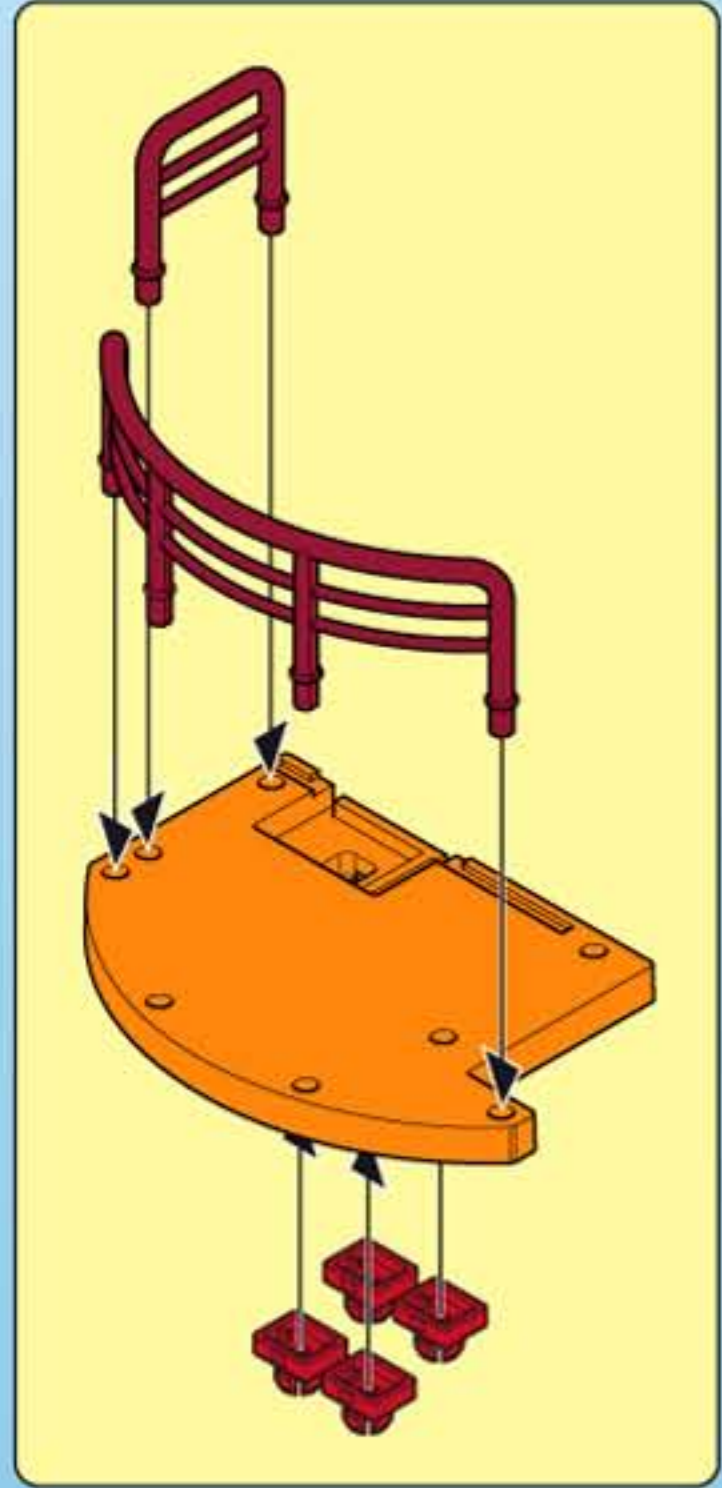

7

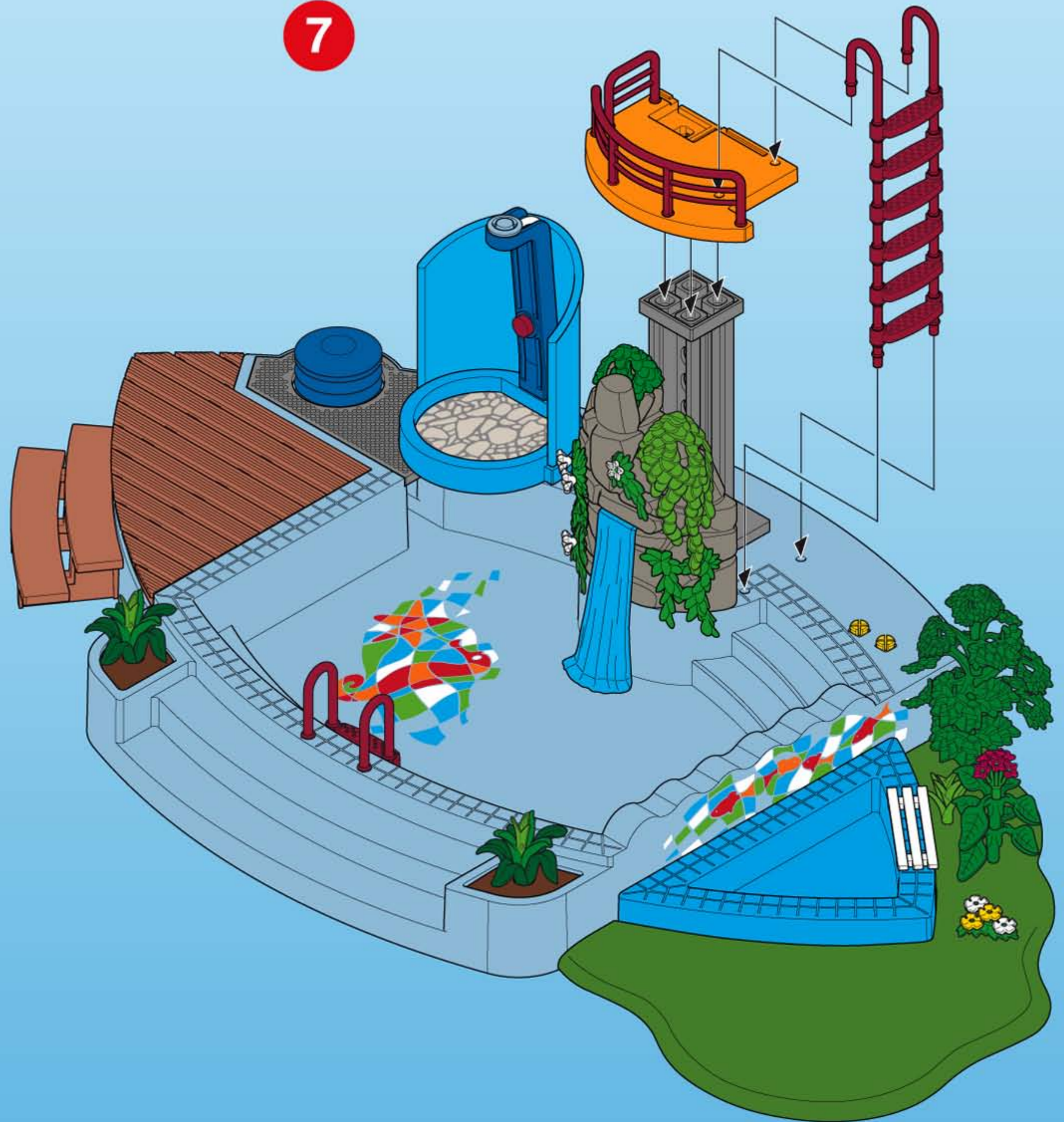

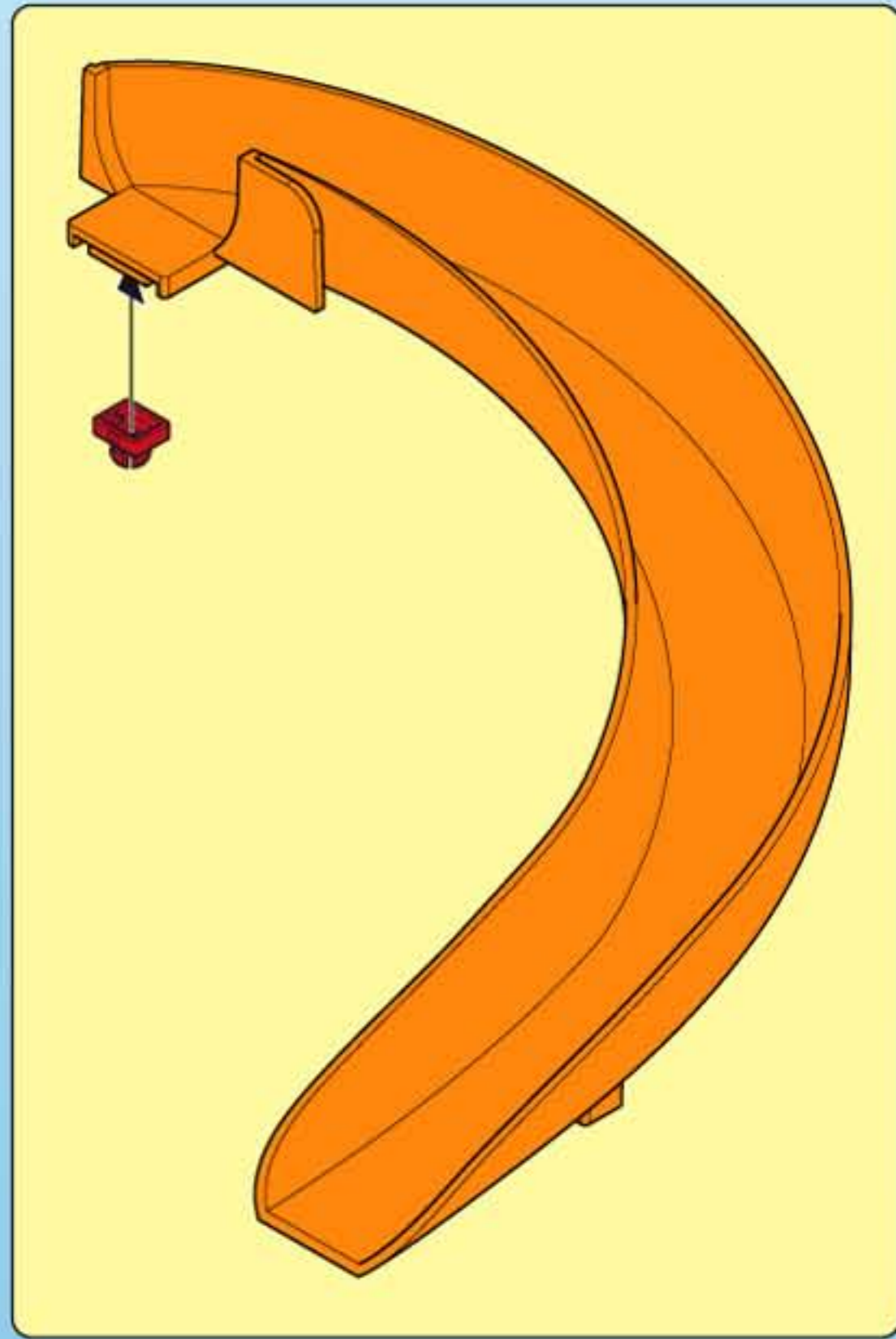

8





**(D A CH L B)** Nur Trinkwasser verwenden. Nach dem Spielen austrocknen lassen.

**(USA GB CDN M IRL)** Use only tap water. Dry thoroughly after play.

**(F CDN B L CH)** N'utiliser que de l'eau potable. Faire sécher après chaque utilisation.

**(E MEX)** Utilizar solamente agua potable. Dejar secar antes de guardar.

**(NL B)** Enkel drinkbaar water gebruiken. Na het spelen laten drogen.

**(I CH)** Usare solo acqua potabile. Asciugare bene dopo ogni uso.

**(P)** Utilizar somente água potável. Deixar secar antes de guardar.

**(DK)** Anvend kun drikkevand. Lad det tørre ud når du er færdig med at lege.

**(N)** Kun drikkevann skal benyttes. Tørk opp etter at leken er ferdig.

**(S FIN)** Använd endast dricksvatten. Låt torka efter användandet.

**(FIN)** Käytä ainoastaan juomavettä. Anna kuivua leikin jälkeen.

**(H)** Kérjük kizárólag ivóvizet használnjon! Játék után ajánlott a termék kiszáritása!

**(CZ)** Používat jen pitnou vodu. Po hraní nechat vyschnout.

**(EST)** Kasutada üksnes joogivett! Mängimise järel kuivatada!

**(LV)** Izmantot tikai dzeramo ūdeni. Pēc spēlēšanās ļaut nožūt.

**(LT)** Naudokite tik geriamąjį vandenį. Pažaidus, išdžiovinkite.

**(SLO)** V igračo vliivate le pitno vodo. Po igri naj se igrača posuši.

**(SK)** Používať iba pitnú vodu. Po hre nechať vyschnúť.

**(PL)** Używać tylko wodę pitną. Po zabawie pozostaw do wyschnięcia.

**(TR CY)** Sadece içme suyu kullanınız. Oyundan sonra kurumaya bırakın.

**(GR CY)** Χρησιμοποιείστε μόνο νερό βρύσης. Μόλις τελειώσετε, αφήστε το παιχνίδι να στεγνώσει εντελώς.

**(RO)** Se folosește doar apă potabilă. După joacă se lasă să se usuce.

**(BG)** Използвайте само питейна вода. След игра оставете да изсъхне.

**(CN)** 仅使用饮用水。玩耍后要干燥。



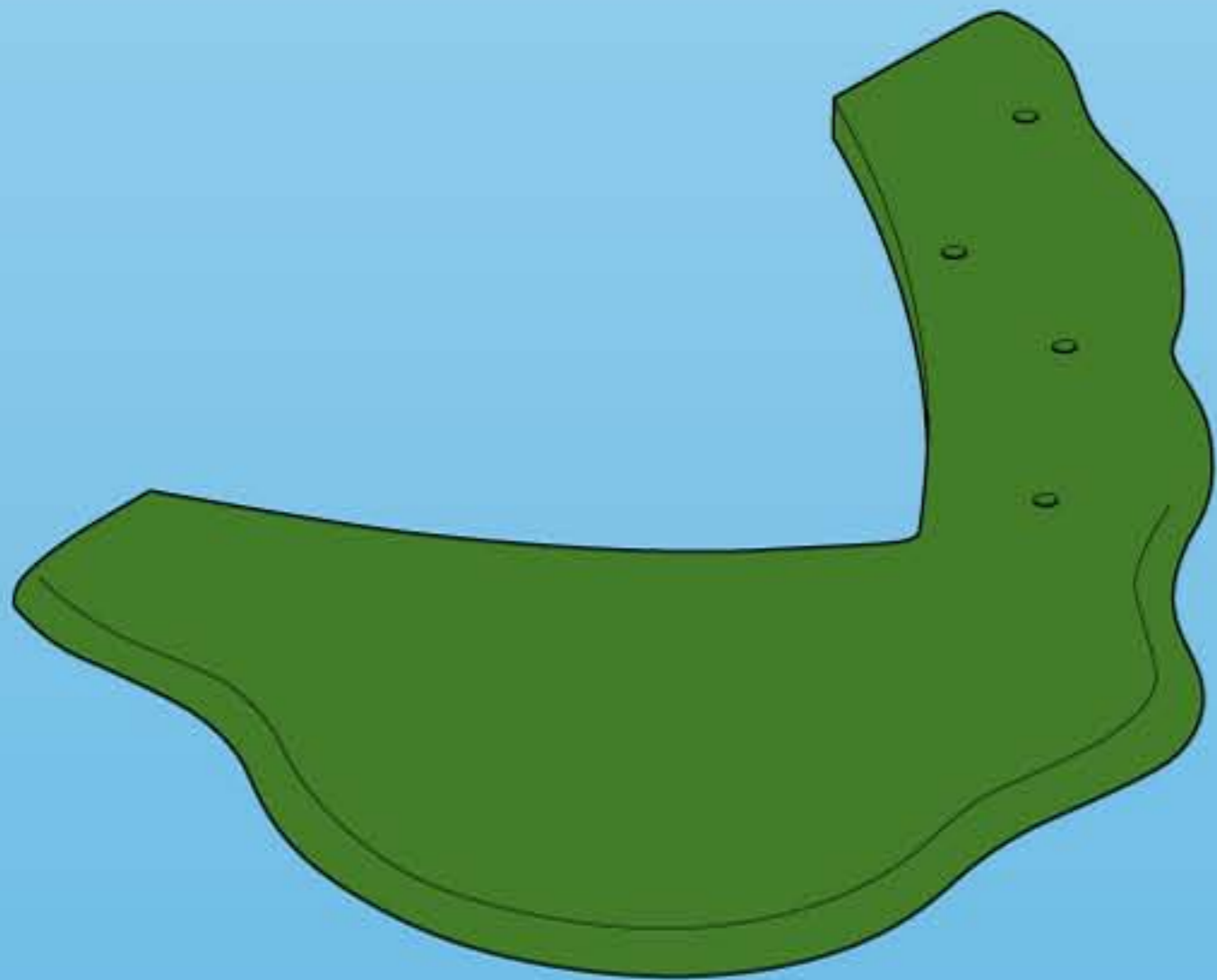
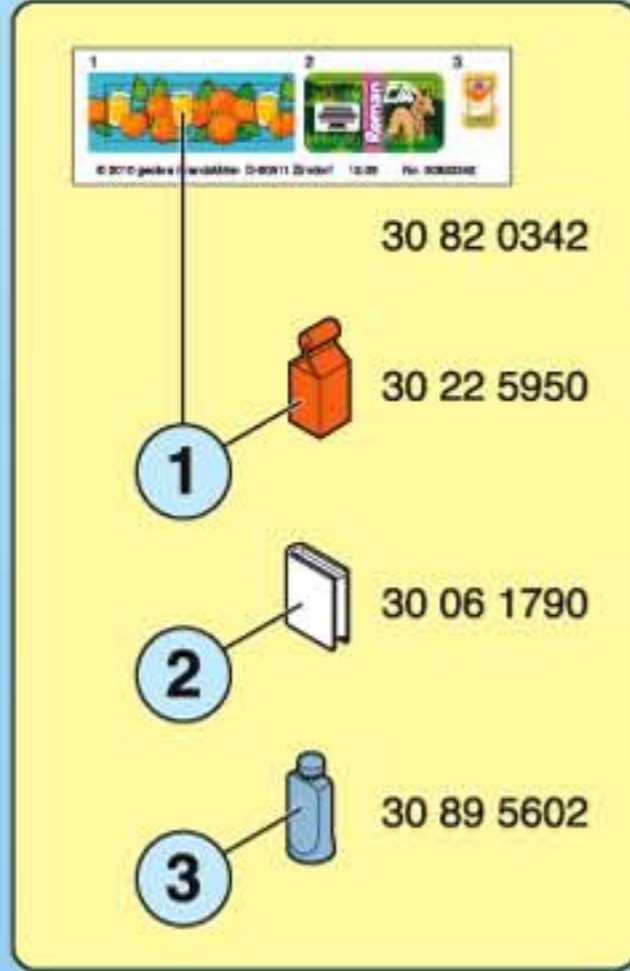
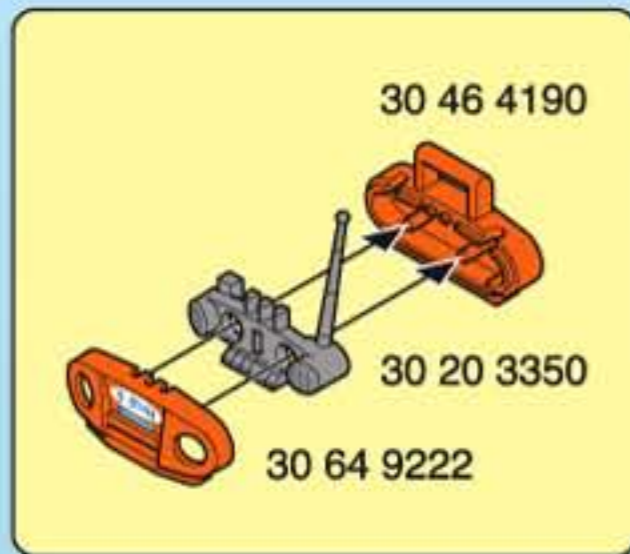
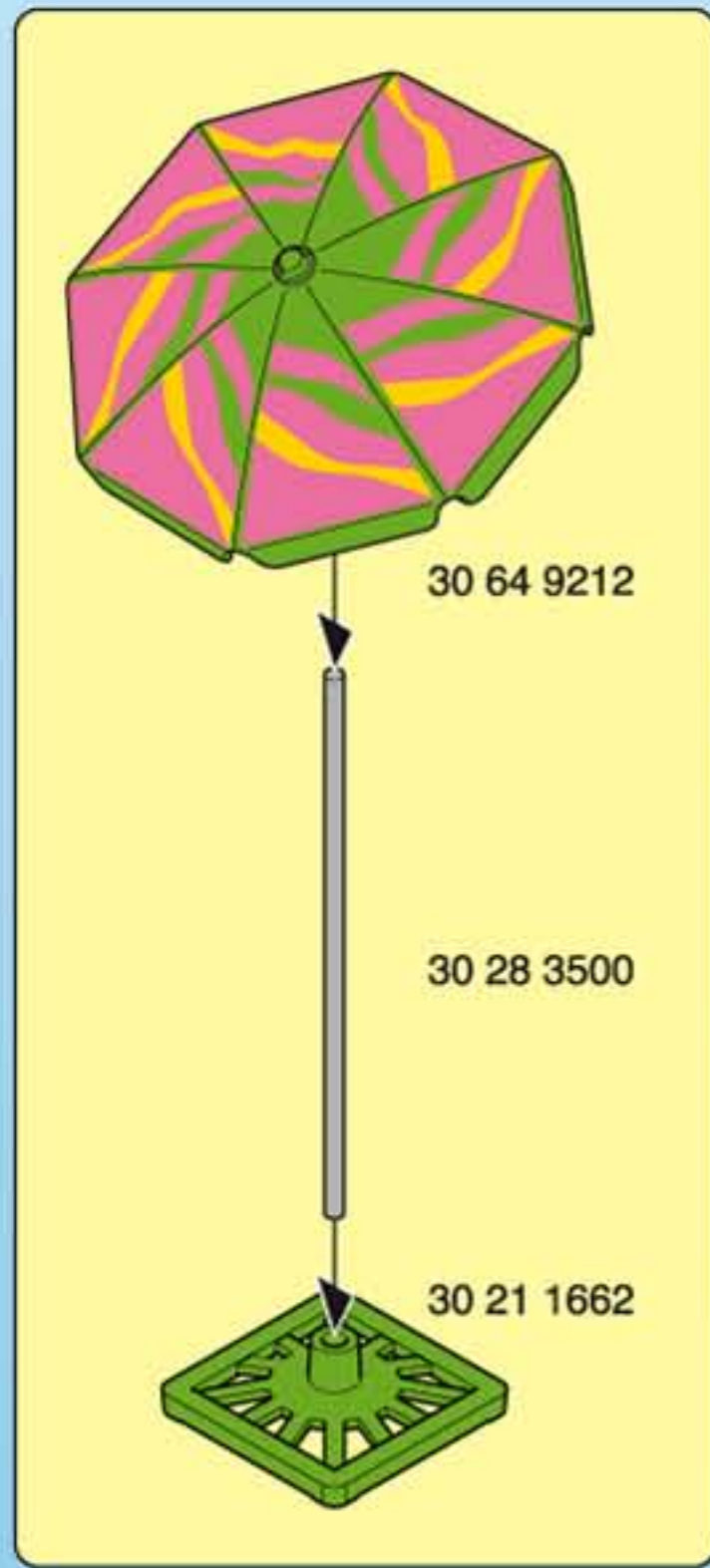

30 21 1592

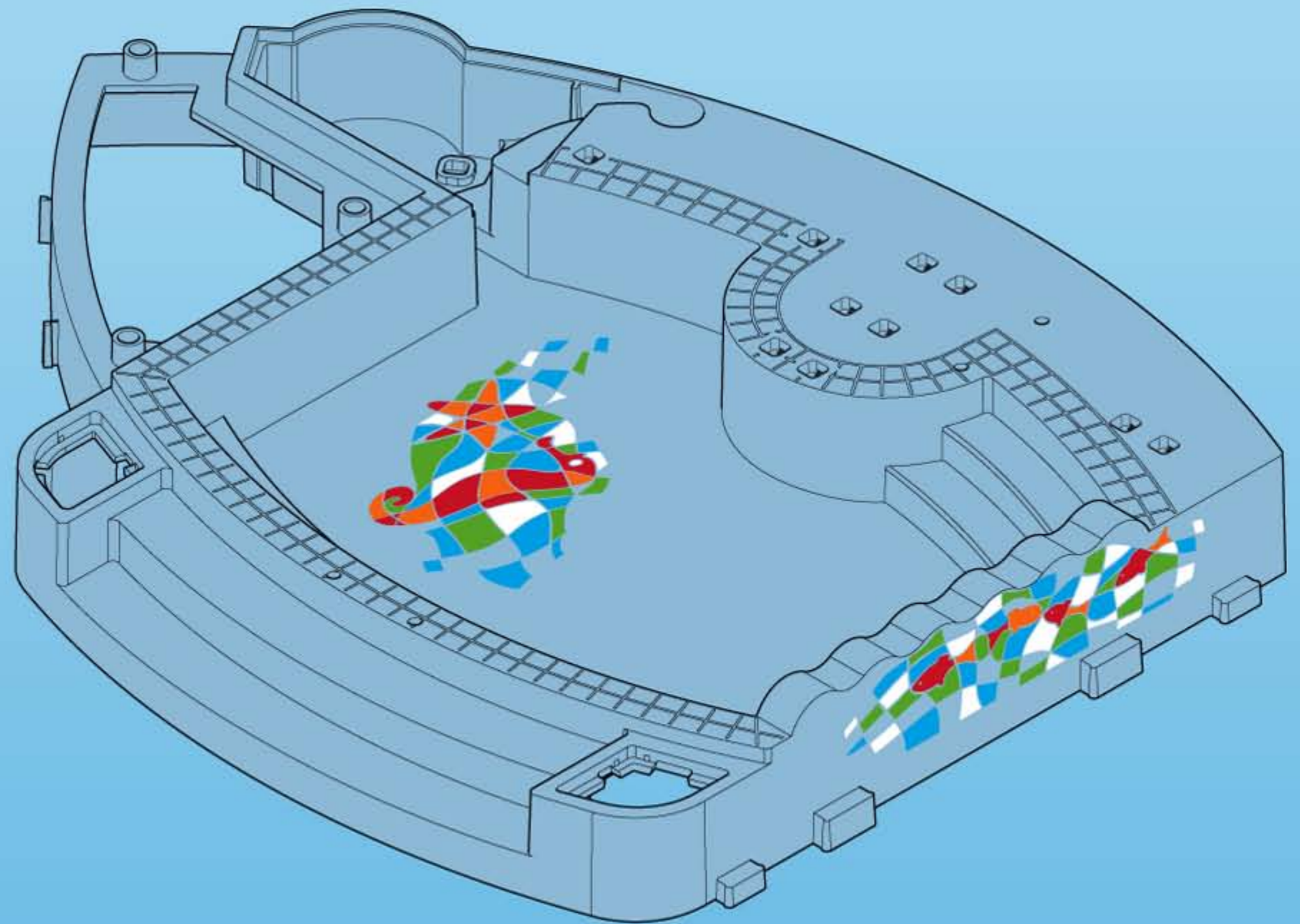

30 64 9172

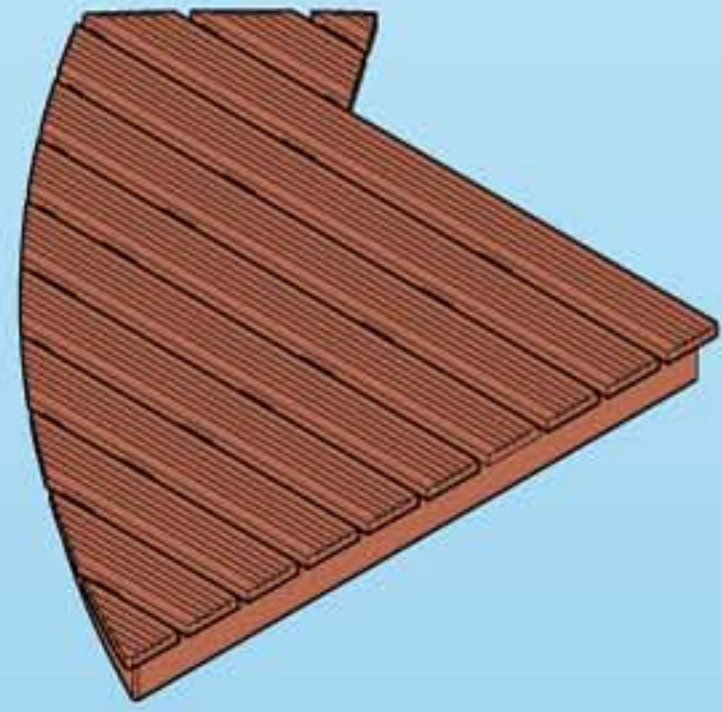

30 46 4210



30 65 9622



30 21 1542

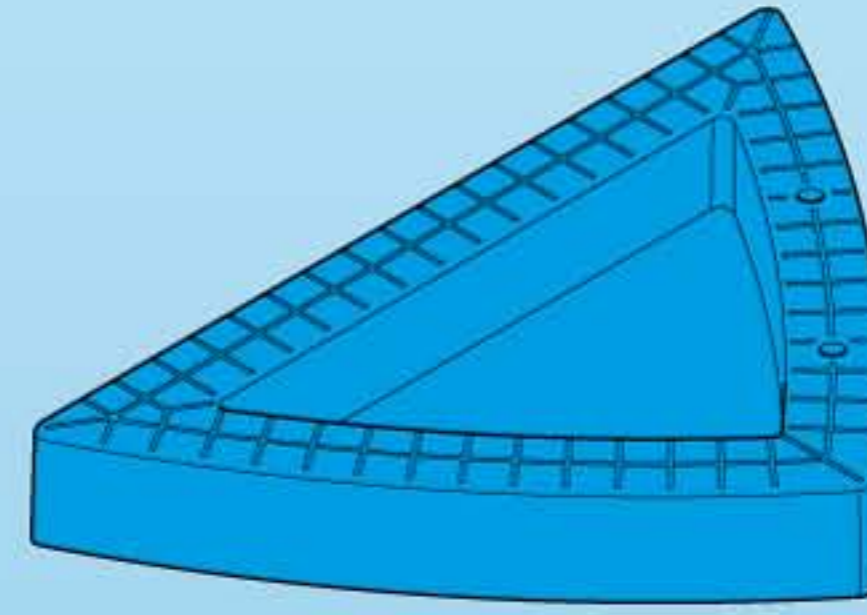

30 46 4220

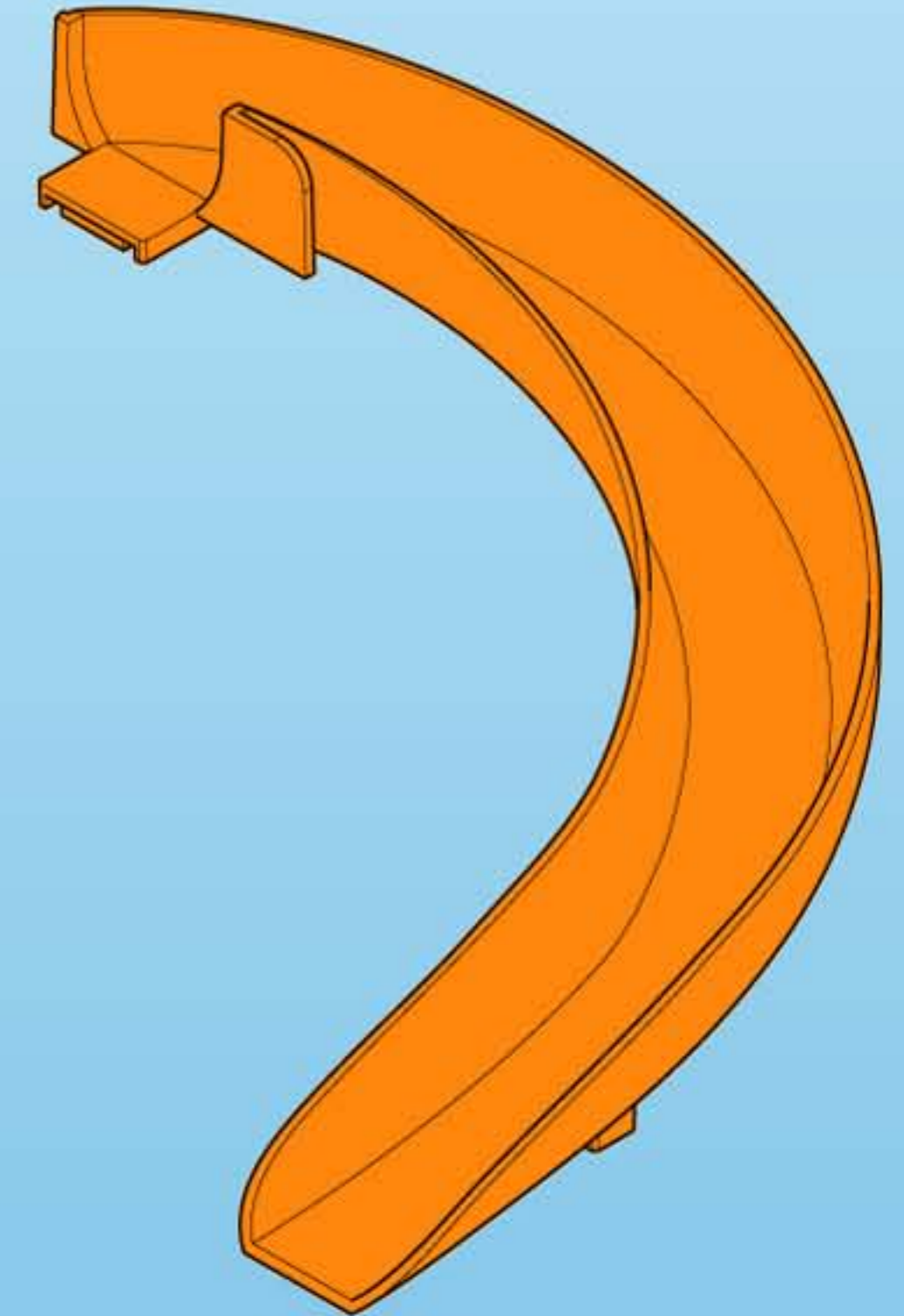

30 21 1522

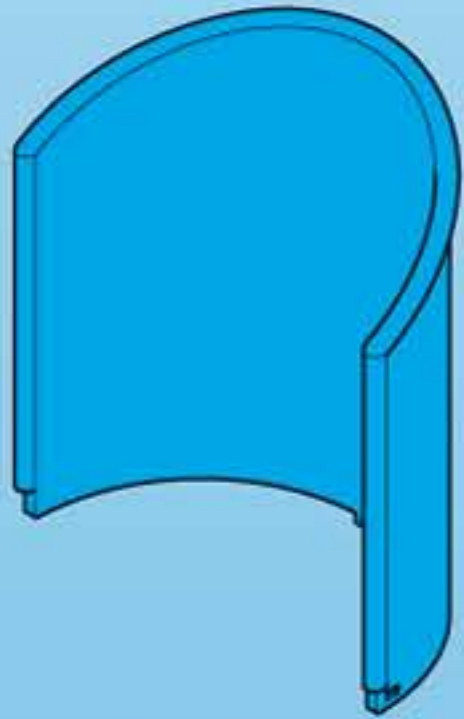

30 21 1532

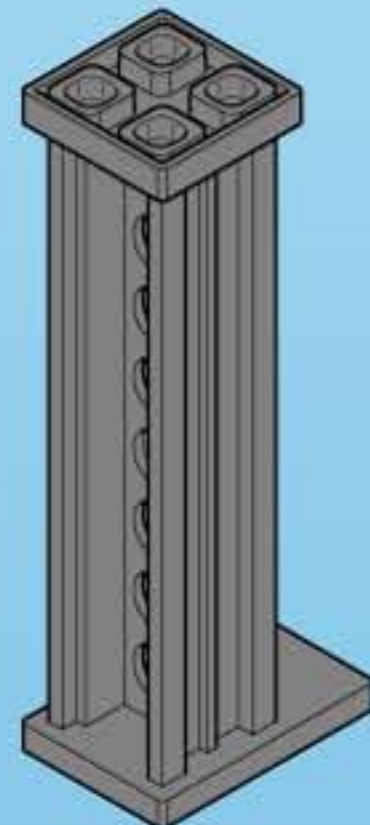

30 21 1502

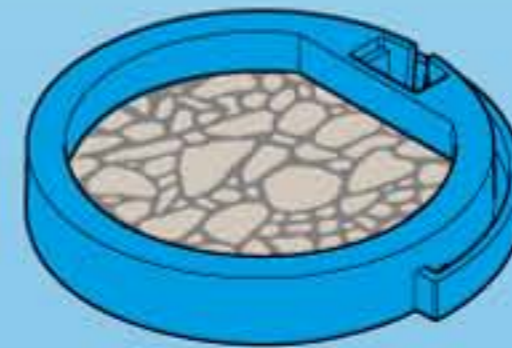

30 64 9182



30 46 4250



30 46 4200

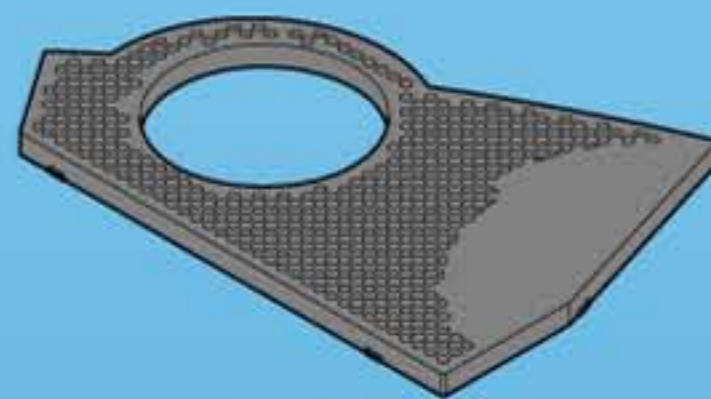

30 21 1562

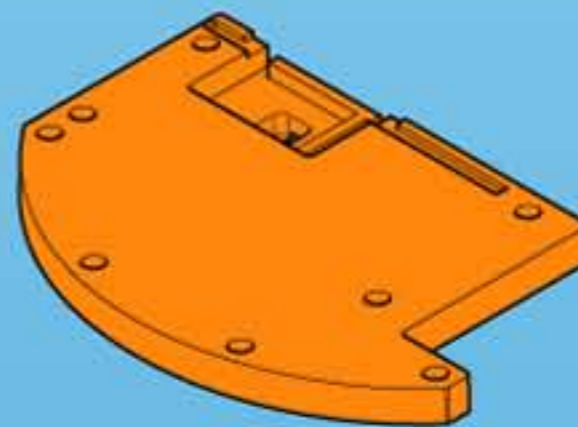

30 21 1512

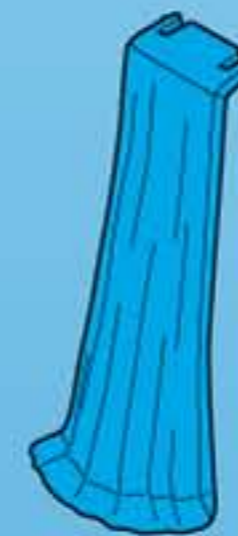

30 21 1632



30 88 8852



2x 30 21 1572

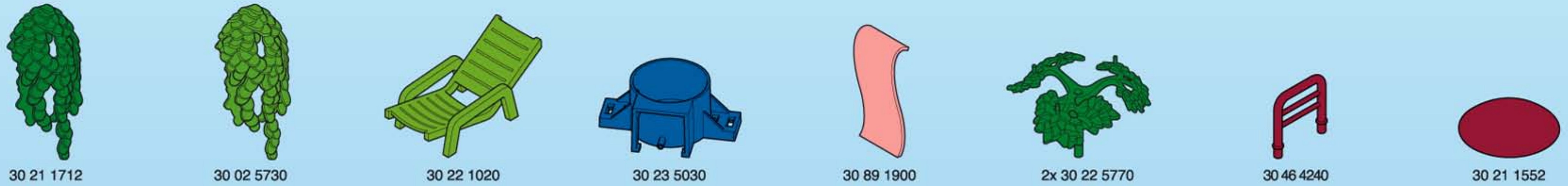

Serviceadressen finden Sie in allen Playmobil-Prospekten  
 In alle PLAYMOBIL catalogi vindt u het adres van onze klantendienst.  
 Addresses of Customer Service Departments are shown in all Playmobil catalogues  
 Las Direcciones de los Departamentos de Servicio al Consumidor se encuentran en todos los catálogos Playmobil  
 L'adresse du service consommateurs est indiquée dans tous les catalogues Playmobil  
 Η διεύθυνση του Γραφείου Εξυπηρέτησης Πελατών είναι καταχωρημένη σε όλους τους καταλόγους Playmobil  
 Troverete gli indirizzi dei centri di assistenza in tutti i cataloghi Playmobil  
 pronounce: play-mō-bēil