



Radyo / Kasetçalar - Radio / Cassette

Istanbul C73

7 643 815 310

Montaj Kılavuzu
Einbauanleitung
Installation instructions
Notice de montage
Istruzioni di installazione
Inbouwhandleiding
Instrucciones de instalación
Instruções de montagem
Monteringsvejledning



<http://www.blaupunkt.com>

 **BLAUPUNKT**

**Montaj kılavuzu • Einbauanleitung • Installation instructions •
Notice de montage • Istruzioni di installazione •
Inbowhandleiding • Instrucciones de instalación • Instruções de
montagem • Monteringsvejledning**

TR  **Emniyet Talimatları**

Montajı gerçekleştirirken ve bağlantıları yaparken lütfen aşağıdaki emniyet talimatlarını göz önünde bulundurunuz:

- Akünün eksi ucunu devre dışı bırakınız! Bunu yaparken, lütfen aracın üreticisinin emniyet talimatlarını göz önünde bulundurunuz.
- Matkapla delik açarken aracın herhangi bir kısmına hasar vermediğinizden emin olunuz.
- Artı ve eksi kablonun kesiti 1.5 mm²den daha küçük olmamalıdır.
- Aracın fişli konektörlerini radyonuzla **takmayınız!**
- Aracınızın türüne uygun adaptör kablosunu herhangi bir BLAUPUNKT satıcısından elde edebilirsiniz.
- Modele bağlı olarak, aracınız burada açıklaması yapılanlardan farklı olabilir. Doğru olmayan montaj veya bağlantı veya bunların herhangi bir hasarından dolayı oluşabilecek hiç bir hasar için sorumluluk kabul etmiyoruz. Eğer burada sağlanmış olan bilgiler size özgü montaj gereksinimlerinize uygun değilse, lütfen Blaupunkt satıcınızla, araç üreticinizle ya da direkt telefon hattımız ile temasa geçiniz.

Bir amplifikatörün veya değiştiricinin takılması durumunda, Line-In (hat girişi) veya Line-Out (hat çıkışı) fişi bağlantısı kurulmadan önce, kesinlikle cihazın şasi (toprak) bağlantıları kurulmalıdır.

D  **Sicherheitshinweise**

Für die Dauer der Montage und des Anschlusses beachten Sie bitte folgende Sicherheitshinweise.

- Minuspol der Batterie abklemmen! Dabei die Sicherheitshinweise des Kfz- Herstellers beachten.
- Beim Bohren von Löchern darauf achten, dass keine Fahrzeugteile beschädigt werden.
- Der Querschnitt des Plus- und Minuskabels darf 1,5 mm² nicht unterschreiten.
- Fahrzeugseitige Stecker **nicht** an das Radio anschließen!
- Die für Ihren Fahrzeugtyp erforderlichen Adapterkabel erhalten Sie im BLAUPUNKT – Fachhandel.
- Je nach Bauart kann Ihr Fahrzeug von dieser Beschreibung abweichen. Für Schäden durch Einbau- oder Anschlussfehler und für Folgeschäden übernehmen wir keine Haftung. Sollten die hier aufgeführten Hinweise für Ihren Einbau nicht passen, so wenden Sie sich bitte an Ihren Blaupunkt-Fachhändler, Ihren Fahrzeughersteller oder unsere Telefon-Hotline.

Bei Einbau eines Amplifier oder Changers müssen unbedingt erst die Gerätemassen angeschlossen werden, bevor die Stecker für die Line-In oder Line-Out Buchse kontaktiert werden.

GB  **Safety instructions**

When carrying out installation work and making connections please observe the following safety instructions:

- Disconnect the negative terminal of the battery! When doing so, please observe the vehicle manufacturer's safety instructions.
- Make sure you do not damage vehicle components when drilling any holes.
- The cross sections of the positive and negative cables must not be less than 1.5 mm².
- Do **not** connect the vehicle's plug connectors to the radio!
- You can obtain the adapter cable required for your vehicle type from any BLAUPUNKT dealer.
- Depending on the model, your vehicle may differ from the description provided here. We accept no responsibility for any damages due to incorrect installation or connection or for any consequential damages.
If the information provided here is not suitable for your specific installation requirements, please contact your Blaupunkt dealer, your vehicle manufacturer or our telephone hotline.

When installing an amplifier or changer, you must first connect the device earth connections before connecting the plugs for the line-in or line-out jacks.

F  **Consignes de sécurité**

Respecter les consignes de sécurité suivantes pendant la durée du montage et du branchement.

- Débrancher le pôle (-) de la batterie ! Respecter les consignes de sécurité du constructeur automobile !
- Veiller à n'endommager aucune pièce du véhicule en perçant des trous.
- La section du câble (+) et (-) ne doit pas dépasser 1,5 mm².
- **Ne pas** brancher les connecteurs du véhicule sur la radio !
- Les câbles d'adaptation nécessaires pour le type de véhicule sont disponibles auprès des revendeurs BLAUPUNKT.
- En fonction du modèle, votre véhicule peut différer de cette description. Nous déclinons toute responsabilité en cas de dommages causés par des erreurs de montage ou de connexion et en cas de dommages consécutifs. Si les indications décrites ici ne s'appliquent au montage que vous voulez effectuer, adressez-vous à votre revendeur Blaupunkt, votre constructeur automobile ou notre service d'assistance téléphonique.

Pour le montage d'un amplificateur ou changeur, les masses d'appareil doivent être d'abord connectées avant de connecter les fiches pour les connecteurs Line IN ou Line Out.

TÜRKÇE

DEUTSCH

ENGLISH

FRANÇAIS

ITALIANO

NEDERLANDS

ESPAÑOL

PORTUGUÊS

DANSK

Note di sicurezza

Durante il montaggio e l'allacciamento osservate per favore le seguenti istruzioni sulla sicurezza.

- Staccate il polo negativo della batteria ! Nel fare ciò osservate le istruzioni di sicurezza del fabbricante d'auto.
- Quando praticate dei fori, fate attenzione a non danneggiare nessuna parte dell'autovettura.
- La sezione dei cavi positivi e negativi non deve essere mai inferiore a 1,5 mm².
- **Non** collegate alla radio le spine in dotazione di autovettura !
- Richiedete ad un negoziante specializzato in articoli BLAUPUNKT il cavo di adattamento richiesto per il vostro modello di autovettura.
- A seconda del modello il Suo veicolo può differire da questa descrizione. Non forniamo garanzia per danni derivanti da errori di montaggio o di collegamento e per danni conseguenti.
Se le indicazioni qui elencate non sono adatte al Suo montaggio, La preghiamo di rivolgersi al Suo rivenditore Blaupunkt, al fabbricante dell'auto o alla nostra hotline telefonica.

Quando vengono montati un amplificatore o un multiletto CD, bisogna innanzi tutto allacciare le masse degli apparecchi prima di eseguire la connessione delle spine con le prese line-in e line-out.

Adviezen voor de veiligheid

Wilt u dedurende het monteren en aansluiten de volgende veiligheidsadviezen in acht nemen.

- De minpool van de batterij afklemmen! De veiligheidsadviezen van de fabrikant in acht nemen.
- Bij het gaten boren erop letten dat geen voertuigonderdelen worden beschadigd.
- De dwarsdoorsnede van de plus- en minkabel mag niet minder dan 1,5 mm² zijn.
- Stekker aan de voertuigkant **niet** aan de radio aansluiten!
- de voor uw voertuig vereiste adapterkabel is bij de BLAUPUNKT-vakhandel verkrijgbaar!
- Afhankelijk van de uitvoering kan uw auto afwijken van deze beschrijving. Voor schade door fouten in montage of aansluiting en schade als gevolg daarvan aanvaarden wij geen aansprakelijkheid. Mochten de hier vermelde aanwijzingen voor de montage voor u niet van toepassing zijn, dan kunt u contact opnemen met uw Blaupunkt-vakhandel, uw autofabrikant of onze telefoon-hotline.

Bij inbouw van een versterker of cd-wisselaar moeten eerst de massacontacten van de apparaten worden verbonden voordat de stekkers voor de line-in- of line-out-bussen worden aangesloten.

E  **Normas de seguridad**

Durante el montaje y la conexión es imprescindible observar las siguientes normas de seguridad.

- Desemborne el polo negativo de la batería. Observe las normas de seguridad dadas por el fabricante del vehículo.
- Al perforar agujeros, asegúrese de no dañar ninguna pieza del vehículo.
- La sección transversal del cable positivo y del cable negativo no debe ser menor de 1,5 mm².
- **¡No** conecte a la radio los conectores ubicados en el vehículo!
- Los cables adaptadores necesarios para su vehículo los encontrará en el comercio especializado en artículos de la marca BLAUPUNKT.
- Dependiendo del modelo, es posible que su vehículo varíe un poco con respecto a la descripción aquí dada. Tenga en cuenta que no asumimos ninguna responsabilidad por los daños debidos a un montaje o conexión incorrectos ni por los daños resultantes. Si las instrucciones aquí dadas no son aptas para el montaje en su vehículo, póngase en contacto con su proveedor de artículos Blaupunkt o con el fabricante del vehículo, o llame a nuestro teléfono de atención al cliente.

En caso de montar un amplificador o un cambiadiscos, es necesario conectar la puesta a tierra de las unidades antes de establecer el contacto de los conectores para las hembrillas Line-In y Line-Out.

P  **Instruções de segurança**

Durante a montagem e a ligação do aparelho, queira respeitar as seguintes instruções de segurança.

- Separar o pólo negativo da bateria ! Respeitar ao mesmo tempo as instruções de segurança do fabricante do automóvel.
- Quando se procede à furagem de buracos, prestar atenção para não serem danificadas quaisquer partes do veículo.
- As secções transversais dos cabos positivo e negativo não devem ser inferiores a 1,5 mm².
- **Não** ligar as fichas existentes do lado do automóvel ao auto-rádio!
- Os cabos adaptadores necessários para o seu automóvel podem ser adquiridos nos revendedores da BLAUPUNKT.
- O seu veículo pode divergir desta descrição em função do modelo. Não assumimos qualquer responsabilidade por erros de montagem ou de ligação nem por danos daí decorrentes. Caso as presentes instruções não sejam adequadas para a montagem no seu veículo, dirija-se ao revendedor da Blaupunkt, ao fabricante do seu veículo ou à nossa linha verde.

No caso de montagem de um amplificador ou leitor multi-CD, é imprescindível ligar primeiro os aparelhos à terra antes de se conectar as fichas às tomadas Line In ou Line Out.

  **Sikkerhedshenvisninger**

Under monteringen og tilslutningen skal følgende sikkerhedshenvisninger iagttages.

- Batteriets negative pol skal afbrydes! Herved skal bilfabrikantens sikkerhedshenvisninger iagttages.
- Vær opmærksom på, at ingen bildele ødelægges under boringen af huller.
- Tværsnittet af plus- og minuskablet må ikke underskride 1,5 mm².
- Bilens stik må **ikke** tilsluttes radioen!
- De nødvendige adapterkabler til din biltype kan købes hos BLAUPUNKT-specialforretningen.
- Alt efter konstruktion kan bilen afvige fra denne beskrivelse. For skader på grund af monterings- eller tilslutningsfejl og for følgeskader overtager vi intet ansvar. Hvis de her anførte henvisninger til monteringen ikke skulle passe, kontakt din Blaupunkt-specialforretning, bilfabrikanten eller vor telefon-hotline.

Ved montering af en forstærker eller et Multi CD-apparat skal apparaternes stel først tilsluttes, før stikkene for tilslutningerne Line-In eller Line-Out sættes i.

**Birlikte verilen montaj ve
bağlantı parçaları**

**Mitgelieferte Montage- und
Anschlussteile**

Supplied Mounting Hardware

Materiel de montage fourni

**Ferreteria de montaje
suministrada**

**Componenti di fissaggio
comprese nella fornitura**

**Medföljande
monteringsdetaljer**

**Elementos de fixação
fornecidos.**

**Medleverede monterings- og
tilslutningsdele**

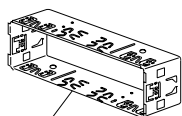

A

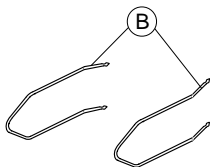

B



C



D



E



F

1.

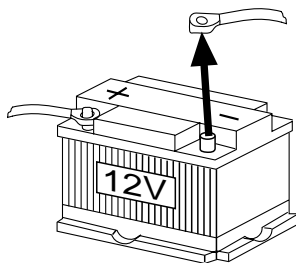

2.

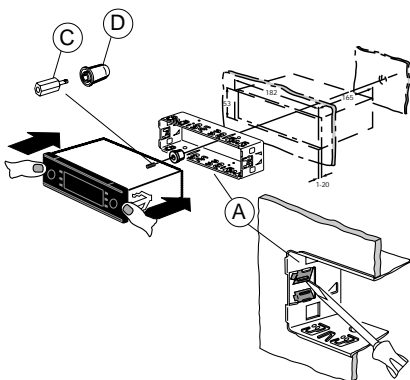

3.

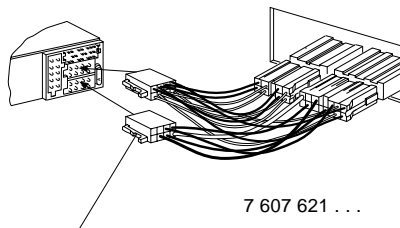

Araca özgü adaptör kablolarını, yetkili satıcılarda bulabilirsiniz.

Kfz-spezifische Adapterkabel sind im Fachhandel erhältlich.

Car-specific adapter cable which is available at your dealer.

Câble adaptateur spécifique au véhicule, disponible dans le commerce.

Adattamento specifico per il vostro modello d'auto, che potrete trovare in negozi specializzati.

Autospecifieke adapterkabel, die bij de vakhandel te verkrijgen is.

Adaptador específico del vehículo, el cual se puede adquirir en el comercio especializado.

Cabo de adaptação específico do automóvel que pode ser adquirido no comércio especializado.

Bilspecifikke adapterkabler kan købes i specialforretninger.

Sub out cable

7 607 609 093

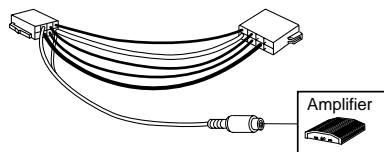

4.

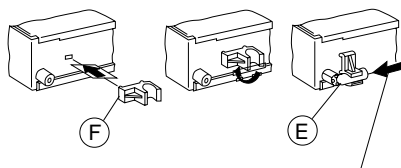

Anten /
Antenne

5. Sökülmesi/Ausbau/Uninstalling

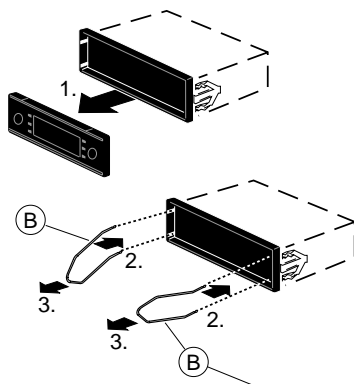

8 601 910 003

6.

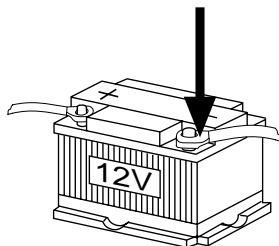

7.

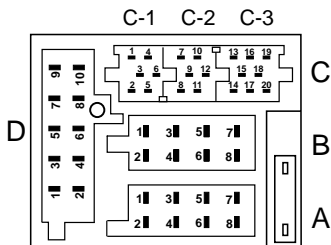

- Aut. antenna
- * FB +12V / RC +12V
- +12V Amplifier

Toplam
Summe
Sum
Somme
EI Zumbid
Zumbam

400 mA

A		B	
1	Automatic Sound	1	Speaker out RR+
2	Radio Mute	2	Speaker out RR-
3	Sub out	3	Speaker out RF+
4	Permanent +12V	4	Speaker out RF-
5	Aut. antenna*	5	Speaker out LF+
6	Illumination	6	Speaker out LF-
7	Kl.15/Ignition	7	Speaker out LR+
8	Ground	8	Speaker out LR-

D	
1	AUX 2- NF L
2	AUX 2- NF R
3	AUX 2- REF
4	NC
5	NC
6	NC
7	NC
8	NC
9	MIC GND
10	MIC INPUT

C					
C1		C2		C3	
1	Line Out LR	7	Telefon / Navi NF in +	13	Bus - In
2	Line Out RR	8	Telefon / Navi NF in -	14	Bus - Out
3	Line Out Masse / Ground	9	Radio / Navi Mute	15	Permanent +12V
4	Line Out LF	10	FB +12V / RC +12V *	16	+12V *
5	Line Out RF	11	Fernbedienung / Remote Control	17	Bus - Masse / GND
6	+12V Amplifier *	12	FB - Masse / RC - GND	18	AF - Masse / GND
				19	Line In - L
				20	Line In - R

Ekolayzer
Equalizer



Amplifikatör
Amplifier

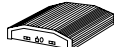

Uzaktan kumanda
Remote Control



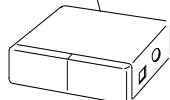

Telefon NF in



CD deęiřtirici
CD-Changer

8.

	Aut. antenna
* 	FB +12V / RC +12V
	+12V Amplifier
Toplam	400 mA
Summe	
Sum	
Somme	
EI Zumbid	
Zumbam	

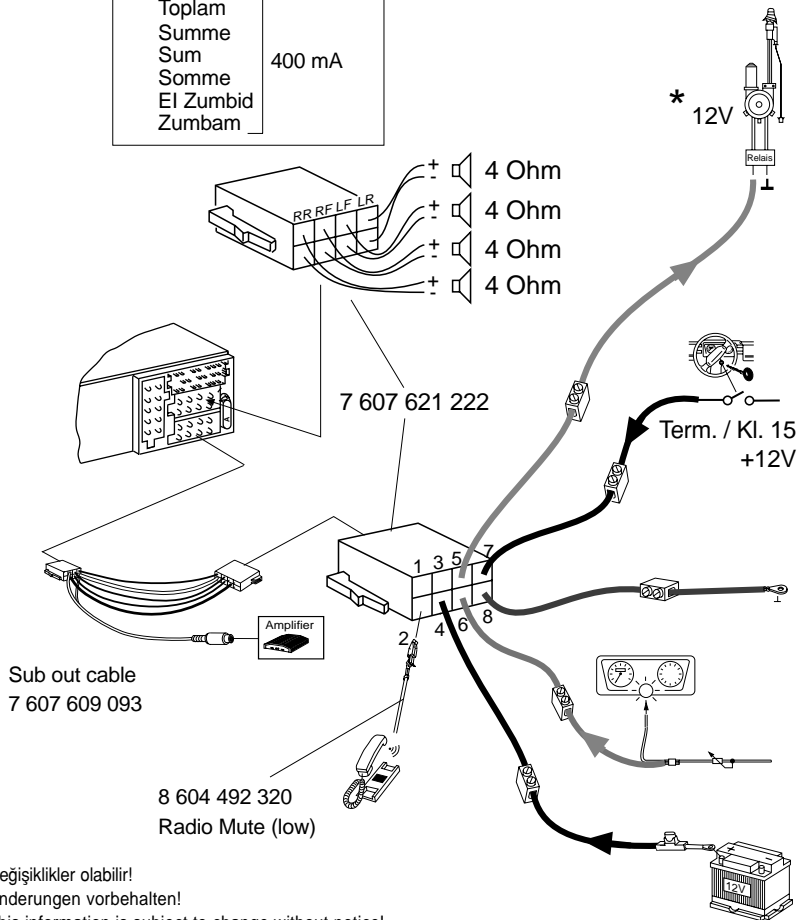

Değişiklikler olabilir!
Änderungen vorbehalten!
This information is subject to change without notice!
Sous réserve de modifications!
Modifiche riservate!
Wijzigingen voorbehouden!
Modificaciones reservadas!
Sob reserva de alterações!
Ret til ændringer forbeholdes!