



Radio | CD | MP3 | WMA

Milano MP28	7 648 493 110
Monte Carlo MP28	7 648 483 110
San Remo MP28	7 648 491 110



Bedienungs- und Einbauanleitung
Operating and installation instructions
Mode d'emploi et de montage
Istruzioni d'uso e di installazione
Gebruiksaanwijzing en inbouwhandleiding
Bruks- och monteringsanvisning

 **BLAUPUNKT**

Milano/Monte Carlo MP28

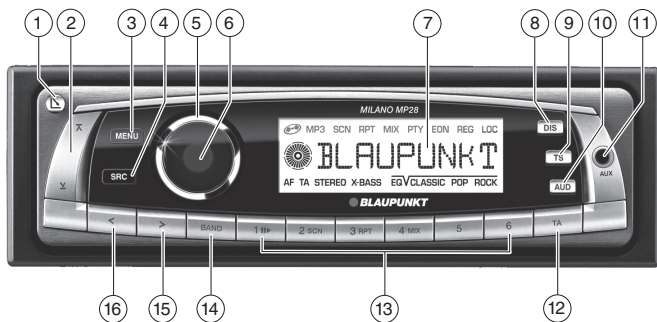



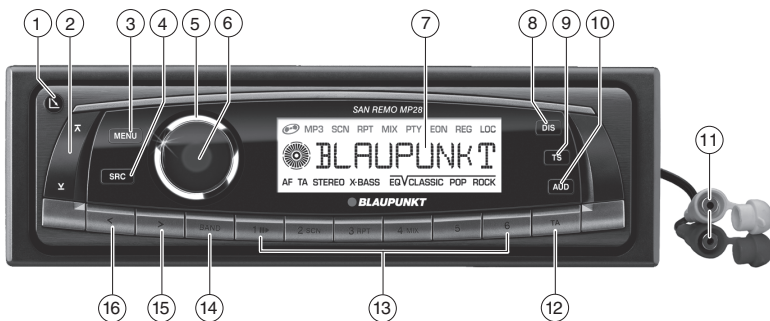

San Remo MP28

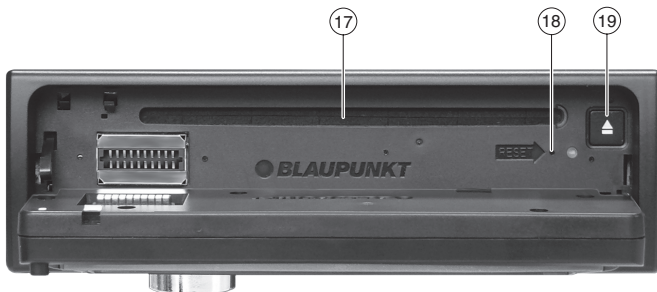

Milano/Monte Carlo/San Remo MP28



- ①  button
Opens the detachable control panel (flip-release panel).
- ② Rocker switch
- ③ **MENU** button
Calls up the menu for basic settings.
- ④ **SRC** button
Source selection between radio, CD and AUX.
- ⑤ Volume control
- ⑥ On/Off button
Short press: Switches the device on. In operation: Mutes the device.
Long press: Switches the device off.
- ⑦ Display
- ⑧ **DIS** button
Changes display contents.
- ⑨ **TS** button
Starts the Travelstore function.
- ⑩ **AUD** button
Sets bass, treble, middle, balance, and fader.
Switches X-BASS on/off and adjusts it.
Selects an equalizer presetting.
- ⑪ AUX input
- ⑫ **TA** button
Starts the traffic announcement function. Traffic announcements have priority over radio or CD mode.
- ⑬ Numeric keypad
- ⑭ **BAND** button
Selects the FM memory banks and the MW and LW wavebands.
- ⑮  arrow button
Short press: Radio mode: manual search in selected frequency band.
CD/MP3/WMA mode: next track.
Long press: Radio mode: automatic seek tuning in selected frequency band.
CD/MP3/WMA mode: fast forward.
- ⑯  arrow button
Short press: Radio mode: manual search in selected frequency band.
CD/MP3/WMA mode: previous track.
Long press: Radio mode: automatic seek tuning in selected frequency band.
CD/MP3/WMA mode: fast reverse.
- ⑰ CD tray
- ⑱ Reset button
Can be activated only with a pointed object.
- ⑲  button (eject)
Ejects the CD from the device

About these instructions	32	Radio mode	38
Symbols used.....	32	Adjusting the tuner.....	38
Use as directed.....	32	Switching to radio mode	39
Declaration of conformity.....	32	RDS	39
For your safety	33	Selecting the waveband/ memory bank	40
If you are installing device yourself.....	33	Tuning into a station	40
Observe the following!.....	33	Setting the sensitivity of station seek tuning	40
Cleaning instructions.....	33	Storing stations	41
Disposal of old unit	33	Listening to stored stations	41
Scope of delivery	34	Programme type (PTY)	41
Optional equipment (not part of the scope of delivery)	34	Traffic information.....	42
Warranty.....	34	Switching traffic information priority on/off	42
Service	34	Setting the volume for traffic announcements.....	43
Detachable control panel	35	CD mode	43
Theft protection.....	35	Switching to CD mode	43
Detaching the control panel.....	35	Selecting tracks.....	44
Attaching the control panel.....	35	Fast searching (audible).....	44
Timeout function	36	Random track play (MIX)	44
Switching on/off.....	36	Scanning tracks (SCAN).....	44
Switching on/off	36	Repeating tracks (REPEAT)	45
Switching on/off using the vehicle ignition.....	36	Interrupting playback (PAUSE).....	45
Switching off with detachable control panel.....	36	Configuring the display	45
Adjusting the volume	37	Traffic announcements in CD mode....	45
Power-on volume	37	Ejecting a CD.....	45
Quickly reducing the volume (MUTE)	37	MP3/WMA mode	46
Muting during telephone mode	37	Preparing an MP3/WMA CD.....	46
Switching the confirmation beep on/off	37	Switching to MP3 mode	47
		Configuring the display	47
		Selecting a directory	47
		Selecting tracks/files	47
		Fast searching (audible).....	47
		Random track play (MIX)	48
		Scanning tracks (SCAN).....	48
		Repeating tracks (REPEAT)	48
		Interrupting playback (PAUSE).....	48

Menu settings.....	49
Setting the time	49
Selecting 12/24-hour clock mode	49
Loading standard settings	49
Switching the AUX input on/off	50
Adjusting the display brightness.....	50
Sound	50
Adjusting the bass	50
Adjusting the treble	50
Setting the left/right volume distribution (balance).....	51
Adjusting the front/rear volume distribution (fader)	51
X-BASS	51
Equalizer presettings (presets)	52
External audio sources	52
Resetting the device (Reset)	53
Technical data	53
Amplifier	53
Tuner	53
CD	53
Preamp Out	53
AUX input sensitivity	53
Installation instructions	156

About these instructions

These instructions contain important information to easily and safely install and operate the device.

- Read these instructions carefully and completely before using the device.
- Keep the instructions at a location so that they are always accessible to all users.
- Always pass on the device to third parties together with these instructions.

In addition, observe the instructions of the devices used in conjunction with this device.

Symbols used

These instructions employ the following symbols:



CAUTION!

Warns about laser beam



DANGER!

Warns about injuries



CAUTION!

Warns about damaging the CD drive



The CE mark confirms the compliance with EU directives.

➔ Identifies a sequencing step

- Identifies a listing

Use as directed

This device is intended for installation and operation in a vehicle with 12 V vehicle system voltage and must be installed in a DIN slot. Observe the performance limits in the technical data. Repairs and installation, if necessary, should be performed by a specialist.

Declaration of conformity

The Blaupunkt GmbH declares that the device complies with the basic requirements and the other relevant regulations of the directive 89/336/EWG.

For your safety

The device was manufactured according to the state of the art and established safety guidelines. Even so, dangers may occur if you do not observe the safety notes in these instructions.

If you are installing device yourself

You may only install the device yourself if you are experienced in installing car sound systems and are very familiar with the electrical system of the vehicle. For this purpose, observe the installation instructions at the end of these instructions.

Observe the following!



CAUTION!

The device contains a Class 1 laser that can cause injuries to your eyes.

Do not open the device and do not perform any modifications.



DANGER!

Increased risk of injury from connector

In case of an accident, the protruding connector in the front AUX-IN socket may cause injuries. The use of straight plugs or adaptors can lead to an increased risk of injury.

- It is, therefore, recommended to use angled jack plugs, e.g. the Blaupunkt accessories cable (7 607 001 535).

In operation:

- Operate the device only if traffic situation permits it! Stop at a suitable location to perform more extensive operations.
- Remove or attach the control panel only while the vehicle is standing an.
- To protect your hearing, always listen at a moderate volume. During mute phases (e.g. when changing the audio source), changing the volume is not audible. Do not increase the volume during this mute phase.
- Always listen at a moderate volume so that you can always hear acoustic warning signals (e.g. police).

After operation:

- The device is worthless to a thief without the control panel. Always remove the control panel whenever you leave the vehicle.
- Transport the control panel so that it is protected against impacts and the contacts cannot become dirty.

Cleaning instructions

Solvents, cleaning and scouring agents as well as dashboard spray and plastics care product may contain ingredients that will damage the surface of the device.

Use only a dry or slightly moistened cloth for cleaning the device.

Disposal of old unit



Do not dispose of your old unit in the household trash!

Use the return and collection systems available to dispose of the old device.

Scope of delivery

The scope of delivery includes:

- 1 Car sound system
- 1 Support frame
- 2 Disassembly tools
- 1 Perforated strips
- 1 Case
- 1 Operating instructions

Optional equipment (not part of the scope of delivery)

Use only accessories approved by Blaupunkt.

Remote control

The steering wheel and/or handheld remote control allows you to access the basic functions of your car sound system safely and conveniently.

You cannot switch the device on/off using the remote control!

You can find out from your Blaupunkt dealer or on the Internet at www.blaupunkt.com which remote controls can be used with your car sound system.

Amplifier

You can use all Blaupunkt and Velocity amplifiers.

Warranty

We provide a manufacturer's warranty for products bought within the European Union. For devices purchased outside the European Union, the warranty terms issued by our respective responsible domestic agency are valid.

The warranty terms can be called up under www.blaupunkt.com or requested directly from:

Blaupunkt GmbH
Hotline
Robert-Bosch-Str. 200
D-31139 Hildesheim, Germany

Service

In some countries, Blaupunkt offers a repair and pick-up service.

Information about the availability of this service in your country can be found at www.blaupunkt.com.

If you want to take advantage of this service, you may request a pick-up service for your device via the Internet.

Detachable control panel

Theft protection

The device is equipped with a detachable control panel (flip-release panel) as a way of protecting your equipment against theft. The device is worthless to a thief without this control panel.

Protect your device against theft by taking the control panel with you whenever you leave your vehicle. Do not leave the control panel inside your vehicle - not even in a hidden place.

Notes:

- Never drop the control panel.
- Do not expose the control panel to direct sunlight or another heat source.
- Avoid direct skin contact with the control panel's electrical contacts. If necessary, clean the contacts with a lint-free cloth moistened with cleaning alcohol.

Detaching the control panel

➤ press the  button ①.

The control panel opens to the bottom.

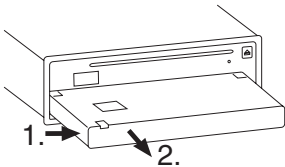

- Grasp the control panel at the left side.
- Push the control panel slightly to the right and then pull it **straight** out of the bracket.

Notes:

- The device switches off as soon as the control panel is removed. The device remembers the audio source played last for the next switch-on.
- Any CD already inserted in the device remains there.

Attaching the control panel

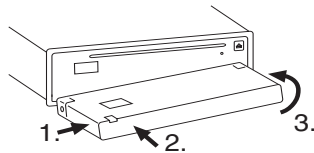

- Insert the control panel on the right side and press it slightly to the right (see Figure 1.).
- Carefully press the control panel into the left bracket until it engages (see Figure 2.).
- Fold the control panel up into the slot and press it gently into place until it engages (see Figure 3.).

If the device was still switched on when you detached the control panel, it will automatically switch on with the last setting activated (radio, CD or AUX) when the panel is replaced.

Timeout function

The device features a time-out function (time window).

For example, if you press the **MENU** button ③ and select a menu item, the device switches back after approx. 5 seconds after the last button activation. The settings performed are saved.

Switching on/off

You can switch on the device with any button.

Switching on/off

To switch on the device,

➡ press any button.

The device switches on.

➡ To switch off the device, press and hold down the On/Off button ⑥ for longer than 2 seconds.

The device switches off.

Switching on/off using the vehicle ignition

The device will switch on/off simultaneously with the ignition if the device is correctly connected to the vehicle's ignition as shown in the installation instructions and you did not switch the device off by pressing the On/Off button ⑥.

Switching off with detachable control panel

➡ Detach the control panel.

The device switches off.

Note:

To protect the vehicle battery, the device will switch off automatically after one hour if the ignition is off.

Adjusting the volume

You can adjust the volume in increments from 0 (off) to 100 (maximum).

To increase the volume,

- turn the volume control (5) clockwise.

To decrease the volume,

- turn the volume control (5) counter-clockwise.

Power-on volume

When you switch off the device, the volume selected last is stored.

When you switch on the device, the stored volume is selected.

Quickly reducing the volume (MUTE)

You can quickly reduce the volume to a preset level.

- Briefly press the On/Off button (6).

The display shows "MUTE".

Cancelling mute

To return to your previously set volume level,

- briefly press the On/Off button (6) again.

Muting during telephone mode

If your car sound system is connected to a cell phone, the car sound system is muted when you answer a call.

Note:

During a phone call, no traffic announcements are switched through.

There are hands-free systems that activate the mute function of the radio with a LOW signal (0 V) or HIGH signal (12 V). This information can be found in the operating instructions of your hands-free system. In the menu, you can select whether the radio should mute during an incoming call using a HIGH or a LOW signal:

- Press the **MENU** button (3).
- Press the \surd or ∇ button (2) repeatedly until "TEL MUTE" appears on the display.
- Press the \gt button (15) to select among "HIGH/LOW/OFF".

Note:

"HIGH" means that the device mutes with an incoming HIGH signal.

"LOW" means that the device mutes with an incoming LOW signal.

"OFF" means that the volume is not lowered during a call.

When you have finished making your changes,

- press the **MENU** button (3) or wait 5 seconds.

The settings are saved.

Switching the confirmation beep on/off

When you press certain buttons of the device, a confirmation beep sounds. You can switch the beep on or off. You can select four volumes for the beep.

- Press the **MENU** button (3).

- Press the **V** or **A** button (2) repeatedly until "BEEP" appears on the display.
- Press the **>** (15) or **<** button (16) to adjust the volume of the beep from 1 to 4.
- To switch off the beep, press the **>** (15) or **<** button (16) repeatedly until "BEEP OFF" appears on the display.

When you have finished making your changes,

- press the **MENU** button (3) or wait 5 seconds.

The settings are saved.

Radio mode

This device is equipped with an RDS radio receiver. Many of the receivable FM stations broadcast a signal that not only carries the programme but also additional information such as the station name and programme type (PTY).

The station name appears on the display as soon as the tuner receives it.

Adjusting the tuner

To ensure proper functioning of the tuner, the device must be set for the region in which it is being operated. You can select between Europe ("EURO"), America ("USA") and Asia ("ASIA"). The tuner is factory-set to the region in which it was sold. If you experience problems with your radio reception, please check this setting.

Note:

The radio functions described in these operating instructions refer to the tuner setting for Europe (EURO). If you switch to a different region (ASIA, USA), the user settings are lost.

- Press the **MENU** button (3).
- Press the **V** or **A** button (2) repeatedly until "AREA EURO", "AREA USA" or "AREA ASIA" appears on the display.
- Select your tuner region with the button **>** (15) or **<** (16).
- Press the **MENU** button (3) or wait 5 seconds.

The settings are saved.

Switching to radio mode

If you are in CD or AUX mode,

- press the **SRC** button (4) repeatedly until an RDS radio name or a frequency appears on the display.

RDS

Your radio uses the Radio Data System (RDS). RDS allows receiving additional information on the radio frequency. In addition to the display of the station name, you can also use convenient RDS functions (see the next chapter).

Note

RDS is broadcast only in the FM band. Not all radio stations in the FM range offer RDS.

Switching the display of station names on/off

You can switch the display of the station names on or off as needed. In the delivery state, the function is activated.

- Press the **MENU** button (3).
- Press the **√** or **∧** button (2) repeatedly until "RDS ON" or "RDS OFF" appears on the display.

To switch RDS on/off,

- press the button > (15) or < (16).

When you have finished making your changes,

- press the **MENU** button (3) or wait 5 seconds.

The settings are saved.

Convenient RDS functions (AF, REG)

The convenient RDS functions AF (Alternative Frequency) and REG (Regional) extend the range of functions of your radio device.

- AF: If the RDS function is activated, the radio automatically tunes into the best receivable frequency for the station that is currently set.
- REG: At certain times, some radio stations divide their programme into regional programmes providing different content. You can use the REG function to prevent the car radio from switching to alternative frequencies that are transmitting different programme content.

Note:

AF and REG must be activated/deactivated separately in the menu.

Switching AF on/off

- Press the **MENU** button (3).
- Press the **√** or **∧** button (2) repeatedly until "AF ON" or "AF OFF" appears on the display.

To switch AF on/off,

- press the button > (15) or < (16).

When you have finished making your changes,

- press the **MENU** button (3) or wait 5 seconds.

The settings are saved.

Switching REG on/off

- Press the **MENU** button (3).
- Press the **√** or **⏏** button (2) repeatedly until "REG ON" or "REG OFF" appears on the display.

To switch REG on/off,

- press the button **>** (15) or **<** (16).

When you have finished making your changes,

- press the **MENU** button (3) or wait 5 seconds.

The settings are saved.

Selecting the waveband/memory bank

This device can receive programmes broadcast over the FM frequency range as well as the MW and LW wavebands. There are three memory banks available for the FM waveband (FM1, FM2 and FMT) and one for each of the MW and LW wavebands.

Six stations can be stored on the station buttons in each memory bank.

The wavebands MW and LW can be switched on or off via the menu.

- Press the **MENU** button (3).
- Press the **√** or **⏏** button (2) repeatedly until "LW ON" or "LW OFF" or "MW ON" or "MW OFF" appears on the display.

To switch the wavebands on/off,

- press the button **>** (15) or **<** (16).

The settings are saved.

To switch between the FM memory banks (FM1, FM2 and FMT) and the MW and LW wavebands,

- press the **BAND** button (14).

Tuning into a station

There are various ways of tuning into a station.

Automatic station seek tuning

- Press and hold down the button **>** (15) or **<** (16) for 2 seconds.

The radio tunes into the next receivable station.

Tuning into stations manually

You can also tune into stations manually.

To change the set frequency in small increments,

- briefly press the **>** (15) or **<** button (16) repeatedly until the desired frequency is set.

Setting the sensitivity of station seek tuning

You can choose whether the radio should only tune into stations providing good reception or whether it can also tune into those with a weak reception.

- Press the **MENU** button (3).
- Press the **√** or **⏏** button (2) repeatedly until "SENS HIGH" or "SENS LOW" appears on the display.
- Set the desired sensitivity with the button **>** (15) or **<** (16).

When you have finished making your changes,

- press the **MENU** button (3) or wait 5 seconds.

The settings are saved.

Storing stations

Storing stations manually

- Select the desired memory bank FM1, FM2, FMT, LW or MW.
- Tune into the desired station.
- Press and hold down one of the station buttons **1 - 6** (13) for longer than two seconds to assign the station to that button.

The settings are saved.

Storing stations automatically (Travelstore)

You can automatically store the six stations offering the strongest reception in the region (FM only). The stations are stored in the FMT memory bank.

Note:

Any stations that were previously stored in this memory bank are deleted in the process.

- Briefly press the **TS** button (9).

The storing procedure begins. "FMTSTORE" appears on the display. After the process has completed, the radio will play the station that is stored on station button 1 of the FMT memory bank.

Listening to stored stations

- Select the waveband or memory bank with the **BAND** button (14).
- Press one of the station buttons **1 - 6** (13).

The stored station is played if it can be received.

Programme type (PTY)

Besides transmitting the station name, some FM stations also provide information on the type of programme that they are broadcasting. Your car radio can receive and display this information.

For example, the programme types can be:

CULTURE	TRAVEL	JAZZ
SPORT	SERVICE	POP
ROCK	SCIENCE	CHILDREN

You can use the PTY function to select stations of a particular programme type.

If you specify the programme type and start seek tuning, the radio will switch from the current station to a station of the selected programme type.

Notes:

- If the tuner does not find a station that corresponds to the selected programme type, you will hear a beep several times and "PTY NONE" appears briefly on the display. The radio will then retune to the station that it received last.
- If the tuned radio station or another station on the broadcasting network broadcasts your selected programme type at a later point in time, the radio will automatically switch from the currently tuned station or from CD mode to the station whose programme type matches the one you selected.
- If you do not want this PTY switching, disable PTY in the menu.

Switching PTY on/off

- Press the **MENU** button (3).
- Press the **√** or **⏏** button (2) repeatedly until "PTY OFF" or a selected programme (e.g. OLDIES, JAZZ, CLASSICS) appears on the display.
- Press the **>** (15) or **<** button (16) to enable or disable PTY (PTY OFF). (The display shows the respective programme type.)

When you have finished making your changes,

- press the **MENU** button (3) or wait 5 seconds.

The settings are saved. Seek tuning starts immediately. During seek tuning, you cannot perform any menu settings.

Note:

As an alternative, you can switch PTY on/off with the **TS** button (9).

To switch PTY on/off using the **TS** button (9),

- press the **TS** button (9) for longer than 2 seconds.

PTY switches on/off.

Traffic information

Your device is equipped with an RDS-EON receiver. EON (**E**nhanced **O**ther **N**etwork) ensures that whenever a traffic announcement (TA) is broadcast, the system switches automatically from a station that does not provide traffic reports to the appropriate traffic information station within the broadcasting network that does.

Once the traffic announcement has been played, the system will switch back to the programme that you were listening to before.

If you do not want to switch within a broadcasting network or toggle PTY, you can switch EON on or off.

To switch EON on/off,

- press the **MENU** button (3).
- Press the **√** or **⏏** button (2) repeatedly until "EON ON" or "EON OFF" appears on the display.
- Press the **>** (15) or **<** button (16) to switch EON on or off.

When you have finished making your changes,

- press the **MENU** button (3) or wait 5 seconds.

The settings are saved.

Switching traffic information priority on/off

- Press the **TA** button (12) to activate or deactivate the priority for traffic information.

The priority for traffic announcements is activated if the display shows "TA".

Setting the volume for traffic announcements

- Press the **MENU** button (3).
- Press the **V** or **A** button (2) repeatedly until "TA VOL" appears on the display.
- Press the **>** (15) or **<** button (16) to adjust the volume. You can select between -2 and +2.

When you have finished making your changes,

- press the **MENU** button (3) or wait 5 seconds.

The settings are saved.

Note:

Using the volume control (5), you can also adjust the volume during a traffic announcement for the duration of that announcement.

CD mode

You can use this device to play standard audio CDs, CD-Rs and CD-RWs with a diameter of 12 cm.



CAUTION!

Labelled or shaped CDs can damage the CD drive.

- Do not insert any shape CDs.
- Do not insert any 8-cm CDs.
- Do not attach labels to CDs since the label may detach during operation.

Notes:

- Label CDs only by using a marker since it does not contain any caustic materials. Permanent markers can damage CDs.
- To ensure proper functioning, use only CDs with the Compact-Disc logo. Copy-protected CDs can cause playback problems. Blaupunkt cannot guarantee the proper functioning of copy-protected CDs!
- Besides being able to play audio CDs on this device, you can also play CDs containing MP3/WMA music files. For further information, please read the chapter entitled "MP3/WMA mode".

Switching to CD mode

If there is no CD inserted in the drive,

- press the **CD** button (1).

The control panel opens.

- Gently insert the CD with its printed side uppermost into the drive until you feel some resistance.

The drive draws in the CD automatically.

You must not hinder or assist the drive as it draws in the CD.

- Gently close the control panel whilst exerting a little pressure until you feel it click into place.

The CD starts playing.

Note:

If the vehicle ignition was switched off prior to inserting the CD, you must switch the device on first with the On/Off button (6) to start the playback.

If a CD is already inserted in the drive,

- press the **SRC** button (4) repeatedly until the "CD symbol" appears on the display.

The playback starts with the track played last.

Selecting tracks

- Press the > (15) or < button (16) to select the next or previous track.

If you press the < button (16) once, the current track will be played again from the beginning.

Fast searching (audible)

To fast search backwards or forwards,

- press and hold down the > (15) or < button (16) until fast searching backwards or forwards begins.

Random track play (MIX)

To play back all the tracks of a CD at random,

- press the **4 MIX** button (13).

The display shows "MIX".

The next randomly selected track will then be played.

Cancelling MIX

- Press the **4 MIX** button (13) again.

The MIX symbol disappears.

Normal playback is then resumed.

Scanning tracks (SCAN)

You can scan (briefly play) all the tracks on the CD.

- Press the **2 SCN** button (13).

The display shows "SCN".

The next track will then be scanned.

Stopping Scan

To end the scanning process,

- press the **2 SCN** button (13).

The SCN symbol disappears.

The currently scanned track will then continue to be played normally.

Adjusting the scan time for SCAN

You can adjust the scan time for the SCAN function in the menu.

- Press the **MENU** button (3).

- Press the **∨** or **∧** button (2) repeatedly until "SCAN" appears on the display.

- Press the > (15) or < button (16) to select either 5, 10 or 20 seconds.

When you have finished making your changes,

➔ press the **MENU** button (3) or wait 5 seconds.

The settings are saved.

Repeating tracks (REPEAT)

If you want to repeat a track,

➔ press the **3 RPT** button (13).

The display shows "RPT".

The track is repeated continuously until you deactivate Repeat.

Canceling Repeat

If you want to cancel the repeat function,

➔ press the **3 RPT** button (13) again.

The RPT symbol disappears.

Normal playback is then resumed.

Interrupting playback (PAUSE)

To interrupt the playback,

➔ press the **1 ||▶** button (13).

The display shows "PAUSE".

Canceling pause

To continue the playback,

➔ press the **1 ||▶** button (13) during the pause.

Playback is continued.

Configuring the display

Notes:

- The display can be changed only if RDS is switched on in the menu.
- The display changes for 5 seconds.

You can choose from various display options in CD mode:

- Time
- Station set last (only for RDS station name reception)
- Frequency set last
- PTY function set last
- CD track display

To switch between the different display options,

➔ press the **DIS** button (8) repeatedly until the desired display appears.

Traffic announcements in CD mode

If you wish to receive traffic announcements in CD mode,

➔ press the **TA** button (12).

The priority for traffic announcements is activated if the display shows the TA symbol. For further details, please read the chapter entitled "Traffic information".

Ejecting a CD

➔ Press the **⏏** button (1).

The control panel opens to the bottom.

➔ Press the  button (19) next to the CD compartment.

The CD is ejected.

➔ Remove the CD and close the control panel.

Notes:

- If a CD is ejected, the drive will automatically draw it back in again after 10 seconds.
- You can also eject CDs whilst the device is switched off or whilst another audio source is activated.

MP3/WMA mode

You can also use this car sound system to play CD-Rs and CD-RWs that contain MP3 music files. You can also play WMA files. This chapter deals only with playing MP3 files since the operation for MP3 and WMA files is identical.

Note:

WMA files with Digital Rights Management (DRM) from online music shops cannot be played with this device.

Preparing an MP3/WMA CD

The various combinations of CD burners, CD burning software and CD blanks may lead to problems arising with the device's ability to play certain CDs. If problems occur with your own burned CDs, you should try another brand of CD blank or choose another colour of CD blank.

The format of the CD must be ISO 9660 Level 1/Level 2 or Joliet. Other formats cannot be played reliably.

Notes:

To ensure uninterrupted playback,

- do not try changing the file extension to ".MP3" of any files other than MP3 files and then attempt to play them. The device will ignore these invalid files during playback.
- do not use "mixed" CDs containing both non-MP3 files and MP3 tracks (the device only reads MP3 files during MP3 playback).

- do not use mix-mode CDs containing both CD-audio tracks and MP3 tracks. If you try playing a mix-mode CD, the device will only play the CD-audio tracks.

MP3 ID3 tags

MP3 tracks can contain additional information such as the artist, album and track name (ID3 tags). This device can display ID3 tags of version 1 and 2.

Switching to MP3 mode

MP3 mode is activated in the same way as normal CD mode. For further information, please read the section entitled "Switching to CD mode" in the "CD mode" chapter.

Note

If an MP3 or WMA CD is located in the drive, the display shows "MP3" during MP3 mode.

Configuring the display

The following settings require that an MP3 CD is in the device.

Notes:

- You can change the display for time, station set last and PTY function set last only if RDS is switched on in the menu.
- The display changes for 5 seconds.

Configuring the default display

You can display various types of information on the current track:

- Time
- Track
- Name of artist
- Genre
- Station set last
- PTY function set last
- File name

To switch between the different display options,

- ➔ press the **DIS** button (8) repeatedly until the desired display appears.

Selecting a directory

To move up or down to another directory,

- ➔ press the **∨** or **∧** button (2) once or several times.

Selecting tracks/files

To move up or down to another track or file in the current directory,

- ➔ press the **>** (15) or **<** button (16) once or several times.

If you press the **<** button (16) once, the current track will be played again from the beginning.

Fast searching (audible)

To fast search forwards or backwards,

- ➔ press and hold down the **>** (15) or **<** button (16) until fast searching backwards or forwards begins.

Random track play (MIX)

To play back all the tracks of a CD at random,

➤ press the **4 MIX** button (13).

The display shows "MIX".

The next randomly selected track will then be played.

Cancelling MIX

➤ Press the **4 MIX** button (13) again.

The MIX symbol disappears.

Normal playback is then resumed.

Scanning tracks (SCAN)

You can scan (briefly play) all the tracks on the CD.

➤ Press the **2 SCN** button (13).

The display shows "SCN".

The next track will then be scanned.

Stopping Scan

To end the scanning process,

➤ press the **2 SCN** button (13).

The SCN symbol disappears.

The currently scanned track will then continue to be played normally.

Adjusting the scan time for SCAN

You can adjust the scan time for the SCAN function in the menu.

➤ Press the **MENU** button (3).

➤ Press the **∨** or **∧** button (2) repeatedly until "SCAN" appears on the display.

➤ Press the **>** button (15) or **<** button (16) to select either 5, 10 or 20 seconds.

When you have finished making your changes,

➤ press the **MENU** button (3) or wait 5 seconds.

The settings are saved.

Repeating tracks (REPEAT)

To repeat a track,

➤ briefly press the **3 RPT** button (13).

The display shows "RPT".

The track is repeated continuously until you deactivate Repeat.

To repeat a directory,

➤ press the **3 RPT** button (13) for longer than 2 seconds.

"RPT" flashes on the display.

The directory is repeated continuously until you deactivate Repeat.

Cancelling Repeat

If you want to cancel the repeat function,

➤ Press the **3 RPT** button (13) again.

The RPT symbol disappears.

Normal playback is then resumed.

Interrupting playback (PAUSE)

➤ Press the **1 |||** button (13).

The display shows "PAUSE".

Cancelling pause

➤ press the **1 |||** button (13) during the pause.

Playback is continued.

Menu settings

Setting the time

To set the time,

- press the **MENU** button (3).
- Press the **↔** or **↵** button (2) repeatedly until "CLOCK ON" or "CLOCK OFF" appears on the display.

You can adjust the time and time mode only if the menu item is set to "CLOCK ON".

- Press the **MENU** button (3).
- Press the **↔** or **↵** button (2) repeatedly until the time appears on the display.
- Press the **>** (15) or **<** button (16) to change the value.
- Press the **↔** or **↵** button (2) to switch between hours and minutes.

Note:

If the menu item is set to "CLOCK ON", the device displays the time for all selected sources. The time adjusts itself automatically with the RDS signal if it can be received.

When you have finished making your changes,

- press the **MENU** button (3) or wait 5 seconds.

The settings are saved.

Selecting 12/24-hour clock mode

- Press the **MENU** button (3).
- Press the **↔** or **↵** button (2) repeatedly until "HOUR 24" or "HOUR 12" appears on the display.
- Press the **>** (15) or **<** button (16) to switch the mode.

When you have finished making your changes,

- press the **MENU** button (3) or wait 5 seconds.

The settings are saved.

Loading standard settings

Note:

Your user settings (audio, station memory) are overwritten when you load the standard settings.

To load the standard settings,

- press the **MENU** button (3).
- Press the **↔** or **↵** button (2) repeatedly until "DEF OFF" appears on the display.
- Press the **>** (15) or **<** button (16) until "DEF LOAD" (default load) appears on the display.
- Press the **MENU** button (3) within 5 seconds (timeout function) to load the standard settings.

Switching the AUX input on/off

You can switch the AUX input on/off in the menu.

- Press the **MENU** button (3).
- Press the **↔** or **↕** button (2) repeatedly until "AUX ON" or "AUX OFF" appears on the display.
- Press the **>** (15) or **<** button (16) to switch the AUX input on/off.

When you have finished making your changes,

- press the **MENU** button (3) or wait 5 seconds.

The settings are saved.

Note

If the AUX input is switched off in the menu, you cannot select the AUX input as a source.

Adjusting the display brightness

To switch between bright and dark,

- press and hold down the **DIS** button (8) for longer than 2 seconds.

Sound

The sound settings for the volume distribution (balance and fader), X-BASS, bass, treble and DSP (Digital Sound Processor) apply to all the audio sources.

Adjusting the bass

You can adjust the bass level between -10 and +10.

Adjusting the level

- Press the **AUD** button (10) repeatedly until "BAS" appears on the display.
- Turn the volume control (5) to adjust the level from -10 to +10.

When you have finished making your changes,

- wait 5 seconds.

The settings are saved.

Note:

If an equalizer presetting (POP M, ROCK M, CLASSICS, FLAT) is selected, the manual increase of the bass level and treble is overwritten. As soon as another manual increase is performed, the equaliser switches off. For further information, please read the note in the section entitled "Equalizer presettings (presets)".

Adjusting the treble

You can adjust the treble level between -10 and +10.

Adjusting the level

- Press the **AUD** button (10) repeatedly until "TRB" appears on the display.
- Turn the volume control (5) to adjust the level from -10 to +10.

When you have finished making your changes,

- wait 5 seconds.

The settings are saved.

Note:

If an equalizer presetting (POP M, ROCK M, CLASSICS, FLAT) is selected, the manual increase of the bass level and treble is overwritten. As soon as another manual increase is performed, the equaliser switches off. For further information, please read the note in the section entitled "Equalizer presettings (presets)".

Setting the left/right volume distribution (balance)

To adjust the left/right volume distribution (balance),

- press the **AUD** button (10) repeatedly until "BAL" appears on the display.
- Turn the volume control (5) to adjust the distribution from 10L to 10R.

When you have finished making your changes,

- wait 5 seconds.

The settings are saved.

Adjusting the front/rear volume distribution (fader)

To adjust the front/rear volume distribution (fader),

- press the **AUD** button (10) repeatedly until "FAD" appears on the display.
- Turn the volume control (5) to adjust the distribution from 10F to 10R.

When you have finished making your changes,

- wait 5 seconds.

The settings are saved.

X-BASS

X-Bass allows you to increase the bass at low volume.

The selected X-Bass setting is effective for all audio sources (radio, CD, MP3 or AUX).

Switching X-BASS on/off

- Press the **AUD** button (10) repeatedly until "X-BASS ON" or "X-BASS OFF" appears on the display.
- Turn the volume control (5) to perform the desired setting.

When you have finished making your changes,

- wait 5 seconds.

The settings are saved.

"X-BASS" appears on the display if the function is activated.

Equalizer presets (presets)

This device features an equaliser in which the settings for "FLAT" (linear) and the music genres "CLASSICS", "POP M" and "ROCK M" are already programmed.

To select an equaliser setting,

- press the **AUD** button (10) repeatedly until "FLAT", "CLASSICS", "POP M", "ROCK M" or "DSP OFF" appears on the display.
- Turn the volume control (5) to select one of the settings or select "DSP OFF" to switch off the equaliser.

When you have finished making your changes,

- wait 5 seconds.

The settings are saved.

The respective setting appears on the display.

Note:

Without equaliser presets, you can adjust the bass and treble from -10 to +10.

If you change the treble and/or bass while an equalizer presetting (POP M, ROCK M, CLASSICS, FLAT) is selected, the equaliser switches off automatically (DSP OFF).

External audio sources

External audio sources, such as portable CD players, MiniDisc players or MP3 players, can be connected to the device via the AUX input.

Notes:

- To connect an external audio source via the rear or front AUX input (depending on the model), you need a cable with cinch plugs (rear AUX input) or a 3.5-mm jack plug (front AUX input).
- The AUX input can be selected with the **SRC** button (4). "AUX" appears on the display.

Resetting the device (Reset)

To reset the device to the delivery state,

- press the Reset button (18) with a pointed object.

The device restarts.

The delivery state has been restored.

Technical data

Amplifier

Output power:	4 x 22 watts sine in accordance with DIN 45324 at 14.4 V at 4 ohms.
	4 x 40 watts max. power

Tuner

Wavebands:

FM :	87.5 - 108 MHz
MW :	531 - 1.620 kHz
LW :	153 - 279 kHz

FM frequency response:

35 - 15.000 Hz

CD

Frequency response:

20 - 20.000 Hz

Preamp Out

2 channels 2 V

AUX input sensitivity

AUX-IN: 150 mV/10 k Ω

Weight approx. 1.6 kg

Subject to changes

D Einbauanleitung

Sicherheitshinweise

Für die Dauer der Montage und des Anschlusses beachten Sie bitte folgende Sicherheitshinweise.

- Minuspol der Batterie abklemmen! Dabei die Sicherheitshinweise des Kfz- Herstellers beachten.
- Beim Bohren von Löchern darauf achten, dass keine Fahrzeugteile beschädigt werden.
- Der Querschnitt des Plus- und Minuskabels darf 1,5 mm² nicht unterschreiten.
- **Fahrzeugseitige Stecker nicht an das Radio anschließen!**
Die für Ihren Fahrzeugtyp erforderlichen Adapterkabel erhalten Sie im BLAUPUNKT-Fachhandel.
- Je nach Bauart kann Ihr Fahrzeug von dieser Beschreibung abweichen. Für Schäden durch Einbau- oder Anschlussfehler und für Folgeschäden übernehmen wir keine Haftung.

Sollten die hier aufgeführten Hinweise für Ihren Einbau nicht passen, so wenden Sie sich bitte an Ihren Blaupunkt-Fachhändler, Ihren Fahrzeughersteller oder unsere Telefon-Hotline.

Bei Einbau eines Amplifiers müssen unbedingt erst die Gerätemassen angeschlossen werden, bevor die Stecker für die Line-In- oder Line-Out-Buchse kontaktiert werden.

Fremdgerätemassen dürfen nicht an der Autoradiomasse (Gehäuse) angeschlossen werden.

GB Installation instructions

Safety instructions

When carrying out installation work and making connections please observe the following safety instructions:

- Disconnect the negative terminal of the battery! When doing so, please observe the vehicle manufacturer's safety instructions.
- Make sure you do not damage vehicle components when drilling any holes.
- The cross sections of the positive and negative cables must not be less than 1.5 mm².
- **Do not connect the vehicle's plug connectors to the radio!**
You can obtain the adapter cable required for your vehicle type from any BLAUPUNKT dealer.
- Depending on the model, your vehicle may differ from the description provided here. We accept no responsibility for any damages due to incorrect installation or connection or for any consequential damages.

If the information provided here is not suitable for your specific installation requirements, please contact your Blaupunkt dealer, your vehicle

manufacturer or our telephone hot-line.

When installing an amplifier, you must first connect the device earth connections before connecting the plugs for the line-in or line-out jacks.

Earth connection of external devices may not be connected to earth of car sound system (housing).

F Notice de montage



Consignes de sécurité

Respecter les consignes de sécurité suivantes pendant la durée du montage et du branchement.

- Débrancher le pôle (-) de la batterie ! Respecter les consignes de sécurité du constructeur automobile !
- Veiller à n'endommager aucune pièce du véhicule en perçant des trous.
- La section du câble (+) et (-) ne doit pas dépasser 1,5 mm².
- **Ne pas brancher les connecteurs du véhicule sur la radio !**
Les câbles d'adaptation nécessaires pour le type de véhicule sont disponibles auprès des revendeurs BLAUPUNKT.
- En fonction du modèle, votre véhicule peut différer de cette description. Nous déclinons toute responsabilité en cas de dommages causés par des erreurs de montage ou de connexion et en cas de dommages consécutifs.

Si les indications décrites ici ne s'appliquent au montage que vous voulez effectuer, adressez-vous à votre revendeur Blaupunkt, votre constructeur automobile ou notre service d'assistance téléphonique.

Pour le montage d'un amplificateur, les masses d'appareil doivent être d'abord connectées avant de connecter les fiches pour les connecteurs Line In ou Line Out.

Les masses des appareils externes ne doivent pas être raccordées à la masse de l'autoradio (boîtier).

I Istruzioni di installazione



Note di sicurezza

Durante il montaggio e l'allacciamento osservate per favore le seguenti istruzioni sulla sicurezza.

- Staccate il polo negativo della batteria! Nel fare ciò osservate le istruzioni di sicurezza del fabbricante d'auto.
- Quando praticate dei fori, fate attenzione a non danneggiare nessuna parte dell'autovettura.
- La sezione dei cavi positivi e negativi non deve essere mai inferiore a 1,5 mm².
- **Non collegate alla radio le spine in dotazione di autovettura!**
Richiedete ad un negoziante specializzato in articoli BLAUPUNKT il cavo di adattamento richiesto per il vostro modello di autovettura.

- A seconda del modello il Suo veicolo può differire da questa descrizione. Non forniamo garanzia per danni derivanti da errori di montaggio o di collegamento e per danni conseguenti.

Se le indicazioni qui elencate non sono adatte al Suo montaggio, La preghiamo di rivolgersi al Suo rivenditore Blaupunkt, al fabbricante dell'auto o alla nostra hotline telefonica.

Quando vengono montati un amplificatore, bisogna innanzi tutto allacciare le masse degli apparecchi prima di eseguire la connessione delle spine con le prese line-in e line-out.

Le masse di altri apparecchi non devono essere collegate alla massa dell'autoradio (involucro).

- **Stekker aan de voertuigkant niet aan de radio aansluiten!**

De voor uw voertuig vereiste adapterkabel is bij de BLAUPUNKT-vakhandel verkrijgbaar!

- Afhankelijk van de uitvoering kan uw auto afwijken van deze beschrijving. Voor schade door fouten in montage of aansluiting en schade als gevolg daarvan aanvaarden wij geen aansprakelijkheid.

Mochten de hier vermelde aanwijzingen voor de montage voor u niet van toepassing zijn, dan kunt u contact opnemen met uw Blaupunkt-vakhandel, uw autofabrikant of onze telefoon-hotline.

Bij inbouw van een versterker moeten eerst de massacontacten van de apparaten worden verbonden voordat de stekkers voor de line-in- of line-out-bussen worden aangesloten.

De massa van andere apparaten mag niet aan de massa van de autoradio (huis) worden aangesloten.

NL Inbowhandleiding



Adviezen voor de veiligheid

Wilt u dedurende het monteren en aansluiten de volgende veiligheidsadviezen in acht nemen.

- De minpool van de batterij afklemmen! De veiligheidsadviezen van de fabrikant in acht nemen.
- Bij het gaten boren erop letten dat geen voertuigonderdelen worden beschadigd.
- De dwarsdoorsnede van de plus-en minkabel mag niet minder dan 1,5 mm² zijn.

S Monteringsanvisning



Skyddsanvisningar

Vänligen beakta följande skyddsanvisningar under pågående montage och anslutning.

- Lossa polskon från batteriets minuspol! Följ därvid fordonstillverkarens skyddsanvisningar.
- Se till att inga av fordonets komponenter skadas i samband med borrning av hål.

- Plus- och minuskabelns ledningsarea måste vara minst 1,5 mm².
- **Fordonets stickkontakt får inte anslutas till radion!**
Din BLAUPUNKT fackhandel tillhandahåller för resp fordonstyp erforderlig adapterkabel.
- Beroende på konstruktionstyp kan fordonet avvika från denna beskrivning. Vi fransäger oss allt ansvar för skada eller följdskada pga. felaktig montering eller anslutning.

Om här givna monteringsanvisningar ej stämmer överens med faktiska förhållanden, vänligen kontakta Blaupunkt fackhandel, representant för fordonets tillverkare eller vår telefonkundtjänst.

Vid montering av förstärkare måste först apparatstommen jordas, innan stickpropparna ansluts till in- eller utgångarna (hylstag line-in resp line-out).

Jord från andra apparater får inte anslutas till bilradions jord (höljet).

Mitgelieferte Montage- und Anschlusssteile

Supplied Mounting Hardware

Materiel de montage fourni

Componenti di fissaggio comprese nella fornitura

Meegeleverde montage materialen

Medföljande monteringsdetaljer

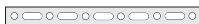
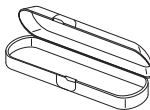
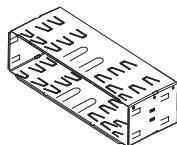

Als Sonderzubehör erhältlich
Available as an optional accessory
Disponibile en option
Reperibili come accessori extra
Als speciale accessoires verkrijgbaar
Tillval

Preamp./Sub./Center - out cable

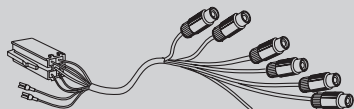

7 607 001 512

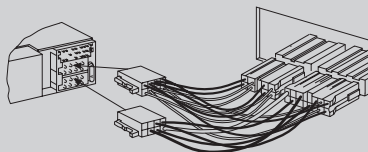

7 607 621...

Einbausätze
Installation kits
Kits de montage
Set di montaggio
Inbouwsets
Monteringssatser

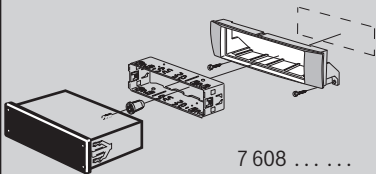

7 608

1.

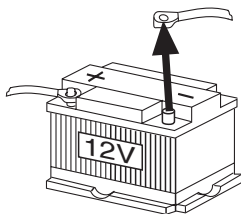

2.

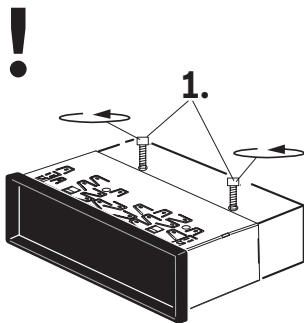

3.

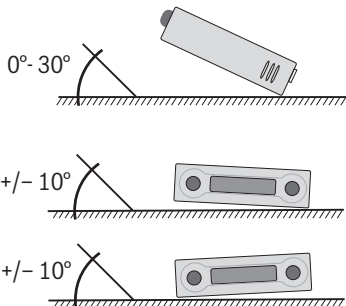

4.

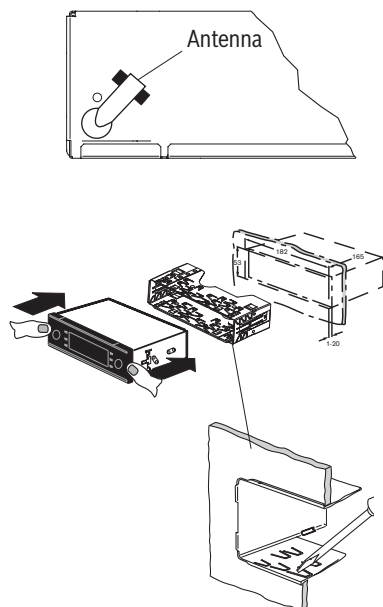

5.

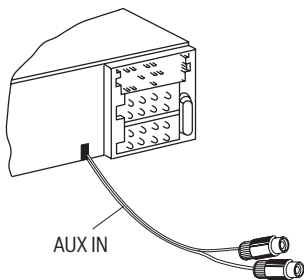

only
San Remo MP28
Monte Carlo MP28

6. **Ausbau / Removal /
Démontage / Smontaggio /
Demontage / Urmontering**

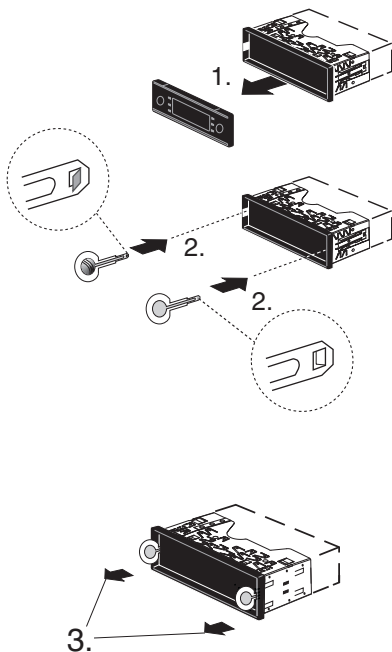

7.

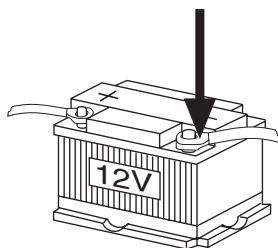

DEUTSCH

ENGLISH

FRANÇAIS

ITALIANO

NETERLANDS

SVENSKA

8.

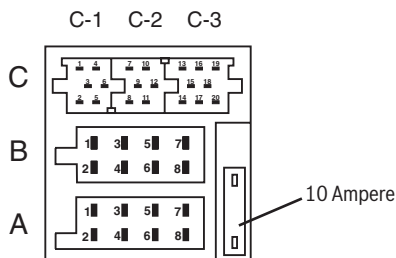

A		B	
1	NC	1	Speaker out RR+
2	Radio Mute	2	Speaker out RR-
3	NC	3	Speaker out RF+
4	Permanent +12V	4	Speaker out RF-
5	NC	5	Speaker out LF+
6	NC	6	Speaker out LF-
7	Kl.15/Ignition	7	Speaker out LR+
8	Masse/GND	8	Speaker out LR-

C1		C2		C3	
1	Line Out LR	7	NC	13	NC
2	Line Out RR	8	NC	14	NC
3	Line Out / Ground	9	NC	15	NC
4	NC	10	SW Supply - RC +12V	16	NC
5	NC	11	Remote Control	17	NC
6	NC	12	RC - GND	18	NC
				19	NC
				20	NC

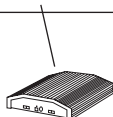

Amplifier

9.

Preamp./Sub./Center - out cable

7 607 001 512

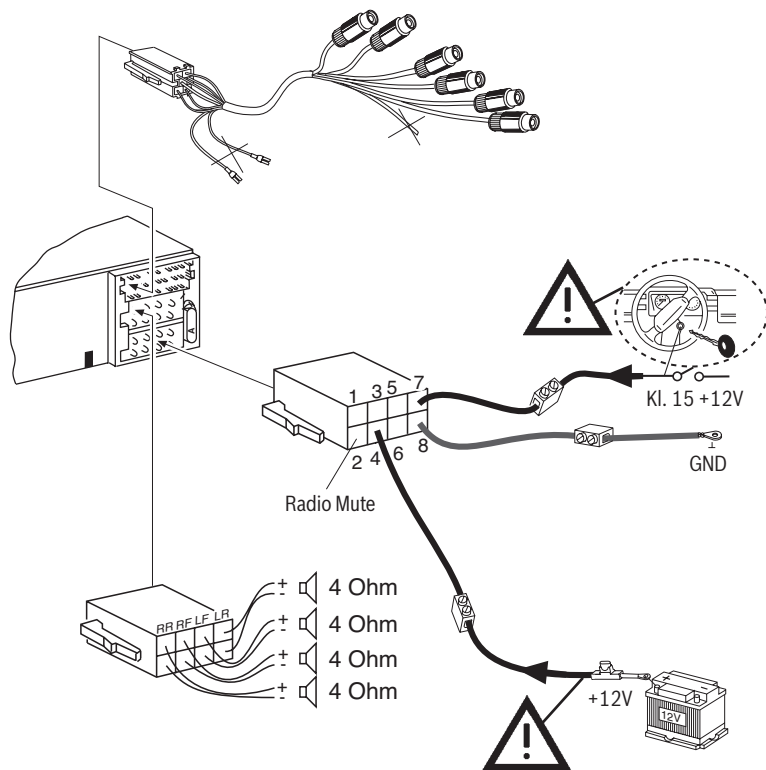

Änderungen vorbehalten!
Subject to changes!
Sous réserve de modifications!
Modifiche riservate!
Wijzigingen voorbehouden!
Ändringar förbehålles!

DEUTSCH

ENGLISH

FRANÇAIS

ITALIANO

NEDERLANDS

SVENSKA

© 2008 All rights reserved by Blaupunkt. This material may be reproduced, copied or distributed for personal use only.

This product is protected by certain intellectual property rights of Microsoft. Use or distribution of such technology outside of this product is prohibited without a license from Microsoft.

Bitte den ausgefüllten Gerätepass sicher aufbewahren!
Please keep the filled-in radio pass in a safe place!
Prière de conserver soigneusement la carte d'autoradio remplie !
Tenete per favore il libretto di apparecchio, debitamente riempito, in un posto sicuro!
Bewaar de ingevulde apparaatpas op een veilige plaats!
Vänligen förvara ifyllt apparatpass på säker plats!

Country:	Phone:	Fax:	WWW:
Germany	(D) 0180-5000225	05121-49 4002	http://www.blaupunkt.com
Austria	(A) 01-610 39 0	01-610 39 391	
Belgium	(B) 02-525 5444	02-525 5263	
Denmark	(DK) 44 898 360	44-898 644	
Finland	(FIN) 09-435 991	09-435 99236	
France	(F) 01-4010 7007	01-4010 7320	
Great Britain	(GB) 01-89583 8880	01-89583 8394	
Greece	(GR) 210 94 27 337	210 94 12 711	
Ireland	(IRL) 01-46 66 700	01-46 66 706	
Italy	(I) 02-369 62331	02-369 62464	
Luxembourg	(L) 40 4078	40 2085	
Netherlands	(NL) 00 31 24 35 91 338	00 31 24 35 91 336	
Norway	(N) +47 64 87 89 60	+47 64 87 89 02	
Portugal	(P) 2185 00144	2185 00165	
Spain	(E) 902 52 77 70	91 410 4078	
Sweden	(S) 08-7501850	08-7501810	
Switzerland	(CH) 01-8471644	01-8471650	
Czech. Rep.	(CZ) 02-6130 0446	02-6130 0514	
Hungary	(H) 76 889 704	-	
Poland	(PL) 0800-118922	022-8771260	
Turkey	(TR) 0212-335 07 23	0212-346 00 40	
USA	(USA) 800-950-2528	708-6817188	
Brasil (Mercosur)	(BR) 0800 7045446	+55-19 3745 2773	
Malaysia (Asia Pacific)	(MAL) +604-6382 474	+604-6413 640	

01/08 - CM-AS/SCS1 (dt, gb, fr, it, nl, sw)

Gerätepass

Name:

Typ: **7 648...**

Serien-Nr: **BP**

 **BLAUPUNKT**



8622405789