



Radio / CD / MP3

# Bermuda MP35

7 645 185 510

Installation instructions  
Notice de montage  
Instrucciones de instalación  
Instruções de montagem



<http://www.blaupunkt.com>

 **BLAUPUNKT**

# Installation instructions • Notice de montage • Instrucciones de instalación • Instruções de montagem

## **Safety instructions**

**When carrying out installation work and making connections please observe the following safety instructions:**

- Disconnect the negative terminal of the battery! When doing so, please observe the vehicle manufacturer's safety instructions.
- Make sure you do not damage vehicle components when drilling any holes.
- The cross sections of the positive and negative cables must not be less than 1.5 mm<sup>2</sup>.
- **Do not connect the vehicle's plug connectors to the radio!**
- You can obtain the adapter cable required for your vehicle type from any BLAUPUNKT dealer.
- Depending on the model, your vehicle may differ from the description provided here. We accept no responsibility for any damages due to incorrect installation or connection or for any consequential damages. If the information provided here is not suitable for your specific installation requirements, please contact your Blaupunkt dealer, your vehicle manufacturer or our telephone hotline.

**When installing an amplifier or changer, you must first connect the device earth connections before connecting the plugs for the line-in or line-out jacks.**

## **Consignes de sécurité**

**Respecter les consignes de sécurité suivantes pendant la durée du montage et du branchement.**

- Débrancher le pôle (-) de la batterie ! Respecter les consignes de sécurité du constructeur automobile !
- Veiller à n'endommager aucune pièce du véhicule en perçant des trous.
- La section du câble (+) et (-) ne doit pas dépasser 1,5 mm<sup>2</sup>.
- **Ne pas brancher les connecteurs du véhicule sur la radio !**
- Les câbles d'adaptation nécessaires pour le type de véhicule sont disponibles auprès des revendeurs BLAUPUNKT.
- En fonction du modèle, votre véhicule peut différer de cette description. Nous déclinons toute responsabilité en cas de dommages causés par des erreurs de montage ou de connexion et en cas de dommages consécutifs. Si les indications décrites ici ne s'appliquent au montage que vous voulez effectuer, adressez-vous à votre revendeur Blaupunkt, votre constructeur automobile ou notre service d'assistance téléphonique.

**Pour le montage d'un amplificateur ou changeur, les masses d'appareil doivent être d'abord connectées avant de connecter les fiches pour les connecteurs Line IN ou Line Out.**

## **Normas de seguridad**

Durante el montaje y la conexión es imprescindible observar las siguientes normas de seguridad.

- Desemborne el polo negativo de la batería. Observe las normas de seguridad dadas por el fabricante del vehículo.
- Al perforar agujeros, asegúrese de no dañar ninguna pieza del vehículo.
- La sección transversal del cable positivo y del cable negativo no debe ser menor de 1,5 mm<sup>2</sup>.
- **¡No conecte a la radio los conectores ubicados en el vehículo!**
- Los cables adaptadores necesarios para su vehículo los encontrará en el comercio especializado en artículos de la marca BLAUPUNKT.
- Dependiendo del modelo, es posible que su vehículo varíe un poco con respecto a la descripción aquí dada. Tenga en cuenta que no asumimos ninguna responsabilidad por los daños debidos a un montaje o conexión incorrectos ni por los daños resultantes. Si las instrucciones aquí dadas no son aptas para el montaje en su vehículo, póngase en contacto con su proveedor de artículos Blaupunkt o con el fabricante del vehículo, o llame a nuestro teléfono de atención al cliente.

**En caso de montar un amplificador o un cambiadiscos, es necesario conectar la puesta a tierra de las unidades antes de establecer el contacto de los conectores para las hembrillas Line-In y Line-Out.**

## **Instruções de segurança**

Durante a montagem e a ligação do aparelho, queira respeitar as seguintes instruções de segurança.

- Separar o pólo negativo da bateria ! Respeitar ao mesmo tempo as instruções de segurança do fabricante do automóvel.
- Quando se procede à furagem de buracos, prestar atenção para não serem danificadas quaisquer partes do veículo.
- As secções transversais dos cabos positivo e negativo não devem ser inferiores a 1,5 mm<sup>2</sup>.
- **Não ligar as fichas existentes do lado do automóvel ao auto-rádio!**
- Os cabos adaptadores necessários para o seu automóvel podem ser adquiridos nos revendedores da BLAUPUNKT.
- O seu veículo pode divergir desta descrição em função do modelo. Não assumimos qualquer responsabilidade por erros de montagem ou de ligação nem por danos daí decorrentes. Caso as presentes instruções não sejam adequadas para a montagem no seu veículo, dirija-se ao revendedor da Blaupunkt, ao fabricante do seu veículo ou à nossa linha verde.

**No caso de montagem de um amplificador ou leitor multi-CD, é imprescindível ligar primeiro os aparelhos à terra antes de se conectar as fichas às tomadas Line In ou Line Out.**

## Supplied Mounting Hardware

Materiel de montage fourni

Ferreteria de montaje  
suministrada

Elementos de fixação fornecidos.

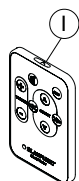
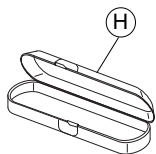
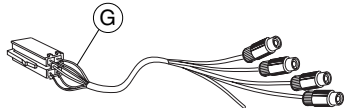
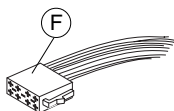
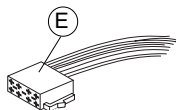
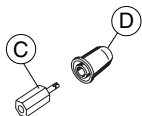
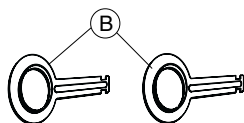
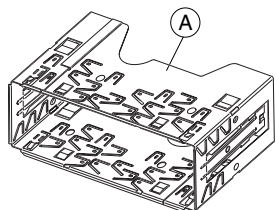

RC-12H

1.

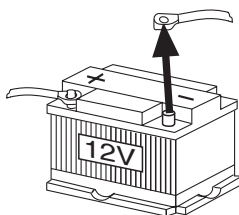

2.

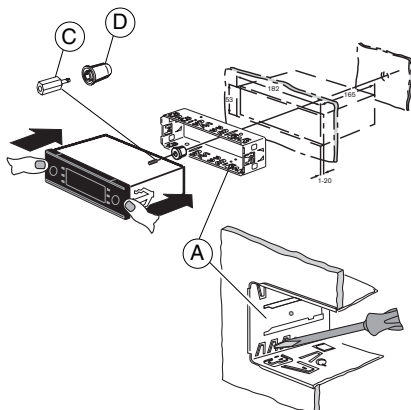

3.

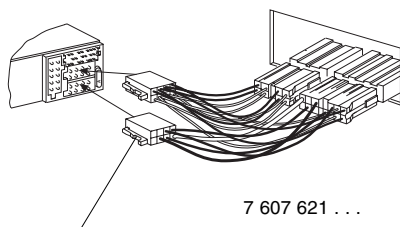

Car-specific adapter cable which is available at your dealer.

Câble adaptateur spécifique au véhicule, disponible dans le commerce.

Adaptador específico del vehículo, el cual se puede adquirir en el comercio especializado.

Cabo de adaptação específico do automóvel que pode ser adquirido no comércio especializado.

4.

Removal, Démontage,  
Desmontaje, Desmontagem

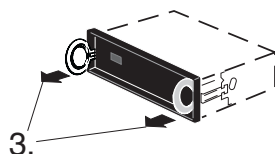
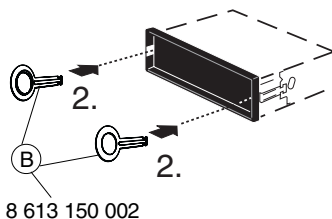
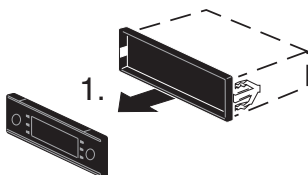

5.

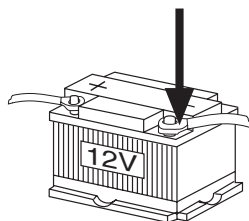

6.

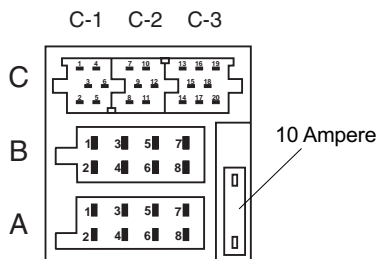

A		B	
1	nc	1	Speaker out RR+
2	Tel.-Mute	2	Speaker out RR-
3	nc	3	Speaker out RF+
4	Permanent +12V	4	Speaker out RF-
5	Aut. antenna	5	Speaker out LF+
6	Illumination	6	Speaker out LF-
7	Kl.15/Ignition	7	Speaker out LR+
8	Masse/GND	8	Speaker out LR-

C					
C1		C2		C3	
1	Line Out LR	7	nc	13	CDC-Data - In
2	Line Out RR	8	nc	14	CDC-Data - Out
3	Line Out / Ground	9	nc	15	Permanent +12V
4	Line Out LF	10	RC +12V	16	+12V
5	Line Out RF	11	Remote Control	17	Bus / GND
6	+12V Amplifier	12	RC - GND	18	AF / GND
				19	Line In - L
				20	Line In - R

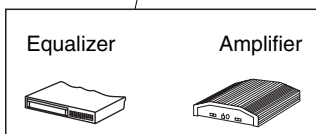

Remote Control



CD-Changer

7.

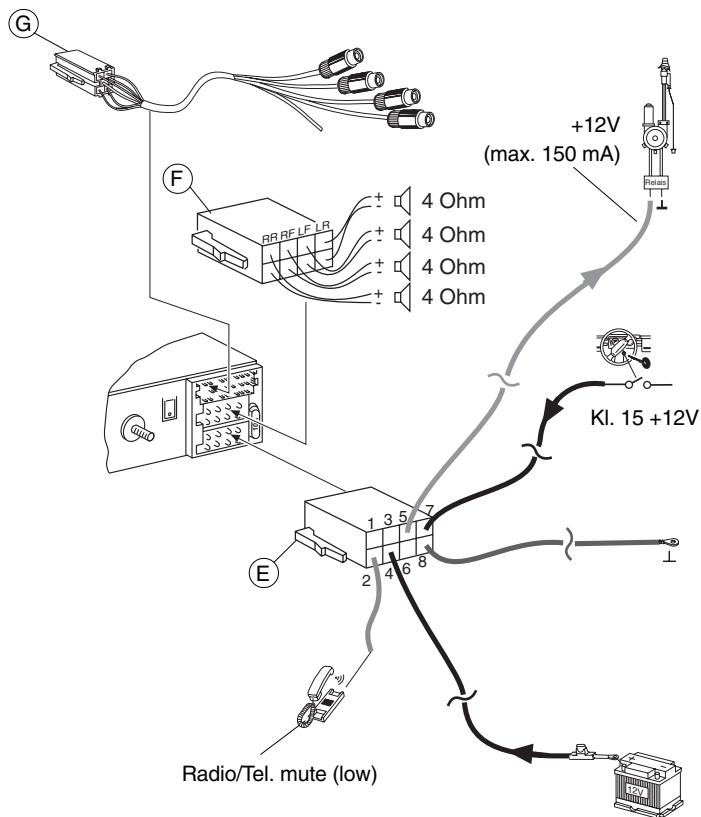

This information is subject to change without notice!

Sous réserve de modifications!

Modificaciones reservadas!

Sob reserva de alterações!

## Service numbers / Numéros du service après-vente / Números de servicio / Número de serviço

Country:	Phone:	Fax:	WWW:
Germany	(D) 0180-5000225	05121-49 4002	<a href="http://www.blaupunkt.com">http://www.blaupunkt.com</a>
Austria	(A) 01-610 39 0	01-610 39 391	
Belgium	(B) 02-525 5444	02-525 5263	
Denmark	(DK) 44 898 360	44-898 644	
Finland	(FIN) 09-435 991	09-435 99236	
France	(F) 01-4010 7007	01-4010 7320	
Great Britain	(GB) 01-89583 8880	01-89583 8394	
Greece	(GR) 210 94 27 337	210 94 12 711	
Ireland	(IRL) 01-4149400	01-4598830	
Italy	(I) 02-369 62331	02-369 62464	
Luxembourg	(L) 40 4078	40 2085	
Netherlands	(NL) 023-565 6348	023-565 6331	
Norway	(N) 66-817 000	66-817 157	
Portugal	(P) 01-2185 00144	01-2185 11111	
Spain	(E) 902 52 77 70	902 52 77 70	
Sweden	(S) 08-7501500	08-7501810	
Switzerland	(CH) 01-8471644	01-8471650	
Czech. Rep.	(CZ) 02-6130 0441	02-6130 0514	
Hungary	(H) 01-333 9575	01-324 8756	
Poland	(PL) 0800-118922	022-8771260	
Turkey	(TR) 0212-335 06 69	0212-346 00 40	
USA	(USA) 800-2662528	708-6817188	
Brasil (Mercosur)	(BR) +55-19 3745 2769	+55-19 3745 2773	
Malaysia (Asia Pacific)	(MAL) +604-6382 474	+604-6413 640	

**Blaupunkt GmbH, Robert-Bosch-Straße 200, D-31139 Hildesheim**



8622404318