

PENTAX

SLR Digital Camera

K-r

Operating Manual

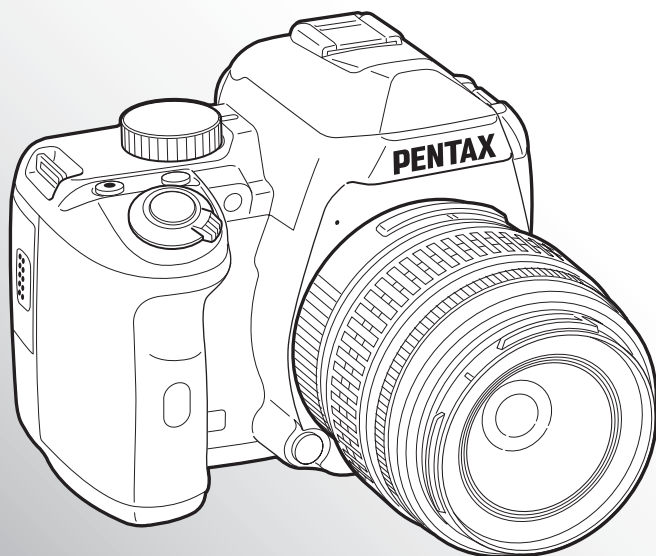

SILKYPIX[®]
The Excellent digital development technology



For optimum camera performance, please read the Operating Manual before using the camera.

Thank you for purchasing this PENTAX **K-r** Digital Camera. Please read this manual before using the camera in order to get the most out of all the features and functions. Keep this manual safe, as it can be a valuable tool in helping you to understand all the camera's capabilities.

Lenses you can use

In general, lenses that can be used with this camera are DA, DA L, D FA and FA J lenses and lenses that have an **A** (Auto) position on the aperture ring. To use any other lens or accessory, see p.56 and p.312.

Regarding copyrights

Images taken with the **K-r** that are for anything other than personal enjoyment cannot be used without permission according to the rights as specified in the Copyright Act. Please take care, as there are cases where limitations are placed on taking pictures even for personal enjoyment during demonstrations, performances or of items on display. Images taken with the purpose of obtaining copyrights also cannot be used outside the scope of use of the copyright as laid out in the Copyright Act, and care should be taken here also.

Regarding trademarks

PENTAX, **K-r** and smc PENTAX are trademarks of HOYA CORPORATION. PENTAX Digital Camera Utility and SDM are trademarks of HOYA CORPORATION. Microsoft and Windows are registered trademarks of Microsoft Corporation in the United States and other countries. Windows Vista is either a registered trademark or trademark of Microsoft Corporation in the United States and/or other countries. Macintosh and Mac OS are trademarks of Apple Inc., registered in the U.S. and other countries.



SDHC Logo is a trademark of SD-3C, LLC.

This product includes DNG technology under license by Adobe Systems Incorporated.



The DNG logo is either registered trademarks or trademarks of Adobe Systems Incorporated in the United States and/or other countries.

IrSimple™ and IrSST™ Trademarks are owned by the Infrared Data Association®. All other brands or product names are trademarks or registered trademarks of their respective companies. However, the TM or ® marks are not used in all cases in this manual.

This product supports PRINT Image Matching III. PRINT Image Matching enabled digital still cameras, printers and software help photographers to produce images more faithful to their intentions. Some functions are not available on printers that are not PRINT Image Matching III compliant.

Copyright 2001 Seiko Epson Corporation. All Rights Reserved.

PRINT Image Matching is a trademark of Seiko Epson Corporation.

The PRINT Image Matching logo is a trademark of Seiko Epson Corporation.

To users of this camera

- Do not use or store this device in the vicinity of equipment that generates strong electromagnetic radiation or magnetic fields. Strong static charges or the magnetic fields produced by equipment such as radio transmitters could interfere with the monitor, damage the stored data, or affect the product's internal circuitry and cause camera misoperation.
- The liquid crystal panel used in the monitor is manufactured using extremely high precision technology. Although the level of functioning pixels is 99.99% or better, you should be aware that 0.01% or fewer of the pixels may not illuminate or may illuminate when they should not. However, this has no effect on the recorded image.
- There is a possibility that the illustrations and the display screen of the monitor in this manual are different from the actual ones.
- In this manual, the generic term "computer(s)" refers to either a Windows PC or a Macintosh hereafter.
- The camera can use either D-L1109 battery or the optional AA battery holder D-BH109 with four AA batteries. In this manual, both the D-L1109 and D-BH109 are referred to as the battery hereafter.

Except stated above, the generic term "battery(ies)" refers to any type of batteries used for this camera and its accessories.

For Using Your Camera Safely

We have paid close attention to the safety of this product. When using this product, we request your special attention regarding items marked with the following symbols.



Warning

This symbol indicates that violating this item could cause serious personal injuries.



Caution

This symbol indicates that violating this item could cause minor or medium personal injuries, or loss of property.

About the Camera



Warning

- Do not disassemble or modify the camera. High voltage areas are present inside the camera, with the risk of electric shock.
- If the camera interior is exposed due to dropping or otherwise damaging the camera, never touch the exposed portion. There is a risk of electric shock.
- Do not look directly at the sun through the camera with a telephoto lens attached, as viewing the sun may damage your eyes. Viewing the sun directly with a telephoto lens may lead to a loss of eyesight.
- If any irregularities occur during use, such as smoke or a strange odor, stop use immediately, remove the battery or the AC adapter, and contact your nearest PENTAX Service Center. Continuing to use the product can cause a fire or electric shock.

- Do not place your finger over the flash when discharging the flash. You may burn yourself.
- Do not cover the flash with clothing when discharging the flash. Discoloration may occur.
- Do not send data via infrared transmission with the infrared port of the camera pointed at a person's eyes. Doing so may cause impaired eyesight and other injury.
- Some portions of the camera heat up during use. There is a risk of low temperature burns when holding such portions for long periods.
- Should the monitor be damaged, be careful of glass fragments. Also, be careful not to allow the liquid crystal to get on your skin or in your eyes or mouth.
- Depending on your individual factors or physical condition, the use of the camera may cause itching, rashes or blisters. In case of any abnormality, stop using the camera and get medical attention immediately.

About the Battery Charger and AC Adapter



Warning

- Always use the battery charger and AC adapter exclusively developed for this product, with the specified power and voltage. Using a battery charger or AC adapter not exclusive to this product, or using the exclusive battery charger or AC adapter with an unspecified power or voltage can cause a fire, electric shock, or camera breakdown. The specified voltage is 100 - 240V AC.
- Do not disassemble or modify the product. This can cause a fire or electrical shock.
- If the generation of smoke or strange odor from the product or other abnormality occurs, immediately discontinue using and consult a PENTAX Service Center. Continuing to use the product can cause a fire or electrical shock.
- If water should happen to get inside the product, consult a PENTAX Service Center. Continuing to use the product can cause a fire or electrical shock.
- If thunderstorm should be present during use of the battery charger and AC plug cord, unplug the power plug and discontinue use. Continuing to use the product can cause damage to the equipment, fire or electrical shock.
- Wipe off the power plug if it should become covered with dust. Accumulated dust may cause a fire.
- To reduce the risk of hazards, use only CSA/UL certified power supply cord set, cord is Type SPT-2 or heavier, minimum NO.18 AWG copper, one end with a molded-on male attachment plug cap (with a specified NEMA configuration), and the other is provided with a molded-on female connector body (with a specified IEC nonindustrial type configuration) or the equivalent.



Caution

- Do not place or drop heavy objects on or forcefully bend the AC plug cord. Doing so may damage the cord. Should the AC plug cord be damaged, consult a PENTAX Service Center.
- Do not touch or short-circuit the terminal area of the AC plug cord while the cord is plugged in.
- Do not handle the power plug with wet hands. This can cause an electric shock.
- Do not drop the product, or subject it to violent impact. This can cause equipment breakdown.
- Do not use the battery charger to charge batteries other than the rechargeable lithium-ion battery D-LI109. Attempting to charge other types of batteries may cause an explosion or heating, or may damage the battery charger.

About the Rechargeable Lithium-ion Battery

Warning

- If any leakage from the battery should come in contact with your eyes, do not rub them. Flush your eyes with clean water and get medical attention immediately.

Caution

- Only use the specified battery with this camera. Use of other batteries may cause an explosion or fire.
- Do not disassemble the battery. Disassembling the battery may cause an explosion or leakage.
- Remove the battery from the camera immediately if it becomes hot or begins to smoke. Be careful not to burn yourself during removal.
- Keep wires, hairpins, and other metal objects away from the + and - contacts of the battery.
- Do not short the battery or dispose of the battery in fire. This can cause an explosion or fire.
- If any leakage from the battery should come in contact with skin or clothes, it may cause irritation to the skin. Wash the affected areas thoroughly with water.
- Precautions for D-LI109 Battery Usage:
USE SPECIFIED CHARGER ONLY.
 - DO NOT INCINERATE.
 - DO NOT DISASSEMBLE.
 - DO NOT SHORT CIRCUIT.
 - DO NOT EXPOSE TO HIGH TEMP. (140°F / 60°C)

About the Usage of AA Batteries

Warning

- If any leakage from the batteries should come in contact with your eyes, do not rub them. Flush your eyes with clean water and get medical attention immediately.

Caution

- When using the optional AA battery holder D-BH109, four AA alkaline, AA lithium or AA Ni-MH batteries can be used. Do not use batteries other than those specified here. Using other types of batteries may cause the camera to function poorly, or the batteries may explode or cause a fire.
- AA alkaline and AA lithium batteries cannot be recharged. Do not disassemble the batteries. Attempting to charge non-rechargeable batteries or disassembling the batteries could result in explosion or leakage.
- The batteries should be inserted correctly, observing (+) and (-) marks on the batteries. Inserting the batteries incorrectly may cause an explosion or fire.
- When replacing the batteries, do not combine different brands, types or capacities. Also, do not combine old batteries with new ones. Doing so may cause the batteries to explode or cause a fire.
- Do not short the batteries or dispose of the batteries in fire. Do not disassemble the batteries. The batteries could explode or catch fire.

- Do not charge any batteries other than rechargeable Ni-MH batteries. The batteries could explode or catch fire. AA batteries for use with this camera other than Ni-MH batteries cannot be charged.
- If any leakage from the batteries should come in contact with skin or clothes, it may cause irritation to the skin. Wash the affected areas thoroughly with water.
- Remove the batteries from the camera immediately if they become hot or begin to smoke. Be careful not to burn yourself during removal.

Keep the Camera and its Accessories out of the Reach of Small Children



Warning

- Do not place the camera and its accessories within the reach of small children.
 1. If the product falls or is operated accidentally it may cause serious personal injuries.
 2. Wrapping the strap around a neck may cause suffocation.
 3. To avoid the risk of a small accessory such as the battery or SD Memory Cards from being swallowed by mistake, keep them out of the reach of small children. Seek medical attention immediately if an accessory is accidentally swallowed.

Care to be Taken During Handling

Before Using Your Camera

- When traveling, take the Worldwide Service Network listing that is included in the package. This will be useful if you experience problems abroad.
- When the camera has not been used for a long time, confirm that it is still working properly, particularly prior to taking important pictures (such as at a wedding or when traveling). Contents of the recording cannot be guaranteed if recording, playback or transferring your data to a computer, etc. is not possible due to a malfunction of your camera or recording media (SD Memory Card), etc.

About the Battery and Charger

- Storing the battery fully charged may decrease the battery performance. Avoid storing in high temperatures.
- If the battery is left inserted and the camera is not used for a long time, the battery will over-discharge and shorten the battery's life.
- Charging the battery a day before use or on the day of use is recommended.
- The AC plug cord provided with this camera is developed exclusively for the battery charger D-BC109. Do not use it with other devices.

Precautions on Carrying and Using Your Camera

- Do not subject the camera to high temperatures or high humidity. Do not leave the camera in a vehicle, as the temperature can get very high.

- Do not subject the camera to strong vibrations, shocks, or pressure. Use a cushion to protect the camera from vibrations of motorcycles, automobiles, or ships.
- The temperature range for camera use is 0°C to 40°C (32°F to 104°F).
- The monitor may appear black at high temperatures, but will return to normal at normal temperatures.
- The monitor may respond more slowly at low temperatures. This is due to liquid crystal properties, and is not a malfunction.
- Sudden temperature changes will cause condensation on the inside and outside of the camera. Place the camera in your bag or a plastic bag, and remove the camera after temperature of the camera and surroundings are equalized.
- Avoid contact with garbage, mud, sand, dust, water, toxic gases, or salts. These could cause the camera to breakdown. Wipe the camera to dry off any rain or water drops.
- Please do not press forcefully on the monitor. This could cause it to break or malfunction.
- Be careful not to overtighten the screw in the tripod socket when using a tripod.

Cleaning Your Camera

- Do not clean the product with organic solvents such as thinner, alcohol, or benzine.
- Use a lens brush to remove dust accumulated on the lens or viewfinder. Never use a spray blower for cleaning as it may damage the lens.
- Please contact a PENTAX Service Center for professional cleaning of the CMOS sensor. (This will involve a fee.)

Storing Your Camera

- Do not store the camera with preservatives or chemicals. Storage in high temperatures and high humidity can cause mold to grow on the camera. Remove the camera from its case and store it in a dry and well-ventilated place.

Other Precautions

- Periodic inspections are recommended every one to two years to maintain high performance.
- Refer to "Precautions When Using the SD Memory Card" (p.53) regarding the SD Memory Card.
- Please note that deleting data stored on an SD Memory Card, or formatting an SD Memory Card does not completely erase the original data. Deleted files can sometimes be recovered using commercially available software. It is the user's responsibility to ensure the privacy of such data.

Regarding Product Registration

In order to better serve you, we request that you complete the product registration, which can be found on the CD-ROM supplied with the camera or on the PENTAX website. Refer to p.301 for details. Thank you for your cooperation.

Contents

For Using Your Camera Safely	1
Care to be Taken During Handling	4
Contents	6
Composition of the Operating Manual	13

Before Using Your Camera 15

<i>K-r</i> Camera Characteristics.....	16
Checking the Contents of the Package	18
Names and Functions of Working Parts	19
Capture Mode	20
Playback Mode	22
Display Indicators.....	24
Monitor	24
Viewfinder	32
How to Change Function Settings	34
Using the Direct Keys	34
Using the Control Panel	35
Using the Menu	37

Getting Started 41

Attaching the Strap	42
Inserting the Battery.....	43
Using the Lithium-ion Battery	43
Using the AA Batteries	46
Battery Level Indicator	49
Approximate Image Storage Capacity and Playback Time (Fully Charged Battery/New AA Batteries)	49
Using the AC Adapter (Optional)	50
Inserting/Removing an SD Memory Card.....	52
Recorded Pixels and Quality Level	54
Attaching a Lens.....	56
Adjusting the Viewfinder Diopter.....	58
Turning the Camera On and Off.....	59
Initial Settings	60
Setting the Display Language	60
Setting the Date and Time	64

Basic Operations

67

Basic Shooting Operation	68
Holding the Camera	68
Letting the Camera Choose the Optimal Settings	69
Using a Zoom Lens	74
Using the Built-in Flash	75
Setting the Flash Mode	75
Compensating Flash Output	81
Playing Back Pictures	82
Playing Back Images	82
Deleting a Single Image	84

Shooting Functions

85

How to Operate the Shooting Functions	86
Direct Keys Setting Items	86
Rec. Mode Menu Setting Items	87
Custom Setting Menu Setting Items	89
Selecting the Appropriate Capture Mode	91
Picture Modes	92
SCN Modes	93
Exposure Modes	95
Setting the Exposure	96
Effect of Aperture and Shutter Speed	96
Setting the Sensitivity	98
Reducing the Image Noise (Noise Reduction)	100
Changing the Exposure Mode	103
Selecting the Metering Method	114
Adjusting the Exposure	117
Locking the Exposure Before Shooting (AE Lock)	120
Focusing	122
Using the Autofocus	122
Setting the AF Mode	125
AF Fine Adjustment	128
Selecting the Focusing Area (AF Point)	129
Locking the Focus (Focus Lock)	132
Adjusting the Focus Manually (Manual Focus)	134

Checking the Composition, Exposure and Focus Before Shooting (Preview)	137
Assigning the Preview Function to the Green Button	137
Displaying the Optical Preview	139
Displaying the Digital Preview	140
Using the Shake Reduction Function to Prevent Camera Shake	141
Taking Pictures Using the Shake Reduction Function	141
Shooting with Self-timer	145
Shooting with Remote Control (Optional)	147
Taking Pictures Continuously	149
Continuous Shooting	149
Interval Shooting	151
Multi-exposure	153
Taking Pictures Using Digital Filters	155
Shooting with Live View	159
Setting Live View	160
Taking Still Pictures	162
Recording Movies	165
Changing the Movie Settings	165
Recording Movies	167
Playing Back Movies	169
Editing Movies	171

Using the Flash **173**

Flash Characteristics in Each Exposure Mode	174
Using the Slow-speed Sync	174
Using the Trailing Curtain Sync	176
Distance and Aperture when Using the Built-in Flash	178
Lens Compatibility with the Built-in Flash	179
Using an External Flash (Optional)	180
Using P-TTL Auto Mode	181
Using High-Speed Flash Sync Mode	182
Using Flash in Wireless Mode	183
Connecting an External Flash with an Extension Cord	187
Multiple Flash Shooting Using Extension Cords	188
Contrast-Control-Sync Flash	189

Shooting Settings

191

Setting a File Format	192
Setting the JPEG Recorded Pixels	192
Setting the JPEG Quality Level.....	193
Setting the File Format.....	195
Setting the Green Button Function	197
Setting the White Balance	200
Adjusting the White Balance Manually.....	202
Fine-Tuning the White Balance.....	204
Setting the Color Space	205
Correcting Images	207
Adjusting Brightness	207
Lens Correction.....	211
Setting the Image Finishing Tone	213
Setting Custom Image	213
Setting Cross Processing.....	216

Playback Functions

219

Playback Functions Operation	220
Playback Mode Palette Setting Items	220
Playback Menu Setting Items	221
Setting the Playback Display Method	222
Enlarging Images	223
Displaying Multiple Images	224
Multi-image Display Screen	224
Displaying Images by Folder.....	225
Displaying Images by Shooting Date (Calendar Display)	226
Comparing Images.....	228
Joining Multiple Images (Index)	229
Playing Back Images Continuously	232
Setting the Slideshow Display.....	232
Starting the Slideshow	233
Rotating Images	235
Deleting Multiple Images	236
Deleting Selected Images	236
Deleting a Folder.....	238
Deleting All Images	239

Protecting Images from Deletion (Protect)	240
Protecting a Single Image	240
Protecting All Images	241
Connecting the Camera to an AV Device	242
Exchanging Image Data with Other Devices	244
Sending and Receiving Image Data via Infrared Transmission	244
Playing a Dueling Game using Your Images (Dueling Images)	246

Processing Images **249**

Changing the Image Size	250
Changing the Number of Recorded Pixels and Quality Level (Resize)	250
Cutting Out Part of the Image (Cropping)	251
Processing Images with Digital Filters	253
Applying the Digital Filter	255
Recreating Filter Effects	256
Searching for the Original Image	258
Developing RAW Images	259
Developing One RAW Image	259
Developing Multiple RAW Images	260
Specifying the Parameters	262

Changing Additional Settings **265**

How to Operate the Set-up Menu	266
Set-up Menu Setting Items	266
Formatting an SD Memory Card	268
Setting the Beep, Date and Time, and Display Language	269
Setting the Beep	269
Changing the Date and Time Display	270
Setting the World Time	270
Setting the Display Language	273
Adjusting the Monitor and the Menu Display	274
Setting the Text Size	274
Setting the Guide Display Time	274
Setting the Initial Menu Tab Displayed	275
Setting the Status Screen Display	276
Setting the Display for Instant Review	276
Adjusting the Brightness of the Monitor	277
Adjusting the Color of the Monitor	278

Setting the Folder/File Number	279
Changing the Naming System of the Folder	279
Creating New Folders	279
Selecting the File Number Setting	280
Selecting the Power Settings	281
Setting the Auto Power Off Function.....	281
Setting the Battery Type	282
Setting the Photographer Information.....	283
Setting the DPOF Settings.....	285
Correcting Defective Pixels in the CMOS Sensor (Pixel Mapping)	287
Selecting Settings to Save in the Camera (Memory).....	288
 Connecting to a Computer	 291
<hr/>	
Manipulating Captured Images on a Computer	292
Saving Images on Your Computer	293
Setting the USB Connection Mode	293
Saving Images by Connecting Your Camera and Your Computer ..	294
Using the Provided Software.....	296
Installing the Software.....	296
Screens of the PENTAX Digital Camera Utility 4	298

Default Settings	304
Resetting the Menus	310
Resetting the Rec. Mode/Playback/Set-up Menus	310
Resetting the Custom Menu	311
Functions Available with Various Lens Combinations	312
Notes on [22. Using Aperture Ring]	314
Cleaning the CMOS Sensor	315
Removing Dust by Shaking the CMOS Sensor (Dust Removal)	315
Detecting Dust on the CMOS Sensor (Dust Alert)	316
Removing Dust with a Blower	318
Optional Accessories	320
Error Messages	325
Troubleshooting	328
Main Specifications	331
Glossary	337
Index	342
WARRANTY POLICY	348

Composition of the Operating Manual

This Operating Manual contains the following chapters.

1 Before Using Your Camera

Explains camera characteristics, accessories and the names and functions of various parts.

1

2 Getting Started

Explains your first steps from purchasing the camera to taking pictures. Be sure to read this chapter and follow the instructions.

2

3 Basic Operations

Explains the procedures for taking and playing back pictures.

3

4 Shooting Functions

Explains the shooting-related functions.

4

5 Using the Flash

Explains how to use the built-in flash and external flashes.

5

6 Shooting Settings

Explains the procedures for configuring image processing and setting the file format.

6

7 Playback Functions

Explains the procedures for playing back, deleting, and protecting images.

7

8 Processing Images

Explains the procedures for changing the image size, applying digital filters and developing images taken in RAW format.

8

9 Changing Additional Settings

Explains the procedures for changing the camera settings, such as the monitor display settings and the image folder naming convention.

9

10

10 Connecting to a Computer



Explains how to connect the camera to a computer, and includes installation instructions and a general overview of the provided software.

11

11 Appendix

Explains troubleshooting, introduces optional accessories and provides various resources.

The symbols used in this Operating Manual are explained below.

	Indicates reference page number explaining a related operation.
	Indicates useful information.
	Indicates precautions to take when operating the camera.

1 Before Using Your Camera

Check the package contents and the names and functions of working parts before use.

<i>K-r</i> Camera Characteristics	16
Checking the Contents of the Package	18
Names and Functions of Working Parts	19
Display Indicators	24
How to Change Function Settings	34

- Features a 23.6×15.8 mm CMOS sensor with approximately 12.4 million effective pixels for high precision and a wide dynamic range.
- Features Shake Reduction (SR), an image sensor shifting shake reduction system. This enables you to capture sharp pictures with minimal camera shake regardless of the lens type.
- Features a viewfinder similar to that of a conventional 35 mm camera, with a magnification of approximately 0.85 and field of view of approximately 96%, for easier image composition and manual focusing. Also features a superimpose function in which the active AF point(s) on the viewfinder illuminate red.
- Features a large 3.0-inch monitor with approximately 921,000 dots, a wide viewing angle and brightness and color adjusting functions for high-precision viewing performance.
- In addition to the rechargeable lithium-ion battery D-LI109, the commercially available AA lithium batteries, AA Ni-MH rechargeable batteries or AA alkaline batteries can also be used with the optional AA battery holder D-BH109.
- Features a Live View function for shooting while viewing the subject in real-time on the monitor.
- Movies can be recorded by taking advantage of the lens properties. The camera can also output a composite video signal so that you can view recorded images and movies on a monitor such as a TV screen.
- A user-friendly design has been implemented in various parts of the camera. The large text size, high-contrast monitor and easy-to-use menus make the camera easier to operate.
- The CMOS sensor features a special SP coating to prevent dust sticking to the sensor. The Dust Removal function also shakes the CMOS sensor for removing collected dust.
- Features Digital Filters to internally process the image in the camera. You can use digital filters such as Color or Soft while taking pictures or to process images after taking them.
- Features Custom Image which allows you to adjust settings while previewing the end result of the edited image, enabling a wider range of expression.
- Records images in the versatile JPEG format or the high quality and fully editable RAW format. You can also select JPEG+RAW and record in both formats simultaneously. Pictures taken in RAW format can be easily processed internally by the camera.

- Features Sensitivity Priority mode **Sv** that automatically adjusts aperture and shutter speed according to the set sensitivity.
- Supports infrared transmission (IrSimple/IrSS) which allows you to send and receive image data to and from cell phones and printers.

Shake Reduction (SR)

Shake Reduction (SR) on the **K-r** features a PENTAX original system which uses magnetic force to move the image sensor at high speeds, compensating for camera shake.

The camera may generate some operating noise when it is shaken, such as when changing the composition of a picture. This is normal and not a malfunction.

Additionally Saving as a RAW Image

When the file format of the last captured image is JPEG, and its data still remains in the buffer memory, you can additionally save the image in RAW format by pressing the **Av** button during playback. If the image was shot using any of the following settings, the corresponding RAW image listed is saved.

- Cross Processing RAW image without Cross Processing
- Digital Filter RAW image without filter effect
- HDR Capture RAW image with standard exposure
- Multi-exposure RAW image with Multi-exposure

The captured area (view angle) will differ between the **K-r** and 35 mm SLR cameras even if the same lens is used because the format sizes for 35 mm film and CMOS sensor are different.

Sizes for 35 mm film and CMOS sensor

35 mm film: 36×24 mm

K-r CMOS sensor: 23.6×15.8 mm

The focal length of a lens used with a 35 mm camera is about 1.5 times longer than that of the **K-r**. To shoot images with an angle of view framing the same area, divide the focal length of the 35 mm lens by 1.5.

Example) To capture the same image as a 150 mm lens attached to a 35 mm camera

$150 \div 1.5 = 100$

Use a 100 mm lens with the **K-r**.

Inversely, multiply the focal length of the lens used with the **K-r** by 1.5 to determine the focal length for 35 mm cameras.

Example) If 300 mm lens is used with the **K-r**

$300 \times 1.5 = 450$

Focal length is equivalent to a 450 mm lens on a 35 mm camera.

Checking the Contents of the Package

The following accessories are packaged with your camera. Check that all accessories are included.

1

Before Using Your Camera



Hot shoe cover F_k
(Installed on camera)

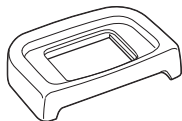

Eyecup F_α
(Installed on camera)

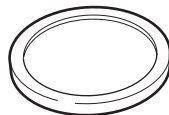

Body mount cover
(Installed on camera)

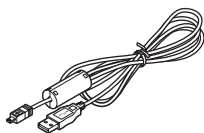

USB cable
I-USB7

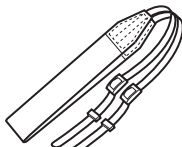

Strap
O-ST53

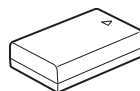

Rechargeable lithium-ion
battery D-LI109

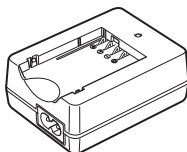

Battery charger
D-BC109



AC plug cord



Software (CD-ROM)
S-SW110



Operating Manual
(this manual)



Refer to p.320 for information on optional accessories.

Names and Functions of Working Parts

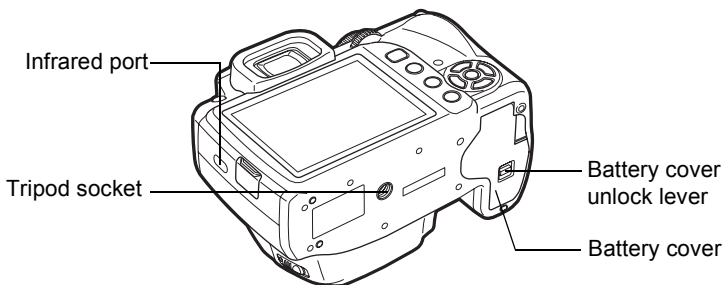
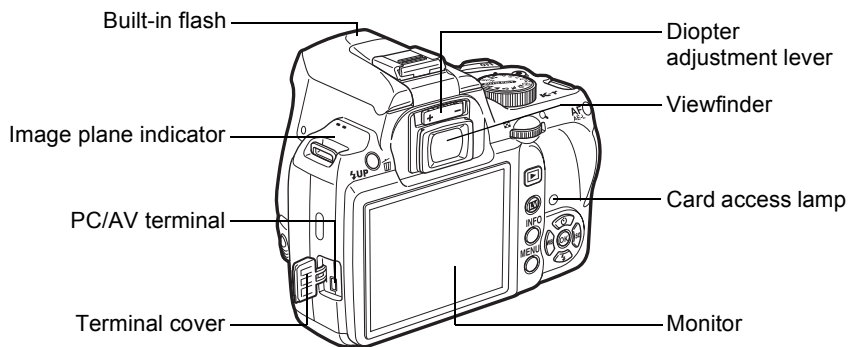
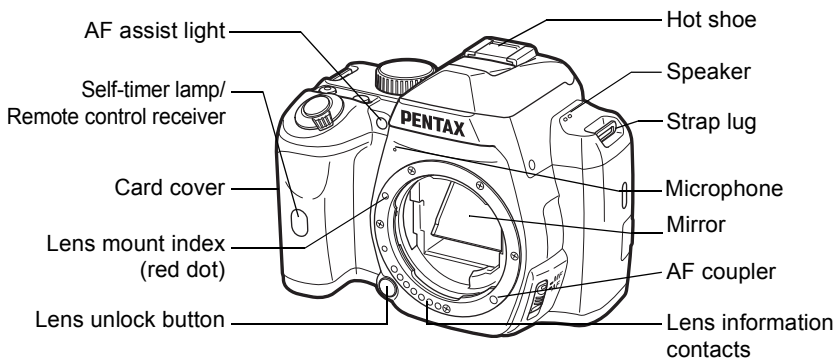

* In the second illustration, the camera is shown with the Eyecup F_α removed.

Capture Mode

Functions of buttons, dials and levers used during shooting are noted.



1

Before Using Your Camera

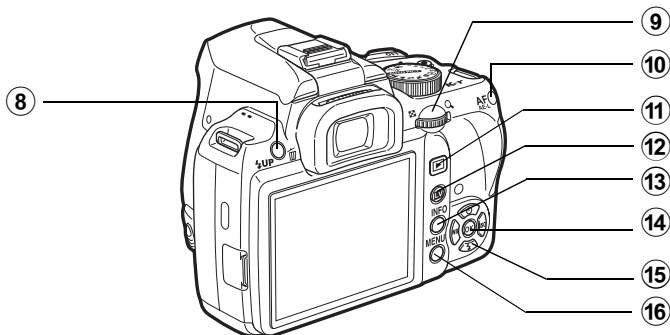
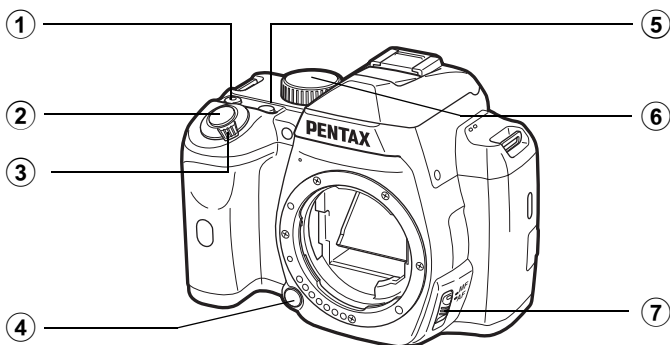

The factory default settings are explained here. Depending on the button, these settings can be changed.



- ① **⦿ (Green) button**
You can assign a function to this button. (p.197)
- ② **Shutter release button**
Press to capture images. (p.72)
- ③ **Main switch**
Move to turn the camera on and off. (p.59)
- ④ **Lens unlock button**
Press to detach a lens. (p.57)
- ⑤ **⦿ Av button**
Sets the EV compensation and aperture values. (p.104, p.110, p.117)
- ⑥ **Mode dial**
Changes Capture mode. (p.91)
- ⑦ **Focus mode lever**
Switches between autofocus mode (p.122) and manual focus mode (p.134).
- ⑧ **⚡UP/🗑️ button**
Press to pop up the built-in flash. (p.75)
- ⑨ **E-dial**
Sets the shutter speed, aperture, sensitivity and EV compensation values.
- ⑩ **AF/AE-L button**
You can select the function of this button either to focus on the target or to lock the exposure value. (p.112, p.120, p.123)
- ⑪ **▶ button**
Switches to Playback mode. (p.82)
- ⑫ **LV button**
Displays a Live View image. (p.159)
- ⑬ **INFO button**
Displays the status screen (p.25)
Switches to the control panel when the status screen is shown. (p.26)
- ⑭ **OK button**
When the control panel or a menu screen is displayed, press this button to confirm the selected item.
When the focusing area is set to  (Select), press this button to enable or disable changing the AF point. (p.129)
- ⑮ **Four-way controller (▲▼◀▶)**
Displays the Drive Mode/Flash Mode/White Balance/Sensitivity setup menu. (p.86)
When the control panel or a menu screen is displayed, use this to move the cursor or change items.
Changes the AF point when it can be changed.
- ⑯ **MENU button**
Displays the [ Rec. Mode 1] menu (p.87). Next, press the four-way controller (▶) to display other menus.

Playback Mode

Functions of buttons, dial and lever used during playback are noted.

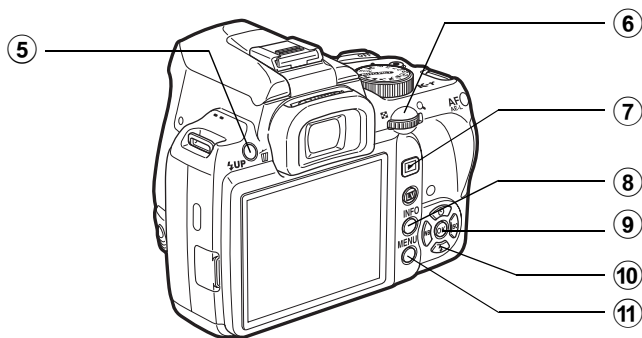
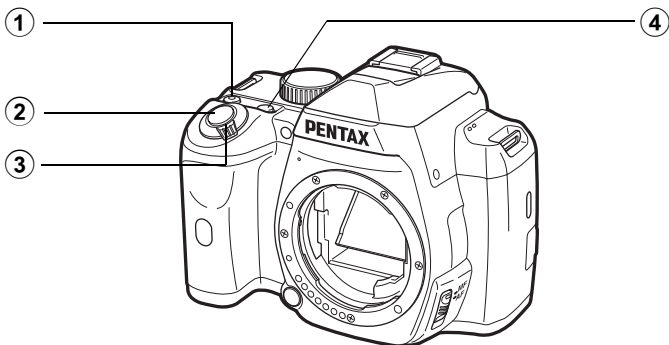

1

Before Using Your Camera

- ① **⦿ (Green) button**
Press to change the settings, such as resetting the values. (p.197)
- ② **Shutter release button**
Press halfway to switch to Capture mode.
- ③ **Main switch**
Move to turn the camera on and off. (p.59)
- ④ **⦿ Av button**
When the file format of the last captured image is JPEG, and its data still remains in the buffer memory, press this button to additionally save the image in RAW format. (p.83)
- ⑤ **⚡UP/🗑️ button**
Press to delete images. (p.84)
- ⑥ **E-dial**
Use this to enlarge an image (p.223) or display multiple images at the same time (p.224).
- ⑦ **▶️ button**
Switches to Capture mode.
- ⑧ **INFO button**
Displays shooting information on the monitor. (p.27)
- ⑨ **OK button**
Confirms the setting you selected in the menu or playback screen.
- ⑩ **Four-way controller (▲▼◀▶)**
Use this to move the cursor or change items in the menu or playback screen. Press the four-way controller (▼) to display the playback mode palette. (p.220)
- ⑪ **MENU button**
Displays the [▶️ Playback 1] menu (p.221). Next, press the four-way controller (▶️) to display other menus.

References to Button Names

In this Operating Manual, the buttons of the four-way controller are referred to in the following way.

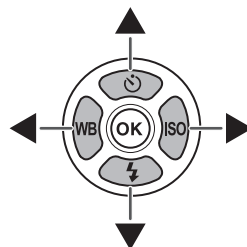

Monitor

The various information appears on the monitor depending on the status of the camera.

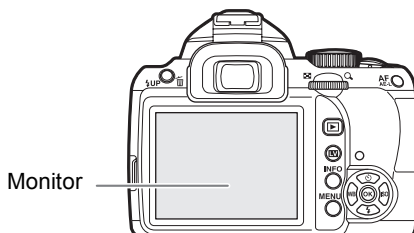

The brightness and the color of the monitor can be adjusted. (p.277, p.278)

At Start-up or when Operating the Mode Dial

Guides appear on the monitor for 3 seconds (default setting) when the camera is switched on or the mode dial is turned.

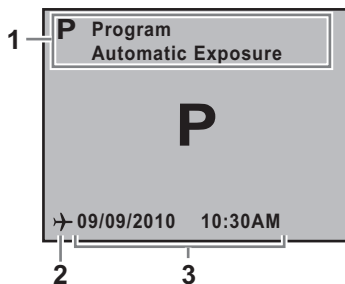

- | | | | |
|---|--|---|------------------------------|
| 1 | Capture mode (p.91) | 3 | Current date and time (p.64) |
| 2 | World Time (p.270)
(only when set to Destination) | | |



To not show guides, set [Guide Display] to [Off] in the [Set-up 1] menu. (p.274)

Capture Mode

While shooting, the status screen is displayed showing the current shooting function settings. You can change the type of the screen displayed by pressing the **INFO** button.

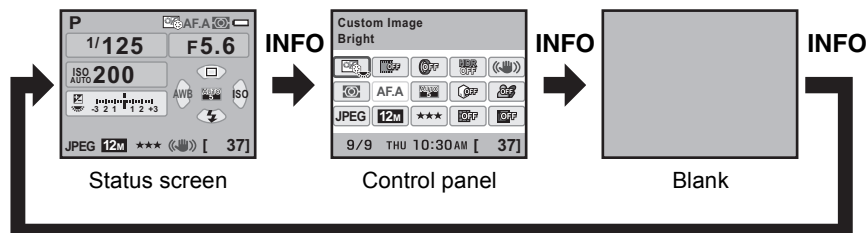

● Status screen

(All items are displayed here for explanatory purposes. The actual display may differ.)

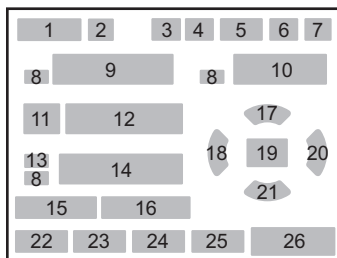
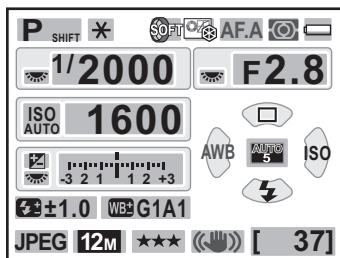

- | | |
|--|--|
| <ol style="list-style-type: none"> 1 Capture Mode (p.91) 2 AE Lock (p.120) 3 Interval Shooting (p.149)/Multi-exposure (p.153)/Digital Filter (p.155)/HDR Capture (p.209) /Cross Processing (p.216) 4 Custom Image (p.213)/ Cross Processing (p.216) 5 Focus Mode (p.122) 6 AE Metering (p.114) 7 Battery level (p.49) 8 E-dial guide 9 Shutter speed 10 Aperture value 11 ISO AUTO 12 Sensitivity (p.98) | <ol style="list-style-type: none"> 13 EV Compensation (p.117)/ Exposure Bracketing (p.118) 14 EV bar 15 Flash Exposure Compensation (p.81) 16 White Balance fine-tuning (p.204) 17 Drive Mode (p.86) 18 White Balance (p.200) 19 Select AF point (p.129) 20 Sensitivity (p.98) 21 Flash Mode (p.75) 22 File Format (p.195) 23 JPEG Recorded Pixels (p.192) 24 JPEG Quality (p.193) 25 Shake Reduction (p.141) 26 Remaining image storage capacity/☉ button guide |
|--|--|

● Control panel

Press the **INFO** button in the status screen to display the control panel and change settings.

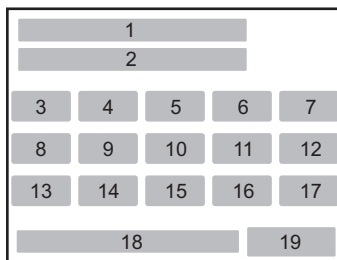
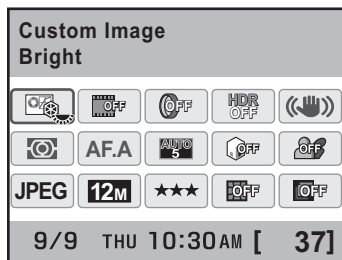

- | | | | |
|----|--------------------------|----|---|
| 1 | Function name | 11 | Highlight Correction (p.207) |
| 2 | Setting | 12 | Shadow Correction (p.208) |
| 3 | Custom Image (p.213) | 13 | File Format (p.195) |
| 4 | Cross Processing (p.216) | 14 | JPEG Recorded Pixels (p.192) |
| 5 | Digital Filter (p.155) | 15 | JPEG Quality (p.193) |
| 6 | HDR Capture (p.209) | 16 | Distortion Correction (p.211) |
| 7 | Shake Reduction (p.141) | 17 | Lateral Chromatic Aberration Correction (p.211) |
| 8 | AE Metering (p.114) | 18 | Current date and time |
| 9 | AF Mode (p.125) | 19 | Remaining image storage capacity |
| 10 | Select AF point (p.129) | | |



- Settings that cannot be changed due to the current camera setup cannot be selected.
- On the status screen, the setting currently being changed or guide display for the buttons that can be operated are displayed in blue (when [Status Screen] in the [Set-up 1] menu is set to [Display Color 1]).
- The status screen will disappear if no operations are made within 30 seconds. Press the **INFO** button to display it again.
- If no operations are made within 30 seconds in the control panel, the status screen will reappear.
- If [Shooting Info Display] is set to (On) in [Memory] (p.288) of the [Rec. Mode 4] menu and the blank screen is selected, the next time the camera is turned on the blank screen is displayed first.
- [9999] is the maximum number of recordable images that can be displayed on the status screen and in the control panel. Even if the number of recordable images is 10,000 or more, [9999] is displayed.

Playback Mode

The camera switches the types of information display when you press the **INFO** button during playback.

Standard	Captured image, file format and guides are displayed.
Histogram display	Captured image and histogram (Brightness/RGB) are displayed. Not available during movie playback. (p.30)
Detailed information display	Detailed information on how and when the image was taken is displayed. (p.28)
No info. display	Only captured image is displayed.

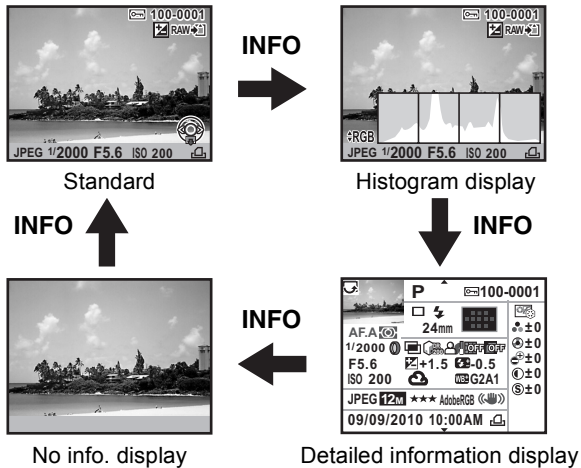

The type of information display that is shown first during playback is the same as that of the last playback in the previous session. If [Playback Info Display] is set to (Off) in [Memory] (p.288) of the [Rec. Mode 4] menu, the [Standard] screen is always displayed first when the camera is turned on.

● Detailed information display

Use the four-way controller (▲▼) to switch between pages.

Page 1

Still Picture

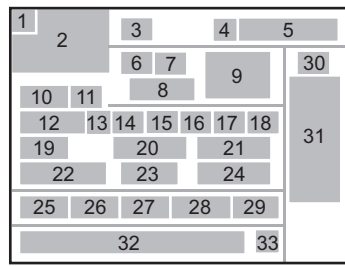
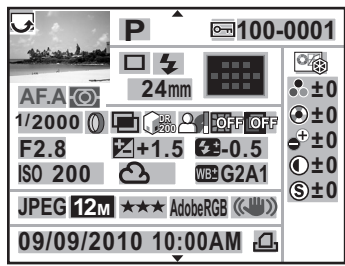

Movie

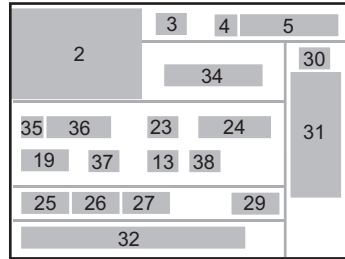
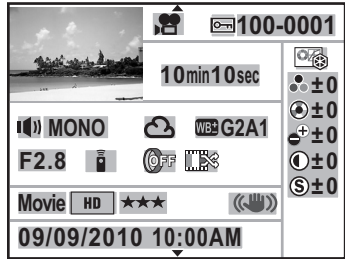

Page 2



Still Picture/Movie

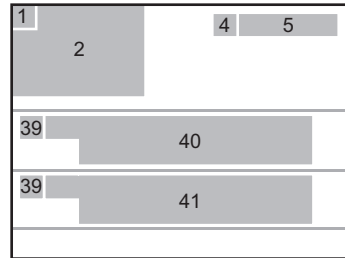

- | | |
|---|--|
| 1 Rotation information (p.235) | 20 EV Compensation (p.117) |
| 2 Captured image | 21 Flash Exposure Compensation (p.81) |
| 3 Capture Mode (p.91) | 22 Sensitivity (p.98) |
| 4 Protect (p.240) | 23 White Balance (p.200) |
| 5 Folder number-File number (p.279) | 24 White Balance fine-tuning (p.204) |
| 6 Drive Mode (p.86) | 25 File Format (p.195) |
| 7 Flash Mode (p.75) | 26 Recorded Pixels (p.165, p.192) |
| 8 Lens focal length | 27 Quality Level (p.165, p.193) |
| 9 AF point (p.129)/
Autofocus Method (p.160) | 28 Color Space (p.205) |
| 10 Focus Mode (p.122) | 29 Shake Reduction (p.141, p.166) |
| 11 AE Metering (p.114) | 30 Image Tone (p.213) |
| 12 Shutter speed | 31 Custom Image parameters (p.213) |
| 13 Digital Filter (p.155) | 32 Shooting date and time |
| 14 HDR Capture (p.209)/
Multi-exposure (p.153)/
Cross Processing (p.216) | 33 DPOF Setting (p.285) |
| 15 Highlight Correction (p.207) | 34 Recording time |
| 16 Shadow Correction (p.208) | 35 Sound setting (p.166) |
| 17 Distortion Correction (p.211) | 36 Sound type (p.165) |
| 18 Lateral Chromatic Aberration
Adjustment (p.211) | 37 Drive Mode (Remote Control) |
| 19 Aperture value | 38 Cross Processing (p.216) |
| | 39 Information tampering warning |
| | 40 Photographer (p.283) |
| | 41 Copyright Holder (p.283) |

* For images taken with Live View, the autofocus method is displayed for indicator 9.

* Indicators 7 and 21 appear only for images taken with the flash.

* Indicators 13, 14, 15, 16, and 24 appear only for images taken with the corresponding functions enabled.

* Indicators 26 and 27 do not appear for RAW images.

● Histogram Display

The following histograms can be displayed when playing back still pictures. The “Brightness histogram” shows the distribution of brightness and the “RGB histogram” shows the distribution of color intensity. Press the four-way controller (▲▼) to switch between “Brightness histogram” and “RGB histogram”.

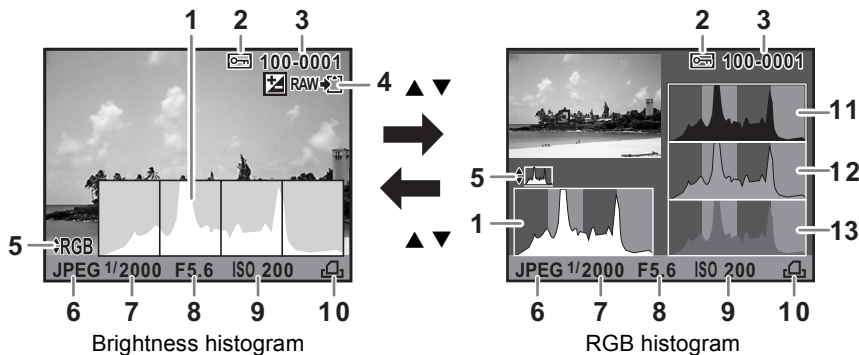

- | | |
|--|------------------|
| 1 Histogram (Brightness) | 7 Shutter speed |
| 2 Protect | 8 Aperture value |
| 3 Folder number-File number | 9 Sensitivity |
| 4 Additionally saving in RAW format | 10 DPOF Setting |
| 5 Switch RGB histogram/ Brightness histogram | 11 Histogram (R) |
| 6 File Format | 12 Histogram (G) |
| | 13 Histogram (B) |

* Indicator 2 appears only for protected images.

* Indicator 4 appears only when the file format of the last captured image is JPEG, and its data still remains in the buffer memory. (p.83)



If [Bright/Dark Area] (p.222) of the [▶ Playback 1] menu is set to (On), areas affected by bright or dark portions blink (except when in RGB histogram display and Detailed information display).

Using the Histogram

A histogram shows the brightness distribution of an image. The horizontal axis represents brightness (dark at the left and bright at the right) and the vertical axis represents the number of pixels. The shape and the distribution of the histogram before and after shooting tells you whether the exposure level and contrast are correct or not, and lets you decide if you need to adjust the exposure and take a picture again.

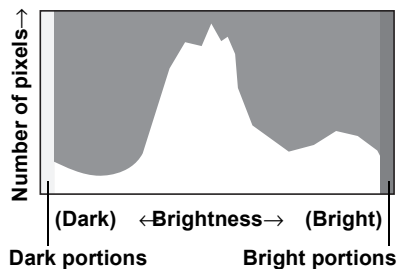

- ☞ Adjusting the Exposure (p.117)
- ☞ Adjusting Brightness (p.207)

Understanding Brightness

When the brightness is correct and there are no overly bright or dark areas, the graph peaks in the middle. If the image is too dark, the peak is on the left side, and if it is too bright, the peak is on the right side.

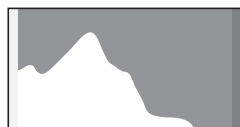

Dark image

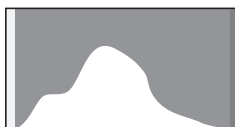
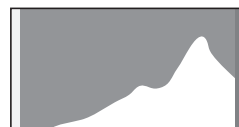

Image with few bright or dark areas



Bright image

When the image is too dark, the part to the left is cut off (dark portions with no detail) and when the image is too bright, the part to the right is cut off (bright portions with no detail).

Bright portions blink red and dark portions blink yellow on the monitor when [Bright/Dark Area] is (On).

- ☞ Playing Back Images (p.82)
- ☞ Setting the Playback Display Method (p.222)
- ☞ Setting the Display for Instant Review (p.276)

Understanding Color Balance













Distribution of color intensity is displayed for each color in the RGB histogram. The right side of the graphs look similar for images that have White Balance adjusted well. If only one color is lopsided to the left, that color is too intense.

- ☞ Setting the White Balance (p.200)

Guide Indicators

The following indicators appear on the monitor to indicate the keys, buttons and e-dial that can be operated at that time.

Example)

	Four-way controller (▲)		MENU button
	Four-way controller (▼)		INFO button
	Four-way controller (◀)		AF/AE-L button
	Four-way controller (▶)		Green button
	OK button		Av button
	E-dial		UP /Trash button
	Shutter release button		

Viewfinder

The following information appears in the viewfinder.

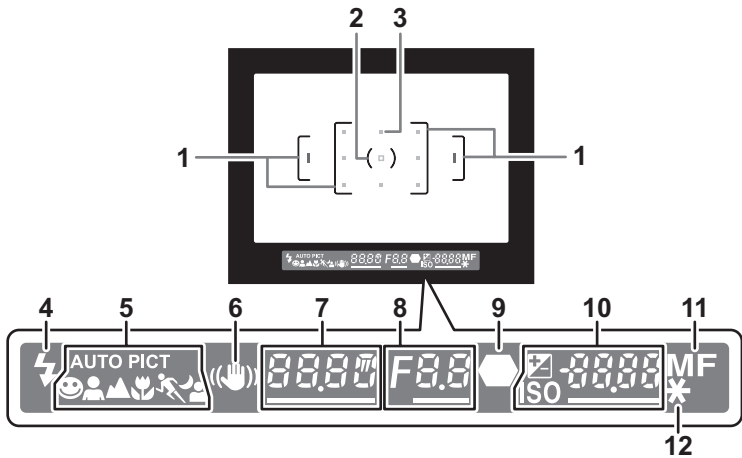

- 1 AF frame (p.58)
- 2 Spot metering frame (p.115)
- 3 AF point (p.129)
- 4 Flash status (p.75)

Lit: when flash is available.

Blinks: when flash is recommended but not set.

- 5** Picture mode icon (p.92)
The icon for Picture mode in use appears.
☺ (Normal mode of **AUTO PICT**), 👤 (Portrait), ▲ (Landscape), 🌿 (Macro), 🏠 (Moving Object), 🌃 (Night Scene Portrait)
- 6** Shake Reduction (p.141)
Appears when the Shake Reduction function is activated.
- 7** Shutter speed
Shutter speed when capturing or adjusting.
Underlined when the shutter speed can be adjusted with the e-dial.
A countdown of processing time is displayed when the Noise Reduction function is activated. (p.100)
- 8** Aperture value
Aperture value when capturing or adjusting.
Underlined when the aperture value can be adjusted with the e-dial.
[nr] blinks when the Noise Reduction function is activated. (p.100)
- 9** Focus indicator (p.70)
Lit: when the subject is focused.
Blinks: when the subject is not in focus.
- 10** Number of recordable images/EV compensation value
Displays the number of recordable images with current quality level and recorded pixels.
The difference from the proper exposure value appears when the mode dial is set to **M**. (p.111)
☑: EV Compensation (p.117)
Underlined when the EV compensation value can be adjusted with the e-dial while the ☑ **Av** button is pressed.
ISO: Sensitivity
Underlined when the sensitivity can be adjusted with the e-dial.
- 11** Focus mode (p.122)
Appears when set to **MF**.
- 12** AE Lock (p.120)
Appears while the AE Lock function is activated.



- The AF point(s) in use for autofocus appear in red (Superimpose AF Area) when the shutter release button is pressed halfway. (p.129)
- [9999] is the maximum number of recordable images that can be displayed in the viewfinder. Even if the number of recordable images is 10,000 or more, [9999] is displayed.
- When [AF/AE-L Button] is set to [Cancel AF] in the [📷 Rec. Mode 4] menu, **MF** is displayed in the viewfinder while the **AF/AE-L** button is pressed. (p.123)

Function settings can be changed using the direct keys, control panel or menus.

This section explains the basic ways to change function settings.

1

Before Using Your Camera

Using the Direct Keys

In Capture mode, you can set Drive Mode, Flash Mode, White Balance and Sensitivity by pressing the four-way controller (▲▼◀▶). (p.86)
Below, how to set [Flash Mode] is explained as an example.

- 1 Press the four-way controller (▼) in Capture mode.**

The [Flash Mode] screen appears.

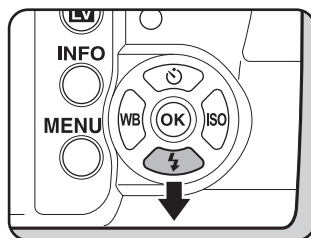

- 2 Use the four-way controller (◀▶) to select a flash mode.**

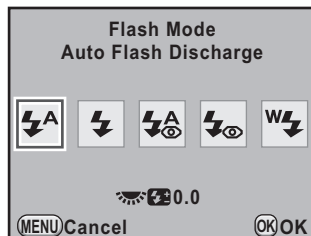

- 3 Press the OK button.**

The camera is ready to take a picture.

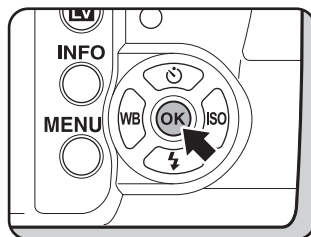



When direct key operation is enabled, the guide indicators for the direct keys are displayed in the status screen. Direct key operation is not available when the AF point is being changed while the focusing area is set to (Select). In such cases, press and hold the **OK** button. (p.130)

Using the Control Panel

While shooting, the current settings can be checked on the status screen. You can also switch the display to the control panel and change settings. Below, how to set [JPEG Quality] is explained as an example.

1 Check the status screen and then press the **INFO** button.

The control panel appears.

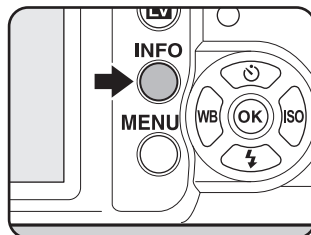

Press the **INFO** button when the status screen is not displayed.

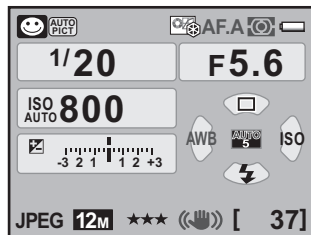

2 Use the four-way controller (**▲▼◀▶**) to select an item you want to change the setting for.

You cannot select items that cannot be changed.

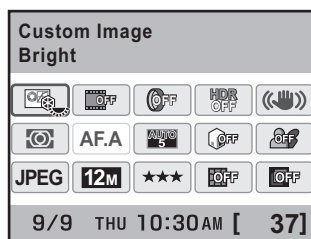

3 Press the **OK** button.

The setup screen of the selected item appears.

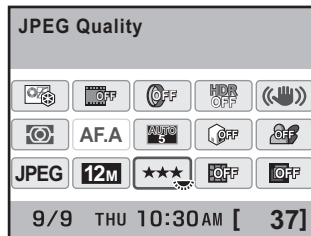

4 Use the four-way controller (◀▶) or e-dial to select a setting value.

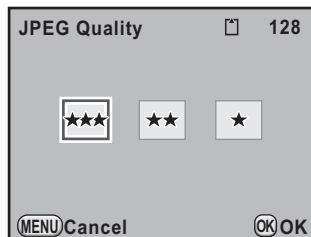

5 Press the **OK** button.

The camera returns to the control panel and is ready to take a picture.



- You can also change the setting by turning the e-dial after selecting the item you want to change in Step 2. Detailed settings such as parameters can be changed after pressing the **OK** button.
- The status screen and control panel are not displayed when Live View (p.159) is displayed. Make or change necessary settings in the [📷 Rec. Mode] menu in advance.

Using the Menus

This section explains how to use the menus: [📷 Rec. Mode], [▶ Playback], [⚙ Set-up] and [C Custom Setting] menus.

Below, how to set [Slow Shutter Speed NR] in the [📷 Rec. Mode 2] menu is explained as an example.

1 Press the MENU button in Capture mode.

The [📷 Rec. Mode 1] menu appears on the monitor.

If the **MENU** button is pressed in Playback mode, the [▶ Playback 1] menu appears. When the mode dial is set to **SCN** (Scene), the [SCN Scene] menu appears instead.

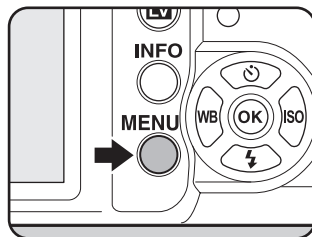

2 Press the four-way controller (▶).

Each time the four-way controller (▶) is pressed, the menu will change in the following sequence: [📷 Rec. Mode 2], [📷 Rec. Mode 3], [📷 Rec. Mode 4], [▶ Playback 1] ... [📷 Rec. Mode 1].

You can also use the e-dial to switch the menus.

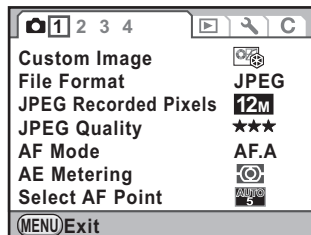

3 Use the four-way controller (▲▼) to choose an item.

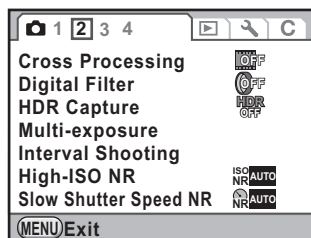

4 Press the four-way controller (▶).

Available settings are displayed.

The frame moves to the pop-up menu if there is one. When there is a submenu, it is displayed.

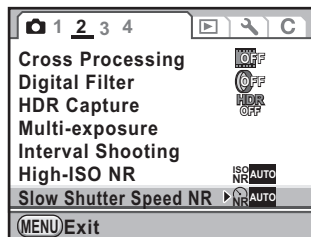

5 Use the four-way controller (▲▼) to select a setting.

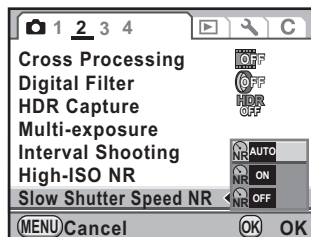

6 Press the OK button.

The setting is saved.

Press the **MENU** button if a submenu is displayed.

Next, set other items.

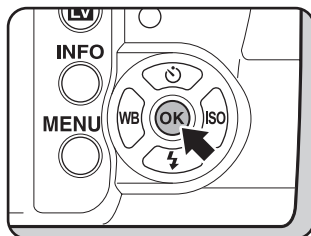

7 Press the MENU button.

The screen that was displayed before selecting the menu appears again.

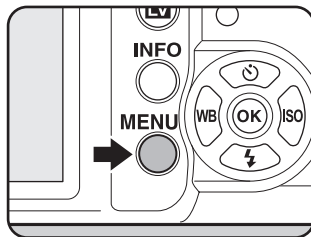

Even after you press the **MENU** button and close the menu screen, your settings will not be saved if the camera is turned off improperly (such as by removing the battery while the camera is on).



- You can select whether to display the menu tab selected the last time first, or to always display the [📷 Rec. Mode 1] menu first. (p.275)
- Refer to the following pages for details on each menu.
 - [📷 Rec. Mode] menu p.87
 - [▶ Playback] menu p.221
 - [🔧 Set-up] menu p.266
 - [C Custom Setting] menu p.89

Memo

2 Getting Started

This chapter explains your first steps from purchasing the camera to taking pictures. Be sure to read it and follow the instructions.

Attaching the Strap	42
Inserting the Battery	43
Inserting/Removing an SD Memory Card	52
Attaching a Lens	56
Adjusting the Viewfinder Diopter	58
Turning the Camera On and Off	59
Initial Settings	60

Attaching the Strap

- 1** Pass the end of the strap through the strap lug, then secure it on the inside of the clasp.

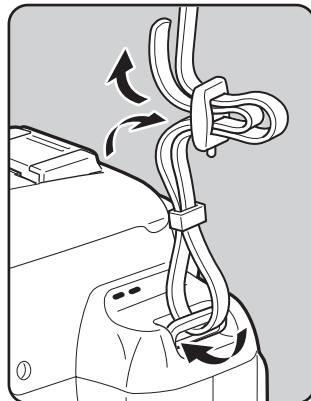

- 2** Attach the other end of the strap in the same manner as described above.

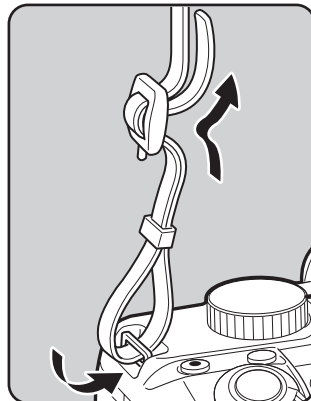

Insert the lithium-ion battery or AA batteries into the camera.

Using the Lithium-ion Battery

Use the exclusive battery D-LI109.

Charging the Battery

When using the battery for the first time, or when the battery has not been used in a long time, or when [Battery depleted] appears, recharge the battery.

Note: AC plug cord “Listed, Type SPT-2 or NISPT-2, 18/2 flexible cord, rated 125 V, 7A, minimum 6ft (1.8m)”

- 1** Connect the AC plug cord to the battery charger.
- 2** Plug the AC plug cord into the power outlet.

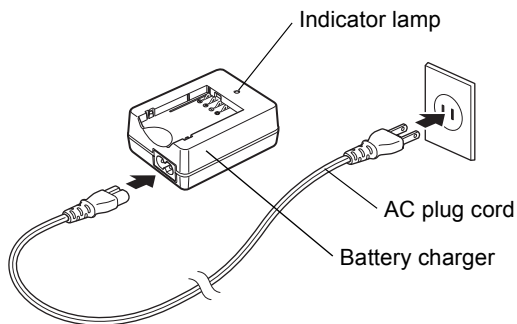

3 Face the ▲ mark on the exclusive battery up and insert it into the battery charger.

First, insert the battery at an angle, as shown in the illustration, and then push down on the battery until it clicks.

The indicator lamp is lit during charging and turns off when the battery is fully charged.

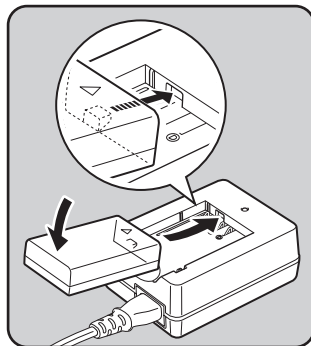

4 When the battery is fully charged, remove the battery from the battery charger.



- Do not use the provided Battery Charger D-BC109 to charge batteries other than rechargeable lithium-ion battery D-LI109. Charging other batteries may cause damage or heating.
- If the battery is correctly oriented and inserted into the battery charger but the indicator lamp is not lit, the battery is faulty. Use a new battery in the camera.



- The maximum charging time is approximately 240 minutes (it depends on temperature and remaining battery power). Charge in a location where the temperature is between 0°C and 40°C.
- If battery usage time is reduced even when properly charged, the battery has reached the end of its life. Use a new battery in the camera.

Inserting/Removing the Battery



- Do not open the battery cover or remove the battery while the power is on.
- Remove the battery when you will not use the camera for a long while. The battery may leak.
- If the date and time settings have been reset when you install a new battery after a long time has passed since the battery was removed, follow the procedure for “Setting the Date and Time” (p.64).
- Insert the battery correctly. If the battery is inserted incorrectly, it may not be removed. Wipe the electrodes of the battery with a soft dry cloth before inserting.
- Be careful as the camera or battery may become hot when the camera is used continuously for a long period of time.

- 1** Slide the battery cover unlock lever in the direction of the arrow (①) to open the battery cover (②).

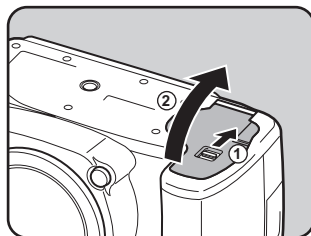

- 2** Face the ▲ mark on the battery towards outside of the camera, push the battery lock lever in the direction of the arrow (③) and insert the battery.

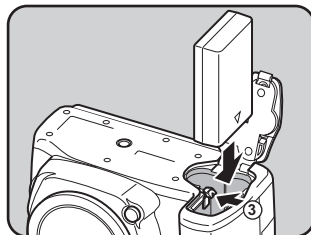

To remove the battery, push the battery lock lever in the direction of the arrow (③) with your finger. Remove the battery when it pops out slightly.

3 Close the battery cover.

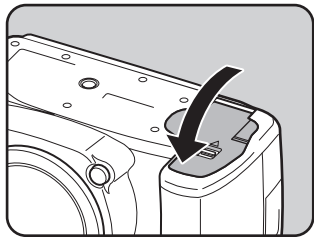

Using the AA Batteries

When using AA batteries, be sure to use the optional AA battery holder D-BH109. (p.320)

Use four AA lithium batteries, AA Ni-MH rechargeable batteries, or AA alkaline batteries.

Available Batteries	Characteristics
AA lithium batteries	Recommended when using the camera in cold climates.
AA Ni-MH rechargeable batteries	These are rechargeable and are economical. A commercially available battery charger that is compatible with the batteries is required.
AA alkaline batteries	These are easily obtainable when the batteries you are using run out but they may not support all the camera functions under certain conditions. We do not recommend using them except in emergencies or when checking the camera functionality.



- Do not use the Ni-Mn batteries as the batteries' voltage characteristics may cause a malfunction.
- AA lithium batteries and AA alkaline batteries that can be used in this camera are not rechargeable.
- Do not open the battery cover or remove the batteries while the power is on.
- Remove the batteries when you do not plan to use the camera for a long time. If you leave them in the camera for a long time, they may leak.
- If the date and time settings have been reset when you install new batteries after a long time has passed since the batteries were removed, follow the procedure for "Setting the Date and Time" (p.64).
- Insert the batteries correctly. Batteries inserted incorrectly may cause a camera breakdown. Wipe the electrodes of the batteries before inserting.
- Replace all the batteries at the same time and do not mix battery types, brands or old batteries with new ones. Otherwise, malfunctions, such as the battery level not being displayed properly, may occur.

- 1** Insert the AA batteries according to the +/- indicators in the battery holder.

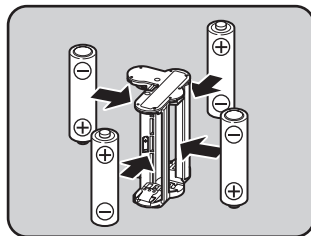

- 2** Slide the battery cover unlock lever in the direction of the arrow (1) to open the battery cover (2).

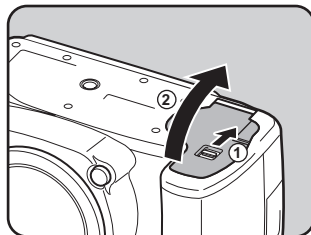

3 Insert the battery holder into the battery chamber.

Push the battery lock lever in the direction of the arrow (3) and insert the battery holder until it locks.

To remove the battery holder, push the battery lock lever in the direction of the arrow (3) with your finger. Remove the battery holder when it pops out slightly.

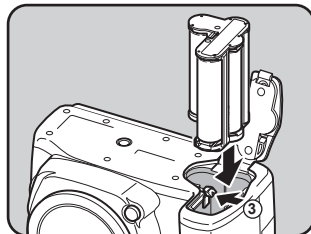



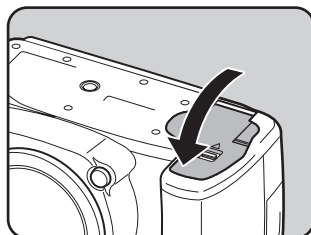



4 Close the battery cover.







- To use the AA batteries, set the AA battery type in [AA Battery Type] of the [Set-up 3] menu before use. (p.282)
- It is recommended to use the AC adapter kit K-AC109 (optional) when using the camera for a prolonged period. (p.50)
- Check the orientation of the batteries if the camera does not operate properly.

Battery Level Indicator

You can confirm remaining battery level by checking the  displayed on the status screen.

Status Screen	Battery Level
 (Green)	Battery is full.
 (Green)	Battery is close to full. (D-LI109 only)
 (Orange)	Battery is running low. (D-BH109 only)
 (Yellow)	Battery is running low. (D-LI109 only)
 (Red)	Battery is almost empty.
[Battery depleted]	The camera turns off after displaying the message.



,  or  (Red) may appear even when the battery level is sufficient if the camera is used at low temperatures or when performing continuous shooting for a long period of time. In this situation, turn the camera off and on again. If  (Green) appears, you can use the camera.

Approximate Image Storage Capacity and Playback Time (Fully Charged Battery/New AA Batteries)

Battery	Temperature	Normal Recording	Flash Photography		Playback Time
			50% Use	100% Use	
D-LI109	23°C	560 images	470 images	400 images	300 minutes
	0°C	420 images	340 images	280 images	240 minutes
AA lithium batteries	23°C	1600 images	1000 images	890 images	620 minutes
AA Ni-MH rechargeable batteries (1900mAh)	23°C	610 images	400 images	300 images	330 minutes
AA alkaline batteries	23°C	200 images	120 images	90 images	270 minutes

The image storage capacity (normal recording and flash use 50%) is based on measuring conditions in accordance with CIPA standards, while other data is based on our measuring conditions. Some deviation from the above figures may occur in actual use depending on shooting mode and shooting conditions.



- Battery performance temporarily decreases as the temperature decreases. When using the camera in cold climates, have extra batteries at hand and keep them warm in your pocket. Battery performance will return to normal when returned to room temperature.
- Have extra batteries ready when traveling overseas, taking pictures in cold climates, or taking a lot of pictures.

Using the AC Adapter (Optional)

We recommend the use of the AC adapter kit K-AC109 (optional) when using the monitor for a long time or when connecting the camera to a computer or AV device.

1 Make sure the camera is turned off.

2 Open the battery cover.

Refer to Step 1 on p.45.

Remove the battery if it is inserted into the camera.

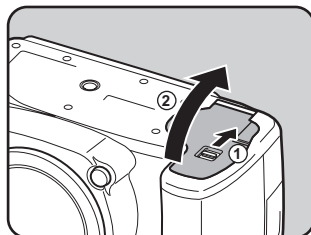

3 Insert the DC coupler into the battery chamber.

Push the battery lock lever in the direction of the arrow (1) and insert the DC coupler until it locks.

To remove the DC coupler, push the battery lock lever in the direction of the arrow (1) with your finger. Remove the DC coupler when it pops out slightly.

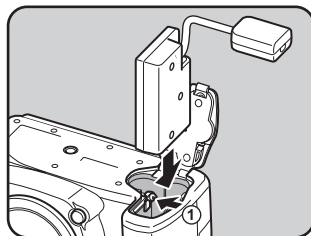

4 Close the battery cover.

The DC coupler's connection cable is pulled out from the battery cover.

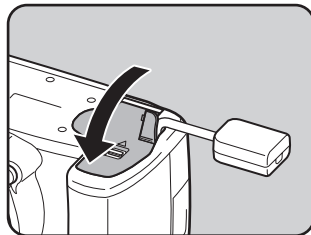

5 Connect the DC terminals on the AC adapter and the DC coupler with the ▲ marks aligned.

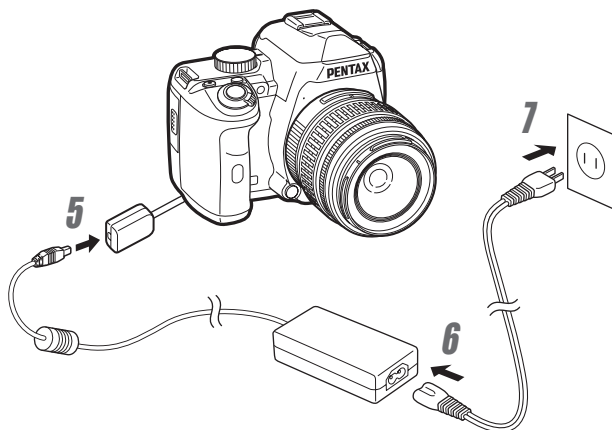

6 Connect the AC plug cord to the AC adapter.

7 Plug the AC cord into the power outlet.



- Make sure the camera is turned off before connecting or disconnecting the AC adapter.
- Make sure connections are secure between the terminals. SD Memory Card or data may be corrupted if disconnected while the card is being accessed.
- The connection cable will protrude from the battery cover while the AC adapter is in use. Be careful as you will not be able to set the camera upright on a table, etc.



Be sure to read the manual of the AC adapter kit K-AC109 when using the AC adapter.

Inserting/Removing an SD Memory Card

This camera uses either an SD Memory Card or an SDHC Memory Card (commercially available). Both cards are referred to as SD Memory Cards hereafter. Make sure the camera is turned off before inserting or removing the SD Memory Card.

2

Getting Started

Caution

- Do not remove the SD Memory Card while the card access lamp is lit.
- If the card cover is opened while the power is on, the camera will turn off. Do not open the cover while the camera is in use.
- Use this camera to format (initialize) an SD Memory Card that is unused or has been used on other cameras or digital devices. Refer to "Formatting an SD Memory Card" (p.268) for details on formatting.
- Use a high-speed memory card when recording movies. If a write speed cannot keep up with a recording speed, the writing may stop during recording.

1 Make sure that the camera is turned off.

2 Slide the card cover in the direction of the arrow and then lift it to open (①→②).

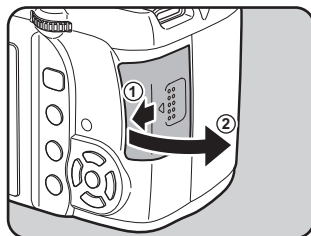

3 Insert the card all the way with the SD Memory Card label facing toward the monitor.

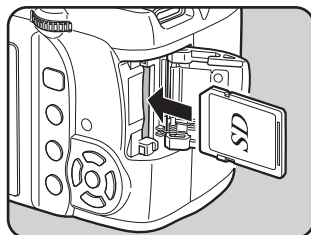

Push the SD Memory Card in once to remove.

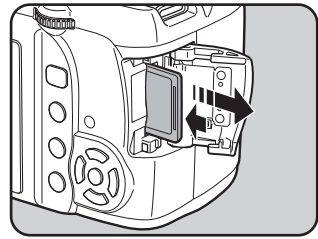

- 4** Close the card cover (③) and then slide it in the direction of the arrow (④).

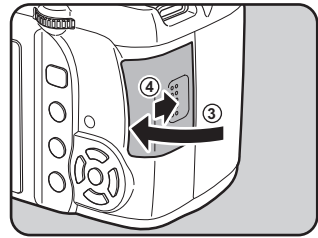

2

Precautions When Using the SD Memory Card

- The SD Memory Card is equipped with a write-protect switch. Setting the switch to LOCK prevents new data from being recorded on the card, the stored data from being deleted, and the card from being formatted by the camera or computer.
- The SD Memory Card may be hot when removing the card immediately after using the camera.
- Do not remove the SD Memory Card or turn off the power while the card is being accessed. This may cause the data to be lost or the card to be damaged.
- Do not bend the SD Memory Card or subject it to violent impact. Keep it away from water and store away from high temperatures.
- Do not remove the SD Memory Card while formatting. The card may be damaged and become unusable.
- Data on the SD Memory Card may be deleted in the following circumstances. We do not accept any liability for data that is deleted if
 - (1) the SD Memory Card is mishandled by the user.
 - (2) the SD Memory Card is exposed to static electricity or electrical interference.
 - (3) the SD Memory Card has not been used for a long time.
 - (4) the SD Memory Card or the battery is removed while the card is being accessed.

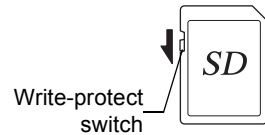

- If the SD Memory Card is not used for a long time, the data on the card may become unreadable. Be sure to regularly make a backup of important data on a computer.
- Avoid using or storing the card where it may be exposed to static electricity or electrical interference.
- Avoid using or storing the card in direct sunlight or in locations where it may be exposed to rapid changes in temperature or to condensation.
- Format new SD Memory Cards. Also format SD Memory Cards used with other cameras.
 - ☞ Formatting an SD Memory Card (p.268)
- The data on your SD Memory Card should be managed at your own risk.

Recorded Pixels and Quality Level

When the File Format is JPEG

Choose the number of recorded pixels (size) and quality level (JPEG data compression rate) of pictures according to how you intend to use the pictures you have taken.

Pictures with larger recorded pixels or more stars (★) are clearer when printed. However, the number of pictures that can be taken (the number of pictures that can be recorded on an SD Memory Card) decreases with larger file sizes.

The quality of the captured photo or printed picture depends on the quality level, exposure control, resolution of the printer and a variety of other factors so you do not need to select more than the required number of pixels. For example, to print in postcard size, **2M** (1728×1152) is adequate. Set the appropriate recorded pixels and quality level depending on how the picture will be used.

- ☞ Setting the JPEG Recorded Pixels (p.192)
- ☞ Setting the JPEG Quality Level (p.193)

● JPEG Recorded Pixels, JPEG Quality and Approximate Image Storage Capacity

(When using a 2 GB SD Memory Card)

JPEG Quality JPEG Rec. Pixels	★★★ Best	★★ Better	★ Good
12M (4288×2848)	281	495	975
10M (3936×2624)	332	585	1138
6M (3072×2048)	543	945	1807
2M (1728×1152)	1617	2793	5121

- The number of storable images may vary depending on the subject, shooting conditions, shooting mode and SD Memory Card, etc.



When the number of storable images exceeds 500, captured images are divided into folders containing 500 images each. However, in Exposure Bracketing, images will be stored in the same folder until shooting is completed, even if the number of images exceeds 500.

When the File Format is RAW

With the **K-r**, you can record in the versatile JPEG format or the high quality and editable RAW format. For RAW file format, you can select PENTAX's original PEF format or general-purpose DNG (Digital Negative) format designed by Adobe Systems. On a 2 GB SD Memory Card, you can record up to 98 images in both PEF and DNG formats.

- ☛ Setting the File Format (p.195)

Attach a proper lens to the camera's body.

When you use one of the following lenses with the **K-r**, all the camera's capture modes will be available.

- (a) DA, DA L, D FA, FA J lenses
- (b) Lenses with an **A** (Auto) position, when used in the **A** position



Turn the camera off before attaching or removing the lens to prevent unexpected lens movement.



- When lenses described in (b) are used in a position other than **A**, some functions will be restricted. Refer to "Notes on [22. Using Aperture Ring]" (p.314).
- With factory default settings, the camera will not work with lenses other than those listed above and accessories. Set [22. Using Aperture Ring] to [Permitted] in the [C Custom Setting 4] menu to use them. (p.314)

1 Check that the camera is turned off.

2 Remove the body mount cover (①) and lens mount cover (②).

Be sure to put the lens down with the lens mount side facing upward to protect the lens mount from damage.

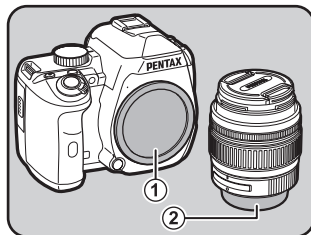

3 Align the Lens mount index (red dots: ③) on the camera and the lens, and secure by turning the lens clockwise until it clicks.

After attaching, turn the lens counterclockwise to check that the lens is locked in place.

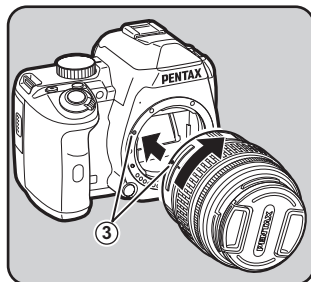

- 4** Remove the front lens cap by pushing the indicated portions inward.

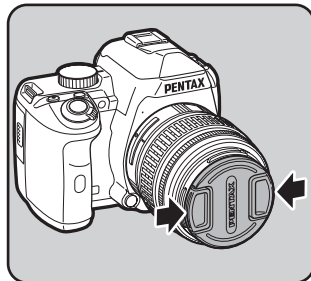

To detach the lens, hold down the lens unlock button (④) and turn the lens counterclockwise.

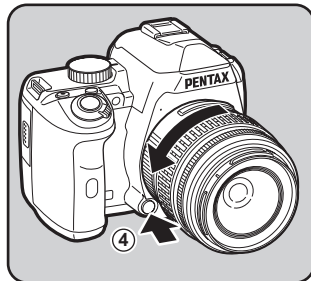

- We assume no responsibility nor liability for accidents, damages and malfunctions resulting from the use of lenses made by other manufacturers.
- The camera body and lens mount incorporate lens information contacts and an AF coupler. Dirt, dust, or corrosion may damage the electrical system. When necessary, clean the contacts with a soft dry cloth.



The body mount cover (①) is a cover to prevent scratches and block dust when shipped. Body Mount Cap K is sold separately and has a lock function.

Adjust the viewfinder diopter to suit your eyesight.

If it is difficult to see the viewfinder image clearly, slide the diopter adjustment lever sideways.

You can adjust the diopter from approximately -2.5 to $+1.5$ m⁻¹.

2

Getting Started

1 Look through the viewfinder and slide the diopter adjustment lever left or right.

Adjust the lever until the AF frame in the viewfinder is focused.

Point the camera at a white wall or other bright and consistent surface.

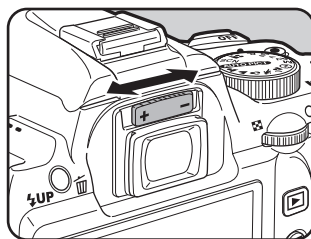

AF frame



- The Eyecup F₀ is attached to the viewfinder portion when the camera leaves the factory. Diopter can be adjusted with the Eyecup F₀ attached. However, adjustment is easier with the eyecup removed.
- To remove the Eyecup F₀, pull it out in the direction of the arrow.
To attach the Eyecup F₀, align it with the groove on the viewfinder eyepiece and push it into the position.
- If it is difficult to see the viewfinder image clearly even if you use the diopter adjustment lever, use the optional diopter correction lens adapter M. However, the Eyecup F₀ must be removed to use this adapter. (p.323)

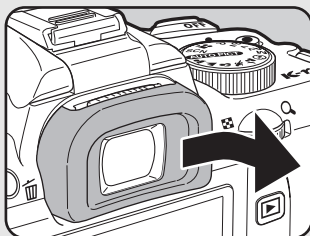



1 Turn the main switch to [ON].

The camera will turn on.

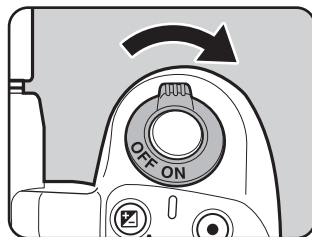
Set the main switch to the position [OFF] to turn off the camera.



- Always turn the camera off when not in use.
- The power will automatically turn off when you do not perform any operations within a set period of time. To reactivate the camera, turn it on again or perform any of the following.
 - Press the shutter release button halfway.
 - Press the  button, **MENU** button, or **INFO** button.
- By default, the camera is set to turn off automatically after 1 minute of inactivity. You can change the setting in [Auto Power Off] of the [ Set-up 3] menu. (p.281)

The first time the camera is turned on after purchasing, the [Language/言語] screen appears on the monitor. Follow the procedure below to set the language displayed on the monitor and the current date and time. Once these settings are made, you will not need to set them again next time you turn on your camera.

If the [Date Adjustment] screen appears, set the date and time by following the procedure in “Setting the Date and Time” (p.64).

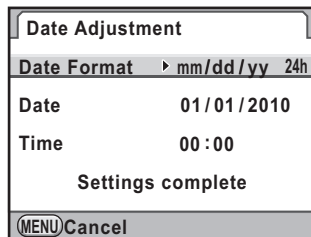

Setting the Display Language

You can choose the language in which the menus, error messages, etc. are displayed from the following: English, French, German, Spanish, Portuguese, Italian, Dutch, Danish, Swedish, Finnish, Polish, Czech, Hungarian, Turkish, Greek, Russian, Korean, Traditional Chinese, Simplified Chinese and Japanese.

- 1 Use the four-way controller (▲▼◀▶) to select the desired language.



2 Press the OK button.

The [Initial Setting] screen appears in the selected language.

Press the four-way controller (▼) twice and proceed to Step 10 on p.62 if

🏠 (Hometown) does not have to be changed.

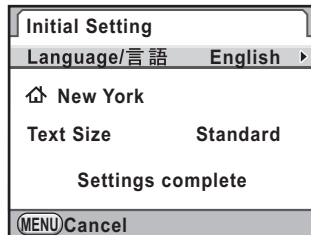

3 Press the four-way controller (▼).

The cursor moves to 🏠.

4 Press the four-way controller (▶).

The [🏠 Hometown] screen appears.

5 Use the four-way controller (◀▶) to select a city.

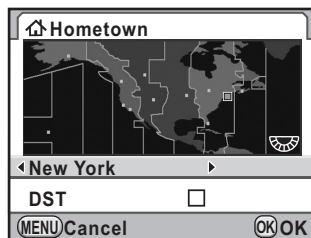

6 Press the four-way controller (▼).

The cursor moves to [DST] (daylight saving time).

7 Use the four-way controller (◀▶) to select or .

8 Press the OK button.

The camera returns to the [Initial Setting] screen.

9 Press the four-way controller (▼).

The cursor moves to [Text Size].

- 10** Press the four-way controller (▶) and use the four-way controller (▲▼) to select [Standard] or [Large].

Selecting [Large] increases the text size of the selected menu items.



- 11** Press the OK button.

- 12** Press the four-way controller (▼) to select [Settings complete].



- 13** Press the OK button.

The [Date Adjustment] screen appears.



In this manual, the menu screens hereafter are described with [Text Size] set to [Standard].

When the Wrong Language is Set

If you mistakenly select the wrong language in the [Language/言語] screen and proceed to the [Date Adjustment] screen, you can perform the following operation to set the language back.

If you have proceeded to switch the camera to Capture mode (and the camera is ready to take a picture), perform the following operation from Step 2 to set the language back.

1 Press the MENU button once to display the guides on the monitor.

The screen shown on the right is an example of the guides displayed. The displayed screen will vary depending on the selected language.

The guides appear on the monitor for 3 seconds.

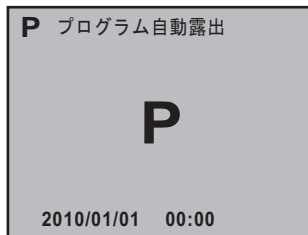

2 Press the MENU button once.

[CAM 1] is displayed in the upper tab.

SCN is displayed when the mode dial is set to SCN.

3 Press the four-way controller (▶) five times.

[CAM 1] is displayed in the upper tab.

Press the four-way controller (▶) six times when the mode dial is set to SCN.

4 Press the four-way controller (▼) to select [Language/言語].

5 Press the four-way controller (▶).

The [Language/言語] screen appears.

6 Use the four-way controller (▲▼◀▶) to select the desired language and press the OK button.

The [CAM Set-up 1] menu in the selected language appears.

Refer to the following pages and set the desired city for [Hometown] and the current date and time as necessary.

- To change the hometown: "Setting the World Time" (p.270)
- To change the date and time: "Changing the Date and Time Display" (p.270)



- When the hometown and the date and time are not set, the [Initial Setting] screen or [Date Adjustment] screen will be displayed again next time the camera is turned on.
- If you have not proceeded to the [Date Adjustment] screen, you can reselect a language using the four-way controller (▶) in the [Language/言語] screen.

Setting the Date and Time

Set the current date and time and the display style.

1 Press the four-way controller (▶).

The frame moves to [mm/dd/yy].

2 Use the four-way controller (▲▼) to choose the date format.

Choose [mm/dd/yy], [dd/mm/yy] or [yy/mm/dd].

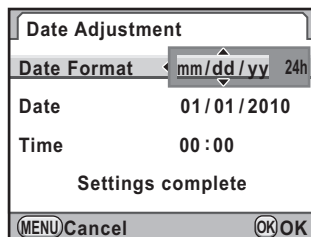

3 Press the four-way controller (▶).

The frame moves to [24h].

4 Use the four-way controller (▲▼) to select 24h (24-hour display) or 12h (12-hour display).

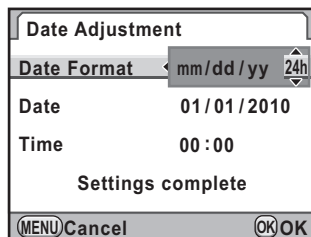

5 Press the four-way controller (▶).

The frame returns to [Date Format].

6 Press the four-way controller (▼).

The frame moves to [Date].

7 Press the four-way controller (▶).

The frame moves to the month.

8 Use the four-way controller (▲▼) to set the month.

Set the day and year in the same manner. Next, set the time.

If you select [12h] in Step 4, the camera switches between am and pm depending on the time.

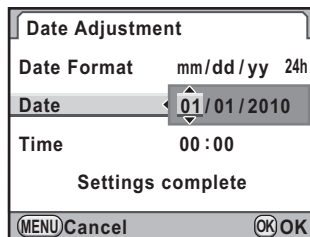

9 Press the four-way controller (▼) to select [Settings complete].

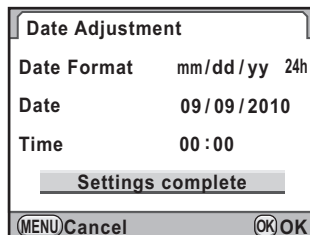

10 Press the OK button.

The camera returns to the status screen and is ready to take a picture.

If you set the date and time from the menu, the screen will return to the [Set-up 1] menu. In this case, press the **MENU** button.



Pressing the **MENU** button while setting the date and time cancels the settings made up to that point and switches the camera to Capture mode. After initial settings are complete, if the camera power is turned off before the date and time settings are complete, the [Date Adjustment] screen will appear first next time you turn the camera on. In this case, you can also set the date and time from the menu later. (p.270)



- When you press the **OK** button in Step 10, the seconds value is set to 0. To set the exact time, press the **OK** button when the time signal (on the TV, radio, etc.) reaches 0 seconds.
- You can change the language and date and time settings from the menu. (p.270, p.273)

Memo

3 Basic Operations

This chapter explains basic operations for shooting by setting mode dial to **AUTO PICT** (Auto Picture) to ensure successful capturing.

For information about advanced functions and settings for taking pictures, refer to chapter 4 and onward.

Basic Shooting Operation	68
Using a Zoom Lens	74
Using the Built-in Flash	75
Playing Back Pictures	82

Holding the Camera

How you hold the camera is important when taking pictures.

- Hold the camera firmly with both hands and keep your elbows close to your body.
- Press the shutter release button gently when taking a picture.

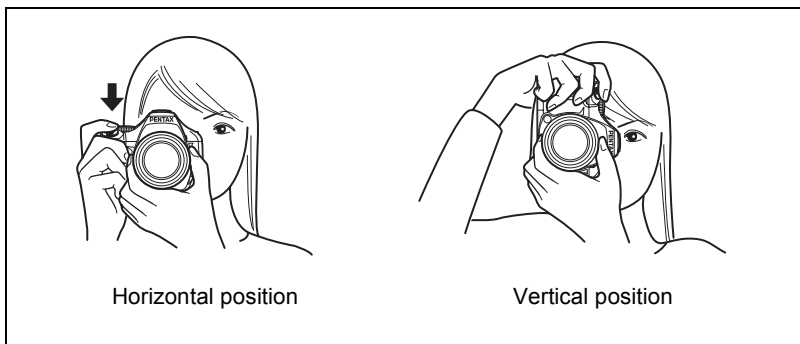

Horizontal position

Vertical position

3

Basic Operations



- To reduce camera shake, support your body or the camera on a solid object such as a table, tree, or wall.
- Although there are individual differences among photographers, the slowest possible shutter speed for a handheld camera is generally $1/(\text{focal length} \times 1.5)$. For example, it is $1/75$ of a second for a focal length of 50 mm and $1/150$ of a second for 100 mm. Use a tripod or the Shake Reduction function (p.141) when using a slower shutter speed.
- When using a telephoto lens, a tripod that is heavier than the total weight of the camera and lens is recommended to avoid camera shake.
- Do not use the Shake Reduction function when using the camera on a tripod. (p.142)

Letting the Camera Choose the Optimal Settings

The **K-r** features various capture modes, focus modes, and drive modes for expressing your photographic vision. This section explains how to take pictures by simply pressing the shutter release button.

1 Set the mode dial to **AUTO PICT**.

The camera will select the optimal capture mode for the subject.

☞ Selecting the Appropriate Capture Mode (p.91)

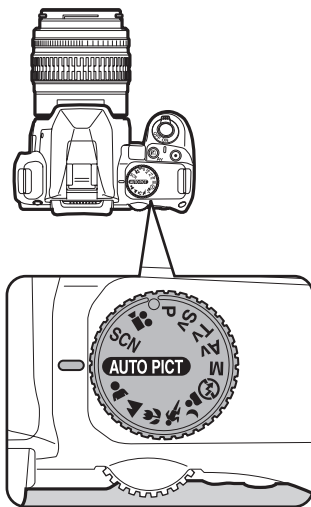

2 Set the focus mode lever to **AF**.

The focus mode changes to **AF** (Autofocus) mode.

When the shutter release button is pressed halfway in **AF**, the camera focuses automatically. (p.122)

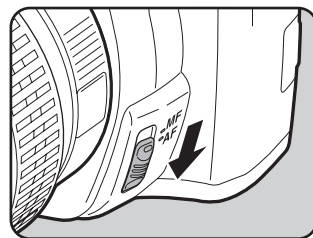





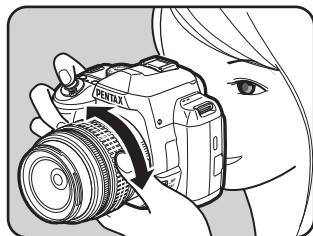

3 Look through the viewfinder to view the subject.

A zoom lens can be used to change the size of the subject in the viewfinder. (p.74)







4 Position the subject inside the AF frame and press the shutter release button halfway.

The autofocus system operates. The focus indicator  appears in the viewfinder when the subject comes into focus.

When set to **AUTO PICT** (Auto Picture) mode, the optimal capture mode is automatically selected from , , , ,  (Moving Object) or  (Night Scene Portrait).

The built-in flash pops up automatically when necessary.

-  Operating the shutter release button (p.72)
-  Subjects that are difficult to focus on (p.73)
-  Using the Built-in Flash (p.75)
-  Selecting the Focusing Area (AF Point) (p.129)

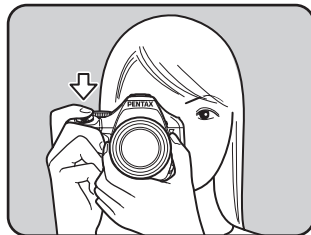

Flash status

Focus indicator

5 Press the shutter release button fully.

The picture is taken.

This action is referred to as "releasing the shutter" or "release".

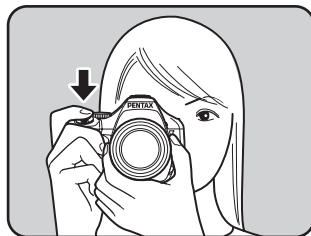

6 Review the captured image on the monitor.

The image appears for 1 second on the monitor shortly after capturing (Instant Review).

- ☞ Setting the Display for Instant Review (p.276)

You can magnify the image during Instant Review with the e-dial. (p.223)

You can delete the image during Instant Review by pressing the **⚡UP** / **🗑️** button.

- ☞ Deleting a Single Image (p.84)

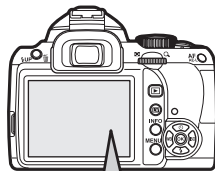

- You can set the camera so that pressing the **AF/AE-L** button will focus automatically, in the same way as pressing the shutter release button halfway. (p.123)
- You can preview the image in the viewfinder or on the monitor and check the composition, exposure, and focus before taking pictures. (p.137)

Operating the shutter release button

The shutter release button has two working positions.

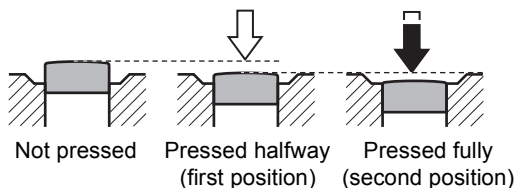

Pressing it down halfway (first position) displays the indicators in the viewfinder and the autofocus system operates. Pressing it fully (second position) takes a picture.



- Press the shutter release button gently when taking a picture to prevent camera shake.
- Practice pressing the shutter release button halfway/fully to learn where the first position and second position are.
- The viewfinder indicators are displayed while the shutter release button is pressed halfway. The indicators are displayed for about 10 seconds (default setting) while the exposure metering timer is on after you take your finger off the button. (p.32, p.116)

Subjects that are difficult to focus on

The autofocus mechanism is not perfect. Focusing may be difficult when taking pictures under the following conditions. These also apply to manual focusing using the focus indicator  in the viewfinder.

- (a) Extremely low-contrast subjects such as a white wall in the focusing area
- (b) Subjects which do not reflect much light within the focusing area
- (c) Fast moving objects
- (d) Strongly reflected light or strong backlighting (bright background)
- (e) If repeating vertical or horizontal line patterns appear within the focusing area
- (f) Multiple subjects in the foreground and background within the focusing area

If the subject cannot be focused automatically, set the focus mode lever to **MF** and use the manual focus mode to focus on the subject with the aid of the matte field in the viewfinder. (p.135)



The subject may not be focused even when the  (focus indicator) is displayed when (e) and (f) above apply.

Enlarge the subject (telephoto) or capture a wider area (wide angle) with a zoom lens. Adjust the subject to the desired size and take pictures.

1 Turn the zoom ring to the right or left.

Turn the zoom ring clockwise for telephoto and counterclockwise for wide angle.

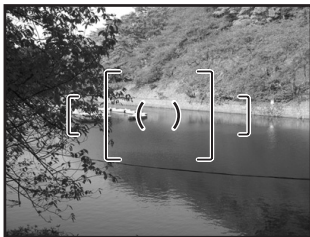
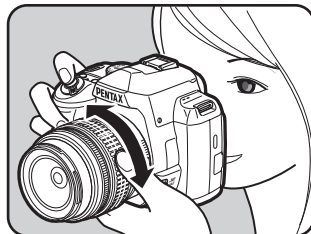

Wide Angle

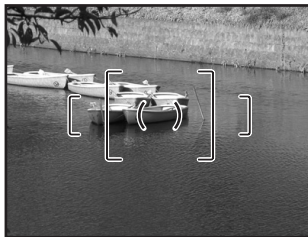

Telephoto



- The smaller the number displayed for the focal length, the wider the angle. The larger the number, the more magnified the image appears.
- Power Zoom functions (Image Size Tracking, Zoom Clip, and Auto Zoom Effect) are not compatible with this camera.

Use the following procedures to take pictures in low light or backlit conditions and when you want to use the built-in flash.

The built-in flash is optimum for a subject at a distance from 0.7 m to 5 m. Exposure will not be properly controlled and vignetting (darkening of the corners of the image due to a lack of light) may occur when used at a distance closer than 0.7 m (this distance varies slightly depending on the lens being used and the set sensitivity (p.178)).

Compatibility of built-in flash and lens

Vignetting may occur depending on the lens being used and the capture conditions. We recommend taking a test shot to check the compatibility.

 Lens Compatibility with the Built-in Flash (p.179)













- When using the built-in flash, remove the lens hood before shooting.
- The built-in flash fully discharges for lenses without a function to set the lens aperture ring to **A** (Auto).

























For details on the built-in flash and instructions on how to take pictures with an external flash, refer to the “Using the Flash” (p.173).





Setting the Flash Mode

Flash Mode	Function
 Auto Flash Discharge	The camera automatically measures the ambient light and determines whether to use the flash. The flash pops up and discharges automatically when necessary, such as when using a shutter speed which is likely to cause camera shake or in backlit conditions (except when in  (Landscape),  (Moving Object) or  (Night Snap) in SCN (Scene) mode). The flash may pop up but may not discharge if the camera determines that the flash is not necessary.
 Manual Flash Discharge	Discharges the flash manually. Discharges when the flash is popped up, does not discharge when retracted.
 Auto Flash+Red-eye Reduction	Discharges a pre-flash for red-eye reduction before the automatic flash.

Flash Mode	Function
 Manual Flash+ Red-eye Reduction	Discharges the flash manually. A pre-flash for red-eye reduction is discharged before the main flash.
 Slow-speed Sync	Sets to a slow shutter speed depending on the brightness. For example, when using this to shoot a portrait with the sunset in the background, both the person and the background are captured beautifully.
 Slow-speed Sync+ Red-eye	Discharges a pre-flash for red-eye reduction before the main flash is discharged with Slow-speed Sync.
 Trailing Curtain Sync	Discharges the flash immediately before closing the shutter curtain. Captures moving objects as if they are leaving a trail behind. (p.176)
 Wireless Mode	You can synchronize a dedicated external flash (AF540FGZ or AF360FGZ) without using a sync cord. (p.183)

The flash modes that can be selected differ depending on the capture mode.

Capture Mode	Selectable Flash Mode
AUTO PICT /  /  /  /  /  /  / SCN *1	 /  /  /  / 
P/Sv/Av	 /  /  /  /  /  / 
Tv/M	 /  /  /  / 

*1 This can be selected in  (Surf & Snow),  (Food),  (Night Snap),  (Kids), and  (Pet) of SCN mode.

1 Press the four-way controller (▼) in Capture mode.

The [Flash Mode] screen appears.

The flash modes that can be selected for the set capture mode appear.

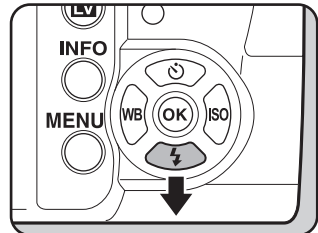

2 Use the four-way controller (◀▶) to select a flash mode.

Turn the e-dial to perform the flash exposure compensation. (p.81)

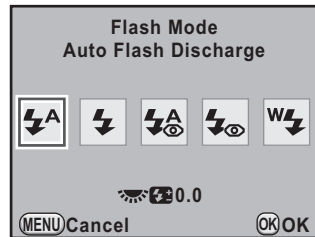

3 Press the OK button.

The camera is ready to take a picture.

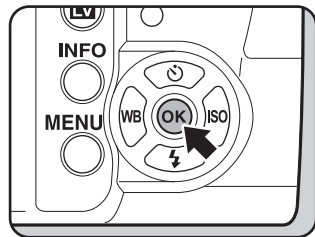

3

Basic Operations

Using Auto Flash Discharge Mode ⚡^A , ⚡^A (Automatic Flash Pop-up)

1 Set the mode dial to **AUTO PICT**, **👤**, **🌸**, **👤** or **SCN**.

The flash is deactivated when **🌃** (Night Scene), **🌅** (Sunset), **🎭** (Stage Lighting), **🌃** (Night Scene HDR), **🕯** (Candlelight), or **🏛** (Museum) is selected in **SCN** (Scene) mode. The built-in flash does not pop up when set to **👤** (Night Snap) in **SCN** (Scene) mode.

2 Press the shutter release button halfway.

The built-in flash pops up if necessary and begins charging. When the flash is fully charged, **⚡** appears in the viewfinder. (p.32)

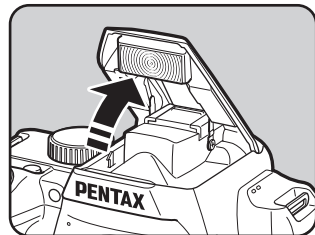

3 Press the shutter release button fully.

The picture is taken.

- 4** Push down on the portion indicated in the illustration to retract the built-in flash.

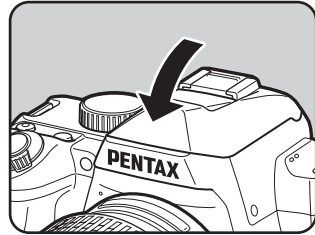

Switch between ⚡^A (Auto Flash Discharge) and ⚡ (Manual Flash Discharge) by pressing the ⚡UP / 🗑 button while the built-in flash is popped up.

Using Manual Flash Discharge Mode ⚡ , ⚡°

- 1** Press the ⚡UP / 🗑 button.

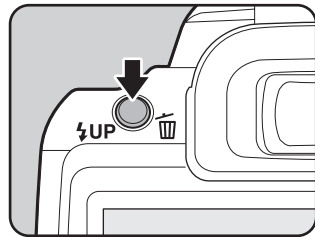

The built-in flash pops up and begins charging. The ⚡ mode is used regardless of the flash mode setting. When the flash is fully charged, ⚡ appears in the viewfinder. (p.32)

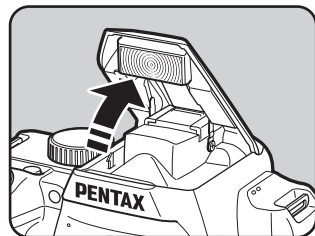

- 2** Press the shutter release button fully.

The flash discharges and the picture is taken.

- 3** Push the built-in flash down to retract.



When the mode dial is set to (Flash Off), the built-in flash will not pop up even if the button is pressed.

Using red-eye reduction flash

“Red-eye” is the phenomenon where eyes look reddish in photographs taken in dark environments with a flash. This is caused by the reflection of the electronic flash in the retina of the eye. Red-eye occurs because pupils are dilated in dark environments. This phenomenon cannot be averted but the following measures can be used to combat it.

- Brighten the surroundings when shooting.
- Set to wide angle and move closer to the subject if a zoom lens is in use.
- Use a flash that supports red-eye reduction.
- Position the flash as far away from the camera as possible when using an external flash.

The red-eye reduction function on this camera reduces a red-eye effect by discharging the flash twice. With the red-eye reduction function, the pre-flash is discharged just before the shutter is released. This reduces pupil dilation. The main flash is then discharged while the pupils are smaller, reducing the red-eye effect. To use the red-eye reduction function in Picture mode or **SCN** (Scene) mode, select or . Set to or in other modes.

Daylight-Sync Shooting

In daylight conditions, the flash will eliminate shadows when a portrait picture is taken with a shadow cast on a person's face. Use of the flash in this way is called Daylight-Sync Shooting. The ⚡ (Manual Flash Discharge) mode is used when shooting with Daylight-Sync Shooting.

● Taking pictures

- 1 Pop up the built-in flash manually and confirm that the flash mode is set to ⚡. (p.78)
- 2 Confirm that the flash is fully charged.
- 3 Take a picture.



Without Daylight-Sync



With Daylight-Sync



The picture may be overexposed if the background is too bright.

Compensating Flash Output

You can change the flash output in a range of -2.0 to $+1.0$. The following flash compensation values can be set according to the step interval set in [1. EV Steps] (p.118) of the [C Custom Setting 1] menu.

Step Interval	Flash Compensation Value
1/3 EV	$-2.0, -1.7, -1.3, -1.0, -0.7, -0.3, 0.0, +0.3, +0.7, +1.0$
1/2 EV	$-2.0, -1.5, -1.0, -0.5, 0.0, +0.5, +1.0$

1 Turn the e-dial in the [Flash Mode] screen.

The flash compensation value is displayed. Press the \odot button to reset the flash output compensation value to 0.0. (Available only when [Green Button] is assigned to the \odot button in [Green Button] of the [Rec. Mode 4] menu) (p.197.)

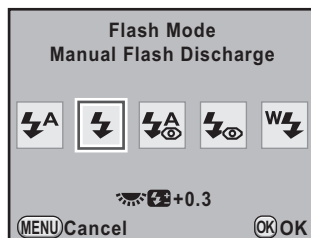

- When the flash output exceeds its maximum amount, the compensation will not be effective even if the compensation value is set to the plus (+) side.
- Compensating to the minus (–) side may not affect the image if the subject is too close, the aperture value is small or sensitivity is high.
- The flash output compensation is also effective for external flash units which support P-TTL auto flash mode.

Enabling Shooting while Charging the Flash

You can set the camera to enable shooting while the flash is being charged.

Set [16. Release While Charging] to [On] in the [C Custom Setting 3] menu (p.90).

By default, pictures cannot be taken while the built-in flash is charging.

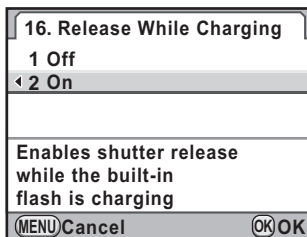

Playing Back Images

You can play back captured images with the camera.



Use the provided "PENTAX Digital Camera Utility 4" software to play back pictures using a computer. Refer to "Using the Provided Software" (p.296) for details on the software.

3

1 Press the button.

The camera enters Playback mode and the most recently captured image (image with the highest file number) is displayed on the monitor. (For movies, only the first frame is displayed on the monitor.)

Press the **INFO** button during playback to switch the information display such as shooting information for the displayed image.

Refer to p.27 for details about display information.

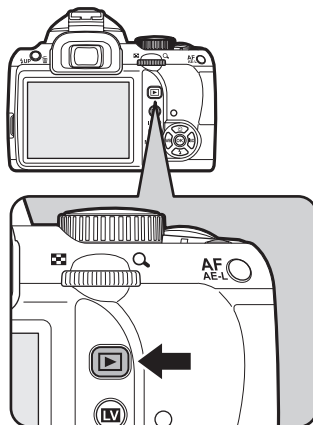

2 Press the four-way controller ().

- ◀: Displays the previous image.
- ▶: Displays the next image.

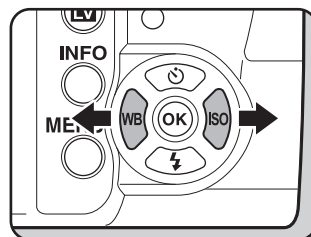



- Refer to “Playback Functions” (p.219) for details on the playback mode functions.
- When the file format of the last captured image is JPEG, and its data still remains in the buffer memory, you can additionally save the image in RAW format by pressing the  **Av** button.

If the image was shot using any of the following settings, the corresponding RAW image listed is saved.

- Multi-exposure RAW image with Multi-exposure
- Digital Filter RAW image without filter effect
- HDR Capture RAW image with standard exposure
- Cross Processing RAW image without Cross Processing

Deleting a Single Image

You can delete images one by one.



- Deleted images cannot be restored.
- Protected images cannot be deleted. (p.240)

1 Press the button and use the four-way controller (◀▶) to select an image to delete.

2 Press the button.

The delete confirmation screen appears.

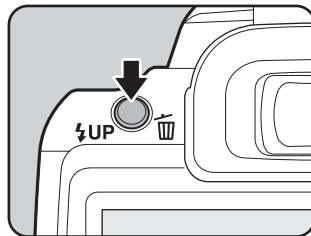

3 Use the four-way controller (▲▼) to select [Delete].

Select a file format to delete for images saved in RAW+ format.

Delete JPEG	Deletes only the JPEG image.
Delete RAW	Deletes only the RAW image.
Delete RAW+JPEG	Deletes images in both file formats.

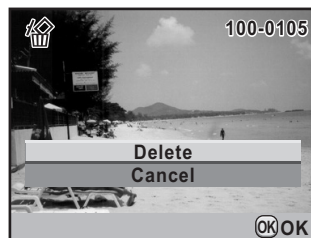

4 Press the **OK** button.

The image is deleted.



When deleting multiple images at once, refer to “Deleting Multiple Images” (p.236)

4 Shooting Functions

This chapter describes the various basic and advanced shooting functions available with the *K-r*.

How to Operate the Shooting Functions	86
Selecting the Appropriate Capture Mode	91
Setting the Exposure	96
Focusing	122
Checking the Composition, Exposure and Focus Before Shooting (Preview)	137
Using the Shake Reduction Function to Prevent Camera Shake	141
Taking Pictures Continuously	149
Taking Pictures Using Digital Filters	155
Shooting with Live View	159
Recording Movies	165

How to Operate the Shooting Functions

You can change capture-related settings using the direct keys, control panel, [📷 Rec. Mode] menu or [C Custom Setting] menu.



For details on how to use the menus, refer to “Using the Menus” (p.37).

Direct Keys Setting Items

Press the four-way controller (▲▼◀▶) in Capture mode to set the following items.

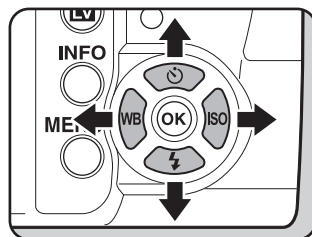



Key	Item	Function	Page
▲	Drive Mode	Selects Continuous shooting, Self-timer, Remote Control or Exposure Bracketing shooting.	p.149 p.145 p.147 p.118
▼	Flash Mode	Sets the method of flash discharge.	p.75
◀	White Balance	Adjusts the color balance to match the type of the light source illuminating the subject.	p.200
▶	Sensitivity	Sets the ISO sensitivity.	p.98

Rec. Mode Menu Setting Items

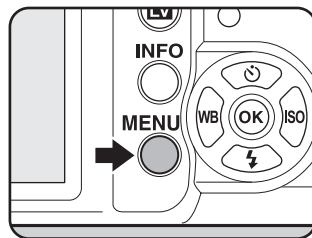
The following settings can be performed in the [📷 Rec. Mode 1-4] menus. Press the **MENU** button in Capture mode to display the [📷 Rec. Mode 1] menu.



Menu	Item	Function	Page
📷1	Custom Image *1	Sets the image finishing tone such as color and contrast before shooting an image.	p.213
	File Format *1	Sets the file format.	p.195
	JPEG Recorded Pixels *1	Sets the recording size of images saved in JPEG format.	p.192
	JPEG Quality *1	Sets the quality of images saved in JPEG format.	p.193
	AF Mode *1	Selects the autofocus mode.	p.125
	AE Metering *1	Selects the part of the viewfinder to use for measuring brightness and determining exposure.	p.114
	Select AF Point *1	Selects the part of the viewfinder to focus on.	p.129
📷2	Cross Processing *1	Changes the hues and contrast by performing digital cross processing.	p.216
	Digital Filter *1	Applies a digital filter effect when taking pictures.	p.155
	HDR Capture *1	Enables capturing images at high dynamic range.	p.209
	Multi-exposure	Creates a composite picture by taking multiple frames.	p.153
	Interval Shooting	Takes pictures at a set interval from a set time.	p.151
	High-ISO NR	Sets whether to use Noise Reduction when shooting with a high ISO sensitivity.	p.100
	Slow Shutter Speed NR	Sets whether to use Noise Reduction in slow speed shooting.	p.102

Menu	Item	Function	Page
 3	Movie	Sets the movie settings.	p.165
	Live View	Sets the Live View display settings.	p.160
	Instant Review	Sets the Instant Review display settings.	p.276
	D-Range Setting *1	Expands the dynamic range and prevents bright and dark areas from occurring.	p.207 p.208
	Lens Correction *1	Corrects distortions and chromatic aberrations of magnification occurring due to lens properties.	p.211
 4	Color Space	Sets the color space to use.	p.205
	RAW File Format	Sets the file format of images saved in RAW format.	p.196
	Green Button	Assigns the function to be called up when the  button is pressed.	p.197
	AF/AE-L Button	Assigns the function to be called up when the AF/AE-L button is pressed.	p.120 p.123
	Memory	Determines which settings to save when the power is turned off.	p.288
	Shake Reduction *1	Activates the Shake Reduction function.	p.142
	Input Focal Length	Sets the focal length when using a lens for which focal length information cannot be obtained.	p.143

*1 Can be set using the control panel.

Custom Setting Menu Setting Items

Set the [C Custom Setting 1-4] menus to fully use the functions of a SLR camera.

Menu	Item	Function	Page
C1	1. EV Steps	Sets the adjustment steps for exposure.	p.118
	2. Sensitivity Steps	Sets the adjustment steps for ISO sensitivity.	p.99
	3. Expanded Sensitivity	Expands the lower and upper sensitivity limits.	p.99
	4. Meter Operating Time	Sets the exposure metering time.	p.116
	5. AE-L with AF Locked	Sets whether to lock the exposure value when the focus is locked.	p.133
	6. Link AE to AF Point	Sets whether to link the exposure and AF point in the focusing area during multi-segment metering.	p.115
	7. Auto Bracketing Order	Sets the order for Exposure Bracketing shooting.	p.118
C2	8. Superimpose AF Area	Sets whether to display the selected AF point in the viewfinder.	p.130
	9. AF.S Setting	Sets the action priority for when AF mode is set to AF.S and the shutter release button is fully pressed.	p.125
	10. AF.C Setting	Sets the action priority for Continuous Shooting when AF mode is set to AF.C .	p.126
	11. AF Assist Light	Sets whether to use the AF assist light when autofocusing in dark locations.	p.127
	12. WB When Using Flash	Sets the white balance setting when using flash.	p.201
	13. AWB in Tungsten Light	Sets whether to adjust the tungsten light color tone when the white balance is set to AWB (Auto White Balance).	–
	14. AF with Remote Control	Sets whether to use autofocus when shooting with remote control.	p.148

Menu	Item	Function	Page
C3	15. Remote Control in Bulb	Sets the remote control operation while using the remote control with the shutter speed set to Bulb .	p.114
	16. Release While Charging	Sets whether to release shutter while the built-in flash is charging.	p.81
	17. Flash in Wireless Mode	Sets the built-in flash discharge method in the wireless mode.	p.184
	18. Saving Rotation Info	Sets whether to save rotation information when shooting.	p.235
	19. Save Menu Location	Sets whether to save the last menu tab displayed on the monitor and to display it again next time the MENU button is pressed.	p.275
	20. Catch-in Focus	When set to [On], if [AF Mode] is set to AF.A or AF.S and a manual focus lens is attached, catch-in focus shooting is enabled and the shutter is released automatically when the subject comes into focus.	p.136
	21. AF Fine Adjustment	Adjusts the AF focusing position.	p.128
C4	22. Using Aperture Ring	Sets whether to enable shutter release when the lens aperture ring is set to the position other than A .	p.314
	Reset Custom Functions	Resets all the settings in the [C Custom Setting 1-4] menus to the defaults.	p.311

Selecting the Appropriate Capture Mode

You can switch the capture modes by setting the icons on the mode dial to the dial indicator.

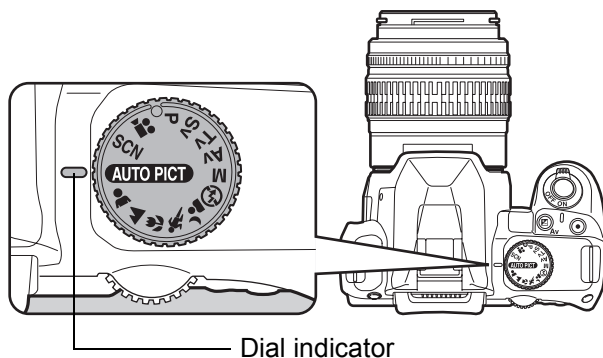

















The **K-1** features various shooting modes, enabling you to take pictures with settings suited for your photographic vision. In this manual, the capture modes are referred to as follows.

Capture Mode	Mode	Page
Picture modes	AUTO PICT (Auto Picture)/ (Portrait)/ (Landscape)/ (Macro)/ (Moving Object)/ (Night Scene Portrait)/ (Flash Off) (When shooting with Live View, (Blue Sky) and (Sunset) can also be selected in AUTO PICT mode.)	p.92
SCN (Scene) modes	(Night Scene)/ (Surf & Snow)/ (Food)/ (Sunset)/ (Stage Lighting)/ (Night Snap)/ (Night Scene HDR)/ (Kids)/ (Pet)/ (Candlelight)/ (Museum)	p.93
Exposure modes	P (Program)/ Sv (Sensitivity Priority)/ Tv (Shutter Priority)/ Av (Aperture Priority)/ M (Manual)	p.95
Movie mode	(Movie)	p.165



Picture Modes

Set the mode dial to , , , ,  or  if you cannot capture the desired image in **AUTO PICT** (Auto Picture) mode.

The characteristics of each mode are as follows.

Mode	Characteristics
AUTO PICT Auto Picture	The optimal capture mode is automatically selected from the  ,  ,  ,  ,  and  (Night Scene Portrait) modes. When shooting with Live View,  (Blue Sky) and  (Sunset) can also be selected.
 Portrait	Optimal for capturing portraits. Reproduces a healthy and bright skin tone.
 Landscape	Deepens the focus range, emphasizes contour and saturation of trees and the sky, and produces a vibrant image.
 Macro	Lets you take vibrant pictures of flowers and other small subjects at short distances.
 Moving Object	Lets you take sharp pictures of a quickly moving subject, such as at sporting events. The drive mode is fixed to  (Continuous Shooting (Hi)).
 Night Scene Portrait	Lets you capture people against a night view or at dusk.
 Flash Off	The flash is deactivated. Other settings are the same as  (Standard) in AUTO PICT .















In , even though the flash is used, the camera will use slow shutter speeds so the background areas beyond the flash's reach will also appear correctly exposed in the picture ( Slow-speed Sync (p.174)). To prevent camera shake, either use the Shake Reduction function or mount the camera on a tripod.









When  is automatically selected in **AUTO PICT**, pictures are taken in the drive mode set beforehand.

SCN Modes

By setting the mode dial to **SCN** (Scene), you can choose from the following 11 shooting scenes.

Mode	Characteristics
 Night Scene	Used for night scenes. Use a tripod, etc. to prevent shaking.
 Surf & Snow	For capturing images of dazzling backgrounds, such as snowy mountains.
 Food	For capturing images of food. Saturation will be rather high to make it look appetizing.
 Sunset	For capturing sunrise or sunset in beautiful colors.
 Stage Lighting	For capturing moving subjects in poorly lit place.
 Night Snap	For taking snapshots in poorly lit place.
 Night Scene HDR	Captures 3 images to generate a single HDR image. Exposure is optimized for dim lighting
 Kids	For capturing moving kids. Reproduces healthy and bright skin tone. The drive mode is fixed to  (Continuous Shooting (Hi)).
 Pet	For capturing moving pets. The drive mode is fixed to  (Continuous Shooting (Hi)).
 Candlelight	For capturing scenes in candlelight.
 Museum	For capturing images in places where a flash is prohibited.



The flash is deactivated in , , , ,  and . To prevent camera shake, either use the Shake Reduction function or mount the camera on a tripod.

Selecting a Shooting Scene

1 Set the mode dial to SCN.

The scene mode status screen appears.

2 Press the INFO button.

The icon for the currently selected shooting scene appears in the control panel.

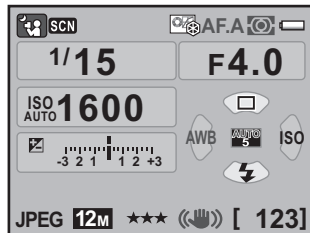

3 Use the four-way controller (▲▼◀▶) to select [Scene Mode] and press the OK button.

The scene mode selection screen appears.

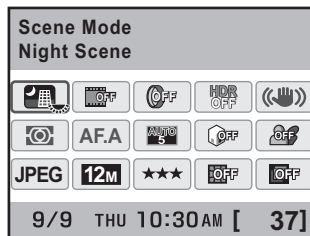

4 Use the four-way controller (▲▼◀▶) or e-dial to choose a scene mode.



5 Press the OK button.

The camera returns to the control panel and is ready to take a picture.



When the **MENU** button is pressed while the mode dial is set to **SCN** (Scene), the [**SCN** Scene] menu appears. Press the four-way controller (▼) to display the scene mode selection screen and you can select a scene in the same way as described in Step 4.

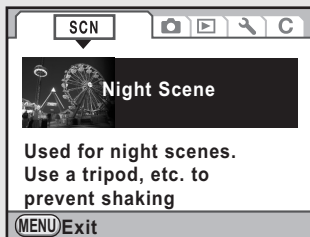

Exposure Modes

Use the exposure modes to change the sensitivity, shutter speed and aperture and take pictures according to your own photographic vision.

Mode	Characteristics	Page
P Program	Automatically sets the shutter speed and aperture value to obtain a proper exposure according to Program line when taking pictures.	p.103
Sv Sensitivity Priority	Automatically sets the shutter speed and aperture value to obtain a proper exposure according to the set sensitivity.	
Tv Shutter Priority	Lets you set the desired shutter speed to freeze or emphasize subject movement. Take pictures of fast moving subjects that look still or subjects that give a sense of movement.	
Av Aperture Priority	Lets you set the desired aperture value for controlling the depth of field. Use it to obtain a blurred or sharp background.	
M Manual	Lets you set the shutter speed and aperture value to capture the picture with creative intent.	

Effect of Aperture and Shutter Speed

Correct exposure of the subject is determined by a combination of shutter speed and aperture setting. There are many correct combinations of shutter speed and aperture value for a particular subject. Different combinations produce different effects.

Effect of Shutter Speed

4

Shooting Functions

By changing the shutter speed, you can manipulate how time is expressed in the pictures you create. Unlike with your own naked eyes, in a picture you can capture a fraction of a moment or a whole period of time, creating different effects.

Use the **Tv** (Shutter Priority) mode.

● Using slower shutter speed

If the subject is moving, the image will be blurred because the shutter is open longer. It is possible to enhance the effect of motion (rivers, waterfalls, waves, etc.) by intentionally using a slower shutter speed.

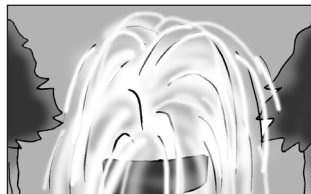

● Using faster shutter speed

Choosing a faster shutter speed will allow freezing the action of a moving subject. A faster shutter speed also helps to prevent camera shake.

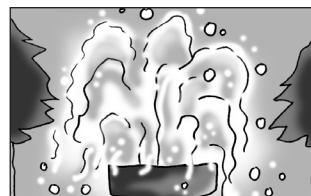

Effect of Aperture

By changing the aperture, you can control the depth of the area that appears in focus in the picture (the depth of field). By either narrowing the focus to emphasize a single point or giving depth to your picture instead you can completely change the feel of the picture you create.

Use the **Av** (Aperture Priority) mode.

● Opening the aperture (reduce the aperture value)

Objects closer and farther than the focused subject will be more out of focus. For instance, if you take a picture of a flower against a landscape with the aperture open, the landscape in front and behind the flower will be blurred, emphasizing only the flower.

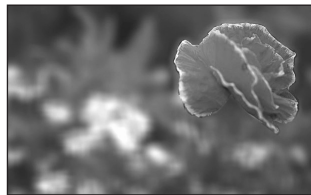

● Closing the aperture (increase the aperture value)

The range in focus expands forward and backward. For instance, if you take a picture of a flower against a landscape with the aperture narrowed, the landscape in front and behind the flower will be in focus.



Aperture and Depth of Field

The following table summarizes how the aperture affects the depth of field.

The depth of field may also change depending on the lens used and the distance to the subject.

Aperture	Open (Smaller value)	↔	Close (Larger value)
Depth of field	Shallow	↔	Deep
Area of focus	Narrow	↔	Wide
Lens focal length	Longer (Telephoto)	↔	Shorter (Wide-angle)
Distance to the subject	Near	↔	Far

- The depth of field for the *K-r* differs depending on the lens but compared to a 35 mm camera, the value is roughly one aperture setting lower (the focused range becomes narrower).
- The wider the wide-angle lens, and the farther away the subject, the deeper the depth of field is (some zoom lenses do not have a scale for depth of field because of their designs).

Setting the Sensitivity

You can set the sensitivity to suit the brightness of the surroundings. The sensitivity can be set to [AUTO] or within a sensitivity range equivalent to ISO 200 to 12800. The default setting is [AUTO].

1 Press the four-way controller (▶) in Capture mode.

The [Sensitivity] screen appears.

2 Use the four-way controller (▲▼) to select [AUTO Setting] or [Fixed Value].

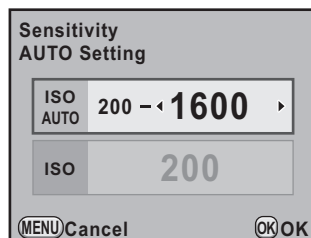

3 Use the four-way controller (◀▶) to change the ISO sensitivity.

For [AUTO Setting], change the maximum sensitivity.

4 Press the OK button.

The camera is ready to take a picture.



- When the capture mode is set to (Stage Lighting), (Night Snap) or (Night Scene HDR) of **SCN** (Scene) mode, or when the mode dial is set to (Movie), the sensitivity is fixed to AUTO and cannot be changed.
- When the capture mode is set to **Sv** (Sensitivity Priority) or **M** (Manual), [AUTO Setting] is not displayed.
- The sensitivity range can be expanded to a range of ISO 100 to 25600 when [3. Expanded Sensitivity] in the [**C** Custom Setting 1] menu (p.89) is set to [On]. However, the minimum sensitivity is ISO 200 when [Highlight Correction] (p.207) is set to [On].
- Captured images may show more noise if a higher sensitivity is set. You can reduce image noise by setting [High-ISO NR] in the [Rec. Mode 2] menu. (p.100)
- You can select whether to set the sensitivity in increments of 1 EV or in accordance with the EV step setting for exposure (p.118). This can be set in [2. Sensitivity Steps] of the [**C** Custom Setting 1] menu (p.89).

Expanding the Dynamic Range

Dynamic range is the ratio that indicates the light level expressed by the CMOS sensor pixels from bright areas to dark areas. The larger it is, the better the whole range from dark to bright areas will appear in the picture.

By expanding the dynamic range, you can expand the light level expressed by the CMOS sensor pixels, making it more difficult for bright area to occur in the image.

To expand the dynamic range, make the settings in [D-Range Setting] of the [Rec. Mode 3] menu. (p.207)

Reducing the Image Noise (Noise Reduction)

When shooting with a digital camera, image noise (image roughness or unevenness) becomes noticeable in the following situations.

- when shooting with a long exposure
- when shooting with a high sensitivity setting
- when the temperature of the CMOS sensor is high

You can reduce image noise by using Noise Reduction. However, images shot with Noise Reduction will take longer to save.

High-ISO NR

Reduces noise at high sensitivity (ISO) settings.

1 Select **[High-ISO NR]** in the **[Rec. Mode 2]** menu and press the four-way controller (▶).

The **[High-ISO NR]** screen appears.

2 Press the four-way controller (▶) and use the four-way controller (▲▼) to select **[Auto]**, **[Off]**, **[Low]**, **[Medium]**, **[High]** or **[Custom]**.

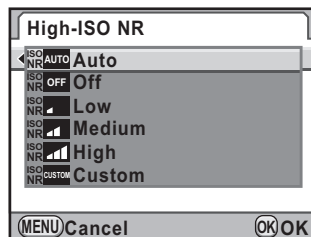

Auto	Applies Noise Reduction at optimally calculated levels throughout ISO range. (default setting)
Off	Does not apply Noise Reduction at any ISO setting.
Low/Medium/High	Applies Noise Reduction at constant chosen level throughout ISO range.
Custom	Applies Noise Reduction at user-defined levels for each ISO setting.

3 Press the **OK** button.

If you select **[Auto]**, **[Off]**, **[Low]**, **[Medium]** or **[High]**, proceed to Step 7.

- 4 Use the four-way controller (▲▼) to select [Setting] and press the four-way controller (▶).**

The screen to set the noise reduction level according to the sensitivity appears.

- 5 Use the four-way controller (▲▼) to select a sensitivity value and use the four-way controller (◀▶) to set the level of noise reduction which is applied to the selected sensitivity.**

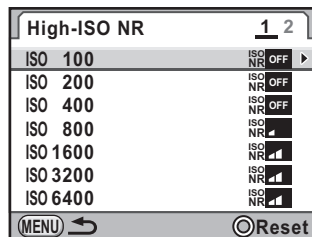

Turn the e-dial to display the [High-ISO NR 2] screen.

Press the  button to reset the settings.

The sensitivity values displayed vary according to the [1. EV Steps] and [2. Sensitivity Steps] settings made in the [C Custom Setting 1] menu (p.89).

- 6 Press the MENU button.**

The screen that was displayed in Step 2 appears again.

- 7 Press the MENU button twice.**

The camera is ready to take a picture.

Slow Shutter Speed NR

Reduces noise during long exposures.

1 Select [Slow Shutter Speed NR] in the [📷 Rec. Mode 2] menu and press the four-way controller (▶).

2 Use the four-way controller (▲▼) to select [AUTO], [ON] or [OFF], and press the OK button.

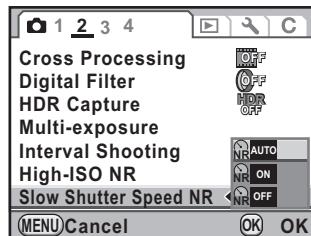

AUTO	Determines conditions such as shutter speed, sensitivity, and internal temperature, and automatically applies Noise Reduction as necessary. (default setting)
ON	Applies Noise Reduction when the exposure time is longer than 1 second.
OFF	Does not apply Noise Reduction.

3 Press the MENU button.

The camera is ready to take a picture.



- Processing may take a while when shooting with Slow Shutter Speed NR set to [ON]. Pictures cannot be taken while an image is being processed.
- When the Noise Reduction function is activated, [nr] blinks on the status screen and in the viewfinder where the aperture value is normally displayed, and a countdown of processing time is displayed where the shutter speed is normally displayed.

Changing the Exposure Mode

This camera features the following five exposure modes. Use the mode dial to change the exposure mode. (p.91)

The settings available for each exposure mode are as follows.

(✓: Available #: Restricted ×: Not available)

Exposure Mode	Description	EV Compensation	Change Shutter Speed	Change Aperture Value	Change Sensitivity	Page
P Program	Automatically sets the shutter speed and aperture value to obtain a proper exposure according to Program line when taking pictures.	✓	#*1	#*1	✓	p.104
Sv Sensitivity Priority	Automatically sets the shutter speed and aperture value to obtain a proper exposure according to the set sensitivity.	✓	×	×	Other than AUTO	p.106
Tv Shutter Priority	Lets you set the desired shutter speed for expressing moving subjects.	✓	✓	×	✓	p.107
Av Aperture Priority	Lets you set the aperture value for controlling the depth of field.	✓	×	✓	✓	p.108
M Manual	Lets you set the shutter speed and aperture value to capture the picture with creative intent.	×	✓	✓	Other than AUTO	p.110

*1 In [Green Button] of the [📷 Rec. Mode 4] menu, you can make the setting so that the shutter speed and/or aperture value can be changed by turning the e-dial. (p.105)

Using a Lens with an Aperture Ring

When using a lens with an aperture ring, set the aperture to the **A** (AUTO) position while holding down the auto-lock button on the lens.

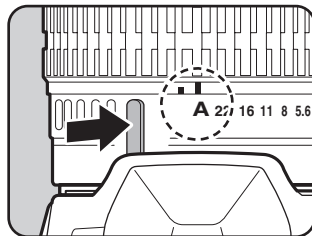

Using the P (Program) Mode

Automatically sets the shutter speed and aperture value to obtain a proper exposure according to Program line when taking pictures.

You can also use the e-dial to change the shutter speed and aperture value while maintaining the proper exposure. (p.105)

1 Set the mode dial to P.

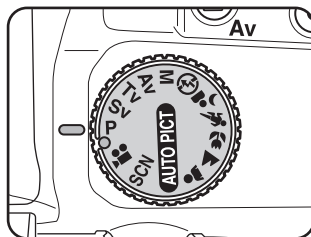

2 Turn the e-dial while pressing the \square Av button to adjust the exposure.

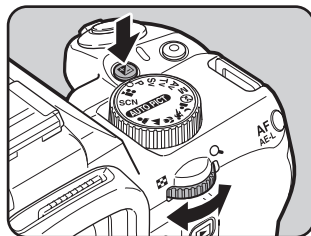

The EV compensation value is displayed in the status screen and viewfinder.

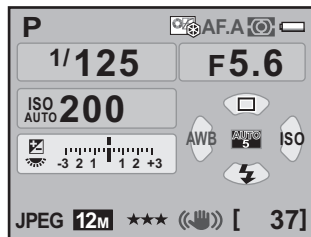

EV compensation value



- EV compensation value can be set in increments of 1/3 EV or 1/2 EV. Set the exposure steps in [1. EV Steps] of the [C Custom Setting 1] menu. (p.118)
- The proper exposure may not be obtained with the selected shutter speed and aperture value when the sensitivity is set to [Fixed Value] (p.98).

E-dial in Program

You can set the function of the e-dial when turned in **P** mode. Set in [Green Button] of the [Rec. Mode 4] menu. (This operation is available only when [Green Button] is assigned to the button.) (p.197)

If the button is pressed after turning the e-dial, the camera returns to normal **P** mode.

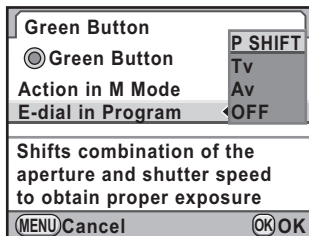

P SHIFT	Automatically adjusts the shutter speed and aperture value to obtain a proper exposure (Program shift). (default setting)
Tv	Sets the shutter speed.
Av	Sets the aperture value.
OFF	Disables the e-dial operation when turned in P mode.

Using the Sv (Sensitivity Priority) Mode

You can set the sensitivity to suit the brightness of the subject. The shutter speed and aperture value are automatically set according to the selected sensitivity to obtain a proper exposure.

1 Set the mode dial to Sv.

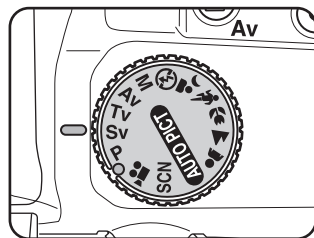

2 Turn the e-dial to adjust the sensitivity.

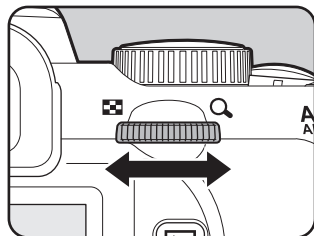

The set values are displayed in the status screen and viewfinder.

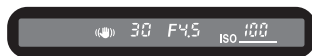
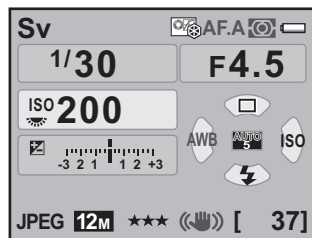

- You can set the sensitivity to a value equivalent to ISO 200 to 12800. [AUTO] is not available.
- Turn the e-dial while pressing the Av button to change the EV compensation value. (p.117)
- The sensitivity can be set in increments of 1/3 EV or 1/2 EV. Set the exposure steps in [1. EV Steps] of the [C Custom Setting 1] menu. (p.118)

Using the Tv (Shutter Priority) Mode

Lets you set the desired shutter speed for expressing moving subjects. When taking pictures of a fast moving subject, you can increase the shutter speed to make the subject look still or decrease the shutter speed to have the subject show movement.

The aperture value is automatically set to give a proper exposure depending on the shutter speed.

☞ Effect of Aperture and Shutter Speed (p.96)

1 Set the mode dial to Tv.

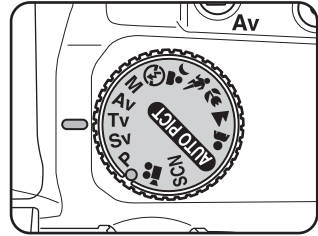

2 Turn the e-dial to adjust the shutter speed.

The shutter speed can be set within the range of 1/6000 to 30 seconds.

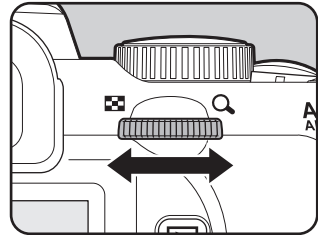

The set values are displayed in the status screen and viewfinder.

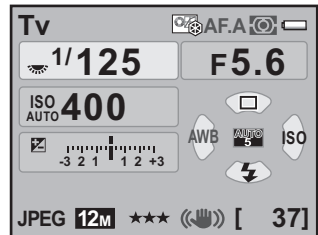



- Turn the e-dial while pressing the **Av** button to change the EV compensation value. (p.117)
- The shutter speed can be set in increments of 1/3 EV or 1/2 EV. Set the exposure steps in [1. EV Steps] of the [C Custom Setting 1] menu. (p.118)
- The proper exposure may not be obtained with the selected shutter speed when the sensitivity is set to [Fixed Value] (p.98).

Exposure Warning

If the subject is too bright or too dark, the aperture value will blink in the status screen and viewfinder. If the subject is too bright, choose a faster shutter speed. If it is too dark, choose a slower shutter speed. When the aperture value indication stops blinking, you can take a picture with proper exposure.



Use a commercially available ND (Neutral Density) Filter if the subject is too bright. Use a flash if it is too dark.

Using the Av (Aperture Priority) Mode

Set the aperture value for controlling the depth of field. The depth of field is deeper and the front and back of the focused object is clear when the aperture is set to a large value, a small lens opening. The depth of field is shallower and the front and back of the focused object is blurred when the aperture is set to a small value, large lens opening.

The shutter speed is automatically set to the proper exposure depending on the aperture value.

☞ Effect of Aperture and Shutter Speed (p.96)

1 Set the mode dial to Av.

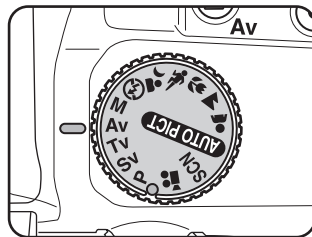

2 Turn the e-dial to adjust the aperture value.

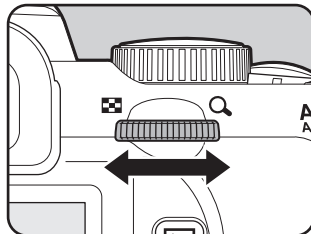

The set values are displayed in the status screen and viewfinder.

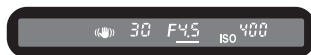
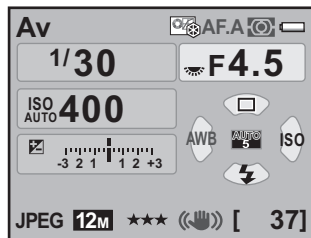

- Turn the e-dial while pressing the **Av** button to change the EV compensation value. (p.117)
- The aperture value can be set in increments of 1/3 EV or 1/2 EV. Set the exposure steps in [1. EV Steps] of the [C Custom Setting 1] menu. (p.118)
- The proper exposure may not be obtained with the selected aperture value when the sensitivity is set to [Fixed Value] (p.98).

Exposure Warning

If the subject is too bright or too dark, the shutter speed will blink in the status screen and viewfinder. When the

subject is too bright, set the aperture to a smaller lens opening (larger number), and when too dark, set the aperture to a larger lens opening (smaller number). Once blinking stops, you can take a picture with proper exposure.

Use a commercially available ND (Neutral Density) Filter if the subject is too bright. Use a flash if it is too dark.



Using the M (Manual) Mode

You can set the shutter speed and aperture value. This mode is suitable to take pictures of your choice by combining them. This mode is convenient for taking pictures using the same combination of the shutter speed and aperture settings or taking intentionally underexposed (darker) or overexposed (brighter) photographs.

☞ Effect of Aperture and Shutter Speed (p.96)

1 Set the mode dial to M.

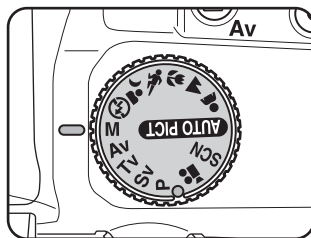

2 Turn the e-dial to adjust the shutter speed.

The shutter speed can be set within the range of 1/6000 to 30 seconds.

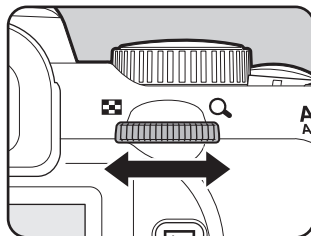

3 Turn the e-dial while pressing the \square Av button to adjust the aperture value.

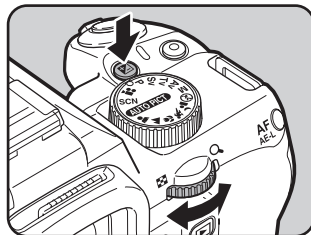

The set values are displayed in the status screen and viewfinder.

On the status screen, the e-dial indicator appears next to the shutter speed or aperture value, depending on which is being adjusted.

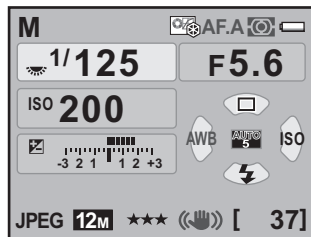

Of the shutter speed and aperture value, the value being adjusted is underlined in the viewfinder.

While adjusting the shutter speed or aperture value, the difference from the proper exposure (EV value) appears in the viewfinder. The proper exposure is set when [0.0] is displayed.

The EV compensation value blinks in the viewfinder when the difference from the proper exposure becomes ± 3.0 or larger.



Difference from the proper exposure





- When the sensitivity is set to [AUTO] and the mode dial is set to **M**, the sensitivity is set to the last set value.
- The shutter speed and aperture value can be set in increments of 1/3 EV or 1/2 EV. Set the exposure steps in [1. EV Steps] of the [C Custom Setting 1] menu. (p.118)
- The aperture value can also be changed by pressing the **Av** button once, taking your finger off the button and turning the e-dial. In this case, the aperture value is set when the **Av** button is pressed again or the exposure metering timer (p.116) elapses.

Using AE Lock

When [AF/AE-L Button] in the [📷 Rec. Mode 4] menu is set to [AE Lock] and the exposure is locked (p.120) by pressing the **AF/AE-L** button in **M** mode, if the shutter speed or aperture value is changed, the combination of shutter speed and aperture value changes while the exposure value is retained.

Example) If the shutter speed is 1/125 sec. and aperture is F5.6 and these settings are locked with the **AF/AE-L** button, the aperture automatically changes to F11 if the shutter speed is changed to 1/30 sec. with the e-dial.

Action in M Mode

You can set the function of the  button when the camera is set to **M** mode. Set in [Green Button] of the [📷 Rec. Mode 4] menu. (This operation is available only when [Green Button] is assigned to the  button. (p.197))

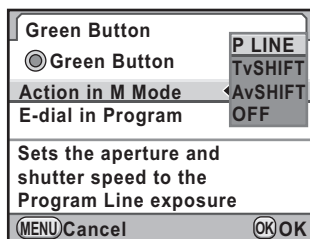

P LINE	Adjusts the aperture value and shutter speed to obtain a proper exposure according to the Program Line. (default setting)
Tv SHIFT	Adjusts the shutter speed while the aperture value remains fixed to obtain a proper exposure.
Av SHIFT	Adjusts the aperture value while the shutter speed remains fixed to obtain a proper exposure.
OFF	Disables the  button operation when pressed in M mode.

Using the Bulb Shooting

This setting is useful when shooting night scenes and fireworks which require the long exposures.

1 Set the mode dial to M.

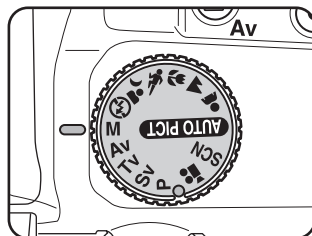

2 Turn the e-dial to the left (☒) and set the shutter speed to Bulb.

Bulb appears after the slowest shutter speed (30 sec.).

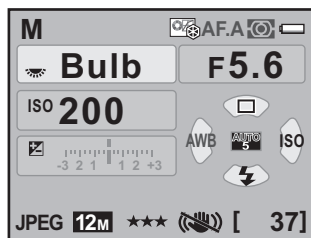

3 Press the shutter release button.

The shutter remains open as long as the shutter release button is kept pressed.



In Bulb shooting, the following functions are not available.

- EV Compensation
- Exposure Bracketing
- Continuous Shooting
- Interval Shooting
- HDR Capture



- Turn the e-dial while holding down the **Av** button to adjust the aperture value.
- The aperture value can be set in increments of 1/3 EV or 1/2 EV. Set the exposure steps in [1. EV Steps] of the [**C** Custom Setting 1] menu. (p.118)
- The Shake Reduction function is automatically turned off during Bulb shooting.
- Use a sturdy tripod to prevent camera shake during Bulb shooting.
- To operate the shutter release button on the remote control, set in [15. Remote Control in Bulb] of the [**C** Custom Setting 3] menu (p.90).
- You can reduce image noise (image roughness or unevenness) caused by the slow shutter speed. Set in [Slow Shutter Speed NR] of the [Rec. Mode 2] menu. (p.102)
- When the sensitivity is set to [AUTO] and the shutter speed is set to **Bulb**, the sensitivity is set to the last set value.
- The upper sensitivity limit for Bulb shooting is ISO 1600.
- There is no limit on exposure time for Bulb shooting. However, we recommend using the AC adapter kit K-AC109 (optional) when shooting with a long exposure setting as the battery is being drained while the shutter remains open. (p.50)

Selecting the Metering Method

Choose the part of the viewfinder to use for measuring brightness and determining exposure. The following three methods are available.

● Multi-segment Metering (default setting)

The scene in the viewfinder is metered in 16 different zones. Even in backlit locations, this mode automatically determines what level of brightness is in which portion and automatically adjusts exposure.

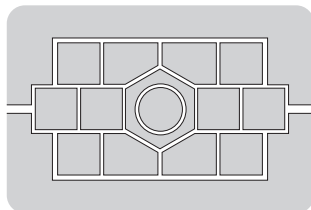

Multi-segment metering method is not available when using a lens other than a DA, DA L, D FA, FA J, FA, F or A lens, or when the lens aperture ring is set to the position other than **A**.

Linking AE to AF Point during Multi-segment Metering

In [6. Link AE to AF Point] of the [C Custom Setting 1] menu (p.89), you can link the exposure and AF point in the focusing area during multi-segment metering.

1	Off	Exposure is set separately from the AF point. (default setting)
2	On	Exposure is set in accordance with the AF point.

● Center-weighted Metering

Metering is weighted at the center of the viewfinder. Use this metering when you want to compensate the exposure by experience, instead of leaving it to the camera. The illustration shows that sensitivity increases as the pattern height increases (center). This mode does not automatically compensate for backlit scenes.

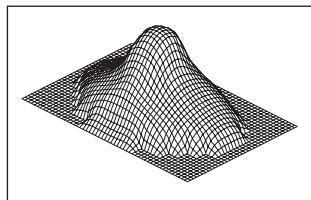

● Spot Metering

The brightness is measured only within a limited area at the center of the viewfinder. You can use this in combination with the AE Lock (p.120) when the subject is extremely small and the correct exposure is difficult to obtain.

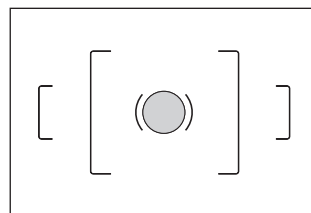

1 Press the **INFO** button in the status screen.

The control panel appears.

Press the **INFO** button when the status screen is not displayed.

- 2** Use the four-way controller (▲▼◀▶) to select [AE Metering] and press the OK button.

The [AE Metering] screen appears.

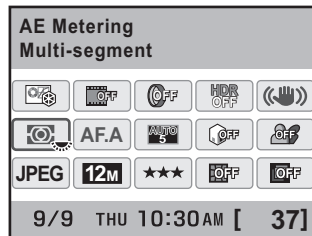

- 3** Use the four-way controller (◀▶) to select a metering method.

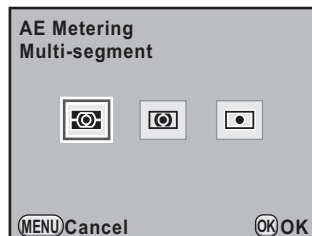

- 4** Press the OK button.

The camera returns to the control panel.



You can also change the setting from the [📷 Rec. Mode 1] menu.

Setting the Meter Operating Time

You can set the exposure metering time to [10 sec.] (default setting), [3 sec.] or [30 sec.] in [4. Meter Operating Time] of the [C Custom Setting 1] menu (p.89).

Adjusting the Exposure

This allows you to deliberately overexpose (brighten) or underexpose (darken) your picture.

The exposure steps can be selected from 1/3 EV or 1/2 EV in [1. EV Steps] of the [C Custom Setting 1] menu.

You can adjust the EV compensation value from -3 to +3 (EV).

1 Turn the e-dial while pressing the Av button.

The exposure is adjusted.

 Av button

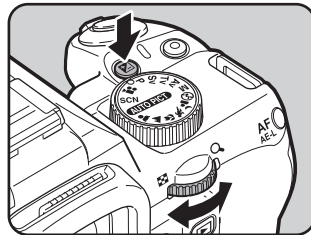



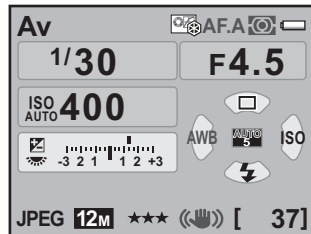

 is displayed in the status screen and viewfinder during adjustment.



Compensation value



- EV compensation is not available when the mode dial is set to **M** (Manual).
- The EV compensation is not canceled by turning the camera off or by switching to another capture mode.
- If [Green Button] is assigned to the  button in [Green Button] of the [Rec. Mode 4] menu (p.197), the compensation value is reset to 0.0 when the  button is pressed.
- EV compensation can also be changed by pressing the  Av button once, taking your finger off the button and turning the e-dial. In this case, EV compensation is set when the  Av button is pressed again or the exposure metering timer (p.116) elapses.

Changing the Exposure Steps

Set the exposure compensation steps to increments of 1/3 EV or 1/2 EV in [1. EV Steps] of the [C Custom Setting 1] menu (p.89).

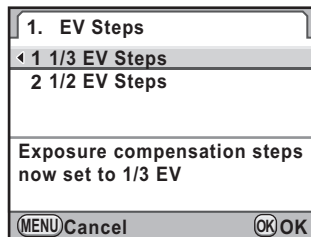

Step Interval	Exposure Setting Value
1/3 EV	±0.3, ±0.7, ±1.0, ±1.3, ±1.7, ±2.0, ±2.3, ±2.7, ±3.0
1/2 EV	±0.5, ±1.0, ±1.5, ±2.0, ±2.5, ±3.0

Changing the Exposure Automatically when Shooting (Exposure Bracketing)

You can take three consecutive images at three different exposure levels when the shutter release button is pressed. The first image is exposed with no compensation, the second image is underexposed (negative compensation) and the third image is overexposed (positive compensation).



Standard exposure



Underexposure



Overexposure

You can set [7. Auto Bracketing Order] in the [C Custom Setting 1] menu (p.89).

1	0 - +	Standard → Underexposed → Overexposed (default setting)
2	- 0 +	Underexposed → Standard → Overexposed
3	+ 0 -	Overexposed → Standard → Underexposed
4	0 + -	Standard → Overexposed → Underexposed



- Exposure Bracketing is not available in the following situations.
 - when the capture mode is set to (Moving Object), or (Kids)/ (Pet)/ (Night Scene HDR) or (SCN (Scene) mode)
 - when the shutter speed is set to **Bulb**
- Exposure Bracketing and Multi-exposure cannot be used at the same time. The function selected last is used.

1 Press the four-way controller (▲) in Capture mode.

The [Drive Mode] screen appears.

2 Use the four-way controller (◀▶) to select .

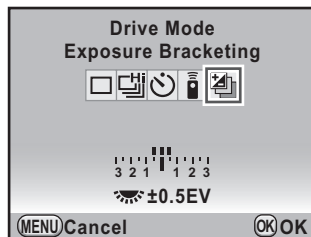

3 Turn the e-dial to set the bracket value.

The following bracket values can be set according to the step interval set in [1. EV Steps] (p.118) of the [C Custom Setting 1] menu.

Step Interval	Bracket Value
1/3 EV	±0.3, ±0.7, ±1.0, ±1.3, ±1.7, ±2.0, ±2.3, ±2.7, ±3.0
1/2 EV	±0.5, ±1.0, ±1.5, ±2.0, ±2.5, ±3.0

Available operations

- Av button + e-dial Adjusts the EV compensation only when taking underexposed or overexposed image with Exposure Bracketing. Images are taken with an EV compensation value set to 0 (intermediate value).
- button Resets the compensation value to ±0. (Available only when [Green Button] is assigned to the button in [Green Button] of the [Rec. Mode 4] menu (p.197).)

4 Press the OK button.

The value for the first image blinks on the monitor.
The camera is ready to take a picture.

5 Press the shutter release button halfway.

The focus indicator  appears in the viewfinder, and EV compensation value appears in the status screen and viewfinder when focused.

6 Press the shutter release button fully.

Continue to press the shutter release button until three images are captured.

Three consecutive images will be taken according to the order set in [7. Auto Bracketing Order] of the [C Custom Setting 1] menu (p.89).



- When [AF Mode] is set to **A.F.S** (Single mode), the focus position is locked in the first image and is used for subsequent images.
- When you take your finger off the shutter release button during Exposure Bracketing, the exposure setting will remain effective for twice the amount of the exposure metering timer (default setting is approx. 20 seconds) (p.116) and you can take a picture at the next compensation value. In this case, autofocus works for each image. After about twice the amount of the exposure metering timer elapses, the camera returns to settings for taking the first image.
- You can combine Exposure Bracketing with the built-in flash or an external flash (P-TTL auto only) to change only the flash output continuously. However, when using an external flash, holding the shutter release button down to take three consecutive images may cause the second and third images to be taken before the flash is fully charged. Take each image after confirming that charging is complete.

Locking the Exposure Before Shooting (AE Lock)

AE Lock is a function that locks the exposure prior to taking a picture. Use this when the subject is too small or is backlit and a proper exposure setting cannot be obtained.

1 Select [AF/AE-L Button] in the [Rec. Mode 4] menu and press the four-way controller (▶).

The [AF/AE-L Button] screen appears.

- 2** Press the four-way controller (▶) and use the four-way controller (▲▼) to select [AE Lock].

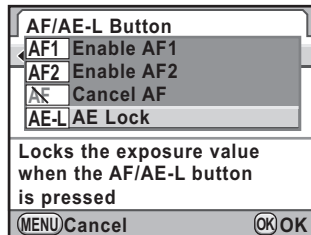

- 3** Press the OK button.

- 4** Press the MENU button twice.

The camera is ready to take a picture.

- 5** Set the exposure and press the AF/AE-L button.

The camera locks the exposure (brightness) at that instant.

* is displayed in the status screen and viewfinder while the AE Lock is engaged.

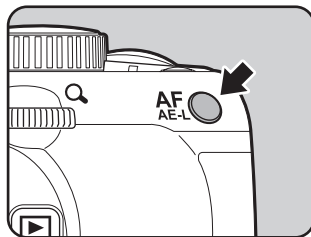

- The exposure remains locked as long as the **AF/AE-L** button is kept pressed or the shutter release button is kept pressed halfway. The exposure remains locked for twice the amount of the exposure metering timer (p.116) even after taking your finger off the **AF/AE-L** button.
- You will hear a beep when the **AF/AE-L** button is pressed. The beep can be turned off. (p.269)
- AE Lock is not available when the shutter speed is set to **Bulb**.
- When any of the following operations are performed, AE Lock is canceled.
 - the **AF/AE-L** button is pressed again
 - the ▶ button, **MENU** button or **INFO** button is pressed
 - the mode dial is turned
 - the lens is changed
 - the lens with an **A** (Auto) position is set to other than the **A** position
- The combination of shutter speed and aperture value changes depending on the zooming position even while the AE Lock is engaged when using a zoom lens for which the maximum aperture varies depending on the focal length. However, the exposure value does not change and a picture is taken at a brightness level set when the AE Lock is activated.
- The exposure can also be locked when the focus is locked. Set in [5. AE-L with AF Locked] of the [C Custom Setting 1] menu. (p.133)

You can focus with the following methods.

AF Autofocus	The camera automatically focuses on the subject when the shutter release button is pressed halfway.
MF Manual focus	Manually adjust the focus.

Using the Autofocus

You can also choose the autofocus mode from **A.F.S** (Single mode) where the shutter release button is pressed halfway to focus on the subject and the focus is locked at that position, **A.F.C** (Continuous mode) where the subject is kept in focus by continuous adjustment while the shutter release button is pressed halfway, and **A.F.A** (Auto) which automatically switches between **A.F.S** and **A.F.C**. The default setting is **A.F.A**.

☞ Setting the AF Mode (p.125)

1 Set the focus mode lever to **AF**.

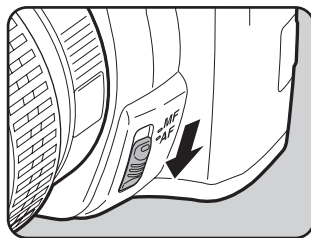

- 2 **Look through the viewfinder and press the shutter release button halfway.**

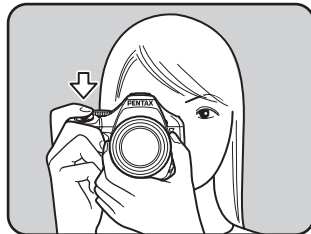

The focus indicator  appears and you will hear a beep when the subject comes into focus. (When blinking, the subject is not in focus.)

-  Subjects that are difficult to focus on (p.73)



Focus Indicator

Using the AF/AE-L Button to Focus on the Subject

You can set the camera so that focusing is performed when the **AF/AE-L** button is pressed. Use this setting when the autofocus by pressing the shutter release button halfway is not desired.

- 1 **Select [AF/AE-L Button] in the [Rec. Mode 4] menu and press the four-way controller (▶).**

The [AF/AE-L Button] screen appears.

- 2** Press the four-way controller (▶) and use the four-way controller (▲▼) to select [Enable AF1] or [Enable AF2].

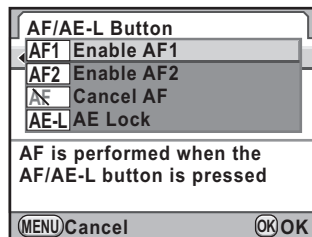

Enable AF1	Autofocus is performed by using the AF/AE-L button or the shutter release button. (default setting)
Enable AF2	Autofocus is performed only when the AF/AE-L button is pressed and not when the shutter release button is pressed halfway.
Cancel AF	MF appears in the viewfinder while the AF/AE-L button is pressed. Autofocus is not performed when the shutter release button is pressed. (Take your finger off the AF/AE-L button to return to normal autofocus mode.)
AE Lock	The exposure setting is locked when the AF/AE-L button is pressed. (p.120)

- 3** Press the **OK** button.

- 4** Press the **MENU** button twice.

The camera is ready to take a picture.





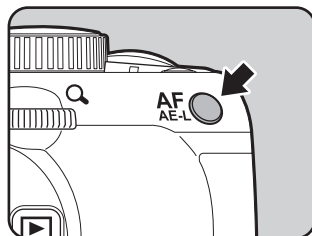







- 5** Press the **AF/AE-L** button while looking through the viewfinder.





Autofocus is performed.



Setting the AF Mode

You can choose from the following three autofocus modes.

<p>AF.A Auto</p>	<p>Switches automatically between AF.S and AF.C modes according to the subject. (default setting)</p> <ul style="list-style-type: none"> • [AF Mode] is fixed to AF.A in <small>AUTO PICT</small> (Auto Picture) mode. • Even if AF.A is selected, [AF Mode] is fixed to AF.S when taking pictures by using Live View with the mode dial set to P, Sv, Tv, Av or M. 							
<p>AF.S Single mode</p>	<p>When the shutter release button is pressed halfway to focus on the subject, the focus is locked at that position (Focus Lock). To focus on another subject, take your finger off the shutter release button first, then press the shutter release button halfway again.</p> <ul style="list-style-type: none"> • [AF Mode] is fixed to AF.S in  (Portrait),  (Landscape),  (Macro),  (Night Scene Portrait) and  (Flash Off) of Picture mode or  (Night Scene),  (Surf & Snow),  (Food),  (Sunset),  (Night Scene HDR),  (Candlelight), and  (Museum) of SCN (Scene) mode. • The AF assist light turns on as necessary. (p.127) • Set the action priority for when the shutter release button is pressed fully in [9. AF.S Setting] in the [C Custom Setting 2] menu (p.89). <table border="1" data-bbox="306 753 955 1000"> <tr> <td data-bbox="306 753 345 931">1</td> <td data-bbox="345 753 522 931">Focus-priority</td> <td data-bbox="522 753 955 931">The shutter cannot be released until the subject is in focus. (default setting) If the subject is too close to the camera, move back and take the picture. If the subject is difficult to focus (p.73), adjust the focus manually. (p.134)</td> </tr> <tr> <td data-bbox="306 931 345 1000">2</td> <td data-bbox="345 931 522 1000">Release-priority</td> <td data-bbox="522 931 955 1000">The shutter can be released even if the subject is not in focus.</td> </tr> </table>		1	Focus-priority	The shutter cannot be released until the subject is in focus. (default setting) If the subject is too close to the camera, move back and take the picture. If the subject is difficult to focus (p.73), adjust the focus manually. (p.134)	2	Release-priority	The shutter can be released even if the subject is not in focus.
1	Focus-priority	The shutter cannot be released until the subject is in focus. (default setting) If the subject is too close to the camera, move back and take the picture. If the subject is difficult to focus (p.73), adjust the focus manually. (p.134)						
2	Release-priority	The shutter can be released even if the subject is not in focus.						

AF.C Continuous mode	The subject is kept in focus by continuous adjustment while the shutter release button is pressed halfway. The focus indicator ● appears in the viewfinder and you will hear a beep. Even if the subject is not in focus, the shutter can be released when the shutter release button is pressed fully.	
	<ul style="list-style-type: none"> • Available only when the mode dial is set to P, Sv, Tv, Av or M. • [AF Mode] is fixed to AF.C in  (Moving Object) of Picture mode and  (Stage Lighting),  (Night Snap),  (Kids), and  (Pet) of SCN (Scene) mode. • When the shutter release button is pressed halfway or the AF/AE-L button is used to adjust the focus, the camera automatically tracks the subject if it is determined to be a moving object. • Set the action priority for Continuous Shooting in [10. AF.C Setting] in the [C Custom Setting 2] menu (p.89). 	
	1	Focus-priority Takes pictures giving priority to keeping the subject in focus during Continuous Shooting. (default setting)
	2	FPS-priority Takes pictures giving priority to the shooting speed during Continuous Shooting.

1 Set the focus mode lever to **AF**.

2 Press the **INFO** button in the status screen.

The control panel appears.

Press the **INFO** button when the status screen is not displayed.

3 Use the four-way controller (▲▼◀▶) to select [AF Mode] and press the **OK** button.

The [AF Mode] screen appears.

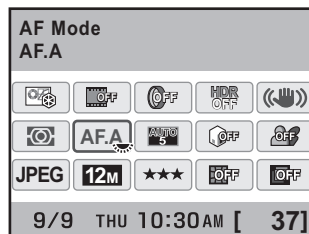

- 4** Use the four-way controller (◀▶) to select an AF mode.

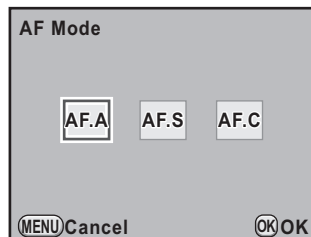

- 5** Press the OK button.

The camera returns to the control panel.



- You can also change the setting from the [📷 Rec. Mode 1] menu (p.87).
- [AF Mode] cannot be changed when the capture mode is set to Picture mode or **SCN** (Scene) mode.
- Always set the camera to **AF.S** when using the Quick-Shift Focus System on a DA lens.

You can set whether or not to use the AF assist light during **AF.S** mode in [11. AF Assist Light] in the [C Custom Setting 2] menu (p.89).

1	On	To make focusing easier when the subject is in a dark location, the AF assist light turns on when the shutter release button is pressed halfway. (default setting)
2	Off	The AF assist light will not be used.

AF Fine Adjustment

You can adjust the AF focusing position.



- Be sure to use [AF Fine Adjustment] only when necessary. Care should be taken as adjusting the autofocus may make it difficult to capture images with the appropriate focus.
- Any camera shake during test shooting may make it difficult to obtain the accurate focusing position. Therefore, always use a tripod when taking test shots.

1 Select [21. AF Fine Adjustment] in the [C Custom Setting 3] menu and press the four-way controller (▶).

2 Use the four-way controller (▲▼) to select [On] and press the four-way controller (▶).

The [21. AF Fine Adjustment] screen appears.

3 Use the four-way controller (◀▶) to adjust the value.

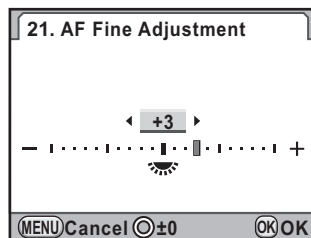

Available operations

Four-way controller (▶)	Adjusts the focus to a closer position.
Four-way controller (◀)	Adjusts the focus to a farther position.
○ button	Resets the adjustment value to ±0.

4 Press the OK button.

The adjustment value is saved.

5 Press the MENU button.

The camera is ready to take a picture.

6

Take a test picture.

You can easily check the focusing point by enlarging the image during Digital Preview (p.140) or Live View (p.159).



Select [Off] in Step 2 to negate an effect of the adjustment value (however, this does not reset the value).

Selecting the Focusing Area (AF Point)

Choose the part of the viewfinder to set focus to.

Selected AF point(s) light red in the viewfinder (Superimpose AF Area).

Auto (5 AF Points)	Out of the 5 AF points, the camera selects the optimum AF point even if the subject is not centered. (default setting)
Auto (11 AF Points)	Out of the 11 AF points, the camera selects the optimum AF point even if the subject is not centered.
Select	Sets the focusing area to the user selected point from eleven points in the AF frame.
Spot	Sets the focusing area to the center of the viewfinder.

1

Press the INFO button in the status screen.

The control panel appears.

Press the **INFO** button when the status screen is not displayed.

2

Use the four-way controller (▲▼◀▶) to select [Select AF Point] and press the OK button.

The [Select AF Point] screen appears.

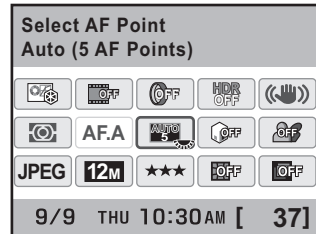

- 3** Use the four-way controller (◀▶) to select a focusing area.

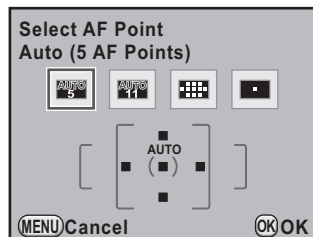

- 4** Press the OK button.

The camera is ready to take a picture.



- You can also change the setting from the [📷 Rec. Mode 1] menu (p.87).
- AF point(s) are not illuminated red in the viewfinder when [Off] is selected for [8. Superimpose AF Area] in the [C Custom Setting 2] menu.
- The focusing area is fixed to regardless of this setting when using lenses other than DA, DA L, D FA, FA J, FA or F lenses.

Setting the Focus Position in the AF Frame

- 1** Set the focusing area to and press the OK button.

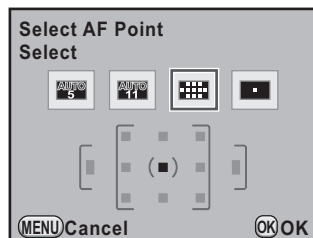

The camera is ready to take a picture.

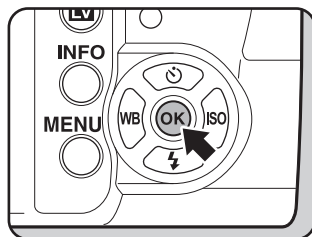

2 Use the four-way controller (▲▼◀▶) to change the AF point.

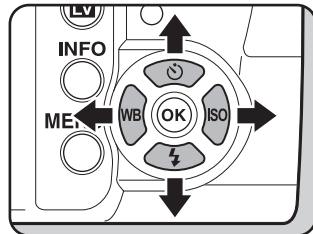

The selected AF point appears in the status screen.

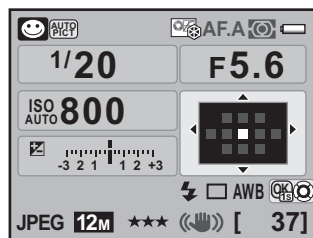

Available operations

OK button

Returns the AF point to the center of the AF frame.

Press and hold **OK** button

Disables changing the AF point and enables direct key operation of the four-way controller (▲▼◀▶). To enable changing the AF point, press the **OK** button while direct key operation is enabled. You will hear a beep when switching between enabled and disabled.

The AF point(s) light red in the viewfinder (Superimpose AF Area) and you can check where you set the AF point.

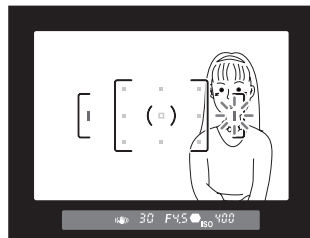

The position of the changed AF point is stored even if the camera is turned off or the focusing area is switched to **AUTO**, **AUTO II** or **AF**.

Locking the Focus (Focus Lock)

If the subject is outside the range of the focusing area, the camera cannot automatically focus on the subject. In this case, set [AF Mode] to **AF.S** (Single mode) first, focus the camera on the subject in the focusing area, lock the focus at that position (Focus Lock), and then recompose your picture.

1 Set [AF Mode] to AF.S.

Refer to p.125.

2 Frame the desired composition for your picture in the viewfinder.

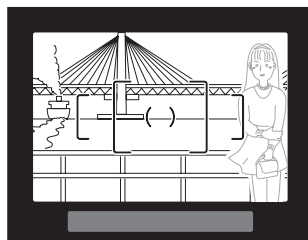

Example) The person is out of focus and the background is focused instead.

3 Center the subject to focus in the viewfinder and press the shutter release button halfway.

The focus indicator  appears and you will hear a beep when the subject comes into focus. (When blinking, the subject is not in focus.)

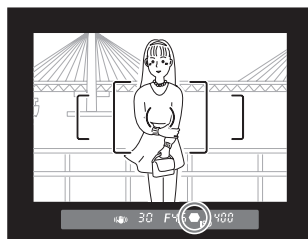





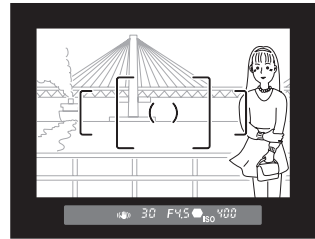

4 Lock the focus.

Keep the shutter release button pressed halfway. The focus will remain locked.

5 Recompose the picture while keeping the shutter release button pressed halfway.



- The focus is locked while the focus indicator  is displayed.
- Turning the zoom ring with the focus locked may cause the subject to be out of focus.
- The beep that sounds when the image is focused can be turned off. (p.269)
- You cannot set the focus lock when [AF Mode] is set to **AFC** (Continuous mode), or the capture mode is set to  (Moving Object) of Picture mode, or  (Stage Lighting),  (Kids),  (Pet) or  (Night Snap) of **SCN** (Scene) mode. In such cases, the autofocus continues to focus on the subject until the shutter is released (Continuous Autofocus).

Locking Exposure when the Focus is Locked

Set [5. AE-L with AF Locked] in the [C Custom Setting 1] menu (p.89) to lock the exposure value while the focus is locked. By default, the exposure is not locked when the focus is locked.

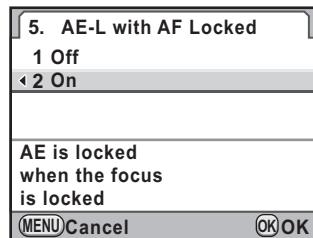



1	Off	Exposure is not locked when the focus is locked. (default setting)
2	On	Exposure is locked when the focus is locked.

Adjusting the Focus Manually (Manual Focus)

When you adjust the focus manually, you can use either the focus indicator or the matte field in the viewfinder.

Using the Focus Indicator

The focus indicator  appears in the viewfinder when the subject is in focus even during manual focus.

You can manually adjust the focus using the focus indicator .

- 1 Set the focus mode lever to **MF**.

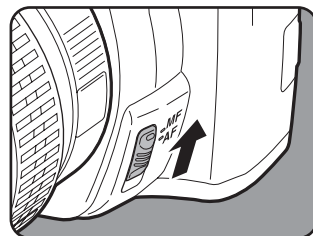

- 2 Look through the viewfinder, press the shutter release button halfway and turn the focusing ring.

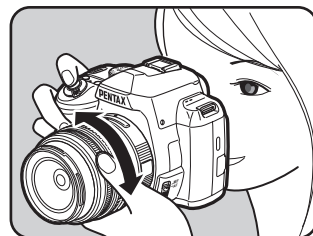

The focus indicator  appears and you will hear a beep when the subject comes into focus.



Focus Indicator



- Adjust the focus manually using the matte field in the viewfinder when the subject is difficult to focus (p.73) and the focus indicator will not appear.
- The beep that sounds when the image is focused can be turned off. (p.269)

Using the Viewfinder Matte Field

You can manually adjust the focus using the matte field in viewfinder.

- 1 Set the focus mode lever to MF.**

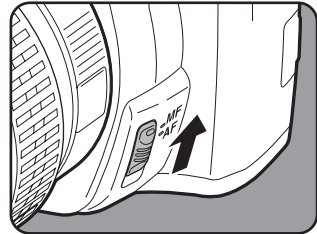

- 2 Look through the viewfinder and turn the focusing ring until the subject is clearly visible in the viewfinder.**

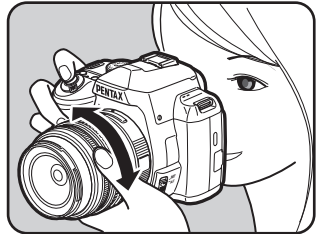

Shooting in Catch-in Focus Mode

When [20. Catch-in Focus] in the [**C** Custom Setting 3] menu (p.90) is set to [On], if [AF Mode] is set to **AFA** or **AFS** and one of the following types of lenses is attached, catch-in focus shooting is enabled and the shutter is released automatically when the subject comes into focus.

- Manual focus lens
- DA or FA lens that has an **AF** and **MF** setting on the lens (the setting on the lens must be set to **MF** before shooting)



● How to Take Pictures

- 1 Attach a proper lens to the camera.
- 2 Set the focus mode lever to **AF**.
- 3 Set [AF Mode] to **AFA** or **AFS**.
- 4 Set the focus on a position the subject will pass.
- 5 Press the shutter release button fully.
The shutter is released automatically when the subject comes into focus at the set position.

Checking the Composition, Exposure and Focus Before Shooting (Preview)

You can use the preview function to check depth of field, composition, exposure and focus before taking a picture.

There are two preview methods.

Preview Method	Description
 Optical Preview	For checking the depth of field with the viewfinder.
 Digital Preview	For checking the composition, exposure and focus on the monitor.



You can also use the Live View function to display a real-time image on the monitor and change the shooting function settings during display and check the settings by enlarging the image. Refer to p.159 for details.

Assigning the Preview Function to the Green Button

First, assign the preview function to the  button.

- 1 **Select [Green Button] in the [Rec. Mode 4] menu and press the four-way controller (▶).**

The [Green Button] screen appears.

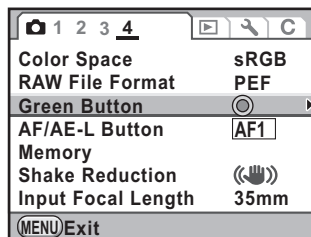

- 2 **Press the four-way controller (▶).**

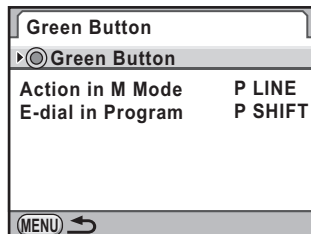

- 3** Use the four-way controller (▲▼) to select [Optical Preview] or [Digital Preview] and press the OK button.

If you selected [Optical Preview], proceed to Step 6.

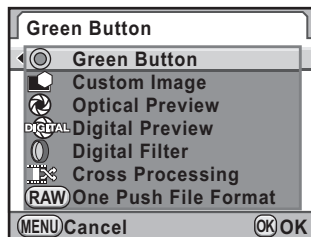

- 4** Use the four-way controller (▲▼) to select [Histogram], [Bright/Dark Area] or [Enlarge Instant Review].

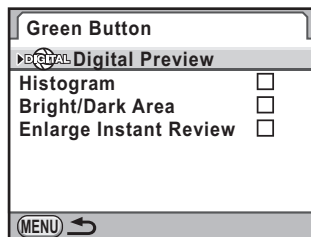

- 5** Use the four-way controller (◀▶) to select or .

- 6** Press the MENU button twice.

The preview function is assigned to the  button and the camera is ready to take a picture.



While shooting with Interval Shooting, Multi-exposure or Live View, Optical Preview is used regardless of the setting.

Displaying the Optical Preview

- 1** Position the subject inside the AF frame and press the shutter release button halfway to focus on the subject.

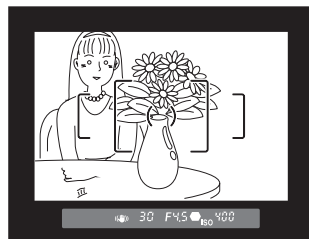

- 2** Press the **⊙** button while looking through the viewfinder.

You can check the depth of field in the viewfinder while the **⊙** button is pressed. During this time, no shooting information is displayed in the viewfinder, and the shutter cannot be released.

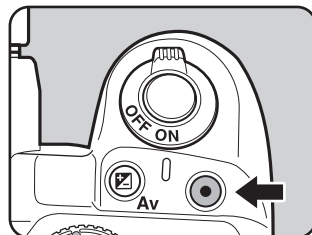



- 3** Take your finger off the **⊙** button.

Optical Preview is ended and the camera is ready to take a picture.

Displaying the Digital Preview

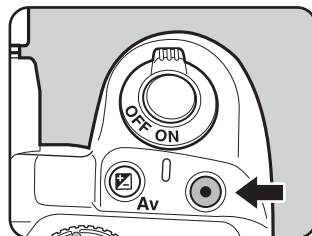
- 1 Focus on the subject, then compose the picture in the viewfinder and press the  button.



The icon  appears on the monitor during preview and you can check the composition, exposure and focus.



Available operations

E-dial	Enlarges the preview image. (p.223)
INFO button	Saves the preview image. Select [Save as] and press the OK button.

- 2 Press the shutter release button halfway.

Digital Preview is ended and the autofocus system operates.



The maximum display time for Digital Preview is 60 seconds.

Taking Pictures Using the Shake Reduction Function

The Shake Reduction function reduces camera shake that occurs when the shutter release button is pressed. This is useful for taking pictures in situations where camera shake is likely to occur. The Shake Reduction function allows you to take pictures at approximately 4 steps slower shutter speed without a risk of camera shake.

The Shake Reduction function is ideal when taking pictures in the following situations.

- When taking pictures in dimly lit locations, such as indoors, at night, on cloudy days and in the shade
- When taking telephoto pictures

Blurred picture

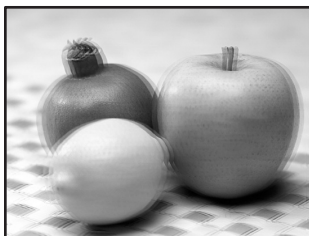

Picture taken with the Shake Reduction function



- The Shake Reduction function does not compensate for blurring caused by subject movement. To take pictures of a moving subject, increase the shutter speed.
- The Shake Reduction function may not fully reduce camera shake when taking close-up shots. In this case, it is recommended to turn off the Shake Reduction function and use the camera with a tripod.
- The Shake Reduction function will not fully work when shooting with a very slow shutter speed, for example when panning or shooting night scenes. In this case, it is recommended to turn off the Shake Reduction function and use the camera with a tripod.

Setting the Shake Reduction Function

1 Press the **INFO** button in the status screen.

The control panel appears.

Press the **INFO** button when the status screen is not displayed.

2 Use the four-way controller (▲▼◀▶) to select [Shake Reduction] and press the **OK** button.

The [Shake Reduction] screen appears.

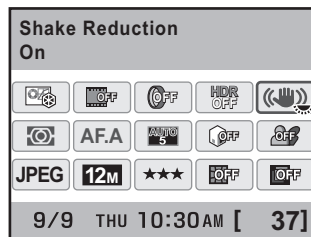

3 Use the four-way controller (◀▶) to select (☞) or (☞).

	Uses Shake Reduction. (default setting)
	Does not use Shake Reduction.

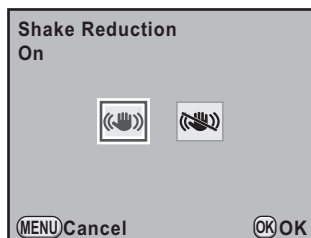

4 Press the **OK** button.

The camera returns to the control panel.

5 Press the shutter release button halfway.

appears in the viewfinder and the Shake Reduction function is activated.

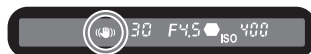



- Be sure to turn the Shake Reduction function off when using the camera with a tripod.
- The Shake Reduction function automatically turns off in the following situations.
 - Self-timer shooting
 - Remote Control shooting
 - when the shutter speed is set to **Bulb**
 - when [Auto Align] is set to (Off) in the [HDR Capture] setting
 - when using the flash in the wireless mode
- The Shake Reduction function is automatically turned on when the capture mode is set to (Night Scene HDR) of **SCN** (Scene) mode.



- You can also change the setting from the [Rec. Mode 4] menu (p.88).
- The Shake Reduction function will not fully work (for about 2 seconds) right after turning on the camera or restoring from Auto Power Off. Wait for the Shake Reduction function to become stable, and then press the shutter button gently. If () appears in the viewfinder when you press the shutter release button halfway, the camera is ready to take a picture.
- The Shake Reduction function is available with any **K-r** compatible PENTAX lens. However, when the aperture ring is set to other than the **A** (Auto) position or a lens without an **A** position is used, the camera will not operate unless [22. Using Aperture Ring] is set to [Permitted] in the [**C** Custom Setting 4] menu. Set this beforehand. In such cases, however, some functions will be restricted. Refer to "Notes on [22. Using Aperture Ring]" (p.314) for details.

When the Focal Length Cannot Be Automatically Detected

The Shake Reduction function operates by obtaining the lens information such as focal length.

If the camera uses a DA, DA L, D FA, FA J, FA or F lens, the lens information is automatically obtained when the Shake Reduction function is activated.

If you use a lens whose information such as focal length cannot be automatically obtained (p.312), the [Input Focal Length] setting screen appears when the camera is turned on with the Shake Reduction function set to () .

Set the focal length manually in the [Input Focal Length] setting screen.



- The [Input Focal Length] setting screen does not appear when using a lens whose information such as focal length can be automatically obtained.
- When using a lens without the **A** position on the aperture or with the aperture set to a position other than the **A** position, set [22. Using Aperture Ring] in the [**C** Custom Setting 4] menu to [Permitted]. (p.314)
- The effect of Shake Reduction is influenced by the shooting distance as well as focal length information. The Shake Reduction function may not work as effectively as expected when shooting at close ranges.

1 Use the four-way controller (◀▶) or the e-dial to set the focal length.

Select from the following 34 focal length values. (The default setting is 35 mm.)

8	10	12	15	18	20	24	28	30	35
40	45	50	55	65	70	75	85	100	120
135	150	180	200	250	300	350	400	450	500
550	600	700	800						

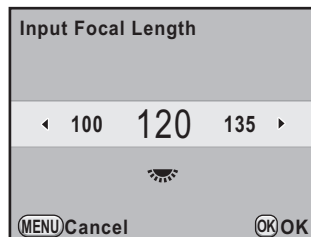

- If the focal length for your lens is not listed above, select the value closest to the actual focal length (example: [18] for 17 mm and [100] for 105 mm).
- When using a zoom lens, select the actual focal length at the zoom setting being used in the same manner.

4

2 Press the OK button.



The camera is ready to take a picture.



To change the focal length setting, use [Input Focal Length] in the [📷 Rec. Mode 4] menu (p.88).

Shooting with Self-timer

This camera has the following two types of self-timers.

 Self-timer (12 sec.)	Shutter is released after about 12 seconds. Use this mode to include the photographer in the picture.
 Self-timer (2 sec.)	A mirror pops up immediately after shutter release button is pressed (Mirror lock-up function). The shutter is released after about 2 seconds. Use this mode to avoid camera shake when the shutter release button is pressed. The AE Lock function is activated and exposure is locked immediately before the mirror pops up.

1 Mount the camera onto a tripod.

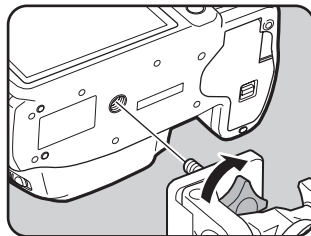

2 Press the four-way controller (▲) in Capture mode.

The [Drive Mode] screen appears.

3 Use the four-way controller (◀▶) to select .

4 Press the four-way controller (▼) and use the four-way controller (◀▶) to select or .

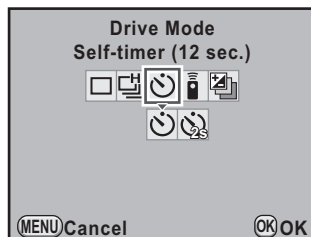

5 Press the OK button.

The camera is ready to take a picture.

6 Press the shutter release button halfway.

The autofocus system operates. The focus indicator  appears in the viewfinder when the subject is in focus.





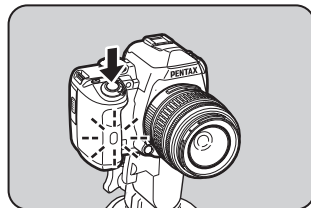



7 Press the shutter release button fully.

For , the self-timer lamp starts blinking slowly and blinks rapidly 2 seconds before the shutter is released. The beep is heard and the rate increases. The shutter will be released about 12 seconds after the shutter release button is pressed fully.



For , the shutter will be released about 2 seconds after the shutter release button is pressed fully.





- The self-timer shooting is not available when the capture mode is set to  (Moving Object) of Picture mode, and  (Kids) or  (Pet) of SCN (Scene) mode.
- Select a mode other than  or  in the [Drive Mode] screen to cancel the self-timer shooting. The setting is canceled when the camera is turned off if [Drive Mode] is set to  (Off) in [Memory] (p.288) of the [Rec. Mode 4] menu.
- The Shake Reduction function is automatically turned off when  or  is set.
- You can set the camera so that the beep does not sound. (p.269)
- The exposure may be affected if light enters the viewfinder. Use the AE Lock function (p.120). The light entering viewfinder has no effect on the exposure when the mode dial is set to **M** (Manual).

Shooting with Remote Control (Optional)

The shutter can be released from a distance by using the optional remote control unit (p.323).

You can select from the following two settings for remote control shooting.

 Remote Control	The shutter is released immediately after the shutter release button on the remote control unit is pressed.
 Remote Control (3s delay)	The shutter is released about 3 seconds after the shutter release button on the remote control unit is pressed.

1 Mount the camera onto a tripod.

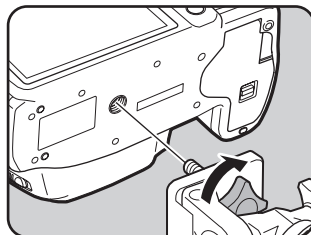

2 Press the four-way controller (▲) in Capture mode.

The [Drive Mode] screen appears.

3 Use the four-way controller (◀▶) to select .

4 Press the four-way controller (▼) and use the four-way controller (◀▶) to select or .

The self-timer lamp will blink and the camera is in a stand-by status.

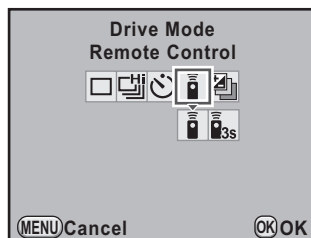

5 Press the OK button.

The camera is ready to take a picture.

6 Press the shutter release button halfway.

The autofocus system operates. The focus indicator  appears in the viewfinder when focused.



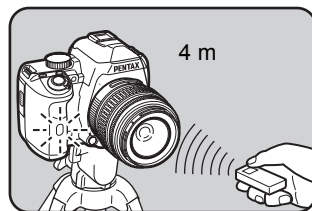









7 Point the remote control unit towards the remote control receiver on the front of the camera and press the shutter release button on the remote control unit.



The operating distance of the remote control unit is about 4 m from the front of the camera.

After a picture is taken, the self-timer lamp lights for 2 seconds and then returns to blinking.





- The remote control shooting is not available when the capture mode is set to  (Moving Object) of Picture mode, and  (Kids) or  (Pet) of **SCN** (Scene) mode.
- By default, you cannot adjust the focus with the remote control unit. Focus on the subject first with the camera before operating with the remote control. When [14. AF with Remote Control] is set to [On] in the [C Custom Setting 2] menu (p.89), you can use the remote control unit to adjust the focus. (AF cannot be used with the remote control unit during Live View.)
- When using the Remote Control Waterproof O-RC1, AF can be operated with the  button. The **Fn** button cannot be used.
- When using the remote control unit, the built-in flash does not pop up automatically even when set to  (Auto Flash Discharge). Press the  **UP** /  button to pop up the built-in flash beforehand. (p.78)
- Select a mode other than  or  in the [Drive Mode] screen to cancel the remote control shooting. The setting is canceled when the camera is turned off if [Drive Mode] is set to  (Off) in [Memory] (p.288) of the [Rec. Mode 4] menu.
- The Shake Reduction function is automatically turned off when  or  is set.
- The exposure may be affected if light enters the viewfinder. Use the AE Lock function (p.120). The light entering the viewfinder has no effect on the exposure when the mode dial is set to **M** (Manual).
- The remote control may not operate in backlit conditions.
- The Remote Control F can send a remote control signal about 30,000 times. Contact a PENTAX Service Center to replace the battery (this will involve a fee).



Continuous Shooting

Pictures can be taken continuously while the shutter release button is kept pressed.

The following two types of continuous shooting are available.

 Continuous Shooting (Hi)	For JPEG image with [12M]/★★★, up to 25 frames are taken continuously at approximately 6 fps. The shooting interval will increase as the buffer fills up.
 Continuous Shooting (Lo)	For JPEG image with [12M]/★★★, pictures are taken continuously at approximately 2 fps until the SD Memory Card is full.



When the file format is [RAW], up to 12 frames for  and up to 36 frames for  can be taken continuously.

1 Press the four-way controller (▲) in Capture mode.

The [Drive Mode] screen appears.

2 Use the four-way controller (◀▶) to select .

3 Press the four-way controller (▼) and use the four-way controller (◀▶) to select or .

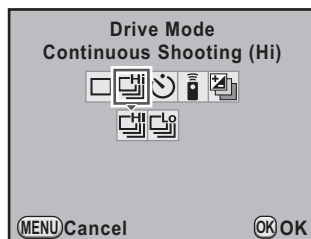

4 Press the OK button.

The camera is ready to take pictures continuously.

5 Press the shutter release button halfway.

The autofocus system operates. The focus indicator ● appears in the viewfinder when focused.

6

Press the shutter release button fully.

Pictures are taken continuously while the shutter release button is fully pressed. Take your finger off the shutter release button to stop.



- The drive mode is fixed to when the capture mode is set to (Moving Object) of Picture mode, and (Kids) or (Pet) of **SCN** (Scene) mode.
- If [AF Mode] is set to **A.F.S** (Single mode), the focus position is locked in the first frame and pictures are taken continuously at the same interval.
- Focusing is continuously activated during continuous shooting when [AF Mode] is set to **A.F.C** (Continuous mode).
- The shutter cannot be released until charging is complete when using the built-in flash. You can set the camera to enable shutter release before the built-in flash is ready in [16. Release While Charging] of the [**C** Custom Setting 3] menu. (p.81)
- Select a mode other than or in the [Drive Mode] screen to cancel the continuous shooting. The setting is canceled when the camera is turned off if [Drive Mode] is set to (Off) in [Memory] (p.288) of the [Rec. Mode 4] menu.
- The shooting speed may be slower when [Distortion Correction] or [Lat-Chromatic-Ab Adj] (p.211) is set to [On].

Interval Shooting

During Interval Shooting, pictures are taken at a set interval from a set time.



- Interval Shooting is not available in the following situations.
 - when the capture mode is set to (Movie), or (Night Scene HDR) of SCN (Scene) mode
 - when the shutter speed is set to **Bulb**
 - when Digital Filter or HDR Capture is set
- When Interval Shooting is set, Multi-exposure is not available.

1 Select [Interval Shooting] in the [Rec. Mode 2] menu and press the four-way controller (▶).

The [Interval Shooting] screen appears.

2 Use the four-way controller (▲▼) to select [Interval].

When taking two or more pictures, set the wait time until the next picture is taken.

Use the four-way controller (◀▶) to select the number of hours, minutes, and seconds, and use the four-way controller (▲▼) to set the time.

You can set up to 24 hours, 00 minutes, and 00 seconds.

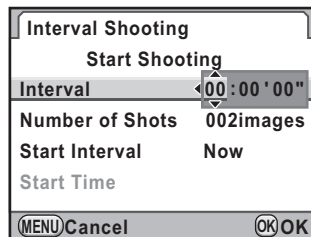

3 Use the four-way controller (▲▼) to select [Number of Shots].

Set the number of shots to be taken.

Press the four-way controller (◀▶) and use the four-way controller (▲▼) to select the number of shots to be taken.

You can select between 1 and 999 shots.

4 Use the four-way controller (▲▼) to select [Start Interval].

Set the time when the first picture is taken.

Press the four-way controller (▶) and use the four-way controller (▲▼) to select [Now] or [Set Time].

Now	Shooting starts immediately. You can take two or more pictures.
Set Time	Shooting starts at the set time. Press the four-way controller (▼) to select [Start Time], use the four-way controller (◀▶) to select the time, and use the four-way controller (▲▼) to set the start time.

5 Use the four-way controller (▲▼) to select [Start Shooting] and press the OK button.

The camera is ready to take a series of interval pictures.

6 Press the shutter release button halfway.

The focus indicator ● appears when the subject is in focus.

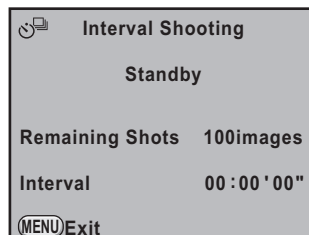

7 Press the shutter release button fully.

When [Start Interval] is set to [Now], the first picture is taken. When set to [Set Time], shooting starts at the set time.

For shooting multiple pictures, pictures are taken at the interval set in Step 2.

After the set number of pictures is taken, the camera returns to normal Capture mode.



- The camera cannot be operated during Interval Shooting. To cancel the Interval Shooting, press any button on the back of the camera or press the shutter release button and the **MENU** button to display the exit confirmation screen, and then use the four-way controller (▲▼) to select [Exit] and press the **OK** button. You can also exit the Interval Shooting by turning the main switch off or turning the mode dial.
- (Single Frame Shooting) is selected regardless of the current drive mode setting.
- If the subject is not in focus with the focus mode set to **AFS** (Single mode) or if the [Interval] setting is too short and the previous image processing cannot be completed before taking the next picture, no picture may be taken.
- Although each shot taken is displayed on the monitor with Instant Review, they cannot be enlarged or deleted.
- The [Interval] setting is disabled when [Number of Shots] is set to [1].
- Interval Shooting is canceled when the SD Memory Card has no more available space.
- If the Auto Power Off function (p.281) turns the camera off during Interval Shooting, the camera automatically turns on again when the shooting time approaches.
- It is recommended to use the AC adapter kit K-AC109 (optional) when using the Interval Shooting over a long period of time. (p.50)

Multi-exposure

You can create a composite picture by taking multiple frames.



- Multi-exposure is not available in the following situations.
 - when the capture mode is set to (Movie), or (Night Scene HDR) of SCN (Scene) mode
 - when Digital Filter, HDR Capture or Cross Processing is set
- When Multi-exposure is set, the following functions are not available.
 - Exposure Bracketing or Interval Shooting (The function selected last is used)
 - Distortion Correction or Lateral Chromatic Aberration Adjustment

1 Select [Multi-exposure] in the [Rec. Mode 2] menu and press the four-way controller (▶).

The [Multi-exposure] screen appears.

2 Use the four-way controller (▲▼) to select [Number of Shots].

3 Press the four-way controller (▶) and use the four-way controller (▲▼) to select the number of shots.

Select from 2 to 9 shots.

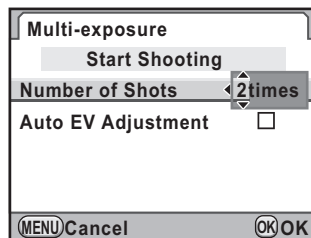

4 Press the OK button.

5 Use the four-way controller (▲▼) to select [Auto EV Adjustment] and use the four-way controller (◀▶) to select or .



When set to (On), the exposure is adjusted automatically according to the number of shots.

6 Use the four-way controller (▲▼) to select [Start Shooting] and press the OK button.

The camera is ready to take a picture.





7

Take the picture.

The composite picture is displayed in Instant Review each time the shutter release button is pressed. Press the  **UP** /  button during Instant Review to discard pictures taken up to that point and take pictures again from the first frame.

The pictures are saved when the set number of shots is taken, and then the [Multi-exposure] screen appears again.



- If any of the following operations are performed while shooting, the pictures that have been already taken are saved and Multi-exposure is ended.
 - when the  button, **MENU** button, four-way controller (  ) or **INFO** button is pressed
 - when the mode dial is turned
 - when Exposure Bracketing is set
- When shooting in Multi-exposure mode using Live View, a semi-transparent composite image of the pictures taken is displayed.

You can apply a filter when taking pictures.
The following filters can be selected.

Filter Name	Effect	Parameter
Toy Camera	For taking pictures that look as if taken with a toy camera.	Shading Level: +1 to +3
		Blur: +1 to +3
		Tone Break: Red/Green/Blue/Yellow
Retro	For taking pictures with the look of old photos.	Toning: -3 to +3
		Frame Composite: None/Thin/Medium/Thick
High Contrast	For taking pictures with high contrasts.	+1 to +5
Extract Color	For extracting two specific colors and making the rest of the image black and white.	Extracted Color 1: Red/Magenta/Blue/Cyan/Green/Yellow
		Extractable Range of Color 1: -2 to +2
		Extracted Color 2: Red/Magenta/Blue/Cyan/Green/Yellow/OFF
		Extractable Range of Color 2: -2 to +2
Soft ^{*1}	For taking pictures with a soft focus throughout the image.	Soft Focus: +1 to +3
		Shadow Blur: OFF/ON
Starburst ^{*1}	For taking pictures of night scenes or lights reflected on water with a special sparkling look by adding extra glitter to the highlights.	Shape: Cross/Star/Snow Crystal/Heart/Musical Note
		Effect Density: Small/Medium/Large
		Size: Small/Medium/Large
		Angle: 0°/30°/45°/60°
Fish-eye ^{*1}	For taking pictures that look as if taken with a fish-eye lens.	Weak/Medium/Strong

Filter Name	Effect	Parameter
Custom Filter *1	Customize and save a filter to your own preferences.	High Contrast: OFF/+1 to +5
		Soft Focus: OFF/+1 to +3
		Tone Break: OFF/Red/Green/Blue/Yellow
		Shading Type: 6 types
		Shading Level: -3 to +3
		Distortion Type: 3 types
		Distortion Level: OFF/Weak/Medium/Strong
Invert Color: OFF/ON		
Color *2	For taking pictures with the selected color filter. Choose from 18 filters (6 colors ×3 tones).	Color: Red/Magenta/Blue/Cyan/Green/Yellow
		Color Density: Light/Medium/Dark

*1 Not available when the capture mode is set to  (Movie).

*2 Available only when the capture mode is set to  (Movie).



- Digital Filter is not available in the following situations.
 - when the capture mode is set to  (Night Scene HDR) of **SCN** (Scene) mode
 - when the file format is set to [RAW] or [RAW+] (fixed to [JPEG])
- When Digital Filter is set, the following functions are not available
 - Continuous Shooting, Interval Shooting or Multi-exposure
 - HDR Capture (The function selected last is used)



Depending on the filter used, it may take longer to save images.

1

Press the **INFO** button in the status screen.

The control panel appears.

Press the **INFO** button when the status screen is not displayed.



- You can also change the settings from the [📷 Rec. Mode 2] menu (p.87).
- Set in [Movie] of the [📷 Rec. Mode 3] menu when the capture mode is set to 📷 (Movie). (p.165)
- Select [Not use any filters] in Step 3 to finish shooting with digital filter.
- You can also apply digital filter effects to JPEG/RAW images after shooting them in Playback mode. (p.253)

You can shoot a picture while displaying the real-time image on the monitor.



- The image in Live View may differ from the captured image if the brightness of the subject is low or high.
- If any changes occur in the shooting light source during Live View, the image may flicker.
- If the camera position is changed rapidly during Live View, the image may not be displayed with the appropriate brightness. Wait for the display to become stable before shooting.
- Noise may appear on the Live View image when used in dark locations.
- Live View can be displayed for up to 5 minutes. When Live View is ended after the elapse of 5 minutes, Live View can be restarted by pressing the **LV** button.
- If you continue shooting with Live View for a prolonged period, the internal temperature of the camera may increase, resulting in lower quality images. It is recommended that you turn off Live View when not shooting. To prevent the image quality from degrading, allow enough time for the camera to cool down while shooting with long exposures or recording movies.
- If the internal temperature of the camera becomes high, (temperature warning) will appear on the monitor and Live View may not be available.
- If Live View is used in places where the camera may become hot, such as in direct sunlight, (temperature warning) may appear on the monitor. Cancel Live View, as the internal temperature of the camera is rising.
- If Live View is used even after (temperature warning) appears, Live View may end before 5 minutes elapse. Shooting with the viewfinder is available even if Live View is ended.
- The higher the sensitivity, the more noise and color unevenness may occur in the Live View image and/or captured image.



- During Live View, nothing is displayed in the viewfinder.
- Holding the camera by hand and shooting while viewing the monitor may cause camera shake. Use of a tripod is recommended.
- Live View is not displayed when data is being saved to an SD Memory Card.

Setting Live View



You can set the display and autofocus method for Live View.

- 1 Select **[Live View]** in the **[📷 Rec. Mode 3]** menu and press the four-way controller (▶).

The **[Live View]** screen appears.

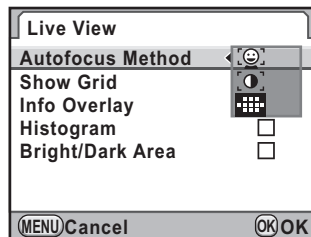
- 2 Press the four-way controller (▶) and use the four-way controller (▲▼) to select an autofocus method.





 Face Detection AF	Gives autofocus priority to detected faces and performs contrast autofocus. A yellow frame appears for a main face (white frames appear for other faces), and autofocus and automatic exposure are performed for the main face. (default setting) The face detection is not performed when the focus mode is set to MF (except when in [AUTO PICT] (Auto Picture)).
 Contrast AF	Displays Live View and performs autofocus based on the information obtained from the image sensor.
 Phase Difference AF	Cancels Live View and performs autofocus with the AF sensor. If the shutter release button is pressed halfway during Live View, the Live View image will disappear and the autofocus system operates. Once focused, the Live View image will be displayed again.

- 3 Press the **OK** button.

4 Use the four-way controller (▲▼) to select [Show Grid] and press the four-way controller (▶).

5 Use the four-way controller (▲▼) to select a grid display type and press the OK button.

Select from [Off] (default setting),  (4×4 Grid),  (Golden Section) or  (Scale).

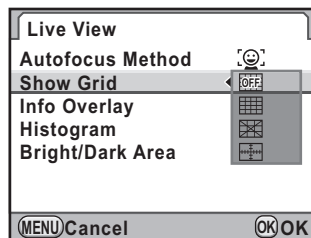



6 Use the four-way controller (▲▼) to select [Info Overlay], [Histogram] or [Bright/Dark Area].

7 Use the four-way controller (◀▶) to select or .

8 Press the MENU button twice.

The screen that was displayed before selecting the menu appears again.



It takes more time to focus on the subject when using  or  than when using . It is also difficult for the camera to focus on the following objects (or under the following conditions).

- objects with poor contrast
- objects with no vertical contrast, such as horizontal stripes
- objects with constantly changing brightness, shape, or color, such as a water fountain
- objects whose distance from the camera changes
- small objects
- objects appearing in both the foreground and background
- when using a special filter
- objects at the edge of the screen

Taking Still Pictures

1 Select a Capture mode.

Set the mode dial to any mode other than .

2 Press the **LV** button.

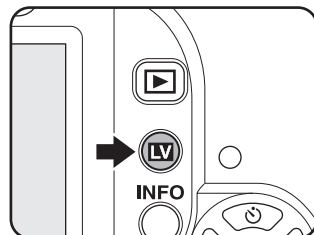

The mirror pops up and a real-time image is displayed on the monitor. Press the **LV** button again to exit Live View.

Live View display

(All of the indicators are displayed here for explanatory purposes.)

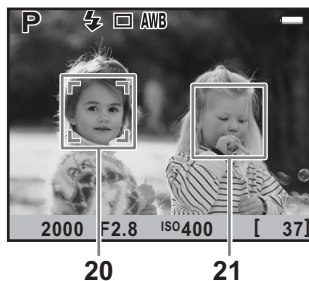
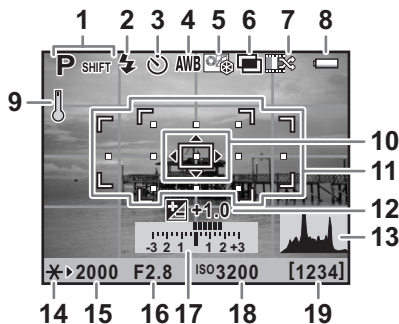

- | | | | |
|---|---|----|---|
| 1 | Capture Mode | 7 | Number of shots using Multi-exposure/Cross Processing |
| 2 | Flash Mode | 8 | Battery level |
| 3 | Drive Mode | 9 | Temperature warning |
| 4 | White Balance | 10 | Contrast AF frame |
| 5 | Custom Image | 11 | Phase Difference AF frame/AF point |
| 6 | Multi-exposure/Interval Shooting/Digital Filter/HDR Capture | | |











- | | |
|---------------------------|---|
| 12 EV Compensation | 18 Sensitivity |
| 13 Histogram | 19 Remaining image storage capacity |
| 14 AE Lock | 20 Main face detection frame (Face Detection AF) |
| 15 Shutter speed | 21 Face detection frame (Face Detection AF) |
| 16 Aperture value | |
| 17 EV bar | |

* Indicator 11 (Phase Difference AF frame) is displayed in white during Live View. When the subject is in focus, a green square frame is displayed instead. It turns red when the subject is not in focus. It is not displayed when the focus mode is set to **MF**.

* When 15, 16, and 18 can be changed, ► appears next to the set value.

* Indicators 20 and 21 are displayed when [Autofocus Method] is set to  and the camera detects person's face(s). (Up to 16 face recognition frames are displayed on the monitor.)

Available operations

OK button	When the focusing area is set to  (Select) and [Autofocus Method] is set to  or  , press this button to disable direct key operation of the four-way controller () and enable changing the AF point.
Four-way controller ()	Changes the AF point when the AF point can be changed. Press the OK button to return AF point to the center of the AF frame.
Press and hold OK button	Disables changing the AF point and enables direct key operation of the four-way controller ( .
INFO button	Enlarges the image to 2, 4, or 6 times (when the focus mode is set to MF , enlarges the image to 2, 4, 6, 8, or 10 times). Use the four-way controller () to move the display area, and press the  button to return the display area to the center. (Available only when [Green Button] is assigned to the  button in [Green Button] of the [ Rec. Mode 4] menu (p.197).)

3 Position the subject on the monitor and press the shutter release button halfway.

The autofocus system operates.

When the focus mode is set to **MF**, turn the focusing ring until the subject is clearly visible on the focusing screen.

4 Press the shutter release button fully.

The picture is taken.



- When [AF Mode] is set to **AFC** and [Autofocus Method] is set to or , the camera focuses on the center of the screen when autofocus starts and then automatically tracks the subject when it is in focus.
- Images captured in magnified display are recorded at normal size.
- If [Optical Preview] or [Digital Preview] is assigned to the button in [Green Button] of the [Rec. Mode 4] menu, you can check the depth of field in the viewfinder when you press the button. (p.137)



The status screen and control panel cannot be displayed during Live View. To change the settings, press the **MENU** button and change them in each menu.

You can record movies using Live View.

Changing the Movie Settings

You can record movies with a frame rate (number of frames shot per second) at 25 frames per second (fps), monaural audio, and the file format set to AVI.

- 1 Select **[Movie]** in the **[📷 Rec. Mode 3]** menu and press the four-way controller (▶).

The **[Movie]** screen appears.

- 2 Press the four-way controller (▶), use the four-way controller (▲▼) to select the number of recorded pixels, and press the **OK** button.

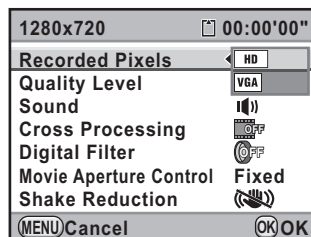

Recorded Pixels	Pixels	Aspect Ratio
HD (default setting)	1280×720	16:9
VGA	640×480	4:3



- 3 Use the four-way controller (▲▼) to select **[Quality Level]** and press the four-way controller (▶).



- 4 Use the four-way controller (▲▼) to select the quality level and press the **OK** button.

Select from ★★★ (Best; default setting), ★★ (Better) and ★ (Good).

When the recorded pixels and quality level are changed, the amount of recordable time at that setting appears at the top right of the screen.

5 Use the four-way controller (▲▼) to select [Sound] and press the four-way controller (▶).

6 Use the four-way controller (▲▼) to select  or  and press the OK button.

	Records sound. (default setting)
	Does not record sound.

7 Change the [Cross Processing] and [Digital Filter] settings as necessary.



For details, refer to p.216 for Cross Processing and p.155 for Digital Filter.



8 Use the four-way controller (▲▼) to select [Movie Aperture Control] and press the four-way controller (▶).

9 Use the four-way controller (▲▼) to select [Fixed] or [Auto] and press the OK button.

Fixed	The movie is recorded at the aperture value set before movie recording starts. (default setting)
Auto	The aperture is controlled automatically. (The aperture value is fixed while recording a movie even if [Auto] is selected.)

10 Use the four-way controller (▲▼) to select [Shake Reduction] and press the four-way controller (▶).

11 Use the four-way controller (▲▼) to select  or  and press the OK button.

	Uses Shake Reduction.
	Does not use Shake Reduction. (default setting)

12 Press the MENU button twice.

The camera is ready to record a movie.

Recording Movies

1 Set the mode dial to .

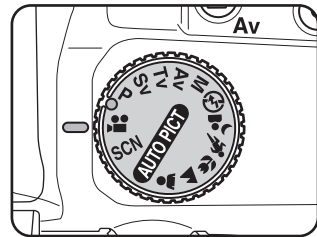



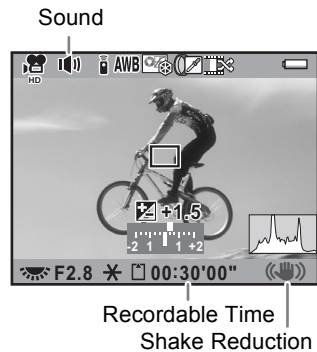





Live View for movie recording is displayed.



Recordable Time
Shake Reduction

Available operations

E-dial	Changes the aperture value when [Movie Aperture Control] is set to [Fixed]. (default setting)
 button	Resets the aperture value when [Green Button] is assigned to the  button in [Green Button] of the [Rec. Mode 4] menu. Displays the setting screen when [Custom Image], [Digital Filter] or [Cross Processing] is assigned to the  button. (p.197)
 Av button + e-dial	Adjusts the EV compensation (± 2 EV).
OK button	When the focusing area is set to  (Select) and [Autofocus Method] is set to  or  , press this button to disable direct key operation of the four-way controller () and enable changing the AF point.
Four-way controller ()	Changes the AF point when the AF point can be changed. Press the OK button to return AF point to the center of the AF frame.

Press and hold OK button	Disables changing the AF point and enables direct key operation of the four-way controller (▲▼◀▶).
INFO button	Enlarges the image to 2, 4, or 6 times (when the focus mode is set to MF , enlarges the image to 2, 4, 6, 8, or 10 times). Use the four-way controller (▲▼◀▶) to move the display area.

2 Position the subject on the monitor and press the shutter release button halfway.

The autofocus system operates.

When the focus mode is set to **MF**, turn the focusing ring until the subject is clearly visible on the focusing screen.

3 Press the shutter release button fully.

Recording of the movie starts.

4 Press the shutter release button again.

Recording stops.



- When [Sound] is set to (On), the camera operation sounds are also recorded. When recording a movie, mount the camera onto a tripod and do not operate the camera while recording.
- When recording a movie, regardless of the AF mode setting, recording starts when the shutter release button is pressed fully even if the subject is not in focus.
- While recording a movie, the autofocus system does not operate.
- The flash is not available.
- When recording movies using image processing, such as Digital Filter, some frames may be omitted from the recorded movie.
- If the internal temperature of the camera becomes high during movie recording, the recording may be terminated to protect the camera circuitry.



- You can record movies continuously up to 4 GB or 25 minutes. When the SD Memory Card is full, recording stops and the movie is saved.
- Live View image in mode is displayed according to the [Live View] setting (p.160) made in the [Rec. Mode 3] menu. However, the histogram and Bright/Dark Area warning are not displayed during movie recording.
- If you intend to shoot continuously for a long period, use of the AC adapter kit K-AC109 (optional) is recommended. (p.50)
- You can also use the optional remote control to record a movie. (p.147)
- EV compensation is also available during movie recording.
- The sensitivity is fixed to [AUTO].

Playing Back Movies

Recorded movies can be played back in Playback mode in the same manner as saved images.

1 Press the button.

The camera switches to Playback mode.

2 Use the four-way controller (◀▶) to choose a movie to play back.

The first frame of the movie is displayed on the monitor.

3 Press the four-way controller (▲).

Movie playback starts.



Available operations

Four-way controller (▲)	Pauses/Resumes playback.
E-dial	Volume control (6 levels)
Four-way controller (▶)	Forwards a frame (during pause).
Press and hold four-way controller (▶)	Fast-forwards playback while pressed.
Four-way controller (◀)	Reverses playback./ Reverses a frame (during pause).
Press and hold four-way controller (◀)	Fast-reverses playback while pressed.
Four-way controller (▼)	Stops playback./ Displays the playback mode palette (when stopped). (p.220)
INFO button	Saves the displayed image as a JPEG file.

When the movie ends, playback stops and the first frame is displayed again.



You can use the optional AV cable I-AVC7 to play back recorded movies on a TV screen or other AV devices. (p.242)

Capturing a Still Picture from a Movie

You can capture a single frame from a movie and save it as a JPEG still picture.

- 1 Press the four-way controller (▲) in Step 3 on p.169 to pause the movie, and display the frame to save as a still picture.



- 2 Press the INFO button.
The save confirmation screen appears.

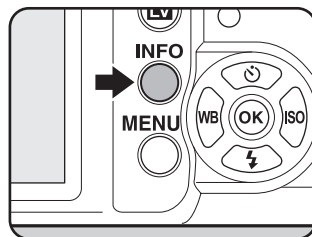





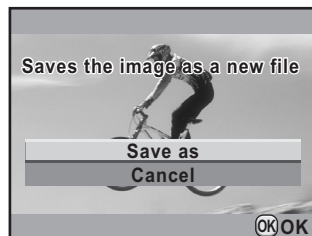



- 3 Use the four-way controller (▲▼) to select [Save as] and press the OK button.

The captured image is saved as a new image.







Editing Movies

Movies can be divided and unwanted segments can be deleted.

- 1 **Press the  button.**
The camera switches to Playback mode.
- 2 **Use the four-way controller () to choose a movie to play back.**
The first frame of the movie is displayed on the monitor.
- 3 **Press the four-way controller () .**
The playback mode palette appears.
- 4 **Use the four-way controller (, , , ) to select  (Movie Editing) and press the OK button.**
The movie editing screen appears.
- 5 **Select point(s) where you want to divide the movie.**
Up to four points can be selected.



Available operations

Four-way controller ()	Plays back/Pauses a movie.
Four-way controller ()	Moves forward 1 second (during pause). Moves to the next dividing point (during playback).
Four-way controller ()	Moves backward 1 second (during pause). Moves to the previous dividing point (during playback).
E-dial	Volume control (6 levels)
 button	Confirms/cancels a dividing point.

6 Press the **UP/** button to delete unwanted segments.

The screen to select segment(s) to delete is displayed.



Available operations

Four-way controller (◀▶)	Moves the selection frame.
OK button	Confirms/cancels a selection of a segment to delete.
MENU button	Exits the screen to select segments to delete.

7 Press the **OK** button.

The save confirmation screen appears.



8 Use the four-way controller (▲▼) to select [Save as] and press the **OK** button.

The movie is divided at the specified points and the unwanted segments are deleted from it. And then the divided movie is saved as separate files and displayed on the screen.

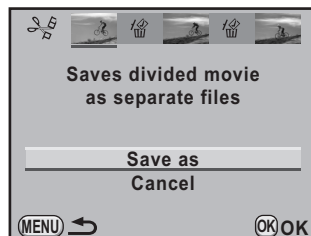

Specify the dividing points in chronological order from the beginning of the movie. When canceling the selected dividing points, cancel each of them in reverse order (from the end of the movie to the beginning). Dividing point(s) cannot be added or canceled while specifying dividing point(s).

5 Using the Flash

This chapter provides details on the built-in flash of the *K-r* and describes how to take pictures with an external flash.

Flash Characteristics in Each Exposure Mode	174
Distance and Aperture when Using the Built-in Flash	178
Lens Compatibility with the Built-in Flash	179
Using an External Flash (Optional)	180

Flash Characteristics in Each Exposure Mode

Using the Flash in Tv (Shutter Priority) Mode

- When taking a moving subject, you can use the flash to change the blur effect.
- Any desired shutter speed of 1/180 sec. or slower can be set for taking a flash photograph.
- The aperture value automatically changes according to the ambient brightness.
- The shutter speed is locked at 1/180 sec. when a lens other than a DA, DA L, D FA, FA J, FA, F or A lens is used.

Using the Flash in Av (Aperture Priority) Mode

- You can set the desired aperture value to take a flash photograph when you want to change the depth of field or shoot a subject farther away.
- The shutter speed automatically changes with the ambient brightness.
- The shutter speed shifts automatically anywhere from 1/180 sec. to a slow shutter speed (p.68) that reduces camera shake. The slowest shutter speed depends on the focal length of the lens in use.
- The shutter speed is locked at 1/180 sec. when a lens other than a DA, DA L, D FA, FA J, FA or F lens is used.

Using the Slow-speed Sync

You can use Slow-speed Sync in  (Night Scene Portrait) of Picture mode or Tv (Shutter Priority) mode when shooting portraits with the sunset in the background. Both the portrait and the background are captured beautifully.



- Slow-speed Sync slows the shutter speed. Use the Shake Reduction function or turn off the Shake Reduction function and use a tripod to avoid camera shake. The picture will also blur if the subject moves.
- Slow-speed Sync shooting can also be performed with an external flash.

Using Tv Mode

1 Set the mode dial to Tv.

2 Use the e-dial to set the shutter speed.

The background is not properly exposed if the aperture value is blinking when the shutter speed is set. Adjust the shutter speed so that the aperture value does not blink.

3 Press the  button.

The built-in flash pops up.

4 Take a picture.

Using P/Sv/Av Mode

1 Set the mode dial to P, Sv or Av.

2 Press the  button.

The built-in flash pops up.

3 Press the four-way controller () button.

The [Flash Mode] screen appears.

4 Select  or  and press the OK button.

The shutter speed is set slower to give a proper exposure for the background.

5 Take a picture.

Using M Mode

- 1 Set the mode dial to **M**.
- 2 Set the shutter speed and aperture value to obtain a proper exposure.

Set 1/180 sec. shutter speed or slower.

- 3 Press the **UP/** button.

The built-in flash pops up.

In **M** (Manual) mode, you can raise the built-in flash at any time prior to shooting.

- 4 Take a picture.

Using the Trailing Curtain Sync

Trailing Curtain Sync discharges the flash immediately before the shutter curtain closes. When shooting moving objects with a slow shutter speed, Trailing Curtain Sync and Slow-speed Sync produce different effects depending on when the flash is discharged.



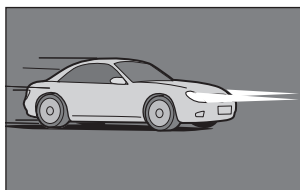

For example, when shooting a moving car with Trailing Curtain Sync, trailing light is captured while the shutter is open and the flash captures the car immediately before the shutter is closed. Therefore, the picture will include a sharp, well-lit car with trailing light behind it.

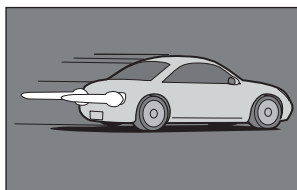

Slow-speed Sync
(Leading Curtain Sync)



Trailing Curtain Sync

- 1** Set the mode dial to **P**, **Sv**, **Tv**, **Av** or **M**.
- 2** Press the four-way controller (▼).
The [Flash Mode] screen appears.
- 3** Select  or  and press the **OK** button.
- 4** Press the UP/ button.
The built-in flash pops up.
- 5** Take a picture.



Trailing Curtain Sync slows the shutter speed. Use the Shake Reduction function or turn off the Shake Reduction function and use a tripod to avoid camera shake.

Distance and Aperture when Using the Built-in Flash

Relationships between the guide number, aperture and distance must be considered when shooting with the flash to obtain a correct exposure. Calculate and adjust the shooting conditions if the flash output is not sufficient.

Sensitivity	Built-in Flash Guide Number	Sensitivity	Built-in Flash Guide Number
ISO 100 *1	Approx. 12	ISO 3200	Approx. 64
ISO 200	Approx. 16	ISO 6400	Approx. 96
ISO 400	Approx. 24	ISO 12800 *1	Approx. 128
ISO 800	Approx. 32	ISO 25600 *1	Approx. 192
ISO 1600	Approx. 48		

*1 This can be used when [3. Expanded Sensitivity] in the [C Custom Setting 1] menu is set to [On].

5

Calculating Shooting Distance from Aperture Value

The following equation calculates the distance of the flash for aperture values.

Maximum flash distance $L1 = \text{Guide number} \div \text{Aperture value}$

Minimum flash distance $L2 = \text{Maximum flash distance} \div 5 *$

* The value 5 used in the formula above is a fixed value which applies only when using the built-in flash alone.

Example)

When the sensitivity is ISO 200 and the aperture value is F4.0

$L1 = 16 \div 4.0 = \text{approx. } 4 \text{ (m)}$

$L2 = 4 \div 5 = \text{approx. } 0.8 \text{ (m)}$

Therefore, the flash can be used in a range of about 0.8 m to 4 m.

However, the built-in flash in this camera cannot be used when the distance is 0.7 m or less. When the flash is used at closer than 0.7 m, it causes vignetting in the picture corners, light is distributed unevenly and a picture may be overexposed.

Calculating Aperture Value from Shooting Distance

The following equation calculates the aperture value for shooting distances.

Aperture value $F = \text{Guide number} \div \text{Shooting distance}$

Example)

When the sensitivity is ISO 200 and the shooting distance is 5 m, the aperture value is:

$F = 16 \div 5 = 3.2$

If the resulting number (3.2, in the above example) is not available as a lens aperture, the smaller number that is closest (2.8, in the above example) is generally used.

Depending on the lens used with the **K-r**, even if a lens without a hood is attached, the use of the built-in flash may not be available or may be limited due to vignetting.

DA, DA L, D FA, FA J, and FA lenses not listed below can be used without problems.

* The following lenses were evaluated without a hood.

Unavailable due to vignetting

Lens Name
DA FISH-EYE 10-17mm F3.5-4.5ED (IF)
DA12-24mm F4ED AL
DA14mm F2.8ED (IF)
FA★300mm F2.8ED (IF)
FA★600mm F4ED (IF)
FA★250-600mm F5.6ED (IF)

Available depending on other factors

Lens Name	Restrictions
F FISH-EYE 17-28mm F3.5-4.5	Vignetting may occur if the focal length is less than 20 mm.
DA16-45mm F4ED AL	When the focal length is less than 28 mm or when the focal length is 28 mm and the shooting distance is 1 m or less, vignetting may occur.
DA★16-50mm F2.8ED AL (IF) SDM	When the focal length is 20 mm or less or when the focal length is 35 mm and the shooting distance is less than 1.5 m, vignetting may occur.
DA17-70mm F4AL (IF) SDM	When the focal length is less than 24 mm or when the focal length is 24 mm and the shooting distance is 1 m or less, vignetting may occur.
DA18-250mm F3.5-6.3ED AL (IF)	Vignetting may occur if the focal length is less than 35 mm.
FA★28-70mm F2.8AL	Vignetting may occur if the focal length is 28 mm and the shooting distance is less than 1 m.
FA SOFT 28mm F2.8	Built-in flash always discharges fully.
FA SOFT 85mm F2.8	Built-in flash always discharges fully.

Using an External Flash (Optional)

Using an optional external flash AF540FGZ, AF360FGZ, AF200FG or AF160FC enables a variety of flash modes, such as P-TTL auto flash mode, depending on the external flash being used. See the chart below for details.

(✓: Available #: Restricted ×: Not available)

Flash	Built-in Flash	AF540FGZ AF360FGZ	AF200FG AF160FC
Camera Function			
Red-eye reduction flash	✓	✓	✓
Auto flash discharge	✓	✓	✓
After the flash is charged, the camera automatically switches to the flash sync speed.	✓	✓	✓
Aperture value is automatically set in P mode and Tv mode.	✓	✓	✓
P-TTL auto flash	✓ ^{*1}	✓ ^{*1}	✓ ^{*1}
Slow-speed Sync	✓	✓	✓
Flash exposure compensation	✓	✓	✓
AF assist light of external flash	×	✓	×
Trailing Curtain Sync ^{*2}	✓	✓	×
Contrast-control-sync flash mode	# ^{*3}	✓	# ^{*4}
Slave flash	×	✓	×
High-speed flash sync	×	✓	×
Wireless flash	# ^{*4}	✓ ^{*5}	×

*1 Available only when using a DA, DA L, D FA, FA J, FA, F or A lens.

*2 Shutter speed of 1/90 sec. or slower.

*3 When combined with the AF540FGZ or AF360FGZ, 1/3 of the flash discharge can be output by the built-in flash and 2/3 can be output by the external flash.

*4 Available only when combined with the AF540FGZ or AF360FGZ.

*5 Multiple AF540FGZ or AF360FGZ units, or a combination of an AF540FGZ or AF360FGZ unit and the built-in flash is required.



Flashes with reversed polarity (the center contact on the hot shoe is minus) cannot be used due to the risk of damaging the camera and flash.

About the Display Panel for AF360FGZ

The AF360FGZ itself does not have the function to set the FORMAT size to [DIGITAL]. However, when it is used with a SLR Digital Camera, the difference in focal length between a 35 mm camera and the **K-r** is automatically calculated based on the difference in angle of view and is displayed on the panel (when using DA, DA L, D FA, FA J, FA or F lens).

The conversion indicator appears and the FORMAT size indicator disappears when the exposure metering timer of the **K-r** is on (it returns to 35 mm format display when the exposure metering timer is turned off).

Lens Focal Length	85mm /77mm	50mm	35mm	28mm /24mm	20mm	18 mm
Exposure metering timer Off	85mm	70mm	50mm	35mm	28mm	24mm*
Exposure metering timer On	58mm	48mm	34mm	24mm	19mm	16mm*





* Using wide-angle panel

Using P-TTL Auto Mode

You can use [P-TTL Auto] with the AF540FGZ, AF360FGZ, AF200FG or AF160FC flash unit. The flash pre-flashes before the actual flash and confirms the subject (the distance, brightness, contrast, whether it is backlit, etc.) using the camera 16-segment metering sensor. The flash output for the actual flash is adjusted based on the information obtained from the pre-flash, enabling flash photography with more accurate exposure for the subject than with normal TTL auto.

- 1** Remove the cover of the hot shoe and attach the external flash.
- 2** Turn on the camera and the external flash.
- 3** Set the external flash mode to [P-TTL auto].
- 4** Confirm that the external flash is fully charged and then take a picture.



- P-TTL auto is only available with an AF540FGZ, AF360FGZ, AF200FG or AF160FC flash unit.
- The  will light in the viewfinder when the flash is ready (fully charged).
- For details such as operation method and effective distance, please refer to the external flash manual.
- The flash does not discharge if the subject is bright enough when the flash mode is set to ^A or . Therefore, it may not be suitable for daylight-sync shooting.
- Never press the /  button when any external flash unit is attached to the camera. The built-in flash will hit the external flash. If you want to use both at once, set the wireless mode or connect them using the extension cord. (p.187).

Using High-Speed Flash Sync Mode

With the AF540FGZ or AF360FGZ, you can discharge the flash to take a picture at a shutter speed faster than 1/180 second.

5

Using the Flash

- 1 Remove the cover of the hot shoe and attach the external flash (AF540FGZ or AF360FGZ) to the camera.**
- 2 Set the mode dial to Tv or M.**
- 3 Turn on the camera and the external flash.**
- 4 Set the external flash sync mode to HS  (high-speed flash sync).**
- 5 Confirm that the external flash is fully charged and then take a picture.**



- The  will light in the viewfinder when the flash is ready (fully charged).
- High-speed flash sync is available only when the shutter speed is set faster than 1/180 sec.
- High-speed flash sync is not available when the shutter speed is set to **Bulb**.

Using Flash in Wireless Mode

By using two external flashes (AF540FGZ or AF360FGZ) or using the built-in flash with one or more external flashes, you can shoot in P-TTL flash mode without connecting the flash units with a cord.



- Set the power switch of the external flash to WIRELESS.
- Two or more AF540FGZ/AF360FGZ external flashes are required to use high-speed flash sync in wireless mode. This function cannot be used in combination with the built-in flash.
- Set the wireless mode of the external flash not directly connected to the camera to SLAVE.

Setting the Channel for the External Flash

First, set the channel for the external flash unit.

- 1 Set the channel for the external flash unit.**
- 2 Remove the cover of the hot shoe and attach the external flash.**
- 3 Turn on the camera and the external flash, and press the shutter release button halfway.**

The built-in flash is set to the same channel as the external flash unit.



- When set to **w** mode, the channel currently set for the built-in flash is displayed in the viewfinder for 10 seconds.
- Be sure to set all the flashes to the same channel. Refer to the manual of the AF540FGZ or AF360FGZ for details on how to set the channel on the external flash.

Using the Built-in Flash in Wireless Mode

Set the camera to wireless flash mode when using an external flash in combination with the built-in flash.



1 Press the four-way controller (▼).

The [Flash Mode] screen appears.

2 Select and press the OK button.

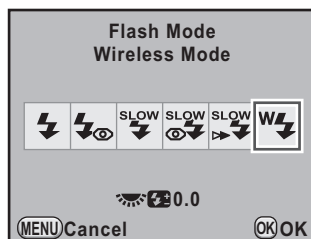
The camera is ready to take a picture.



When the drive mode is set to  (Remote Control (3s delay)) or the lens aperture is not set to the **A** position,  cannot be selected.

Changing the Built-in Flash Discharge Method

You can change the built-in flash discharge method used in wireless mode.

Set in [17. Flash in Wireless Mode] of the [**C** Custom Setting 3] menu (p.90).

1	On	Discharges the built-in flash as a master. (default setting)
2	Off	Discharges the built-in flash as a control flash.



HS  (High-speed flash sync) is not available with the built-in flash.

Wireless Shooting

- Using a Combination of the Built-in Flash and an External Flash Unit

- 1 Remove the external flash unit after the channel is set on the camera, and place it at the desired location.
- 2 Set the camera flash to ^w⚡ mode, and press the ⚡UP/🗑 button.
- 3 Confirm that both flashes are fully charged and then take a picture.

- Using a Combination of External Flash Units

- 1 Set the wireless mode of the external flash directly connected to the camera to [MASTER] or [CONTROL].

MASTER	Sets the camera to discharge both the flash directly connected to the camera and the wireless flash unit.
CONTROL	Sets the camera to discharge the flash directly connected to the camera as a control flash only, not as the main flash.

- 2 On the wireless remote flash unit, set the wireless flash mode to [SLAVE] and set the channel to the same channel as the flash directly connected to the camera. Then, place it at the desired location.
- 3 Confirm that both flashes are fully charged and then take a picture.



- The Shake Reduction function is automatically turned off in wireless mode.
- When using multiple AF540FGZ/AF360FGZ external flashes and performing high-speed flash sync shooting in wireless mode, set the flash directly connected to the camera to high-speed flash sync mode.

Wireless Flash Control (P-TTL Flash Mode)

When using external flash units (AF540FGZ or AF360FGZ) for wireless shooting, the following information is exchanged between the flash units before the flash is discharged.

Press the shutter release button fully.



- 1 The flash directly connected to the camera emits a control flash (relays the flash mode of the camera).
- 2 The wireless remote flash emits a test flash (relays confirmation of subject).
- 3 The flash directly connected to the camera emits a control flash (relays flash output to the wireless remote flash).
 - * The flash directly connected to the camera will emit a control flash one more time after this to relay the flash duration time when HS \downarrow (High-speed sync) is set.
- 4 The wireless remote flash discharges.



When the wireless mode of the external flash directly connected to the camera is set to [MASTER] or [17. Flash in Wireless Mode] (p.184) is set to [On] for the built-in flash, all the flashes will discharge simultaneously.

Red-Eye Reduction

As with the built-in flash, the red-eye reduction function is available with an external flash. However, this function may not be available on some flashes or may have restrictions for usage conditions. Refer to the chart on p.180.



- The red-eye reduction function works by discharging the flash twice even when only an external flash is used. (p.79)
- If the red-eye reduction function of the built-in flash is used when the external flash is set as the slave unit or with the wireless function, the pre-flash for red-eye reduction will trigger the external flash. Do not use the red-eye reduction function when using a slave unit.

Trailing Curtain Sync

When using the built-in flash with an external flash (AF540FGZ or AF360FGZ) that is set to the Trailing Curtain Sync mode, the built-in flash will also use this mode. Confirm that both flash units are fully charged before shooting.

Connecting an External Flash with an Extension Cord

When using the built-in flash with an external flash that does not have a wireless flash mode function such as AF200FG, attach the Hot Shoe Adapter F_G (optional) to the camera hot shoe and an Off-Camera Shoe Adapter F (optional) to the bottom of the external flash, and connect these with the Extension Cord F5P (optional) as shown in the illustration below. The Off-Camera Shoe Adapter F can be mounted to your tripod using the tripod screw.

Only a P-TTL auto flash can be used in combination with the built-in flash.

When combining with the built-in flash

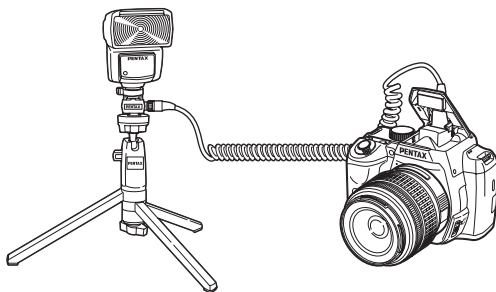

Multiple Flash Shooting Using Extension Cords

You can combine two or more external flashes (AF540FGZ, AF360FGZ or AF200FG) or you can use two or more external flashes in combination with the built-in flash. You can use the extension cord connection terminal on the flash to connect the AF540FGZ. You can connect AF360FGZ or AF200FG units as shown in the illustration below. Connect an external flash and the Hot Shoe Adapter F (optional) to the Off-Camera Shoe Adapter F (optional) and then connect another Off-Camera Shoe Adapter F with external flash using the Extension Cord F5P (optional). Refer to the manual of the external flash for details.

When combining two or more external flashes

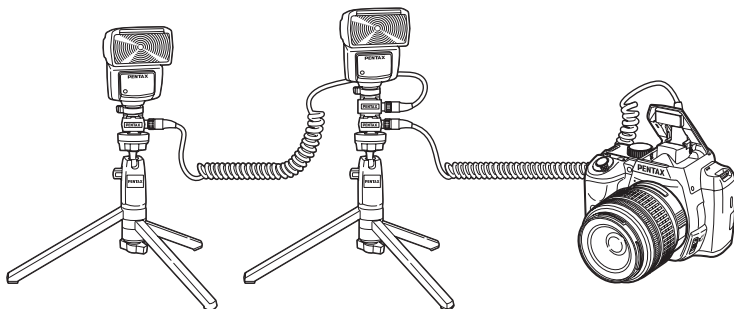

- Do not combine with accessories that have a different number of contacts such as a Hot Shoe Grip as a malfunction may occur.
- Combining with flashes from other manufacturers may cause equipment breakdown. We recommend using the AF540FGZ, AF360FGZ or AF200FG.



When using multiple external flashes or using an external flash with the built-in flash, P-TTL is used for flash control.

Contrast-Control-Sync Flash

Combining two or more external flashes (AF540FGZ, AF360FGZ or AF200FG) or using an external flash in combination with the built-in flash allows multiple flash photography (contrast-control-sync flash photography). This is based on the difference between the amounts of light discharged from multiple units.



- The AF200FG must be combined with the AF540FGZ or AF360FGZ.
- Do not combine with accessories that have a different number of contacts, such as a Hot Shoe Grip, as a malfunction may occur.
- Combining with flashes from other manufacturers may cause equipment breakdown. We recommend using the AF540FGZ, AF360FGZ or AF200FG.

1 Connect the external flash to the camera indirectly.

Refer to p.187.

2 Set the sync mode for the external flash to contrast-control-sync mode.

3 Set the mode dial to P, Sv, Tv, Av or M.

4 Confirm that both the external flash and built-in flash are fully charged and then take a picture.



- When using two or more external flashes and the contrast-control-sync mode is set on the external master flash unit, the flash output ratio is 2 (master unit) : 1 (slave units). When an external flash is used in combination with the built-in flash, the flash output ratio is 2 (external flash) : 1 (built-in flash).
- When using multiple external flashes or using an external flash with the built-in flash, P-TTL is used for flash control.

Memo

6 Shooting Settings

This chapter describes how to set the save format for pictures taken and other settings.

Setting a File Format	192
Setting the Green Button Function	197
Setting the White Balance	200
Correcting Images	207
Setting the Image Finishing Tone	213

Setting the JPEG Recorded Pixels

You can select the number of recorded pixels from **12M**, **10M**, **6M** and **2M**. The more pixels there are, the larger the picture and the bigger the file size. The file size will also vary according to the [JPEG Quality] setting. The default setting is **12M**.

Recorded Pixels	Pixels	Paper Size
12M	4288×2848	14"×17" / A2 paper
10M	3936×2624	10"×12" / A3 paper
6M	3072×2048	8"×10" / A4 paper
2M	1728×1152	5"×7" / A5 paper

The paper sizes above are references for optimal printing by recorded pixels. The quality of the captured photo or printed picture depends on the quality level, exposure control, resolution of the printer and a variety of other factors.

1 Press the **INFO** button in the status screen.

The control panel appears.

Press the **INFO** button when the status screen is not displayed.

2 Use the four-way controller (▲▼◀▶) to select [JPEG Recorded Pixels] and press the **OK** button.

The [JPEG Recorded Pixels] screen appears.

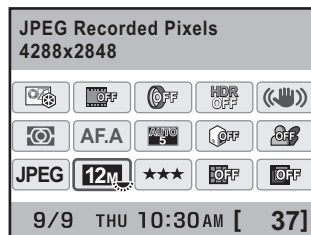

3 Use the four-way controller (◀▶) to select the number of recorded pixels.

When the number of recorded pixels is changed, the number of recordable images appears at the top right of the screen.

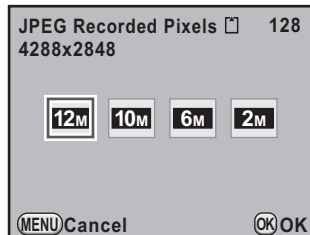

4 Press the OK button.

The camera returns to the control panel.



You can also change the setting from the [📷 Rec. Mode 1] menu (p.87).

Setting the JPEG Quality Level

You can set the image quality level (compression ratio). The file size will also vary according to the [JPEG Recorded Pixels] setting. The default setting is ★★★ (Best).

★★★ Best	↑ Images will be clearer but file size will be larger. ↓ Images will be grainier but file size will be smaller.
★★ Better	
★ Good	

1 Press the INFO button in the status screen.

The control panel appears.

Press the **INFO** button when the status screen is not displayed.

- 2** Use the four-way controller (▲▼◀▶) to select [JPEG Quality] and press the OK button.

The [JPEG Quality] screen appears.

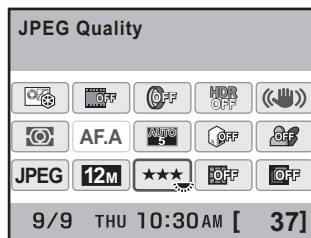

- 3** Use the four-way controller (◀▶) to select a quality level.

When the quality level is changed, the number of recordable images at that quality level appears at the top right of the screen.

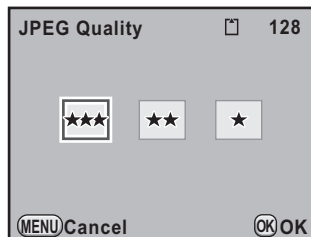

- 4** Press the OK button.



The camera returns to the control panel.



You can also change the setting from the [📷 Rec. Mode 1] menu (p.87).

Setting the File Format

You can set the format of image files.

JPEG	Captures images in JPEG format (default setting). You can change the number of recorded pixels in [JPEG Recorded Pixels], and the image quality level in [JPEG Quality].
RAW	RAW format is a CMOS sensor output format saved without processing. Effects of White Balance, Custom Image and Color Space are not applied to the captured images, but they are saved as actual original information. When you perform the development process by using RAW Development function (p.259), or using the provided software (PENTAX Digital Camera Utility 4) after transferring RAW data to a computer, you can create JPEG images with these effects.
RAW+	Images are saved in both RAW and JPEG formats. When [One Push File Format] is assigned to the  button, you can press the  button to temporarily change the file format and save an image in both file formats. (p.198)



When Digital Filter, HDR Capture or Cross Processing is set, the file format is fixed to [JPEG] and cannot be changed. To change the file format, turn these functions off.

1 Press the **INFO** button in the status screen.

The control panel appears.

Press the **INFO** button when the status screen is not displayed.

2 Use the four-way controller (▲▼◀▶) to select [File Format] and press the **OK** button.

The [File Format] screen appears.

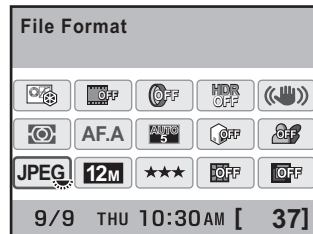

3 Use the four-way controller (◀▶) to select a file format.

When the file format is changed, the number of recordable images appears at the top right of the screen.

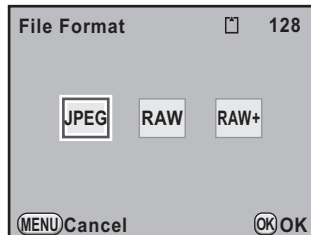

4 Press the OK button.

The camera returns to the control panel.



- You can also change the setting from the [📷 Rec. Mode 1] menu (p.87).
- The file format is fixed to [JPEG] when the capture mode is set to [⏸] (Stage Lighting), [🌙] (Night Snap) or [🌃] (Night Scene HDR) of [SCN] (Scene) mode.

Setting the RAW File Format

You can select PEF or DNG format in [RAW File Format] of the [📷 Rec. Mode 4] menu (p.88) when capturing images in RAW format.

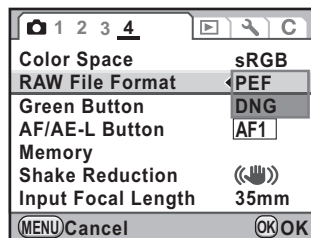

PEF	PENTAX's original RAW file format (default setting)
DNG	General-purpose, publicly available RAW file format designed by Adobe Systems

You can assign one of the following functions to the  button and access the function by simply pressing the button while shooting.

Green Button	Resets the values being adjusted. (default setting)
Custom Image	Sets the Custom Image settings. (p.213)
Optical Preview	Displays the Optical Preview. (p.139)
Digital Preview	Displays the Digital Preview. (p.140)
Digital Filter	Sets the Digital Filter. (p.155)
Cross Processing	Sets the Cross Processing. (p.216)
One Push File Format	Temporarily changes the file format. Simultaneously saves an image in both JPEG and RAW format, regardless of the [File Format] setting. You can set whether to apply the setting to only one image or not, and select the file format when the  button is pressed. (p.198)

- 1 Select [Green Button] in the [📷 Rec. Mode 4] menu and press the four-way controller (▶).**

The [Green Button] screen appears.

- 2 Press the four-way controller (▶).**

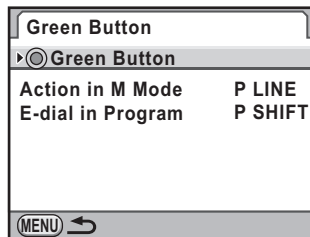

- 3** Use the four-way controller (▲▼) to select a function to assign to the **⊙** button, and press the **OK** button.

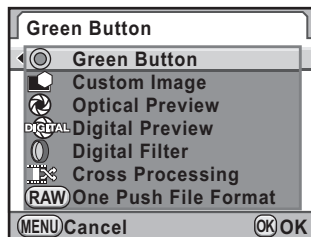

- 4** Press the **MENU** button twice.

The screen that was displayed before selecting the menu appears again.

Setting the One Push File Format

When [One Push File Format] is assigned to the **⊙** button, specify the function settings.

- 1** Select [One Push File Format] in Step 3 of “Setting the Green Button Function”.
- 2** Use the four-way controller (▲▼) to select [Cancel after 1 shot].
- 3** Use the four-way controller (◀▶) to select or .

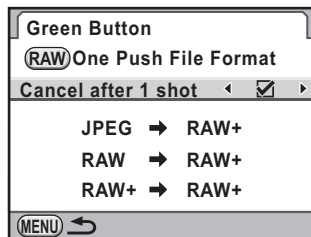

<input checked="" type="checkbox"/>	The recording format returns to the original file format after a picture is taken. (default setting)
<input type="checkbox"/>	The setting is canceled when the following operations are performed. <ul style="list-style-type: none"> - the ⊙ button is pressed again - the ▶ button or MENU button is pressed - the main switch is turned off - the mode dial is turned

4 Use the four-way controller (▲▼) to choose a file format.

The left side is the [File Format] setting and the right side is the file format when the **○** button is pressed.

5 Press the four-way controller (▶), and use the four-way controller (▲▼) to select a file format when the **○** button is pressed.

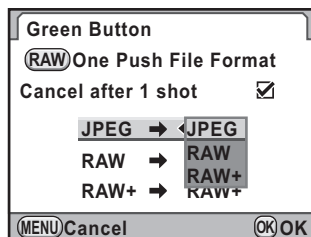







6 Press the OK button.

7 Press the MENU button twice.

The screen that was displayed before selecting the menu appears again.

White balance is a function for adjusting the color of an image so that white objects appear white. Set the white balance if you are not satisfied with the color balance of pictures taken with white balance set to **AWB** (Auto), or to intentionally apply a creative effect to your images.

Item	Settings	Color Temperature *1
AWB Auto	Automatically adjusts the white balance. (default setting)	Approx. 4,000 to 8,000K
 Daylight	For use when taking pictures in sunlight.	Approx. 5,200K
 Shade	For use when taking pictures in the shade. It reduces the bluish color tones in a picture.	Approx. 8,000K
 Cloudy	For use when taking pictures on cloudy days.	Approx. 6,000K
 Fluorescent Light	For use when taking pictures under fluorescent lighting. Select the type of fluorescent light. D Fluorescent Light Daylight Color N Fluorescent Light Daylight White W Fluorescent Light Cool White L Fluorescent Light Warm White	Approx. 6,500K Approx. 5,000K Approx. 4,200K Approx. 3,000K
 Tungsten Light	For use when taking pictures under light bulbs or other tungsten light. It reduces the reddish color tones in a picture.	Approx. 2,850K
 Flash	For use when taking pictures using the built-in flash.	Approx. 5,400K
CTE *2	Use this to keep and strengthen the color tone of the light source in the image.	—
 Manual	Use this to manually adjust the white balance according to the lighting so that white objects appear as a natural white.	—

*1 The color temperatures (K) shown above are all estimates. These do not indicate precise colors.

*2 CTE= Color Temperature Enhancement



White balance is fixed to **AWB** when the capture mode is set to Picture mode or **SCN** (Scene) mode, or when Cross Processing is set.

1 Set the mode dial to **P**, **Sv**, **Tv**, **Av**, or **M**.

2 Press the four-way controller (◀) in Capture mode.

The [White Balance] screen appears.

After the power is turned on, the last image taken is displayed in the background.

3 Press the four-way controller (▲▼) to select the white balance.

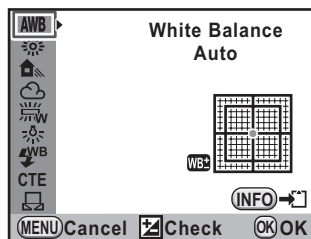

Available operations

<input checked="" type="checkbox"/> Av button	Uses Digital Preview to preview the background image with the setting applied.
INFO button	Saves the background image. Select [Save as] and press the OK button.

4 Press the **OK** button.

The camera is ready to take a picture.



Because the light source changes when a flash discharges, you can set the white balance for when the flash discharges. Select [Auto White Balance], [Unchanged] or [Flash] in [12. WB When Using Flash] of the [C Custom Setting 2] menu (p.89).

2 Under the light to measure the white balance, fully display a white sheet of paper in the viewfinder or select a white area as the subject.

3 Press the shutter release button fully.

Set the focus mode lever to **MF** when the shutter cannot be released. The screen to select the measuring range is displayed.

4 Use the e-dial to select the entire screen or spot area for the measuring range.

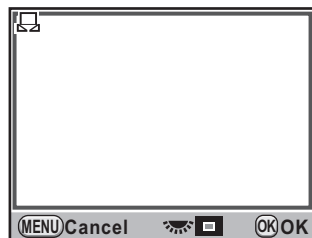

5 When a spot area is selected, use the four-way controller (▲▼◀▶) to move the frame to the position you want to measure.

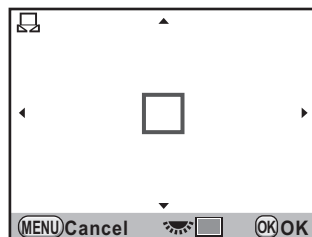

6 Press the OK button.

The white balance fine-tuning screen appears when measuring is completed. Adjust the white balance as necessary. (p.204)

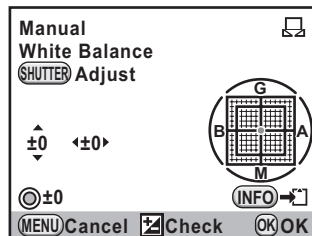

7 Press the OK button.

The camera returns to the [White Balance] screen.

8 Press the OK button.

The camera is ready to take a picture.



- No image is recorded when the shutter release button is pressed to adjust the white balance.
- The message [The operation could not be completed correctly] appears when measuring is unsuccessful. Press the **OK** button while displayed to remeasure the white balance.
- If a picture is extremely overexposed or underexposed, the white balance may not be adjusted. In this case, adjust exposure to the correct amount level before adjusting the white balance.
- When the mode dial is set to (Movie), the white balance cannot be measured. Adjust the white balance in any capture mode other than before recording a movie.

Fine-Tuning the White Balance

You can fine-tune the white balance setting.

1 Perform the desired setting in Step 3 on p.201.

2 Press the four-way controller (▶).

The fine-tuning screen appears.

3 Fine-tune the white balance.

Seven levels (225 patterns) are available on the G-M and B-A axes.

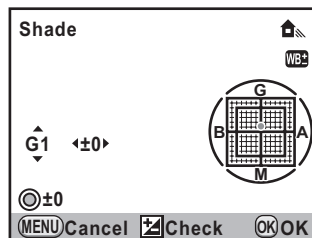

Available operations

Four-way controller (▲▼)	Adjusts the tone of the colors between green (G) and magenta (M).
Four-way controller (◀▶)	Adjusts the tone of the colors between blue (B) and amber (A).
◎ button	Resets the adjustment value. (Available only when [Green Button] is assigned to ◎ button in [Green Button] of the [Rec. Mode 4] menu (p.197).)

4 Press the OK button.

The camera returns to the [White Balance] screen.

5 Press the OK button.

The camera is ready to take a picture.



When set to , the white balance can also be measured by pressing the shutter release button fully (except while recording a movie).

Setting the Color Space

You can select a color space to use.

sRGB	Sets to sRGB color space. (default setting)
AdobeRGB	Sets to AdobeRGB color space.

Set [Color Space] in the [ Rec. Mode 4] menu (p.88).

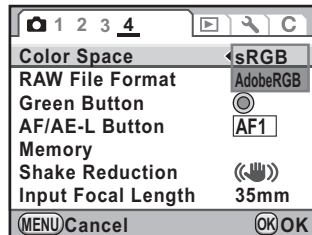

The file naming system changes depending on the color space setting as shown below.

For sRGB: IMGpxxxx.JPG

For AdobeRGB: _IGPxxxx.JPG

“xxxx” indicates the file number. This is displayed as a four-digit sequential number. (p.280)

Color Space

Color ranges for various input/output devices, such as digital cameras, monitors, and printers, differ. This color range is called the Color Space.

To recreate different color spaces in different devices, standard color spaces have been proposed. This camera supports sRGB and AdobeRGB.

sRGB is mainly used for devices such as a computer.

AdobeRGB covers a wider range of color than sRGB and is used for occupational uses such as industrial printing.

An image created in AdobeRGB may appear lighter than an image created in sRGB when output from an sRGB compatible device.

The camera and lens properties can be automatically adjusted for when taking pictures.

Adjusting Brightness

Adjusts the brightness and reduces the occurrence of overexposed and underexposed areas.

Highlight Correction

Expands the dynamic range and enables a more ample gradation expression by the CMOS sensor and reduces the occurrence of overexposed areas.

1 Press the **INFO** button in the status screen.

The control panel appears.

Press the **INFO** button when the status screen is not displayed.

2 Use the four-way controller (▲▼◀▶) to select [**Highlight Correction**] and press the **OK** button.

The [**Highlight Correction**] screen appears.

3 Use the four-way controller (◀▶) to select [**Off**] or [**On**].

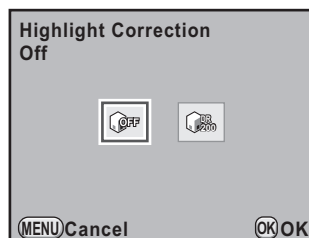

4 Press the **OK** button.

The camera returns to the control panel.



- When [Highlight Correction] is set to [On], the minimum sensitivity is set to ISO 400. If [3. Expanded Sensitivity] in the [C Custom Setting 1] menu (p.89) is set to [On], the sensitivity is set to ISO 200.
- [Highlight Correction] is fixed to [On] when the capture mode is set to (Stage Lighting) or (Night Snap) of **SCN** (Scene) mode.

Shadow Correction

Expands the dynamic range and enables a more ample gradation expression by the CMOS sensor and reduces the occurrence of underexposed areas.

1 Press the **INFO** button in the status screen.

The control panel appears.

Press the **INFO** button when the status screen is not displayed.

2 Use the four-way controller (**▲ ▼ ◀ ▶**) to select [Shadow Correction] and press the **OK** button.

The [Shadow Correction] screen appears.

3 Use the four-way controller (**◀ ▶**) to select [Off], [Low], [Medium] or [High].

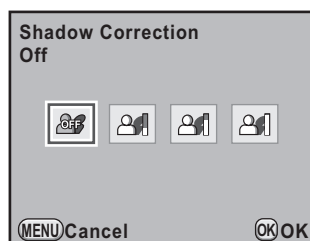

4 Press the **OK** button.

The camera returns to the control panel.



You can also set Highlight Correction and Shadow Correction in [D-Range Setting] of the [Rec. Mode 3] menu (p.88).

HDR Capture

Enables capturing images at high dynamic range. Takes three images (-3EV underexposed, standard (proper exposure) and +3EV overexposed) to create a single composite image with them.



- HDR Capture is not available in the following situations.
 - when the file format is set to [RAW] or [RAW+] (fixed to [JPEG])
 - when the shutter speed is set to **Bulb**
- When HDR Capture is set, the following functions are not available.
 - Continuous Shooting, Exposure Bracketing, Interval Shooting or Multi-exposure
 - Flash modes other than (Flash Off)
 - Digital Filter or Cross Processing (The function selected last is used)
- During HDR Capture, multiple images are combined together to create a single image, so it will take time to save an image.

1 Press the **INFO** button in the status screen.

The control panel appears.

Press the **INFO** button when the status screen is not displayed.

2 Use the four-way controller (, , ,) to select [HDR Capture] and press the **OK** button.

The [HDR Capture] screen appears.

3 Use the four-way controller (,) to select [Off], [Auto], [Standard], [Strong 1], [Strong 2] or [Strong 3].

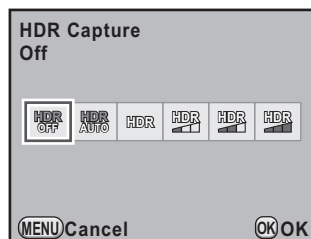

4 Press the **OK** button.

The camera returns to the control panel.



- During HDR Capture, pressing the **MENU** button while an image is being saved cancels the process and saves the image as a standard image.
- HDR Capture is fixed to [Auto] and [Auto Align] is set to (On) when the capture mode is set to (Night Scene HDR) or **SCN** (Scene) mode.
- You can set the [HDR Capture] setting from the [📷 Rec. Mode 2] menu (p.87). If you use the menu, you can also set the [Auto Align] setting.

<input type="checkbox"/>	Does not use Shake Reduction regardless of the Shake Reduction setting. (default setting)
<input checked="" type="checkbox"/>	Turns Shake Reduction on or off according to the Shake Reduction setting.

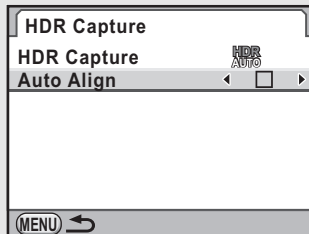

- When both [Shake Reduction] and [Auto Align] are set to on, be careful of the following points.
 - Make sure to hold the camera firmly so that the composition of the picture does not change while the three images are taken. If there is a great difference of the composition between three images, [Auto Align] may not be possible.
 - Images taken with HDR Capture are susceptible to camera shake and blur. Be sure to set a higher shutter speed and a higher ISO sensitivity.
 - When the ISO sensitivity is set to AUTO, the sensitivity can be raised more easily than normal.
 - [Auto Align] may not be possible for lenses that have a focal length exceeding 100 mm.
 - When the entire subject is checkered or has a uniform surface, [Auto Align] may not be possible.

Lens Correction

Reduces distortions and lateral chromatic aberrations occurring due to lens properties.

● Distortion

Distortion is the phenomenon in which the center of the image appears inflated (barrel distortion) or the center of the image appears pinched (pincushion distortion). Distortion occurs more easily when using a zoom lens or a small diameter lens, and straight walls or the horizon in the image appear curved.

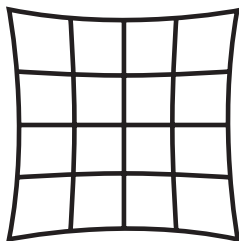

Pincushion distortion

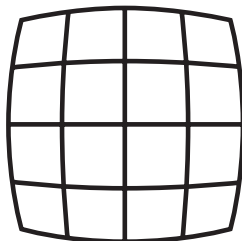

Barrel distortion

● Lateral chromatic aberration

Lateral chromatic aberration is the phenomenon in which the magnification of the image varies according to the colors (wavelengths of light) when a picture was taken, and may cause a blurred image. Chromatic aberration occurs more easily at shorter focal lengths.

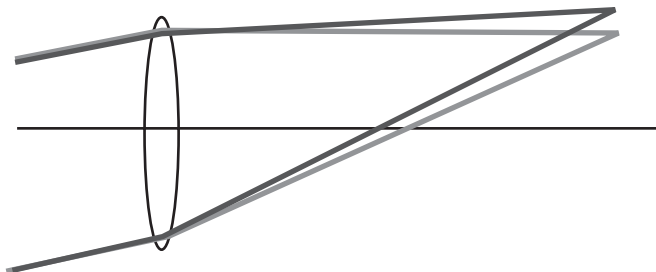



- Corrections can only be made when using DA, DA L, D FA or some FA lenses (p.312). [Distortion Correction] and [Lat-Chromatic-Ab Adj] cannot be selected when an incompatible lens is attached.
- [Distortion Correction] is disabled when using a DA FISH-EYE 10-17mm.
- The Lens Correction function is disabled when using an accessory such as a close-up ring or rear converter that is attached between the camera and the lens.
- The shooting speed for continuous shooting may be slower when the Lens Correction function is activated.
- The effects of the Lens Correction function may be barely noticeable in some cases due to the shooting conditions or other factors.

1 Press the **INFO** button in the status screen.

The control panel appears.

Press the **INFO** button when the status screen is not displayed.

2 Use the four-way controller (▲▼◀▶) to select [Distortion Correction] or [Lat-Chromatic-Ab Adj] and press the **OK** button.

The [Distortion Correction] or [Lat-Chromatic-Ab Adj] screen appears.

3 Use the four-way controller (◀▶) to select [Off] or [On].

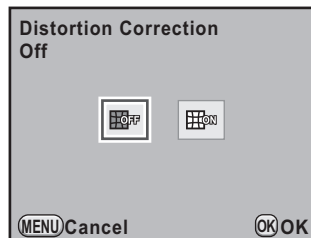

4 Press the **OK** button.

The camera returns to the control panel.



- When a compatible lens is attached and the file format is set to [RAW] or [RAW+], the correction information is saved as a RAW file parameter and you can select [On] or [Off] when developing the RAW images. (p.262)
- You can also set [Distortion Correction] and [Lat-Chromatic-Ab Adj] in [Lens Correction] of the [📷 Rec. Mode 3] menu (p.88).

Setting Custom Image

You can set the image finishing tone before shooting when the capture mode is set to **P** (Program), **Sv** (Sensitivity Priority), **Tv** (Shutter Priority), **Av** (Aperture Priority) or **M** (Manual).

Select from the following nine modes for the image finishing tone: Bright (default setting), Natural, Portrait, Landscape, Vibrant, Muted, Bleach Bypass, Reversal Film and Monochrome. You can adjust the following parameters for Image Tone.

Parameter	Settings	Setting Values
Saturation	Sets the color saturation. <ul style="list-style-type: none"> Not available when [Reversal Film] or [Monochrome] is selected. 	-4 to +4
Hue	Sets the color. <ul style="list-style-type: none"> Not available when [Bleach Bypass], [Reversal Film] or [Monochrome] is selected. 	-4 to +4
High/Low Key Adj	Changes the brightness of the image. <ul style="list-style-type: none"> Not available when [Reversal Film] is selected. 	-4 to +4
Contrast	Sets the image contrast. <ul style="list-style-type: none"> Not available when [Reversal Film] is selected. 	-4 to +4
Sharpness	Sets the sharpness of the image outlines. You can switch to [Fine Sharpness] which makes image outlines even thinner and sharper. Not available when the capture mode is set to  (Movie).	-4 to +4
Filter Effect	Changes the contrast to appear as if a B&W color filter was used. Set the filter color. <ul style="list-style-type: none"> Available only when [Monochrome] is selected. 	None/Green/Yellow/Orange/Red/Magenta/Blue/Cyan/Infrared Filter
Toning	Sets a color tone for [Bleach Bypass]. Sets the level for cold tone adjustment (- direction) and warm tone adjustment (+ direction) for [Monochrome]. <ul style="list-style-type: none"> Available only when [Bleach Bypass] or [Monochrome] is selected. 	Bleach Bypass: Off/ Green/Yellow/ Orange/Red/ Magenta/Purple/Blue/ Cyan Monochrome: -4 to +4



When Cross Processing is set, the image finishing tone is fixed to [Bright] and the parameters cannot be changed.

1 Press the **INFO** button in the status screen.

The control panel appears.

Press the **INFO** button when the status screen is not displayed.

2 Use the four way controller (▲▼◀▶) to select [**Custom Image**] and press the **OK** button.

The screen to select a custom image appears.

After the power is turned on, the last image taken is displayed in the background.

3 Use the four-way controller (◀▶) to select an image finishing tone.

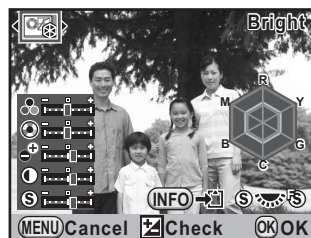

4 Use the four-way controller (▲▼) to choose a parameter you want to change.

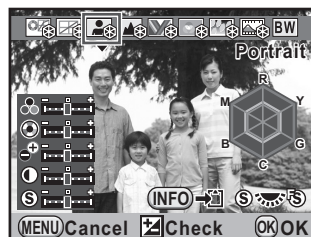

5 Use the four-way controller (◀▶) to change the setting.

The background image changes according to the settings.

You can visually check the saturation and hue with the radar chart.

Available operations

E-dial	Switches between [Sharpness] and [Fine Sharpness]. When set to [Fine Sharpness], image outlines can be captured with more detail.
⊙ button	Resets the set value. (Available only when [Green Button] is assigned to the ⊙ button in [Green Button] of the [📷 Rec. Mode 4] menu (p.197).)
📷 Av button	Uses Digital Preview to preview the background image with the setting applied.
INFO button	Saves the background image. Select [Save as] and press the OK button. (Not available during Live View.)

6 Press the OK button.

The camera returns to the control panel.



You can also change the settings from the [📷 Rec. Mode 1] menu (p.87).

Setting Cross Processing

Cross processing is the procedure of deliberately processing a film in the wrong type of chemicals to create an image with different colors and contrast. This camera features digital cross processing, which is done internally.



- Cross Processing is not available in the following situations.
 - when the capture mode is set to (Night Scene HDR) of **SCN** (Scene) mode
 - when the file format is set to [RAW] or [RAW+] (fixed to [JPEG])
- When Cross Processing is set, the following functions are not available.
 - Multi-exposure
 - HDR Capture (The function selected last is used)
 - Changing the settings of White Balance and Custom Image



Set the mode dial to (Movie) when using Cross Processing for movies.

6

1 Press the **INFO** button in the status screen.

The control panel appears.

Press the **INFO** button when the status screen is not displayed.

Set in [Movie] of the [Rec. Mode 3] menu when the capture mode is set to (Movie). (p.165)

2 Use the four-way controller (▲▼◀▶) to select [**Cross Processing**] and press the **OK** button.

The [Cross Processing] screen appears.

3 Use the four-way controller (▲▼◀▶) to select [**Off**], [**Preset 1-3**], [**Random**] or [**Favorite 1-3**].

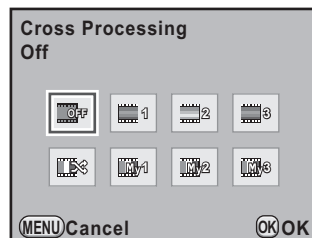

4 Press the **OK** button.

The camera returns to the control panel.



You can also change the setting from the [📷 Rec. Mode 2] menu (p.87).

Saving the Cross Processing Setting of a Captured Image

The outcome of cross processing varies each time a picture is taken. If you are able to take a cross processed image that you like, you can save the Cross Processing settings used in that image. A total of 3 Cross Processing settings can be saved for still pictures and movies.



To save Cross Processing setting for movies, set from [Movie] in the [📷 Rec. Mode 3] menu with the mode dial set to 📷 (Movie).

1 Select [Cross Processing] in the [📷 Rec. Mode 2] menu and press the four-way controller (▶).

The [Cross Processing] screen appears.

2 Use the four-way controller (▲▼) to select [Save Settings] and press the four-way controller (▶).

The camera will search for cross processed images starting from the most recent image taken. (An hourglass icon is displayed while searching.) When a cross processed image is found, the screen to save the settings appears. If there are no cross processed images, the message [No cross processed image] appears.

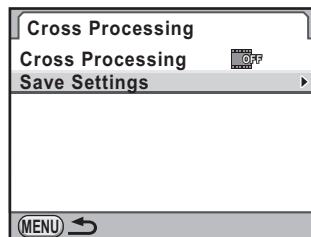

3 Use the e-dial to select a cross processed image.

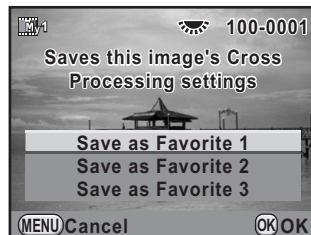

-
- 4** Use the four-way controller (▲▼) to select [Save as Favorite 1], [Save as Favorite 2] or [Save as Favorite 3] and press the **OK** button.

The settings for the selected image are saved to [Favorite 1 - 3].

- 5** Press the **MENU** button twice to finish saving.

7 Playback Functions

This chapter describes how to use the various playback functions in Playback mode.

Playback Functions Operation	220
Setting the Playback Display Method	222
Enlarging Images	223
Displaying Multiple Images	224
Playing Back Images Continuously	232
Rotating Images	235
Deleting Multiple Images	236
Protecting Images from Deletion (Protect)	240
Connecting the Camera to an AV Device	242
Exchanging Image Data with Other Devices ...	244

Make settings related to playing back images in the playback mode palette or [▶ Playback] menu.







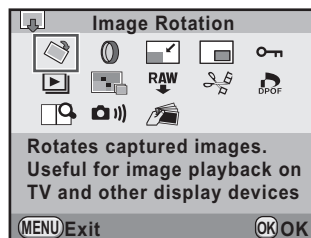
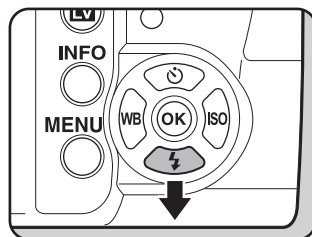

For details on how to use the menus, see “Using the Menu” (p.37).

Playback Mode Palette Setting Items

Press the four-way controller (▼) in Playback mode to display the playback mode palette. You can display the playback mode palette even when a movie is paused.



Item	Function	Page
◇ Image Rotation *1	Rotates images.	p.235
⦿ Digital Filter *1	Changes the color tone of images, adds softening and slimming effects, or adjusts the brightness.	p.253
▣ Resize *1 *2	Changes the number of recorded pixels and quality level of the captured image and saves it as a new file.	p.250
⦿ Cropping *1	Cuts out only the desired area of the picture and saves it as a new image.	p.251
⦿ Protect	Protects images from being accidentally erased.	p.240
▶ Slideshow	Plays back the images one after another.	p.233

Item	Function	Page
 Index	Joins a number of images together and creates a new image with them.	p.229
 RAW Development * ¹	Converts RAW images to JPEG format.	p.259
 Movie Editing * ³	Divides a movie and extracts segments from it.	p.171
 DPOF * ¹ * ²	Sets the DPOF settings.	p.285
 Image Comparison * ¹	Displays two images side-by-side.	p.228
 IrSimple	Sends or receives image data via infrared transmission.	p.244
 Dueling Images	Images are squared off with those of other K-r cameras in this dueling game.	p.246

*¹ This cannot be performed when a movie is displayed.

*² This cannot be performed when a RAW image is displayed.

*³ This can be performed only when a movie is displayed.

Playback Menu Setting Items

You can perform the following settings in the [ Playback] menu.

Press the **MENU** button in Playback mode to display the [ Playback 1] menu.

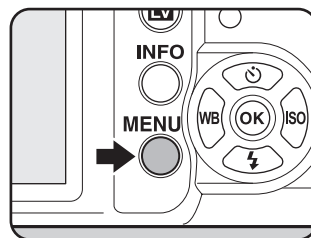

Menu	Item	Function	Page
	Slideshow	Plays back the images one after another. You can set how images will be displayed in the slideshow.	p.232
	Quick Zoom	Sets the initial magnification when enlarging images.	p.222
	Bright/Dark Area	Sets whether or not to display the Bright/Dark Area warning during playback.	
	Auto Image Rotation	Sets whether to rotate images shot with the camera held vertically when playing back.	p.244
	IrSimple	Sets infrared transmission settings and sends or receives data via infrared transmission.	
	Delete All Images	You can delete all saved images at once.	

Setting the Playback Display Method

You can set the initial magnification when enlarging images, whether to display the Bright/Dark Area warning, and whether to automatically rotate images that are shot with the camera held vertically in Playback mode.

1 Select [Quick Zoom] in the [▶] Playback 1] menu and press the four-way controller (▶).

2 Use the four-way controller (▲▼) to select the magnification and press the OK button.

Select from [Off] (default setting), [×2], [×4], [×8] or [×16].

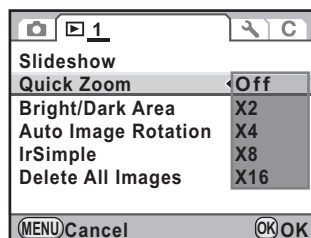

3 Use the four-way controller (▲▼) to select [Bright/Dark Area], and use the four-way controller (◀▶) to select or .

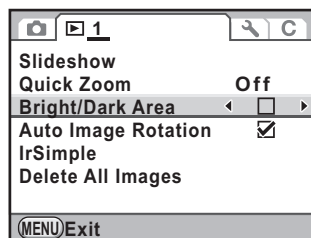

4 Use the four-way controller (▲▼) to select [Auto Image Rotation], and use the four-way controller (◀▶) to select or .

<input checked="" type="checkbox"/>	During playback, the image is automatically rotated based on the rotation information when [18. Saving Rotation Info] in the [C Custom Setting 3] menu (p.90) is set to [On]. (default setting)
<input type="checkbox"/>	The image is not automatically rotated during playback.

5 Press the MENU button.

The screen that was displayed before selecting the menu appears again.

Images can be magnified up to 16 times in Playback mode.

- 1 Use the four-way controller (◀▶) to select an image in Playback mode.

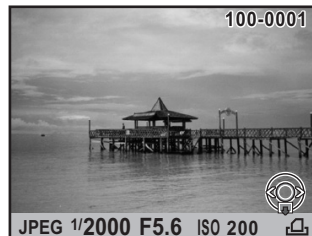

- 2 Turn the e-dial to the right (toward Q).

The image enlarges at each click (1.2 times to 16 times).



Available operations

Four-way controller (▲▼◀▶)	Moves the area to enlarge.
E-dial to the right (Q)	Enlarges the image (up to 16 times).
E-dial to the left (Q)	Reduces the image (up to 1.2 times*).
OK button	Returns to the original size.
INFO button	Switches information display On/Off.

* The default setting for the first click (minimum magnification) is 1.2 times. You can change this in [Quick Zoom] of the [Playback 1] menu. (p.222)



- You can enlarge the image by following the same procedure during Instant Review (p.71), Digital Preview (p.140) or Live View (p.163).
- The initial full display of vertical images is displayed with a magnification of 0.675 times that of horizontal images, therefore, magnification at the first click starts at 1.0 times.

Multi-image Display Screen

You can display 4, 9, 16, 36 or 81 thumbnail images on the monitor at the same time. The default setting is nine image-display.

- 1 Turn the e-dial to the left (toward ) in Playback mode.

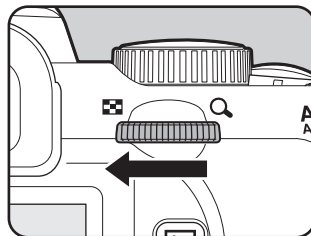

The multi-image display screen appears.

Up to nine thumbnail images will be displayed at once.

Selection frame

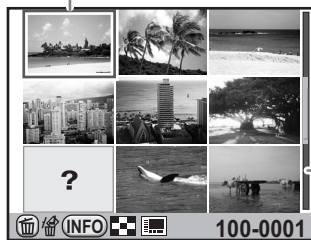

Scroll bar

Available operations

Four-way controller (▲▼◀▶) Moves the selection frame

INFO button Displays the [Multi-Img Display Setting] screen. Use the four-way controller (◀▶) to select the number of images to display at the same time.



(Display Type cannot be selected when developing multiple RAW images (p.260).)

UP/Trash button Selects multiple images and deletes them. (p.236)

2 Press the OK button.

A full screen display of the selected image appears.



Icons such as and are not displayed with thumbnail images for 81-image display.

Displaying Images by Folder

Images will be grouped and displayed by folder in which they are saved.

1 In the multi-image display screen, turn the e-dial to the left (toward) again.

The folder display screen appears.

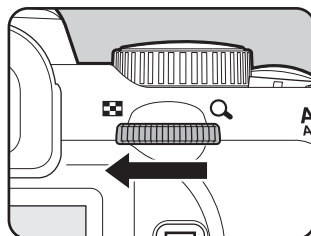

- 2** Select the folder you want to display.

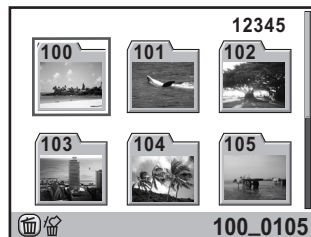

Available operations

Four-way controller (▲▼◀▶)	Moves the selection frame.
⚡UP/🗑️ button	Deletes the selected folder and all the images in it. (p.238)

- 3** Press the **OK** button.

The multi-image display screen for the selected folder appears.

Displaying Images by Shooting Date (Calendar Display)

7

Images will be grouped and displayed by the shooting date.

- 1** In the multi-image display screen, press the **INFO** button.

The [Multi-Img Display Setting] screen appears.

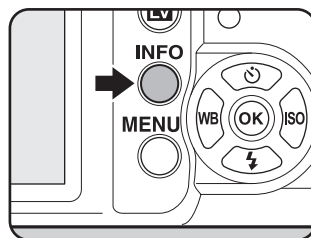

2 Press the INFO button again.



The calendar display screen appears. Only the dates when pictures were taken are displayed.

Number of images shot on this date



Shooting date Thumbnail

Available operations

Four-way controller (▲▼)	Selects a shooting date.
Four-way controller (◀▶)	Selects an image taken on the selected shooting date.
E-dial to the right (Q)	Displays the selected image. Turn to the left (☒) to return to the calendar display.
INFO button	The camera returns to the multi-image display screen.
⚡UP/🗑️ button	Deletes selected images.

3 Press the OK button.

A full screen display of the selected image appears.

Comparing Images

You can display two images side-by-side.

1 Press the four-way controller (▼) in Playback mode.

The playback mode palette appears.

2 Use the four-way controller (▲▼◀▶) to select (Image Comparison) and press the OK button.

The last image displayed will be displayed twice side-by-side.

3 Select two images you want to compare using the e-dial and compare them at left and right.



Available operations

OK button	Moves the selection frame to the right image, both images, and left image each time the button is pressed.
Four-way controller (▲▼◀▶)	Moves the area to enlarge. When the selection frame is placed on both images, you can manipulate both images at the same time.
⊙ button	Returns a position of the enlarged display area to the center.
E-dial	When the selection frame is placed on the left or right image, the previous or next image is displayed. When the selection frames are placed on both images, you can enlarge or reduce both images simultaneously in the same magnification.
INFO button	Switches information display On/Off.
 button	When the selection frame is placed on the left or right image, the selected image is deleted.

4 Press the MENU button.

The camera returns to the normal playback mode.

Joining Multiple Images (Index)

Join a number of images together and display them as an index print. You can also save the displayed index print as a new image. You can select the images to include in the index print and have them randomly-arranged.

1 Press the four-way controller (▼) in Playback mode.







The playback mode palette appears.

2 Use the four-way controller (▲▼◀▶) to select (Index) and press the OK button.

The [Index] screen appears.

3 Press the four-way controller (▶).

4 Use the four-way controller (▲▼) to select a layout and press the OK button.

You can select  (Thumbnail),  (Square),  (Random1),  (Random2),  (Random3) or  (Bubble).

Images are displayed according to the file number (from the smallest number) for , and are displayed in random order for other layouts.

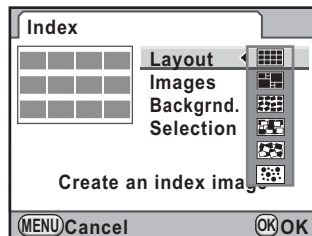

5 Use the four-way controller (▲▼) to select [Images] and press the four-way controller (▶).

6 Use the four-way controller (▲▼) to select the number of images and press the OK button.

You can select 12, 24 or 36 images.

When the number of saved images is smaller than the number selected, empty spaces will appear when [Layout] is set to  and some images may be duplicated for other layouts.

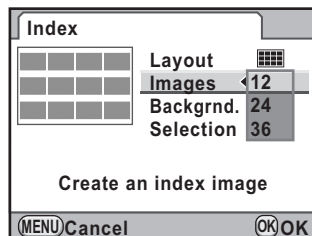

7 Use the four-way controller (▲▼) to select [Backgrnd.] and press the four-way controller (▶).

8 Use the four-way controller (▲▼) to select the background color and press the OK button.

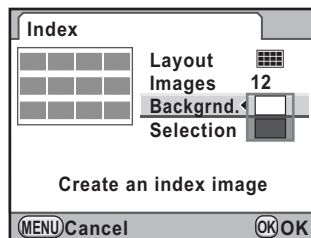

You can select a white or black background.

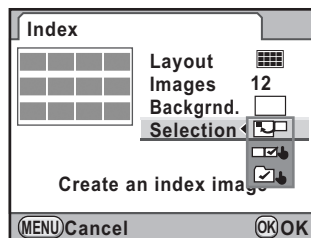

9 Use the four-way controller (▲▼) to select [Selection] and press the four-way controller (▶).

10 Use the four-way controller (▲▼) to select a type of image selection and press the OK button.



 All images	Picks images automatically from all of the images saved.
<input type="checkbox"/>  Manual	Individually select images you want to include in the index. Continue by selecting [Select image(s)] and select the individual images.
<input checked="" type="checkbox"/>  Folder name	Picks images automatically from the folder selected. Continue by selecting [Select a folder] and select the folder.

11 Use the four-way controller (▲▼) to select [Create an index image] and press the OK button.

The index image is created and a confirmation screen appears.

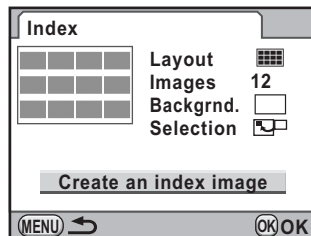

- 12** Use the four-way controller (▲▼) to select [Save] or [Reshuffle] and press the OK button.

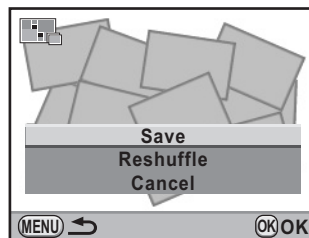

Save	The index image is saved as a [6M] and ★★★ file.
Reshuffle	Reselects the images to be included in the index and displays a new index image. However, if [Thumbnail] is selected for [Layout], this item is not displayed.

After the index image is saved, the camera returns to Playback mode and the index image is displayed.



Processing may take a while when creating an index image.

You can play back all images saved on your SD Memory Card successively in the slideshow.

Setting the Slideshow Display

Sets how images will be displayed during the Slideshow.

- 1** Select [Slideshow] in the [▶] Playback 1] menu and press the four-way controller (▶).

The screen to make the slideshow settings appears.

- 2** Use the four-way controller (▲ ▼) to select an item you want to change.

The following items can be changed.

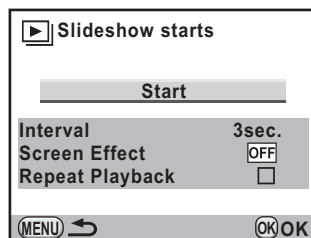

Item	Description	Setting
Interval	Select an image display interval.	3sec. (default setting)/ 5sec./10sec./30sec.
Screen Effect	Select a transition effect when the next image is displayed.	Off (default setting)/Fade/ Wipe/Stripe
Repeat Playback	Set whether to start the slideshow again from the beginning after the last image is displayed.	<input type="checkbox"/> (default setting)/ <input checked="" type="checkbox"/>

- 3** Press the four-way controller (▶) and use the four-way controller (▲▼) to change the setting and press the OK button.

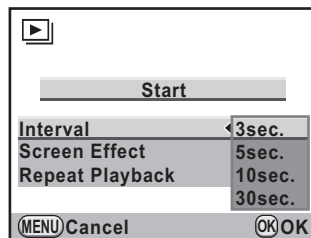

Starting the Slideshow

- 1** Select [Start] in Step 2 on p.232 and press the OK button. Or, select  (Slideshow) in the playback mode palette and press the OK button.

The start screen is displayed and the slideshow begins.

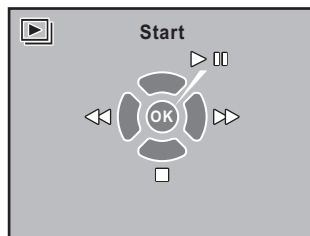

Available operations

OK button	Pauses playback. Press again to resume playback.
Four-way controller (◀)	Shows the previous image.
Four-way controller (▶)	Shows the next image.
Four-way controller (▼)	Stops playback.

2 Stop the slideshow.

Slideshow ends when one of the following operations is performed during playback or pause.

- the four-way controller (▼) is pressed *1
- the  button is pressed *1
- the **MENU** button is pressed *1
- the shutter release button is pressed halfway or fully *2
- the mode dial is turned *2
- the **AF/AE-L** button is pressed *2

*1 After slideshow ends, the camera switches to normal Playback mode.

*2 After slideshow ends, the camera switches to Capture mode.



For movies, only the first frame is displayed and then the next image is displayed after the set interval has elapsed. To play a movie during a slideshow, press the **OK** button while the first frame is displayed. After the movie has finished playing, the slideshow will resume.

You can rotate an image counterclockwise in 90° increments at a time and save the rotated image. The image rotation information is saved with the image and during playback it will be displayed in portrait orientation.



- When [18. Saving Rotation Info] in the [C Custom Setting 3] menu (p.90) is set to [Off], the image rotation information is not saved when shooting.
- When [Auto Image Rotation] (p.222) in the [▶ Playback 1] menu is set to (On), the image with rotation information is automatically rotated during playback.



You cannot change the image rotation information in the following conditions.

- when the image is protected
- when the image rotation information is not saved with the image
- when [Auto Image Rotation] (p.222) in the [▶ Playback 1] menu is set to (Off)

1 Select the image you want to rotate in Playback mode.

2 Press the four-way controller (▼).

The playback mode palette appears.

3 Use the four-way controller (▲▼◀▶) to select  (Image Rotation) and press the OK button.

The selected image is rotated in 90° increments and the four thumbnail images are displayed.

4 Use the four-way controller (▲▼◀▶) to select a desired rotation direction and press the OK button.

The image rotation information is saved.

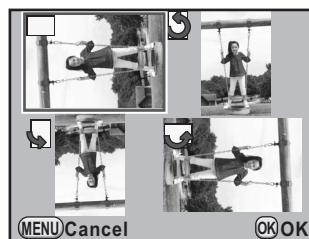

Deleting Selected Images

You can delete multiple images in the multi-image display at once.



Deleted images cannot be restored.



- Protected images cannot be deleted.
- You can select up to 100 images at a time.

- 1 Turn the e-dial to the left (toward ) in Playback mode.**

The multi-image display screen appears.

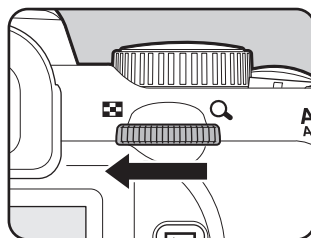

- 2 Press the  button.**

The screen to select the images to delete is displayed.

The screen temporarily changes to 36-image display when [Multi-Img Display Setting] (p.224) is set to 81-image display.

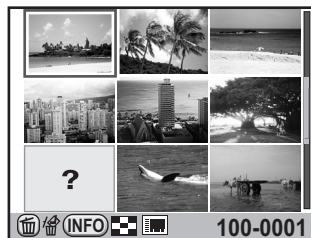

3 Select the images to delete.



Available operations

Four-way controller (▲▼◀▶) Moves the selection frame

OK button Adds and selects an image. Press again to return to . Protected images (🔒) cannot be selected.

E-dial Displays a full screen display of the image selected with the selection frame. When the image is displayed full screen, press the four-way controller (◀▶) to display the previous or next image.

4 Press the **UP**/ button.

The delete confirmation screen appears.

5 Press the four-way controller (▲) to select **[Select & Delete]**.

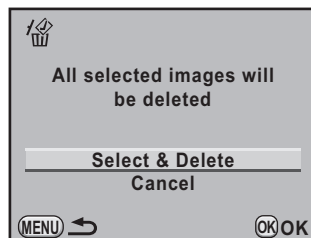

6 Press the **OK** button.

The selected images are deleted.





Deleting a Folder

You can delete a selected folder and all the images in it.

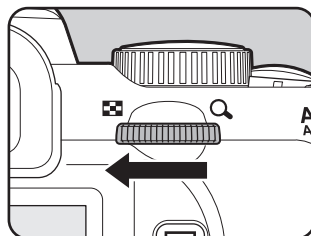
- 1 Turn the e-dial two clicks to the left (toward ) in Playback mode.

The folder display screen appears.



- 2 Use the four-way controller (, , , ) to select a folder to delete and press the  button.

The delete folder confirmation screen appears.

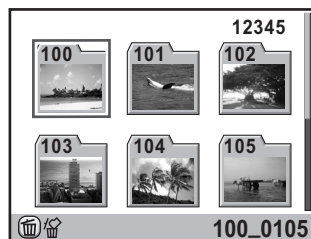

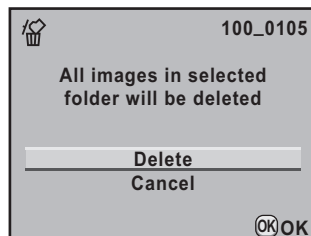

- 3 Press the four-way controller () to select [Delete].



- 4 Press the **OK** button.

The selected folder and all images in it are deleted.

The confirmation screen appears when there are protected images. Use the four-way controller (, ) to select [Delete All] or [Leave All] and press the **OK** button.

When [Delete All] is selected, protected images are also deleted.

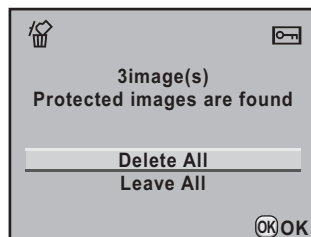

Deleting All Images

You can delete all saved images at once.



Deleted images cannot be restored.

- 1 Select [Delete All Images] in the [▶ Playback 1] menu and press the four-way controller (▶).**

The confirmation screen for deleting all images is displayed.

- 2 Press the four-way controller (▲) to select [Delete All Images].**

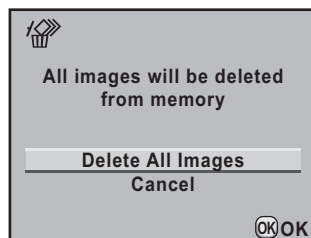

- 3 Press the OK button.**

All images are deleted.

The confirmation screen appears when there are protected images. Use the four-way controller (▲▼) to select [Delete All] or [Leave All] and press the **OK** button.

When [Delete All] is selected, protected images are also deleted.



Protecting Images from Deletion (Protect)

You can protect images from being accidentally deleted.



Even protected images are deleted if the inserted SD Memory Card is formatted.

Protecting a Single Image

- 1 Press the four-way controller (▼) in Playback mode.**

The playback mode palette appears.

- 2 Use the four-way controller (▲▼◀▶) to select  (Protect) and press the OK button.**

The screen to select the protection setting method is displayed.

- 3 Use the four-way controller (▲▼) to select [Single Image] and press the OK button.**



- 4 Use the four-way controller (◀▶) to select an image to protect.**

- 5 Press the four-way controller (▲) to select [Protect].**

Select [Unprotect] to cancel the protection of the image.



6 Press the OK button.

The image is protected and the  icon appears at the top right of the screen.

Repeat Steps 4 to 6 to protect other images.

7 Press the MENU button.

The camera returns to Playback mode.

Protecting All Images

1 Select [All Images] in Step 3 on p.240 and press the OK button.

2 Press the four-way controller (▲) to select [Protect] and press the OK button.

All images saved on the SD Memory Card are protected.

Select [Unprotect] to cancel the protection of all images.



Connecting the Camera to an AV Device

You can connect the camera to a TV or other device with a video input terminal and play back images. Use the optional AV cable I-AVC7.

- 1** Turn the AV device and camera off.
- 2** Open the terminal cover, face the arrow on the AV cable toward the ▲ mark on the camera, and connect the cable to the PC/AV terminal.

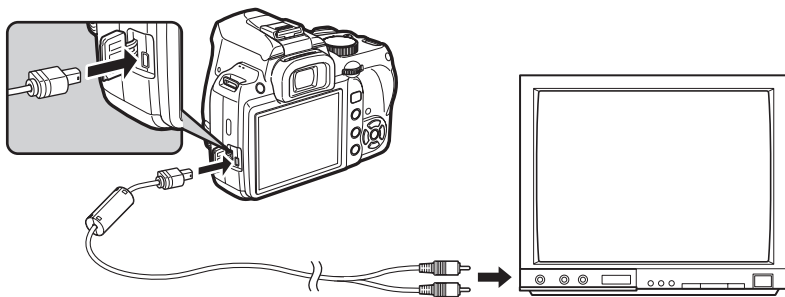

- 3** Connect the other end of the AV cable to the video input terminal on the AV device.
- 4** Turn the AV device and camera on.

The camera turns on in video mode, and the camera information is displayed on the screen of the connected AV device.



- If you intend to use the camera continuously for a long period, use of the AC adapter kit K-AC109 (optional) is recommended. (p.50)
- For an AV device with multiple video input terminals, check the operating manual of the AV device, and select a suitable video input terminal for connecting the camera.
- You cannot adjust the volume on the camera while the camera is connected to the AV device. Adjust the volume on the AV device.

Selecting the Video Output Format

When the hometown is set at the time of initial setting (p.60), the video output format is set in accordance with that region. Depending on the country or region, images may fail to be played back with the set video output format. If this happens, change the video output format setting.

1 Select [Video Out] in the [Set-up 2] menu and press the four-way controller (▶).

2 Use the four-way controller (▲▼) to select [NTSC] or [PAL] and press the OK button.

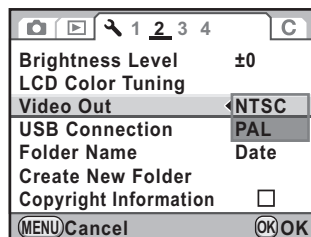

3 Press the MENU button.

The video output format is set.



The video output format differs depending on the region. When you set [Setting the Time] in the World Time setting (p.270) to (Destination), the video output setting changes to the video output format for that city.

Exchanging Image Data with Other Devices

This camera features infrared transmission (IrSimple/IrSS) which allows you to send image data to cell phones and printers, as well as play a dueling game with other **K-r** cameras.

Sending and Receiving Image Data via Infrared Transmission

Send and receive image data to and from other **K-r** cameras and other devices that support infrared transmission, such as cell phones.



- Do not block the infrared port during infrared transmission.
- Infrared transmission may not operate properly if the infrared port is dirty. When necessary, clean the port with a soft dry cloth.
- Data may not be properly transmitted under direct sunlight, directly under a fluorescent light, or near infrared devices.



Only JPEG files can be sent or received.

7

- 1 To send an image via infrared transmission, first select the image in Playback mode.**
- 2 Select [IrSimple] in the [▢ Playback 1] menu and press the four-way controller (▶).**
The [IrSimple] screen appears.
- 3 Use the four-way controller (▲ ▼) to select [Automatic Resizing] and press the four-way controller (▶).**

- 4 Use the four-way controller (▲▼) to select the number of recorded pixels and press the OK button.**

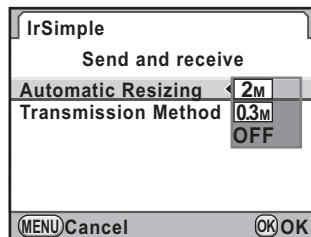

2M	When the number of pixels is larger than 2M, the image is resized to 2M or less. (default setting)
0.3M	When the number of pixels is larger than 0.3M, the image is resized to 0.3M or less.
OFF	The image is not resized.

- 5 Change the [Transmission Method] setting as necessary.**

Standard (IrSimple)	Bi-directionally exchanges information with the other device. (default setting)
IrSS	Transmits information in only one direction and does not accept any answers or requests for resending from the other device. Select this setting when specified by the other device.

- 6 Use the four-way controller (▲▼) to select [Send and receive] and press the OK button.**

The screen to select either to send or receive data appears.

- 7 Bring the infrared ports of your camera and the other device close together.**

Operate infrared transmission on the other device.

Transmission is possible is within a distance of 20 cm, at an emission angle of up to 15 degrees from the center.

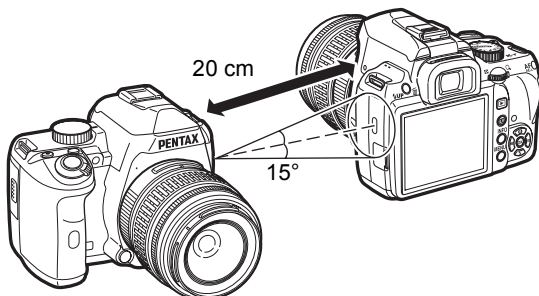

8 Use the four-way controller (▲▼) to select [Send] or [Receive] and press the OK button.

[Sending] or [Receiving] appears and the data is transmitted.

Do not move the camera until data transmission is complete.

When data transmission is successful, [Send complete] or [Receive complete] appears.

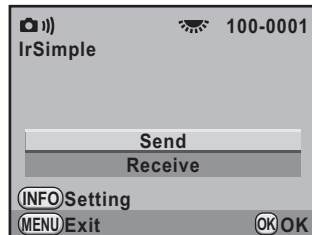

You can transmit data from (IrSimple) in the playback mode palette if the settings for [Automatic Resizing] and [Transmission Method] are not changed.

Playing a Dueling Game using Your Images (Dueling Images)

You can play a game with other **K-r** cameras using infrared transmission.



- Only JPEG and RAW files captured with this camera can be used for Dueling Images.
- Dueling Images uses the IrDA method of infrared transmission regardless of the [IrSimple] setting in the [▶ Playback 1] menu.

1 Press the four-way controller (▼) in Playback mode.

The playback mode palette appears.

2 Use the four-way controller (▲▼◀▶) to select (Dueling Images) and press the OK button.

The image selection screen appears.

3 Use the four-way controller (◀▶) to choose an image to use.



4 Use the four-way controller (▲▼) to select [Accept challenge] or [Issue challenge] and press the OK button.

When your opponent selects [Accept challenge], select [Issue challenge].

[Communication in progress] appears and the data is transmitted.

If the data is transmitted properly, your opponent's image appears in the right side of the [Prepare Your Image] screen.

5 Use the four-way controller (▲▼) to select the order of parameters to use.

Fighting strength is calculated based on the shooting conditions.



6 Use the four-way controller (▲▼) to select [Start] and press the OK button.

After [Communication in progress] appears, the duel starts.

When the duel is over, the result appears.



7 Press the OK button.

The camera returns to the single image display.





- The image sent from the opponent is not saved.
- If you select [Game Score] in Step 3, you can check the number of duels that you have won and lost, and those that ended in a draw. Press the  button in this screen to reset the game score.
- If data transmission is not completed properly or it is interrupted, the message [Unable to establish data communication] appears.

Game Score	
Win	10
Lose	200
Draw	1

 Reset  OK

8 Processing Images

This chapter describes how to process pictures taken and edit RAW images.

Changing the Image Size	250
Processing Images with Digital Filters	253
Developing RAW Images	259

Changes the number of recorded pixels and quality level of the image, and saves the image as a new file.

Changing the Number of Recorded Pixels and Quality Level (Resize)

Changes the number of recorded pixels and quality level of the selected image and saves it as a new image. The number of recorded pixels can be reduced while still obtaining an image with good quality.



- Only JPEG files captured with this camera can be resized.
- You cannot select a larger resolution than that of the original image.
- Images already resized to 0.3M with this camera cannot be resized.

1 Select an image to resize in Playback mode.

2 Press the four-way controller (▼).

The playback mode palette appears.

3 Use the four-way controller (▲▼◀▶) to select  (Resize) and press the OK button.

The screen to select the recorded pixels and quality level appears.

4 Use the four-way controller (◀▶) to select the desired image size.

You can select one of the image sizes starting from one size smaller than that of the original image. The selectable sizes vary according to the original image size and aspect ratio.

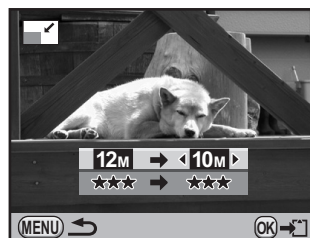

5 Press the four-way controller (▼) and use the four-way controller (◀▶) to select the quality level.

You can select ☆☆☆, ☆☆☆ or ☆.

6 Press the OK button.

The save confirmation screen appears.

7 Use the four-way controller (▲▼) to select [Save as] and press the OK button.

The resized image is saved as a new image.

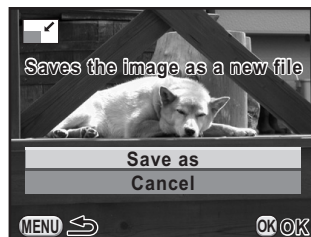

Cutting Out Part of the Image (Cropping)

Cuts out only the desired area of the selected image and saves it as a new image. The aspect ratio can also be changed.



- Only JPEG and RAW files captured with this camera can be cropped.
- Images already resized to 0.2M or 0.3M with this camera cannot be cropped.

1 Select an image to crop in Playback mode.

2 Press the four-way controller (▼).

The playback mode palette appears.

3 Use the four-way controller (▲▼◀▶) to select (Cropping) and press the OK button.

The cropping frame to specify the size and position of the area to crop appears on the screen.

- 4** Specify the size and position of the area to crop by using cropping frame.



Available operations

E-dial	Changes the size of the cropping frame.
Four-way controller (▲▼◀▶)	Moves the cropping frame.
INFO button	Changes the aspect ratio. Select from [3:2], [4:3], [16:9] or [1:1]. The image can also be rotated from -45° to +45° in increments of 1°.

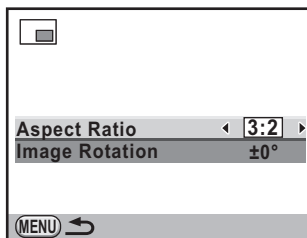

⊙ button	Rotates the cropping frame in 90° increments. ⊙ appears only when the cropping frame can be rotated.
----------	---

- 5** Press the **OK** button.

The save confirmation screen appears.

- 6** Use the four-way controller (▲▼) to select **[Save as]** and press the **OK** button.

The cropped image is saved as a new image.

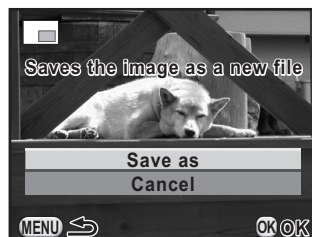

You can edit captured images using digital filters. The following filters are available.

Filter name	Effect	Parameter
Toy Camera	Creates an image that looks as though it was shot with a toy camera.	Shading Level: +1 to +3
		Blur: +1 to +3
		Tone Break: Red/Green/Blue/Yellow
Retro	Creates an image with the look of an old photo.	Toning (B-A): 7 levels
		Frame Composite: None/Thin/Medium/Thick
High Contrast	Enhances the contrast in the image.	+1 to +5
Sketch Filter	Creates an image that looks as though it was drawn with a pencil.	Contrast: Low/Medium/High
		Scratch Effect: OFF/ON
Water Color	Creates an image that looks as though it was painted.	Intensity: +1 to +3
		Saturation: OFF/Low/Medium/High
Pastel	Creates an image that looks as though it was drawn with a crayon.	Weak/Standard/Strong
Posterization	Lessens the tone of the image to create an image that looks as though it was hand-drawn.	+1 to +5
Miniature	Blurs part of the image to create a fake miniature scene.	In-Focus Plane: -3 to +3
		Width: Narrow/Middle/Wide
		Angle: Side/Vertical/Positive Slope/Negative Slope
		Blur: +1 to +3
Base Parameter Adj	Adjusts the parameters to create the desired image.	Brightness: -8 to +8
		Saturation: -3 to +3
		Hue: -3 to +3
		Contrast: -3 to +3
		Sharpness: -3 to +3
Monochrome	Creates a monochrome image such as a black-and-white photo.	Filter Effect: OFF/Red/Green/Blue/Infrared Filter
		Toning (B-A): 7 levels

Filter name	Effect	Parameter
Color	Adds a color filter to the image. Select from 18 filters (6 colors × 3 tones).	Color: Red/Magenta/Blue/Cyan/Green/Yellow
		Color Density: Light/Standard/Dark
Extract Color	Extracts two specific colors and makes the rest of the image black and white.	Extracted Color 1: Red/Magenta/Blue/Cyan/Green/Yellow
		Extractable Range of Color 1: -2 to +2
		Extracted Color 2: Red/Magenta/Blue/Cyan/Green/Yellow/OFF
		Extractable Range of Color 2: -2 to +2
Soft	Creates an image with a soft focus throughout the image.	Soft Focus: +1 to +3
		Shadow Blur: OFF/ON
Starburst	For taking pictures of night scenes or lights reflected on water with a special sparkling look by adding extra glitter to the highlights.	Shape: Cross/Star/Snow Crystal/Heart/Musical Note
		Effect Density: Small/Medium/Large
		Size: Small/Medium/Large
		Angle: 0°/30°/45°/60°
Fish-eye	Creates an image that looks as though it was shot with a fish-eye lens.	Weak/Medium/Strong
Slim	Changes the horizontal and vertical ratio of images.	-8 to +8
HDR	Creates an image that looks like a high dynamic range image.	Weak/Medium/Strong
Custom Filter	Customize and save a filter to your own preferences.	High Contrast: OFF/+1 to +5
		Soft Focus: OFF/+1 to +3
		Tone Break: OFF/Red/Green/Blue/Yellow
		Shading Type: 6 types
		Shading Level: -3 to +3
		Distortion Type: 3 types
		Distortion Level: OFF/Weak/Medium/Strong
		Invert Color: OFF/ON



Only JPEG and RAW files captured with this camera can be edited using the Digital Filter.

Applying the Digital Filter

- 1 Select an image for applying the digital filter in Playback mode.
- 2 Press the four-way controller (▼).
The playback mode palette appears.
- 3 Use the four-way controller (▲▼◀▶) to select 0 (Digital Filter) and press the OK button.
The screen to select a filter appears.

- 4 Use the four-way controller (▲▼◀▶) to select a filter and press the OK button.

After selecting a filter, you can check the effect on the screen.

You can select a different image by turning the e-dial.



- 5 Use the four-way controller (▲▼) to select a parameter and the four-way controller (◀▶) to adjust the value.

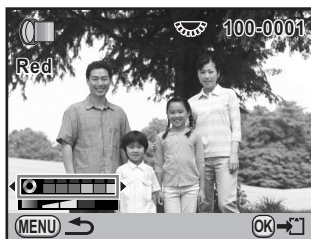

Color Filter



Slim Filter

6 Press the OK button.

The save confirmation screen appears.

7 Use the four-way controller (▲▼) to select [Use filters in combination] or [Save as].

Select [Use filters in combination] when you want to apply additional filters to the same image.



8 Press the OK button.

If [Use filters in combination] was selected, the camera returns to Step 4.
If [Save as] was selected, the filter-processed image is saved as a new image.



Up to 20 filters, including a digital filter used during shooting (p.155), can be combined to the same image.

Recreating Filter Effects

Retrieves the setting of an image with filter effects and apply the same filter effects to other images.

1 Select a filter-processed image in Playback mode.

2 Select **0** (Digital Filter) in the playback mode palette.

- 3 Use the four-way controller (▲▼) to select [Recreating filter effects] and press the OK button.**

The history of the filter set for the selected image appears.



- 4 To check the parameter details, press the INFO button.**

You can check the filter parameters.

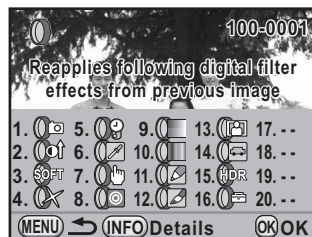

- 5 Press the OK button.**

The image selection screen appears.

- 6 Use the four-way controller (◀▶) to select an image for applying the same filter effects and press the OK button.**

You can only select an image that has not been processed with a filter.

The save confirmation screen appears.



- 7 Use the four-way controller (▲▼) to select [Save as] and press the OK button.**

The filter-processed image is saved as a new image.

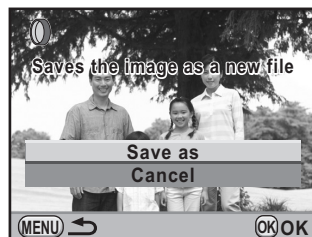

Searching for the Original Image

Searches for and displays the original image prior to digital filter application.

- 1 Select [Searching for the original image] in Step 3 on p.257 and press the OK button.**

The original image prior to digital filter application is retrieved.



If the original image is no longer stored on the SD Memory Card, the message [Original image, prior to digital filter application, is not found] appears.

You can convert captured RAW files into JPEG files.



Only RAW files captured with this camera can be edited. RAW files and JPEG files captured with other cameras cannot be edited on this camera.

Developing One RAW Image

- 1 **Select a RAW image in Playback mode.**
- 2 **Press the four-way controller (▼).**
The playback mode palette appears.
- 3 **Use the four-way controller (▲▼◀▶) to select **RAW** (RAW Development) and press the OK button.**
The screen to select a development method is displayed.
- 4 **Use the four-way controller (▲▼) to select [Developing a Single Image] and press the OK button.**

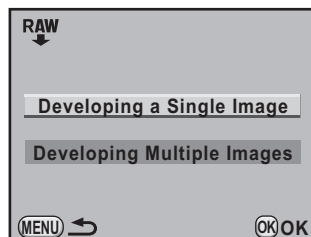

The parameters recorded in the image file appear.

You can select a different image by turning the e-dial.

To specify the parameters before developing, refer to “Specifying the Parameters” (p.262).

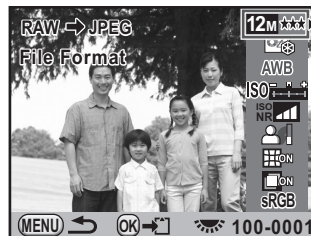

5 Press the OK button.

The save confirmation screen appears.

6 Use the four-way controller (▲▼) to select [Save as] and press the OK button.

The RAW image is developed and saved as a new image.

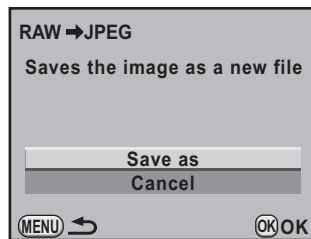
**7 Use the four-way controller (▲▼) to select [Continue] or [Exit].**

Select [Continue] to edit other images.

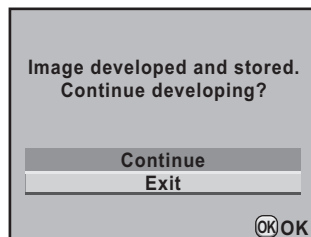
**8 Press the OK button.**

If you select [Continue] in Step 7, the screen for selecting the parameter in Step 4 appears again.

Developing Multiple RAW Images

You can develop multiple RAW images with the same settings.

1 Select [Developing Multiple Images] in Step 4 on p.259 and press the OK button.

The multi-image display screen appears.

Refer to p.224 for details on operations in the multi-image display screen.

2 Use the four-way controller (▲▼◀▶) to select the RAW images to be developed and press the OK button.

3 Press the INFO button.

The development confirmation screen appears.

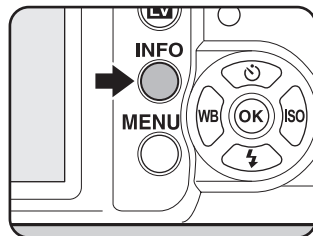

4 Use the four-way controller (▲▼) to select [Develop images as shot] or [Develop images with modified settings].

To change parameters, select [Develop images with modified settings]. For details, refer to “Specifying the Parameters” (p.262).

The screen to select a parameter appears.



5 Use the four-way controller (▲▼◀▶) to set [Recorded Pixels] and [Quality Level].



6 Press the OK button.

The save confirmation screen appears.

7 Use the four-way controller (▲▼) to select [Save as] and press the OK button.

The selected RAW images are developed and saved as new images.

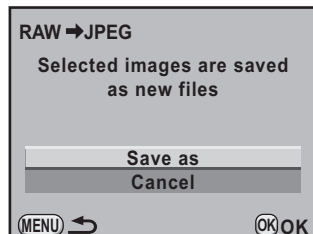

Specifying the Parameters

Specify the parameters for developing RAW images.
The following parameters can be changed.

Parameter	Value	Page
Recorded Pixels	12M (4288×2848)/ 10M (3936×2624)/ 6M (3072×2048)/ 2M (1728×1152)	p.192
Quality Level	★★★ (Best) / ★★ (Better) / ★ (Good)	p.193
Custom Image	Bright/Natural/Portrait/Landscape/Vibrant/ Muted/Bleach Bypass/Reversal Film/ Monochrome	p.213
White Balance *1	AWB (Auto)/☀ (Daylight)/⬆ (Shade)/ ☁ (Cloudy)/☾ D (Fluorescent Light Daylight Color)/☾ N (Fluorescent Light Daylight White)/☾ W (Fluorescent Light Cool White)/ ☾ L (Fluorescent Light Warm White)/ ☀ (Tungsten Light)/⚡ WB (Flash)/ CTE / ☒ (Manual)	p.200
Sensitivity	-2.0 to +2.0	—
High-ISO NR	Auto/Off/Low/Medium/High	p.100
Shadow Correction	Off/Low/Medium/High	p.208
Distortion Correction *2	Off/On	p.211
Lat-Chromatic-Ab Adj *2	Off/On	p.211
Color Space	sRGB/AdobeRGB	p.205

*1 This cannot be set for RAW files taken in Multi-exposure mode.

*2 This can be selected only when a compatible lens is attached. (p.211)

- 1 Press the four-way controller (▲▼) in Step 4 on p.259 to choose the parameter you want to change.

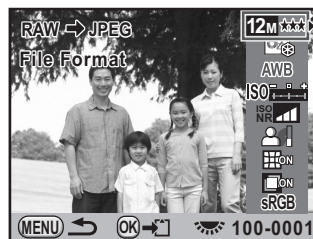

2 Use the four-way controller (◀▶) to change the value.

Use the four-way controller (▶) to display the setting screen for White Balance and Custom Image.



3 Press the OK button.

The save confirmation screen appears.

4 Use the four-way controller (▲▼) to select [Save as] and press the OK button.

The RAW image is developed and saved as a new image.



- You cannot save the background image and use Digital Preview with White Balance and Custom Image.
- When the white balance is set to  (Manual), press the  Av button to display the measuring screen.

Memo

9 Changing Additional Settings

This chapter describes how to change additional settings.

How to Operate the Set-up Menu	266
Formatting an SD Memory Card	268
Setting the Beep, Date and Time, and Display Language	269
Adjusting the Monitor and the Menu Display ..	274
Setting the Folder/File Number	279
Selecting the Power Settings	281
Setting the Photographer Information	283
Setting the DPOF Settings	285
Correcting Defective Pixels in the CMOS Sensor (Pixel Mapping)	287
Selecting Settings to Save in the Camera (Memory)	288



Perform general settings related to the camera in the [ Set-up] menu.





For details on how to use the menus, refer to “Using the Menus” (p.37).

Set-up Menu Setting Items

Perform the following settings in the [ Set-up 1-4] menu.

Press the **MENU** button in Capture/Playback mode and use the four-way controller ( ) or e-dial to display the [ Set-up 1-4] menus.

Menu	Item	Function	Page
 1	Language/言語	Changes the language in which menus and messages appear.	p.273
	Date Adjustment	Sets the date format and time.	p.270
	World Time	Sets the display of the local date and time of the specified city so they can be displayed on the monitor in addition to the present location when traveling overseas.	p.270
	Text Size	Sets the text size of an item selected on the respective menu screens.	p.274
	Beep	Switches the beep tone on/off and changes its volume.	p.269
	Guide Display	Sets whether to display indicators on the monitor.	p.274
	Status Screen	Sets the display color of the status screen and control panel.	p.276
 2	Brightness Level	Changes the brightness of the monitor.	p.277
	LCD Color Tuning	Adjusts the color of the monitor.	p.278
	Video Out	Sets the output format when connecting to an AV device with a video input terminal.	p.243
	USB Connection	Sets the USB connection mode when connecting to a computer.	p.293
	Folder Name	Sets the naming system of the folder for storing images.	p.279

Menu	Item	Function	Page
2	Create New Folder	Creates a new folder on the SD Memory Card.	p.279
	Copyright Information	Sets the photographer and copyright information embedded in Exif.	p.283
3	Auto Power Off	Sets the time until the camera turns off automatically.	p.281
	AA Battery Type	Selects the type of AA batteries used for the camera.	p.282
	Reset	Resets all settings.	p.310
4	Pixel Mapping	Maps out and corrects any defective pixels in the CMOS sensor.	p.287
	Dust Alert	Detects dust adhering to the CMOS sensor.	p.316
	Dust Removal	Cleans the CMOS sensor by shaking it.	p.315
	Sensor Cleaning	Locks the mirror in the up position for cleaning the CMOS sensor with a blower.	p.318
	Format	Formats an SD Memory Card.	p.268

● [2] Set-up 1] menu

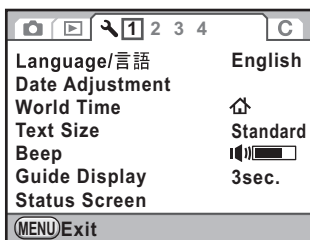

● [3] Set-up 2] menu

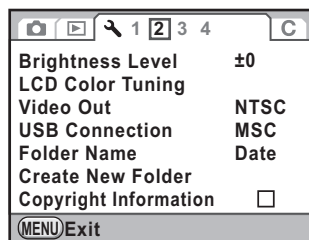

● [3] Set-up 3] menu

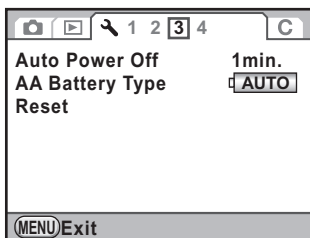

● [4] Set-up 4] menu

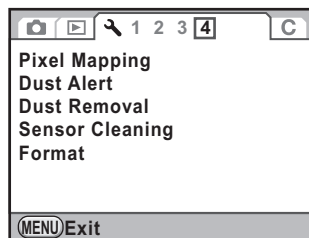

Formatting an SD Memory Card

Use this camera to format (initialize) an SD Memory Card that is unused or has been used on other cameras or digital devices.

Formatting deletes all the data saved on the SD Memory Card.



- Do not remove the SD Memory Card while formatting. The card may be damaged and become unusable.
- Formatting deletes all data, either protected or unprotected. Be aware.

1 Select [Format] in the [Set-up 4] menu and press the four-way controller (▶).

The [Format] screen appears.

2 Press the four-way controller (▲) to select [Format].

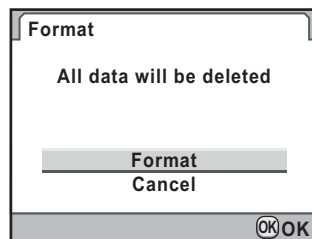

3 Press the OK button.

Formatting starts.

When formatting is completed, the screen that was displayed before selecting the menu appears again.

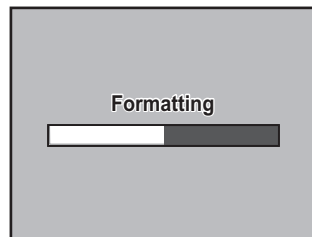

When an SD Memory Card is formatted, the volume label assigned to the card is "K-r". When the **K-r** is connected to a computer, the SD Memory Card is recognized as a removable disk with the name "K-r". (p.294)

Setting the Beep

You can turn the camera operation beep on or off, or change its volume. By default, all available items are set to (On), and the volume level is set to [3]. The following six items can be set.

- In-focus
- AE-L (AE Lock operation sound)
- Self-timer
- Remote Control
- One Push File Format (operation sound when [One Push File Format] is assigned to the  button)
- Press OK for 1 sec. (operation sound when changing AF point is enabled or disabled)

1 Select [Beep] in the [ Set-up 1] menu and press the four-way controller ().

The [Beep 1] screen appears.

2 Press the four-way controller () and use the four-way controller ( ) to adjust the volume.

Select from six levels. When set to 0, you can turn all the beeps off.

3 Use the four-way controller ( ) to select an item.

Turn the e-dial to display the [Beep 2] screen.

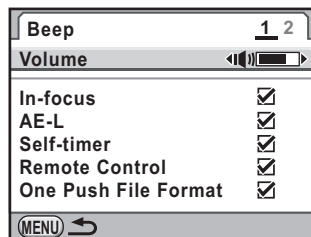

4 Use the four-way controller ( ) to select (On) or (Off).

5 Press the MENU button twice.

The screen that was displayed before selecting the menu appears again.

Changing the Date and Time Display

You can change the initial date and time settings, and set their display formats. Choose [mm/dd/yy], [dd/mm/yy] or [yy/mm/dd] for the date display format, and [12h] (12-hour display) or [24h] (24-hour display) for the time display format.

Set in [Date Adjustment] of the [↖ Set-up 1] menu (p.266).

☰ Setting the Date and Time (p.64)

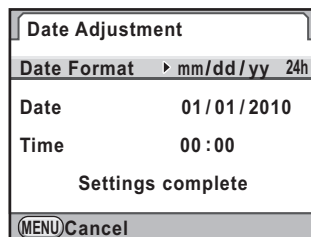

Setting the World Time

The date and time selected in “Initial Settings” (p.60) serve as the date and time of your present location.

Setting the destination in [World Time] enables you to display the local date and time on the monitor when traveling overseas.

1 Select [World Time] in the [↖ Set-up 1] menu and press the four-way controller (▶).

The [World Time] screen appears.

2 Use the four-way controller (◀▶) to select → (Destination) or ↕ (Hometown) for [Setting the Time].

This setting is reflected on the date and time that appear in the guide display and control panel.

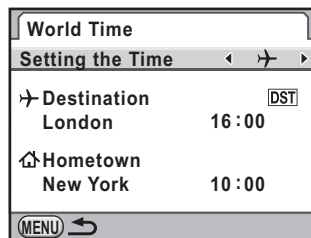

3 Press the four-way controller (▼).

The selection frame moves to → (Destination setting).

4 Press the four-way controller (▶).

The [→ Destination] screen appears.

5 Use the four-way controller (◀▶) to select a destination city.

Turn the e-dial to change the region.

The location, time difference and current time of the selected city appear.

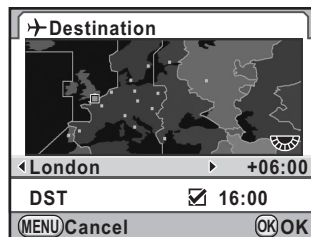

6 Press the four-way controller (▼) to select [DST].

7 Use the four-way controller (◀▶) to select (On) or (Off).

Select if the destination city uses daylight saving time (DST).

8 Press the OK button.

The destination setting is saved and the camera returns to the [World Time] screen.

9 Press the MENU button twice.

The screen that was displayed before selecting the menu appears again.



- Refer to “List of World Time Cities” (p.272) for cities that can be selected as a destination.
- Select (Hometown) in Step 2 to set the city and DST setting.
- → appears in the guide display and control panel if [Setting the Time] is set to → (Destination). (p.24)
- When you switch [Setting the Time] to → (Destination), the video output (p.243) setting changes to the video output format for that city.

List of World Time Cities

Region	City	Region	City
North America	Honolulu	Africa/ West Asia	Dakar
	Anchorage		Algiers
	Vancouver		Johannesburg
	San Francisco		Istanbul
	Los Angeles		Cairo
	Calgary		Jerusalem
	Denver		Nairobi
	Chicago		Jeddah
	Miami		Tehran
	Toronto		Dubai
	New York	Karachi	
	Halifax	Kabul	
Central and South America	Mexico City	Male	
	Lima	Delhi	
	Santiago	Colombo	
	Caracas	Kathmandu	
	Buenos Aires	Dacca	
	Sao Paulo	East Asia	Yangon
	Rio de Janeiro		Bangkok
Europe	Lisbon		Kuala Lumpur
	Madrid		Vientiane
	London		Singapore
	Paris		Phnom Penh
	Amsterdam		Ho chi Minh
	Milan		Jakarta
	Rome		Hong Kong
	Copenhagen		Beijing
	Berlin	Shanghai	
	Prague	Manila	
	Stockholm	Taipei	
	Budapest	Seoul	
	Warsaw	Tokyo	
	Athens	Guam	
	Helsinki		
	Moscow		

Region	City
Oceania	Perth
	Adelaide
	Sydney
	Noumea
	Wellington
	Auckland
	Pago Pago

Setting the Display Language

You can change the language in which the menus, error messages, etc. are displayed.

The camera supports the following languages: English, French, German, Spanish, Portuguese, Italian, Dutch, Danish, Swedish, Finnish, Polish, Czech, Hungarian, Turkish, Greek, Russian, Korean, Traditional Chinese, Simplified Chinese and Japanese.

Set in [Language/言語] of the [ Set-up 1] menu (p.266).

 Setting the Display Language (p.60)

Language/言語		
<u>English</u>	Dansk	Ελληνικά
Français	Svenska	Русский
Deutsch	Suomi	한국어
Español	Polski	中文繁體
Português	Čeština	中文简体
Italiano	Magyar	日本語
Nederlands	Türkçe	
(MENU) Cancel		(OK) OK

Adjusting the Monitor and the Menu Display

Setting the Text Size

You can set the text size of an item selected on the respective menu screens to [Standard] (normal display) or [Large] (magnified display).

Set in [Text Size] of the [Set-up 1] menu (p.266).

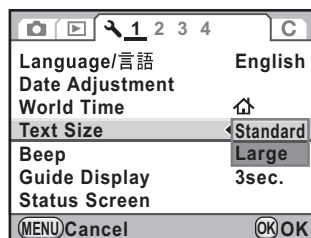

Setting the Guide Display Time

Set the length of time that the guides are displayed on the monitor when the camera is turned on or the Capture mode is changed. (p.24)

Select from [3 sec.] (default setting), [10 sec.], [30 sec.] and [Off].

Set in [Guide Display] of the [Set-up 1] menu (p.266).

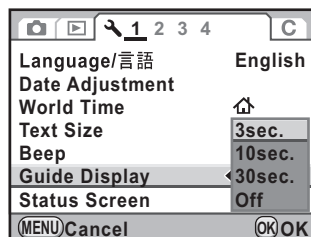

Setting the Initial Menu Tab Displayed

Set the initial menu tab displayed on the monitor when the **MENU** button is pressed.

- 1 **Select [19. Save Menu Location] in the [C Custom Setting 3] menu and press the four-way controller (▶).**

The [19. Save Menu Location] screen appears.

- 2 **Use the four-way controller (▲▼) to select [Reset Menu Location] or [Save Menu Location] and press the OK button.**

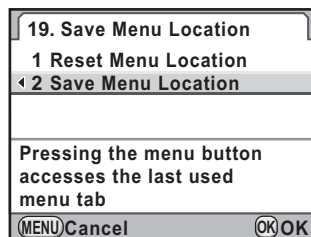

1	Reset Menu Location	The [📷 Rec. Mode 1] menu ([▶ Playback 1] menu in Playback mode) is always displayed first. (default setting)
2	Save Menu Location	The menu tab last selected is displayed first.

- 3 **Press the MENU button.**

The screen that was displayed before selecting the menu appears again.

Setting the Status Screen Display

You can set the display color of the status screen and control panel.

- 1 Select [Status Screen] in the [Set-up 1] menu and press the four-way controller (▶).

The [Status Screen] screen appears.

- 2 Use the four-way controller (◀▶) to select from six display colors.

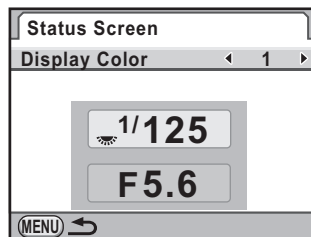

- 3 Press the MENU button twice.

The display color of the status screen and control panel are changed.

Setting the Display for Instant Review

You can set the Instant Review display settings.

- 1 Select [Instant Review] in the [Rec. Mode 3] menu and press the four-way controller (▶).

The [Instant Review] screen appears.

- 2 Press the four-way controller (▶) and use the four-way controller (▲▼) to select a display time.

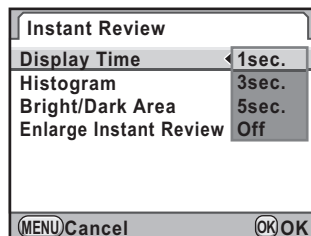

3 Press the **OK** button.

4 Use the four-way controller (▲▼) to select [**Histogram**], [**Bright/Dark Area**] or [**Enlarge Instant Review**].

5 Use the four-way controller (◀▶) to select or .

When [**Enlarge Instant Review**] is set to (default setting), you can magnify the image with the e-dial. (p.223)

6 Press the **MENU** button twice.

The screen that was displayed before selecting the menu appears again.

Adjusting the Brightness of the Monitor

You can adjust the brightness of the monitor. Adjust the settings when the monitor is hard to see.

1 Select [**Brightness Level**] in the [**Set-up 2**] menu and press the four-way controller (▶).

The [**Brightness Level**] screen appears.

2 Use the four-way controller (◀▶) to adjust the brightness.

You can select from 15 brightness levels.

The value is reset to ±0 when the  button is pressed.

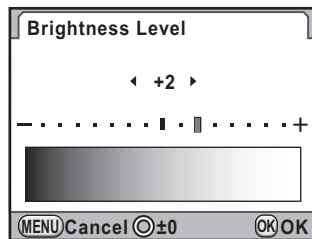

3 Press the **OK** button.

4 Press the **MENU** button.

The screen that was displayed before selecting the menu appears again.

Adjusting the Color of the Monitor

You can adjust the color of the monitor.

- 1 Select [LCD Color Tuning] in the [↖ Set-up 2] menu and press the four-way controller (▶).**

The [LCD Color Tuning] screen appears.

- 2 Adjust the color.**

Seven levels (225 patterns) are available on the G-M and B-A axes.

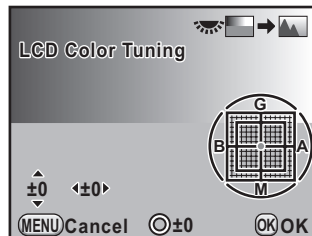

Available operations

Four-way controller (▲▼) Adjusts the tone of the colors between green (G) and magenta (M).

Four-way controller (◀▶) Adjusts the tone of the colors between blue (B) and amber (A).

⊙ button Resets the adjustment value.

E-dial Displays a saved image in the background so you can adjust the color while viewing the image. This is useful for matching the color of the monitor with that of a computer.

- 3 Press the OK button.**

- 4 Press the MENU button.**

The screen that was displayed before selecting the menu appears again.

Changing the Naming System of the Folder

You can select a naming system of the folder for storing images.

Date	The two digits of the month and day on which the picture was taken are assigned as the folder name in the form of [xxx_MMDD]. [xxx] is a sequential number from 100 to 999. [MMDD] (month and day) appears according to the display style set in [Date Adjustment] (p.270). (default setting) Example) 101_0125: Folder for images taken on January 25th
PENTX	The folder name is assigned in the form of [xxxPENTX]. Example) 101PENTX

Set in [Folder Name] of the [Set-up 2] menu (p.266).

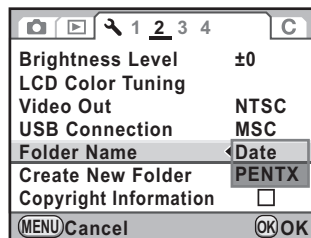

Creating New Folders

Creates a new folder on an SD Memory Card. A folder is created with the number following the number of the folder currently being used.

- 1** Select [Create New Folder] in the [Set-up 2] menu and press the four-way controller (▶).

The [Create New Folder] screen appears.

2 Use the four-way controller (▲▼) to select [Create folder] and press the OK button.

A folder with a new number is created.

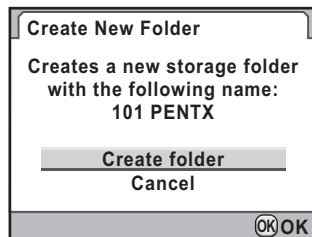

Only one folder can be created using this operation. Multiple empty folders cannot be created consecutively.

Selecting the File Number Setting

You can select a method for assigning the file number of an image when saved to a new folder. Set in [File No.] in [Memory] (p.288) of the [📷 Rec. Mode 4] menu.

<input checked="" type="checkbox"/>	The file number of the last image saved to the previous folder is saved and subsequent images are assigned sequential file numbers even if a new folder is created.
<input type="checkbox"/>	The file number of the first image saved to a folder returns to 0001 each time a new folder is created for saving images.





When the number of storable images exceeds 500, captured images are divided into folders of 500 images each. However, in Exposure Bracketing shooting, images will be stored in the same folder until shooting is completed, even if the number of images exceeds 500.

Setting the Auto Power Off Function

You can set the camera to turn off automatically if unused after a certain length of time. Select from [1 min.] (default setting), [3 min.], [5 min.], [10 min.], [30 min.] or [Off].

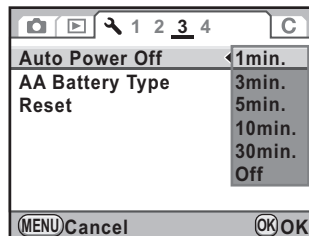
Set in [Auto Power Off] of the [ Set-up 3] menu (p.267).



- The Auto Power Off function does not work in the following situations.
 - when the Live View image is displayed
 - when the slideshow is played back
 - when the camera is connected to a computer with an USB cable
- If the camera turns off after the set length of time, perform one of the following operations to reactivate it.
 - Turn on the camera again.
 - Press the shutter release button halfway.
 - Press the  button, the **MENU** button, or the **INFO** button.

Setting the Battery Type

Sets the type of AA batteries used in the camera. The default setting is [Auto-detect].

- 1 **Select [AA Battery Type] in the [Set-up 3] menu and press the four-way controller (▶).**

The [AA Battery Type] screen appears.

- 2 **Use the four-way controller (▲▼) to select a battery type and press the OK button.**

When set to [Auto-detect], the camera will automatically detect the type of batteries being used.

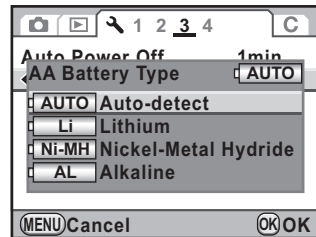

- 3 **Press the MENU button.**

The screen that was displayed before selecting the menu appears again.



When the type of batteries being used is different from the item you selected, the battery level will not be correctly determined. Make sure that the correct battery type is selected in the [AA Battery Type] setting. Usually, there is no problem using [Auto-detect]. However in low temperatures and when using batteries that were stored for long periods of time, set the appropriate battery type so the camera can correctly determine the remaining battery level.

The camera type, shooting conditions and other information are automatically embedded in captured images in the Exif data format. You can embed photographer information in this Exif.



Use the provided "PENTAX Digital Camera Utility 4" software (p.298) to check the Exif information.

1 Select [Copyright Information] in the [↖ Set-up 2] menu and press the four-way controller (▶).

The [Copyright Information] screen appears.

2 Use the four-way controller (◀▶) to select or .

<input checked="" type="checkbox"/>	Embeds copyright information in the Exif.
<input type="checkbox"/>	Does not embed copyright information in the Exif. (default setting)

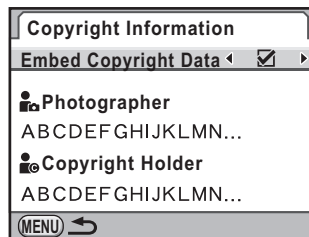

3 Use the four-way controller (▲▼) to select [Photographer] and press the four-way controller (▶).

The text-entry screen appears.

4 Enter the text.

Up to 32 single-byte alphanumeric characters and symbols can be entered.

Text selection cursor

Text input cursor

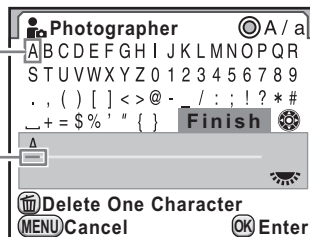

Available operations

Four-way controller (▲▼◀▶)	Moves the text selection cursor.
E-dial	Moves the text input cursor.
⊙ button	Switches between upper and lower case letters.
OK button	Enters a character selected with the text selection cursor at the position of the text input cursor.
↵/🗑️ button	Deletes a character at the position of the text input cursor.

5 After entering the text, move the text selection cursor to [Finish] and press the OK button.

The camera returns to the [Copyright Information] screen.

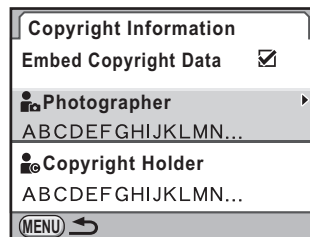

6 Use the four-way controller (▲▼) to select [Copyright Holder] and enter the text in the same way as [Photographer].

7 Press the MENU button twice.

The screen that was displayed before selecting the menu appears again.

You can order conventional photograph prints by taking the SD Memory Card with recorded images to a store for printing. DPOF (Digital Print Order Format) settings allow you to specify the number of copies and whether to imprint the date.



- DPOF settings cannot be applied to RAW images and movies.
- You can make DPOF settings for up to 999 images.

1 Press the four-way controller (▼) in Playback mode.

The playback mode palette appears.

2 Use the four-way controller (▲▼◀▶) to select (DPOF) and press the OK button.

The screen to select how to change the settings is displayed.

3 Use the four-way controller (▲▼) to select [Single Image] or [All Images] and press the OK button.



4 When [Single Image] is selected in Step 3, use the four-way controller (◀▶) to select an image to set DPOF settings.



5 Use the four-way controller (▲▼) to select the number of copies.

You can set up to 99 copies.

 appears at the top right of the screen for images with DPOF settings. To cancel the DPOF settings, set the number of copies to [00].

6 Turn the e-dial to select or for printing the date.

<input checked="" type="checkbox"/>	The date will be printed.
<input type="checkbox"/>	The date will not be printed.

Repeat Steps 4 to 6 to make DPOF settings for other images (up to 999).



7 Press the OK button.

The DPOF settings for the selected image is saved and the camera returns to Playback mode.



- Depending on the printer or printing equipment at the photo processing lab, the date may not be printed on the pictures even if the date for DPOF setting is set to .
- The number of copies specified in the All Images setting applies to all the images, and that specified in the Single Image setting is canceled. Before printing, check that the specified number is correct.

Correcting Defective Pixels in the CMOS Sensor (Pixel Mapping)

Pixel Mapping is a function for mapping out and correcting defective pixels in the CMOS sensor.

- 1** Select **[Pixel Mapping]** in the **[ Set-up 4]** menu and press the four-way controller (**▶**).

The **[Pixel Mapping]** screen appears.

- 2** Press the four-way controller (**▲**) to select **[Pixel Mapping]** and press the **OK** button.

Defective pixels are mapped and corrected, and the screen that was displayed before selecting the menu appears again.

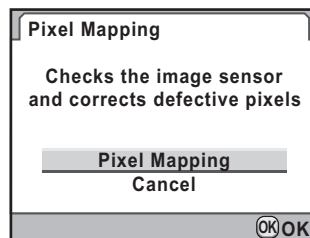

When the battery level is low, **[Not enough battery power remaining to activate Pixel Mapping]** is displayed on the monitor. Use the AC adapter kit K-AC109 (optional) or change to the battery with ample power remaining.

Selecting Settings to Save in the Camera (Memory)

You can select which function settings to save when the camera is turned off. The following function settings can be saved.

Function	Default Setting
Flash Mode	<input checked="" type="checkbox"/>
Drive Mode	<input checked="" type="checkbox"/>
White Balance	<input checked="" type="checkbox"/>
Custom Image	<input checked="" type="checkbox"/>
Sensitivity	<input checked="" type="checkbox"/>
EV Compensation	<input checked="" type="checkbox"/>
Flash Exposure Comp.	<input checked="" type="checkbox"/>

Function	Default Setting
Cross Processing	<input type="checkbox"/>
Digital Filter	<input type="checkbox"/>
HDR Capture	<input type="checkbox"/>
Shooting Info Display	<input type="checkbox"/>
Playback Info Display	<input checked="" type="checkbox"/>
File No.	<input checked="" type="checkbox"/>

- 1 Select [Memory] in the [📷 Rec. Mode 4] menu and press the four-way controller (▶).**

The [Memory 1] screen appears.

- 2 Use the four-way controller (▲▼) to choose an item.**

Turn the e-dial to display the [Memory 2] screen.

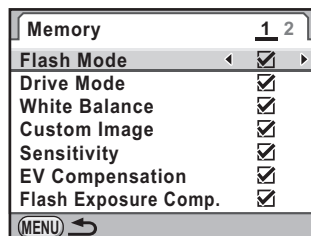

- 3 Use the four-way controller (◀▶) to select or .**

<input checked="" type="checkbox"/>	Settings are saved even when the camera is turned off.
<input type="checkbox"/>	Settings are cleared and returned to their default values when the camera is turned off.

- 4 Press the MENU button twice.**

The screen that was displayed before selecting the menu appears again.



- Set [File No.] to (On) to continue the sequential numbering for the file name even if a new folder is created. Refer to “Selecting the File Number Setting” (p.280).
- When the [ Set-up] menu is reset (p.310), all Memory settings return to the default values.
- If [Shooting Info Display] is set to (Off), the status screen is always displayed first when the camera is turned on. (p.26)

Memo

10 Connecting to a Computer

This chapter explains how to connect the camera to your computer, install the supplied CD-ROM, etc.

Manipulating Captured Images on a Computer	292
Saving Images on Your Computer	293
Using the Provided Software	296

Manipulating Captured Images on a Computer

The captured still pictures and movies can be transferred to a computer by connecting the **K-r** using a USB cable and can be managed using the provided software.

We recommend the following system requirements to connect your camera to a computer or to use the software “PENTAX Digital Camera Utility 4” included on the CD-ROM (S-SW110).

● Windows

OS	Windows XP (SP3 or later), Windows Vista, or Windows 7 (can be run as a 32-bit application on any x64 Edition of Windows.)
CPU	Pentium D 3.0 GHz equivalent or higher (Intel Core 2 Duo processor 2.0 GHz equivalent or higher recommended)
RAM	2.0 GB minimum (3.0 GB or more recommended)
Free Disk Space	1 GB minimum (8 GB or more recommended)
Monitor	1280×800 pixels or more (1920×1200 or more recommended) with 24-bit full color (approximately 16.77 million colors)
Others	USB 2.0 port must be standard equipment

● Macintosh

OS	Mac OS X 10.4.11, 10.5, or 10.6
CPU	PowerPC G5 Dual-core 2.0 GHz or higher (Intel Core 2 Duo processor 2.0 GHz or higher recommended. Universal Binary format.)
RAM	2.0 GB minimum (4.0 GB or more recommended)
Free Disk Space	1 GB minimum (8 GB or more recommended)
Monitor	1280×800 pixels or more (1920×1200 or more recommended) with 24-bit full color (approximately 16.77 million colors)
Others	USB 2.0 port must be standard equipment

Setting the USB Connection Mode

Set the USB connection mode when connecting to a computer via the provided USB cable (I-USB7). The default setting is [MSC].

1 Select [USB Connection] in the [Set-up 2] menu and press the four-way controller (▶).

2 Use the four-way controller (▲ ▼) to select [MSC] or [PTP].

Refer to p.294 for details.

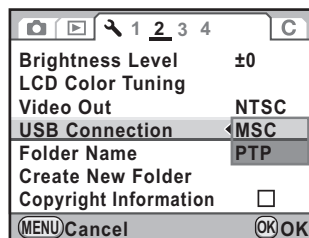

3 Press the **OK** button.

The setting is changed.

4 Press the **MENU** button.

The screen that was displayed before selecting the menu appears again.

MSC and PTP

MSC (Mass Storage Class)

A general-purpose driver program that handles devices connected to the computer via USB as a memory device. Also indicates a standard for controlling USB devices with this driver.

By simply connecting a device that supports USB Mass Storage Class, you can copy, read, and write files from a computer without installing a dedicated driver.

PTP (Picture Transfer Protocol)

A protocol that allows transfer of digital images and control of digital cameras via USB, standardized as ISO 15740.

You can transfer image data between devices that support PTP without installing a device driver.

Unless otherwise specified, select MSC when connecting the **K-r** to your computer.

Saving Images by Connecting Your Camera and Your Computer

- 1 Turn your computer on.
- 2 Turn off your camera and use the provided USB cable to connect your camera and your computer.

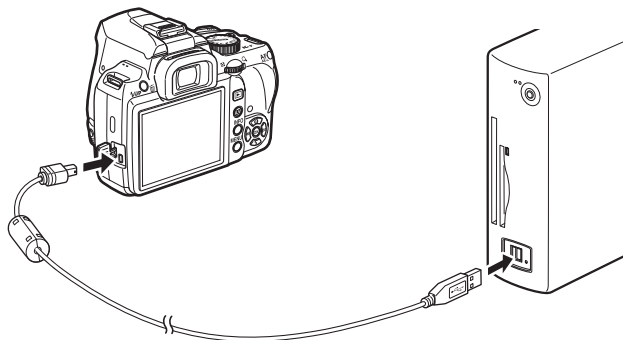

3 Turn your camera on.

The camera is recognized as a removable disk or an SD Memory Card with a volume label "K-r".

If the "K-r" dialog appears when the camera is turned on, select [Open folder to view files using Windows Explorer] and click the OK button.

4 Save the captured images to your computer.

Drag and drop the image file(s) or the folder containing the image files in your camera to the hard disk of your computer or the desktop.

5 Disconnect your camera from your computer.

“PENTAX Digital Camera Utility 4” is included on the CD-ROM (S-SW110). Using the PENTAX Digital Camera Utility 4, you can manage images saved on your computer, and develop RAW files taken with the **K-r** and adjust the color of the images.

Compatible file formats: .bmp (BMP)/.jpg (JPEG)/.pef (files recorded in PENTAX original RAW format)/.png (PNG)/.tif (TIFF)/.dng (DNG format RAW file)

Installing the Software

You can install the software from the provided CD-ROM. When multiple accounts have been setup on your computer, log on with an account that has administrative rights before installing the software.

1 Turn your computer on.

Make sure no other software is running.

2 Place the CD-ROM (S-SW110) into the CD-ROM drive on your computer.

The [PENTAX Software Installer] screen appears.

If the [PENTAX Software Installer] screen does not appear

• For Windows

- 1 Click [My Computer] from the Start menu.
- 2 Double-click the [CD-ROM drive (S-SW110)] icon.
- 3 Double-click the [Setup.exe] icon.

• For Macintosh

- 1 Double-click the CD-ROM (S-SW110) icon on the desktop.
- 2 Double-click the [PENTAX Installer] icon.

3 Click [PENTAX Digital Camera Utility 4].

For Windows, proceed to Step 4.

For Macintosh, follow the instructions on the screen to perform subsequent steps.



4 Select the desired language in the [Choose Setup Language] screen and click [OK].



5 When the [InstallShield Wizard] screen appears in the selected language, click [Next].

Follow the instructions on the screen to perform subsequent steps.

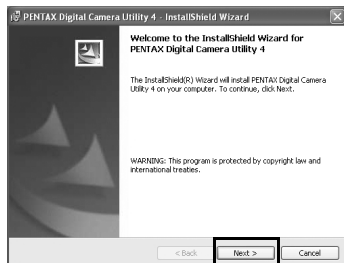

Screens of the PENTAX Digital Camera Utility 4

When PENTAX Digital Camera Utility 4 is launched, the following screen (browser) appears.



The screenshots used in this explanation are for Windows.

● Browser tab set (default setting)

You can perform the file management functions such as viewing and organizing the images.

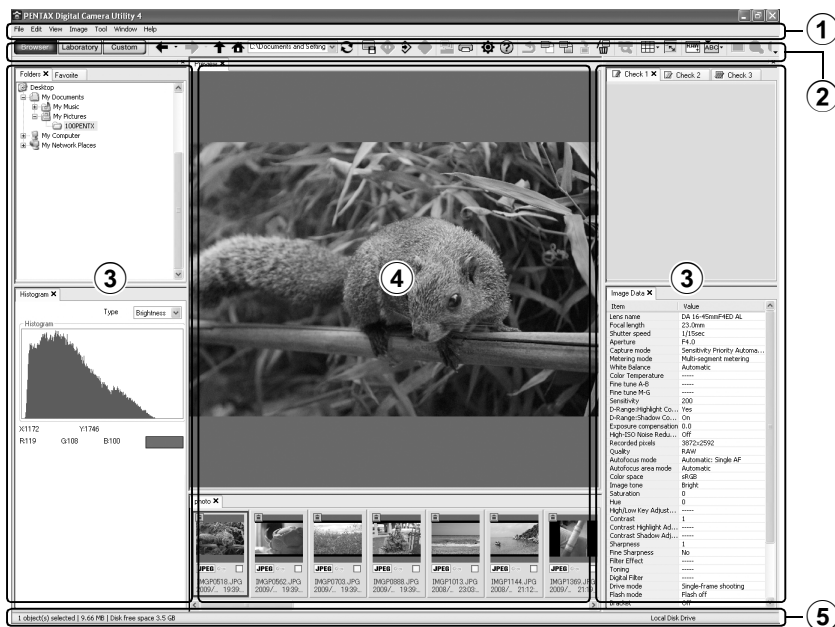

① Menu Bar

This executes functions or makes various settings.

For Macintosh, the Menu bar appears at the top of the desktop.

② Tool Bar

Frequently used functions are provided as Tool bar buttons.

③ Control Panel

Shooting information and settings of the selected image appear in this panel. The set of tab pages displayed in Control Panel can be changed by pressing the Browser, Laboratory and Custom buttons on the Tool bar.

④ File Display Pane

The file list and the images in the selected folder appear here.

⑤ Status Bar

Information on the selected item appears.

● Laboratory tab set (default setting)

The control panel for adjusting the image appears here.

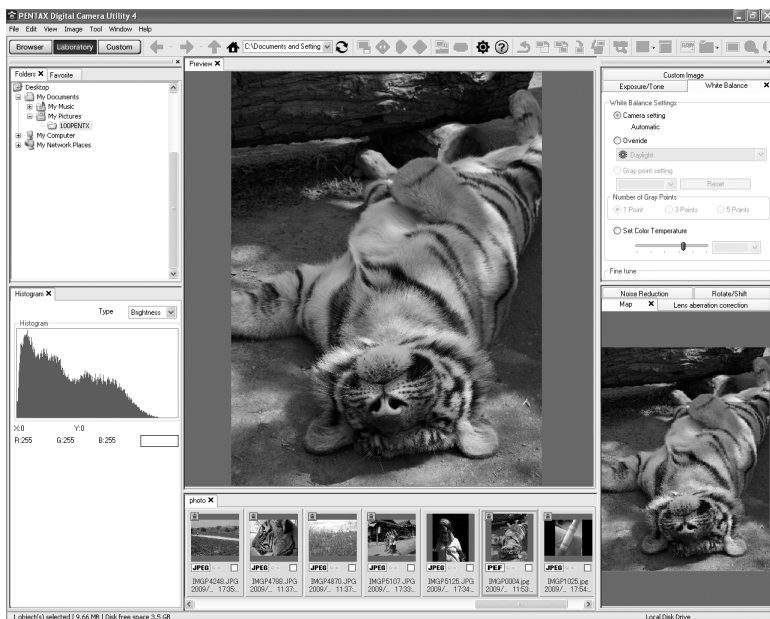

● Custom tab set (default setting)

The screen display can be customized here. The Custom tab pages enable you to customize whether to show/hide the various tab pages in accordance with your needs. By default, all tab pages are displayed.

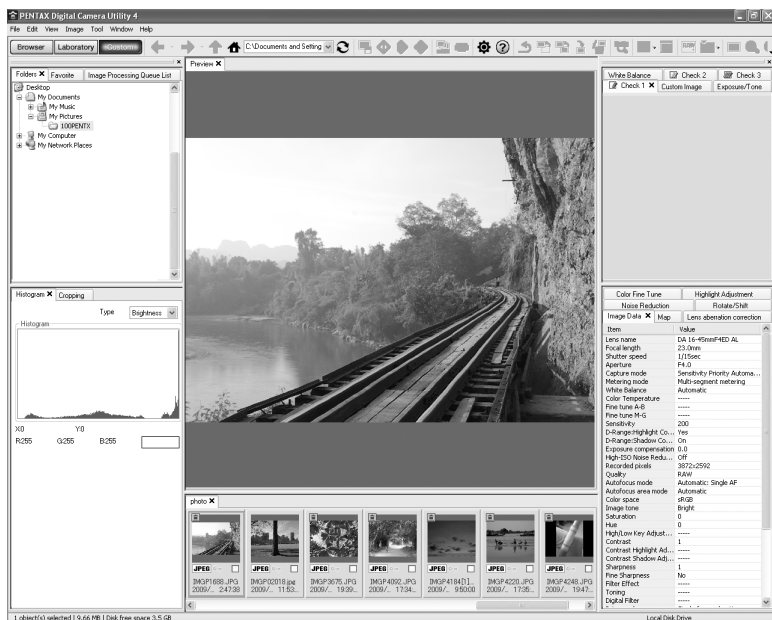

Viewing Detailed Information on the Software

Refer to Help for details on using the software program.

1 Click the button on the Tool bar.

Or, select [PENTAX Digital Camera Utility Help] from the [Help] menu.

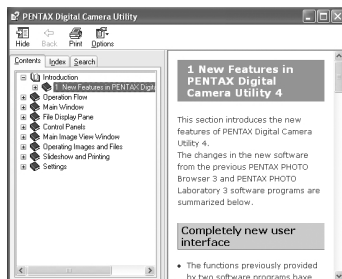

Regarding Product Registration

To better serve you, please take a moment to register your software.

Click [Product Registration] on the screen in Step 3 on p.297.



A world map for Internet Product Registration is displayed. If your computer is connected to the Internet, click the displayed country or region and then follow the instructions to register your software.

Note that you can only register online if your country or area is shown.

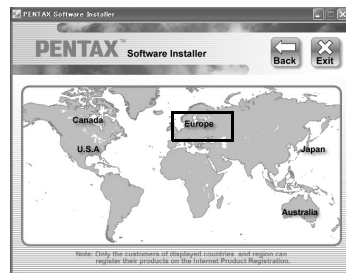

Memo

11 Appendix

Default Settings	304
Resetting the Menus	310
Functions Available with Various Lens Combinations	312
Cleaning the CMOS Sensor	315
Optional Accessories	320
Error Messages	325
Troubleshooting	328
Main Specifications	331
Glossary	337
Index	342
WARRANTY POLICY	348

The table below shows the factory default settings.

The functions set in Memory (p.288) are saved even when the camera is turned off.

Reset Setting



Yes: The setting returns to the default setting with the reset function (p.310).





No: The setting is saved even after reset.

Direct Keys

Item	Default Setting	Reset Setting	Page
Drive Mode	<input type="checkbox"/> (Single Frame Shooting)	Yes	p.118 p.145 p.147 p.149
Flash Mode	Depends on Capture mode	Yes	p.75
White Balance	AWB (Auto)	Yes	p.200
Sensitivity	AUTO (ISO 200 - 3200)	Yes	p.98

[Rec. Mode] Menu

Item	Default Setting	Reset Setting	Page
Custom Image	Bright	Yes ^{*1}	p.213
File Format	JPEG	Yes	p.195
JPEG Recorded Pixels	 (4288×2848)	Yes	p.192
JPEG Quality	★★★ (Best)	Yes	p.193
AF Mode	AF.A	Yes	p.125
AE Metering	 (Multi-segment)	Yes	p.114
Select AF Point	 (5 AF Points)	Yes	p.129
Cross Processing	Off	Yes	p.216
Digital Filter	Not use any filters	Yes	p.155
HDR Capture	Off	Yes	p.209

Item		Default Setting	Reset Setting	Page
Multi-exposure	Number of Shots	2 times	Yes	p.153
	Auto EV Adjustment	<input type="checkbox"/> (Off)	Yes	
Interval Shooting	Interval	1sec.	Yes	p.151
	Number of Shots	2 images	Yes	
	Start Interval	Now	Yes	
	Start Time	12:00AM / 00:00	Yes	
High-ISO NR		Auto	Yes	p.100
Slow Shutter Speed NR		Auto	Yes	p.102
Movie	Recorded Pixels	 (1280×720, 16:9)	Yes	p.165
	Quality Level	★★★ (Best)	Yes	
	Sound	 (On)	Yes	
	Cross Processing	Off	Yes	
	Digital Filter	Not use any filters	Yes	
	Movie Aperture Control	Fixed	Yes	
	Shake Reduction	 (Off)	Yes	
Live View	Autofocus Method	 (Face Detection AF)	Yes	p.160
	Show Grid	Off	Yes	
	Info Overlay	<input checked="" type="checkbox"/> (On)	Yes	
	Histogram	<input type="checkbox"/> (Off)	Yes	
	Bright/Dark Area	<input type="checkbox"/> (Off)	Yes	
Instant Review	Display Time	1 sec.	Yes	p.276
	Histogram	<input type="checkbox"/> (Off)	Yes	
	Bright/Dark Area	<input type="checkbox"/> (Off)	Yes	
	Enlarge Instant Review	<input checked="" type="checkbox"/> (On)	Yes	
D-Range Setting	Highlight Correction	Off	Yes	p.207
	Shadow Correction	Off	Yes	p.208
Lens Correction	Distortion Correction	Off	Yes	p.211
	Lat-Chromatic-Ab Adj	Off	Yes	
Color Space		sRGB	Yes	p.205
RAW File Format		PEF	Yes	p.196

Item		Default Setting	Reset Setting	Page	
Green Button	Green Button	Green Button	Yes	p.197	
	Custom Image *2	—	Yes		
	Optical Preview *2	—	Yes		
	Digital Preview *2	Histogram	<input type="checkbox"/> (Off)		Yes
		Bright/Dark Area	<input type="checkbox"/> (Off)		Yes
		Enlarge Instant Review	<input checked="" type="checkbox"/> (On)		Yes
	Digital Filter *2	—	Yes		
	Cross Processing *2	—	Yes		
	One Push File Format *2	Cancel after 1 shot	<input checked="" type="checkbox"/> (On)		Yes
		JPEG/RAW/RAW+ File Format	All RAW+	Yes	
Action in M Mode	P LINE	Yes	p.112		
E-dial in Program	P SHIFT	Yes	p.105		
AF/AE-L Button		Enable AF1	Yes	p.120 p.123	
Memory	Cross Processing, Digital Filter, HDR Capture, Shooting Info Display	<input type="checkbox"/> (Off)	Yes	p.288	
	Other than the above functions	<input checked="" type="checkbox"/> (On)	Yes		
Shake Reduction		 (On)	Yes	p.142	
Input Focal Length		35 mm	Yes	p.143	

*1 The parameters specified in [Custom Image] are also reset.

*2 The setting returns to [Green Button] after reset.

Playback Mode Palette

Item	Default Setting	Reset Setting	Page
Image Rotation	—	—	p.235
Digital Filter	Toy Camera	Yes *1	p.253
Resize	Maximum size according to the setting	—	p.250
Cropping	Maximum size according to the setting	—	p.251
Slideshow	—	Yes	p.233
RAW Development	File Format: JPEG Recorded Pixels: 12M Quality Level: ★★★	Yes	p.259
Index	—	—	p.229
Image Comparison	—	—	p.228
Protect	—	No	p.240
DPOF	—	No	p.285
Movie Editing	—	—	p.171
IrSimple	—	—	p.244
Dueling Images	—	—	p.246

*1 The parameters specified in [Digital Filter] are also reset.

[▶ Playback] Menu

Item		Default Setting	Reset Setting	Page
Slideshow	Interval	3 sec.	Yes	p.232
	Screen Effect	Off	Yes	
	Repeat Playback	<input type="checkbox"/> (Off)	Yes	
Quick Zoom		Off	Yes	p.222
Bright/Dark Area		<input type="checkbox"/> (Off)	Yes	
Auto Image Rotation		<input checked="" type="checkbox"/> (On)	Yes	
IrSimple	Automatic Resizing	2M	Yes	p.244
	Transmission Method	Standard (IrSimple)	Yes	
Delete All Images		—	—	p.239

[↶] Set-up] Menu

Item		Default Setting	Reset Setting	Page
Language/言語		According to default setting	No	p.273
Date Adjustment		According to default setting	No	p.270
World Time	World Time setting	🏠 (Hometown)	Yes	p.270
	Hometown (City)	According to default setting	No	
	Hometown (DST)	According to default setting	No	
	Destination (City)	Same as Hometown	No	
	Destination (DST)	Same as Hometown	No	
Text Size		According to default setting	No	p.274
Beep	Volume	3	Yes	p.269
	Setting	All <input checked="" type="checkbox"/> (On)		
Guide Display		3 sec.	Yes	p.274
Status Screen		1	Yes	p.276
Brightness Level		±0	Yes	p.277
LCD Color Tuning		±0	Yes	p.278
Video Out		According to default setting	No	p.243
USB Connection		MSC	Yes	p.293
Folder Name		Date	Yes	p.279
Create New Folder		—	—	p.279
Copyright Information	Embed Copyright Data	<input type="checkbox"/> (Off)	Yes	p.283
	Photographer	—	No	
	Copyright Holder	—	No	
Auto Power Off		1 min.	Yes	p.281
AA Battery Type		Auto-detect	Yes	p.282
Reset		—	—	p.310
Pixel Mapping		—	—	p.287
Dust Alert		—	—	p.316
Dust Removal	Dust Removal	—	—	p.315
	Start-up Action	<input type="checkbox"/> (Off)	Yes	
Sensor Cleaning		—	—	p.318
Format		—	—	p.268

[C Custom Setting] Menu

Item	Default Setting	Reset Setting	Page
1. EV Steps	1/3 EV Steps	Yes	p.118
2. Sensitivity Steps	1 EV Step	Yes	p.99
3. Expanded Sensitivity	Off	Yes	p.99
4. Meter Operating Time	10 sec.	Yes	p.116
5. AE-L with AF Locked	Off	Yes	p.133
6. Link AE to AF Point	Off	Yes	p.115
7. Auto Bracketing Order	0 - +	Yes	p.118
8. Superimpose AF Area	On	Yes	p.130
9. AF.S Setting	Focus-priority	Yes	p.125
10. AF.C Setting	Focus-priority	Yes	p.126
11. AF Assist Light	On	Yes	p.127
12. WB When Using Flash	Auto White Balance	Yes	p.201
13. AWB in Tungsten Light	Subtle Correction	Yes	—
14. AF with Remote Control	Off	Yes	p.148
15. Remote Control in Bulb	Mode1	Yes	p.114
16. Release While Charging	Off	Yes	p.81
17. Flash in Wireless Mode	On	Yes	p.184
18. Saving Rotation Info	On	Yes	p.235
19. Save Menu Location	Reset Menu Location	Yes	p.275
20. Catch-in Focus	Off	Yes	p.136
21. AF Fine Adjustment	Off	Yes ^{*1}	p.128
22. Using Aperture Ring	Prohibited	Yes	p.314
Reset Custom Functions	—	—	p.311

*1 The adjustment values can be reset only for [Reset] in the [21. AF Fine Adjustment] screen.

Resetting the Rec. Mode/Playback/Set-up Menus

Settings in the [📷 Rec. Mode] menu, [▶ Playback] menu, [⚙️ Set-up] menu, direct keys and playback mode palette can be reset to default settings.



Language/言語, Date Adjustment, the city and DST settings for World Time, Text Size, Video Output, Copyright Information and [C Custom Setting] menu settings are not reset.

- 1 Select [Reset] in the [⚙️ Set-up 3] menu and press the four-way controller (▶).**

The [Reset] screen appears.

- 2 Press the four-way controller (▲) to select [Reset] and press the OK button.**

The settings are reset, and the screen that was displayed before selecting the menu appears again.

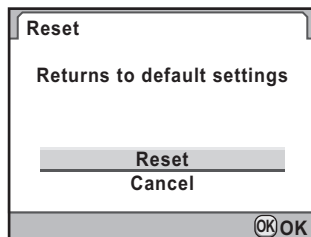

Resetting the Custom Menu

Reset settings in [C Custom Setting] menu to default values.

- 1 Select [Reset Custom Functions] in the [C Custom Setting 4] menu and press the four-way controller (▶).**

The [Reset Custom Functions] screen appears.

- 2 Press the four-way controller (▲) to select [Reset] and press the OK button.**

The settings are reset, and the screen that was displayed before selecting the menu appears again.

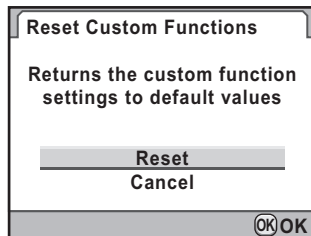



Functions Available with Various Lens Combinations

Only DA, DA L and FA J lenses and D FA/FA/F/A lenses which have an **A** (Auto) position on the aperture ring can be used with factory default settings. Refer to “Notes on [22. Using Aperture Ring]” (p.314) for other lenses and D FA/FA/F/A lenses with aperture ring set to a position other than **A**.

- ✓ : Functions are available when the aperture ring is set to the **A** position.
- # : Some functions are restricted.
- × : Functions are unavailable.

Function	Lens [Mount type]	DA DA L D FA	FA J FA *6	F *6	A	M P
		[KAF] [KAF2] [KAF3]	[KAF] [KAF2]	[KAF]	[KA]	[K]
Autofocus (Lens only) (With AF adapter 1.7×) *1		✓ —	✓ —	✓ —	— #*8	— #*8
Manual focus (With the focus indicator) *2 (With matte field)		✓ ✓	✓ ✓	✓ ✓	✓ ✓	✓ ✓
Quick-Shift Focus System		#*5	×	×	×	×
Five AF points/Eleven AF points		✓	✓	✓	#*8	×
Multi-segment metering		✓	✓	✓	✓	×
P (Program) mode		✓	✓	✓	✓	#*9
Sv (Sensitivity Priority) mode		✓	✓	✓	✓	#*9
Tv (Shutter Priority) mode		✓	✓	✓	✓	#*9
Av (Aperture Priority) mode		✓	✓	✓	✓	#*9
M (Manual) mode		✓	✓	✓	✓	#
P-TTL Auto Flash *3		✓	✓	✓	✓	×
Power Zoom		—	×	—	—	—
Automatically obtaining the lens focal length information when using the Shake Reduction function		✓	✓	✓	×	×
Lens Correction function *4		✓	×*7	×	×	×

- *1 Lenses with a maximum aperture of F2.8 or faster. Only available at the **A** position.
- *2 Lenses with a maximum aperture of F5.6 or faster.
- *3 When using the built-in flash and AF540FGZ, AF360FGZ, AF200FG or AF160FC.
- *4 Aberration correction is available in [Lens Correction] of the [ Rec. Mode 3] menu. The [Distortion Correction] setting is disabled when using a DA 10-17mm FISH-EYE lens.
- *5 Only available with compatible lenses.
- *6 To use an FA/F SOFT 85 mm F2.8 lens or FA SOFT 28 mm F2.8 lens, set [22. Using Aperture Ring] in the [**C** Custom Setting 4] menu to [Permitted]. Pictures can be taken with the aperture you set, but only within manual aperture range.
- *7 Only available with compatible lenses (FA 31mm F1.8 Limited, FA 43mm F1.9 Limited, or FA 77mm F1.8 Limited).
- *8 The focusing area is fixed to  (Spot).
- *9 **Av** (Aperture Priority) Automatic Exposure with the aperture open. (Adjusting the aperture ring has no effect on the actual aperture value.)

Lens names and mount names

DA lenses with an ultrasonic motor and FA zoom lenses with power zoom use the KAF2 mount. DA lenses with an ultrasonic motor and no AF coupler use the KAF3 mount.

FA single focal length lenses (non-zoom lenses), DA or DA L lenses without an ultrasonic motor and D FA, FA J and F lenses use the KAF mount.

Refer to respective lens manuals for details. Note that this camera is not equipped with a power zoom function.

Lenses and accessories that cannot be used with this camera

When the aperture ring is set to other than the **A** (Auto) position or a lens without an **A** position or accessories such as an auto extension tube or auto bellows are used, the camera will not operate unless [22. Using Aperture Ring] is set to [Permitted] in the [**C** Custom Setting 4] menu. Refer to “Notes on [22. Using Aperture Ring]” (p.314) for restrictions that apply.

All camera capture modes are available when using DA/DA L/FA J or lenses with an aperture **A** position set to the **A** position.

Lens and Built-in Flash

The built-in flash cannot be regulated and fully discharges when A lenses not set to the **A** (Auto) position, pre A lenses or soft focus lenses are used. Note that the built-in flash cannot be used as an Auto Flash.

Notes on [22. Using Aperture Ring]

When [22. Using Aperture Ring] is set to [Permitted] in the [C Custom Setting 4] menu, the shutter can be released even if the aperture ring of the D FA, FA, F or A lens is not set to the **A** (Auto) position or a lens without an **A** position is attached. However, some features will be restricted as shown below.

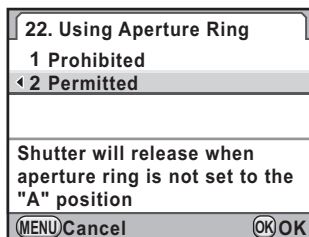

Restrictions on using lenses with aperture ring set to a position other than **A**

Lens Used	Exposure Mode	Restriction
D FA, FA, F, A, M (lens only or with auto diaphragm accessories such as auto extension tube K)	Av (Aperture Priority) mode	The aperture remains open regardless of the aperture ring position. The shutter speed changes in relation to the open aperture but an exposure error may occur. In the viewfinder, [F--] appears for the aperture indicator.
D FA, FA, F, A, M, S (with diaphragm accessories such as extension tube K)	Av (Aperture Priority) mode	Pictures can be taken with a specified aperture value but an exposure error may occur. In the viewfinder, [F--] appears for the aperture indicator.
Manual diaphragm lens such as reflex lens (lens only)	Av (Aperture Priority) mode	
FA, F SOFT 85mm, FA SOFT 28mm (lens only)	Av (Aperture Priority) mode	Pictures can be taken with a specified aperture value in the manual aperture range. In the viewfinder, [F--] appears for the aperture indicator. When the depth of field is checked (Optical Preview), exposure metering starts and the exposure can be checked.
All lenses	M (Manual) mode	Pictures can be taken with a set aperture value and shutter speed. In the viewfinder, [F--] appears for the aperture indicator. When the depth of field is checked (Optical Preview), exposure metering starts and the exposure can be checked.



If the aperture is set to a position other than **A**, the camera operates in **Av** (Aperture Priority) mode regardless of the mode dial setting except when set to **M** (Manual) or (Movie) mode.

If the CMOS sensor becomes dirty or dusty, shadows may appear in the image in certain situations such as when shooting against a white background. This indicates that the CMOS sensor must be cleaned.

Removing Dust by Shaking the CMOS Sensor (Dust Removal)

Shaking the CMOS sensor removes dust that has collected.

- 1 Select [Dust Removal] in the [Set-up 4] menu and press the four-way controller (▶).**

The [Dust Removal] screen appears.

- 2 Press the OK button.**

The Dust Removal function is activated by shaking the CMOS sensor.

To activate the Dust Removal function every time the camera is turned on, select [Start-up Action] and use the four-way controller (◀▶) to select .

When Dust Removal is completed, the camera returns to the [Set-up 4] menu.

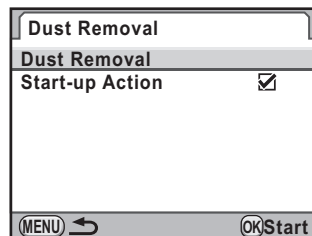

Detecting Dust on the CMOS Sensor (Dust Alert)

Dust Alert is a function that detects dust adhering to the CMOS sensor and visually displays the location of the dust.

You can save an image indicating the dust location and display it when performing sensor cleaning (p.318).

The following conditions must be met before using the Dust Alert function:

- A DA, DA L, FA J lens or a D FA, FA or F lens that has an **A** (Auto) position is attached.
- The aperture is set to the **A** position when using a lens with an aperture ring.
- The mode dial is set to any mode other than  (Movie).
- The focus mode lever is set to **AF**.



- The exposure time may be extremely long when using the Dust Alert function. Note that if the direction of the lens is changed before processing is complete, dust will not be detected properly.
- Depending on the subject conditions or temperature, dust may not be detected properly.
- The Dust Alert image can only be displayed during sensor cleaning within 30 minutes from the time the image is saved. If more than 30 minutes elapse, save a new Dust Alert image and then perform sensor cleaning.
- The saved Dust Alert image cannot be displayed in Playback mode.
- The Dust Alert image is saved only when an SD Memory Card is inserted.

1 Select [Dust Alert] in the [Set-up 4] menu and press the four-way controller (▶).

The [Dust Alert] screen appears.

2 Fully display a white wall or other bright subject with no detail in the viewfinder and press the shutter release button fully.

After image processing is performed, the Dust Alert image appears.

If the message [The operation could not be completed correctly] is displayed, press the **OK** button and take another picture.

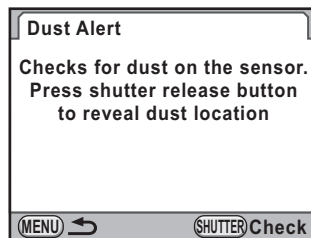

3 Check the sensor for dust.

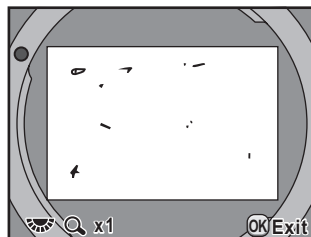

Available operations

E-dial/ INFO button	Displays the Dust Alert image at full screen display.
-------------------------------	---

4 Press the **OK** button.

The Dust Alert image is saved and the camera returns to the [ Set-up 4] menu.



- Regardless of the camera settings, the Dust Alert image will be taken with specific shooting conditions.
- Press the **INFO** button or turn the e-dial when the Dust Alert image is displayed to view the sensor area at full screen display.

Removing Dust with a Blower

Raise the mirror up and open the shutter when cleaning the CMOS sensor with a blower.

Please contact a PENTAX Service Center for professional cleaning because the CMOS sensor is a precision part. Cleaning services involve a fee.

You can use the optional Imagesensor Cleaning kit O-ICK1 (p.324) when cleaning the CMOS sensor.



- Do not use a spray type blower.
- Do not clean the sensor when the shutter speed is set to **Bulb**.
- To prevent dirt and dust from accumulating on the CMOS sensor, keep the lens mount cap on the camera when a lens is not attached.
- When the battery level is low, the message [Not enough battery power remaining to clean sensor] is displayed on the monitor.
- It is recommended to use the AC adapter kit K-AC109 (optional) when cleaning the sensor. If you are not using the AC adapter kit K-AC109 (optional), please install the battery with ample power remaining. If the battery capacity becomes low during cleaning, a warning beep will sound. In this case, stop cleaning immediately.
- Do not put the tip of the blower inside the lens mount area. If the power is turned off, this may cause damage to the shutter, CMOS sensor and the mirror.



- The self-timer lamp blinks while cleaning the sensor.
- This camera features a CMOS sensor corresponding to the shake reduction system, and it may generate a vibration sound while cleaning the CMOS sensor. It is not a malfunction.

1 Turn the camera off and remove the lens.

2 Turn the camera on.

3 Select [Sensor Cleaning] in the [Set-up 4] menu and press the four-way controller (▶).

The [Sensor Cleaning] screen appears.

4 Use the four-way controller (▲▼) to select [Mirror Up] and press the OK button.

The mirror is locked in the up position.

If you used Dust Alert to detect dust on the sensor within the last 30 minutes, the Dust Alert image appears on the monitor. Clean the sensor while checking the location of the dust.

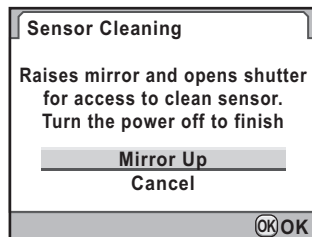

5 Clean the CMOS sensor.

Use a brush-less blower to remove dirt and dust from the CMOS sensor. Using a blower with a brush may scratch the CMOS sensor. Do not wipe the CMOS sensor with a cloth.

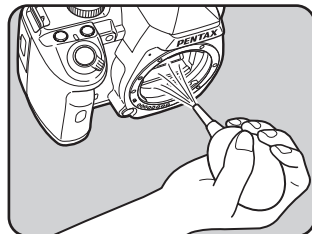

6 Turn off the camera.

7 Attach the lens after the mirror returns to its original position.

A number of dedicated accessories are available for this camera. Contact a PENTAX Service Center for details regarding accessories. Products marked with an asterisk (*) are the same as those supplied with the camera.

Power Supply Accessories

Battery Charger kit K-BC109 (*)

(Kit includes Battery Charger D-BC109 and AC plug cord.)

Rechargeable Lithium-ion Battery D-LI109 (*)

AC Adapter kit K-AC109

(Kit includes AC Adapter D-AC50, DC Coupler D-DC109 and AC plug cord.)

Lets you power your camera from an AC outlet.

AA battery holder D-BH109

Adapter for using four commercially available AA batteries.



D-BH109



The AC adapter and battery charger are only sold as a kit respectively.

Flash Accessories

Auto Flash AF540FGZ

Auto Flash AF360FGZ

The AF540FGZ and AF360FGZ are P-TTL auto flash units with a maximum guide number of 54 and 36 (ISO 100/m), respectively. Their features include slave-sync flash, contrast-control-sync flash, high-speed sync flash, wireless flash, slow-speed sync and trailing curtain sync flash.



AF540FGZ



AF360FGZ

Auto Flash AF200FG

The AF200FG is a P-TTL auto flash unit with a maximum guide number of 20 (ISO 100/m). It features contrast-control-sync flash and slow-speed sync flash when combined with an AF540FGZ or AF360FGZ unit.



AF200FG

Auto Macro Flash AF160FC

The AF160FC is a flash system especially designed for macro photography to take close, shadowless pictures of small objects. It is compatible with existing TTL auto flash functions and it can be used with a wide range of PENTAX cameras by using provided adapter rings.



AF160FC

Hot Shoe Adapter Fc**Extension Cord F5P**

Hot Shoe Adapter Fc

Off-Camera Shoe Adapter F

Use the adapters and cords to use the external flash away from the camera.



Off-camera Shoe Adapter F

Off-camera Shoe Clip CL-10

When using the AF540FGZ or AF360FGZ as a wireless flash, this large clip is used for setting the external flash on a desk or table.



Off-camera Shoe Clip CL-10

For Viewfinder**Magnifier Eyecup O-ME53**

This viewfinder accessory is for magnifying up to approximately 1.18 times.

When the eyecup is attached to the **K-r** with a viewfinder magnification of approximately 0.85 times, the combined magnification becomes approximately 1.0 times, making manual focusing much easier.



Magnifier Eyecup O-ME53

Magnifier Fb

This viewfinder accessory is for magnifying the central area of the viewfinder 2 \times .

You can see the entire view by simply flipping up the accessory from the eyepiece, as it is a hinge-type magnifier.



Magnifier Fb

Ref-converter A

This is an accessory that changes the viewfinder viewing angle at 90° intervals. The viewfinder magnification can be switched between 1× and 2×.



Ref-converter A

Diopter correction lens adapter M

This accessory adjusts the diopter. Install it on the viewfinder.

If it is difficult to see the viewfinder image clearly, choose one of the eight correction of approximately -5 to $+3 \text{ m}^{-1}$ (per meter).



Diopter correction lens adapter M

Eyecup F_α (*)

ME Viewfinder Cap

Remote Control

Lets you shoot pictures from within 4 m of the front of the camera.

Remote Control F



Remote Control Waterproof O-RC1



Camera Case/Strap

Camera Case O-CC84

Camera Strap O-ST53 (*)

Hand Strap O-ST991

Hand Strap O-ST992

Free Length Strap O-ST842

Imagesensor Cleaning Kit O-ICK1

Use this kit to clean the optical parts such as the CMOS sensor and lens of this camera.



Others

Body Mount Cap K

Hot Shoe Cover Fk (*)

USB Cable I-USB7 (*)

AV Cable I-AVC7

Error Message	Description
Memory card full	<p>The SD Memory Card is full and no more images can be saved. Insert a new SD Memory Card or delete unwanted images. (p.52, p.84) Data may be saved when you perform the following operations.</p> <ul style="list-style-type: none"> • Change the file format to JPEG. (p.195) • Change the JPEG Recorded Pixels or JPEG Quality setting. (p.192, p.193)
No image	There are no images that can be played back on the SD Memory Card.
This image cannot be displayed	You are trying to play back an image in a format not supported by this camera. You may be able to play it back on another brand of camera or your computer.
No card in the camera	The SD Memory Card is not inserted in the camera. (p.52)
Cannot use this card	The inserted SD Memory Card is not compatible with this camera.
Memory card error	The SD Memory Card has a problem, and image capture and playback are impossible. It may be viewable on a computer but not with this camera.
Card is not formatted	The SD Memory Card you have inserted is unformatted or has been formatted on another device and is not compatible with this camera. Use the card after formatting it with this camera. (p.268)
Card is locked	The write-protect switch on an SD Memory Card you have inserted is locked. Unlock the SD Memory Card. (p.53)
The card is electronically locked	Data is protected by the SD Memory Card security feature.
This image cannot be enlarged	You are trying to enlarge an image that cannot be enlarged.
This image is protected	You are trying to delete an image that is protected. Remove protection from the image. (p.240)



























Error Message	Description
Battery depleted	The battery is exhausted. Install a fully charged battery or new AA batteries in the camera. (p.43)
Not enough battery power remaining to clean sensor	Appears during sensor cleaning if the battery level is insufficient. Install a fully charged battery or new AA batteries, or use the AC adaptor kit K-AC109 (optional). (p.50)
Not enough battery power remaining to activate Pixel Mapping	Appears during Pixel Mapping if the battery level is insufficient. Install a fully charged battery or new AA batteries, or use the AC adaptor kit K-AC109 (optional). (p.50)
Image folder cannot be created	The maximum folder number (999) and file number (9999) are being used, and no more images can be saved. Insert a new SD Memory Card or format the card. (p.268)
Unable to store image	The image could not be saved because of an SD Memory Card error.
Settings not stored	The DPOF settings could not be saved because SD Memory Card is full. Delete unwanted images and perform DPOF setting again. (p.84)
The operation could not be completed correctly	The camera was unable to measure the manual white balance or detect dust on the sensor. Try the operation again. (p.202, p.316)
No more images can be selected	You cannot select 100 or more images at a time for Index (p.229) and Select & Delete (p.236).
No image can be processed	There are no images that can be processed using Digital Filter (p.253) or RAW Development (p.259) function.
This image cannot be processed	Appears when you try to perform Resize (p.250), Cropping (p.251), Digital Filter (p.253), or RAW Development (p.259) for images captured with other cameras, or when you try to perform Resize or Cropping for minimum file size images.
The camera failed to create an image	The creation of an index print image failed. (p.229)

Error Message	Description
<p>Camera overheated. Disabling Live View temporarily to protect circuitry</p>	<p>Live View cannot be used because the camera's internal temperature is too high. Press the OK button and try using Live View again when the camera has cooled down.</p>
<p>Cannot start Live View</p>	<p>Appears when Live View is started when [22. Using Aperture Ring] in the [C Custom Setting 4] menu is set to [Prohibited] and the lens aperture ring is set to a position other than A, or a lens without an A position is being used.</p>
<p>This function is not available in the current mode</p>	<p>You are trying to set a function that is not available when the capture mode is set to Picture mode, SCN (Scene) mode or  (Movie) mode.</p>

In rare cases, the camera may not operate correctly due to static electricity. This can be remedied by taking the battery out and putting it back in again. When the mirror remains in the up position, take the battery out and put it back in again. Then, the mirror will retract when the camera is turned on again. After these procedures are done, if the camera operates correctly, it does not require any repairs.

We recommend checking the following items before contacting a service center.

Problem	Cause	Remedy
The camera does not turn on	Battery is not installed	Check if battery is installed. If not, install a fully charged battery.
	Battery is not installed properly	Check the orientation of battery. Re-insert battery according to the +/- symbols. (p.45, p.46)
	The battery power is low	Replace with a charged battery or use the AC adapter kit K-AC109 (optional). (p.50)
The shutter cannot be released	The lens aperture ring is set to other than the A position	Set the lens aperture ring to the A position (p.104) or select [Permitted] in [22. Using Aperture Ring] of the [C Custom Setting 4] menu. (p.314)
	The built-in flash is charging	Wait until charging is finished.
	There is no available space on the SD Memory Card	Insert an SD Memory Card with available space or delete unwanted images. (p.52, p.84)
	Recording	Wait until recording is finished.
Autofocus does not work	The subject is difficult to focus on	Autofocus cannot focus well on subjects that have low contrast (the sky, white walls, etc.), dark colors, intricate designs, rapidly-moving objects or scenery shot through a window or a net-like pattern. Lock focus on another object located at the same distance as your subject, then aim at the target and press the shutter release button fully. Alternatively, use manual focus. (p.134)

Problem	Cause	Remedy
Autofocus does not work	The subject is not in the focusing area	Position the subject in the focus frame in the middle of the viewfinder. If the subject is outside the focusing area, aim the camera at the subject and lock the focus, then compose a picture and press the shutter release button fully. (p.132)
	The subject is too close	Move away from the subject and take a picture.
	The focus mode is set to MF	Set the focus mode lever to AF . (p.122)
The focus cannot be locked	[AF Mode] is set to AFC	Autofocus is not locked (focus lock) when [AF Mode] is set to AFC (including when the AFC setting is automatically selected in AFA). The camera will continue focusing on the subject while the shutter release button is pressed halfway. If there is a subject that you want to focus on, set [AF Mode] to AFS (Single mode) and use the focus lock. (p.125)
	The Capture mode is set to  in Picture mode, or  ,  , or  in SCN mode.	Set Capture mode to any setting other than  (Moving Object) in Picture mode, or  (Stage Lighting),  (Night Snap),  (Kids), or  (Pet) in SCN (Scene) mode. (p.91)
The AE Lock function does not operate	The shutter speed is set to Bulb	Set the shutter speed to any mode other than Bulb . (p.113)
The built-in flash does not discharge	When the flash mode is set to  or  , the flash will not discharge if the subject is bright	Set the flash mode to  (Manual Flash Discharge) or  (Manual Flash+Red-eye Reduct.). (p.75)
	The mode dial is set to 	Set mode dial to any setting other than  (Flash Off). (p.91)
	SCN mode is set to  ,  ,  ,  , or 	Set SCN (Scene) mode to any mode other than  (Night Scene),  (Sunset),  (Stage Lighting),  (Night Scene HDR),  (Candlelight), or  (Museum). (p.93)
The power zoom system does not work	The camera does not have the power zoom function	Use manual zoom. (p.74)

Problem	Cause	Remedy
The USB connection with a computer does not work properly	The USB connection mode is set to [PTP]	Set [USB Connection] in the [ Set-up 2] menu to [MSC]. (p.293)
Shake Reduction does not work	The Shake Reduction function is off	Set [Shake Reduction] to on. (p.142)
	The Shake Reduction function is not set properly	If a lens for which the focal length information cannot be obtained is used, set the focal length in the [Input Focal Length] screen. (p.143)
	Shutter speed is too low for the Shake Reduction function to be effective when panning or shooting night scenes, etc.	Set [Shake Reduction] to off and use a tripod.
	The subject is too close	Move away from the subject, or turn off the Shake Reduction function and use a tripod.

Model Description

Type	TTL autofocus, auto-exposure SLR digital-still camera with built-in retractable P-TTL flash
Lens Mount	PENTAX KAF ₂ bayonet mount (AF coupler, lens information contacts, K-mount with power contacts)
Compatible Lens	KAF ₃ , KAF ₂ (power zoom not compatible), KAF, KA mount lenses

Image Capture Unit

Image Sensor	Primary color filter, CMOS, Size: 23.6 × 15.8 (mm)
Effective Pixels	Approx. 12.4 megapixels
Total Pixels	Approx. 12.9 megapixels
Dust Removal	SP coating and CMOS sensor operations with the Dust Alert function
Sensitivity (Standard Output)	AUTO/200 to 12800 (EV steps can be set to 1 EV, 1/2 EV, or 1/3 EV), expandable from ISO 100 to ISO 25600. Up to ISO 1600 in Bulb mode.

Image Stabilizer

Type	CMOS image sensor shift
Effective Compensation Range	Up to 4 EV (depending on the used lens type and shooting conditions)

File Formats

File Format	RAW (PEF/DNG), JPEG (Exif 2.21), DCF2.0 compliant
Recorded Pixels	JPEG: 12M (4288 × 2848 pixels), 10M (3936 × 2624 pixels), 6M (3072 × 2048 pixels), 2M (1728 × 1152 pixels) RAW: 12M (4288 × 2848 pixels)
Quality Level	RAW (12bit): PEF, DNG JPEG: ★★★ (Best), ★★ (Better), ★ (Good), RAW + JPEG simultaneous capturing compatible
Color Space	sRGB, AdobeRGB
Storage Medium	SD/SDHC Memory Card
Storage Folder	Date (100_1018, 100_1019...)/ PENTX (100PENTX, 101PENTX...)

Viewfinder

Type	Penta-mirror viewfinder
Coverage (FOV)	Approx. 96%
Magnification	Approx. 0.85× (50 mm F1.4 · ∞)
Eye-Relief Length	Approx. 19.1 mm (from the view window), Approx. 21.6 mm (from the center of lens)
Diopter Adjustment	Approx. -2.5 to +1.5m ⁻¹
Focusing Screen	Natural-Bright-Matte II focusing screen

Live View

Type	TTL method using CMOS image sensor
Focusing Mechanism	Contrast detection + Face detection, Contrast detection, Phase matching
Display	Field of View approx. 100%, Magnified view (AF mode: 2×, 4×, 6×/ MF mode: 2×, 4×, 6×, 8×, 10×), Grid display (4 × 4 Grid, Golden Section, Scale display), Bright/dark area warning, Histogram

LCD Monitor

Type	Wide viewing angle TFT color LCD
Size	3.0 inches
Dots	Approx. 921,000 dots
Adjustment	Brightness and colors adjustable

Preview

Type	Optical preview and digital preview (can be assigned to the ) button from the menu)
------	---

White Balance

Auto	TTL method using CMOS image sensor
Preset	Daylight, Shade, Cloudy, Fluorescent Light (D : Daylight Color, N : Daylight White, W : Cool White, L : Warm White), Tungsten Light, Flash, CTE , Manual
Manual	Configuration using the display screen
Fine Adjustment	Adjustable ±7 steps on A-B axis or G-M axis

Autofocus System

Type	TTL: phase-matching autofocus
Focus Sensor	SAFOX IX, 11 points (9 cross type focus points in the center)
Brightness Range	EV-1 to 18 (ISO100)
AF Mode	Auto AF (AFA), Single AF (AFS), Continuous AF (AFC) Focus priority or shutter priority mode for AFS Focus priority or FPS priority mode for AFC
AF Point Selection	Auto: 5 points, Auto: 11 points, Select, Center
AF Assist Light	Dedicated LED AF assist light

Metering

Type	TTL open aperture, 16 segmented metering, center-weighted and spot metering
Exposure Compensation	EV1 to 21.5 (ISO200 · 50mm F1.4)
Exposure Mode	Auto Picture mode, Picture mode (Portrait, Landscape, Macro, Moving Object, Night Scene Portrait, Flash Off) Scene mode (Night Scene, Surf & Snow, Food, Sunset, Stage Lighting, Night Snap, Night Scene HDR, Kids, Pet, Candlelight, Museum) * In Stage Lighting, Night Snap, and Night Scene HDR, the file format is fixed to JPEG. Program, Sensitivity Priority, Shutter Priority, Aperture Priority, Manual, Bulb
EV Compensation	±3 EV (1/2 EV steps or 1/3 EV steps can be selected)
AE Lock	Can be assigned to AF/AE-L button from the menu. (Timer method: two times the meter operating time set in the custom function setting), Continuous as long as the shutter release button is pressed halfway.

Shutter

Type	Electronically controlled vertical-run focal-plane shutter
Shutter Speed	Auto: 1/6000 to 30 sec., Manual: 1/6000 to 30 sec. (1/3 EV steps or 1/ 2EV steps), Bulb

Drive Modes

Mode Selection	Single frame, Continuous (Hi, Lo), Self-timer (12s, 2s), Remote Control (immediately, 3 sec., continuous), Auto Bracketing (3 frames)
Continuous Shooting	Approx. 6 fps, JPEG (12M) · ★★★ · Continuous Hi): up to 25 frames, RAW: up to 12 frames Approx. 2 fps, JPEG (12M) · ★★★ · Continuous Lo): until SD Memory Card is full, RAW: up to 36 frames



Built-in Flash

Type	Built-in P-TTL flash with serial control GN: approx. 16 (ISO200/m), approx. 12 (ISO100/m) Angle of view: equivalent to angle of view of 28mm lens (35mm format equivalent)
Flash Mode	P-TTL, Red-eye Reduction, Slow-speed Sync, Trailing Curtain Sync High-Speed Sync and Wireless Sync are also available with PENTAX dedicated external flash.
Sync Speed	1/180 sec.
Flash Exposure Compensation	-2.0 to +1.0EV

Capture Functions

Custom Image	Bright, Natural, Portrait, Landscape, Vibrant, Muted, Bleach Bypass, Reversal Film, Monochrome
Noise Reduction	Slow Shutter Speed NR, High-ISO NR
Dynamic Range Setting	Highlight Correction, Shadow Correction
Lens Correction	Distortion Correction, Lateral Chromatic Aberration Correction
Cross Processing	Random, Preset 1-3, Favorite 1-3
Digital Filter	Toy Camera, Retro, High Contrast, Extract Color, Soft, Starburst, Fish-eye, Custom Filter
HDR Capture	Auto, Standard, Strong 1, Strong 2, Strong 3, Automatic composition correction function
Multi-exposure	Select the number of shots between 2 and 9. Auto EV adjustment available.
Interval Shooting	Capture Interval setting (1 sec. to 24 hr.), Start Interval setting (immediate, designated time), Captures up to 999 images

Movie

File Format	Motion JPEG (AVI)
Recorded Pixels	 (1280 × 720, 16:9, 25 fps),  (640 × 480, 4:3, 25 fps)
Quality Level	★★★ (Best), ★★ (Better), ★ (Good)
Sound	Built-in monaural microphone
Recording Time	Up to 25 minutes; automatically stops recording if the internal temperature of the camera becomes high.
Custom Image	Bright, Natural, Portrait, Landscape, Vibrant, Muted, Bleach Bypass, Reversal Film, Monochrome
Cross Processing	Random, Preset 1-3, Favorite 1-3
Digital Filter	Toy Camera, Retro, High Contrast, Extract Color, Color

Playback Functions

Playback View	Single frame, image comparison, multi-image display (4, 9, 16, 36, 81 segmentation), display magnification (up to 16×, scrolling and quick magnification available), rotating, histogram (Y histogram, RGB histogram), bright/dark area warning, detailed information display, copyright information display (photographer, copyright holder), folder display, calendar display, slideshow
Delete	Delete single image, delete all, select & delete, delete folder, delete instant review image
Digital Filter	Toy Camera, Retro, High Contrast, Sketch Filter, Water Color, Pastel, Posterization, Miniature, Base Parameter Adjustment, Monochrome, Color, Extract Color, Soft, Starburst, Fish-eye, Slim, HDR, Custom Filter
RAW Development	File Format (JPEG), Custom Image, White Balance, Sensitivity, High-ISO NR, Shadow Correction, Distortion Correction, Lateral Chromatic Aberration Correction, Color Space
Edit	Resize, Cropping (aspect ratio and slant adjustment available), Index, Movie Edit (divide or delete selected frames), Capturing a JPEG still picture from a movie

Customization

Custom Functions	22 items
Mode Memory	13 items
Custom Button	<p>☉ button (Green button, Custom Image, Optical preview, Digital preview, Digital Filter, Cross Processing, One Push File Format)</p> <p>AF/AE-L button (AF, AE-L)</p>
Text Size	Standard, Large
World Time	World Time settings for 75 cities (28 time zones)
Language	English, French, German, Spanish, Portuguese, Italian, Dutch, Danish, Swedish, Finnish, Polish, Czech, Hungarian, Turkish, Greek, Russian, Korean, Traditional Chinese, Simplified Chinese, and Japanese
AF Fine Adjustment	±10 steps, Uniform adjustment
Copyright Information	Names of “Photographer” and “Copyright Holder” are embedded to the image file. Revision history can be checked using the provided software.

Power Supply

Battery Type	Rechargeable Lithium-ion Battery D-LI109 With AA battery holder D-BH109 (optional), four AA batteries (lithium, Ni-MH rechargeable, alkaline) can be used.
AC Adapter	AC Adapter Kit K-AC109 (optional)
Battery Life	(With D-LI109) Number of recordable images (with 50% flash usage): approx. 470 images, (without flash usage): approx. 560 images Playback time: approx. 300 minutes (With AA lithium batteries) Number of recordable images (with 50% flash usage): approx. 1,000 images, (without flash usage): approx. 1,600 images Playback time: approx. 620 minutes * Tested in compliance with CIPA standard. Actual results may vary depending on the shooting conditions/ circumstances.

Interfaces

Connection Port	USB 2.0 (high-speed compatible)/AV output terminal
USB Connection	MSC/PTP
Video Output Format	NTSC/PAL
Infrared Connection	Infrared connection in/out (IrSimple)

Dimensions and Weight

Dimensions	Approx. 125 mm (W) × 97 mm (H) × 68 mm (D) (excluding protrusions)
Weight	Approx. 544 g (body only), Approx. 598 g (including dedicated battery and SD Memory Card)

Accessories

Package Contents	USB Cable I-USB7, Strap O-ST53, Rechargeable Lithium-ion Battery D-LI109, Battery Charger D-BC109, Software (CD-ROM) S-SW110, <Mounted on the camera> Eyecup F _α , Hot shoe cover F _κ , Body mount cover
Software	PENTAX Digital Camera Utility 4

AdobeRGB

Color space recommended by Adobe Systems, Inc. for commercial printing. Wider range of color reproduction than sRGB. Covers most of the color range so colors available only when printed are not lost when editing images on a computer. When an image is opened by non-compatible software, the colors look lighter.

AE Metering

Brightness of subject is measured to determine exposure. In this camera, select from [Multi-segment Metering], [Center-weighted Metering] and [Spot Metering].

AF point

Position in the viewfinder that determines focus. In this camera, select from [Auto], [Select] and [Spot].

Aperture

The aperture increases or reduces the light beam (thickness) passing through the lens to the CMOS sensor.

Bright Portion

Overexposed area in an image loses contrast and appears white.

Camera Shake (Blur)

When the camera moves while the shutter is open, the entire image appears blurred. This occurs more often when shutter speed is low. Prevent camera shake by raising the sensitivity, using the flash, and raising the shutter speed. Alternatively, use a tripod to stabilize the camera. As camera shake is most likely to occur when pressing the shutter release button, use the Shake Reduction function, Self-timer or Remote Control shooting to prevent camera movement.

CMOS sensor

Photography element which converts light entering through the lens into electric signals that create an image.

Color Space

A defined range of colors from the spectrum which are used. In digital cameras, [sRGB] is defined as the standard by Exif. In this camera, [AdobeRGB], which supports a wider color gamut than sRGB, can be also used.

Color Temperature

This numerically expresses the color of the light source illuminating the subject. This is indicated in absolute temperature, using Kelvin (K) units. The color of light shifts to a bluish color as the color temperature rises, and to a reddish color as the color temperature falls.

Dark Portion

Underexposed area in an image loses contrast and appears black.

DCF (Design rule for Camera File system)

A digital camera file system standard established by the Japan Electronics and Information Technology Industries Association (JEITA).

Depth of field

Area of focus. This depends on the aperture value, lens focal length, and distance to the subject. For example, select a smaller aperture value (higher number) to increase the depth of field or use a larger aperture value (smaller number) to decrease the depth of field.

DNG RAW file

DNG (Digital Negative) is a general-purpose RAW file format designed by Adobe Systems. When images captured in proprietary RAW formats are converted to DNG format, support and compatibility for the images increases significantly.

DPOF (Digital Print Order Format)

Rules for writing information onto a card with recorded images regarding the specific images and number of copies to be printed. Prints can easily be made by taking the images to a DPOF photo printing store.

Dynamic Range (D-Range)

Indicated with a value expressing the light level reproducible in an image. This is the same as the term “Exposure latitude” used with silver halide film.

Generally, when the dynamic range is wide, overexposed and/or underexposed areas are less likely to occur within the image, and when the dynamic range is narrow, all image tones can be reproduced sharply and accurately.

EV (Exposure Value)

Exposure value is determined by a combination of the aperture value and the shutter speed.

EV Compensation

Process of adjusting the image brightness by changing the shutter speed and/or aperture value.

Exif (Exchangeable image file format for digital still camera)

A standard digital camera file format established by the Japan Electronics and Information Technology Industries Association (JEITA).

Exposure Bracketing

For automatically changing exposure. When the shutter release button is pressed, three images are captured. The first one has no compensation, the second is underexposed and the third is over-exposed.

Histogram

A graph that shows the darkest and brightest points in an image. The horizontal axis represents the brightness and the vertical axis represents the number of pixels. This is useful when you check the exposure level of an image.

ISO Sensitivity

The level of sensitivity to light. With a high sensitivity, images can be shot with a high shutter speed even in dark places, reducing camera shake. However, images taken with a high sensitivity are more susceptible to noise.

JPEG

An image compression method. In this camera, select from ★★★ (Best), ★★ (Better), or ★ (Good). Images recorded in JPEG format are suited for viewing on your computer or attaching to e-mail.

ND (Neutral Density) Filter

A filter available in different saturation levels that adjusts the brightness without affecting the color tone of pictures.

Noise Reduction

Process to reduce noise (image roughness or unevenness) caused by slow shutter speed or high sensitivity shooting.

NTSC/PAL

These are video output formats. NTSC is mainly used in Japan, North America, and South Korea. PAL is mainly used in Europe and China.

Quality Level

This refers to the image compression ratio. The lower the compression, the more detailed the image. The image becomes rougher as the compression rate rises.

RAW data

Unedited image data output from the CMOS sensor. RAW data is data before being internally processed by the camera. Camera settings at the time of capture, such as White Balance, Contrast, Saturation, and Sharpness can be set for each frame after shooting. In addition, RAW data is 12 bit data that contain 16 times the information of 8 bit JPEG data. Rich gradations are possible. Transfer RAW data to your computer and use the provided software to create image data with different settings, such as JPEG.

Recorded Pixels

Indicates the size of the image by the number of pixels. The more pixels that compose a picture, the larger the image size.

Shutter Speed

The length of time that the shutter is open and light strikes the CMOS sensor. The amount of light that strikes the CMOS sensor can be changed by altering the shutter speed.

sRGB (standard RGB)

International standard of color space established by the IEC (International Electrotechnical Commission). This is defined from color space for computer monitors and is also used as the standard color space for Exif.





























Vignetting

The picture edges are blackened when part of the light coming from the subject is blocked by the hood or filter ring, or when the flash is partially blocked by the lens.

White Balance

While shooting, color temperature is adjusted to match the light source so that the subject appears to have the correct color.

Symbols

- [ Rec. Mode] Menu 87, 304
- [ Playback] Menu 221, 307
- [ Set-up] Menu 266, 308
- [**C** Custom Setting] Menu
..... 89, 309
- [ (Playback) button
..... 21, 23, 82
-  (Green) button 21, 23, 197
-  **Av** (EV Compensation)
button 21, 117
-  **UP**/ (Flash pop-up/Delete)
button 21, 23, 78, 84
-  **AUTO PICT** Auto Picture 69, 92
-  Portrait 92
-  Landscape 92
-  Macro 92
-  Moving Object 92
-  Night Scene Portrait 92
-  Blue Sky 92
-  Flash Off 92
-  Night Scene 93
-  Surf & Snow 93
-  Food 93
-  Sunset 93
-  Stage Lighting 93
-  Night Snap 93
-  **HDR** Night Scene HDR 93
-  Kids 93
-  Pet 93
-  Candlelight 93
-  Museum 93
-  Movie 167

A

- AC adapter 50
- Accessories 320

- Action in **M** Mode 112
- Adding the date 286
- AdobeRGB 205, 337
- AE Lock 112, 120, 133
- AE Metering 114, 337
- AF Fine Adjustment 128
- AF assist light 19, 127
- AF** (Autofocus) 122
- AF/AE-L** button 21, 123
- AF coupler 19
- AF Mode 125
- AF point 129, 337
- AF160FC 180, 321
- AF200FG 180, 321
- AF360FGZ 180, 321
- AF540FGZ 180, 321
- Alkaline batteries 46
- Aperture 96, 337
- Aperture Priority Mode **Av** 108
- Aperture ring 104, 314
- Aspect ratio 251
- Auto Flash Discharge 77
- Auto Image Rotation 222
- Auto Picture **AUTO PICT** 69, 92
- Auto Power Off 281
- AWB** (White Balance) 200
- Autofocus **AF** 122
- Av** (Aperture Priority) Mode
..... 108
- AV cable 242
- AV device 242

B

- Base Parameter Adj (Digital
Filter) 253
- Battery 43, 46, 282
- Battery Type 282







- Beep 269
- Blue Sky  92
- Bright areas 31, 207, 337
- Bright/Dark Area warning 222
- Brightness adjustment 207
- Brightness Level 277
- Brightness of the monitor 277
- Built-in Flash 75
- Bulb shooting 113

- C**
- Calendar display 226
- Camera shake 141, 337
- Candlelight  93
- Capture Mode 91
- Card access lamp 19
- Catch-in Focus 136
- Center-weighted 115
- Charging 43
- City names 272
- Cloudy (White Balance) 200
- CMOS sensor 337
- CMOS sensor cleaning 315
- Color (Digital Filter) 156, 254
- Color of the monitor 278
- Color Space 205, 338
- Color Temperature 202, 338
- Computer 291
- Continuous Autofocus 133
- Continuous mode **AFC** 125
- Continuous Shooting 149
- Contrast (Custom Image) 213
- Contrast AF 160
- Contrast-Control-Sync mode
(flash) 189
- Control panel 26, 35
- Copyright Holder 283
- Correct exposure 96
- Creating New Folders 279
- Cropping 251
- Cross Processing 216

- CTE** (White Balance) 200
- Custom Filter (Digital Filters)
..... 156, 254
- Custom Image 213
- [**C** Custom Setting] Menu
..... 89, 309

- D**
- Dark areas 31, 208, 338
- Date Adjustment 64
- Date change 270
- Daylight (White Balance) 200
- Daylight-Sync Shooting 80
- DCF 338
- Default settings 304
- Delete 84, 236
- Delete all images 239
- Delete folder 238
- Deleting a single image 84
- Depth of field 97, 338
- Destination 270
- Detailed information display ... 28
- Developing 259
- Digital Filter 155, 253
- Digital Preview 137, 140
- Diopter adjustment 58
- Direct keys 34, 86, 304
- Display Color 276
- Display language 60, 273
- Distortion 211
- DNG 196, 338
- DPOF 285, 338
- Drive Mode 86
- Dueling Images 246
- Dust Alert 316
- Dust Removal 315
- Dynamic Range 99, 207, 339

- E**
- E-dial 21, 23
- E-dial in Program 105

- Editing movies 171
 Error message 325
 EV 339
 EV Compensation 117, 339
 **Av** (EV Compensation)
 button 21, 117
 EV Steps 118
 Exif 283, 339
 Exposure 96
 Exposure Bracketing 118, 339
 Exposure mode 103
 Exposure warning
 108, 109
 External flash 180
 Extract Color (Digital Filter)
 155, 254
 Eyecup 58
- F**
- Face Detection AF 160
 File Format 195, 196, 296
 File number 280
 Filter 155, 253
 Filter Effect (Custom Image)
 213
 Fish-eye (Digital Filter)
 155, 254
 Flash 75, 173
 Flash (White Balance) 200
 Flash Exposure Compensation
 81
 Flash Off  92
 **UP**/ (Flash pop-up/Delete)
 button 21, 23, 78, 84
 Fluorescent Light (White
 Balance) 200
 Focal length 143
 Focus indicator 70, 134
 Focus Lock 132
 Focus Mode 122
 Focus mode lever 21, 122
- Focus point 129, 337
 Focusing 122
 Focusing area 129
 Folder display 225
 Folder Name 279
 Food   93
 Format 268
 Four-way controller
 () 21, 23
- G**
- Game 246
 Green button 21, 23, 197
 Grid display 161
 Guide Display 24, 274
 Guide indicator 32
- H**
- HDR (Digital Filter) 254
 HDR Capture 209
 Help 300
 High Contrast (Digital Filter)
 155, 253
 High Dynamic Range 209
 High/Low Key Adjustment
 (Custom Image) 213
 High-ISO NR 100
 Highlight Correction 207
 High-Speed Flash Sync mode
 (flash) 182
 Histogram 30, 339
 Hometown 270
 Hue (Custom Image) 213
- I**
- Image Comparison 228
 Image plane indicator 19
 Image storage capacity 55
 Image Tone 213
 Index 229
INFO button 21, 23, 27

Infrared port	19
Infrared transmission	244
Initial settings	60
Initializing	268
Input Focal Length	143
Installing software	296
Instant Review	71, 276
Interval Shooting	151
IrSimple	244
ISO Sensitivity	98, 339

J

JPEG	195, 340
JPEG Quality	54, 193
JPEG Recorded Pixels	54, 192



K

Kelvin	202, 338
Kids 	93





L





Landscape 	92
Language setting	60, 273
Lateral chromatic aberration	211
LCD Color Tuning	278
Lens	56, 312
Lens Correction	211
Lens information contacts	19
Lens mount index	19
Lens unlock button	19, 21, 57
Lens with aperture ring	104, 314
Lithium batteries	46
Live View	159
Locking the exposure ...	120, 133
Locking the focus	132
LV button	21, 162





M

M (Manual) Mode	110
Macintosh	292
Macro 	92
Main switch	21, 23, 59
Manual Flash Discharge	78
Manual focus MF	134
Manual Mode M	110
Manual White Balance	202
Mass Storage Class	294
Matte Field	135
Memory	288
MENU button	21, 23, 37
Menu operation	37
Menu page display	275
Meter Operating Time	116
Metering method	114
MF (Manual focus)	134
Miniature (Digital Filter)	253
Mirror Lock-up	145
Mirror Up	318
Mode dial	21, 91
Monitor	24
Monochrome (Digital Filter)	253
Movie	165
Moving Object 	92
MSC	294
Multi-exposure	153
Multi-image display	224
Multiple flash shooting	188
Multi-segment	114
Museum 	93

N

ND (Neutral Density) Filter ...	340
Night Scene 	93
Night Scene HDR 	93
Night Scene Portrait 	92
Night Snap 	93

Ni-MH rechargeable batteries	46	Preview	137
Noise Reduction	100, 340	Product registration	301
NTSC	243, 340	Program Mode P	104
O		Protect	240
OK button	21, 23, 130	Provided software	296
One Push File Format	198	PTP	294
Optical Preview	137, 139	P-TTL (Flash)	186
Optional accessories	320	P-TTL Auto (Flash)	181
P		Q	
P (Program) Mode	104	Quality Level	54, 165, 193, 340
PAL	243, 340	Quick Zoom	222
Pastel (Digital Filter)	253	R	
PC/AV terminal	242	RAW	195, 340
PEF	196	RAW Development	259
PENTAX Digital Camera		RAW File Format	196
Utility 4	296	[ Rec. Mode] Menu	87, 304
Pet 	93	Recorded Pixels	54, 165, 192, 340
Phase Difference AF	160	Red-eye reduction	79, 186
Photographer information	283	Remaining image storage	
Picture mode	92	capacity	49
Picture Transfer Protocol	294	Remote Control	147
Pixel Mapping	287	Reset	310
Pixels	192	Resize	250
Playback	82	Retro (Digital Filter)	155, 253
 (Playback) button	21, 23, 82	Rotate	235
[ Playback] Menu	221, 307	S	
Playback mode palette	220, 307	Saturation (Custom Image)	213
Playback time	49	SCN (Scene) mode	93
Playing back images		SD Memory Card	52
continuously	232	Select & Delete	236
Playing back movies	169	Self-timer	145
Portrait 	92	Sensitivity	98
Posterization (Digital Filter)	253	Sensitivity Priority Mode Sv	106
Power	59	Sensor Cleaning	318
Press fully	72		
Press halfway	72		

[ Set-up] Menu	266, 308
Shade (White Balance)	200
Shadow Correction	208
Shake Reduction	141, 166
Sharpness (Custom Image)	213
Shooting Information	25
Show Grid	161
Shutter Priority Mode Tv	107
Shutter release button	21, 23, 72
Shutter speed	96, 340
Single mode A/FS	125
Sketch Filter (Digital Filter)	253
Slideshow	232
Slim (Digital Filter)	254
Slow Shutter Speed NR	102
Slow-speed Sync	174
Soft (Digital Filter)	155, 254
Sound	166
Spot Metering	115
sRGB	205, 341
Stage Lighting 	93
Starburst (Digital Filter)	155, 254
Status display	276
Status screen	25
Strap	42
Sunset 	93
Superimpose AF Area	129
Surf & Snow 	93
Sv (Sensitivity Priority) Mode	106
T	
Taking pictures continuously	149
Text Size	274
Toning (Custom Image)	213

Toy Camera (Digital Filter)	155, 253
Trailing Curtain Sync	176, 187
Transmission method	245
Tungsten Light (White Balance)	200
TV	242
Tv (Shutter Priority) Mode	107

U

USB Connection	293
USB Connection mode	293

V

Video Output Format	243
Viewfinder	32, 58
Vignetting	341

W

Water Color (Digital Filter)	253
White Balance	200, 341
Windows	292
Wireless flash control	186
Wireless Mode (Flash)	183
World Time	270
Write-protect	53

Z

Zoom display	223
Zoom lens	74

All PENTAX cameras purchased through authorized bona fide photographic distribution channels are guaranteed against defects of material or workmanship for a period of twelve months from date of purchase. Service will be rendered, and defective parts will be replaced without cost to you within that period, provided the equipment does not show evidence of impact, sand or liquid damage, mishandling, tampering, battery or chemical corrosion, operation contrary to operating instructions, or modification by an unauthorized repair shop. The manufacturer or its authorized representatives shall not be liable for any repair or alterations except those made with its written consent and shall not be liable for damages from delay or loss of use or from other indirect or consequential damages of any kind, whether caused by defective material or workmanship or otherwise; and it is expressly agreed that the liability of the manufacturer or its representatives under all guarantees or warranties, whether expressed or implied, is strictly limited to the replacement of parts as hereinbefore provided. No refunds will be made on repairs by non-authorized PENTAX service facilities.

Procedure During 12-month Warranty Period

Any PENTAX which proves defective during the 12-month warranty period should be returned to the dealer from whom you purchased the equipment or to the manufacturer. If there are no representatives of the manufacturer in your country, send the equipment to the manufacturer, with postage prepaid. In this case, it will take a considerable length of time before the equipment can be returned to you owing to the complicated customs procedures required. If the equipment is covered by warranty, repairs will be made and parts replaced free of charge, and the equipment will be returned to you upon completion of servicing. If the equipment is not covered by warranty, regular charges of the manufacturer or of its representatives will apply. Shipping charges are to be borne by the owner. If your PENTAX was purchased outside of the country where you wish to have it serviced during the warranty period, regular handling and servicing fees may be charged by the manufacturer's representatives in that country. Notwithstanding this, your PENTAX returned to the manufacturer will be serviced free of charge according to this procedure and warranty policy. In any case, however, shipping charges and customs clearance fees to be borne by the sender. To prove the date of your purchase when

required, please keep the receipt or bills covering the purchase of your equipment for at least a year. Before sending your equipment for servicing, please make sure that you are sending it to the manufacturer's authorized representatives or their approved repair shops, unless you are sending it directly to the manufacturer. Always obtain a quotation for the service charge, and only after you accept the quoted service charge, instruct the service station to proceed with the servicing.

- **This warranty policy does not affect the customer's statutory rights.**
- **The local warranty policies available from PENTAX distributors in some countries can supersede this warranty policy. Therefore, we recommend that you review the warranty card supplied with your product at the time of purchase, or contact the PENTAX distributor in your country for more information and to receive a copy of the warranty policy.**



The CE Mark is a Directive conformity mark of the European Union.

For customers in USA

STATEMENT OF FCC COMPLIANCE

This device complies with Part 15 of the FCC Rules. Operation is subject to the following two conditions: (1) This device may not cause harmful interference, and (2) this device must accept any interference received, including interference that may cause undesired operation.

Changes or modifications not approved by the party responsible for compliance could void the user's authority to operate the equipment.

This equipment has been tested and found to comply with the limits for a Class B digital device, pursuant to part 15 of the FCC Rules.

These limits are designed to provide reasonable protection against harmful interference in a residential installation. This equipment generates, uses and can radiate radio frequency energy and, if not installed and used in accordance with the instructions, may cause harmful interference to radio communications. However, there is no guarantee that interference will not occur in a particular installation.

If this equipment does cause harmful interference to radio or television reception, which can be determined by turning the equipment off and on, the user is encouraged to try to correct the interference by one or more of the following measures:

- Reorient or relocate the receiving antenna.
 - Increase the separation between the equipment and receiver.
 - Connect the equipment into an outlet on a circuit different from that to which the receiver is connected.
- * Consult the dealer or an experienced radio/TV technician for help.

For customers in Canada

This Class B digital apparatus complies with Canadian ICES-003.

Pour les utilisateurs au Canada

Cet appareil numérique de la classe B est conforme à la norme NMB-003 du Canada.

FOR CALIFORNIA, U.S.A. ONLY

Perchlorate Material-special handling may apply.

The lithium battery used in this camera contains perchlorate material, which may require special handling.

See www.dtsc.ca.gov/hazardouswaste/perchlorate

Declaration of Conformity

According to 47CFR, Parts 2 and 15 for
Class B Personal Computers and Peripherals

We: PENTAX Imaging Company
A Division of PENTAX of America, Inc.

Located at: 600 12th Street, Suite 300
Golden, Colorado 80401 U.S.A.
Phone: 303-799-8000 FAX: 303-790-1131

Declare under sole responsibility that the product identified herein complies with 47CFR Parts 2 and 15 of the FCC rules as a Class B digital device. Each product marketed is identical to the representative unit tested and found to be compliant with the standards. Records maintained continue to reflect the equipment being produced can be expected to be within the variation accepted, due to quantity production and testing on the statistical basis as required by 47CFR §2.909. Operation is subject to the following two conditions: (1) This device may not cause harmful interference, and (2) This device must accept any interference received, including interference that may cause undesired operation. The above named party is responsible for ensuring that the equipment complies with the standards of 47CFR §15.101 to §15.109.

Product Name: PENTAX Digital Still Camera

Model Number: ***K-r***

Contact person: Customer Service Manager

Date and Place: October, 2010, Colorado

Information for Users on Collection and Disposal of Old Equipment and Used Batteries



1. In the European Union

These symbols on the products, packaging and/or accompanying documents mean that used electrical and electronic equipments and batteries should not be mixed with general household waste.

Used electrical/electronic equipments and batteries must be treated separately and in accordance with legislation that requires proper treatment, recovery and recycling of these products.

Following the implementation by member states, private households within the EU states may return their used electrical/electronic equipments and batteries to designated collection facilities free of charge*.

In some countries your local retailer may also take back your old product free of charge if you purchase a similar new one.

*Please contact your local authority for further details.



By disposing of this product correctly you will help ensure that the waste undergoes the necessary treatment, recovery and recycling and thus prevent potential negative effects on the environment and human health which could otherwise arise due to inappropriate waste handling.

2. In other countries outside the EU

These symbols are only valid in the European Union. If you wish to discard these items, please contact your local authorities or dealer and ask for the correct method of disposal.



For Switzerland: Used electrical/electronic equipment can be returned free of charge to the dealer, even when you don't purchase a new product. Further collection facilities are listed on the home page of www.swico.ch or www.sens.ch.

Note for the battery symbol (bottom two symbol examples): This symbol might be used in combination with a designation for the chemical element or compound in use. In this case you have to comply with the requirement set by the Directive for the chemicals involved.

HOYA CORPORATION
PENTAX Imaging Systems Division

2-36-9, Maeno-cho, Itabashi-ku, Tokyo 174-8639, JAPAN
(<http://www.pentax.jp>)

PENTAX Europe Imaging Systems S.A.S.

(European Headquarters) 112 Quai de Bezons - BP 204,
95106 Argenteuil Cedex, FRANCE
(HQ - <http://www.pentaxeurope.com>)
(France - <http://www.pentax.fr>)

PENTAX Imaging Systems GmbH

Julius-Vosseler-Strasse, 104, 22527 Hamburg, GERMANY
(<http://www.pentax.de>)

PENTAX Imaging Systems Limited

PENTAX House, Heron Drive, Langley, Slough,
Berks SL3 8PN, U.K.
(<http://www.pentax.co.uk>)

PENTAX Imaging Company
A Division of PENTAX of America, Inc.

(Headquarters)
600 12th Street, Suite 300 Golden, Colorado 80401, U.S.A.
(PENTAX Service Department)
250 North 54th Street Chandler, AZ 85226, U.S.A.
(<http://www.pentaximaging.com>)

PENTAX Canada Inc. 1770 Argentia Road Mississauga, Ontario L5N 3S7, CANADA
(<http://www.pentax.ca>)

PENTAX Trading (SHANGHAI) Limited

23D, Jun Yao International Plaza, 789 Zhaojiabang Road,
Xu Hui District, Shanghai, 200032 CHINA
(<http://www.pentax.com.cn>)

- Specifications and external dimensions are subject to change without notice.