

Operating instructions

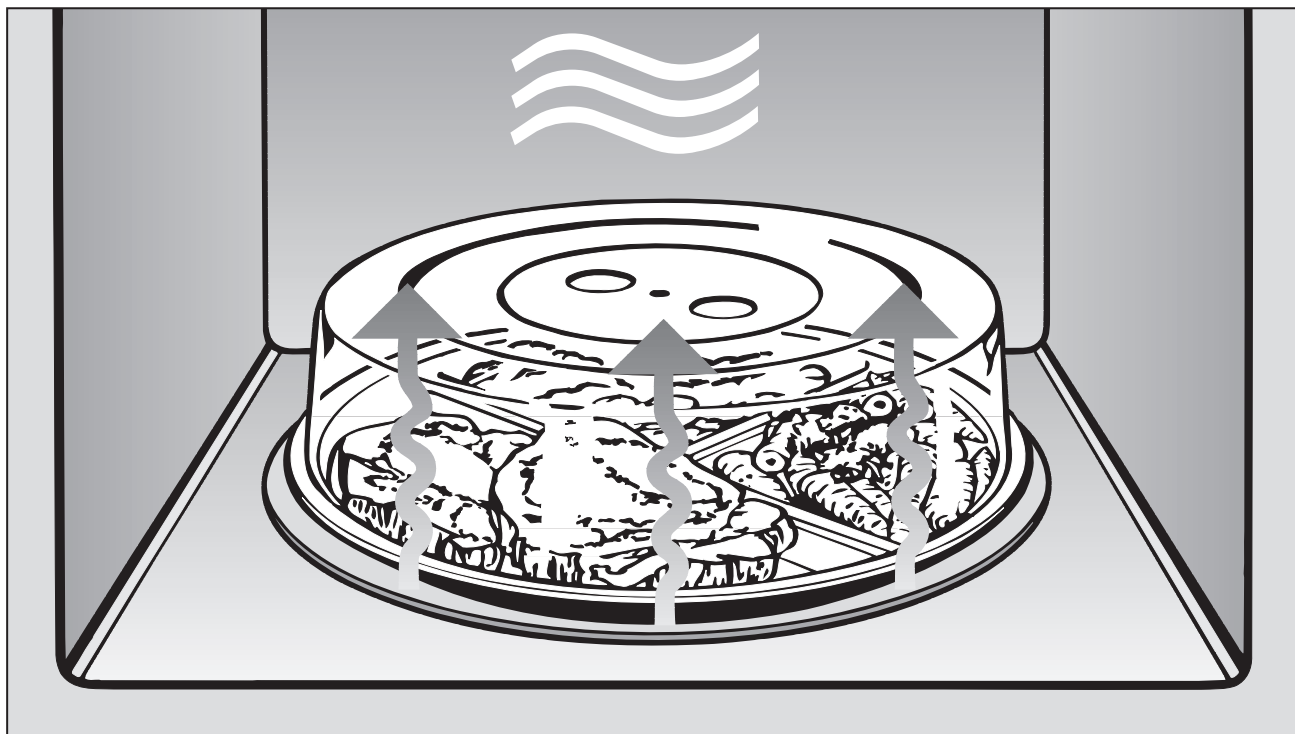

Microwave ovens

M 316 E

M 326 EG, M 336 EG

M 326 EC, M 336 EC

It is **essential** to read these operating instructions before installing or using the machine, to avoid the risk of accident or damage to the machine.



M.-Nr. 04 982 410













Contents

Description of the appliance	4
Caring for the environment	5
Warning and Safety instructions	6
How the microwave oven functions	11
Calculating power settings	12
Suitable containers for microwave ovens	
Material and shape	13
Testing dishes for their suitability	15
Preparation for use	
Setting the time of day	17
Minute minder	17
Audible tone	17
Function safety lock	17
Opening the door	18
Closing the door	18
Operating modes	19
Operation	
Microwave-Solo mode	20
Altering settings	21
Cancelling a process	21
Switching off the turntable	21
Fault indication	21
Automatic programmes (Microwave mode)	22
Grilling (not with M 316 E)	26
Microwave with Grill Combination mode (not with M 316 E)	26
Fan heat (only with models M 326 EC and M 336 EC)	27

Contents

Combination mode Microwave with Fan heat (only with models M 326 EC and M 336 EC)	28
Automatic programme "Proving dough" (only with M 326 EC and M 336 EC)	29
Sequential programming	30
Short step systems.	31
Delaying start	32
Practical tips	
Reheating	33
Cooking	34
Defrosting	35
Defrosting and reheating or cooking	36
Examples	37
Cleaning and care	38
Problem solving guide	40
After sales service	42
Electrical connection	43
Electrical connection and Installation	44
Technical data	45

Description of the appliance

- ① Display area
- ② Selection touchpads: (without and with microwave respectively)
 - Grill , 
 - Fan Heat , 
 (available with some models only)
- ③ Automatic touchpads (Microwave mode)
- ④ Selection touchpads: Microwave mode  P +/-
- ⑤ Touchpads: Fan Heat temp. °C +/-
- ⑥ Auto touchpad: "Proving dough" 
- ⑦ Programme memory store touchpads  1/2
- ⑧ START touchpad 
- ⑨ Cancel touchpad C
- ⑩ Function touchpads: Timer switch , Delay start  decrease/increase +/-
Turntable , Clock 
(symbol crossed through on facia)
- ⑪ Rotary selector (Input weight, time)
- ⑫ Door button 

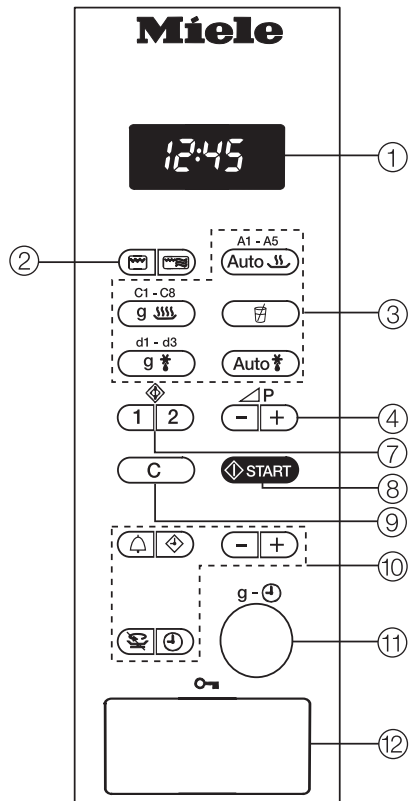

**M 326 EG,
M 336 EG**

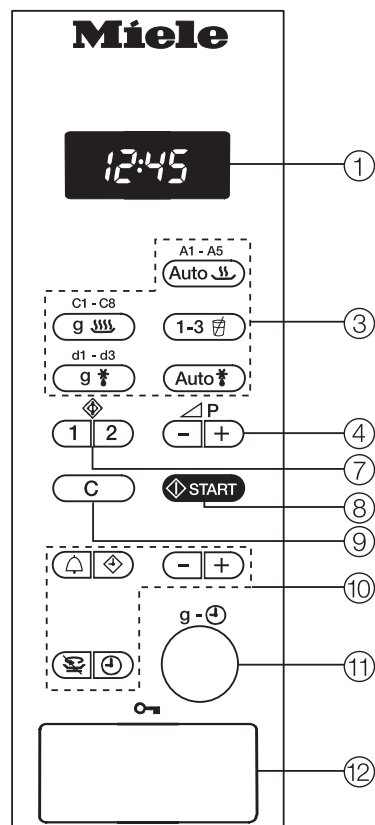

M 316 E

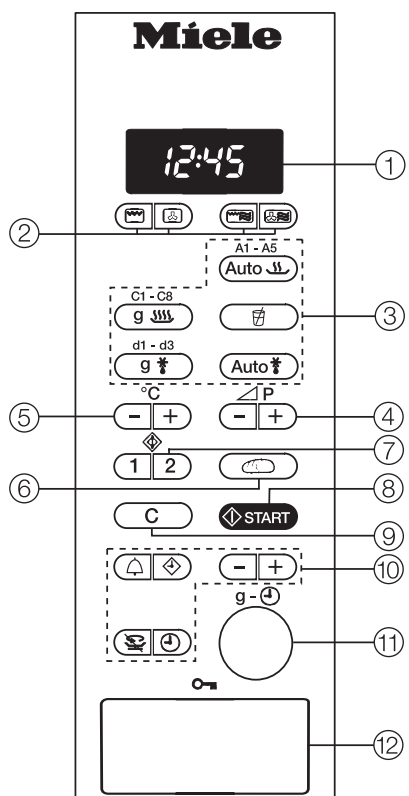

**M 326 EC,
M 336 EC**

Disposal of the packing material

The transport and protective packing has been selected from materials which are environmentally friendly for disposal and can normally be recycled.

Rather than just throwing these materials away, please ensure they are offered for recycling.

Disposal of your old machine / appliance

Old machines or appliances may contain materials which can be reclaimed or recycled. Please contact your dealer, your local waste collection centre or scrap merchant about potential recycling schemes.

Ensure that the machine or appliance presents no danger to children while being stored for disposal.

See the appropriate section in the "Warning and Safety" instructions.

Warning and Safety instructions

This appliance complies with all relevant legal safety requirements. Improper use of the appliance can, however, present a risk of both personal injury and material damage. Before installation and before using the appliance for the first time, read the operating instructions carefully. They contain important notes on safety, on the operation and care of the appliance. This way you will avoid the risk of accidents and damage to the appliance. Do not let children access the appliance or its controls. Supervise its use by the elderly or infirm. Keep these instructions in a safe place and pass them on to any future user.

Correct usage

The appliance is intended for domestic use only: to cook food, and in particular to defrost, re-heat, cook, and to grill (except M 316 E). Any other usage is at the owner's risk and could be dangerous. The manufacturer cannot be held responsible for damage caused by improper use of the appliance.

Technical safety

Do not use the microwave if

- the door is warped.
- the door hinges are loose.
- holes or cracks are visible in the casing, the door, the door seal or the oven interior walls. Switching on with this type of damage could result in micro-

waves no longer being contained within the oven, and presenting a hazard to the user.

Installation work and repairs may only be carried out by suitably competent, authorised persons trained by the manufacturer to ensure safety. Repairs and other work by unqualified persons could be dangerous.

Never open the casing of the appliance.

Tampering with electrical connections or components and mechanical parts is highly dangerous to the user and can cause operational faults.

If the connection cable is damaged the new cable must be fitted by a Miele service engineer or an authorised agent.

Before connecting the appliance to the mains supply make sure that the rating on the data plate corresponds to the voltage and frequency of the household supply. It is essential that these data correspond as otherwise damage will occur to the machine. If in doubt consult a suitably competent person.

The electrical safety of this appliance can only be guaranteed when continuity is complete between the appliance and an effective earthing system, which complies with local and national regulations. It is most important that this basic safety requirement is tested by a qualified electrician. The manufacturer cannot be held responsible for the consequences of an inadequate earthing system, such as electric shock.

Warning and Safety instructions

■ The appliance is only completely isolated from the electricity supply when:

- it is switched off at the wall socket and the plug removed. Hold the plug and do not pull on the cable to remove the plug.
- The house mains fuse is switched off. The fuse is screwed out (in countries where this is applicable).

■ Do not connect the appliance to the mains electricity supply by an extension lead.

Extension leads do not guarantee the required safety of the appliance, (for example danger of overheating).

Use

■ Always ensure that food has been thoroughly heated before eating. Many factors will affect the overall cooking time, including the size and amount of food, its initial temperature, changes to recipe and the shape and size of cooking container. Some foods may contain micro organisms which are only destroyed by thorough cooking, therefore when cooking or re-heating foods, e.g. poultry it is particularly important that food is fully cooked through (at more than 70 °C, for more than 10 minutes). If in doubt select a longer cooking or re-heating time.

■ It is important that the heat is allowed to spread evenly throughout the food being cooked. This can be achieved by stirring and/or turning the food, and by observing a sufficiently long standing time, which

should be added to the time needed for cooking, re-heating or defrosting.

■ Always remember that cooking times in a microwave oven are usually considerably shorter than with traditional methods of food preparation. Excessively long cooking times can lead to food drying out and eventually burning, or could even cause it to catch fire.

There is also a danger of fire if bread-crumbs, flowers, herbs, etc., are dried in the microwave oven. Always ensure that this type of procedure is supervised.

■ Do not use full power if you warm empty dishes or dry herbs. The lack or minimum amount of food could cause damage to the appliance.

■ Never cook or reheat food or liquids in sealed containers or bottles. With baby bottles the screw top **and** teat must be removed. Otherwise pressure builds up which can cause the bottle or container to explode posing a severe risk of injury.

■ Always check the temperature of the actual food itself after taking it out of the microwave. Do not be misled by the temperature of the container. **In particular when preparing food for babies, children, and the elderly or infirm, it is essential to check the temperature of the food or liquid itself, after stirring and before serving.** The temperature of the container does not necessarily give a correct indication of the temperature of the food or liquid it contains.

Warning and Safety instructions

When heating liquids, the boiling rod provided should be placed into the container.



When heating, and especially reheating liquids, milk, sauces etc., in the microwave oven, the boiling point of the liquid may be reached without the production of typical bubbles. The liquid does not boil evenly throughout. This so-called 'boiling delay' can cause a sudden build up of bubbles, when the container is removed from the oven or shaken. This can lead to the liquid boiling over suddenly and explosively. There is a danger of burning. The formation of bubbles can be so strong that the pressure forces the oven door open. The user could be injured and the appliance damaged.

The boiling rod ensures that the liquid boils evenly and that bubbles form at an early stage during the operation.

If smoke occurs in the oven interior do not open the oven door, to avoid fuelling any flame. Cancel the process (press button C), switch off at the wall socket, and where applicable, remove the plug. Do not open the door until the smoke has dispersed.

Never heat undiluted alcohol in the microwave oven as this can easily ignite.

Do not use any containers or cutlery made from or containing metal, aluminium foil, lead crystal glassware, temperature-sensitive plastics, wooden utensils or cutlery, metal clips or wire ties. Do not use bowls with milled rims, or cream pots with the tin-foil lid partly removed. Such items could be damaged, or cause a fire hazard.

The accessories supplied with the appliance (except for M 316 E) are designed to be compatible with microwaves, and can therefore be used when working in microwave mode.

Eggs can only be cooked in their shells in the microwave oven in a specially designed egg-boiling device. Similarly, hard-boiled eggs should not be reheated in the microwave oven as this may lead to the eggs bursting, even once they have been removed from the oven.

Eggs can be cooked without their shells in the microwave oven only if the yolk membrane has been punctured several times first. The pressure would otherwise cause the egg yolk to explode.

Food with a thick skin or peel, such as tomatoes, sausages, jacket potatoes, aubergines, should be pierced or cut in several places to allow steam to escape and prevent the food from bursting.

Warning and Safety instructions

Do not reheat food in the oven in heat-retaining bags intended for normal ovens.

These heat-retaining bags usually contain a thin layer of aluminium foil which reflects microwaves. This reflected energy can, in turn, cause the outer paper covering to become so hot that it ignites.

Always ensure that food or the browning dish has been placed in the microwave oven, and that the turntable is in place, before switching on.

Do not leave the oven unattended when cooking with oils and fats as these can be a fire hazard if allowed to overheat.

Ovenproof earthenware can retain a considerable amount of moisture. Earthenware and porcelain containers with hollow handles and lid knobs must only be used in this oven if they have vent holes, which allow the moisture to escape. Without vent holes there can be a pressure build-up, causing the container to crack or shatter, dangerously.

In all operating modes, except Microwave-Solo, the oven interior, the grill element, the oven door and the housing get hot.

Do not let small children touch the oven while it is in operation, there is a danger of being burnt.

Supervise its use by the elderly or infirm.

Wear oven gloves when taking dishes in and out of the oven, or when handling dishes or food in the oven if the oven is or has just been in operation.

When placing food to be cooked directly on the glass tray (if supplied), always place a rack under the glass tray so that heat can also reach the food from underneath. The rack and the glass tray become hot during operation. There is a danger of being burnt.

Do not use the oven to heat up the room. Due to the high temperatures radiated, objects left near the oven could catch fire.

To measure the food temperature only use a thermometer specifically approved for use in a microwave oven. Never use a thermometer with mercury or liquid.

Under no circumstances use a steam cleaner to clean this appliance. Pressurised steam could give rise to a short circuit, or cause permanent damage to the surface and to components, for which the manufacturer of the oven cannot accept any responsibility.

In countries which may be subject to infestation by cockroaches or other vermin, pay particular attention to keeping the appliance and its surroundings in a clean condition at all times. Any damage which might be caused by cockroaches or other vermin will not be covered by the appliance guarantee.

Warning and Safety instructions

When using browning dishes:

- Always use oven gloves when handling the browning dish to avoid burns.
- Out of the oven always place the browning dish on a suitable heat-resistant mat, grid or board to protect the work surface or table, which could otherwise be heat-marked.
- Use browning dishes in a microwave oven only, or as a serving dish. In a conventional oven the special glaze would suffer damage.

Disposal of old appliances

- Before discarding an old machine switch off and disconnect it from the power supply. Cut off and render any plug useless.

Cut off the cable directly behind the machine to prevent misuse.

The manufacturer cannot be held liable for damage caused by non-compliance with safety instructions.

How the microwave oven functions

In the microwave oven, food is cooked, reheated or defrosted considerably more quickly than by any other method.

How does the microwave oven function?

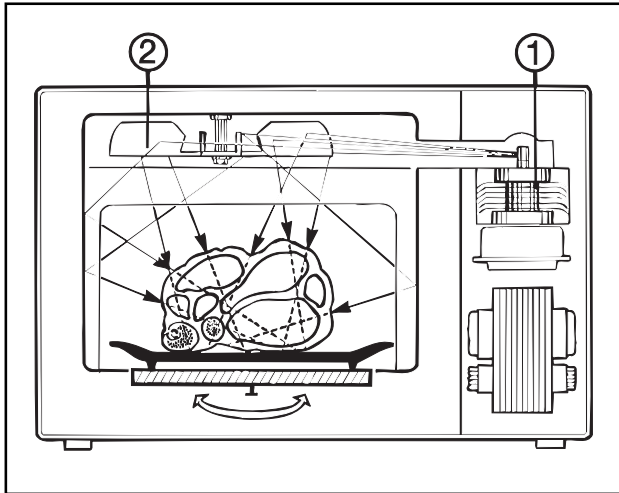

In a microwave oven there is a high-frequency tube called a magnetron ①. This converts electrical energy into microwaves. These microwaves are distributed evenly throughout the oven interior by a metal fan blade known as a stirrer ② -, rebounding off the stainless steel sides of the oven interior and thereby reaching the food from all sides. Microwave distribution is improved by engaging the turntable.

In order for microwaves to reach the food, they must be able to penetrate the cooking utensil being used. Microwaves can penetrate porcelain, glass, cardboard and plastics but not metal. Do not, therefore, use utensils made of metal, or which contain metal, for example in the form of gold or silver trim. The metal reflects the microwaves and this could lead to the creation of sparks. The microwaves cannot be absorbed.

Microwaves pass through a suitable container and find their way directly into the foodstuff. All foodstuffs contain moisture molecules which, when subjected to microwave energy, start to oscillate 2.5 thousand million times a second. The friction caused by this vibration creates heat, which first starts developing around the outside of the foodstuff and then slowly penetrates towards the centre. The moisture, fat and sugar content of food will affect the speed at which it is cooked.

As heat is produced directly in the food,

- food can generally be cooked without adding much liquid or cooking oil.
- cooking, reheating and defrosting in a microwave oven is quicker than using conventional methods.
- nutrients, such as vitamins and minerals, are retained.
- colour, texture and taste of food are not impaired.

Calculating power settings

This microwave has 9 power settings. Very often, power is expressed in watts on food packaging or in general recipes for microwaving.

The following table should help to convert the watts given to a matching power setting with these ovens.

Set-ting	Microwave oven with max.:		
	750/ 800 Watt [Watt]	850 Watt [Watt]	900/ 1000 Watt [Watt]
1	80	80	100
2	150	150	200
3	200	250	300
4	300	350	400
5	400	450	500
6	450	500	600
7	550	600	700
8	600	700	800
9	750/800	850	900/1000

Example:

A recipe states:

Cook in the microwave at 850 watts initially for approx. 5 minutes. Then continue for 20 minutes at 450 watts.

For the microwave with 850 watts maximum power, using the table for guidance this converts to:

Cook in the microwave at setting 9 initially for approx. 5 minutes. Then continue for 20 minutes at setting 5.

Where the recipe gives a wattage which does not correspond exactly to the table, select the nearest power setting available. It may be necessary to adjust the time very slightly to compensate.

For appliances with a maximum setting of 1000 watts we recommend using the top setting (9) to heat clear liquids and bring them to the boil. To prepare noodles and vegetables setting 8 is suggested followed by 4 or 5.

The maximum microwave power output in watts and the intermediate scale of settings in watts are given for each model of oven on the data plate, located at the rear of the oven.

Please make a note of these.

Examples of use given later in this book refer to oven models with a maximum microwave power output of 900/1000 watts. Adjust according to the table on this page for ovens with a different scale of output watts.

Suitable containers for microwave ovens

Microwaves

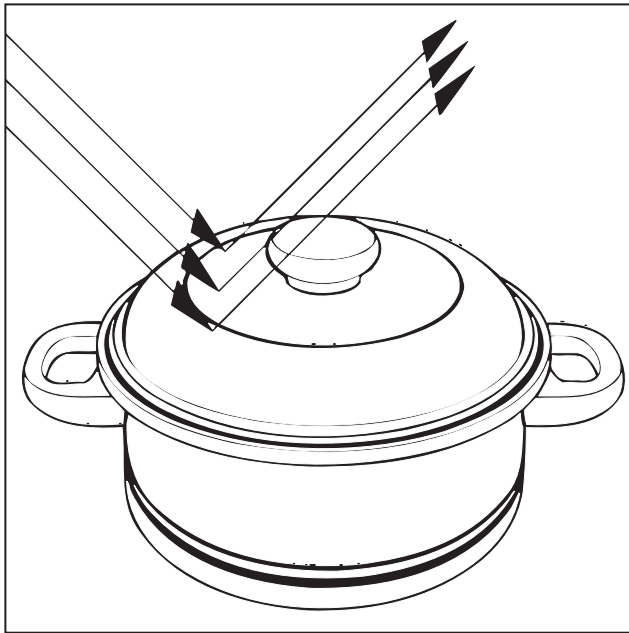

- are reflected by metal.

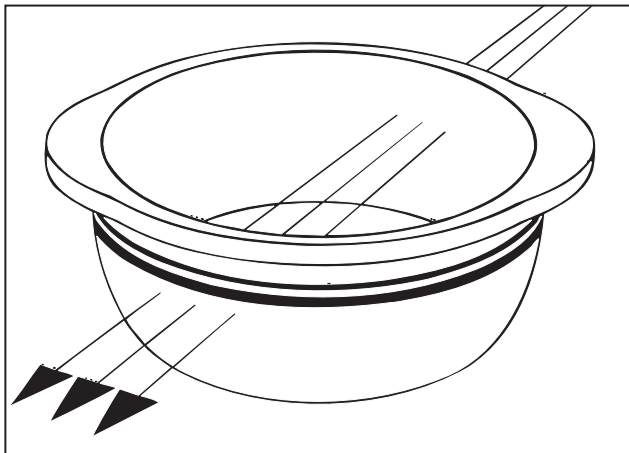

- pass through glass and china-ware, . . .

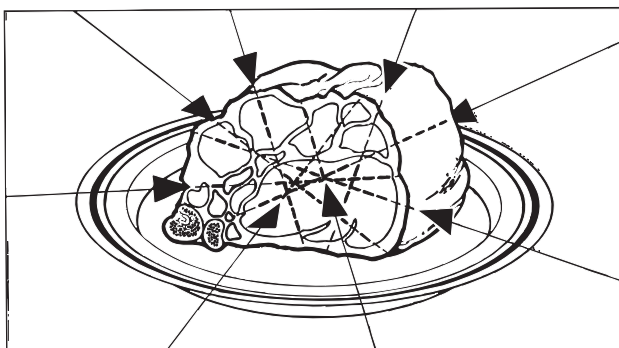

- and are absorbed by food.

Material and shape

The material and shape of containers used affect the cooking results and times. Round and oval shaped ones provide good results. Heat distribution is more even than it is in rectangular containers.

Metal

The following do not belong in an oven being used in microwave mode. Metal containers, aluminium foil and metal cutlery, or china with metallic decoration, such as gold rims or cobalt blue.

The metal reflects the microwaves, hindering the cooking process.

Exceptions:

- If recommended by the producer, pre-cooked meals packed in aluminium foil containers can be defrosted and reheated in the microwave oven. Important: remove the lid first. The disadvantage is that the food is only heated from the top. It is better to remove the food from the aluminium foil container and transfer it to a dish suitable for a microwave oven. The heat distribution will be more even.

If sparks and arcing occur when using a metal container, stop and transfer the food to a microwave safe container.

- Small pieces of aluminium foil. For even defrosting and to avoid overcooking unevenly shaped cuts of meat, poultry or fish, small areas of aluminium foil may be used to mask wingtips or other thin parts for the last few minutes

Suitable containers for microwave ovens

of the process. The aluminium foil must not touch the interior of the oven.

Make sure that the aluminium foil is at least 2 cm from the oven walls at all times. It must not touch the walls.

– Metal meat skewers or clamps
Metal skewers and clamps should only be used if they are very small in comparison to the size of the cut of meat.

Glassware

Heat-resistant glass or ceramic glass are ideal for use in the microwave oven.

Crystal glass contains lead which could cause the glass to crack. Glass dishes with a milled rim are subject to the same risk. Both are unsuitable for use.

Porcelain (chinaware)

Porcelain (chinaware) is suitable

Do not use porcelain with gold or silver edging or items with hollow knobs or handles, as insufficient ventilation may cause pressure.

Earthenware

Decorated earthenware is only suitable if the decoration is beneath an all-over glaze. Earthenware can get very hot, and may crack.

Glazes and colours

Some glazes and colours contain metal.

This makes them unsuitable for use in a microwave oven.

Plastics

Plastic containers must only be used for microwave mode alone and not in normal oven mode. Plastics must be heat-resistant to a minimum of 180 °C.

Otherwise the plastic may melt and fuse with the food.

Special plastic utensils, designed for use in microwave ovens are available from most department and hardware stores. Melamine ware is not suitable as it absorbs energy and heats up. When purchasing plasticware, make sure that it is suitable for use in a microwave oven.

Disposable containers, such as trays made from polystyrene, can only be used for very short timed warming and reheating of food.

Plastic boiling bags can be used for cooking and reheating. They should be pierced beforehand so that steam can escape.

This prevents a build-up of pressure and reduces the risk of the bag bursting.

Suitable containers for microwave ovens

Roasting bags and **tubes** can be used. Roasting tubes should be about 40 cm longer and roasting bags about 20 cm longer than the food being roasted, and carefully tied with string. Turn the ends over and secure them. Holes should be made according to the manufacturer's instructions.

Do not use metal clips or wire ties coated in plastic or paper.

There is a danger that they will ignite when heated.

Wood

Wooden dishes are not suitable

Moisture contained in the wood evaporates when exposed to microwave energy, causing the wood to dry and crack.

Disposable containers



Only those plastic disposable containers which are specified by the producer as suitable for use in a microwave oven may be used.

Do not leave the oven unattended when re-heating or cooking food in disposable containers made of plastic paper or other inflammable material.

Disposable containers are not always recyclable or degradable.

Testing dishes for their suitability

If in doubt as to whether glass, earthenware or porcelain plates or dishes are suitable for use in a microwave oven, a simple test can be performed:

- Place the item you wish to test in the centre of the oven, fill a suitable small container with water and also place this in the oven.
- Shut the door
- Using touchpads  P +/- select setting 8, or setting 9 for the M 316 E.
- Enter a time of 30 seconds with the rotary selector.
- Do not switch off the turntable .
- Press the START  control.

If a crackling noise is heard accompanied by sparks during the test, switch off the appliance immediately.

Any crockery which causes this reaction is unsuitable for use in the microwave oven.

The water in the small container should be warm, but the dish cool. If the dish is very hot and the water is cold, it would be unwise to use the dish.

If any doubt exists about the suitability of containers, please contact the supplier.

This test cannot be used to check whether items with hollow knobs or handles are suitable for use in a microwave oven.

Suitable containers for microwave ovens

A cover

- prevents too much steam escaping, especially when cooking foodstuffs which need longer to cook, such as potatoes,
- shortens and evens out the cooking process,
- keeps the oven interior cleaner,
- prevents food from drying out,
- contains the aroma.

Do not use a lid / cover

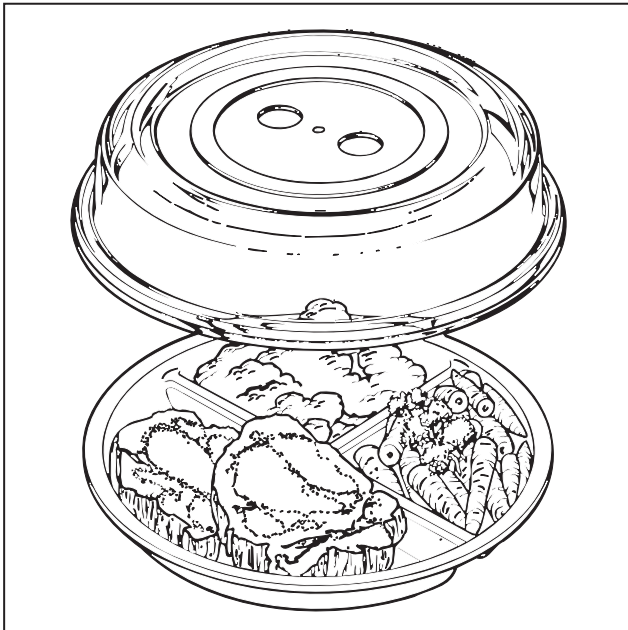

- if food coated with breadcrumbs is being cooked.
- cooking meals which are to be given a crisp finish.



Always use lids or covers made of microwave-safe glass or plastic, or use a clingfilm recommended for use in a microwave oven, (pierce as instructed by the producer).

Sealed glass containers, such as jars of food, must be opened before they are placed in the oven.

Setting the time of day

- Connect the appliance to the electricity supply.
All the displays light up in the display area.
- Press the C touchpad.
0 appears in the display area.
- Press the  touchpad and use the rotary control to set the hours.
- Press the  again and use the rotary control to set the minutes.
- Press the  touchpad to confirm the time now showing in the display area.
The two dots between the hours and minutes flash every two seconds.

The appliance is now ready for use.



Altering the time of day

- Press the  touchpad and set the time of day as described above.

Calling up the time of day

- Press the  touchpad to call up the time of day during a cooking process. The time of day will be shown for 5 seconds.

Minute minder

- Press the  touchpad.
:0 lights up in the display area and the time symbol flashes.
- Use the rotary control to set the minute minder time you require (5 seconds to 95 minutes).
The  symbol flashes in the display area.
- Press the  START touchpad.
In the display area the set time begins to count down in one second steps.
- An audible tone sounds after the minute minder time has elapsed.

Audible tone

An audible tone sounds after the set times have elapsed. The time of day reappears in the display area.

- Press the C touchpad to cancel the tone.

Function safety lock

- Press the +/- function touch pads at the same time.
The microwave oven can not now be used as all the programme functions are locked.
- Press the +/- at the same time again to cancel the function safety lock.
All the touchpads are available for use again.

If the appliance is disconnected from the electricity supply the function safety lock is switched off.

Preparation for use

Opening the door

- Press the "🔌" button to open the door.

If the microwave oven is being used, opening the door will interrupt the cooking process and the interior lighting will go out.

Closing the door

- Push the door firmly to.

Press the  START touchpad to continue an interrupted cooking process.

The appliance will not start again if the door has not been closed properly.

M 326 EC, M 336 EC





The 5 modes listed below are available on these models.

M 326 EG, M 336 EG

Here you can choose between 3 operating modes - Microwave-Solo, Grill, and combination mode Microwave and Grill.

M 316 E

The Microwave-Solo mode is available on this model. Fan Heat and Grilling (with or without microwave function are not available).

- **1. Microwave-Solo mode**  **P**
suitable for defrosting, reheating or cooking.
- **2. Grilling** 
is ideal for grilling flat items, e.g. fish or meat steaks, or sausages.
- **3. Fan Heat** 
is ideal for baking.
- **4. Combination mode - Microwave with Grilling** 
is ideal for crisping and browning. The microwave cooks the food, the grill browns the surface.
- **5. Combination mode - Microwave with Fan Heat** 
This combination mode is useful for the speedy preparation of dishes in a sauce.
The two functions combined not only cook the food but turn the surface golden.

Automatic programmes

The microwave mode offers the five automatic programmes listed below:

- reheating dishes,
- reheating liquids,
- defrosting using an entered time,
- defrosting using an entered weight,
- cooking using an entered weight.

The M 326 EC and M 336 EC models also have a "proving dough" automatic fan heat programme.

Sequential programming

You can programme up to 3 functions to run one after the other.

Short step system

With the  1/ 2 touchpads you can store in memory programmes which are frequently used.

These two programme stores are reusable.

Delayed start

Start can be delayed by up to 24 hours.

Operation

Microwave-Solo mode

There is a choice of up to 9 different microwave power settings.

The higher the power setting, the more microwaves reach the food.

When heating up food of differing composition, or which cannot be stirred or turned during cooking, as with a plated meal, it is preferable to heat these on a lower power setting. This ensures that the heat is distributed evenly. Heat for long enough to reach the temperature required.

Times for defrosting, reheating and cooking

The necessary time depends on:

- the initial temperature of the food.
Food taken from the refrigerator will need longer to be reheated or cooked than food already at room temperature.
- the type, texture and consistency of the food.
Fresh vegetables usually contain more water and cook more quickly than stored vegetables.
- the shape and material of the container.
- the amount of food.

In general:



As a general rule double quantity – approx. time and a half.

Smaller quantity, possibly shorter time but ensure food is cooked thoroughly.

Ideally the container should be placed in the centre of the oven.

- Press the  P +/- touchpads and select the power level required (P1 to P9).

The  symbol for Microwave Mode and the power setting selected will appear in the display area, and the time symbol flashes.

- Use the rotary control to enter a cooking time (5 seconds up to 95 minutes).
The  symbol for Microwave Mode and the cooking time selected appear in the display, the  symbol flashes.

- Press the  START touchpad.
The time entered begins to count down in seconds in the display area.

At the end of the cooking time an audible tone sounds. The time of day reappears in the display area.

- Press the C touchpad to cancel the audible tone.

To achieve good results it is essential that the appliance is cool. If the oven interior temperature is too high the fault message "E" appears in the display area. If this happens allow the appliance to cool down with the door open for about 15 to 20 minutes. Press the C touchpad and then enter the settings again.

Calling up the microwave power setting

Press the  P + or - touchpads, if you want to check the power setting during a process. The power setting will appear for 5 seconds.

Altering settings

Before a process has begun

- Alter the settings before starting the programme.

After a process has begun

- press the C touchpad.
A new setting can now be entered.
- Press the  START touchpad, to restart the process.

Cancelling a process

- Press the C touchpad, to cancel any functions that have been entered, if for example the food is cooked before the set time.
The time of day appears.

Switching off the turntable

The turntable is always switched on and should only be switched off if there is a danger of something blocking it, e.g. a large dish which is wider than the turntable.

- Press the  touchpad to switch off the turntable. This can be done either before starting or during the cooking process.

Fault indication

- Allow the appliance to cool down with the door open for about 15 - 20 minutes, if an "E" shows in the display, indicating that the oven interior is too hot.
- Then press the C touchpad and re-enter the settings.

Operation

Automatic programmes (Microwave mode)





With microwave mode there is the choice of five automatic programmes as follows:

- Reheating various dishes,
- Reheating liquids,
- Timed defrosting,
- Defrosting according to weight,
- Cooking according to weight.

Automatic reheating of various dishes (Auto)

The following programmes are available:

Pro-gramme	Dish
A 1	small plated meal
A 2	large plated meal
A 3	jacket potatoes
A 4	doughs
A 5	casseroles

- Press the **Auto**  touchpad. A 1, AUTO and the symbol for microwave mode  light up, the  symbol and +/- flash.
- Select the programme you want by pressing the **Auto**  touchpad as many times as necessary.

Specific heating-up times are pre-programmed for individual dishes. These can be adapted if you prefer a longer or shorter time.

There are 5 possible time settings for each dish.

- Press the +/- touchpads to lengthen or shorten the reheating time. For example if you press the + touchpad twice, 2 and + appear in the display area. The longest time setting has been chosen.
- Press the  START touchpad. The set time appears in the display area and begins to count down in one second steps. An audible tone sounds when the time has elapsed. The time of day reappears in the display area.
- Ensure that the food is given sufficient standing time, eg at least one minute with menus A 1, A 2 and A 4 and three minutes with A 5. Standing time is a resting time at room temperature during which the temperature is distributed evenly to all parts of the food.

Ensure that the food is thoroughly heated through. If necessary extend the heating time manually.

Automatic heating of liquids (☞)



With this programme you can heat up (or reheat) liquids in cups or mugs.

1 – 3 cups can be heated at a time.
The programme assumes 150 to 225 ml per cup.

If you wish to heat more or less liquid you can adapt the appropriate heating up time.

There are 5 possible time settings.

When (re)heating liquids in the microwave oven the boiling rod provided must be placed into the container. (Alternatively, when (re)heating more than one cup place a plastic or glass spoon in each cup). The liquid will then boil evenly, and a boiling surge is avoided.

- Press the ☞ touchpad.
CUP 1, AUTO and the symbol for Microwave mode  appear in the display area, in addition the symbol  and +/- flash.
- Press the ☞ (CUP 1, CUP 2 or CUP 3) touchpad until you reach the programme required.
- Press the + or - touchpads, if you wish to lengthen or shorten the time. For example, if you press the + touchpad twice, "2" and + appear in the display area, showing that you have selected the longest time possible.

- Press the  START touchpad.
The set time appears in the display area and begins to count down in one second steps.
An audible tone sounds when the time has elapsed.
The time of day reappears in the display area.

Automatic defrosting using a time entry (Auto ☞)

Only use this programme with food up to a max. 450 g in weight.

- Press the **Auto** ☞ touchpad.
:0, the symbol for Defrost and AUTO light up in the display area, and the time symbol flashes.
- Enter the defrost time required using the rotary control.
- Press the  START touchpad.
The set time appears in the display area and begins to count down in one second steps.
An audible tone sounds when the time has elapsed.
The time of day reappears in the display area.

Operation

Automatic defrosting using a weight entry (g \star)

Three programmes are available.

Programme	Type of food
d 1	poultry
d 2	meat
d 3	fish

- Press the **g \star** touchpad.
In the display d 1, the symbol for Defrost and AUTO appear. The weight symbol g flashes.
- Press the **g \star** touchpad until you reach the required programme.
- Use the rotary control to enter the weight of the food (25 g – 4000g). The weight entered, the Defrost symbol and AUTO show in the display, the symbol \diamond and +/- flash.
- Press the + or - touchpads, if you wish to lengthen or shorten the time. For example, if you press the + touchpad twice, "2" and + appear in the display area, showing that you have selected the longest time possible.
- Press the \diamond START touchpad.
The appliance automatically calculates the necessary defrost time, which appears in the display area and begins to count down in one second steps.
To achieve good results, turn or rearrange the food during the cooking process.

An audible tone sounds at one third and two thirds of the time set.

- When the tone sounds, open the door and either turn or rearrange the food. Then close the door and press the \diamond START touchpad to continue the interrupted process.

An audible tone also sounds when the time has elapsed.

The time of day reappears in the display area.

Leave the food to stand at room temperature for a few minutes after defrosting, (standing time), so that the temperature is distributed more evenly throughout the food.

Before cooking check that the food is completely defrosted.

Dear Customer,

Congratulations on the purchase of your new Miele microwave oven.
We trust you will be delighted with the wide range of programmes
and applications it has to offer.

To help you make the most of your oven, we would be pleased to send you,
free of charge, a copy of the

Good Housekeeping Essential Microwave Handbook.

This prestigious book contains over a hundred delicious recipes, all tested on
Miele 850 W microwave ovens. Furthermore, it offers comprehensive advice on
the basics of microwave cooking, how to use the different cooking techniques to
best advantage and timing charts for thawing and cooking many types of food.

Please fill in the slip below and send it to:

Miele Company Limited, Fairacres, Marcham Road, Abingdon, Oxon OX14 1TW

Please note, this offer applies only to new microwave ovens purchased in the UK.



I have purchased a Miele microwave oven, model

from (name of retailer).....town.....

Please send me the ***Good Housekeeping Essential Microwave Handbook.***

Name:.....

Address:.....

.....

.....





.....

Signed:.....Date:.....

Automatic cooking using a weight entry (g)

There is a choice of 8 programmes.

Programme	Type of food
C 1	Chicken
C 2	Jacket potatoes
C 3	Beef, well done
C 4	Beef, medium
C 5	Beef/ Lamb, rare
C 6	Lamb, medium
C 7	Lamb, well done
C 8	Pork

- Press the **g**  touchpad. C 1,  the symbol for microwave mode and AUTO light up, the weight symbol **g** flashes.
- Press the **g**  touchpad enough times to select the programme you require.
- Use the rotary control to enter the weight (25 g – 4000 g). The weight entered,  the symbol for microwave mode and AUTO light up, the  symbol and +/- flash.
- Press the +/- function touchpads to lengthen or shorten cooking time. For example, if you press the + touchpad twice, 2 and + appear in the display area. This indicates that you have chosen the longest cooking time.

- Press the  START touchpad. The necessary cooking time is calculated automatically. This time will appear in the display area and begin to count down in one second steps.

To achieve good results, turn or rearrange the food during the cooking process.

- When the tone sounds, open the door and either turn or rearrange the food. Then close the door and press the  START touchpad to continue the interrupted process.

An audible tone also sounds when the time has elapsed.



The time of day reappears in the display area.

Leave the food to stand at room temperature for a few minutes after cooking, (standing time), so that the temperature is distributed more evenly throughout the food.

Operation

Grilling

(not with M 316 E)



- Place the food on the rack or on the turntable. The glass tray can be placed under the rack to catch any oils or cooking juices.
- Press the  touchpad. :0 and the Grill symbol appear in the display area, the time symbol flashes.
- Use the rotary control to enter the required grilling time.
- Press the  START touchpad. The grilling time will appear in the display area and count down in one second steps. At the end of this time an audible tone sounds. The time of day reappears in the display area.

Flat pieces of fish and meat should usually be turned half way through grilling for an even finish. Larger pieces should be turned several times. If the total grilling time is less than 15 minutes, pre-heat the grill for approx. 5 minutes.

Some food (where suitable) can be placed directly on to the glass tray to be grilled. Always place a rack under the glass tray so that heat can also reach the food from underneath.

Microwave with Grill Combination mode

(not with M 316 E)



- Place the food on the rack or on the turntable.
- Press the  touchpad. In the display area the symbols for Microwave with Grill light up, P flashes.
- With the  P +/- touchpads select the power setting required (P 1 to P 9). The time symbol flashes.
- Use the rotary control to enter the required grilling time.
- Press the  START touchpad. The grilling time will appear in the display area and count down in one second steps. At the end of this time an audible tone sounds. The time of day reappears in the display area.

The rack and the glass tray become hot during operation. There is a danger of being burnt.



Fan heat



(only with models M 326 EC and M 336 EC)

Without pre-heating

- Put the food to be cooked on the glass tray and place the glass tray on the low rack.
- Press the  touchpad. :0 and the Fan heat symbol appear in the display area, the time symbol flashes.
- Use the rotary control to enter the required cooking time. °C flashes.
- Use the °C +/- touchpads to select the required temperature. (100 °C – 250 °C).
- Press the  START touchpad. The cooking time will appear in the display area and count down in one second steps. At the end of this time an audible tone sounds. The time of day reappears in the display area.

With pre-heating

- Press the  touchpad. :0 and the Fan heat symbol appear in the display area, the time symbol flashes.
- Press the  touchpad again. °C flashes, the time symbol disappears.
- Use the °C +/- touchpads to select the required temperature. (100 °C – 250 °C).

- Press the  START touchpad, to start with the pre-heating. °C and the Fan heat symbol appear in the display area. The selected temperature flashes. At the end of the pre-heating time an audible tone sounds.
- Open the door and put the food to be cooked on the glass tray and place the glass tray on the low rack.
- Close the door. :0 and the Fan heat symbol appear in the display area, the time symbol flashes.
- Use the rotary control to enter the required cooking time.
- Press the  START touchpad. The cooking time will appear in the display area and count down in one second steps. At the end of this time an audible tone sounds. The time of day reappears in the display area.



The rack and the glass tray become hot during operation. There is a danger of being burnt.

Operation



Combination mode Microwave with Fan heat



(only with models M 326 EC and M 336 EC)

Without pre-heating

- Put the food to be cooked on the glass tray and place the glass tray on the low rack.
- Press the  touchpad. The symbol for Fan heat with microwave appears in the display area, P flashes.
- With the  P +/- touchpads select the power setting required (P 1 to P 9). The time symbol flashes.
- Use the rotary control to enter the required cooking time. °C flashes.
- Use the °C +/- touchpads to select the required temperature (100 °C – 250 °C).
- Press the  START touchpad. The cooking time will appear in the display area and count down in one second steps. At the end of this time an audible tone sounds. The time of day reappears in the display area.



With pre-heating

- Press the  touchpad. The symbol for Fan heat with microwave appears in the display area, P flashes.
- Press the  touchpad again. °C flashes, P disappears.

- Use the °C +/- touchpads to select the required temperature (100 °C – 250 °C).
- Press the  START touchpad, to start with the pre-heating. °C and the symbol for Fan heat with microwave appear in the display area. The selected temperature flashes. At the end of the pre-heating time an audible tone sounds.
- Open the door and put the food to be cooked on the glass tray and place the glass tray on the low rack.
- Close the door. The symbol for Fan heat with microwave appears in the display area, P flashes.
- With the  P +/- touchpads select the power setting required (P 1 to P 9). The time symbol flashes.
- Use the rotary control to enter the required cooking time.
- Press the  START touchpad. The cooking time appears in the display area and counts down in one second steps. At the end of this time an audible tone sounds. The time of day reappears in the display area.

Automatic programme "Proving dough"

(only with M 326 EC and M 336 EC)

- Press the  touchpad.
The Fan heat symbol and F appear in the display, the time symbol flashes.
- Use the rotary control to enter the required time.
The Fan heat symbol and the selected time appear in the display, the START symbol  flashes.
- Press the  START touchpad.
The time appears in the display area and counts down in one second steps. At the end of this time an audible tone sounds.
The time of day reappears in the display area.

In order to achieve good results it is essential that the appliance is cool before use. The fault message "E" appears in the display area if the oven interior temperature is too high for this function.

If this happens allow the oven to cool for approx. 15 - 20 minutes with the door open, press touchpad C and enter the settings again.

Operation



Sequential programming

Up to three functions can be programmed to run one after the other.

All the heating modes are available, for example, grilling, combination mode, and automatic programmes.

One possible combination could for example be:

Defrost - Cook - Grill.

- Proceed as previously described to enter details for the first function.
- Ignore the start symbol  which is flashing in the display area, and enter the second (and if required, third) functions.
- Only now press the  START touchpad, to set the sequence of programmes in motion.
The time appears in the display area and counts down in one second steps.
At the end of this time an audible tone sounds.
The time of day reappears in the display area.

Short step systems



Touchpads  1/2 allow you to store in memory programmes which are frequently used.

There are two memory stores where frequently used programmes can be recorded.

You can store all the operating functions, e.g. grilling, combination functions, and automatic programmes.

A programmed sequence of functions can also be stored.

Each memory store can be used again with a different programme.

- Proceed as for setting the operating mode.
- Do not however press the  START button at the end, instead select  1 or 2 to store the setting.
The code number of the stored programme will appear in the display, then the time of day will reappear.

Calling up the "Short step system"

- Press the relevant storage touchpad,  1 or 2.
The stored settings for the operating function appear in the display area step by step.

- Press the  START touchpad.
In the display area the time counts down in one second steps. An audible tone sounds at the end and the time of day reappears.

If you press the START button immediately after selecting the stored programme 1 or 2, this will avoid the whole sequence showing in the display area.



Storing a new programme will automatically delete any previously stored programme.

In the event of a power cut the stored programmes will be deleted, and will need to be re-entered. Make a note of the programme sequences, so that they are available for use when you need them.



Operation

Delaying start

The start time of a process can be pre-programmed up to 24 hours beforehand.



You can store all the operating functions, e.g. grilling, combination functions, and automatic programmes [Exception: Automatic reheating of various dishes (Auto ) and Automatic heating of liquids ()].





A programmed sequence of two functions can also be pre-programmed.

- The start time can be set in hours and minutes. First press the  touchpad, and use the rotary selector to set the hour of the starting time you require.
- Then press the  again and use the rotary selector to set the minutes. The selected start time appears in the display area, the clock symbol for delay start flashes.
- Press the  touchpad. The time of day appears in the display area, the clock symbol for delayed start lights up.

Proceed as previously described to set the operating mode.

Example: Microwave - Solo mode

- Press the  P +/- touchpads and select the power setting required (P 1 to P 9). The symbol  for microwave mode and the chosen power setting appear in the display area, and the time symbol flashes.

- Use the rotary control to enter the length of time of the process. The symbol  for microwave mode and the length of time of the process appear in the display area. The  symbol flashes.
- Press the  START touchpad. The current time of day, the  symbol for microwave mode and the clock symbol for delayed start appear in the display area.

The appliance will then switch on automatically at the programmed start time, and off at the end.

If you are using the delaying start function with the microwave mode, the food must have already been placed in the cooking compartment.

If you open the door again before the starting time,

- Press the  START touchpad again after closing the door, to ensure that the process starts at the preselected time.

If you wish to alter the starting time,

- Press touchpad C, and re-programme.

If you wish to delete the starting time,

- Press the C touchpad.

Reheating

Select the following microwave power settings, to reheat food:

Drinks	8
Food	6
Food for babies *	4

(See table on page 12 for ovens with maximum microwave output of less than 900/1000 watts.)

* We do not recommend heating or reheating foods or drinks for babies or young children in the microwave oven. Any decision to do this is the responsibility of the user, and should only be done with the utmost care. Pasteurised or sterilised cooked food should be gently heated for half to one minute on level 4, and tasted so that it is not too hot for a baby's palate before serving. Other food or drink when reheated should be heated to a high temperature and allowed to cool to a suitable heat for eating. For made-up milk follow the maker's instructions.

Always use a lid or cover for reheating food, except when a drier finish is needed, e.g. breaded poultry/meat.

Always remove the lids from jars, especially jars of baby food. Remove the rubber teat and seal top before warming baby bottles. When reheating liquids place the boiling rod supplied with the machine into the cup or glass. Never reheat hard boiled eggs in a microwave oven, even without the shell. The eggs can burst.

The time required depends largely on the nature and initial temperature of the food and the amount to be cooked. For example food taken straight from the fridge requires example longer to reheat than food stored at room temperature.

Always ensure that the food is adequately heated.

If in any doubt that a sufficiently high temperature has been reached, continue reheating for a little longer.

Stir or turn food from time to time during cooking. Stir the food from the outside towards the middle, as food heats more quickly from the outside.

Practical tips

After reheating

Be careful when removing a dish from the oven. It may be hot.

Although heat is not normally produced in the container itself by the microwaves, (apart from stoneware and similar dishes), heat transfer from the food to the container may be considerable, making the container itself hot.

Allow food to stand for a few minutes once a programme has ended to allow heat to be distributed evenly.

After reheating food, especially food for babies and small children, stir the food or shake the container and check that the temperature does not pose any danger. Double check after it has been left to stand.

Cooking

Place the food in a covered microwave-safe dish.

When cooking fresh **vegetables, fish, meat, poultry** first select power setting 8, and then select power setting 5 to continue cooking, (see table on page 12 for ovens with a maximum microwave output of less than 900/1000 watts.)

Add a little water to vegetables which have been kept stored. Vegetable cooking times depend on the texture of the vegetable. Fresh vegetables usually contain more water and cook more quickly. Stir and turn food at least once during cooking.

Ensure that perishable food, such as meat and fish, are cooked for an appropriate length of time.

For dishes such as **rice or semolina pudding** first select power setting 8, and then turn down to power setting 2 to complete cooking (see table on page 12 for ovens with a maximum microwave output of less than 900/1000 watts.).

For **food with skin or peel**, such as tomatoes, some types of sausage, jacket potatoes and aubergines, the skin should be pierced or cut several times before cooking to prevent food from bursting.

Boiling eggs in the microwave oven is not possible without a special egg-boiling device, available from specialist shops.

Otherwise the eggs will burst. Eggs can only be cooked in a microwave oven out of their shells in a glass dish. The yolk must be pierced several times first with a sharp object.

Bottling

Bottling should only be undertaken by an experienced cook who has received proper training in this method of preserving fruit and vegetables in an oven or microwave oven, and understands the implications of the chemical reactions involved.

Defrosting

Remove the food from its packaging and place in a microwave-safe container, to defrost without a lid. Turn, stir or separate the food about half-way through the programme.

To defrost delicate foods, e.g. cream, butter, gateau and cheese, select the microwave setting 1. However to achieve an even result remove from the oven and allow to finish defrosting at room temperature.

To defrost meat unpack the frozen meat and lay it on an upturned plate in a glass or china container so that the meat juice can run out, but not spread over the oven floor. Turn half way through defrosting.

For defrosting food such as bread, cakes or fruit microwave power setting 2 is recommended.

After defrosting

Allow the food to stand at room temperature for approximately the same amount of time spent for defrosting to enable the heat to spread evenly throughout the food.

Practical tips

Defrosting and reheating or cooking

Deep-frozen pre-cooked food can be defrosted and immediately reheated or cooked, using the combination of an automatic defrost programme, with an automatic cooking programme.

Remove the food from its packaging and place in a covered microwave-safe dish for defrosting and reheating or cooking. Exception: Minced meat should be left uncovered while cooking. Soups, stew and vegetables should be stirred several times during the process. Separate slices of meat half-way through the programme. Turn pieces of meat and fish at the half-way stage.

Deep-frozen pre-cooked meals in cardboard trays which, according to manufacturer's instructions are suitable for use in a conventional oven, are microwave-safe.

After defrosting followed by reheating or cooking.

Allow the food to stand at room temperature long enough to enable the heat to spread evenly throughout the food.

Examples

Melting margarine, butter

Melt 100 g at setting 5 uncovered, for approx 1-1¹/₂ minutes.

Melting chocolate

Break 100 g into pieces, melt at setting 5 uncovered, for approx. 2 minutes.

Dissolving gelatine

Melt in water at setting 5 uncovered, for approx. ¹/₂-1 minutes, stirring occasionally, (n.b. follow the instructions on the packet if these differ and for the amount of water).

Preparing flan topping

Gently heat 1 sachet + ¹/₄ l liquid at setting 5 uncovered, for approx. 4-5 minutes, stirring occasionally.

Proving dough

(500 g flour) leave covered to rise for approx. 8-10 minutes at setting 1.

Skinning tomatoes

Cut 3 tomatoes crosswise, drop into water and heat at setting 5 for approx. 2 minutes. The skin can now be peeled away easily. Take care, the tomatoes may be very hot.

The examples below are for an oven with a maximum microwave power output of 900/1000 watts.

For models with a different power output scale, adjust according to the table on page 12. E.g. for a 750 watt model use setting 6 instead of setting 5.

Bottling

Bottling should only be undertaken by an experienced cook who has received proper training in this method of preserving fruit and vegetables in an oven or microwave oven, and understands the implications of the chemical reactions involved.

Cleaning and care

Microwave appliance

Disconnect the microwave oven from the power supply before cleaning.

Oven housing and interior

The housing and interior can be cleaned using a damp cloth with washing up liquid or a mild detergent and water. Wipe dry with a soft cloth.

Avoid too much water as this could penetrate the openings.

Do not use a scouring agent which could scratch.

The stainless steel surfaces can be cleaned with a non abrasive cleaner for stainless steel.

To neutralise odours in the microwave put a cup of water with some lemon juice in the oven and simmer for a few minutes.

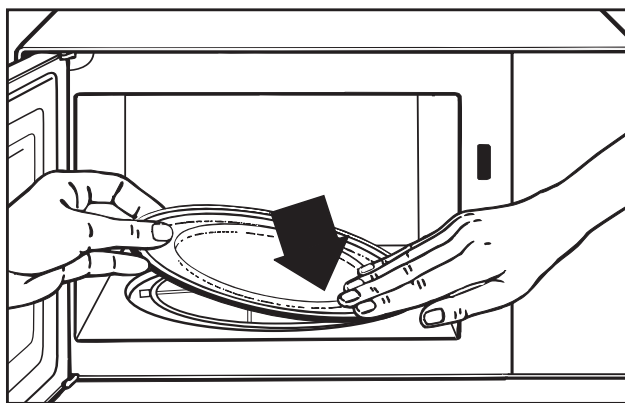

- The turntable can be removed for cleaning

- Always keep the roller ring underneath it clean as well as the oven floor. Otherwise the ring might not run smoothly.

Do not turn the carrier manually, as this could damage the drive motor.

Door interior

Always keep the door interior clean. Do not use any scouring agent. Check the door and the door seal at regular intervals for any sign of damage. If any damage is noticed, the oven should not be used again in microwave mode until the fault has been rectified by a service engineer trained by Miele.

Air vents

Do not let water or any other object find their way into the air vents.

Accessories (depending on model)

Boiling rod, glass tray

The boiling rod and glass tray can be washed in the dishwasher.

Rack

Wash and dry after each use.

Remove stubborn soils with a stainless steel cleaner.

Problem solving guide

Repairs to electrical appliances should only be carried out by suitably qualified and competent service technicians trained by Miele. Improper repairs may pose a serious risk to the user.

The following minor malfunctions however can usually be resolved without calling the Service Department:

What to do if . . .

. . . a process cannot be started.

Check whether,

- the appliance door is closed properly.
- a time has been entered.
- the appliance is plugged in to the mains supply.
- the mains fuse has blown (call a qualified electrician or the Service department, see "After Sales Service").

. . . food is not adequately defrosted, heated or cooked at the end of the selected process time.

- check whether the correct power setting was selected for the time set.

The lower the power setting the longer the time required.

- check whether the process has been interrupted and not restarted.

. . . the turntable does not turn smoothly.

- Check whether the path described by the ring on the base of the oven interior under the turntable is clean, and if not remove any soiling.

. . . strange noises are heard when the microwave oven is being used.

Check whether,

- the food is covered with aluminium foil.

If it is remove it.

- Sparks are being created by the use of crockery with a metallic finish. See notes on types of containers.

. . . food cools down too quickly.

In the microwave oven, food begins to cook from the outside first, the inside of the food relying on the slower conduction of heat.

If food is cooked at a high power level it is possible that the heat may not have reached the centre of the food. During standing time heat is transferred to the centre of the food. Food may be warm in the middle but cool on the edge.

When reheating food with different densities, such as plated meals it is sensible to start with a low power level and lengthen the time required.

. . . the microwave switches itself off during a cooking, reheating or defrosting process.

There may be insufficient air circulation.

Check whether:

- the air inlet is blocked.
- Any object is blocking the ventilation outlets.
- whether anything is blocking the gap between the base of the unit and the worktop surface.

Remove any objects if necessary. The appliance switches off automatically in the case of overheating. Cooking can be recontinued after a cooling-down period.

If the microwave oven switches itself off repeatedly, please call the Service Department.

. . . an E 15 appears in the display

The oven interior is too hot.

- Let the appliance cool down with the door open for 15 – 20 minutes. Afterwards, press the C touchpad and enter the settings again.

. . . an E 2 appears in the display

The ambient temperature is too low. If the room temperature drops to below 15 °C the machine will cease operating.

- Increase the room temperature or find a more suitable location for the appliance.

If it is not possible to remedy a fault by following the instructions given above, on no account open the appliance casing.

These microwave ovens should only be repaired by suitably qualified technicians trained by Miele.

After sales service

In the event of any faults which you cannot easily remedy, please contact

- your Miele dealer
- the nearest Miele Service Department.

See address on the back page.

When contacting the service department please quote the Model and Serial number of your appliance, given on the data plate which is located externally, on the rear wall of the appliance.

All electrical work should be carried out by a competent person, in accordance with national and local safety regulations.

The microwave oven is supplied with a mains cable and plug for connection to a single phase 220-240 V, 50 Hz a. c. supply. The voltage, rated load and fuse rating are given on the data plate. Please ensure that these match the household mains supply.

If the cable is damaged it must be replaced by a special cable which must be fitted by a competent person trained by the manufacturer. Please consult the Customer Service dept.

Connection should be made via a fused connection unit or a fused plug and a suitable switched socket, (rated load under 3000 W), or via suitable isolator (rated load over 3000 W), which is easily accessible. For extra safety it is advisable to install a residual current device (rcd) with a trip current of 30 mA.

Important

The wires in the mains lead are coloured in accordance with the following code:

Green/yellow = earth

Blue = neutral

Brown = live

As the colours of the wires in the mains lead of this appliance may not correspond with the coloured markings identifying the terminals in your plug, proceed as follows:

The wire which is coloured green and yellow must be connected to the terminal in the plug which is marked with the letter E or by the earth symbol  or coloured green or green and yellow.

The wire which is coloured blue must be connected to the terminal which is marked with the letter N or coloured black.

The wire which is coloured brown must be connected to the terminal which is marked with the letter L or coloured red.

WARNING
THIS APPLIANCE MUST
BE EARTHED

Electrical connection and Installation

Non-rewireable plugs BS 1363

If this machine or appliance is fitted with a non-rewireable plug, the following information applies:

If the socket outlets are not suitable for the plug supplied with this product, it must be cut off and an appropriate plug fitted.

The plug cut from the flexible cord should be disposed of and on no account be inserted into a socket elsewhere in the house (electric shock hazard).

The fuse cover must be refitted when changing the fuse, and if the fuse cover is lost, the plug must not be used until a suitable replacement is obtained. The colour of the correct replacement cover is that of the coloured insert in the base of the plug, or the colour that is embossed in words in the base of the plug (as applicable to the design of plug fitted).

The correct fuse rating of the replacement fuses that are ASTA approved to BS 1362 should be fitted. Replacement fuse covers may be purchased from your local electrical suppliers, or Miele Service Agent.

Installation

Do not position the appliance too close to adjacent furniture. A space of 5 cm is required all round the appliance for ventilation.

The microwave oven should be positioned or built-in at least 85 cm above the ground (EN 60335).

When installing a microwave oven care should also be taken that the air can be freely discharged from under and behind the appliance. Do not place any objects on the ventilation outlets or block the space between the appliance floor and the surface upon which it is placed.

The microwave oven can be:

- placed on a worktop
- built under a wall unit in conjunction with a building under frame (M 316 E only).
- built into a wall unit (M 316 EG only) or into a tall unit.
M 336 on the other hand can be built under a worktop.

Use the appropriate building frame and follow the fitting instructions.

The special fitting kit with instructions is available from the Miele specialist dealer or the Domestic Sales Department.

M 316 E

Voltage 230-240 V, 50 Hz

Rated load see data plate

Power settings 9 (80/150/200/300/
. 400/450/550/600/750 W)

Fuse rating see data plate

Timer switch up to 95 minutes

Freestanding appliance:

Dimensions (H x W x D) in mm:

Housing 296 x 440 x 316

Net weight 15 kg

M 326 EG

Voltage 230-240 V, 50 Hz

Rated load see data plate

Power settings 9 (80/150/250/350/
. 450/500/600/700/850 W)

Fuse rating see data plate

Timer switch up to 95 minutes

Freestanding appliance:

Dimensions (H x W x D) in mm:

Housing 296 x 496 x 384

Net weight 17 kg

M 326 EC

Voltage 230-240 V, 50 Hz

Rated load see data plate

Power settings 9 (100/200/300/400/
. 500/600/700/800/1000 W)

Fuse rating see data plate

Timer switch up to 95 minutes

Freestanding appliance:

Dimensions (H x W x D) in mm:

Housing 296 x 496 x 460

Net weight 25 kg

M 336 EG

Voltage 230-240 V, 50 Hz

Rated load see data plate

Power settings 9 (100/200/300/400/
. 500/600/700/800/900 W)

Fuse rating see data plate

Timer switch up to 95 minutes

Freestanding appliance:

Dimensions (H x W x D) in mm:

Housing 348 x 555 x 429

Net weight 22 kg

M 336 EC

Voltage 230-240 V, 50 Hz

Rated load see data plate

Power settings 9 (80/150/200/300/
. 400/450/550/600/800 W)

Fuse rating see data plate

Timer switch up to 95 minutes

Freestanding appliance:

Dimensions (H x W x D) in mm:

Housing 348 x 555 x 484

Net weight 26 kg



United Kingdom
Miele Co. Ltd., Fairacres, Marcham Road, Abingdon, Oxon, OX14 1TW
tel. Abingdon (01235) 554455 - fax (01235) 554477
Service Office, tel. Abingdon (01235) 554466