

SHARP®

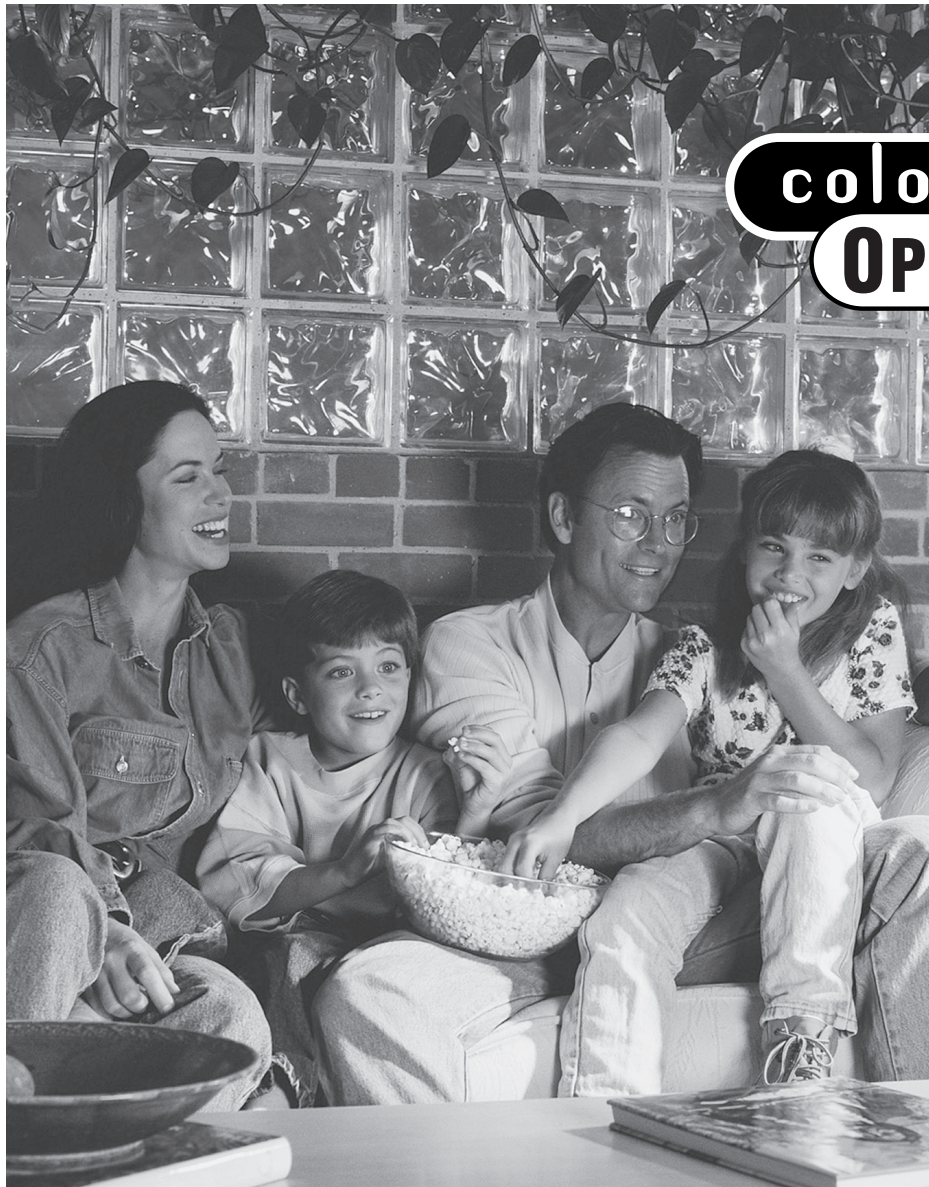

color television OPERATION MANUAL

model _____
32N-S500



As an ENERGY STAR® Partner, SHARP has determined that this product meets the ENERGY STAR® guidelines for energy efficiency. ENERGY STAR® is a U.S. registered trademark.

CONTENTS

	PAGE		PAGE
• Important Information	2	• Parent Control	15 - 19
• Important Safeguards	2 - 3	• V-Chip	15 - 19
• Outstanding Features	4	• View Timer	19
• Supplied Accessories	5	• Energy Save	20
• Before Operating Your Television	5	• Set Up	20 - 23
• Antenna Connections	6	• EZ Setup	20 - 21
• Quick Reference Control Operation	7 - 9	• Channel Setting	21 - 22
• Menu Functions	10	• Universal Plus Function	22
• EZ SETUP during First Power On	11	• Personal Preference	23
• Language	11	• Blue Screen	23
• Sleep Timer	12	• PIP (2 Tuner Picture In Picture)	24
• Closed Caption	12	• Using the Video and Audio Input Jacks	25
• Video Adjust	13	• Using the Audio Output Jacks	26
• Audio Adjust	13 - 14	• Operation of Remote Control	27 - 30
		• Before Calling for Service	31
		• Calling for Service	40
		• Limited Warranty	40

This operating manual includes basic operating instructions in Spanish and French.
SPANISH is on page 8, 32.
FRENCH is on page 9.

7020 ME

Welcome to the SHARP Family. We are pleased that you are now the owner of a SHARP Color Television – built for outstanding quality, reliability and performance.

Every SHARP Color Television set is properly tuned and adjusted for a proper color picture and sound, and has passed through the most stringent quality control tests at the factory. We have prepared this OPERATION MANUAL so that you may adjust the picture and color to your personal viewing preference.

We sincerely hope that you receive the utmost satisfaction and enjoyment from your new SHARP Color Television set for years to come. Please read these instructions carefully, and keep them handy for your future reference.

IMPORTANT:

To aid reporting in case of loss or theft, please record the TV's model and serial numbers in the space provided. The numbers are located at the rear of the TV.

Model No.:

Serial No.:

Important Information

There are two important reasons for prompt warranty registration of your new SHARP television set, using the REGISTRATION CARD packed in with the set.

FIRST – WARRANTY

This is to assure that you will immediately receive the full consumer benefit of the parts, service and labor warranty applicable to your purchase.

SECOND – CONSUMER PRODUCT SAFETY ACT

To assure that you will promptly receive any safety notification on inspection, modification or recall that SHARP may be required to give under the 1972 Consumer Product Safety Act. PLEASE READ CAREFULLY THE IMPORTANT "LIMITED WARRANTY" CLAUSE ON THE LAST PAGE.

WHAT IS ENERGY STAR®

TVs and VCRs use energy both when they are on and when they are off. Americans spend more than \$1 billion a year on energy consumed by TVs and VCRs when they are not in use. The new ENERGY STAR® models will reduce that energy "leakage" by up to 75 percent. Ultimately, this will mean more than \$500 million a year in energy savings for consumers.

The energy savings will help reduce the burning of fossil fuels and the related carbon dioxide pollution that contributes to global warming. If every American family replaced their TVs and VCRs with ENERGY STAR® models, it would reduce carbon dioxide emissions by five million tons every year — equivalent to eliminating the pollution from more than one million cars.

By using ENERGY STAR® products, you will save money on your electric bills and use less energy. That makes good economic sense and it's good for our environment.

WARNING: TO REDUCE THE RISK OF FIRE OR ELECTRIC SHOCK, DO NOT EXPOSE THIS APPLIANCE TO WET LOCATIONS.

	CAUTION RISK OF ELECTRIC SHOCK DO NOT OPEN	
CAUTION: TO REDUCE THE RISK OF ELECTRIC SHOCK, DO NOT REMOVE COVER (OR BACK). NO USER-SERVICEABLE PARTS INSIDE. REFER SERVICING TO QUALIFIED SERVICE PERSONNEL.		



The lightning flash with arrowhead within a triangle is intended to tell the user that parts inside the product are a risk of electric shock to persons.



The exclamation point within a triangle is intended to tell the user that important operating and servicing instructions are in the papers with the appliance.

WARNING - FCC Regulations state that any unauthorized changes or modifications to this equipment not expressly approved by the manufacturer could void the user's authority to operate this equipment.

"Note to CATV system installer: This reminder is provided to call the CATV system installer's attention to Article 820-40 of the National Electrical Code that provides guidelines for proper grounding and, in particular, specifies that the cable ground shall be connected to the grounding system of the building, as close to the point of cable entry as practical."

Important Safeguards

CAUTION: Please read all of these instructions before you operate your television and save these instructions for later use.

Electrical energy can perform many useful functions. This unit has been engineered and manufactured to assure your personal safety. BUT IMPROPER USE CAN RESULT IN POTENTIAL ELECTRICAL SHOCK OR FIRE HAZARDS. In order not to defeat the safeguards incorporated in this equipment, observe the following basic rules for its installation, use and servicing.

1. Unplug this television equipment from the wall outlet before cleaning.
2. Do not use liquid cleaners or aerosol cleaners. Use a damp cloth for cleaning.
3. Do not use attachments not recommended by the television equipment manufacturer as they may cause hazards.
4. Do not use this television equipment near water — for example, near a bathtub, washbowl, kitchen sink or laundry tub, in a wet basement, or near a swimming pool, etc.
5. Do not place this equipment on an unstable cart, stand, or table. The television equipment may fall, causing serious injury to a child or an adult, and serious damage to the equipment. Use only with a cart or stand recommended by the manufacturer or sold with the television equipment.
6. Television equipment and cart combination should be moved with care. Quick stops, excessive force, and uneven surfaces may cause the equipment and cart combination to overturn.
7. Wall or shelf mounting should follow the manufacturer's instructions, and should use a mounting kit approved by the manufacturer.
8. Slots and openings in the cabinet and the back or bottom are provided for ventilation. To insure reliable operation of the television equipment and to protect it from overheating, these openings must not be blocked or covered. This television equipment should not be placed in a built-in insulation such as a bookcase unless proper ventilation is provided.
9. The openings should never be covered with a cloth or other material, and the bottom openings should not be blocked by placing the television equipment on a bed, sofa, rug, or other similar surface. This television equipment should never be placed near or over a radiator or heat register.
10. This television equipment should be operated only from the type of power source indicated on the marking label. If you are not sure of the type of power supplied to your home, consult your television dealer or local power company.



For television equipment designed to operate from battery power, refer to the operating instructions.

11. As a safety feature, television equipment is equipped with a 2-wire polarized plug (one plug blade bigger than the other). The 2-wire polarized plug will fit only one way into the power outlet.

If the plug does not fit, ask your electrician to replace your obsolete outlet. Do not modify the plug and defeat this safety feature.

12. Do not allow anything to rest on the power cord. Do not locate this television equipment where the cord will be abused by persons walking on it.
13. Follow all warnings and instructions marked on the television equipment.
14. If an outside antenna is connected to the television equipment, be sure the antenna system is grounded so as to provide some protection against voltage surges and built-up static charges. Section 810 of the National Electrical Code provides information with respect to proper grounding of the mast and supporting structure, grounding of the lead-in wire to an antenna discharge unit, size of grounding conductors, location of antenna-discharge unit, connection to grounding electrodes, and requirements for the grounding electrode.

**EXAMPLE OF ANTENNA GROUNDING
ACCORDING TO NATIONAL ELECTRICAL CODE.**

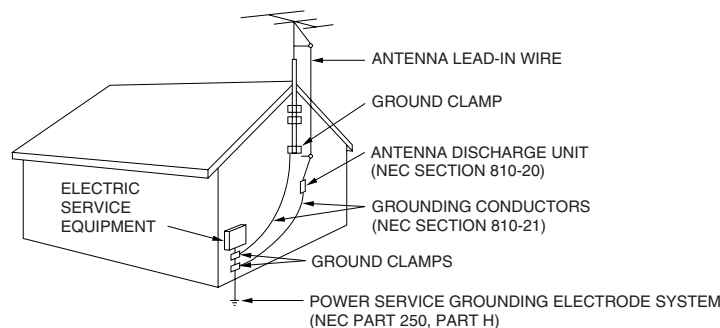

NEC - NATIONAL ELECTRICAL CODE

15. For added protection for this television equipment during a lightning storm, or when it is left unattended and unused for long periods of time, unplug it from the wall outlet and disconnect the antenna. This will prevent damage to the equipment due to lightning and power-line surges.
16. An outside antenna system should not be located in the vicinity of overhead power lines or other electric light or power circuits, or where it can fall into such power lines or circuits. When installing an outside antenna system, extreme care should be taken to keep from touching such power lines or circuits as contact with them might be fatal.
17. Do not overload wall outlets and extension cords as this can result in fire or electric shock.

Important Safeguards (Continued)

18. Never push objects of any kind into this television equipment through cabinet slots as they may touch dangerous voltage points or short out parts that could result in a fire or electric shock. Never spill liquid of any kind on the television equipment.
19. Do not attempt to service this television equipment yourself as opening or removing covers may expose you to dangerous voltage or other hazards. Refer all servicing to qualified service personnel.
20. Unplug this television equipment from the wall outlet and refer servicing to qualified service personnel under the following conditions:
 - A. When the power cord or plug is damaged or frayed.
 - B. If liquid has been spilled into the television equipment.
 - C. If the television equipment has been exposed to rain or water.
 - D. If the television equipment does not operate normally by following the operating instructions. Adjust only those controls that are covered by the operating instructions as improper adjustment of other controls may result in damage and will often require extensive work by a qualified technician to restore the television equipment to normal operation.
 - E. If the television equipment has been dropped or the cabinet has been damaged.
 - F. When the television equipment exhibits a distinct change in performance — this indicates a need for service.
21. Upon completion of any service or repairs to this television equipment, ask the service technician to perform routine safety checks to determine that the television is in safe operating condition.
22. When replacement parts are required, be sure the service technician has used replacement parts specified by the manufacturer that have the same characteristics as the original part. Unauthorized substitutions may result in fire, electric shock, or other hazards.

Outstanding Features

• **V-CHIP FUNCTION**

This function allows you to restrict TV programs and also allows you to control TV usage based on FCC data. This function is to prevent your children from watching violence or sexual scenes that are harmful to youth.

• **PICTURE IN PICTURE**

The two built-in tuners enable you to watch two TV programs at the same time, one on the main picture and one on an inset while commercial messages are on the screen..

• **DARKER-TINTED PICTURE TUBE**

The darker tint makes black look blacker for greater contrasts and richer colors. These features combine to provide you with a beautiful, easily viewed picture.

• **S-VIDEO INPUT TERMINALS**

The S-Video input terminal allows connection to an S-VHS VCR or other video equipment with an S-Video output terminal for crisp, clear reproduction of images.

• **FRONT VIDEO/AUDIO INPUT JACKS**

Additional Video/Audio input Jacks are located on the front of your set, so it is easier for you to connect camcorders, TV games and other video equipment.

• **UNIVERSAL REMOTE CONTROL**

This infrared remote control operates your TV set, and can control a variety of VCRs and CATV converter boxes.

• **UNIVERSAL PLUS FUNCTION**

The unit will select the suitable input mode automatically when the VCR PLAY button on the UNIVERSAL REMOTE CONTROL is pressed.

• **VARIABLE AUDIO OUTPUT (VAO)**

The VAO offers TV remote control over separate audio equipment volume that can raise or lower the audio equipment volume.

• **ENERGY SAVE**

When this feature is turned on, it reduces the brightness of the TV to a level that consumes approximately 20 percent less energy than when the feature is turned off.

• **BUILT-IN MULTICHANNEL TV SOUND (MTS) CIRCUIT & SRS® (Sound Retrieval System)**

This circuit allows reception of stereo or bilingual TV sound. The SRS feature adds a three dimensional quality to stereo so the audio is more like a live performance (see page 13 for details).

• **VIEWING TIMER**

This function can be used to prevent your children from watching too much TV.

• **TRILINGUAL MENU ON SCREEN DISPLAY**

For your convenience you can easily select the MENU ON SCREEN DISPLAY in ENGLISH, SPANISH or FRENCH.

• **CLOSED CAPTION DECODER**

Allows you to view conversations, narration and sound effects from TV programs or pre-recorded video tape as subscript on your TV screen.

• **SLEEP TIMER**

For convenient viewing, the Sleep Timer automatically shuts off the set in preselected periods of up to 120 minutes. This Timer can be set at 30, 60, 90 or 120 minute intervals.

Supplied Accessories

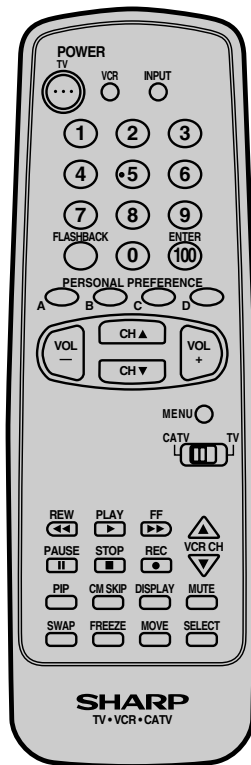

Infrared Remote Control
Part Number : RRMCG1494CESA

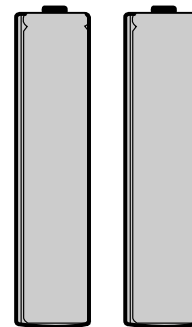

Size AA
Dry Batteries (2pcs.)

Before Operating Your Television

Location

- For normal operation, your TV should be located in an area of the room where cool, adequate ventilation is provided. Do not place the back of the television set in a place where free airflow will be restricted.
- Any magnetic force may disturb the color picture. Make sure that magnets, electric clocks, toys using magnets or any other magnetic substance, such as iron are kept well away from this TV set.

Power

Your TV operates on 120 Volts, 60 Hertz (normal household current) and has a polarized plug. If you are unable to insert the plug fully into the outlet, try reversing the plug. Should it fail to fit, contact an electrician. Do not defeat the safety feature of the polarized plug.

NOTE:

- If the set will not be used for a long period, such as during a vacation, unplug the set from the wall outlet to economize power. (If the TV set is plugged in, slight current still flows, even with the POWER BUTTON in the OFF position.)
- Lines and other noise may appear in TV broadcast images when an FM tuner or radio is located near the TV and both radio and TV broadcasts are being received. Should such noise appear, turn off either the TV or the radio.
- If you are listening to the AM broadcasts, turn the TV off. AM broadcast signals may not be received due to the interference of the TV.

Before using the television, prepare the Remote Control.

To use the remote control, insert batteries first.

- With your thumbnail, pull up the slit as indicated by the arrow to remove the back cover. Insert two batteries (size "AA"). Be sure to match the battery ⊕/⊖ terminals with the ⊕/⊖ marks inside the compartment.

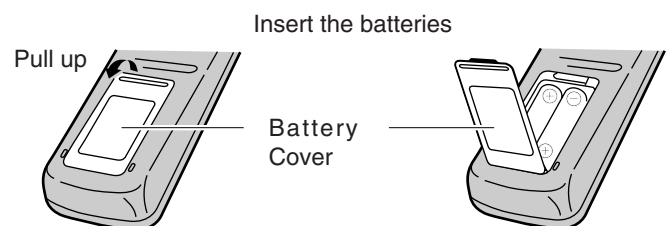

Antenna Connections

Antennas

- The antenna requirements for good color television reception are more important than those for black & white television reception. For this reason, a good quality outdoor antenna is strongly recommended.

The following is a brief explanation of the type of connections that are provided with the various antenna systems:

- A 75 ohm system is generally a round cable with F-type connector that can easily be attached to a terminal without tools. **The F-type connector should be finger tightened only.**
- A 300 ohm system is a flat "twin-lead" cable that can be attached to a 75 ohm terminal through a 300-75 ohm ADAPTOR (not supplied).

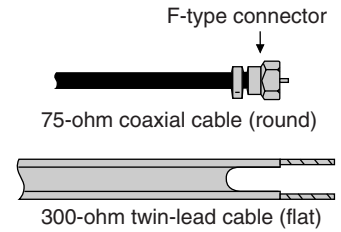

OUTDOOR ANTENNA CONNECTION

- Use one of the following two diagrams if you connect an outdoor antenna.
 - Using a VHF/UHF combination outdoor antenna.
 - Using separate VHF and/or UHF outdoor antenna.
- Connect an outdoor antenna cable lead-in to the COAXIAL CABLE CONNECTOR on the rear of the TV set.

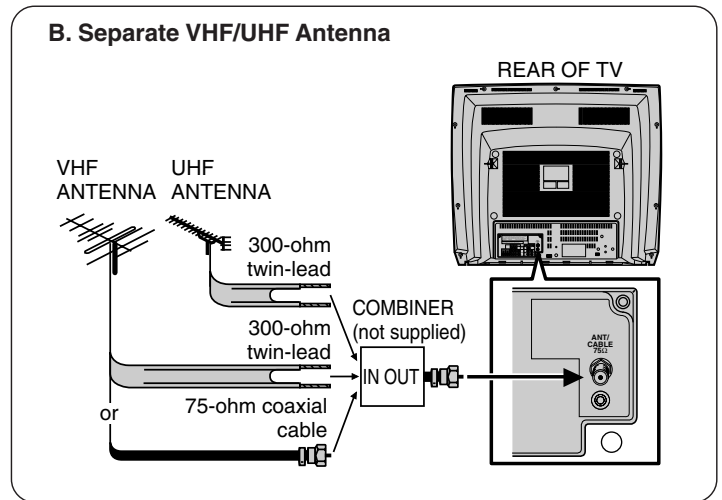
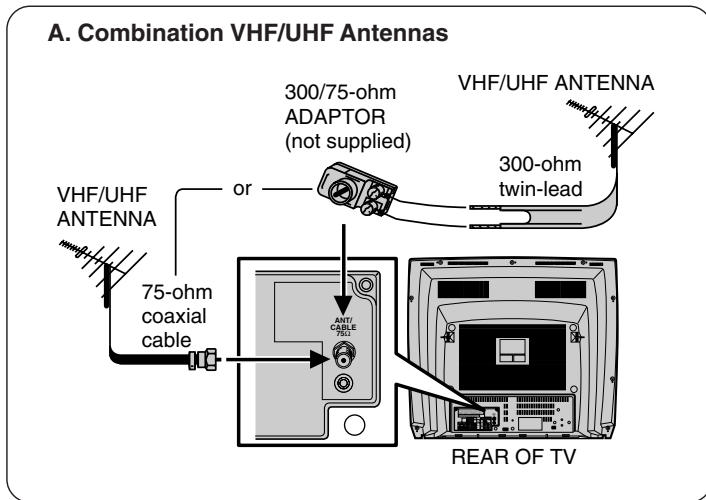

CABLE TV (CATV) CONNECTION

- A 75 ohm coaxial cable connector is built into the set for easy hookup. When connecting the 75 ohm coaxial cable to the set, screw the 75 ohm cable to the COAXIAL CABLE CONNECTOR.
 - Some cable TV companies offer "premium pay channels". Since the signals of these premium pay channels are scrambled, a cable TV converter/descrambler is generally provided to the subscriber by the cable TV company. This converter/descrambler is necessary for normal viewing of the scrambled channels. (Set your TV on channel 3 or 4. Typically one of these channels is used. If this is unknown, consult your cable TV company.) For more specific instructions on installing cable TV, consult your cable TV company. One possible method of utilizing the converter/descrambler provided by your cable TV company is explained below.
- Please note: RF switch equipped with position A/B (not provided) is required.

- "A" position on the RF switch (not supplied) : You can view all unscrambled channels using the TV's channel keys.
- "B" position on the RF switch (not supplied) : You can view the scrambled channels via the converter/descrambler using the converter's channel keys.

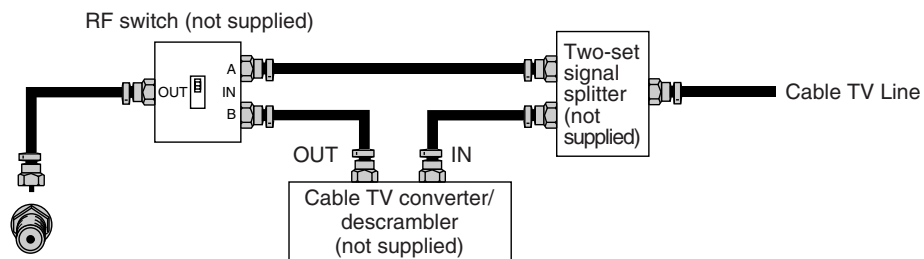

NOTE:

- Consult your SHARP Dealer or Service Center for the type of splitter, RF switch or combiner that might be required.

Quick Reference Control Operation

Location of Controls

(ENGLISH)

Front Panel

POWER

Press → On.
Press again → Off.

VOLUME UP/DOWN

(+) Increases sound.
(-) Decreases sound.

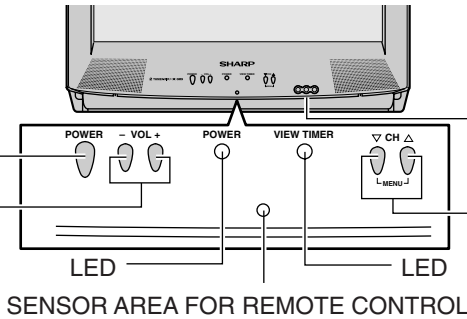

VIDEO/AUDIO IN 2 TERMINALS

(VIDEO/AUDIO terminals are also provided on the rear.)

CHANNEL UP/DOWN – MENU

(▲) Selects next higher channel.
(▼) Selects next lower channel.

- Press both at the same time to access the MAIN MENU screen.

Basic Remote Control Functions

POWER

Press → On.
Press again → Off.

REMOTE KEYPAD

Accesses any channel from keypad.

FLASHBACK

Returns to previous channel.

PERSONAL PREFERENCE

With the Personal Preference buttons, you can program your favorite programs by using the four categories A, B, C and D. The channels can be accessed quickly by using these buttons. (See page 23.)

VOLUME UP/DOWN

(+) Increases sound.
(-) Decreases sound.
• In menu mode, changes or selects the TV adjustments.

TV-CATV MODE SELECT SWITCH

In TV position, sends power and channel select commands (Channel up/down and Random Access buttons) to the TV.
In CATV position, sends power and channel select commands to a cable TV converter.

VCR CONTROL

See page 27.

DISPLAY

Press → Display receiving channel for four seconds.

Press again → Displays remaining time of SLEEP TIMER and VIEW TIMER.

Press again → Temporarily displays receiving channel when in Closed Caption mode.

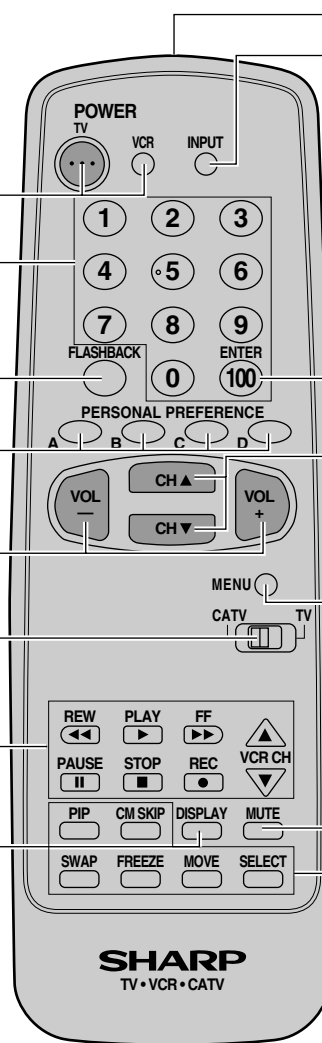

Infrared Transmitter Window

INPUT

Press → Switch to external video INPUT 1 mode.

Press again → Switch to external video INPUT 2 mode.

Press again → Switch to external video INPUT 3 mode.

Press again → Switch back to the original TV mode.

See page 25.

ENTER

Used in some instances where a VCR or Cable Converter Box requires an “enter” command after selecting channels, when using the REMOTE KEYPAD button. (See page 27)

CHANNEL UP/DOWN

(▲) Selects next higher channel.
(▼) Selects next lower channel.

- See pages 21 - 22 for channel presetting.
- Moves the “▶” mark of the MENU screens.

MENU

Press → Accesses MAIN MENU.
Press again → Exits MAIN MENU.

MUTE

Press → Mutes sound.
Press again → Restores sound.
• CLOSED CAPTION appears when sound is muted.

PIP FUNCTION

You can watch two pictures at the same time. See page 24.

NOTE:

- The above shaded buttons on the Remote Control glow in the dark. To use the glow-in-the-dark display on the remote control, place it under a fluorescent light or other lighting.
- The phosphorescent material contains no radioactive or toxic material, so it is safe to use.
- The degree of illumination will vary depending on the strength of lighting used.
- The degree of illumination will decrease with time and depending on the temperature.
- The time needed to charge the phosphorescent display will vary depending on the surrounding lighting.
- Sunlight and fluorescent lighting are the most effective when charging the display.

Referencia rápida de los controles de operación

(ESPAÑOL)

Ubicación de los Controles

Front Delantero

ALIMENTACION (POWER)

Pulsando → Enciende (On).
Pulsando nuevamente → Apaga (Off).

AUMENTO/DISMINUCION DEL VOLUMEN (VOL)

(+) Aumenta el sonido.
(-) Disminuye el sonido.

Funciones Basicas Del Control Remoto

ALIMENTACION (POWER)

Pulsando → Enciende (On).
Pulsando nuevamente → Apaga (Off).

TECLADO A DISTANCIA (REMOTE KEYPAD)
Para tener acceso a cualquier canal empleando las teclas.

RETORNO AL CANAL ANTERIOR (FLASHBACK)

Para volver al canal anterior.

PREFERENCIAS PERSONALES (PERSONAL PREFERENCE)

Con los botones Personal Preference puede programar sus programas favoritos utilizando las cuatro categorías A, B, C y D.
Puede acceder a los canales rápidamente utilizando estos botones.

AUMENTO/DISMINUCION DEL VOLUMEN (VOLUME UP/DOWN)

(+) Aumenta el sonido.
(-) Disminuye el sonido.
• En modo de MENU cambia o selecciona el ajuste del televisor.

CONMUTADOR SELECTOR DE TELEVISOR/TV POR CABLE (TV-CATV)

En la posición TV, el mando envía los comandos de alimentación y selección de canales (botones de canal superior/inferior y de acceso aleatorio) a un televisor.
En la posición CATV, envía los comandos de alimentación y selección de canales a un convertidor de TV por cable.

CONTROLES DEL VIDEO
Pulsando → Aparece el canal de recepción por cuatro segundos.
Pulsando nuevamente → Aparece el tiempo restante del TEMPORIZADOR PARA APAGAR y del LIMITADOR.
• En el modo de "Closed Caption" se muestra el canal de recepción por un corto tiempo.

CONTROLES DEL VIDEO

VISUALIZACION (DISPLAY)

Pulsando → Aparece el canal de recepción por cuatro segundos.
Pulsando nuevamente → Aparece el tiempo restante del TEMPORIZADOR PARA APAGAR y del LIMITADOR.
• En el modo de "Closed Caption" se muestra el canal de recepción por un corto tiempo.

NOTE:

- Los botones que arriba pueden verse sombreados en el Control Remoto lucen en la oscuridad. Para usar el visor del control remoto que luce en la oscuridad, colocarlo bajo una luz fluorescente u otra fuente luminosa.
- El material fosforescente no contiene elementos radiactivos ni tóxicos, de modo que su uso no representa ningún peligro.
- El grado de iluminación variará de acuerdo con la potencia de la luz utilizada.
- El grado de iluminación irá decayendo con el tiempo y dependiendo de la temperatura.
- El tiempo necesario para cargar el visor fosforescente variará de acuerdo con la iluminación circundante.
- La luz del sol y la luz fluorescente son las más eficaces para la carga del visor.

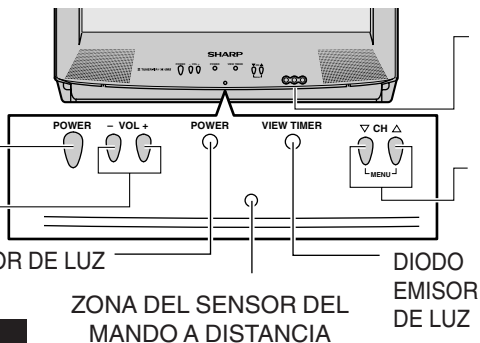

TERMINALES DE ENTRADA VIDEO/AUDIO IN 2

(Los terminales VIDEO/AUDIO también se encuentran en la parte posterior)

CANAL SUPERIOR/INFERIOR (CH) - MENU

(▲) Selecciona el siguiente canal superior.
(▼) Selecciona el siguiente canal inferior.
• Pulse ambos al mismo tiempo para acceder a la pantalla de MENU PRINCIPAL.

Ventanilla del transmisor de infrarrojos

ENTRADA (INPUT)

Pulsando → Cambia al modo de entrada 1 del vídeo externo.

Pulsando nuevamente → Cambia al modo de entrada 2 del vídeo externo.

Pulsando nuevamente → Cambia al modo de entrada 3 del vídeo externo.

Pulsando nuevamente → Vuelve al modo TV original.

INTRODUCIR (ENTER)

Se utiliza en algunos casos en los cuales un VCR o una Caja de Inversor de Cable requiere una orden "enter" después de seleccionar los canales, al usar el teclado a distancia.

CANAL SUPERIOR/INFERIOR (CHANNEL UP/DOWN)

(▲) Selecciona el siguiente canal superior.
(▼) Selecciona el siguiente canal inferior.
• En el modo de MENU, mueve la marca "▶".

PREPARACION (MENU)

Pulsando → Accede al MENU PRINCIPAL.
Pulsando nuevamente → Sale del MENU PRINCIPAL.

SILENCIAMIENTO (MUTE)

Pulsando → Silencia el sonido.
Pulsando nuevamente → Restaura el sonido.
• CLOSED CAPTION aparece automáticamente cuando el sonido es silenciado. Siempre y cuando la transmisión tenga esta señal.

IMAGEN EN IMAGEN (FUNCTION PIP)

Se puede ver dos imágenes al mismo tiempo.

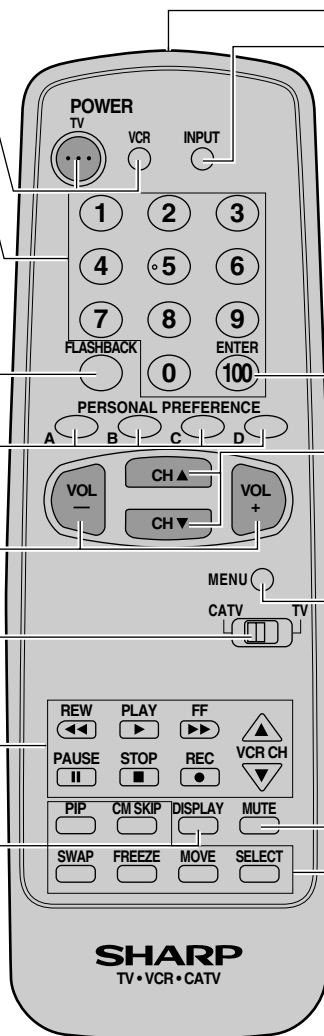

Référence rapide sur les commandes

(FRANÇAIS)

■ Emplacement des touches

Panneau avant

ALIMENTATION (POWER)

Appuyer pour mettre sous tension.
Appuyer de nouveau pour mettre hors tension.

AUGMENTATION/RÉDUCTION DU VOLUME SONORE (VOL)

(+) Pour augmenter le volume du son.
(-) Pour diminuer le volume du son.

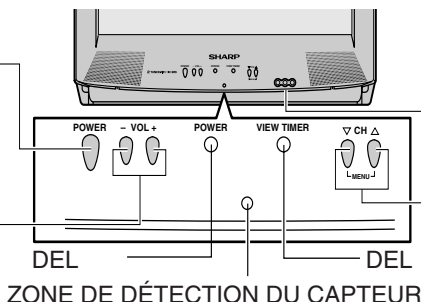

PRISES D'ENTRÉE VIDÉO/AUDIO IN 2
(Les prises VIDÉO/AUDIO sont également reprises à l'arrière.)

TOUCHES DES CANAUX CROISSANT/DECROISSANT (CH) – MENU

(▲) Sélectionne le canal supérieur suivant.
(▼) Sélectionne le canal inférieur précédent.
• Appuyez simultanément sur ces deux touches pour accéder à l'écran MENU PRINCIPAL.

Fonctions de base de la télécommande

ALIMENTATION (POWER)

Appuyer pour mettre sous tension.
Appuyer de nouveau pour mettre hors tension.

PAVÉ NUMÉRIQUE DE COMMANDE A DISTANCE (REMOTE KEYPAD)

Sélectionne directement le canal voulu sur le pavé numérique.

RETOUR (FLASHBACK)

Rappelle dernier le canal regardé.

PRÉFÉRENCES PERSONNELLES (PERSONAL PREFERENCE)

Grâce aux touches de préférence personnelle, vous pouvez programmer vos programmes préférés à l'aide des 4 catégories: A, B, C et D. Ces touches vous permettent d'accéder rapidement à ces canaux.

AUGMENTATION/RÉDUCTION DU VOLUME SONORE (VOLUME UP/DOWN)

(+) Pour augmenter le volume du son.
(-) Pour diminuer le volume du son.
• Pour changer ou sélectionner les réglages du téléviseur en mode menu.

SÉLECTEUR DE MODE TÉLÉVISION/ CÂBLOVISION (TV-CATV)

En position télévision (TV), permet de mettre le téléviseur sous/hors tension et de sélectionner ses canaux (touches de canaux en ordre croissant/décroissant et d'accès direct).

En position câblovision (CATV), permet de mettre un convertisseur de téléviseur par câble sous/hors tension et de sélectionner ses canaux.

COMMANDE DU MAGNÉTOSCOPE

AFFICHAGE (DISPLAY)

Appuyer pour afficher le canal reçu pendant quatre secondes.
Appuyer de nouveau → Affichage du temps restant du MINUTEUR DE MISE HORS TENSION ou du LIMITEUR.

• Pour afficher temporairement le canal reçu en mode sous-titrage.

REMARQUE:

- Les boutons ombrés de la télécommande illustrés ci-dessus brillent dans l'obscurité lorsque la télécommande a été placée sous une ampoule fluorescente ou toute autre source lumineuse.
- Le matériau phosphorescent n'est absolument pas toxique ou radioactif. Il peut donc être utilisé en toute sécurité.
- Le degré d'illumination variera en fonction de l'intensité de la source d'éclairage.
- Le degré d'illumination diminuera avec le temps, et de façon de la température.
- Le temps requis pour charger les touches phosphorescentes dépendra de l'éclairage environnant.
- Les rayons directs du soleil et les luminaires fluorescents constituent les meilleures sources de chargement des touches phosphorescentes.

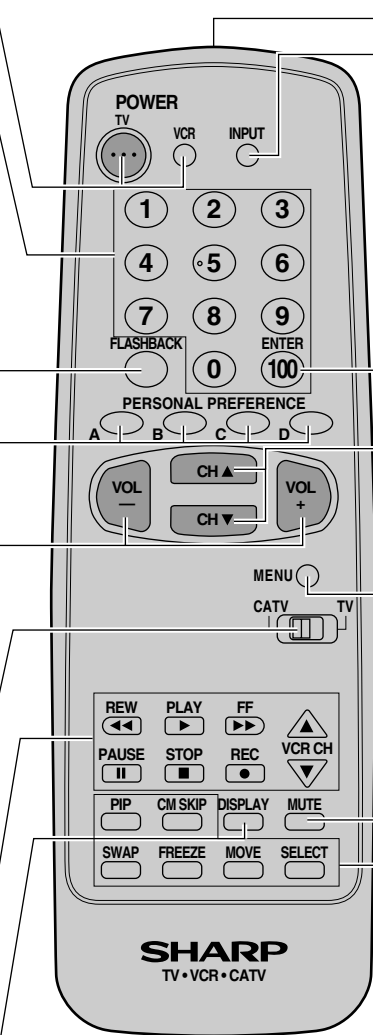

Fenêtre d'émission du signal infrarouge

ENTRÉE (INPUT)

Appuyer pour sélectionner le mode ENTRÉE 1 vidéo externe.
Appuyer de nouveau pour sélectionner le mode ENTRÉE 2 vidéo externe.
Appuyer de nouveau pour sélectionner le mode ENTRÉE 3 vidéo externe.
Appuyer de nouveau pour revenir au mode TV initial.

ENTRER (ENTER)

Parfois utilisée lorsqu'un magnétoscope ou un convertisseur nécessite l'introduction d'une commande "enter" après la sélection de canaux à l'aide du pavé numérique de commande à distance.

TOUCHES DES CANAUX CROISSANT/ DÉCROISSANT (CHANNEL UP/DOWN)

(▲) Sélectionne le canal supérieur suivant.
(▼) Sélectionne le canal inférieur précédent.
• Déplace le curseur "►" sur l'écran du MENU.

RÉGLAGE (MENU)

Appuyer → Accès au MENU PRINCIPAL.
Appuyer de nouveau → Sortie du MENU PRINCIPAL.

SOURDINE (MUTE)

Appuyer → Mise en sourdine du son.
Appuyer de nouveau → Rétablissement du son.
• CLOSED CAPTION apparaît lorsque le son est mis en sourdine.

IMAGE DANS L'IMAGE (FUNCTION PIP)

Vous pouvez regarder deux images en même temps.

Menu Functions

■ Master these basic operations and the rest is simple.

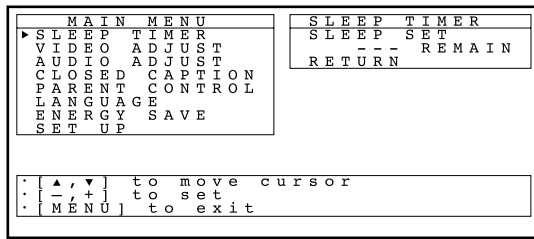
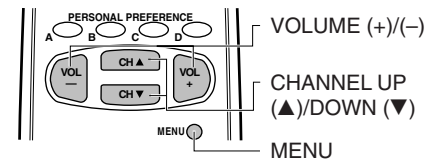

(MAIN MENU screen)

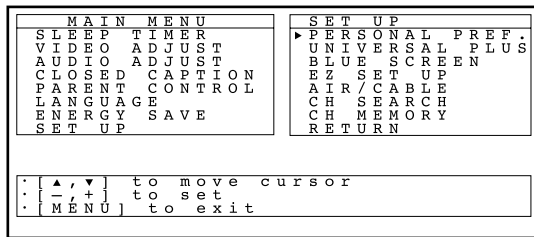

(SET UP mode)

Calling Up the Functions.	R/C buttons
1 Press MENU to access MAIN MENU screen.	MENU
2 Press CH UP (▲) or DOWN (▼) to move the “▶” mark to the desired function mode. CH UP (▲) moves the “▶” mark up. DOWN (▼) moves the “▶” mark down.	CH ▲ CH ▼
3 Press VOL (+) or (–) to access the desired function mode. (If you select RETURN, the cursor moves to the MAIN MENU)	VOL – VOL + MENU

■ Accessing the MAIN MENU screen without Remote Control

- If you misplaced your Remote Control, you can still access most settings via the MAIN MENU screen when you press both **CH UP (▲)** and **DOWN (▼)** on the TV set.
- Some features of your TV set will not be accessible without the Remote Control. If you lost your Remote Control, contact a Sharp Service Center for a replacement.

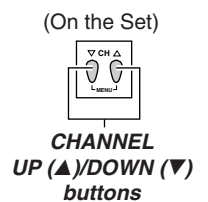

■ MENU SUMMARY

1. SLEEP TIMER

You can set the number of minutes for your TV to automatically turn off. See page 12.

2. VIDEO ADJUST

You can adjust the settings of PICTURE, TINT, COLOR, BRIGHTNESS, SHARPNESS, COLOR TEMP., FLESH TONE and NOISE REDUCT. See page 13.

3. AUDIO ADJUST

You can adjust the AUDIO settings such as the BASS, TREBLE and BALANCE, as well as MTS, EQUISOUND and internal SPEAKER ON/OFF and SRS. See pages 13 - 14.

4. CLOSED CAPTION

Your TV is equipped with an internal Closed Caption decoder. “Closed Caption” is a system which allows you to view conversations, narration, and sound effects in TV programs and home videos as subscript on your TV screen. See page 12.

5. PARENT CONTROL (V-CHIP)

This function allows you to restrict TV programs, to control TV usage based on FCC data and to prevent your children from watching violence or sexual scenes that may be harmful. See pages 15 - 19.

6. PARENT CONTROL (VIEW TIMER)

This function allows you to restrict TV viewing time and also allows you to control TV usage. This function is to prevent your children from watching too much TV. See page 19.

7. LANGUAGE

Allows you to select between ENGLISH, ESPAÑOL and FRANCAIS from the ON SCREEN DISPLAY. See page 11.

8. ENERGY SAVE

This function controls the BRIGHTNESS of CRT and reduces power consumption about 20 percent. See page 20.

9. SET UP

You can select each function of PERSONAL PREFERENCE, UNIVERSAL PLUS, BLUE SCREEN, EZ SET UP, AIR/CABLE, CH SEARCH and CH MEMORY. See pages 20 - 23.

10. PERSONAL PREFERENCE

By selecting the PERSONAL PREFERENCE channels in advance you can select your favorite channels easily. See page 23.

11. UNIVERSAL PLUS

VCR input mode will be selected automatically by pressing VCR PLAY button on UNIVERSAL REMOTE CONTROL, and CATV input mode by pressing TV-CATV switch. See page 22.

12. BLUE SCREEN

Automatically turns the screen blue if a broadcast signal is not received. See page 23.

13. EZ SET UP

By operating the channel presetting functions, you can preset your TV to the desired channels for viewing. See pages 20 - 21.

14. AIR/CABLE

You can select TV signal mode of AIR, CABLE STD, CABLE HRC and CABLE IRC. See page 21.

15. CH SEARCH

You can save broadcast TV channels into memory. See pages 21 - 22.

16. CH MEMORY

You can add weak or additional channels, or erase unwanted channels from TV memory. See pages 21 - 22.

EZ SETUP during First Power On

- When you turn on the TV for the first time, it will automatically memorize the broadcasting channels.

Please perform the following instructions before you press the power button.

- Insert the batteries into the remote control. (See page 5)
- Connect the antenna cable to the TV set. (See page 6)
- Plug in the AC POWER cord to the wall outlet.

- Press the **POWER** button on the TV set or on the Remote Control to turn on the TV. The SELECT LANGUAGE mode will be displayed.

- Press **CH UP** (▲) or **DOWN** (▼) to select "ENGLISH", "ESPAÑOL (SPANISH)" or "FRANÇAIS (FRENCH)" and then press **VOL (+)** or **(-)**.

- Press **CH UP** (▲) or **DOWN** (▼) to select "NEXT".

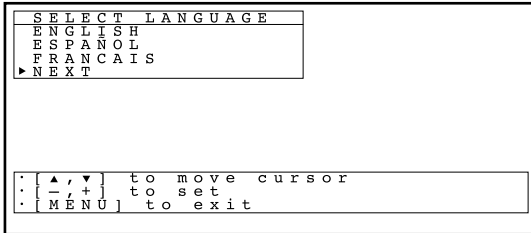

(SELECT LANGUAGE screen)

- Press **VOL (+)** or **(-)** to access SET AIR/CABLE mode.

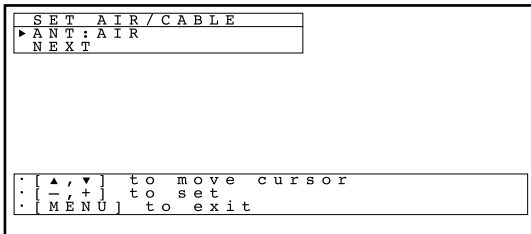

(SET AIR/CABLE mode)

- Press **VOL (+)** or **(-)** to set AIR/CABLE.



- Press **CH UP** (▲) or **DOWN** (▼) to select "NEXT", then press **VOL (+)** or **(-)** to access EZ SETUP mode.

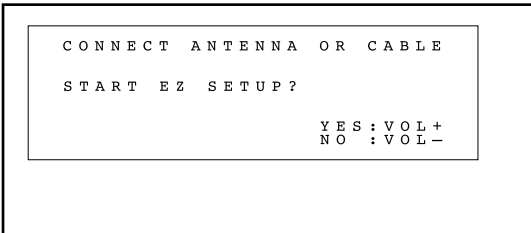

(EZ SETUP mode)

- Press **VOL (+)**. The tuner will automatically search for the broadcasting and cable TV channels. (The CH No. will automatically increase when it appears.)

If you want to stop the EZ SETUP process once it has started, press **VOL (-)** and it will be canceled.

If you want to SETUP again, please refer to pages 20 - 23 on SETUP. Press **VOL (-)** to cancel EZ SETUP.

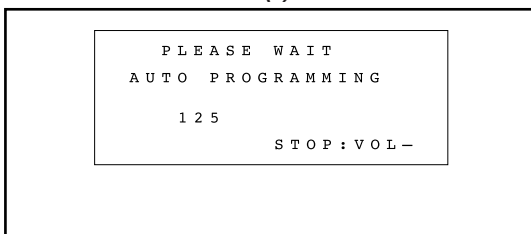

- Once EZ SETUP is completed, the lowest channel number memorized will be displayed (Ex: 2 CH).

Language

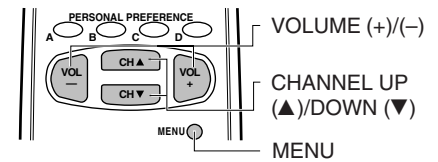

- The language for the ON SCREEN DISPLAY can be set to ENGLISH, SPANISH or FRENCH.

- Setting the ON SCREEN DISPLAY Language.

- Press **MENU** to access MAIN MENU screen.
- Press **CH UP** (▲) or **DOWN** (▼) to move the "►" mark to "LANGUAGE".

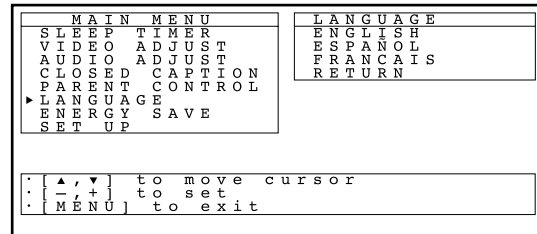

(MAIN MENU screen)

- Press **VOL (+)** or **(-)** to access LANGUAGE mode.

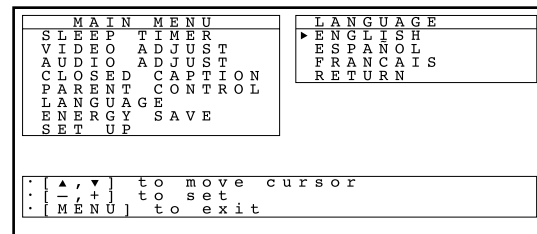

(LANGUAGE mode)

- Press **CH UP** (▲) or **DOWN** (▼) to move the "►" mark to "ESPAÑOL (SPANISH)" or "FRANÇAIS (FRENCH)".

- Press **VOL (+)** or **(-)** to select "ESPAÑOL (SPANISH)".

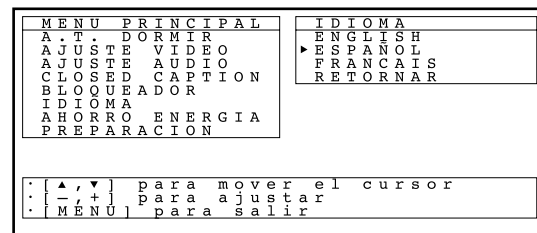

- Press **MENU** to exit.

NOTE:

- If EZ SETUP does not memorize all the channels in your region, please refer to page 18 ~ 19 for more information on manually memorizing the channels using CHANNEL SETTING.
- It may be difficult to PRESET all channels in an area when the broadcasting signals are weak, or multiple stations are received on the same channel. Please refer to pages 21 - 22 for more information on manually memorizing additional channels using CHANNEL MEMORY.

Sleep Timer

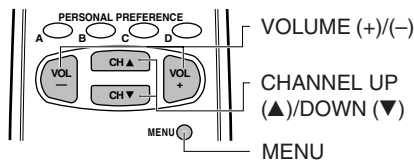

■ You can set the number of minutes for your TV to automatically turn off.

- 1 Press **MENU** to access MAIN MENU screen.
- 2 Press **VOL (+)** or **(-)** to access SLEEP TIMER mode.
- 3 Press **VOL (+)** or **(-)** to set a sleep time of 30, 60, 90 or 120 minutes.

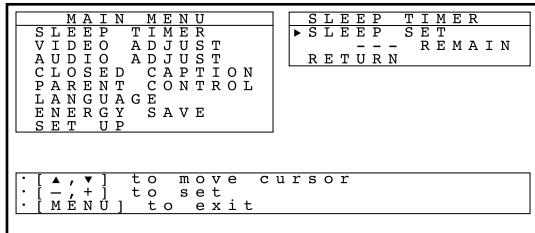
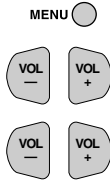

(SLEEP TIMER mode)

- 4 Press **MENU** to exit.



NOTE:

- To turn off the Sleep Timer, repeat the above SLEEP TIMER steps and select "-- REMAIN" during step 3.
- While Sleep Timer is active, the time remaining will be briefly displayed on-screen at regular intervals or when the remote's Display key is pressed.

Closed Caption



■ HOW TO SET CLOSED CAPTION

- Your TV is equipped with an internal Closed Caption decoder. "Closed Caption" is a system which allows you to view conversations, narration, and sound effects in TV programs and home videos as subscript on your TV screen as shown above.
- Not all the programs and videos will offer closed caption. Please look for the "CC" symbol to ensure that captions will be shown.
- Closed Caption broadcast can be viewed in two modes: CAPTION and TEXT. For each mode, two channels are available, CH1 and CH2:

The [CAPTION] mode subtitles dialogues and commentaries of TV dramas and news programs while allowing clear view of the picture.

The [TEXT] mode displays over the picture other various information (such as TV program schedule, weather forecast, etc.) that is independent of the TV programs.

- 1 Press **MENU** to access MAIN MENU screen.
- 2 Press **CH UP (▲)** or **DOWN (▼)** to move the "▶" mark to "CLOSED CAPTION".
- 3 Press **VOL (+)** or **(-)** to access CLOSED CAPTION setting mode.
- 4 Press **CH UP (▲)** or **DOWN (▼)** to move the "▶" mark to either "MODE" or "DATA".

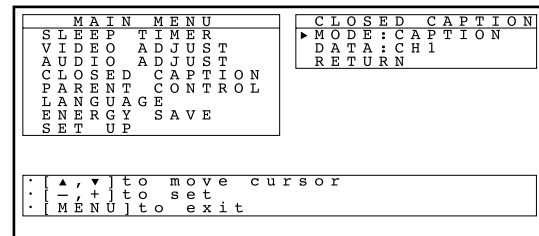
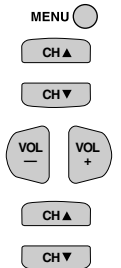

(CLOSED CAPTION setting mode)

- 5 Press **VOL (+)** or **(-)** to change the CLOSED CAPTION setting.

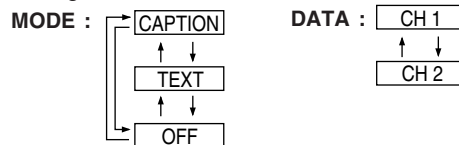
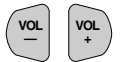

- 6 Press **MENU** to exit.



NOTE:

- If a broadcast has CLOSED CAPTION and the **MUTE** button is pressed, the set enters [CAPTION] mode automatically. Pressing **MUTE** again will return the set to its previous condition.
- Closed Caption may malfunction (white blocks, strange characters, etc.) if signal conditions are poor or if there are problems at the broadcast source. This does not necessarily indicate a problem with your set.
- If any button is pressed to call up the ON SCREEN DISPLAY while viewing a CLOSED CAPTION broadcast, the closed captions will disappear momentarily.
- When viewing in TEXT mode, if no TEXT broadcast is being received, for some programs the screen may become dark and blank. Should this occur, set the Closed Caption mode to "OFF".

Video Adjust

Description of Adjustment Items

Selected item	VOL UP (+) button	VOL DOWN (-) button
PICTURE	To increase contrast	To decrease contrast
TINT	To make skin tones greenish	To make skin tones purplish
COLOR	To increase color intensity	To decrease color intensity
BRIGHT	To increase brightness	To decrease brightness
SHARP	To increase sharpness	To decrease sharpness
COLOR TEMP.	To adjust color of the overall display: "LOW" increases reddish color. "HIGH" increases bluish color. <div style="border: 1px solid black; padding: 5px; width: fit-content; margin: 5px auto;"> ← LOW ⇄ M.L. (MID. LOW) ⇄ M.H. (MID. HIGH) ⇄ HIGH → </div> (→ : VOL (+) / ← : VOL (-))	
FLESH TONE	When ON, adjusts skin tone to more natural colors.	
NOISE REDUCTION	When ON, reduces overall video noise.	
RESET	To return all adjustments to factory preset levels.	

- 1 Press **MENU** to access MAIN MENU screen.
- 2 Press **CH UP (▲)** or **DOWN (▼)** to move the "▶" mark to "VIDEO ADJUST".
- 3 Press **VOL (+)** or **(-)** to access VIDEO ADJUST mode.

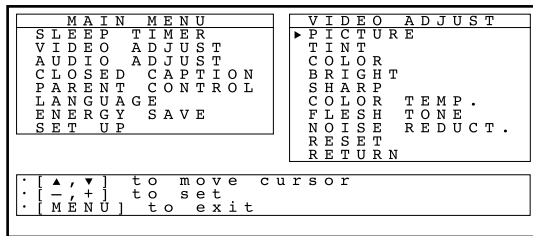
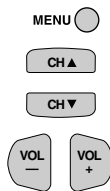

(VIDEO ADJUST mode)

- 4 Press **CH UP (▲)** or **DOWN (▼)** to move the "▶" mark to "the item (Ex. COLOR)" you wish to adjust.
- 5 Press **VOL (+)** or **(-)** to access COLOR ADJUST mode.

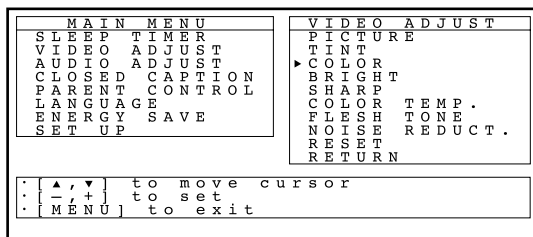
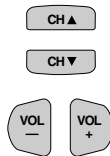

(COLOR ADJUST mode)

- 6 Press **VOL (+)** or **(-)** to adjust "COLOR".

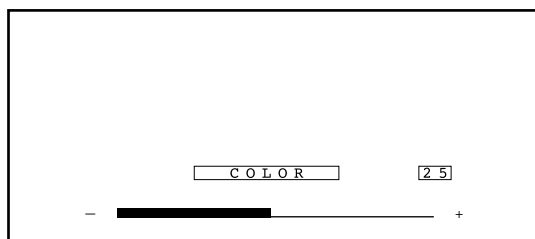
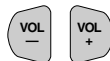

- 7 Repeat steps 4 to 5 to adjust other settings you wish to adjust.
- 8 Press **MENU** to exit.



Audio Adjust

- **MTS (MULTICHANNEL TV SOUND)**
This circuit allows reception of stereo or bilingual TV sound.
- **EQUISOUND**
This function keeps the volume level constant during program changes and commercial breaks.
- **INTERNAL SPEAKER SWITCH**
This function turns the TV's internal speakers "ON" or "OFF" when listening to sound from external speakers by using the AUDIO OUTPUT JACKS on page 26.
- **●SRS® (SOUND RETRIEVAL SYSTEM)**
In "STEREO" mode, this function restores the Audio's three dimensional quality so that stereo sound is closer to a live performance. The "3D MONO" mode adjusts mono sound to simulate a more open, stereo-like quality.

- 1 Press **MENU** to access MAIN MENU screen.
- 2 Press **CH UP (▲)** or **DOWN (▼)** to move the "▶" mark to "AUDIO ADJUST".
- 3 Press **VOL (+)** or **(-)** to access AUDIO ADJUST mode.

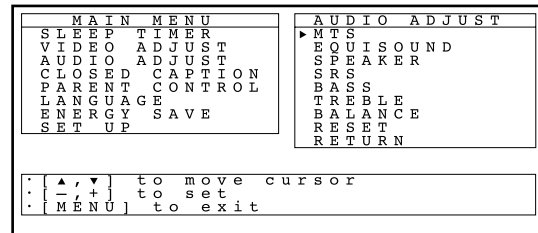
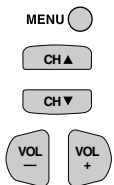

(AUDIO ADJUST mode)

- 4 Press **CH UP (▲)** or **DOWN (▼)** to move the "▶" mark to "MTS", "EQUISOUND", "SPEAKER" or "SRS".
- 5 Press **VOL (+)** or **(-)** to select MTS mode "STEREO", "SAP" or "MONO".

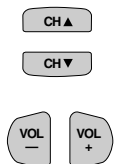

(MTS mode)

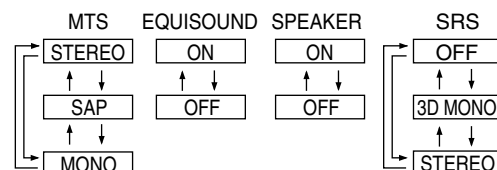

- 6 Press **MENU** to exit.



Audio Adjust (Continued)

NOTE:

- SRS and the (●) symbol are trademarks of SRS Labs, Inc. in the United States and selected foreign countries. SRS technology is incorporated under license from SRS Labs, Inc. and is protected under United States Patent Nos. 4,748,669 and 4,841,572 with numerous additional issued and pending foreign patents. Purchase of this product does not convey the right to sell recordings made with the SRS technology.

Selected item	VOL UP (+) button	VOL DOWN (-) button
BASS	To increase bass response.	To decrease bass response.
TREBLE	To increase treble response.	To decrease treble response.
BALANCE	To emphasize the right speaker's volume.	To emphasize the left speaker's volume.
RESET	To return all adjustments to factory preset levels.	

- Press **MENU** to access MAIN MENU screen.
- Press **CH UP (▲)** or **DOWN (▼)** to move the "►" mark to "AUDIO ADJUST".
- Press **VOL (+)** or **(-)** to access AUDIO ADJUST mode.

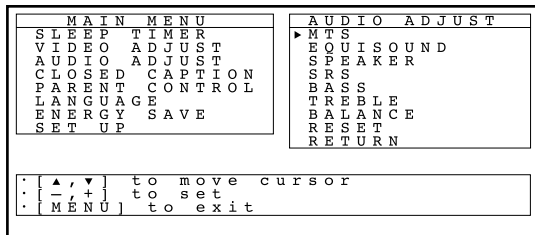
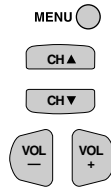

(AUDIO ADJUST mode)

- Press **CH UP (▲)** or **DOWN (▼)** to move the "►" mark to "BASS".

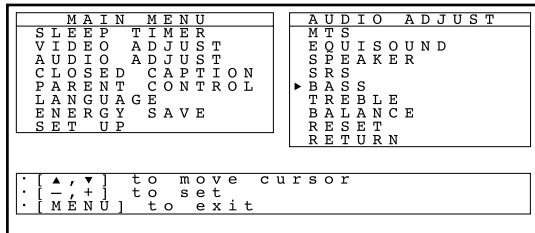

- Press **VOL (+)** or **(-)** to access BASS ADJUST mode.
- Press **VOL (+)** or **(-)** to adjust "BASS".

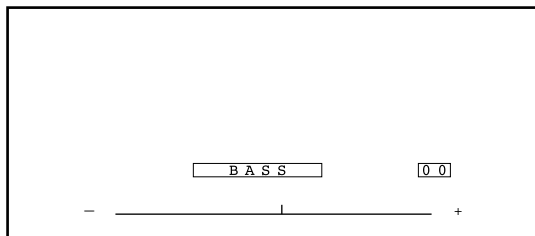
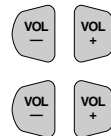

(BASS ADJUST mode)

- Repeat steps 4 and 5 to adjust the other settings you wish to adjust.
- Press **MENU** to exit.

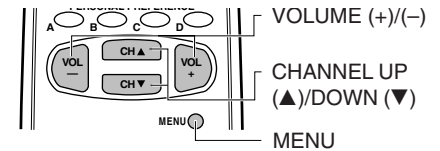

Ex.

Actual screen indicating ON AIR when receiving STEREO broadcasts.

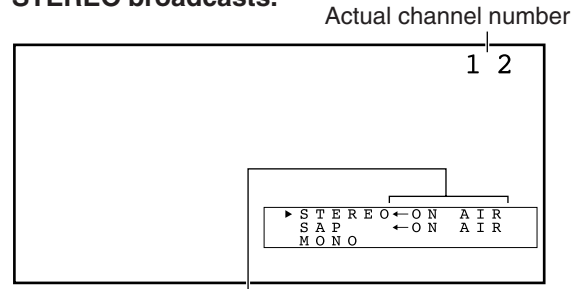

"← ON AIR" will appear next to STEREO or SAP when receiving STEREO or SAP broadcasts.

■ **You can enjoy Hi-Fi stereo sound or SAP broadcasts where available.**

- Stereo broadcasts**
Live television transmission of sports, shows, concerts, etc. can be received in dynamic stereo sound.
- SAP broadcasts**
Television broadcast can be received with either MAIN or SAP sound.
MAIN sound: The normal program soundtrack. (Monaural or stereo where available.)
SAP sound: Second language, supplementary commentaries, etc. (SAP sound is monaural.)

■ **If stereo sound is difficult to hear.**

- You can obtain clearer sound by manually switching to fixed monaural mode.

NOTE:

- Once MONO mode is selected, the TV sound remains monaural even if the TV set receives a stereo broadcast. You must switch the mode back to STEREO if you want to hear stereo sound again.
- Selecting MTS while in the INPUT mode does not change the type of sound; in this case, sound is determined by the video source.

Parent Control (V-CHIP operation)

■ V-CHIP

- This function allows you to restrict TV programs and also allows you to control TV usage based on FCC data. This function is to prevent your children from watching violence or sexual scenes that may be harmful.
- Restriction of TV programs includes two characters that contain information about the program's MPAA rating and the TV Parental Guidelines. MPAA is restricted by age. TV Parental Guidelines are restricted by age and contents.
- Since a TV program may use either the MPAA rating or the TV Guidelines you should adjust both for complete control.

[1] MPAA RATING

RATING		
age base	G	GENERAL AUDIENCES. All ages admitted.
	PG	PARENTAL GUIDANCE SUGGESTED. Some material may not be suitable for children.
	PG-13	PARENTS STRONGLY CAUTIONED. Some material may be inappropriate for children under 13.
	R	RESTRICTED. Under 17 requires accompanying parent or adult guardian.
	NC-17	NO ONE 17 AND UNDER ADMITTED.
	X	X Rating is an older rating that is unified with NC-17 but may be encoded on older movie's data.

• MPAA RATING (Example)

Example 1.

"PG-13" in the age-based RATING is blocked. This will automatically block the high ratings "R", "NC-17", "X" also.

1. User setting	2. Block table
G -----	G not to block
PG -----	PG not to block
PG-13 BLOCK	PG-13 Select block
R BLOCK	R auto-block
NC-17 BLOCK	NC-17 auto-block
X BLOCK	X auto-block

Example 2.

"R" in the age-based RATING is blocked. This will automatically block the high ratings "NC-17" and "X" also.

1. User setting	2. Block table
G -----	G not to block
PG -----	PG not to block
PG-13 -----	PG-13 not to block
R BLOCK	R Select block
NC-17 BLOCK	NC-17 auto-block
X BLOCK	X auto-block

NOTE:

- MPAA RATING is only age-based ratings.

[2] TV PARENTAL GUIDELINES

RATING		⇔ content base ⇔				
		FV (Fantasy Violence)	V (Violence)	S (Sexual Situation)	L (Adult Language)	D (Sexually Suggestive Dialog)
age base ↑ ↓	TV-Y (All children)	X	X	X	X	X
	TV-Y7 (Direct to Older Children)	X	X	X	X	X
	TV-G (General Audience)		X	X	X	X
	TV-PG (Parental Guidance Suggested)		X	X	X	X
	TV-14 (Parents Strongly Cautioned)		X	X	X	X
	TV-MA (Mature Audience Only)		X	X	X	

X: Content Rating can be set.

X: Content Rating can not be set (not normally broadcast by TV station).

• TV-PARENTAL GUIDELINES (Example)

Example 1.

If "TV-Y7" in age-based rating is "BLOCK" then this will automatically block the higher ratings "TV-G", "TV-PG", "TV-14" and "TV-MA". Furthermore, the "D", "L", "S", "V", and "FV" in "CONTENT" are automatically blocked for "TV-Y7" as well unless you choose to unblock each one.

1. User setting	2. Block table
TV-Y -----	
TV-Y7 BLOCK	TV-Y7 Select block
TV-G BLOCK	TV-G auto-block
TV-PG BLOCK	TV-PG auto-block
TV-14 BLOCK	TV-14 auto-block
TV-MA BLOCK	TV-MA auto-block

Example 2.

If all items in the age-based RATINGS are not blocked, "D" in content-based ratings will be blocked as below. (2. Block table)

1. User setting	2. Block table
TV-Y -----	
TV-Y7 -----	
TV-G -----	
TV-PG -----	
TV-14 -----	
TV-MA -----	

		content base				
		FV	V	S	L	D
age base ↑ ↓	TV-Y					
	TV-Y7					
	TV-G					
	TV-PG					
	TV-14					
	TV-MA					

BLOCK CONTENT (D L S V FV)

auto-block

NOTE:

- Age-based ratings can be modified by the content-based ratings but only in the combinations indicated by an X in the table above.
- Choosing a lower age-based rating blocks the higher age-based ratings regardless of content ratings settings.
- An unblocked CONTENT RATING will override its respective AGE RATING, even when that AGE RATING is set to BLOCK. (For example, if FCC data is "TV-PG" & "D", then TV program is still viewable if CONTENT "D" is unblocked for "TV-PG" regardless if "TV-PG" AGE RATING is also blocked.)

[3] ADDITIONAL MODE

Besides the above "MPAA RATINGS" and "TV PARENTAL GUIDELINES," new ratings systems data can be downloaded when they become available. (See page 17.)

Parent Control (V-CHIP operation Continued)

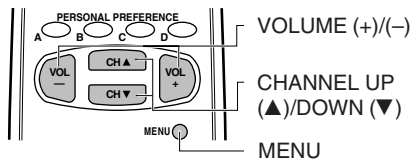

HOW TO SET V-CHIP

[1] MPAA RATING

- 1 Press **MENU** to access MAIN MENU screen.
- 2 Press **CH UP (▲)** or **DOWN (▼)** to move the "►" mark to "PARENT CONTROL".

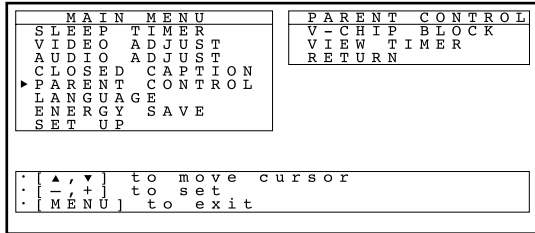

(MAIN MENU screen)

- 3 Press **VOL (+)** or **(-)** to access PARENT CONTROL mode. (The "►" mark move to "V-CHIP BLOCK")

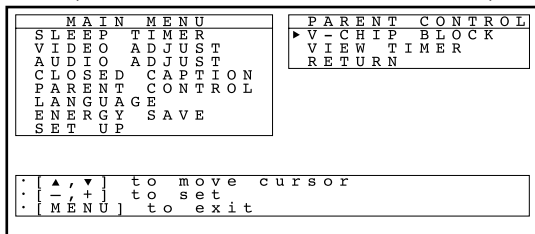

(PARENT CONTROL mode)

- 4 Press **VOL (+)** or **(-)** to access V-CHIP select mode.

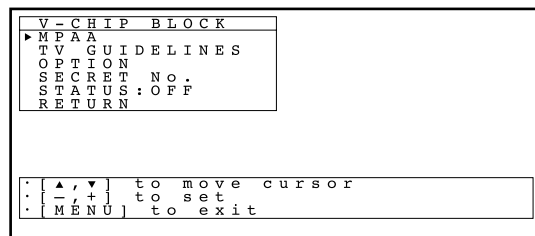

(V-CHIP SELECT mode)

- 5 Press **VOL (+)** or **(-)** to access MPAA rating mode.

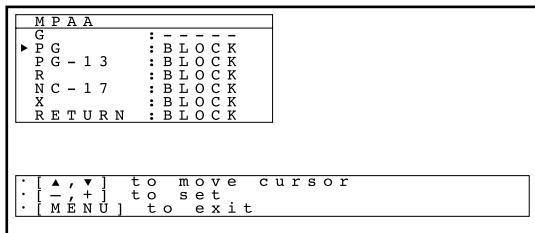

(MPAA rating mode)

- 6 Press **CH UP (▲)** or **DOWN (▼)** to move the "►" mark to "PG", then press **VOL (+)** or **(-)** to select BLOCK.
- 7 Press **MENU** to exit.

NOTE:

- Higher ratings are blocked when a lower rating is set to BLOCK. Refer to examples 1 and 2 in **MPAA RATING** section of V-CHIP operation on page 15.

[2] TV GUIDELINES

- 1 Repeat steps 1 to 4 of [1] **MPAA RATING** to access V-CHIP select mode.

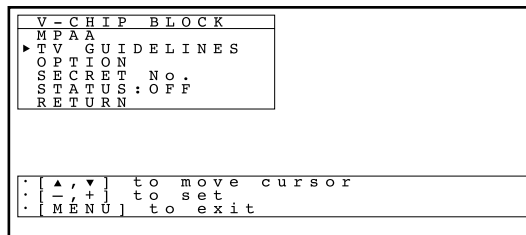

(V-CHIP SELECT mode)

- 2 Press **CH UP (▲)** or **DOWN (▼)** to move the "►" mark to "TV GUIDELINES".
- 3 Press **VOL (+)** or **(-)** to access TV GUIDELINES mode.

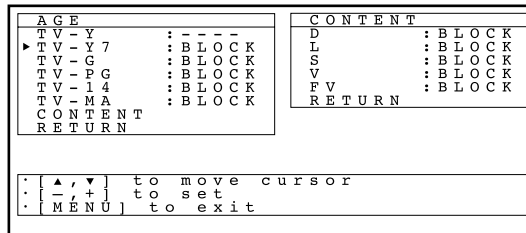

(TV GUIDELINES mode)

- 4 Press **CH UP (▲)** or **DOWN (▼)** to move the "►" mark to "TV-Y7", then press **VOL (+)** or **(-)** to select BLOCK.
- 5 Press **MENU** to exit.

NOTE:

- Higher ratings and their CONTENT are blocked when a lower rating is set to BLOCK. Refer to example 1 in **TV PARENTAL GUIDELINES** section of V-CHIP operation on page 15.

- 1 If you want to change CONTENT in above step 4, press **CH UP (▲)** or **DOWN (▼)** to move the "►" mark to CONTENT, then press **VOL (+)** or **(-)** to access CONTENT mode.

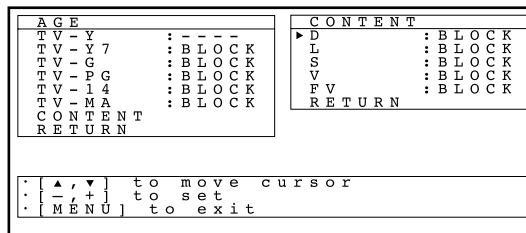

(CONTENT mode)

- 2 You can select "BLOCK" or "-----" (VIEW) from each CONTENT by pressing **CH UP (▲)** or **DOWN (▼)** and **VOL (+)** or **(-)** if you want to control these ratings.
- 3 Press **MENU** to exit.

NOTE:

- If FCC data of a TV program contains only the AGE rating but not the CONTENT rating, then CONTENT settings have no effect.
- Controlling only by the CONTENT rating works best if each AGE rating is unblocked. Refer to example 2 in **TV PARENTAL GUIDELINES** section of V-CHIP operation on page 15.

Parent Control (V-CHIP operation Continued)

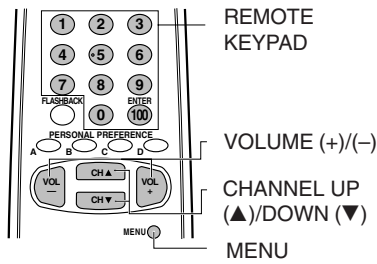

[3] TURN ON V-CHIP BLOCK

- Repeat steps 1 to 4 of (1) **MPAA RATING** to access V-CHIP select mode.

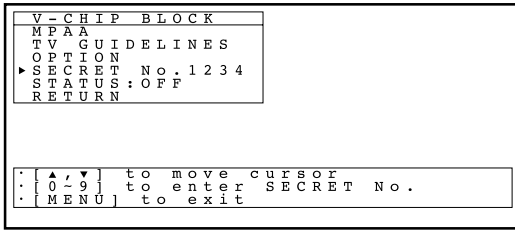

(V-CHIP SELECT mode)

- Press **CH UP (▲)** or **DOWN (▼)** to select "SECRET No." Enter the 4-digit secret no. (Ex. 1 2 3 4) using the **REMOTE KEYPAD**.
- Press **CH UP (▲)** or **DOWN (▼)** to select "STATUS". Press **VOL (+)** or **(-)** to turn "ON" the V-CHIP function. (V-CHIP function is not operating if "STATUS" is "OFF".)

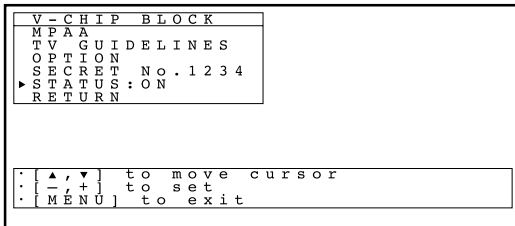

- Press **MENU** to exit.

■ To cancel the V-CHIP BLOCK screen while V-CHIP BLOCK has been activated.

- "V-CHIP HAS BEEN ACTIVATED" will be displayed if you watch the program with Program Rating data as the same as you configured.

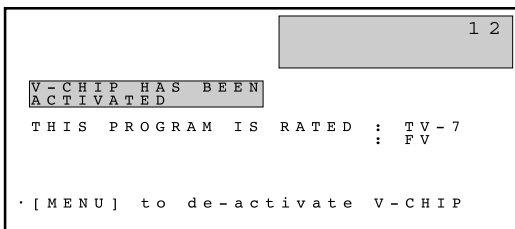

NOTE:

- "V-CHIP HAS BEEN ACTIVATED" will not be displayed if STATUS is not configured to "ON".
- Press **MENU**, then "INPUT SECRET No." will be displayed.

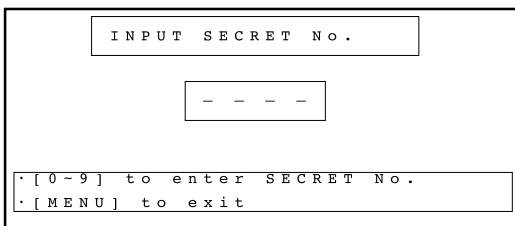

- Enter the 4-digit **SECRET No.** using the **REMOTE KEYPAD**, then V-CHIP BLOCK will temporarily be canceled. If the wrong SECRET No. is chosen, "INPUT SECRET No." will be displayed again. Input the correct SECRET No. again in this case.

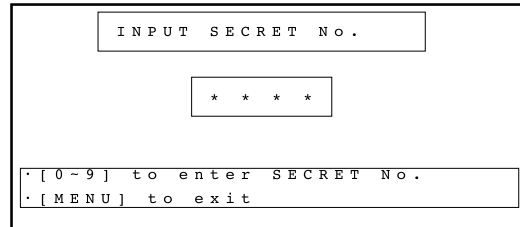
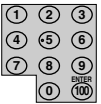

- "V-CHIP TIMER mode" is displayed, then press **VOL (+)** or **(-)** to set **TIMER**.

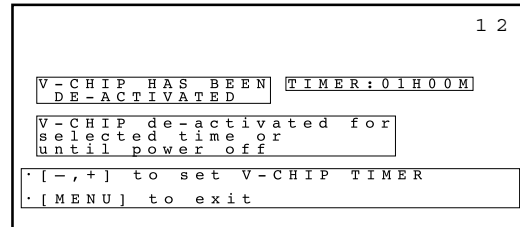
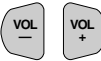

- Press **MENU** to exit.



■ To change the V-CHIP setting while V-CHIP BLOCK is set or change the SECRET No. (When you forget the SECRET No.)

- Change to another unblocked channel. Repeat steps 1 to 4 of [1] **MPAA RATING** to access V-CHIP select mode. The "INPUT SECRET No." will be displayed again.
- Press and hold both **VOL (+)** and **CH DOWN (▼)** on the TV set simultaneously until the message "INPUT SECRET No." disappears. The V-CHIP select mode will be displayed and its settings or secret number can be changed.

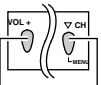

VOL (+) / CHANNEL DOWN (▼) buttons

NOTE:

- As for the secret number, it will remain the same as shown on the screen until you input another 4-digit pin number.
- If you turn the **POWER OFF** then **ON** again, the V-CHIP function will be turned **ON** again.

[3]-A. Additional mode

There will be an additional new rating system. In that case, please setup as follows. Subsequently the new rating system will setup automatically.

- Repeat steps 1 to 4 of [1] **MPAA RATING** to access V-CHIP select mode.
- Press **CH UP (▲)** or **DOWN (▼)** to move the "▶" mark to "OPTION", then press **VOL (+)** or **(-)**.

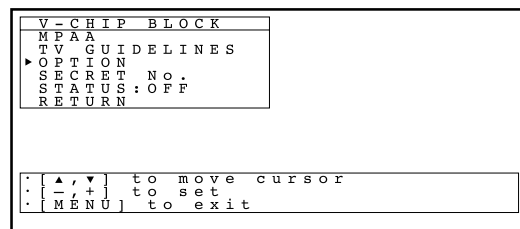
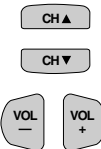

(V-CHIP SELECT mode)

Parent Control (V-CHIP operation Continued)

- 3 Press **CH UP** (▲) or **DOWN** (▼) to select "DOWNLOAD", press **VOL (+)** or **(-)** to activate "ON".

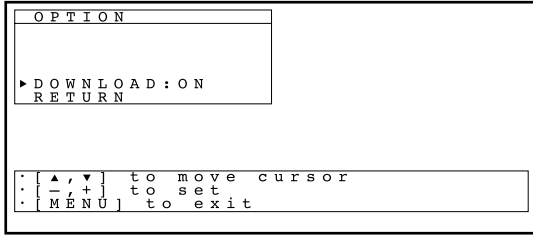
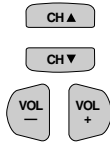

- 4 Press **MENU** to exit.



■ DOWNLOAD V-CHIP DATA

- 1 If you watch the program with "New Rating System Data", DOWNLOAD screen will be displayed.

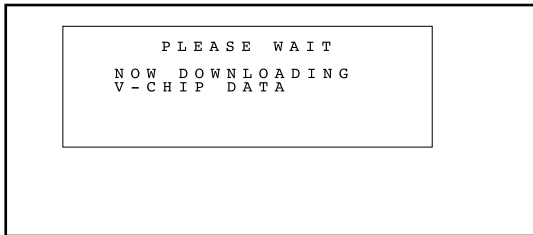

(DOWNLOAD screen)

- 2 DOWNLOAD screen will disappear, if DOWNLOAD is finished.

NOTE:

- DOWNLOAD would not be started if you don't watch the program with New Rating System Data.

[3]-B. Additional mode (Example)

- 1 Repeat steps 1 to 4 of [1] MPAAL RATING to access V-CHIP select mode.

- 2 Press **CH UP** (▲) or **DOWN** (▼) to select "Cdn. ENGLISH RATINGS", then press **VOL (+)** or **(-)**.

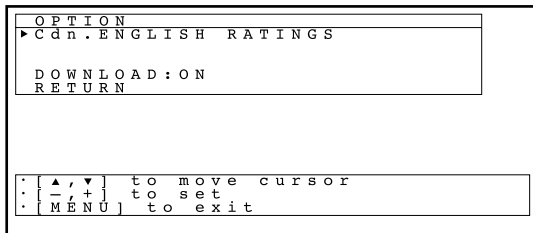
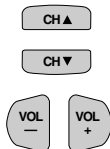

(After download, the new rating data)

- 3 You can select "BLOCK" or "-----" (non BLOCK) from each RATING by pressing **CH UP** (▲) or **DOWN** (▼) and **VOL (+)** or **(-)**.

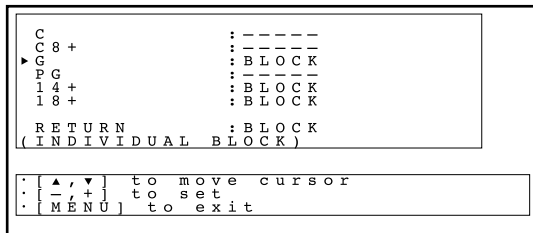
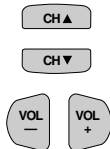

(CANADIAN ENGLISH INDIVIDUAL BLOCK)

- 4 You can select "BLOCK" or "-----" (non BLOCK) from each RATING by pressing **CH UP** (▲) or **DOWN** (▼) and **VOL (+)** or **(-)** if you select "Cdn. FRENCH RATINGS" in step 2.

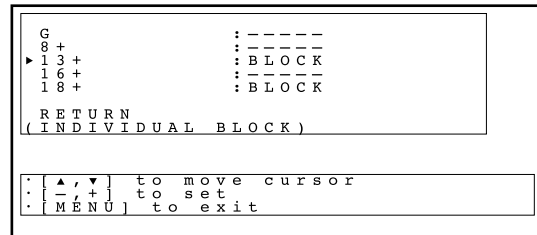
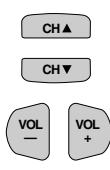

(CANADIAN FRENCH INDIVIDUAL BLOCK)

- The screen displays as follows when the picture is blocked due to V-CHIP being activated.

- A) PIP (Picture In Picture) is OFF
This is shown as page 17 [■ To cancel the V-CHIP BLOCK screen while V-CHIP BLOCK has been activated].

- B) PIP is ON
When the Main Picture is blocked, Main Picture will turn to blue and "V-CHIP has been activated" will be displayed. (Main and Sub Channel No. are displayed, but Sub Picture is not displayed.)

This message will remain the same on the screen. Cancel the V-CHIP BLOCK temporarily at the V-CHIP TIMER mode or change to other channel in this case.

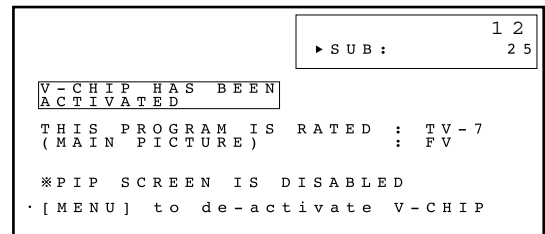

(Main Picture screen)

When the Sub Picture is blocked, Sub Picture will turn to blue and "V-CHIP has been activated" will be displayed. This message will remain the same on the screen. Cancel the V-CHIP BLOCK temporarily at the V-CHIP TIMER mode or change to other channel in this case.

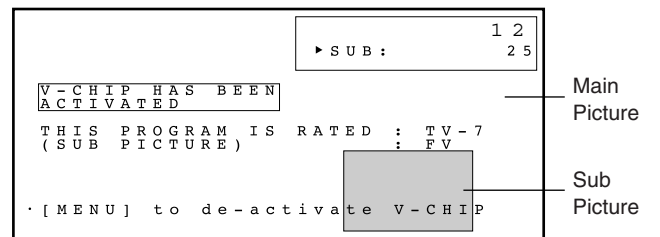

(Main and Sub Picture screen)

V-CHIP TIMER mode during PIP ON

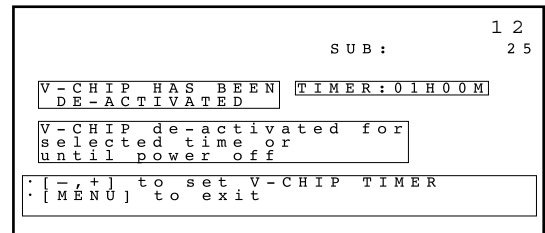

(V-CHIP TIMER mode)

Parent Control (VIEW TIMER)

VIEW TIMER

This function allows you to restrict TV viewing time and also allows you to control TV usage. This function is to prevent your children from watching too much TV.

How to set VIEW TIMER.

- 1 Press **MENU** to access MAIN screen.
- 2 Press **CH UP (▲)** or **DOWN (▼)** to move the "►" mark to "PARENT CONTROL".
- 3 Press **VOL (+)** or **(-)** to access PARENT CONTROL mode.
- 4 Press **CH UP (▲)** or **DOWN (▼)** to move the "►" mark to "VIEW TIMER".

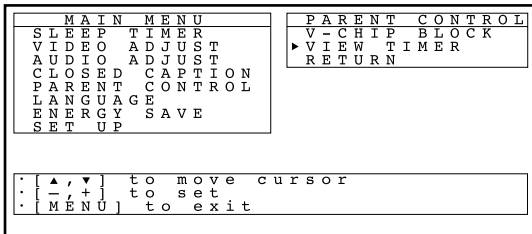

(PARENT CONTROL mode)

- 5 Press **VOL (+)** or **(-)** to access VIEW TIMER mode.

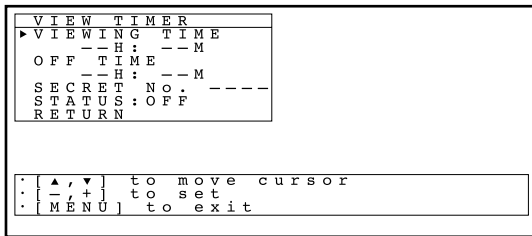

(VIEW TIMER mode; before setting)

- 6 Press **CH UP (▲)** or **DOWN (▼)** to select "VIEWING TIME" and "OFF TIME". For each selection, press the **VOL (+)** or **(-)** to set the time duration.
- 7 Press **CH UP (▲)** or **DOWN (▼)** to select "SECRET No." and then enter the 4-digit no. using the **REMOTE KEYPAD**.
- 8 Press **CH UP (▲)** or **DOWN (▼)** to select "STATUS". Press the **VOL (+)** or **(-)** to turn ON the "VIEWING TIMER". (If STATUS is OFF, VIEW TIMER is not operated)

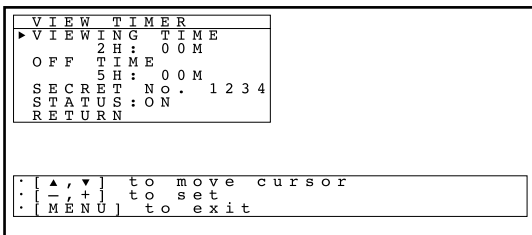

(VIEW TIMER mode; after setting)

- 9 Press **MENU** to exit.

NOTE:

Example

- To restrict anybody from watching the TV for 5 hours, after watching the TV for 2 hours, your settings would look like the settings in Step 8.
- They can choose to watch the 2 hours of TV however they wish. For example, they could watch 1 hour of TV, turn TV off for 30 minutes, then turn TV on and watch the remaining 1 hour on the VIEWING TIMER.

Notice of Remaining VIEWING TIME

- For every 30 minute interval, the "remaining time" will be displayed for four seconds. For the last 5 minutes, the "remaining time" will be displayed every minute.
- "0H 00M REMAIN" will be displayed for 10 seconds just before the VIEWING TIME is completed.

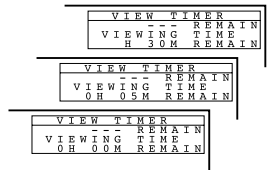

To cancel the VIEW TIMER setting or change the SECRET No. (When you forget the SECRET No.)

- 1 Repeat steps 1 to 3 of "How to set VIEW TIMER." During Step 3, Press **VOL (+)** or **(-)**, and the message "VIEWING TIMER NOW SET" will be displayed.

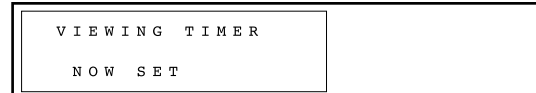

- 2 Press and hold both **VOL (+)** and **CH DOWN (▼)** on the TV set simultaneously until the message "VIEWING TIMER NOW SET" disappears. The VIEW TIMER is now off.
- 3 Now repeat again Steps 1 to 3 of "How to set VIEW TIMER." During Step 3, press the **VOL (+)** or **(-)**, and the message "INPUT SECRET No." is displayed.

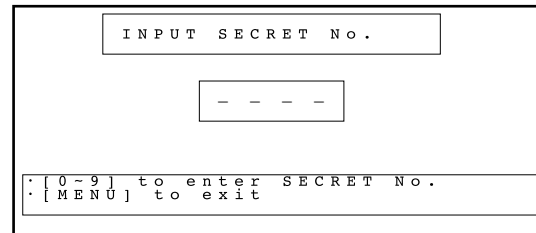

(VIEW TIMER mode)

- 4 Enter the 4-digit SECRET No. using **REMOTE KEYPAD**, and the VIEW TIMER mode will be displayed. Repeat Steps 5 - 7 of "How to set VIEW TIMER".



- 5 If in Step 4 above you have forgotten your SECRET No., press and hold both **VOL (+)** and **CH DOWN (▼)** on the TV set simultaneously until the message "INPUT SECRET No." disappears and the VIEW TIMER mode will be displayed. Then repeat Steps 5 - 7 of "How to set VIEW TIMER".
- 6 Press **MENU** to exit.

NOTE:

- When you choose the correct SECRET No., VIEW TIMER mode is displayed. If the wrong SECRET No. is chosen, the screen message is not displayed. Input the SECRET No. again in this case.
- While the TV set is OFF but the VIEW TIMER is set: Turn on TV; the screen message "TIME OVER" will appear. If you do nothing, the TV will turn off in approximately 30 seconds.

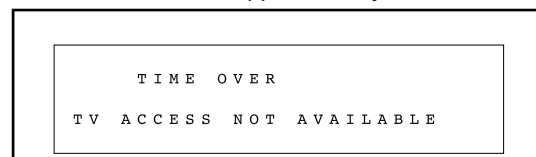

- To cancel VIEW TIMER while the TV set is OFF but the VIEW TIMER is set: Turn on the TV; the screen message "TIME OVER" will appear. Repeat "To cancel VIEW TIMER" Steps 2 - 6.

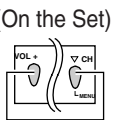
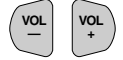
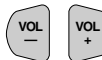
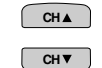
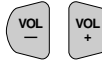
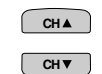
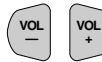
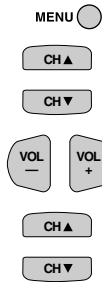

(On the Set)
VOL (+) / CHANNEL DOWN (▼) buttons

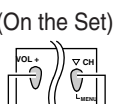
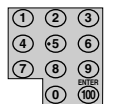
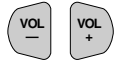

(On the Set)
VOL (+) / CHANNEL DOWN (▼) buttons



Energy Save

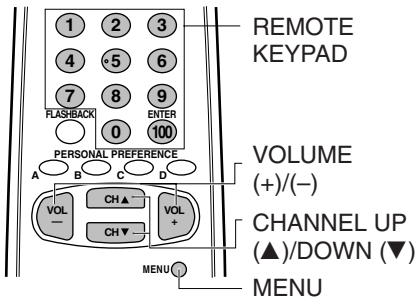

■ This feature lets you lower the power consumption of your TV set which in turn saves you money and minimizes the impact on the environment. When this feature is turned on, it reduces the brightness of the TV to a level that consumes approximately 20 percent less energy than when the feature is turned off.

The reduction in brightness will be less noticeable under low room lighting conditions.

1 Press **MENU** to access MAIN MENU screen.

2 Press **CH UP (▲)** or **DOWN (▼)** to move the “▶” mark to “ENERGY SAVE”.

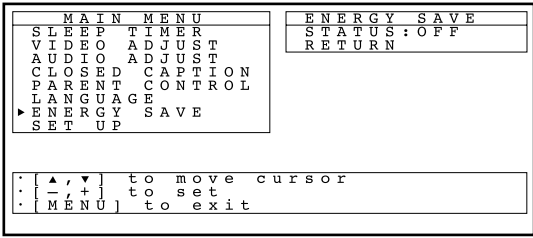

(MAIN MENU screen)

3 Press **VOL (+)** or **(-)** to access ENERGY SAVE select mode.

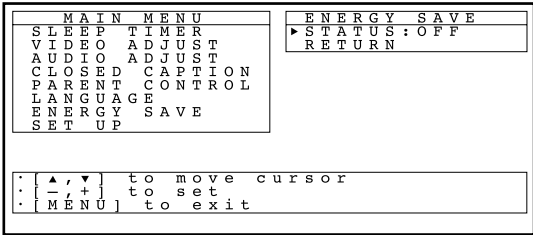

(ENERGY SAVE select mode)

4 Press **VOL (+)** or **(-)** to select “ON”.

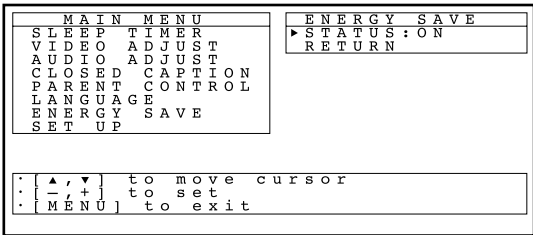

5 Press **MENU** to exit.

Set Up

EZ SETUP

By operating the channel presetting functions, you can preset your TV to the desired channels for viewing.

1 Press **MENU** to access MAIN MENU screen.

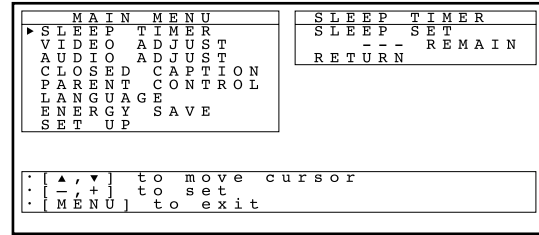

(MAIN MENU screen)

2 Press **CH UP (▲)** or **DOWN (▼)** to move the “▶” mark to “SET UP”.

3 Press **VOL (+)** or **(-)** to access SET UP mode.

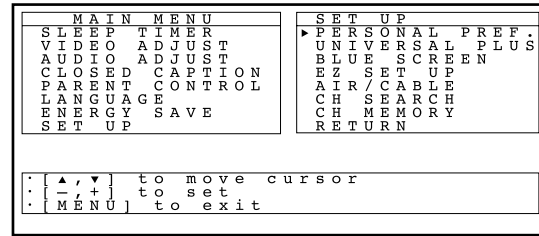

(SET UP mode)

4 Press **CH UP (▲)** or **DOWN (▼)** to move the “▶” mark to “EZ SET UP”.

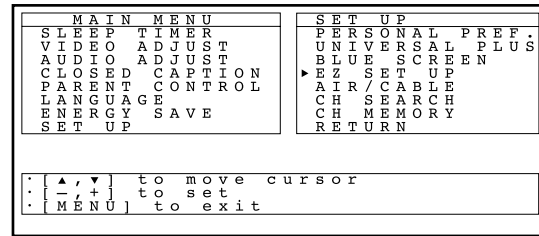

5 Press **VOL (+)** or **(-)** to access EZ SET UP.

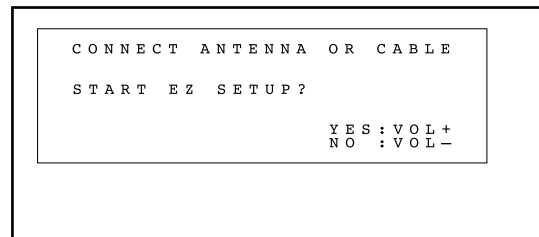

6 Press **VOL (+)**.

The tuner will automatically search for the broadcasting and cable TV channels. (The CH No. will automatically increase when it appears.)

If you want to stop the EZ SETUP process once it has started, press **VOL (-)**. Search will be canceled.

To cancel EZ SETUP

Press **VOL (-)**.

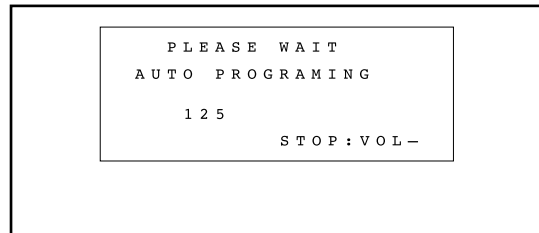

Set Up (Continued)

7 Once EZ SETUP is completed, the lowest channel number memorized will be displayed. (Ex. 2CH)

CHANNEL SETTING

If EZ SETUP does not memorize all the channels in your region, follow the instructions below to manually memorize the channel.

1 AIR/CABLE setting

1 Repeat steps 1 to 3 of EZ SETUP.

2 Press **CH UP (▲)** or **DOWN (▼)** to move the “▶” mark to “AIR/CABLE”.

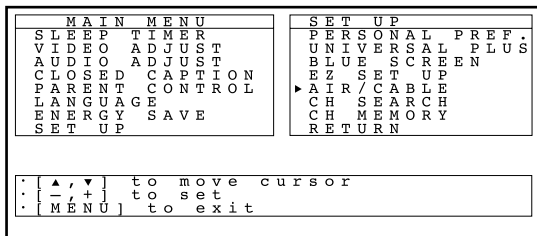

(SET UP mode)

3 Press **VOL (+)** or **(–)** to access AIR/CABLE select mode.

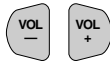

4 Press **VOL (+)** or **(–)** to select your TV signal mode.

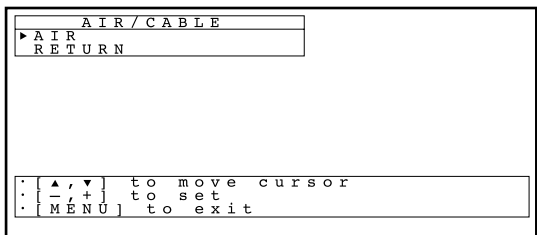
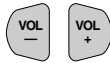

(AIR/CABLE SELECT mode)



(TV signal mode)

5 Press **MENU** to exit.



NOTE:

- Receivable channels of your TV set are:
AIR channels:
VHF: 2 through 13.
UHF: 14 through 69.
- CABLE channels:
1 (HRC and IRC mode only)
2 through 125 (STD, HRC and IRC)

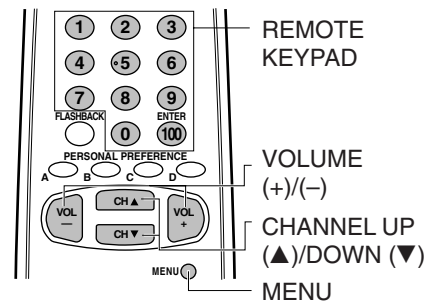

2 Saving Broadcast TV channels to memory.

1 Repeat steps 1 to 3 of EZ SETUP.

2 Press **CH UP (▲)** or **DOWN (▼)** to move the “▶” mark to “CH SEARCH”.

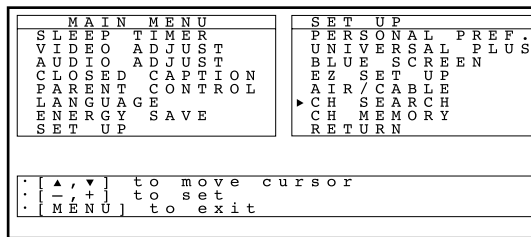

(SET UP mode)

3 Press **VOL (+)** or **(–)** to access CH SEARCH mode.

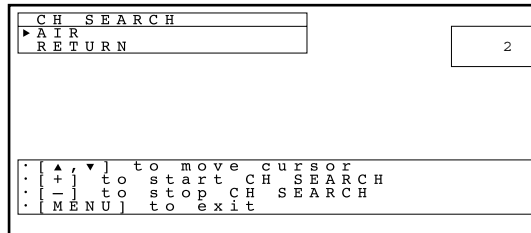
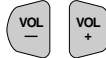

(CH SEARCH mode)

4 Press **VOL (+)**. The tuner will search through all available channels in your area and add them into the TV's memory.



TO STOP SEARCH

Press **VOL (–)**. CH SEARCH will stop at the current channel and will not add any higher channels.



5 Press **MENU** to exit.



NOTE:

- If you press **VOL (+)** again while in the CH SEARCH mode, auto-program will start again, and the previously memorized channels will be lost.

3 Adding weak or additional channels or erasing unwanted channels from TV memory.

1 Repeat steps 1 to 3 of EZ SETUP.

2 Press **CH UP (▲)** or **DOWN (▼)** to move the “▶” mark to “CHANNEL MEMORY”.

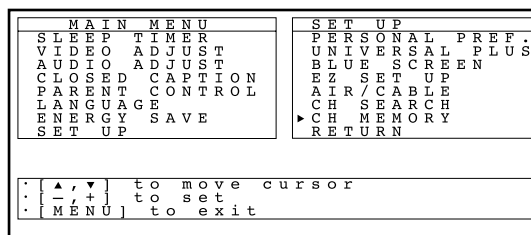

(SET UP mode)

Set Up (Continued)

3 Press **VOL (+)** or **(-)** to access CH MEMORY mode.

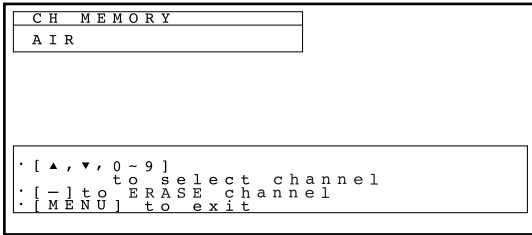

(CH MEMORY mode)

4 Use **CH UP (▲)** or **DOWN (▼)** or **REMOTE KEYPAD** to select each desired channel to add or erase.

5 Press **VOL (+)** to add a channel to the TV's memory or press **VOL (-)** to erase a channel from the TV's memory.

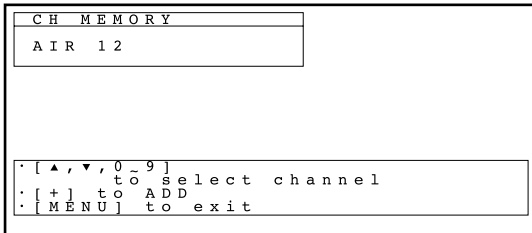

(CH MEMORY unmemorized channel)

VOL (-)
To erase channel 12 from the TV memory

VOL (+)
To add channel 12 from the TV memory

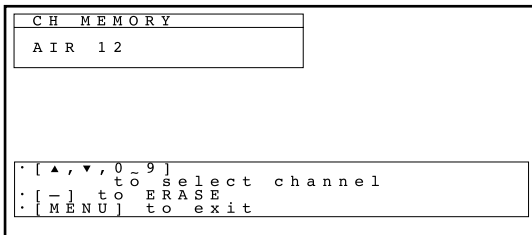

(CH MEMORY memorized channel)

6 Press **MENU** to exit.

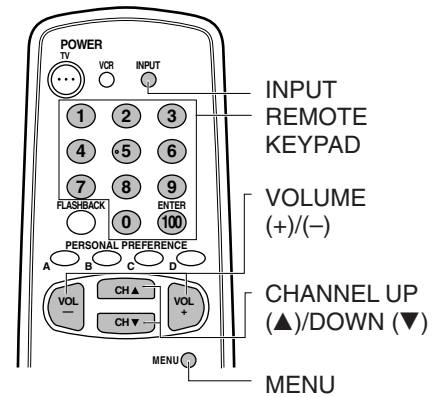
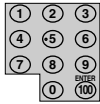
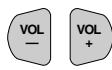

■ UNIVERSAL PLUS Function

VCR input mode will be selected automatically by pressing VCR PLAY button on UNIVERSAL REMOTE CONTROL. (for VCR connections, see pages 27 - 30)

1 Repeat steps 1 to 3 of EZ SETUP.

2 Press **CH UP (▲)** or **DOWN (▼)** to move the "▶" mark to "UNIVERSAL PLUS".

3 Press **VOL (+)** or **(-)** to access UNIVERSAL PLUS mode.

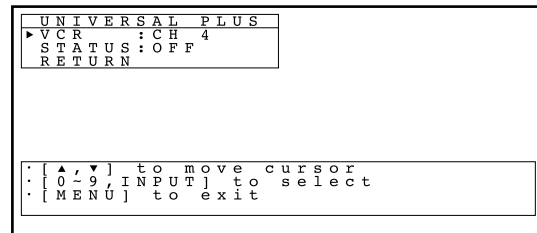

(UNIVERSAL PLUS mode)

4 Press **INPUT** to select the VCR connection. If VCR is connected to Antenna use **REMOTE KEYPAD** to select channel 3 or 4 to match the setting of the VCR.

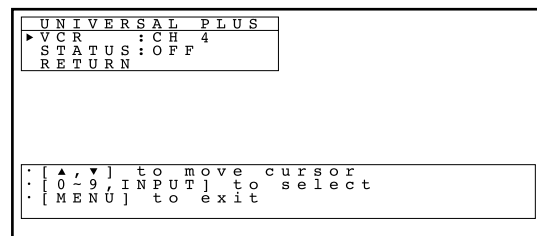

(VCR Setting mode)

5 Press **CH UP (▲)** or **DOWN (▼)** to move the "▶" mark to "STATUS", and press **VOL (+)** or **(-)** to set ON.

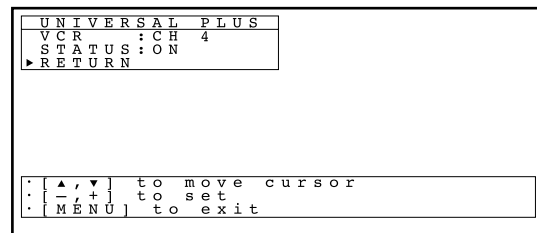

6 Press **MENU** to exit.

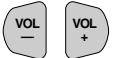
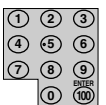
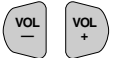

Set Up (Continued)

PERSONAL PREFERENCE

By setting the **PERSONAL PREFERENCE** channels in advance, you can select your favorite channels easily. You can program six favorite channels in four different categories. (total of 24 channels)

- Repeat steps 1 to 3 of **EZ SETUP**
- Confirm the "►" mark is at "PERSONAL PREF."

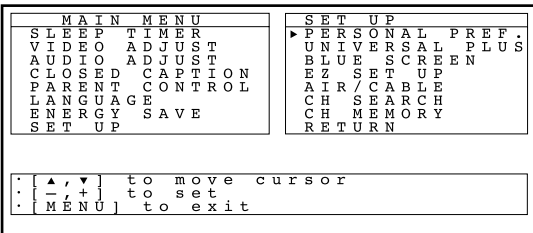

(SET UP mode)

- Press **VOL (+)** or **(-)** to access **PERSONAL PREFERENCE** mode.
- Press **CH UP (▲)** or **DOWN (▼)** and **VOL (+)** or **(-)** to move the "►" mark to the desired position.

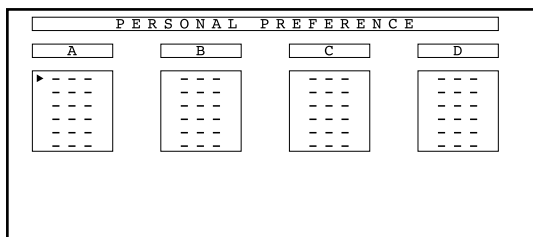
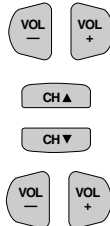

(PERSONAL PREFERENCE mode)

- Use the **REMOTE KEYPAD** to input the CHANNEL Number into the memory.

Example:

125: — Press "100" followed by "2" and then "5".

→ 125 → 25 → 40 → 4 → 18 → 20

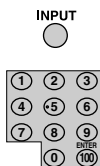

- Repeat steps 4 and 5 to input the next CHANNEL Number.

- Press **MENU** to exit.



To select the PERSONAL PREFERENCE channel.

If the channels are memorized as shown here:

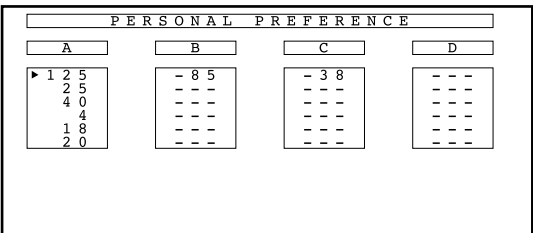

Then press the Remote's "A" button to select the Channels below:

→ 125 → 25 → 40 → 4 → 18 → 20

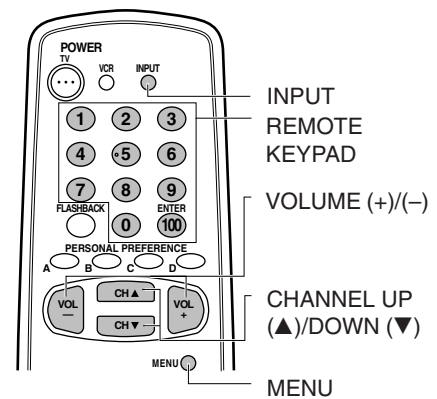

BLUE SCREEN

Automatically turns the screen blue if a broadcast signal is not received.

- Repeat steps 1 to 3 of **EZ SETUP**.
- Press **CH UP (▲)** or **DOWN (▼)** to move the "►" mark to "BLUE SCREEN".

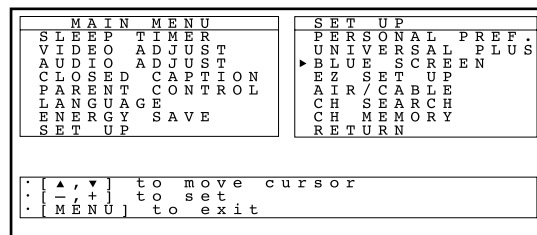

(SET UP mode)

- Press **VOL (+)** or **(-)** to access **BLUE SCREEN** mode.
- Press **VOL (+)** or **(-)** to turn STATUS "ON".

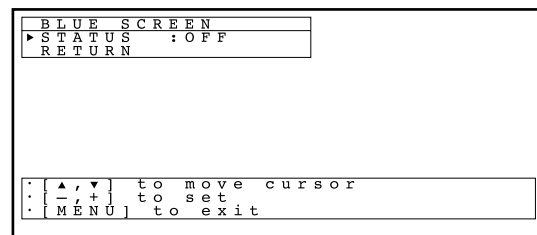
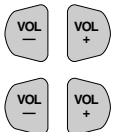

(BLUE SCREEN mode)

- Press **MENU** to exit.



NOTE:

- Poor reception due to weak signals, or too much noise might activate the BLUE SCREEN function despite the presence of a broadcast signal. To continue watching TV under these conditions, switch the BLUE SCREEN "OFF".
- While either VCR or COMPONENT VIDEO input mode are selected, the BLUE SCREEN will not be shown on your TV even if the BLUE SCREEN is turned on.
- If you choose the BLUE SCREEN mode, sometimes the BLUE SCREEN will appear or disappear due to the condition of the reception. In this case, cancel the BLUE SCREEN mode.

PIP (2 Tuner Picture In Picture)

- Using the various video input or the second tuner, you can watch two programs at the same time. During airing of commercial messages, you can watch other program by using the **CM SKIP** function.

To view the Inset Picture.

Press **PIP**.

(Press the button to turn the Inset Picture on and off).

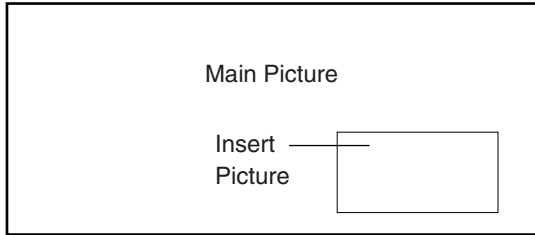

Channel Display when PIP is ON (4 seconds).

Example:

Main Picture — Channel 12

Inset Picture — Channel 6

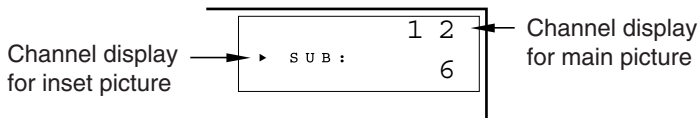

To select the channel or input mode for the Inset Picture.

- If you want to change the channel or input mode, then press **SELECT** to move the "▶" mark to channel display "SUB."

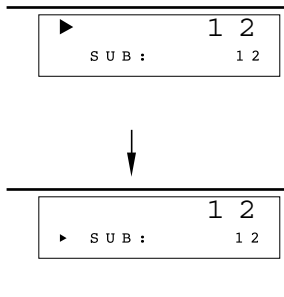

Press **INPUT**.

(Each time you press the button, the picture will change as shown below.)

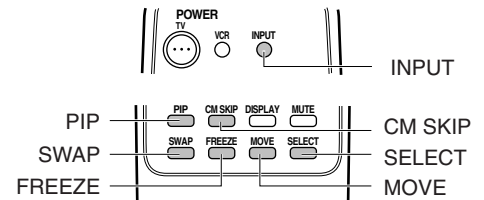
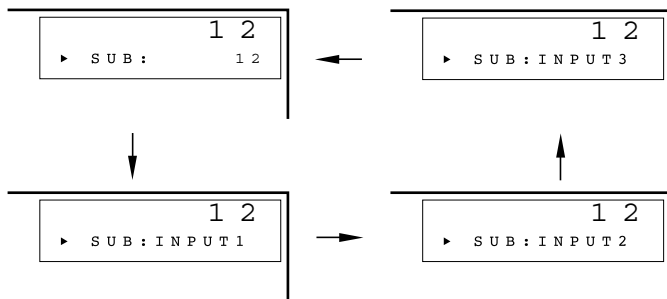

To swap the Main and Inset Pictures.

- Press **SWAP**.

(Press the button to swap the pictures again.)

Example:

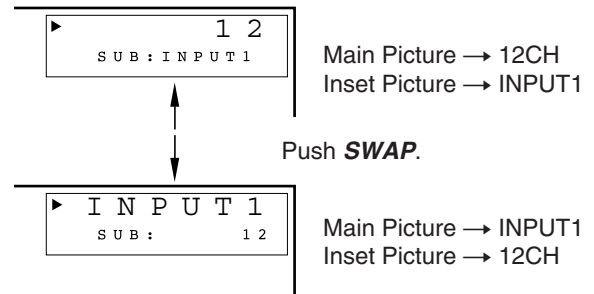

To move the Inset Picture.

Press **MOVE**.

(Press the button again to move the Inset Picture to another position.)

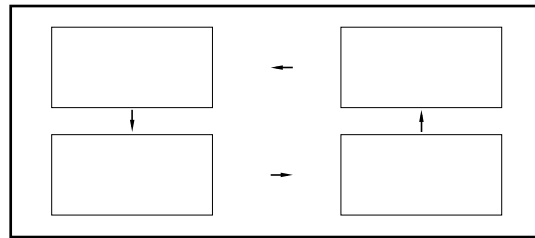

Freeze-Frame Inset Pictures.

- When the Inset Picture is on the screen, press the **FREEZE** to freeze the Inset Picture. Only when the Main Picture is on the screen, press the **FREEZE** to inset a freeze-frame of the Main Picture.
- Press **FREEZE** again to remove the Inset Picture.

Commercial Skip Function

- Use this function when you want to scan other channels during a commercial break.

- When a program break occurs, press **CM SKIP**. Then Main Picture move to the Inset Picture. (While you are watching other channels you can check the Inset Picture.)
- Press **CM SKIP** when the program in Inset Picture starts again. Then Inset Picture moves to Main Picture.

NOTE:

- When the Main Picture's signal is black and white or the signal is lost, the Inset Picture may change to black and white. In this case, the Inset Picture may appear with a bit of vertical jagged lines depending on the type of receiving signal.

Using the Video and Audio Input Jacks

■ Connecting video equipment for playback of video material.

- When the television is connected to video equipment as shown below, the material being played back on the video equipment can be seen on the television screen.

Connecting video device equipped with video output terminal.

CONNECTIONS

(Front connection terminals of TV)

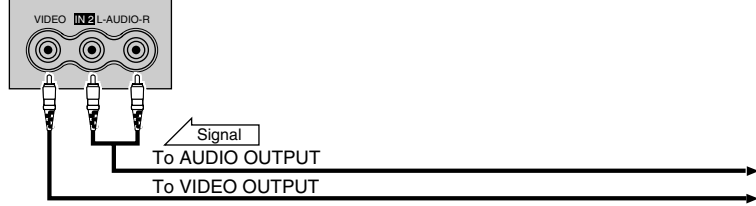

VIDEO EQUIPMENT

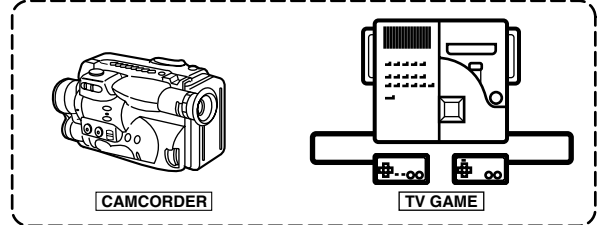

Notes:

- The S-VIDEO INPUT terminals (IN 1, IN 3) are used to obtain a higher quality image by importing image signal separated into color and brightness signals.
- Each S-VIDEO INPUT terminal is for image signal. The audio signals are connected to either IN 1 or IN 3 AUDIO terminals (left and right).

Video Equipment

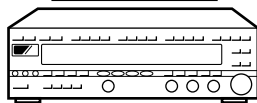

(Rear connection terminals of TV)

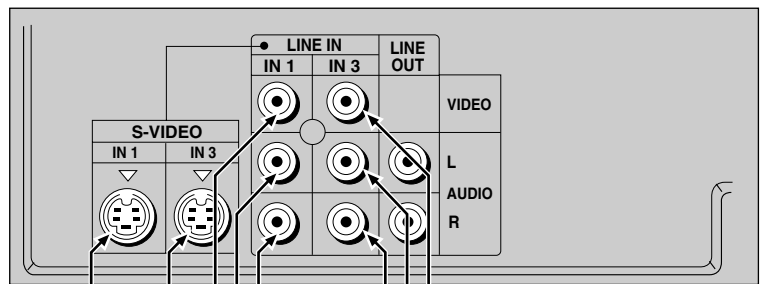

To AUDIO INPUT (L)
To AUDIO INPUT (R)
To VIDEO INPUT

To S-VIDEO OUTPUT
(When your video equipment has an S-VIDEO output terminal).

To S-VIDEO OUTPUT
(When your video equipment has an S-VIDEO output terminal).

To AUDIO INPUT (L)
To AUDIO INPUT (R)
To VIDEO INPUT

■ To watch video material playback.

- Press the Remote's **INPUT** to select the VIDEO INPUT mode to which the video equipment you want to playback is connected.
- The external VIDEO INPUT mode will change as follows each time the **INPUT** is pressed.

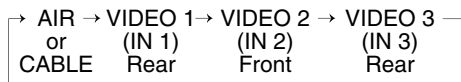

- INPUT mode can be selected by pressing either the **CH UP (▲)** on the TV remote control when the TV is set to the highest channel stored in memory, or by pressing the **CH DOWN (▼)** when it is set to the lowest channel.

NOTE:

- When connecting video or audio equipment to the television, be sure that the power is turned off in order to prevent damage to either the television or the equipment being connected.
- An S-VIDEO terminal has priority over its corresponding VIDEO terminal (IN 1 or IN 3). When you want to watch pictures from video equipment connected to a VIDEO terminal, unplug equipment connected to the corresponding S-VIDEO terminal.
- It is the intent of SHARP that this product be used in full compliance with the copyright law of the United States and that prior permission be obtained from copyright owners whenever necessary.
- For detailed information on the connection and use of auxiliary equipment, refer to the instruction manuals of the equipment being used.
- The connection cords can be obtained from your local video store.

Using the Audio Output Jacks

- These jacks are used for connecting a standard studio amplifier. Control of STEREO/MONO/SAP, BASS, TREBLE, BALANCE, VOLUME and MUTE are retained at the TV. These jacks relay the audio signal of all programs being displayed on the TV screen.

(AUDIO OUTPUT JACKS are located on the rear of the cabinet).

CONNECTIONS

(Rear connection terminals of TV)

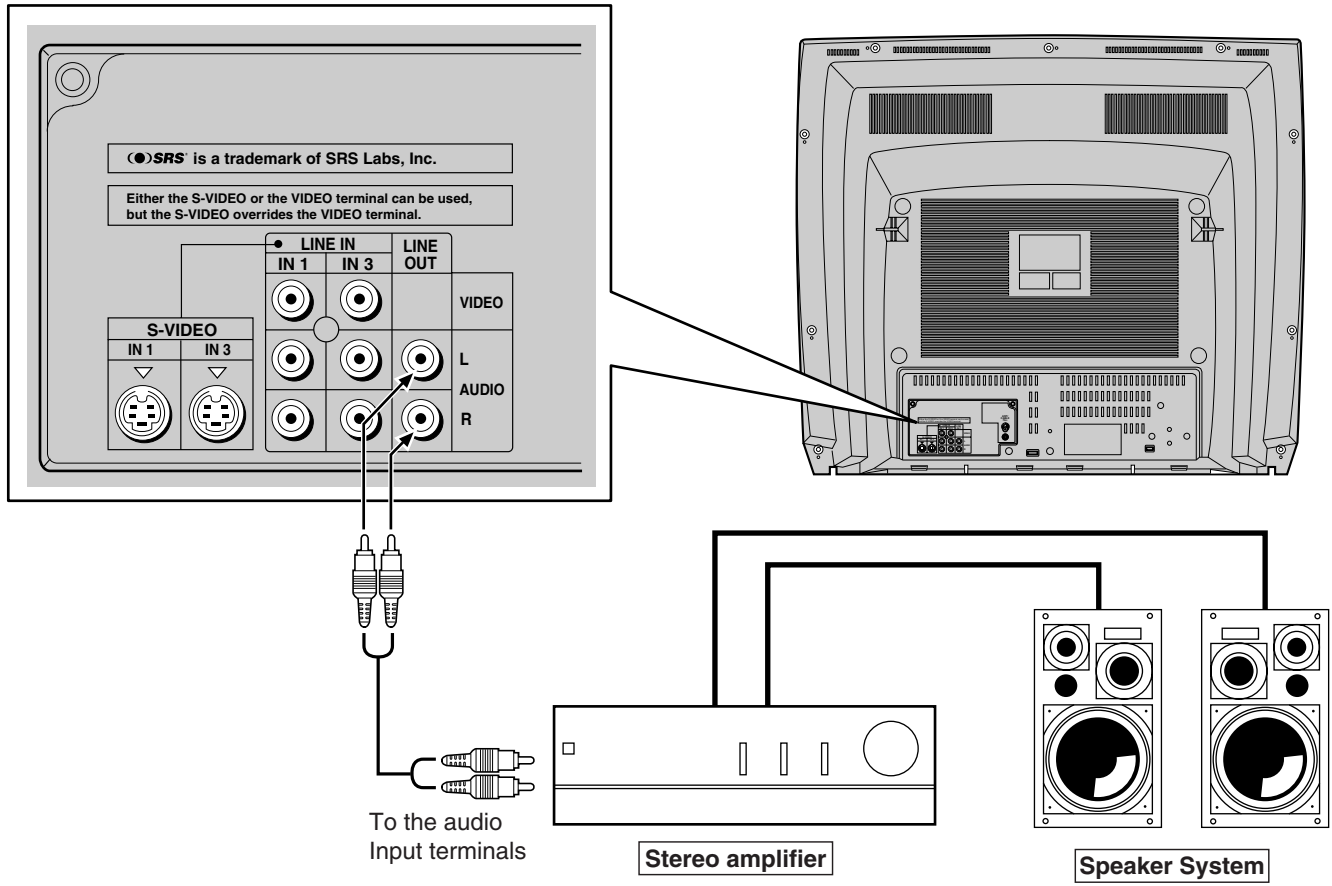

- Before connecting the cord, turn on the TV and adjust the VOLUME control on the TV for a moderate listening level.
- Turn off the TV and connect the audio cord to the AUDIO LINE OUTPUT JACKS on the TV.
- Turn the TV set and stereo amplifier on.
- If you desire, you can turn off the sound to the TV's internal speakers by SPEAKER mode. See pages 13 - 14.
- Adjust the VOLUME control on the stereo amplifier for a moderate listening level.
- Control of the audio can be done using the audio controls (STEREO/MONO/SAP, VOLUME, SRS, EQUISOUND and MUTE), from either the remote control, or directly from the TV set.

NOTE:

- For detailed information on the connection and use of auxiliary equipment, refer to the operation manuals of the equipment being used.
- When connecting monaural equipment to the AUDIO INPUT or OUTPUT of this set, use an audio connection cord and plug adapter as shown below.
- For optimal sound quality, it is recommended to keep the TV's audio output level high.

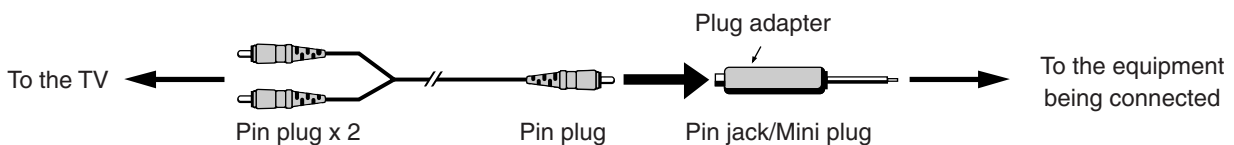

Operation of Remote Control

■ Universal Remote Control

With the purchase of your television set you also have received the latest innovation in remote control technology. With its easy-to-use push button keyboard, your Remote can control your television set and most infrared remote controlled VCRs and cable TV converters as well.

NOTE:

- Depending on the model, year produced, brand and type of VCR, some models may not be compatible with the remote control.
- Some brands of Cable TV converter Box may not enable channel selection until the ENTER is pressed.

Example:

- When you select channel 24,
- (1) Press REMOTE KEYPAD "2".
 - (2) Press REMOTE KEYPAD "4".
 - (3) Press **ENTER**.

For detailed information on the use of the VCR or Cable TV converter Box refer to their operating manuals.

■ Using Your Remote With Your TV

After installing the batteries, set the **TV-CATV** on the remote to the TV position. (If you can change the channel of the TV by pressing **CH UP (▲)** or **DOWN (▼)** on the Remote Control, it is the TV position.)

■ "Identifying" Remote VCR and Cable TV Converters

Your Remote Control has been set at the factory to operate your TV and many remote control VCRs and Cable Converters. However, in some cases an easy one-time set-up step may be necessary before the Remote will operate accessory VCRs and Cable Converters.

- In this set-up step, the Remote locates and memorizes the remote control transmitter code for the VCR or Cable Converter.
- Once "identified", the Remote sends the proper remote signals to operate your accessory.
- This identify step will not have to be repeated until power to the Remote is interrupted due to a battery failure.

■ USING YOUR REMOTE CONTROL WITH A VCR

Once you make certain the Remote Control has "identified" your remote controlled VCR, the Remote Control is ready to operate your unit. The various VCR function buttons on the Remote Control will not operate your VCR if those features are not already found on your unit.

- All VCR buttons will operate whether the Remote Control is in TV or CATV modes.
- For detailed information on the use of the VCR, refer to the operation manual of the VCR.

VCR POWER

Press to turn the VCR on and off.

PLAY ►

Press to playback a tape.

REWIND ◀◀

Press to rewind a tape.

For some VCRs you may need to press STOP first, then REWIND. In Playback mode, hold button down to view picture moving rapidly in reverse.

PAUSE II

Press to temporarily stop the tape during playback or recording. Press again to release Pause.

STOP ■

Press to stop the tape.

REMOTE KEYPAD

Use to enter two-digit code numbers when identifying your VCR.

ENTER

FF ►►

Press to rapidly advance the tape. For some VCRs, you may need to press STOP first, then FF. In Playback mode, hold button down to view the picture moving rapidly in forward direction.

VCR CHANNEL

UP (▲)/ DOWN (▼)

Press to scan up or down through channels on the VCR.

RECORD ●

Press to begin recording.

PIP BUTTONS

See page 24.

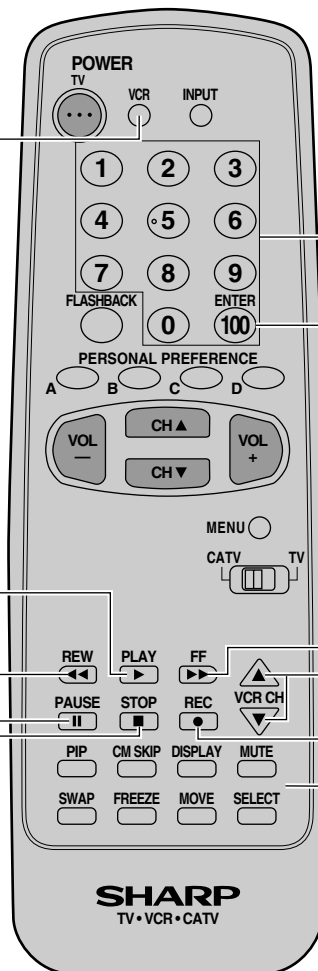

Operation of Remote Control (Continued)

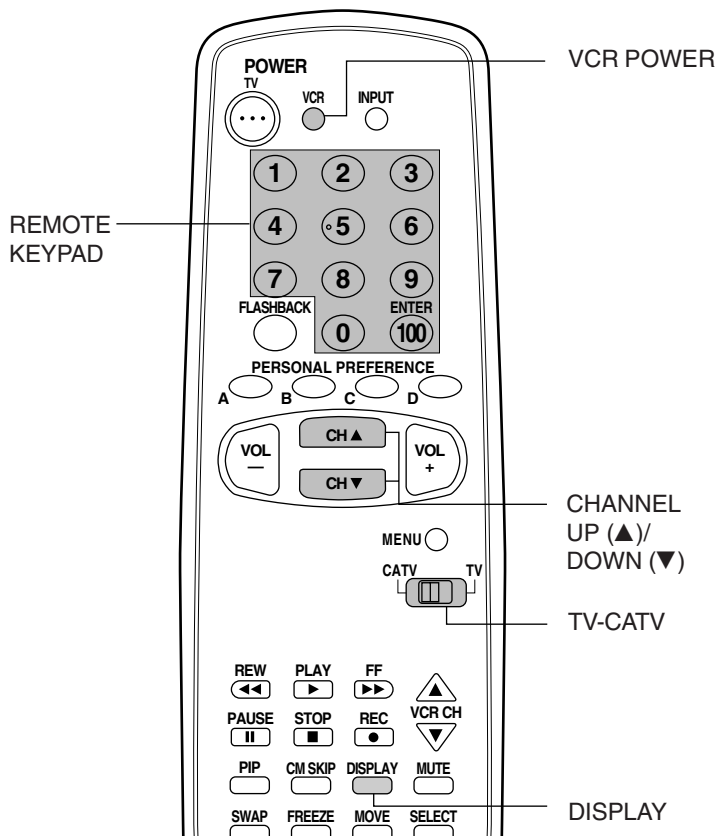

Some brands have more than one remote code listed, due to changes in the remote codes from early to later model years, or due to format differences (VHS/BETA). In such cases, you may have to try more than one code to find the code your VCR accepts.

NOTE:

Depending on the model, year produced, brand, and type of VCR, some models may not be compatible with the remote control.

■ To Identify Your VCR – Search Method.

- (1) Slide **TV-CATV** switch on the remote to TV.
- (2) Press **POWER** on the VCR to ON.
- (3) Stand at least six feet away from the front of the VCR. Point the remote towards the VCR. Hold down **DISPLAY** and **CH UP (▲)** at the same time. Keep holding the buttons down.
- (4) Watch the Channel Number indicator on the VCR. Channel numbers will scan up when the VCR has been identified. Release **DISPLAY** and **CH UP (▲)** as soon as the channel numbers start to scan up. The VCR's remote control code number has been identified, and the remote is ready to operate the VCR.

■ HOW TO IDENTIFY A VCR

The remote control may already be set to operate your VCR. Try this initial check to see if going on to the following "identify" section is necessary.

- (1) Point remote towards VCR and press **VCR POWER**.
- (2) Does the remote turn the VCR ON and OFF?
 - If yes, the remote is ready to operate the VCR and no further steps are needed.
 - If no, continue to the "identify" section.

■ To Identify Your VCR – Direct Entry Method.

Use the following steps and list on page 29 to quickly find the remote control code for your accessory VCR.

- First look up your VCR's remote control code number before going through the direct code entry steps control.
 - If this procedure does not identify your accessory VCR, use the Search method of identification (described in the next section).
- (1) Slide **TV-CATV** switch to TV.
 - (2) Press and hold down **DISPLAY** and **CH DOWN (▼)** on your remote control. Then release both buttons.
 - (3) Within ten seconds after releasing **DISPLAY** and **CH DOWN (▼)**, enter your VCR's two-digit remote control code number using **REMOTE KEYPAD** (refer to list).
 - The remote control is now ready to send commands to your VCR.

Operation of Remote Control (Continued)

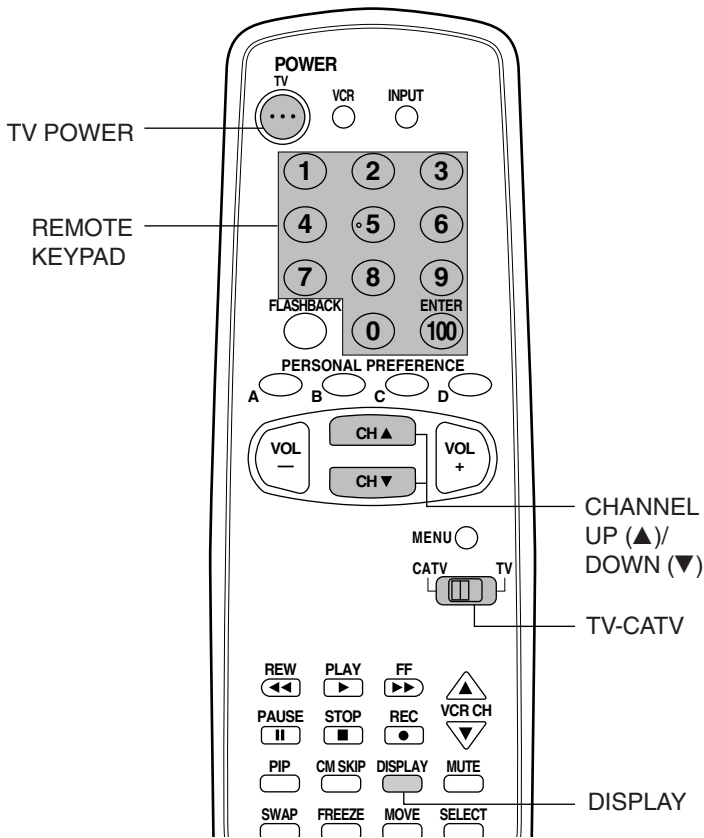

VCR BRAND	REMOTE CONTROL CODE NUMBER
Akai _____	25, 26, 37
Audio Dynamics _____	15, 22, 30
Broksonic _____	32
Canon _____	04
Capehart _____	34
Craig _____	10, 31
Curtis Mathis _____	04
Daewoo _____	34
DBX _____	15, 22, 30
Dynatech _____	29
Emerson _____	21, 32, 35
Fisher _____	09, 10, 11
Funai _____	28, 29
GE _____	04
Goldstar _____	24
Hitachi _____	06
Instant Replay _____	04
JC Penney _____	04, 06, 24, 30
JVC _____	15, 41, 42
Kenwood _____	14, 15
Lloyds _____	29
Magnavox _____	04, 05, 08
Magnin _____	31
Marantz _____	30
Memorex _____	04, 10, 24, 29
Minolta _____	06
Mitsubishi _____	17, 18, 39, 40
Montgomery Ward _____	02, 43
Multitech _____	29
NEC _____	15, 22, 30
Panasonic _____	04, 44
Pentax _____	05, 06
Philco _____	04, 05
Philips _____	04, 05, 08
Quasar _____	04
RCA _____	06, 07, 33
Realistic _____	01, 02, 10, 24
Samsung _____	23, 31
Sanyo _____	14, 10
Scott _____	20
Sears _____	06, 11, 24
Sharp _____	01, 02, 03
Shintom _____	36
Sony _____	12, 13, 38
Sound Design _____	29
Sylvania _____	04, 05, 08
Symphonic _____	29
Tatung _____	15
Teac _____	15, 29
Teknika _____	27, 29
Thomas _____	29
TMK _____	21
Toshiba _____	19, 20
Video Concepts _____	30
Yamaha _____	15, 29, 30
Zenith _____	16

TIPS ON IDENTIFYING YOUR VCR:

If your VCR model does not have the CHANNEL UP function on its remote control, it cannot be identified using the SEARCH method of identifying. For such models, please try the DIRECT ENTRY method of identifying.

Be Patient: a minute or two can seem a lot longer when you're waiting for something to happen, but the code should be identified within two minutes. Remember, it is only a one-time set-up.

Be careful not to let the VCR scan more than five channels when the indicator starts to move up. If you continue holding down the **DISPLAY** and **CH UP (▲)** after five channel scans, the proper remote code can be passed up, and the two minute identify cycle will have to be repeated.

If a channel change does not occur on the VCR within two minutes, read the identifying instructions again and repeat the steps. Should a channel change still not occur, the remote will not operate with the desired VCR.

■ HOW TO IDENTIFY A CABLE CONVERTER

■ To Identify Your Cable Converter –Direct Entry Method.

Use the following steps and list to quickly find the remote control code for your cable TV converter.

- First look up your converter's remote code number on page 30 before going through the direct code entry steps below.
- If this procedure does not identify your converter, use the Search method of identification (described in the next section).

- (1) Slide **TV-CATV** switch to CATV.
- (2) Press and hold down **DISPLAY** and **CH DOWN (▼)** on your remote control.
Then release both buttons.

Operation of Remote Control (Continued)

(3) Within ten seconds after releasing **DISPLAY** and **CH DOWN** (▼), enter your converter's two-digit code number using **REMOTE KEYPAD** (refer to list).

- The remote control is now ready to send commands to your converter.
- Some brands have more than one remote code listed, due to changes in the remote codes from early to later model years. In such cases, you may have to try more than one code to find the code your converter accepts.

NOTE:

Depending on the model, year produced, brand, and type of CATV converter, some models may not be compatible with the remote control.

■ To Identify Your Cable Converter – Search Method.

- (1) Slide **TV-CATV** switch on the remote to CATV.
- (2) Press the **POWER** button on the cable converter to ON.
- (3) Stand at least six feet away from the converter. Point the remote towards the converter. Hold down the **DISPLAY** and **CH UP** (▲) at the same time. KEEP HOLDING THE BUTTONS DOWN.
- (4) Watch the Channel Number indicator on the converter. Channel numbers will scan up when the converter has been identified. Release the **DISPLAY** and **CH UP** (▲) as soon as the channel numbers start to scan up. The converter's remote control code number has been identified, and the remote is ready to operate the converter.

TIPS ON IDENTIFYING YOUR CABLE CONVERTER:

Be Patient: a minute or two can seem a lot longer when you're waiting for something to happen, but the code should be identified within two minutes. Remember, it is only a one-time set-up.

Be careful not to let the CATV converter scan more than five channels when the indicator starts to move up. If you continue holding down the **DISPLAY** and **CH UP** (▲) after five channel scans, the proper remote code can be passed up, and the two minutes identify cycle will have to be repeated.

If a channel change does not occur on the cable converter within two minutes, read the identifying instructions again and repeat the steps. Should a channel change still not occur, the remote will not operate with the desired converter.

NOTE:

Some satellite receivers can be operated by the **REMOTE CONTROL**. If you have a Satellite Receiver, you can use the above method to search for available channels.

CATV CONVERTER BRAND	REMOTE CONTROL CODE NUMBER
Anvision _____	07, 08
Cable Star _____	07, 08
Eagle _____	08
Eastern International ____	02
General Instrument ____	04, 05, 15, 23, 24, 25, 30, 36
Hamlin _____	12, 13, 34
Jerrold _____	04, 05, 15, 23, 24, 25, 30, 36
Macom _____	37
Magnavox _____	07, 08, 19, 25, 28, 29, 32, 33, 40, 41
NSC _____	09
Oak _____	01, 16, 38
Oak Sigma _____	18
Panasonic _____	27, 39
Philips _____	07, 08, 19, 26, 28, 29, 32, 33, 40, 41
Pioneer _____	18, 20
Randtek _____	07, 08
RCA _____	27, 43
Regal _____	12, 13
Regency _____	02
Scientific Atlantic ____	03, 22, 42
Sony _____	44
Sylvania _____	11
Teknika _____	06
Texscan _____	11
Tocom _____	17, 21
Unika _____	31
Viewstar _____	07, 08, 19, 26, 28, 29, 32, 33, 40, 41
Zenith _____	14

Before Calling for Service

Check these items and see if you can correct trouble with a slight adjustment of the controls.

QUICK SERVICE CHECK LIST	PROBLEM																
POSSIBLE REMEDY	No Playback of VCR and Disk Player	No Picture or Sound from External Video/Audio Products	Remote Control Doesn't Work	Bars On Screen	Picture Distorted	Picture Rolls Vertically	No Color	Poor Reception on Some Channels	Weak Picture	Lines or Streaks in Picture	Ghosts in Picture	Picture Blurred	Sound OK, Picture Poor	Picture OK, Sound Poor	No Picture or Sound	Dark and Blank Picture	External Electrical Noise Interfering with TV's Operation
Try a new channel, if OK, then possible station trouble.					X	X	X	X	X	X	X	X	X	X	X		
Is TV plugged in? Power at outlet?		X	X												X		
Is TV's POWER button on?		X													X		
Is antenna connected to terminal on the back of the set?							X	X	X		X		X		X		
If outside antenna is being used, check for broken wire.				X	X	X	X	X	X	X	X	X	X		X		
Check for local interference or external electrical noise.				X	X			X		X	X		X	X			X
Turn off with POWER button and then turn it on after about a minute.		X													X		
Adjust COLOR control.							X										
Adjust PICTURE control.									X				X				
Check external Video/Audio products; look for loose / broken connections leads. (Refer to pages 25 - 26.)	X	X											X	X	X		
Check batteries of Remote Control.			X														
Press CATV/TV Select Switch to TV position.			X														
Are audio cables connected firmly? Check the volume level.															X		
Is SPEAKER ON? See page 13 - 14.															X		
Change Closed Caption mode to "OFF" / Energy Save mode to "OFF".																X	
Unplug the TV and plug it in again after two minutes.			X			X	X	X	X				X	X	X	X	X

NOTE:

- When viewing in TEXT mode, if no TEXT broadcast is being received, the screen may become dark and blank. Should this occur, set the Closed Caption mode to "OFF".
- If your TV does not work normally in such case of power failure, once turn power off and then return power on again.

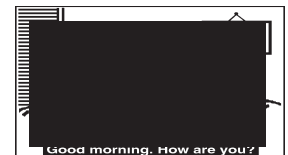

(Dark and Blank Picture)

Antes de llamar al servicio de reparaciones

Verifique estos items para ver si usted mismo puede solucionar el problema.

LISTA DE COMPROBACIONES DE SERVICIO RAPIDO	PROBLEMA																
	El video o el reproductor de discos de video no reproducen imágenes	El equipo de video/audio externo no produce imagen ni sonido	El mando a distancia no funciona	Barras en la pantalla	Imagen distorsionada	La imagen se desplaza verticalmente	No hay color	Mala recepción de algunos canales	Imagen débil	Franjas en la imagen	Imagen fantasma	Imagen borrosa	Sonido adecuado, imagen mala	Imagen adecuada, sonido malo	No hay imagen ni sonido	Imagen oscura y en blanco	Interferencia de ruido eléctrico externo con el funcionamiento del televisor
POSIBLE SOLUCIÓN																	
Pruebe con otro canal y si todo está bien, el problema puede ser de la emisora.				X	X	X	X	X	X	X	X	X	X	X	X		
Está conectado el televisor? Llega electricidad al tomacorrientes?		X	X												X		
Está conectado el interruptor del televisor?		X													X		
Está conectado la antena al terminal del panel posterior del televisor?							X	X	X		X		X		X		
Si utiliza una antena exterior, cerciórese de que el cable no esté dañado.				X	X	X	X	X	X	X	X	X	X		X		
Compruebe si hay interferencia local.				X		X		X		X	X		X	X			X
Desconecte el interruptor POWER y vuelva a conectarlo después de transcurrir un minuto.		X													X		
Adjuste el control de COLOR.							X										
Adjuste el control de MATIZ.									X				X				
Verifique los productos externos de Video/Audio, revise si hay fugas de conexiones sueltas o rotas.	X	X											X	X	X		
Compruebe el estado de las pilas del mando a distancia.			X														
Pulse CATV/TV selector para situarlo sobre la posición TV.			X														
Están bien conectados los cables de sonido? Compruebe el nivel del volumen.															X		
Está conectado el altavoz?															X		
Desactive (OFF) el modo CLOSED CAPTION / Desactive (OFF) el modo Ahorro de Energía (Energy Save).																X	
Desenchufe el televisor y vuelva a enchufarlo después de dos minutos.			X			X	X	X	X				X	X	X	X	X

NOTA:

- Cuando se ve en modo TEXTO sin recibir emisiones de TEXTO, la pantalla puede ponerse en blanco y negro. Si ocurriera ésto, ponga el modo CLOSED CAPTION en OFF.
- Si su televisor no funciona normalmente en caso de corte de energía eléctrica, desconecte una vez la alimentación y vuelva a conectarla a continuación.

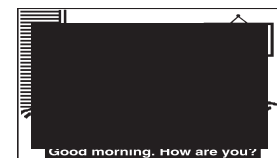

(Imagen oscura y en blanco)

Notes:

Notes:

Calling for Service

For location of the nearest Sharp Authorized Service, or to obtain product literature accessories, supplies, or customer assistance, please call 1-800-BE-SHARP.

Limited Warranty

Consumer Limited Warranty:

SHARP ELECTRONICS CORPORATION warrants to the first consumer purchaser that this Sharp brand product (the "Product"), when shipped in its original container, will be free from defective workmanship and materials, and agrees that it will, at its option, either repair the defect or replace the defective Product or part thereof with a new or remanufactured equivalent at no charge to the purchaser for parts or labor for the period(s) set forth below.

This warranty does not apply to any appearance items of the Product nor to the additional excluded item(s) set forth below nor to any Product the exterior of which has been damaged or defaced, which has been subjected to improper voltage or other misuse, abnormal service or handling, or which has been altered or modified in design or construction.

In order to enforce the rights under this limited warranty, the purchaser should follow the steps set forth below and provide proof of purchase to the servicer.

The limited warranty described herein is in addition to whatever implied warranties may be granted to purchasers by law. ALL IMPLIED WARRANTIES INCLUDING THE WARRANTIES OF MERCHANTABILITY AND FITNESS FOR USE ARE LIMITED TO THE PERIOD(S) FROM THE DATE OF PURCHASE SET FORTH BELOW. Some states do not allow limitations on how long an implied warranty lasts, so the above limitation may not apply to you.

Neither the sales personnel of the seller nor any other person is authorized to make any warranties other than those described herein, or to extend the duration of any warranties beyond the time period described herein on behalf of Sharp.

The warranties described herein shall be the sole and exclusive warranties granted by Sharp and shall be the sole and exclusive remedy available to the purchaser. Correction of defects, in the manner and for the period of time described herein, shall constitute complete fulfillment of all liabilities and responsibilities of Sharp to the purchaser with respect to the Product, and shall constitute full satisfaction of all claims, whether based on contract, negligence, strict liability or otherwise. In no event shall Sharp be liable or in any way responsible for any damages or defects in the Product which were caused by repairs or attempted repairs performed by anyone other than an authorized servicer. Nor shall Sharp be liable or in any way responsible for any incidental or consequential economic or property damage. Some states do not allow the exclusion of incidental or consequential damages, so that above exclusion may not apply to you.

THIS WARRANTY GIVES YOU SPECIFIC LEGAL RIGHTS. YOU MAY ALSO HAVE OTHER RIGHTS WHICH VARY FROM STATE TO STATE.

Model Specific Section

Your Product Model Number & Description

: 32N-S500, 32 inch Color Television
(Be sure to have this information available when you need service for your Product.)

Warranty Period for this Product

: One (1) year parts and 90 days labor for 25 inch models; one (1) year parts and one (1) year labor for 27, 32, and 36 inch models. The warranty period continues for an additional one (1) year, for a total of two (2) years, with respect to the picture tube(s) in the Product for parts only. Labor and service are not provided free of charge for this additional period.

Additional Item(s) Excluded from Warranty Coverage (if any) : Non-rechargeable batteries.

Where to Obtain Service

: From a Sharp Authorized Servicer located in the United States. To find the location of the nearest Sharp Authorized Servicer, call Sharp toll free at 1-800-BE-SHARP.

What to Do to Obtain Service

: Contact your Sharp Authorized Servicer to obtain in-home service for this Product. The Servicer will come to your home and if it is necessary to remove the Product, the Servicer will reinstall it. Be sure to have **Proof of Purchase** available.

TO OBTAIN ACCESSORY OR PRODUCT INFORMATION, CALL 1-800-BE-SHARP OR VISIT www.sharp-usa.com

SHARP
SHARP ELECTRONICS CORPORATION

Sharp Plaza, Mahwah, New Jersey 07430-2135

Printed in U.S.A.
TINS-7020MEZZ
T2418-A 0P06-AMP