

SHARP

COLOR TELEVISION

MODEL
20F630

OPERATION MANUAL

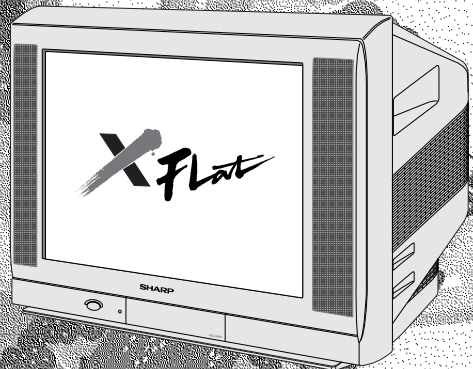

As an ENERGY STAR® Partner, SHARP has determined that this product meets the ENERGY STAR® guidelines for energy efficiency. ENERGY STAR® is a U.S. registered trademark.

CONTENTS

	PAGE		PAGE
• IMPORTANT INFORMATION/IMPORTANT SAFEGUARDS	2 ~ 10	• Closed Caption	24
• Supplied Accessories	11	• Parental Control	25 ~ 35
• Before Operating Your Television	11	V-CHIP	25 ~ 32
• Antenna Connections	11 ~ 12	View Timer	33 ~ 35
• Quick Reference Control Operation	13 ~ 15	• Ch Setup	36 ~ 41
• EZ SETUP during First Use	16	EZ Setup	36
• Demo Mode	17	Channel Setting	37 ~ 39
• Accessing the MAIN MENU screen without Remote Control	17	Personal Preference	40
• Language	18	Universal Plus Function	41
• Sleep Timer	19	• Set Up	42 ~ 43
• Video Adjust	20	Energy Save	42
• Audio Adjust	21	Blue Screen	43
• Audio Select	22 ~ 23	• Using the Video and Audio Input Jacks	44 ~ 45
MTS (Multichannel TV Sound)	22	• Using the Audio Output Jacks	46
INTERNAL SPEAKER SWITCH	22	• Operation of Remote Control	47 ~ 51
FAO (Fixed Audio Output)	22	• Before Calling for Service	52 ~ 53
		• Calling for Service	52 ~ 53
		• Specifications	54
		• Limited Warranty	56

This operating manual includes basic operating instructions in Spanish and French.
SPANISH is on page 5 ~ 7, 14, 53.
FRENCH is on page 8 ~ 10, 15, 54.

A725 WJ



Welcome to the SHARP Family. We are pleased that you are now the owner of a SHARP Color Television – built for outstanding quality, reliability and performance.

Every SHARP Color Television set is tuned and adjusted for proper color and sound, and has passed through the most stringent quality control tests at the factory. We have prepared this OPERATION MANUAL so that you may adjust the picture and color to your personal viewing preference.

We sincerely hope that you receive the greatest satisfaction and enjoyment from your new SHARP Color Television set for years to come.

Please read these instructions carefully, and keep them handy for your future reference.

IMPORTANT

To aid reporting in case of loss or theft, please record the TV's model and serial numbers in the space provided. The numbers are located at the rear of the TV.

Model No.:
Serial No.:

IMPORTANT INFORMATION

There are two important reasons for prompt warranty registration of your new SHARP television set. Use the REGISTRATION CARD packed in with the set.

FIRST – WARRANTY

This is to assure that you will immediately receive the full consumer benefit of the parts, service and labor warranty applicable to your purchase.

SECOND – CONSUMER PRODUCT SAFETY ACT

To assure that you will promptly receive any safety notification on inspection, modification or recall that SHARP may be required to give under the 1972 Consumer Product Safety Act. PLEASE READ CAREFULLY THE IMPORTANT "LIMITED WARRANTY" CLAUSE ON THE LAST PAGE.

WHAT IS ENERGY STAR®

TVs and VCRs use energy both when they are on and when they are off. Americans spend more than \$1 billion a year on energy consumed by TVs and VCRs when they are not in use. The new ENERGY STAR® models will reduce that energy "leakage" by up to 75 percent. Ultimately, this will mean more than \$500 million a year in energy savings for consumers.

The energy savings will help reduce the burning of fossil fuels and the related carbon dioxide pollution that contributes to global warming. If every American family replaced their TVs and VCRs with ENERGY STAR® models, it would reduce carbon dioxide emissions by five million tons every year — equivalent to eliminating the pollution from more than one million cars.

By using ENERGY STAR® products, you will save money on your electric bills and use less energy. That makes good economic sense and it's good for our environment.

WARNING: TO REDUCE THE RISK OF FIRE OR ELECTRIC SHOCK, DO NOT EXPOSE THIS APPLIANCE TO WET LOCATIONS.

<div style="display: inline-block; border: 1px solid black; padding: 5px; text-align: center; margin: 0 10px;"> CAUTION RISK OF ELECTRIC SHOCK DO NOT OPEN </div>
<p>CAUTION: TO REDUCE THE RISK OF ELECTRIC SHOCK, DO NOT REMOVE COVER (OR BACK). NO USER-SERVICEABLE PARTS INSIDE. REFER SERVICING TO QUALIFIED SERVICE PERSONNEL.</p>



The lightning flash with arrowhead within a triangle is intended to tell the user that parts inside the product are a risk of electric shock to persons.



The exclamation point within a triangle is intended to tell the user that important operating and servicing instructions are in the papers with the appliance.

"Note to CATV system installer: This reminder is provided to call the CATV system installer's attention to Article 820-40 of the National Electrical Code that provides guidelines for proper grounding and, in particular, specifies that the cable ground shall be connected to the grounding system of the building, as close to the point of cable entry as practical!"





IMPORTANT INFORMATION (Continued)

WARNING – FCC Regulations state that any unauthorized changes or modifications to this equipment not expressly approved by the manufacturer could void the user's authority to operate this equipment.

PRODUCT DISPOSAL

This product utilizes a Cathode Ray Tube (CRT) containing lead and tin lead solder. Disposal of these materials may be regulated due to environment considerations. For disposal or recycling information, please contact your local authorities or the Electronics Industries Alliance: www.eiae.org

CAUTION: Do not place the AC power cord under the TV set or other heavy items.

IMPORTANT SAFEGUARDS

CAUTION: Please read all of these instructions before you operate your television and save these instructions for later use.

Electrical energy can perform many useful functions. This unit has been engineered and manufactured to assure your personal safety. BUT IMPROPER USE CAN RESULT IN POTENTIAL ELECTRICAL SHOCK OR FIRE HAZARDS. In order not to defeat the safeguards incorporated in this equipment, observe the following basic rules for its installation, use and servicing.

1. Unplug this television equipment from the wall outlet before cleaning.
2. Do not use liquid cleaners or aerosol cleaners. Use a damp cloth for cleaning.
3. Do not use attachments not recommended by the television equipment manufacturer as they may cause hazards.
4. Do not use this television equipment near water — for example, near a bath tub, washbowl, kitchen sink or laundry tub, in a wet basement, or near a swimming pool, etc.
5. Do not place this equipment on an unstable cart, stand, or table. The television equipment may fall, causing serious injury to a child or an adult, and serious damage to the equipment.
Use only with a cart or stand recommended by the manufacturer or sold with the television equipment.
Television equipment and cart combination should be moved with care. Quick stops, excessive force, and uneven surfaces may cause the equipment and cart combination to overturn.
6. Wall or shelf mounting should follow the manufacturer's instructions, and should use a mounting kit approved by the manufacturer.
7. Slots and openings in the cabinet and the back or bottom are provided for ventilation, and to insure reliable operation of the television equipment and to protect it from overheating, these openings must not be blocked or covered. This television equipment should not be placed in a built-in insulation such as a bookcase unless proper ventilation is provided.
8. The openings should never be covered with a cloth or other material, and the bottom openings should not be blocked by placing the television equipment on a bed, sofa, rug, or other similar surface. This television equipment should never be placed near or over a radiator or heat register.
9. This television equipment should be operated only from the type of power source indicated on the marking label. If you are not sure of the type of power supplied to your home, consult your television dealer or local power company.
For television equipment designed to operate from battery power, refer to the operating instructions.
If the plug does not fit, ask your electrician to replace your obsolete outlet. Do not modify the plug and defeat this safety feature.
10. Do not allow anything to rest on the power cord. Do not locate this television equipment where the cord will be abused by persons walking on it.
11. As a safety feature, television equipment is equipped with a 2-wire polarized plug (one plug blade bigger than the other). The 2-wire polarized plug will fit only one way into the power outlet.
If the plug does not fit, ask your electrician to replace your obsolete outlet. Do not modify the plug and defeat this safety feature.





IMPORTANT INFORMATION (Continued)

12. Follow all warnings and instructions marked on the television equipment.
13. If an outside antenna is connected to the television equipment, be sure the antenna system is grounded so as to provide some protection against voltage surges and built-up static charges. Section 810 of the National Electrical Code provides information with respect to proper grounding of the mast and supporting structure, grounding of the lead-in wire to an antenna discharge unit, size of grounding conductors, location of antenna-discharge unit, connection to grounding electrodes, and requirements for the grounding electrode.

EXAMPLE OF ANTENNA GROUNDING ACCORDING TO NATIONAL ELECTRICAL CODE.

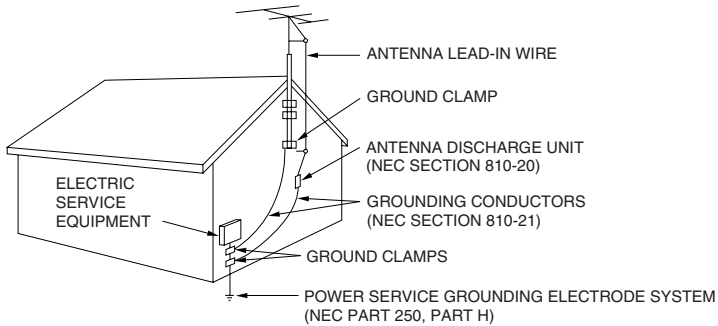

NEC - NATIONAL ELECTRICAL CODE

14. For added protection for this television equipment during a lightning storm, or when it is left unattended and unused for long periods of time, unplug it from the wall outlet and disconnect the antenna. This will prevent damage to the equipment due to lightning and power-line surges.
15. An outside antenna system should not be located in the vicinity of overhead power lines or other electric light or power circuits, or where it can fall into such power lines or circuits. When installing an outside antenna system, extreme care should be taken to keep from touching such power lines or circuits as contact with them might be fatal.
16. Do not overload wall outlets and extension cords as this can result in fire or electric shock.
17. Never push objects of any kind into this television equipment through cabinet slots as they may touch dangerous voltage points or short out parts that could result in a fire or electric shock. Never spill liquid of any kind on the television equipment.
18. Do not attempt to service this television equipment yourself as opening or removing covers may expose you to dangerous voltage or other hazards. Refer all servicing to qualified service personnel.
19. Unplug this television equipment from the wall outlet and refer servicing to qualified service personnel under the following conditions:
 - A. When the power cord or plug is damaged or frayed.
 - B. If liquid has been spilled into the television equipment.
 - C. If the television equipment has been exposed to rain or water.
 - D. If the television equipment does not operate normally by following the operating instructions. Adjust only those controls that are covered by the operating instructions as improper adjustment of other controls may result in damage and will often require extensive work by a qualified technician to restore the television equipment to normal operation.
 - E. If the television equipment has been dropped or the cabinet has been damaged.
 - F. When the television equipment exhibits a distinct change in performance — this indicates a need for service.
20. Upon completion of any service or repairs to this television equipment, ask the service technician to perform routine safety checks to determine that the television is in safe operating condition.
21. When replacement parts are required, be sure the service technician has used replacement parts specified by the manufacturer that have the same characteristics as the original part. Unauthorized substitutions may result in fire, electric shock, or other hazards.





(ESPAÑOL)

Lea estas instrucciones cuidadosamente y consérvelas a la mano para consultarlas en el futuro.

IMPORTANTE

Sírvase anotar el modelo del televisor y los números de serie en el espacio provisto, para ayudar a reportar en caso de pérdida o robo. Los números están ubicados en la parte posterior del televisor.

N° de modelo :

N° de serie :

INFORMACIÓN IMPORTANTE

Existen dos razones importantes para registrar dentro del plazo límite la garantía de su nuevo televisor SHARP, mediante la TARJETA DE REGISTRO incluida con el aparato.

PRIMERA – GARANTÍA

Garantiza al cliente la recepción inmediata de todas las prestaciones de consumidor en cuanto a piezas, servicio técnico y mano de obra aplicable a su adquisición.

SEGUNDA – ACTA DE SEGURIDAD DE PRODUCTOS DE CONSUMIDOR

Con el fin de garantizar al cliente la recepción puntual de cualquier notificación de seguridad sobre inspección, modificación o cancelación que se le pueda solicitar a SHARP bajo el Acta de seguridad de productos de consumidor de 1972. LEA CUIDADOSAMENTE LA CLÁUSULA “GARANTÍA LIMITADA” DE LA ÚLTIMA PÁGINA.

¿QUÉ ES ENERGY STAR® ?

Los televisores y las videograbadoras utilizan energía cuando están encendidos ó apagados. Los norteamericanos gastan más de 1 billón de dólares al año en la energía que consumen televisores y videograbadoras cuando no se encuentran en uso. Los nuevos modelos ENERGY STAR® reducen esa “fuga” de energía hasta en un 75 por ciento. Esto implica más de 500 millones de dólares al año en ahorro de energía para los consumidores.

El ahorro de energía ayuda a reducir el consumo de combustibles fósiles y por tanto la contaminación por dióxido de carbono que contribuye al calentamiento global. Si cada familia norteamericana sustituyera sus televisores y videograbadoras por modelos ENERGY STAR®, se reducirían las emisiones de dióxido de carbono en cinco millones de toneladas cada año (equivalente a eliminar la contaminación procedente de más de un millón de automóviles).

El uso de productos ENERGY STAR® permite reducir el monto de las facturas de energía eléctrica y consumir menos energía. De este modo ahorrará dinero y ayudará a proteger el medio ambiente.

ADVERTENCIA: PARA REDUCIR EL RIESGO DE INCENDIO O DESCARGA ELÉCTRICA, NO EXPONGA ESTE APARATO A LA HUMEDAD.



PRECAUCION

RIESGO DE ELECTRO-CHOQUE NO ABRA



PRECAUCIÓN : PARA REDUCIR EL RIESGO DE DESCARGAS ELÉCTRICAS, NO RETIRE LA CUBIERTA (NI EL PANEL POSTERIOR). NO CONTIENE PIEZAS REPARABLES POR EL USUARIO. SOLICITE ASISTENCIA TÉCNICA A PERSONAL DE SERVICIO TÉCNICO ESPECIALIZADO.



El relámpago con cabeza de flecha dentro de un triángulo trata de indicar al usuario que las partes dentro del producto representan riesgo de electrochoque para las personas.



El signo de exclamación dentro de un triángulo trata de indicar al usuario que las instrucciones importantes de operación y servicio se encuentran en los documentos con el aparato.

“Nota para el instalador del sistema de TV por cable: Esta nota tiene el propósito de llamar la atención del instalador del sistema de cable acerca del Artículo 820-40 del Código Eléctrico Nacional, que contiene las directrices para la puesta a tierra y, en particular, especifica que el cable de puesta a tierra debe estar conectado al sistema de puesta a tierra del edificio lo más cerca a la entrada del cable.”





INFORMACIÓN IMPORTANTE (Continuación)

ADVERTENCIA - Las Normas de la FCC establecen que cualquier cambio o modificación no autorizada que se realice en este equipo y que no esté expresamente aprobado por el fabricante podría anular la autoridad del usuario para utilizar este equipo.

DESECHO DEL PRODUCTO

Este producto utiliza un Tubo de rayos catódicos (TRC) que contiene soldadura de estaño y plomo. El desecho de estos materiales deberá ser considerando regulaciones ambientales. Para obtener información sobre el desecho o el reciclado, póngase en contacto con las autoridades locales o con Electronics Industries Alliance: www.eiae.org

PRECAUCIÓN: No coloque el cable de alimentación de CA debajo del televisor u otro elemento pesado.

MEDIDAS DE SEGURIDAD IMPORTANTES

PRECAUCIÓN: Lea por favor todas estas instrucciones antes de poner en funcionamiento su televisor, y guárdelas para poder utilizarlas en el futuro.

La energía eléctrica permite realizar muchas funciones útiles. Este aparato ha sido diseñado y fabricado para garantizar su seguridad física. Sin embargo, UNA UTILIZACIÓN INAPROPIADA PODRÍA SER LA CAUSA DE DESCARGAS ELÉCTRICAS O INCENDIOS. Para mantener el buen funcionamiento de este equipo y evitar problemas, siga las normas básicas indicadas a continuación cuando lo instale, utilice o repare.

1. Desenchufe el televisor del tomacorriente antes de limpiarlo.
2. No utilice líquidos ni aerosoles de limpieza. Para limpiar el televisor utilice un paño húmedo.
3. No utilice accesorios que no los recomiende el fabricante del televisor porque podrían causar peligros.
4. No utilice el televisor cerca del agua – por ejemplo, cerca de una bañera, lavado, fregadero o lavadora, en un sótano húmedo, cerca de una piscina, etc.
5. No utilice este televisor sobre un carrito, un soporte o una mesa inestables. El televisor podría caerse causando serias heridas a niños o adultos, y, por supuesto, el aparato se estropearía.
Ponga el televisor solamente sobre un carrito o soporte recomendado por el fabricante, o vendido junto con el televisor.
La combinación de carrito y televisor debe moverse con mucho cuidado. Las paradas rápidas, la fuerza excesiva y las superficies irregulares pueden ser la causa de que la combinación de televisor y carrito se volteen.
6. Cuando instale el televisor en una pared o en una estantería siga las instrucciones del fabricante, y utilice el kit de montaje aprobado por el fabricante.
7. Las ranuras y aberturas de la caja y del panel posterior o inferior sirven para la ventilación del aparato, para que éste funcione bien y para evitar que se caliente. Estas aberturas no deben taparse nunca. Este televisor no debe colocarse en un lugar cerrado (como un estante para libros) si éste no dispone de la ventilación apropiada.
8. Las aberturas no deben taparse nunca con un paño u otro material; y las aberturas del panel inferior no deben taparse tampoco colocando el televisor sobre una cama, sofá, alfombra u otra superficie similar. Este televisor no debe ponerse nunca cerca o encima de un radiador u otro aparato que produzca calor.
9. Este televisor sólo debe funcionar con la fuente de corriente indicada en la etiqueta del fabricante. Si no está seguro acerca del tipo de corriente de su hogar, póngase en contacto con el concesionario de quien adquirió el televisor o con la compañía eléctrica local.
En el caso de equipos de televisión diseñados para funcionar con baterías, consulte las instrucciones de uso. Si el enchufe no entra en el tomacorriente, pídale a un electricista que le coloque un tomacorriente nuevo. No modifique el enchufe porque anulará esta característica de seguridad.
10. No permita que se apoye nada sobre el cable de alimentación. No ponga este televisor donde el cable pueda ser deformado por personas que caminen sobre él.
11. Como medida de seguridad, el equipo de televisión está equipado con un enchufe polarizado de dos hilos. El enchufe polarizado de dos hilos solamente calza de una sola manera en el tomacorriente. Si el enchufe no entra en el tomacorriente, pídale a un electricista que le coloque un tomacorriente nuevo. No modifique el enchufe porque anulará esta característica de seguridad.





MEDIDAS DE SEGURIDAD IMPORTANTES (Continuación)

- Cumpla con todos los avisos y las instrucciones marcados en el televisor.
- Si hay una antena exterior conectada al televisor, asegúrese de que el sistema de antena está conectado a tierra, para obtener así cierta protección contra la sobretensión y contra las cargas de electricidad estática acumulada.

EJEMPLO DE CONEXIÓN A TIERRA DE UNA ANTENA SEGÚN CÓDIGO ELÉCTRICO NACIONAL.

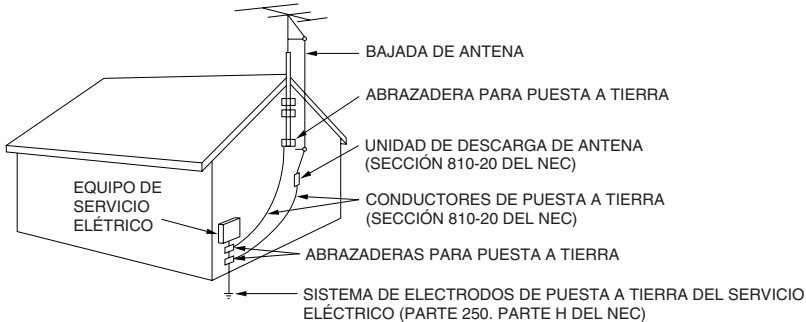

NEC - NATIONAL ELECTRICAL CODE (CÓDIGO ELÉCTRICO NACIONAL)

- Para proteger aún más este televisor durante tormentas eléctricas o cuando se deje sin atender y sin utilizar durante largos periodos de tiempo, desenchufe el cable de alimentación del tomacorriente y desconecte la antena. Esto evitará que el aparato pueda estropearse debido a los relámpagos y la sobretensión en la línea de alimentación.
- Un sistema de antena exterior no debe ubicarse cerca de líneas de alimentación elevadas, ni cerca de luces eléctricas o circuitos de alimentación. Tampoco debe ubicarse donde pueda caer sobre tales líneas o circuitos de alimentación. Cuando instale un sistema de antena exterior, tenga muchísimo cuidado para no tocar las líneas o circuitos de alimentación porque el contacto podría causar un accidente mortal.
- No sobrecargue los tomacorrientes ni los cables de extensión porque esto podría causar un incendio o descarga eléctrica.
- No meta nunca ningún objeto en el interior del televisor porque podría tocar piezas con alta tensión o causar un cortocircuito con otras piezas causando un incendio o descarga eléctrica. No derrame nunca ningún tipo de líquido sobre el televisor.
- No trate de reparar el televisor usted mismo porque al abrir o quitar las tapas podría exponerse a una descarga de tensión u otros peligros. Las reparaciones debe realizarlas el personal de servicio CALIFICADO.
- Desenchufe este televisor del tomacorriente y solicite el servicio de un técnico calificado cuando se produzcan las condiciones siguientes:
 - Cuando el cable de la alimentación o el enchufe estén estropeados.
 - Cuando haya derramado un líquido sobre el televisor.
 - Si el televisor ha quedado expuesto a la lluvia o al agua.
 - Si el televisor no funciona normalmente siguiendo las instrucciones de utilización. Ajuste solamente los controles indicados en las instrucciones de utilización. Un ajuste inadecuado de otros controles podría estropear el aparato y, entonces, sería necesario acudir a un técnico CALIFICADO para que éste lo repare y lo devuelva a su condición normal.
 - Si el televisor se ha caído o la caja se ha estropeado.
 - Cuando las prestaciones del televisor cambien considerablemente será necesario llamar al servicio de reparaciones.
- Al finalizar cualquier servicio o reparación de este televisor, pida al técnico de servicio que realice comprobaciones de seguridad rutinarias para determinar si el televisor puede funcionar sin causar ningún problema.
- Cuando sea necesario cambiar piezas, cerciórese de que el técnico de servicio utiliza las piezas de CAMBIO especificadas por el fabricante, aquellas que tengan las mismas características que las piezas originales. Las piezas de recambio no autorizadas pueden causar incendios, descargas eléctricas u otros peligros.





(FRANÇAIS)

Lisez attentivement ces instructions et gardez-les à proximité pour toute référence ultérieure.

IMPORTANT

Afin de vous aider en cas de perte ou de vol, inscrivez les numéros de série et de modèle du téléviseur dans les espaces fournis à cet effet. Ces numéros sont situés à l'arrière du téléviseur.

N° du modèle :

N° de série :

INFORMATIONS IMPORTANTES

Deux raisons importantes d'enregistrer rapidement la garantie de votre nouveau téléviseur SHARP à l'aide de la carte d'enregistrement (REGISTRATION CARD) incluse dans le colis :

LA PREMIERE – LA GARANTIE

Grâce à elle, vous obtiendrez immédiatement les avantages client concernant la garantie des pièces, du service et des travaux applicable à votre achat.

LA DEUXIEME – LA LOI SUR LA SECURITE DU PRODUIT DE CONSOMMATION (CONSUMER PRODUCT SAFETY ACT)

Grâce à elle, vous recevrez rapidement un avis de sécurité lors du contrôle, de la modification ou du rappel de votre produit que SHARP peut être amené à fournir conformément à la loi de 1972 sur la sécurité du produit de consommation. LISEZ ATTENTIVEMENT LE PARAGRAPHE «GARANTIE LIMITEE» DE LA DERNIERE PAGE.

ENERGY STAR® : QU'EST-CE QUE C'EST

Les téléviseurs et les magnétoscopes utilisent de l'énergie lorsqu'ils sont allumés et éteints. Les Américains dépensent plus d'1 milliard de dollars par an en énergie consommée par les téléviseurs et les magnétoscopes une fois éteints. Les nouveaux modèles ENERGY STAR® réduisent jusqu'à 75 % ce gaspillage d'énergie. Ce qui représente finalement plus de 500 millions de dollars par an d'économie d'énergie pour les consommateurs.

Ces économies aident à réduire la combustion des énergies fossiles et la pollution au gaz carbonique associée, qui contribue au réchauffement de la planète. Si toutes les familles américaines remplaçaient leurs téléviseurs et leurs magnétoscopes par des modèles ENERGY STAR®, les émissions de gaz carbonique seraient réduites de cinq millions de tonnes par an — ce qui reviendrait à éliminer la pollution émise par plus d'un million de voitures.

En utilisant les produits ENERGY STAR®, vous économiserez également de l'argent sur vos factures d'électricité et vous utiliserez moins d'énergie. Un peu de bon sens économique au profit de notre environnement !

AVERTISSEMENT: POUR REDUIRE LE RISQUE D'INCENDIE OU D'ELECTROCUTION, N'EXPOSEZ PAS CET EQUIPEMENT A DES ENDROITS TRES HUMIDES.



ATTENTION
RISQUE D'ELECTROCUTION
NE PAS OUVRIR



Le symbole de la foudre sous forme de flèche dans un triangle est supposé indiquer à l'utilisateur que les pièces internes au produit constituent un risque d'électrocution.

ATTENTION : POUR REDUIRE LE RISQUE D'ELECTROCUTION,
NE RETIREZ PAS LE CAPOT (OU LE PANNEAU ARRIERE).
L'APPAREIL NE CONTIENT AUCUNE PIECE A ENTREtenir PAR L'UTILISATEUR.
CONSULTEZ UN PERSONNEL QUALIFIE POUR LA MAINTENANCE.



Le symbole du point d'exclamation dans un triangle est supposé indiquer à l'utilisateur que des instructions de fonctionnement et de maintenance importantes se trouvent dans la documentation fournie avec l'équipement.

“Note à l'intention de l'installateur du système CATV : Ce rappel est fourni afin d'attirer l'attention de l'installateur de système CATV sur l'article 820-40 du National Electrical Code qui indique les règles de mise à la terre appropriée et, en particulier, spécifie que la ligne de terre doit être connectée au réseau commun de mise à la terre du bâtiment, au point le plus proche possible de la source.”





INFORMATIONS IMPORTANTES (Suite)

AVERTISSEMENT - Les réglementations FCC établissent que des changements ou des modifications non autorisés sur cet équipement et non approuvés expressément par le fabricant peuvent annuler tout pouvoir de l'utilisateur sur le fonctionnement de cet équipement.

MISE AU REBUT DU PRODUIT

Ce produit utilise un tube à rayons cathodiques (TRC) contenant du plomb à braser et du brasage tendre. La mise au rebut de ces matières peut être réglementée pour des raisons environnementales. Pour toute information sur la mise au rebut ou le recyclage, contactez les autorités locales ou les précautions importantes préconisées par la société Electronics Industries Alliance sur : www.eiaa.org.

ATTENTION: Ne placez pas le cordon d'alimentation sous le téléviseur ou sous tout autre objet lourd.

PRÉCAUTIONS IMPORTANTES

ATTENTION: Veuillez lire toutes ces instructions avant d'utiliser votre télévision et conservez-les pour un usage ultérieur.

L'énergie électrique peut exécuter de nombreuses fonctions utiles. Cet appareil a été conçu et fabriqué de façon à garantir votre entière sécurité. CÉPENDANT, TOUTE UTILISATION INADEQUATE PEUT ENTRAINER DES RISQUES D'ELECTROCUTION OU D'INCENDIE. Afin de ne pas détruire les protections intégrées à cet appareil, respectez les règles de base suivantes pour son installation, son utilisation et sa maintenance.

1. Débranchez la télévision avant de la nettoyer.
2. N'utilisez pas de nettoyeurs liquides ou d'aérosols et utilisez un chiffon humide.
3. N'utilisez pas d'accessoires déconseillés par le fabricant de matériel vidéo, car ils impliquent des risques.
4. N'utilisez pas cette télévision à proximité d'eau — par exemple, près d'une baignoire, d'un lavabo, d'un évier ou d'un bac à laver, dans une cave humide ou près d'une piscine, etc.

5. Ne placez pas cet équipement sur un chariot, un support ou une table instable. La télévision peut tomber et provoquer de graves lésions à toute personne et causer de sérieux dommages à l'équipement.

Utilisez uniquement un support ou un chariot recommandé par le fabricant ou vendu avec la télévision.

L'ensemble télévision-chariot doit être déplacé délicatement. Les arrêts brusques, une force excessive et des surfaces inégales peuvent renverser l'ensemble.



6. L'installation au mur ou sur une tablette doit être réalisée conformément aux instructions du fabricant et à l'aide d'un kit de montage approuvé par ce dernier.
7. Les fentes et les ouvertures du châssis à l'arrière ou dans la partie inférieure sont prévus pour la ventilation. Pour garantir un fonctionnement fiable de la télévision et pour la protéger de toute surchauffe, ces ouvertures ne doivent être ni obturées, ni recouvertes. La télévision ne doit pas être placée dans un endroit encastré tel qu'une bibliothèque, sauf si une ventilation adéquate est prévue.
8. Les ouvertures ne doivent jamais être recouvertes par un chiffon ou autre et celles de la partie inférieure ne doivent jamais être obturées si vous placez la télévision sur un lit, un sofa, un tapis ou toute surface similaire. Cette télévision ne doit être placée ni à proximité d'un radiateur ou d'un registre de chaleur, ni dessus.
9. Cette télévision doit être alimentée uniquement par le type d'alimentation électrique indiqué sur l'étiquette. Si vous n'êtes pas sûr du type d'alimentation de votre domicile, consultez votre revendeur de télévision ou la compagnie d'électricité locale (EDF en France).
Pour la télévision conçue pour fonctionner sur batterie, reportez-vous au mode d'emploi.
Si la fiche ne correspond pas à la prise, demandez à votre électricien de remplacer la prise, elle doit être obsolète. Ne modifiez pas la fiche et ne désactivez pas cette fonction de sécurité.
10. Ne posez rien sur le cordon d'alimentation. Ne placez pas la télévision dans un emplacement où le cordon d'alimentation est susceptible d'être endommagé par le passage répété de personnes.
11. Du point de vue de la sécurité, la télévision est équipée d'une fiche polarisée à 2 fils (une lame plus importante que l'autre). La fiche polarisée à 2 fils ne pénètre dans la prise électrique que dans un seul sens.
Si la fiche ne correspond pas à la prise, demandez à votre électricien de remplacer la prise, elle doit être obsolète. Ne modifiez pas la fiche et ne désactivez pas cette fonction de sécurité.



PRÉCAUTIONS IMPORTANTES (Suite)

12. Respectez tous les avertissements et instructions mentionnés sur la télévision.
13. Si une antenne extérieure est raccordée à la télévision, veillez à ce que le système d'antenne soit relié à la terre de façon à fournir une protection vis-à-vis des poussées de tension et des charges électrostatiques accumulées. La section 810 du National Electrical Code fournit des informations relatives à une mise à la terre correcte de la potence et de la structure portante, à une mise à la terre du fil d'entrée à une unité de décharge d'antenne, aux dimensions des conducteurs de terre, à l'emplacement de l'unité de décharge d'antenne, au raccordement des prises de terre ainsi qu'à leurs exigences.

EXEMPLE DE MISE A LA TERRE D'ANTENNE CONFORME AU NATIONAL ELECTRICAL CODE.

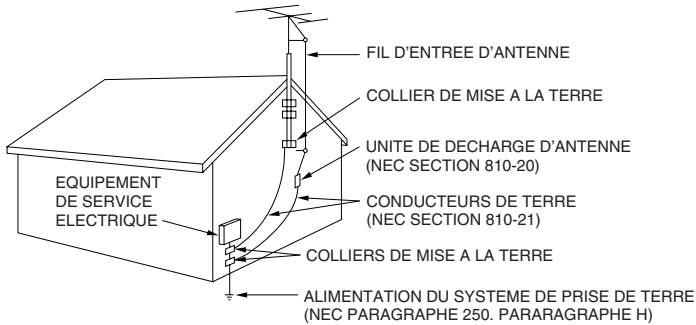

NEC - NATIONAL ELECTRICAL CODE

14. Pour tout ajout de protection à votre télévision en cas de foudre ou lorsque elle reste en veille et inutilisée pendant de longues périodes, débranchez-la et déconnectez l'antenne. Vous éviterez ainsi des dommages à votre équipement suite à la foudre et des poussées de tension.
15. Un système d'antenne extérieure ne doit pas être situé à proximité de lignes aériennes ou d'autres groupes électrogènes ou circuits électriques ou dans des emplacements où l'antenne pourrait tomber sur ce type de lignes ou circuits. Lors de l'installation d'un système d'antenne extérieure, faites extrêmement attention à ne pas entrer en contact avec ces lignes ou circuits, car cela pourrait vous être fatal.
16. Ne surchargez pas les prises et les prolongateurs de ligne afin d'éviter tout risque d'incendie ou d'électrocution.
17. N'introduisez jamais d'objets à travers les fentes du châssis, car ils pourraient entrer en contact avec des points de tension dangereux ou des pièces court-circuitées et provoquer ainsi un incendie ou une électrocution. Ne répandez jamais de liquides sur la télévision.
18. N'essayez pas de réparer vous-même votre télévision. L'ouverture ou le retrait des capots peut vous exposer à une tension dangereuse ou à d'autres risques. Confiez toutes les opérations de maintenance à un personnel qualifié.
19. Lorsque vous êtes confronté aux situations suivantes, débranchez la télévision et confiez toutes les opérations de maintenance à un personnel qualifié :
 - A. Lorsque le cordon d'alimentation ou la fiche est endommagé ou effiloché ;
 - B. Si du liquide a été répandu sur/dans la télévision ;
 - C. Si la télévision a été exposée à la pluie ou à l'eau ;
 - D. Si la télévision ne fonctionne pas normalement même en respectant le mode d'emploi. Réglez uniquement les commandes abordées par le mode d'emploi. Des réglages inappropriés d'autres commandes peuvent occasionner des dommages et nécessiteront ensuite, dans la plupart des cas, une intervention plus importante d'un technicien qualifié pour que la télévision fonctionne normalement ;
 - E. Si la télévision a été renversée ou que le châssis est endommagé ;
 - F. Lorsque la télévision présente une altération visible des performances — cela indique un besoin de maintenance.
20. Pour toute maintenance ou réparation de la télévision, demandez au technicien de réaliser des contrôles de sécurité classiques afin de déterminer si la télévision est en bon état de marche.
21. Lorsqu'un remplacement de pièces se révèle nécessaire, veillez à ce que le technicien utilise des pièces de rechange spécifiées par le fabricant et qu'elles aient les mêmes caractéristiques que la pièce d'origine. Des remplacements non autorisés peuvent occasionner un incendie, une électrocution ou d'autres risques.

10





Supplied Accessories

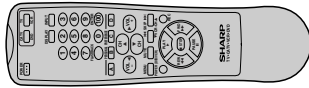

Infrared Remote Control/Part Number
RRMCGA108WJSA

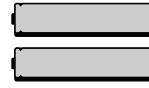

Dry batteries size "AA"/
1.5 V cc

Before Operating Your Television

Location

- For normal operation, your TV should be located in an area of the room where cool adequate ventilation is provided. Do not place the back of the television set in a place where free airflow will be restricted.
- Any magnetic force may disturb the color picture. Make sure that magnets, electric clocks, toys using magnets or any other magnetic substance, such as iron are kept well away from the TV set.

Power

Your TV operates on 120 Volts, 60 Hz (normal household current) and has a polarized plug. If you are unable to insert the plug fully into the outlet, try reversing the plug. Should it fail to fit, contact an electrician. Do not defeat the safety feature of the polarized plug.

Note:

- If the set will not be used for a long period, such as during a vacation, unplug the set from the wall outlet to economize power. (If the TV set is plugged in, a slight current still flows, even with the POWER BUTTON in the OFF position.)
- Lines and other noise may appear in TV broadcast images when an FM tuner or radio is located near the TV and both radio and TV broadcasts are being received. Should such noise appear, turn off either the TV or the radio.
- If you are listening to an AM broadcast, turn the TV off. AM broadcast signals may not be received due to interference from the TV.

■ Before using the television, prepare the Remote Control

To use the remote control, insert batteries first.

Insert the batteries

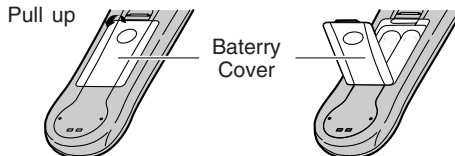

- With your thumbnail, pull up the slit as indicated by the arrow to remove the back cover. Insert two batteries (size "AA"/1.5 V cc). Be sure to match the battery \oplus/\ominus terminals with the \oplus/\ominus marks inside the compartment.

Antenna Connections

Antennas

- The antenna requirements for good color television reception are more important than those for black & white television reception. For this reason, a good quality outdoor antenna is strongly recommended. The following is a brief explanation of the type of connections that are provided with the various antenna systems:

1. A 75 ohm system is generally a round cable with F-type connector that can easily be attached to a terminal without tools (not supplied).
2. A 300 ohm system is a flat "twin-lead" cable that can be attached to a 75 ohm terminal through a 300-75 ohm ADAPTOR (not supplied).

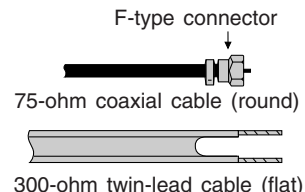



Antenna Connections (Continued)

OUTDOOR ANTENNA CONNECTION

- Use one of the following two diagrams if you connect an outdoor antenna.
 - A: Using a VHF/UHF combination outdoor antenna.
 - B: Using separate VHF and/or UHF outdoor antenna.
- Connect an outdoor antenna cable lead-in to the COAXIAL CABLE CONNECTOR on the rear of the TV set.

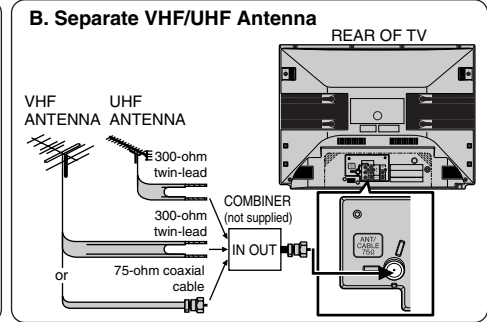
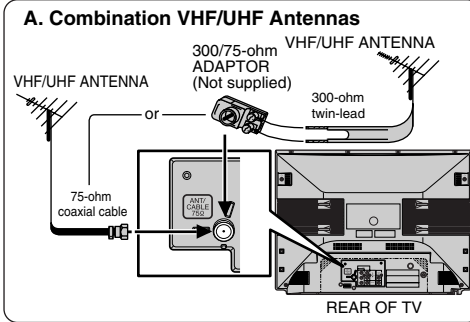

NOTICE

F-type connector

F-type connector should be finger tightened only

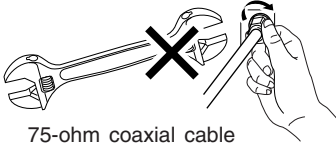

75-ohm coaxial cable

When connecting the RF cable to the TV set, do not tighten F-type connector with tools.

If tools are used, it may cause damage to your TV set. (The breaking of Internal circuit, etc.)

CABLE TV (CATV) CONNECTION

- A 75 ohm coaxial cable connector is built into the set for easy hookup. When connecting the 75 ohm coaxial cable to the set, screw the 75 ohm cable to the COAXIAL CABLE CONNECTOR.
- Some cable TV companies offer "premium pay channels". Since the signals of these premium pay channels are scrambled, a cable TV converter/descrambler is generally provided to the subscriber by the cable TV company. This converter/descrambler is necessary for normal viewing of the scrambled channels. (Set your TV on channel 3 or 4. Typically one of these channels is used. If this is unknown, consult your cable TV company.) For more specific instructions on installing cable TV, consult your cable TV company. One possible method of utilizing the converter/descrambler provided by your cable TV company is explained below.

Please note: RF switch equipped with position A/B (not provided) is required.

"A" position on the RF switch (not supplied): You can view all unscrambled channels using the TV's channel keys.

"B" position on the RF switch (not supplied): You can view the scrambled channels via the converter/descrambler using the converter's channel keys.

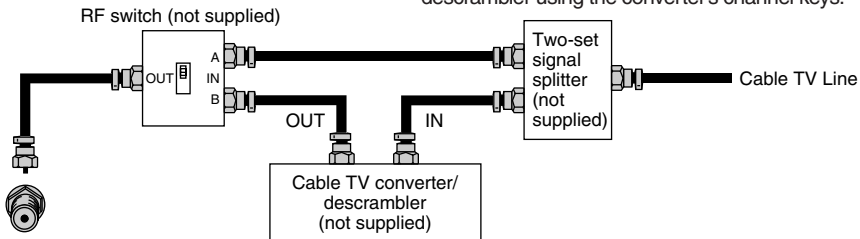

Note:

- Consult your SHARP Dealer or Service Center for the type of splitter, RF switch or combiner that might be required.



Quick Reference Control Operation

Location of Controls

(ENGLISH)

Front Panel

POWER

Press → On.
Press again → Off.

SENSOR AREA FOR REMOTE CONTROL

MENU

Press → Accesses MAIN MENU.
Press again → Exits MAIN MENU.

VOLUME UP/DOWN

(+) Increases sound.
(-) Decreases sound.

VIDEO IN 2 L-AUDIO-R

(INSIDE DOOR)

CHANNEL UP/DOWN

(▲) Selects next higher channel.
(▼) Selects next lower channel.

Basic Remote Control Functions

POWER

Press → On.
Press again → Off.

REMOTE KEYPAD

Accesses any channel from keypad.

FLASHBACK

Returns to previous channel.

PERSONAL PREFERENCE

With the Personal Preference buttons, you can program your favorite programs by using the 4 categories A, B, C and D. The channels can be accessed quickly by using these buttons. (See page 40.)

VOLUME UP/DOWN

(+) Increases sound.
(-) Decreases sound.
• In menu mode, changes or selects the TV adjustments.

MENU

Press → Accesses MAIN MENU.
Press again → Exits MAIN MENU.

MUTE

Press → Mutes sound.
Press again → Restores sound.
• CLOSED CAPTION appears when sound is muted.

POWER (DVD/VCR)

Press → On.
Press again → Off.

DVD/VCR CONTROL

See page 47.

REC

Infrared Transmitter Window

CATV/DVD-TV/VCR MODE buttons

Press TV/VCR, sends power and channel select commands (Channel up/down and Random Access buttons) to the TV and VCR control.
Press CATV/DVD, sends power and channel select commands to a cable TV converter and DVD control.

DISPLAY

Press → Displays receiving channel for four seconds.
Press 2 times → Removes display.
• Temporarily displays receiving channel when in Closed Caption mode.

INPUT

Press → Switch to external video INPUT 1 mode or COMPONENT mode.
Press 2 times → Switch to external video INPUT 2 mode.
Press 3 times → Switch back to the original TV mode. See page 45.

ENTER

Used in some instances where a Cable Converter Box requires an "enter" command after selecting channels, when using the **REMOTE KEYPAD** button. (See page 47)

CHANNEL UP/DOWN

(▲) Selects next higher channel.
(▼) Selects next lower channel.
• See pages 37 ~ 39 for channel presetting.
• Moves the "●" mark of the MENU screens.

SKIP/VCR-CH

Note:

- The above shaded buttons on the Remote Control glow in the dark. To use the glow-in-the-dark display on the remote control, place it under a fluorescent light or other lighting.
- The phosphorescent material contains no radioactive or toxic material, so it is safe to use.
- The degree of illumination will vary depending on the strength of lighting used.
- The degree of illumination will decrease with time and depending on the temperature.
- The time needed to charge the phosphorescent display will vary depending on the surrounding lighting.
- Sunlight and fluorescent lighting are the most effective when charging the display.

Referencia rápida de los controles de operación

Ubicación de los controles

(ESPAÑOL)

Panel Delantero

ALIMENTACION (POWER)

Pulsando → Enciende (On).
Pulsando nuevamente → Apaga (Off).

ZONA DEL SENSOR DEL MANDO A DISTANCIA

MENU (MENU)

Pulsando → Accede al MENU PRINCIPAL.
Pulsando nuevamente → Sale del MENU PRINCIPAL.

AUMENTO/DISMINUCION DEL VOLUMEN (VOL)

(+) Aumenta el sonido.
(-) Disminuye el sonido.

ENTRADA VIDEO I-AUDIO-D **IN 2**

(POR DENTRO DE LA PUERTA)

CANAL SUPERIOR/INFERIOR (CH) – MENU

(▲) Selecciona el siguiente canal superior.
(▼) Selecciona el siguiente canal inferior.

Funciones Basicas Del Control Remoto

ALIMENTACION (POWER)

Pulsando → Enciende (On).
Pulsando nuevamente → Apaga (Off).

TECLADO A DISTANCIA (REMOTE KEYPAD)

Para tener acceso a cualquier canal empleando las teclas.

RETORNO AL CANAL ANTERIOR (FLASHBACK)

Para volver al canal anterior.

PREFERENCIAS PERSONALES

Con los botones Personal Preference puede programar sus programas favoritos utilizando las cuatro categorías A, B, C y D. Puede acceder a los canales rápidamente utilizando estos botones. (Consulte la página 40)

AUMENTO/DISMINUCION DEL VOLUMEN (VOLUME UP/DOWN)

(+) Aumenta el sonido.
(-) Disminuye el sonido.
• En modo de MENU cambia o selecciona el ajuste del televisor.

PREPARACION (MENU)

Pulsando → Accede al MENU PRINCIPAL.
Pulsando nuevamente → Sale del MENU PRINCIPAL.

SILENCIAMIENTO (MUTE)

Pulsando → Silencia el sonido.
Pulsando nuevamente → Restaura el sonido.
• CLOSED CAPTION aparece automáticamente cuando el sonido es silenciado.
Siempre y cuando la transmisión tenga esta señal.

ALIMENTACION (DVD/VCR)

[POWER (DVD/VCR)]
Pulsando → Enciende (On).
Pulsando nuevamente → Apaga (Off).

CONTROLES DEL DVD/VIDEO

Consulte la página 47.

Ventanilla del transmisor de infrarrojos

Botones DE TELEVISOR/TV POR CABLE (TV-CATV)

Pulse TV/VCR, el mando envía los comandos de alimentación y selección de canales (botones de canal superior/inferior y de acceso aleatorio) a un televisor.

Pulse CATV/DVD, envía los comandos de alimentación y selección de canales a un convertidor de TV por cable.

VISUALIZACION (DISPLAY)

Pulsando → Aparece el canal de recepción por cuatro segundos.
Pulsando nuevamente → Elimina la visualización.

• En el modo de "Closed Caption" se muestra el canal de recepción por un corto tiempo.

ENTRADA (INPUT)

Pulsando → Cambia al modo de entrada 1 del video externo o al modo.
Pulsando 2 veces → Cambia al modo de entrada 2 del video externo.
Pulsando 3 veces → Vuelve al modo TV original. Consulte la página 45.

INTRODUCIR (ENTER)

Se utiliza en algunos casos en los cuales una Caja de Inversor de Cable requiere una orden "enter" después de seleccionar los canales, al usar el teclado a distancia. (Consulte la página 47)

CANAL SUPERIOR/INFERIOR (CHANNEL UP/DOWN)

(▲) Selecciona el siguiente canal superior.
(▼) Selecciona el siguiente canal inferior.
• Consulte las páginas 37 – 39 para obtener información sobre el preajuste de canales.
• En el modo de MENU, mueve la marca "●".

SKIP/VCR-CH

REC

Nota:

- Los botones que arriba pueden verse sombreados en el Control Remoto lucen en la oscuridad. Para usar el visor del control remoto que luce en la oscuridad, colocarlo bajo una luz fluorescente u otra fuente luminosa.
- El material fosforescente no contiene elementos radiactivos ni tóxicos, de modo que su uso no representa ningún peligro.
- El grado de iluminación variará de acuerdo con la potencia de la luz utilizada.
- El grado de iluminación irá decayendo con el tiempo y dependiendo de la temperatura.
- El tiempo necesario para cargar el visor fosforescente variará de acuerdo con la iluminación circundante.
- La luz del sol y la luz fluorescente son las más eficaces para la carga del visor.

Référence rapide sur les commandes

■ Emplacement des touches

(FRANÇAIS)

Panneau Avant

ALIMENTATION (POWER)

Appuyer → Pour mettre sous tension.
Appuyer de nouveau → Pour mettre hors tension.

ZONE DE DETECTION DU CAPTEUR

RÉGLAGE (MENU)

Appuyer → Accès au MENU PRINCIPAL.

Appuyer de nouveau → Sortie du MENU PRINCIPAL.

AUGMENTATION/RÉDUCTION DU VOLUME SONORE (VOL)

(+) Pour augmenter le volume du son.
(-) Pour diminuer le volume du son.

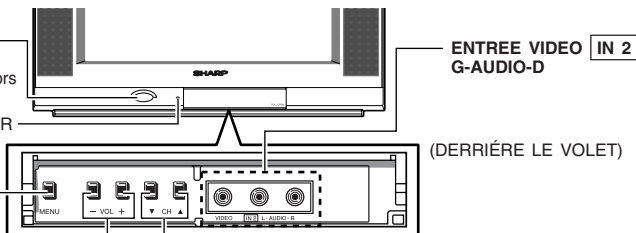

TOUCHES DES CANAUX CROISSANT/ DÉCROISSANT (CH) – MENU

(▲) Sélectionne le canal supérieur suivant.
(▼) Sélectionne le canal inférieur précédent.

Fonctions de base de la télécommande

ALIMENTATION (POWER)

Appuyer → Pour mettre sous tension.
Appuyer de nouveau → Pour mettre hors tension.

PAVE NUMERIQUE DE COMMANDE A DISTANCE (REMOTE KEYPAD)

Sélectionne directement le canal voulu sur le pavé numérique.

RETOUR (FLASHBACK)

Rappelle le canal regardé précédent.

PREFERENCES PERSONNELLES

Grâce aux touches de préférence personnelle, vous pouvez programmer vos programmes préférés à l'aide des 4 catégories: A, B, C et D. Ces touches vous permettent d'accéder rapidement à ces canaux. (Voir page 40)

AUGMENTATION/RÉDUCTION DU VOLUME SONORE (VOLUME UP/DOWN)

(+) Pour augmenter le volume du son.
(-) Pour diminuer le volume du son.

- Pour changer ou sélectionner les réglages du téléviseur en mode menu.

RÉGLAGE (MENU)

Appuyer → Accès au MENU PRINCIPAL.
Appuyer de nouveau → Sortie du MENU PRINCIPAL.

SOURDINE (MUTE)

Appuyer → Mise en sourdine du son.
Appuyer de nouveau → Rétablissement du son.

- CLOSED CAPTION apparaît lorsque le son est mis en sourdine.

ALIMENTATION (DVD/VCR) [POWER (DVD/VCR)]

Appuyer → Pour mettre sous tension.
Appuyer de nouveau → Pour mettre hors tension.

COMMANDE DU LECTEUR DE DVD/ MAGNÉTOSCOPE

Voir page 47.

REC

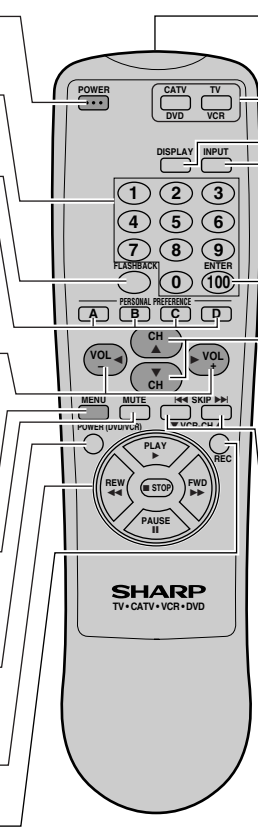

Fenêtre d'émission du signal infrarouge

Touches DE MODE DE CÂBLOVISION/ DVD-TÉLÉVISION/MAGNÉTOSCOPE (CATV/DVD-TV/VCR)

Appuyer sur la touche télévision/ magnétoscope (TV/VCR), permet de mettre le téléviseur et le magnétoscope sous/hors tension et de sélectionner ses canaux (touche de canaux en ordre croissant/décroissant et d'accès direct).

Appuyer sur la touche câblovision/DVD (CATV/DVD), permet de mettre un convertisseur de téléviseur par câble et un lecteur de DVD sous/hors tension et de sélectionner ses canaux.

AFFICHAGE (DISPLAY)

Appuyer → Pour afficher le canal reçu pendant quatre secondes.
Appuyer de nouveau → Pour faire disparaître le canal.

- Pour afficher temporairement le canal reçu en mode Sous-titres.

ENTRÉE (INPUT)

Appuyer → Pour sélectionner le mode ENTRÉE 1 vidéo externe ou le mode COMPOSANT.

Appuyer 2 fois → Pour sélectionner le mode ENTRÉE 2 vidéo externe.
Appuyer 3 fois → Pour revenir au mode TV initial. Voir page 45.

ENTRER (ENTER)

Parfois utilisée lorsqu'un convertisseur nécessite l'introduction d'une commande "enter" après la sélection de canaux à l'aide du pavé numérique de commande à distance. (Voir page 47)

TOUCHES DES CANAUX CROISSANT/ DÉCROISSANT (CHANNEL UP/DOWN)

(▲) Sélectionne le canal supérieur suivant.
(▼) Sélectionne le canal inférieur précédent.

- Voir pages 37 - 39 pour pré-régler les canaux.
- Déplace le curseur "●" sur l'écran du MENU.

SKIP/VCR-CH

Remarque:

- Les boutons ombrés de la télécommande illustrés ci-dessus brillent dans l'obscurité lorsque la télécommande a été placée sous une ampoule fluorescente ou toute autre source lumineuse.
- Le matériau phosphorescent n'est absolument pas toxique ou radioactif. Il peut donc être utilisé en toute sécurité.
- Le degré d'illumination variera en fonction de l'intensité de la source d'éclairage.
- Le degré d'illumination diminuera avec le temps, en fonction de la température.
- Les temps requis pour charger les touches phosphorescentes dépendra de l'éclairage environnant.
- Les rayons directs du soleil et les luminaires fluorescents constituent les meilleures sources de chargement des touches phosphorescentes.



EZ SETUP during First Use

- When you turn on the TV for the first time, it will automatically memorize the broadcast channels.

Please perform the following instructions before pressing the **POWER** button.

- Insert the batteries into the remote control. (See page 11)
- Connect the antenna cable to the TV set. (See page 11 ~ 12)
- Plug in the AC POWER cord to the wall outlet.

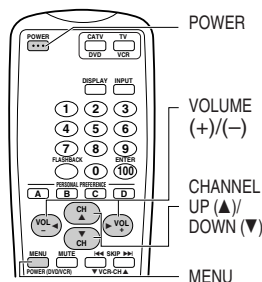

- Press **POWER** on the TV set or on the Remote Control to turn on the TV. The SELECT LANGUAGE mode will be displayed.

(On the Set)



(Remote Control)



SELECT LANGUAGE

● ENGLISH
ESPAÑOL
FRANCAIS

SELECT: CH ▲/▼
SET : VOL +/-

(SELECT LANGUAGE mode)

- Press **CH UP (▲)** or **DOWN (▼)** to select "ENGLISH", "SPANISH (ESPAÑOL)" or "FRENCH (FRANCAIS)".



SELECT LANGUAGE

● ENGLISH
ESPAÑOL
FRANCAIS

SELECT: CH ▲/▼
SET : VOL +/-

- Press **VOL (+)** or **(-)** to SET LANGUAGE and access EZ SETUP mode.



CONNECT ANTENNA OR
CABLE

START EZ SETUP?

● STOP START

(EZ SETUP mode)

- Press **VOL (+)**.
The tuner will automatically search for the broadcast and cable TV channels. (The CH No. will automatically increase when it appears.)

If you want to stop the EZ SETUP process once it has started, press **VOL (-)** and it will be canceled.

If you want to SETUP again, please refer to page 36 on CH SETUP.

To cancel EZ SETUP

Press **VOL (-)**.



PLEASE WAIT

AUTO PROGRAMMING

125

STOP ● START

- Once EZ SETUP is completed, the lowest channel number memorized will be displayed.

2

Note:

- If EZ SETUP does not memorize all the channels in your region, please refer to page 37 for more information on manually memorizing the channels using CHANNEL SETTING.
- It may be difficult to PRESET when the broadcast signals are weak, the channel cycle frequency is incorrect or frequency jamming is occurring around the area. Please refer to pages 37 ~ 39 for more information on manually memorizing the channels using CHANNEL SETTING.





Demo Mode

- To quickly learn more about the TV set, press and hold for more than three seconds both **CH UP (▲)** and **DOWN (▼)** or **MENU** on the TV set. The TV set will go into DEMO mode and briefly explain the various features.
- To cancel DEMO mode, again press and hold for more than three seconds both **CH UP (▲)** and **DOWN (▼)** or **MENU** on the TV set.

Example:

DEMO mode display



Note:

- Without signal on COMPONENT IN, video input and antenna in, the DEMO mode cannot be activated.

Accessing the MAIN MENU screen without Remote Control

- If you misplaced your Remote Control you can still access most settings via the MAIN MENU screen when you press **MENU** on the TV set.
- Some features of your TV set will not be accessible without the Remote Control. If you lost your Remote Control, contact a Sharp Service Center for a replacement.

(On the Set)

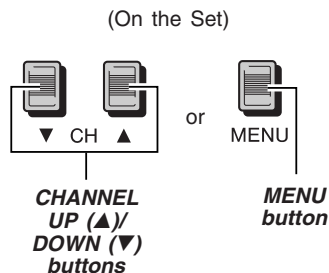



Language

- The language for the ON SCREEN DISPLAY can be set to ENGLISH, SPANISH or FRENCH.
- Setting the ON SCREEN DISPLAY Language.

1 Press **MENU** to access the MAIN MENU screen.



MENU
 ● SLEEP TIMER
 VIDEO ADJUST
 AUDIO ADJUST
 AUDIO SELECT
 CLOSED CAPTION
 PARENTAL CONTROL
 CH SETUP
 SETUP

(MAIN MENU screen)

2 Press **CH UP (▲)** or **DOWN (▼)** to move the “●” mark to “SETUP”.



MENU
 SLEEP TIMER
 VIDEO ADJUST
 AUDIO ADJUST
 AUDIO SELECT
 CLOSED CAPTION
 PARENTAL CONTROL
 CH SETUP
 ● SETUP

3 Press **VOL (+)** or **(-)** to access SETUP mode.



SETUP
 ● LANGUAGE
 ENERGY SAVE
 BLUE SCREEN

(SETUP mode)

4 Press **VOL (+)** or **(-)** to access LANGUAGE change mode.



LANGUAGE
 ● ENGLISH
 ESPAÑOL
 FRANCAIS

(LANGUAGE change mode)

5 Press **CH UP (▲)** or **DOWN (▼)** to select “ENGLISH”, “SPANISH (ESPAÑOL)” or “FRENCH (FRANCAIS)”.



IDIOMA
 † ENGLISH
 ● ESPAÑOL
 † FRANCAIS

6 Press **MENU** to exit.





Sleep Timer

- You can preset your television to turn off automatically in increments of 30, 60, 90 or 120 minutes.

1 Press **MENU** to access the MAIN MENU screen.

2 Press **VOL (+)** or **(-)** to access SLEEP TIMER mode.



MENU
 ● SLEEP TIMER
 VIDEO ADJUST
 AUDIO ADJUST
 AUDIO SELECT
 CLOSED CAPTION
 PARENTAL CONTROL
 CH SETUP
 SETUP

(MAIN MENU screen)

3 Press **VOL (+)** or **(-)** to set a sleep time of 30, 60, 90 or 120 minutes.



SLEEP TIMER
 120M REMAIN

(SLEEP TIMER mode)

4 Press **MENU** to exit.



Note:

- To turn off the SLEEP TIMER, repeat the above SLEEP TIMER steps and select “-- M REMAIN” during step 3.
- While SLEEP TIMER is active, the time remaining will be briefly displayed on-screen at regular intervals or when the remote’s **DISPLAY** key is pressed.





Audio Adjust

Selected item	VOL UP (+) button	VOL DOWN (-) button
TREBLE	To increase treble response	To decrease treble response
BASS	To increase bass response	To decrease bass response
BALANCE	To emphasize the right speaker's volume	To emphasize the left speaker's volume
RESET	To return all adjustments to factory preset levels.	

- 1 Press **MENU** to access the MAIN MENU screen.
- 2 Press **CH UP (▲)** or **DOWN (▼)** to move the "●" mark to "AUDIO ADJUST".

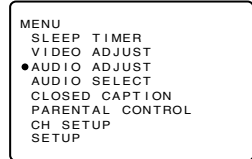
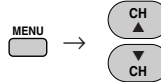

(MAIN MENU screen)

- 3 Press **VOL (+)** or **(-)** to access TREBLE adjust mode.

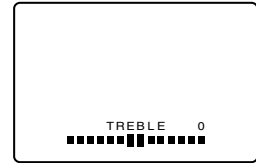

(TREBLE adjust mode)

- 4 Press **CH UP (▲)** or **DOWN (▼)** to select the desired mode.
(Refer to the diagram below.)

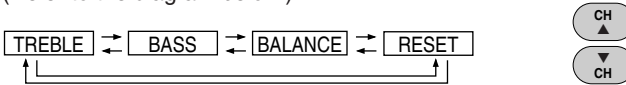

- 5 Press **VOL (+)** or **(-)** to adjust the setting.

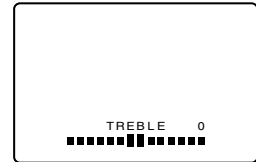

- 6 Repeat steps 4 to 5 to adjust other settings.

- 7 Press **MENU** to exit.





Audio Select

- **MTS (Multichannel TV Sound)**
This circuit allows reception of stereo or bilingual TV sound.
- **INTERNAL SPEAKER SWITCH**
This function turns the TV's internal speakers "ON" or "OFF" when listening to sound from external speakers by using the AUDIO OUTPUT JACKS on page 46.
- **FAO (Fixed Audio Output)**
This function turns the TV's internal speakers "OFF" and allows fixed audio output from the AUDIO OUTPUT JACKS on page 46. With FAO, the TV's volume control is disabled.

- 1 Press **MENU** to access the MAIN MENU screen.
- 2 Press **CH UP (▲)** or **DOWN (▼)** to move the "●" mark to "AUDIO SELECT".

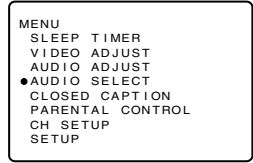
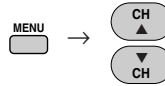

(MAIN MENU screen)

- 3 Press **VOL (+)** or **(-)** to access AUDIO SELECT mode.
- 4 Press **CH UP (▲)** or **DOWN (▼)** to move the "●" mark to "MTS", "SPEAKER" or "FAO".

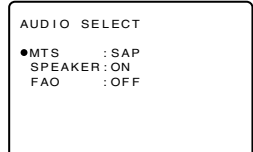
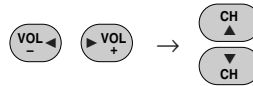

(AUDIO SELECT mode)

- 5 Press **VOL (+)** or **(-)** to select "STEREO", "SAP" or "MONO" when the "●" mark is at "MTS" position.

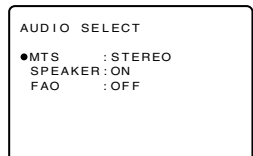
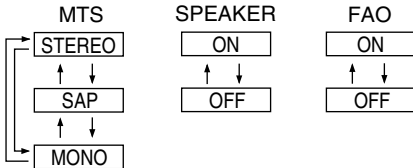

(AUDIO SELECT mode)

- 6 Press **MENU** to exit.



Ex: Actual screen indicating ON AIR when receiving STEREO broadcasts

Actual channel number _____
 "← ON AIR" will appear next to STEREO or _____
 SAP when receiving STEREO or SAP broadcasts.



(CHANNEL call on screen)





Audio Select (Continued)

■ You can enjoy Hi-Fi stereo sound or SAP broadcasts where available.

- Stereo broadcasts
Live television transmission of sports, shows, concerts, etc. can be received in dynamic stereo sound.
- SAP broadcasts
Television broadcast can be received with either MAIN or SAP sound.
MAIN sound: The normal program soundtrack. (Monaural or stereo where available.)
SAP sound: Second language, supplementary commentaries, etc. (SAP sound is monaural.)

■ If stereo sound is difficult to hear.

- You can obtain clearer sound by manually switching to the fixed monaural mode.

Note:

- Once MONO mode is selected, the TV sound remains monaural even if the TV set receives a stereo broadcast. You must switch the mode back to STEREO if you want to hear stereo sound again.
- MTS while in the INPUT mode does not change the type of sound; in this case, sound is determined by the video source.
- If the "FAO" mode is selected "ON", the "SPEAKER" mode will automatically turn "OFF".
"SPEAKER" selecting will not affect "FAO" mode.



Closed Caption

■ HOW TO SET CLOSED CAPTION

- Your TV is equipped with an internal Closed Caption decoder. "Closed Caption" is a system which allows you to view conversations, narration, and sound effects in TV programs and home videos as subscript on your TV screen as shown on the right.
- Not all the programs and videos will offer closed caption. Please look for the "CC" symbol to ensure that captions will be shown.
- Closed Caption broadcast can be viewed in two modes: CAPTION and TEXT. For each mode, two channels are available, CH1 and CH2: The [CAPTION] mode subscripts dialogues and commentaries of TV dramas and news programs while allowing clear view of the picture. The [TEXT] mode displays over the picture other various information (such as TV program schedule, weather forecast, etc.) that is independent of the TV programs.

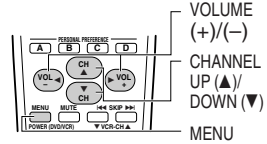
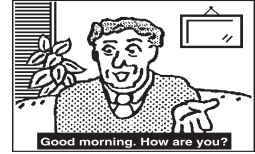

- Press **MENU** to access the MAIN MENU screen.
- Press **CH UP (▲)** or **DOWN (▼)** to move the "●" mark to "CLOSED CAPTION".

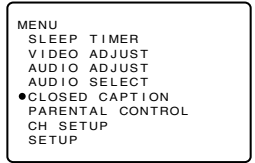
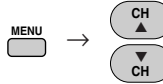

(MAIN MENU screen)

- Press **VOL (+)** or **(-)** to access CLOSED CAPTION setting mode.

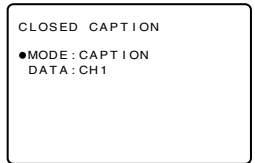

(CLOSED CAPTION setting mode)

- Press **CH UP (▲)** or **DOWN (▼)** to move the "●" mark to either "MODE" or "DATA".

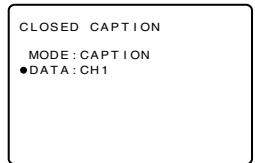

- Press **VOL (+)** or **(-)** to change the CLOSED CAPTION setting.

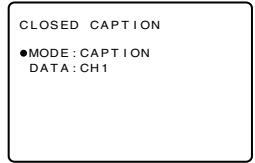
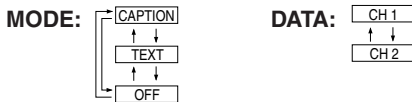

- Press **MENU** to exit.



Note:

- If a broadcast has CLOSED CAPTION and the **MUTE** button is pressed, the set enters [CAPTION] mode automatically. Pressing **MUTE** again will return the set to its previous condition.
- CLOSED CAPTION may malfunction (white blocks, strange characters, etc.) if signal conditions are poor or if there are problems at the broadcast source. This does not necessarily indicate a problem with your TV.
- If any button is pressed to call up the ON SCREEN DISPLAY while viewing a CLOSED CAPTION broadcast, the CLOSED CAPTION will disappear momentarily.
- When viewing in TEXT mode, if no TEXT broadcast is being received, for some programs the screen may become dark and blank. Should this occur, set the CLOSED CAPTION mode to "OFF".





Parental Control (V-CHIP Operation)

■ V-CHIP

- This function allows you to restrict TV programs and also allows you to control TV usage based on FCC data. This function is to prevent your children from watching violence or sexual scenes that may be harmful.
- Restriction of TV programs includes two characters that contain information about the program's MPAA rating and the TV Parental Guidelines. MPAA is restricted by age. TV Parental Guidelines are restricted by age and contents.
- Since a TV program may use either the MPAA rating or the TV Guidelines you should adjust both for complete control.

[1] MPAA RATING

RATING		
age base	G	GENERAL AUDIENCES. All ages admitted.
	PG	PARENTAL GUIDANCE SUGGESTED. Some material may not be suitable for children.
	PG-13	PARENTAL STRONGLY CAUTIONED. Some material may be inappropriate for children under 13.
	R	RESTRICTED. Under 17 requires accompanying parent or adult guardian.
	NC-17	NO ONE 17 AND UNDER ADMITTED.
	X	X Rating is an older rating that is unified with NC-17 but may be encoded on older movie's data.

• MPAA RATING (Example)

Example 1.

"PG-13" in the age based RATING is blocked, this will automatically block the high ratings "R", "NC-17", "X" also.

1. User setting

G	----
PG	----
PG-13	BLOCK
R	BLOCK
NC-17	BLOCK
X	BLOCK

2. Block table

G	not to block
PG	not to block
PG-13	Select block
R	auto-block
NC-17	auto-block
X	auto-block

Example 2.

"R" in the age based RATING is blocked, this will automatically block the high rating "NC-17", "X" also.

1. User setting

G	----
PG	----
PG-13	----
R	BLOCK
NC-17	BLOCK
X	BLOCK

2. Block table

G	not to block
PG	not to block
PG-13	not to block
R	Select block
NC-17	auto-block
X	auto-block

Note:

- MPAA RATING is only age based ratings.

[2] TV PARENTAL GUIDELINES

RATING	content base					
	AGE	D (Sexually Suggestive Dialog)	L (Adult Language)	S (Sexual Situation)	V (Violence)	FV (Fantasy Violence)
Age base ↑ ↓	TV-Y (All children)	<input checked="" type="checkbox"/>	-	-	-	-
	TV-Y7 (Direct to Older Children)	<input checked="" type="checkbox"/>	-	-	-	<input checked="" type="checkbox"/>
	TV-G (General Audience)	<input checked="" type="checkbox"/>	-	-	-	-
	TV-PG (Parental Guidance Suggested)	<input checked="" type="checkbox"/>	<input checked="" type="checkbox"/>	<input checked="" type="checkbox"/>	<input checked="" type="checkbox"/>	-
	TV-14 (Parents Strongly Cautioned)	<input checked="" type="checkbox"/>	<input checked="" type="checkbox"/>	<input checked="" type="checkbox"/>	<input checked="" type="checkbox"/>	-
	TV-MA (Mature Audience Only)	<input checked="" type="checkbox"/>	-	<input checked="" type="checkbox"/>	<input checked="" type="checkbox"/>	-

: Content Rating can be set.

- : Content Rating cannot be set (not normally broadcast by TV station).



Parental Control (V-CHIP Operation Continued)

• **TV-PARENTAL GUIDELINES (Example)**

Example 1.1 : Age Based setting

Go through all select ratings and select unblocked for "AGE". This will automatically unblock everything.

	AGE	D	L	S	V	FV
TV-Y	<input type="checkbox"/>	-	-	-	-	-
TV-Y7	<input type="checkbox"/>	-	-	-	-	<input type="checkbox"/>
TV-G	<input type="checkbox"/>	-	-	-	-	-
TV-PG	<input type="checkbox"/>	<input type="checkbox"/>	<input type="checkbox"/>	<input type="checkbox"/>	<input type="checkbox"/>	<input type="checkbox"/>
TV-14	<input type="checkbox"/>	<input type="checkbox"/>	<input type="checkbox"/>	<input type="checkbox"/>	<input type="checkbox"/>	<input type="checkbox"/>
TV-MA	<input type="checkbox"/>	<input type="checkbox"/>	<input type="checkbox"/>	<input type="checkbox"/>	<input type="checkbox"/>	<input type="checkbox"/>
RETURN						

: BLOCK

Example 1.2 : Age Based setting

For "TV-G" select "BLOCK" for "AGE". This will automatically block the higher age ratings "TV-PG", "TV-14" and "TV-MA" as well as "TV-G".

Furthermore, the content ratings "D", "L", "S", "V", "FV" are automatically blocked as well for "TV-PG", "TV-14" and "TV-MA" as well as "TV-G".

	AGE	D	L	S	V	FV
TV-Y	<input type="checkbox"/>	-	-	-	-	-
TV-Y7	<input type="checkbox"/>	-	-	-	-	<input type="checkbox"/>
TV-G	<input checked="" type="checkbox"/>	<input checked="" type="checkbox"/>	<input checked="" type="checkbox"/>	<input checked="" type="checkbox"/>	<input checked="" type="checkbox"/>	<input checked="" type="checkbox"/>
TV-PG	<input checked="" type="checkbox"/>	<input checked="" type="checkbox"/>	<input checked="" type="checkbox"/>	<input checked="" type="checkbox"/>	<input checked="" type="checkbox"/>	<input checked="" type="checkbox"/>
TV-14	<input checked="" type="checkbox"/>	<input checked="" type="checkbox"/>	<input checked="" type="checkbox"/>	<input checked="" type="checkbox"/>	<input checked="" type="checkbox"/>	<input checked="" type="checkbox"/>
TV-MA	<input checked="" type="checkbox"/>	<input checked="" type="checkbox"/>	<input checked="" type="checkbox"/>	<input checked="" type="checkbox"/>	<input checked="" type="checkbox"/>	<input checked="" type="checkbox"/>
RETURN						

: BLOCK

Example 2.1 : Content Based setting

For "TV-PG", "TV-14" and "TV-MA" select unblocked for each content ratings ("D", "L", "S", "V", "FV") by leaving "AGE" unblocked for "TV-PG", "TV-14" and "TV-MA". If you choose to unblock for each one in content base.

	AGE	D	L	S	V	FV
TV-Y	<input type="checkbox"/>	-	-	-	-	-
TV-Y7	<input type="checkbox"/>	-	-	-	-	<input type="checkbox"/>
TV-G	<input type="checkbox"/>	-	-	-	-	-
TV-PG	<input type="checkbox"/>	<input type="checkbox"/>	<input type="checkbox"/>	<input type="checkbox"/>	<input type="checkbox"/>	<input type="checkbox"/>
TV-14	<input type="checkbox"/>	<input type="checkbox"/>	<input type="checkbox"/>	<input type="checkbox"/>	<input type="checkbox"/>	<input type="checkbox"/>
TV-MA	<input type="checkbox"/>	<input type="checkbox"/>	<input type="checkbox"/>	<input type="checkbox"/>	<input type="checkbox"/>	<input type="checkbox"/>
RETURN						

: BLOCK

Example 2.2 : Content Based setting

Then for "TV-PG" and select "BLOCK" for only "V" (Violence). This will automatically block the higher ratings "TV-14-V" and "TV-MA-V" ("TV-14" and "TV-MA" for Violence content only).

Please note that with these settings blocking does NOT occur. If a program is rated only "TV-MA"; it must be rated "TV-MA-V" to be blocked.

	AGE	D	L	S	V	FV
TV-Y	<input type="checkbox"/>	-	-	-	-	-
TV-Y7	<input type="checkbox"/>	-	-	-	-	<input type="checkbox"/>
TV-G	<input type="checkbox"/>	-	-	-	-	-
TV-PG	<input type="checkbox"/>	<input type="checkbox"/>	<input type="checkbox"/>	<input type="checkbox"/>	<input checked="" type="checkbox"/>	<input type="checkbox"/>
TV-14	<input type="checkbox"/>	<input type="checkbox"/>	<input type="checkbox"/>	<input type="checkbox"/>	<input checked="" type="checkbox"/>	<input type="checkbox"/>
TV-MA	<input type="checkbox"/>	<input type="checkbox"/>	<input type="checkbox"/>	<input type="checkbox"/>	<input checked="" type="checkbox"/>	<input type="checkbox"/>
RETURN						

: BLOCK

Example 3 : Reset an Age Based setting

For "TV-14" and select again "BLOCK" for "AGE".

This will again automatically block the content ratings "D", "L", "S", "V", "FV" for "TV-MA" as well as "TV-14".

Please note that the lower age rating "TV-PG" did not change from its previous settings.

	AGE	D	L	S	V	FV
TV-Y	<input type="checkbox"/>	-	-	-	-	-
TV-Y7	<input type="checkbox"/>	-	-	-	-	<input type="checkbox"/>
TV-G	<input type="checkbox"/>	-	-	-	-	-
TV-PG	<input type="checkbox"/>	<input type="checkbox"/>	<input type="checkbox"/>	<input type="checkbox"/>	<input type="checkbox"/>	<input type="checkbox"/>
TV-14	<input checked="" type="checkbox"/>	<input checked="" type="checkbox"/>	<input checked="" type="checkbox"/>	<input checked="" type="checkbox"/>	<input checked="" type="checkbox"/>	<input checked="" type="checkbox"/>
TV-MA	<input checked="" type="checkbox"/>	<input checked="" type="checkbox"/>	<input checked="" type="checkbox"/>	<input checked="" type="checkbox"/>	<input checked="" type="checkbox"/>	<input checked="" type="checkbox"/>
RETURN						

: BLOCK

Note:

- Content ratings can be modified but only in the combinations indicated by an in the table on page 25.
- Changing a lower age rating's content setting to "BLOCK" automatically changes the same higher rating's content setting to "BLOCK" regardless of their previous settings.
- Changing a lower rating's "AGE" setting to "BLOCK" automatically changes all higher ratings to "BLOCK" regardless of their previous settings.
- Any rating's "AGE" set to unblocked must have its content settings individually set.

[3] ADDITIONAL MODE

Besides the above "MPAA RATINGS" and "TV PARENTAL GUIDELINES" new ratings system's data can be downloaded when they become available. (See page 29.)



Parental Control (V-CHIP Operation Continued)

■ HOW TO SET V-CHIP

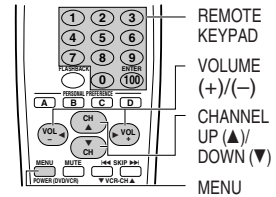

[1] MPAA RATING

- 1 Press **MENU** to access the MAIN MENU screen.
- 2 Press **CH UP (▲)** or **DOWN (▼)** to move the “●” mark to “PARENTAL CONTROL”.

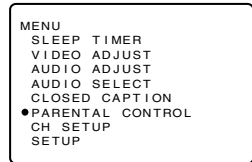
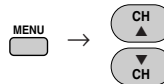

(MAIN MENU screen)

- 3 Press **VOL (+)** or **(-)** to access PARENTAL CONTROL mode.

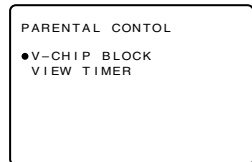

(PARENTAL CONTROL mode)

- 4 Press **VOL (+)** or **(-)** to access V-CHIP BLOCK select mode, then press **VOL (+)** or **(-)** to select “MPAA RATING”.

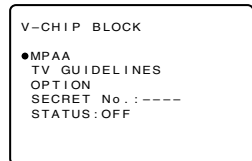
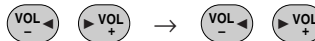

(V-CHIP BLOCK select mode)

- 5 Press **CH UP (▲)** or **DOWN (▼)** to move the “●” mark to “PG”, then press **VOL (+)** or **(-)** to select BLOCK. If you set “PG” to BLOCK, “PG-13”, “R”, “NC-17” and “X” are automatically blocked.

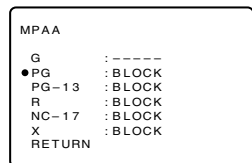
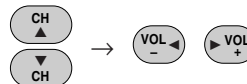

- 6 Press **CH UP (▲)** or **DOWN (▼)** to move the “●” mark to “RETURN”, then press **VOL (+)** or **(-)** to exit V-CHIP BLOCK select mode.

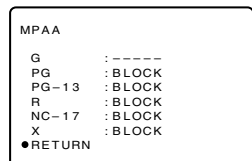
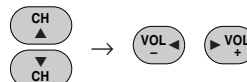

Note:

Ex.

- If you set “G” to BLOCK, all RATING are automatically blocked.
- If you set “X” to BLOCK, “G”, “PG”, “PG-13”, “R” and “NC-17” are not blocked.





Parental Control (V-CHIP Operation Continued)

[2] TV GUIDELINES

- Repeat steps 1 to 3 of [1] MPAA RATING.
- Press **VOL (+)** or **(-)** to access V-CHIP BLOCK select mode, then press **CH UP (▲)** or **DOWN (▼)** to move the "●" mark to "TV GUIDELINES".

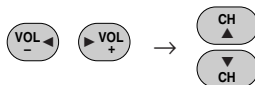

V-CHIP BLOCK

MPAA
● TV GUIDELINES
OPTION
SECRET No. : ----
STATUS : OFF

(V-CHIP BLOCK select mode)

- Press **VOL (+)** or **(-)** to access TV GUIDELINES mode.



	AGE	D	L	S	V	FV
TV-Y	<input type="checkbox"/>	-	-	-	-	-
● TV-Y7	<input checked="" type="checkbox"/>	-	-	-	-	<input checked="" type="checkbox"/>
TV-G	<input checked="" type="checkbox"/>	-	-	-	-	-
TV-PG	<input checked="" type="checkbox"/>	<input checked="" type="checkbox"/>	<input checked="" type="checkbox"/>	<input checked="" type="checkbox"/>	<input checked="" type="checkbox"/>	<input checked="" type="checkbox"/>
TV-14	<input checked="" type="checkbox"/>	<input checked="" type="checkbox"/>	<input checked="" type="checkbox"/>	<input checked="" type="checkbox"/>	<input checked="" type="checkbox"/>	<input checked="" type="checkbox"/>
TV-MA	<input checked="" type="checkbox"/>	-	-	-	-	-
RETURN						

: BLOCK

(TV GUIDELINES mode)

- To change CONTENT SETTING, press **CH UP (▲)** or **DOWN (▼)** to move the "●" mark to the desired rating and then press **VOL (+)** or **(-)** to select.

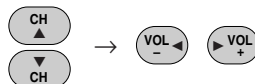

- Press **CH UP (▲)** or **DOWN (▼)** to move the "●" mark to the desired content and then press **VOL (+)** or **(-)** to select either "BLOCK" or unblock ("-----").

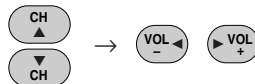

TV-Y7

● AGE : BLOCK
D : -----
L : -----
S : -----
V : -----
FV : BLOCK
RETURN

(CONTENT RATING mode)

- Press **CH UP (▲)** or **DOWN (▼)** to move the "●" mark to "RETURN", then press **VOL (+)** or **(-)** to return to TV GUIDELINES mode.

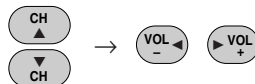

	AGE	D	L	S	V	FV
TV-Y	<input type="checkbox"/>	-	-	-	-	-
TV-Y7	<input type="checkbox"/>	-	-	-	-	<input type="checkbox"/>
● TV-G	<input checked="" type="checkbox"/>	-	-	-	-	-
TV-PG	<input checked="" type="checkbox"/>	<input checked="" type="checkbox"/>	<input checked="" type="checkbox"/>	<input checked="" type="checkbox"/>	<input checked="" type="checkbox"/>	<input checked="" type="checkbox"/>
TV-14	<input checked="" type="checkbox"/>	<input checked="" type="checkbox"/>	<input checked="" type="checkbox"/>	<input checked="" type="checkbox"/>	<input checked="" type="checkbox"/>	<input checked="" type="checkbox"/>
TV-MA	<input checked="" type="checkbox"/>	-	-	-	-	-
RETURN						

: BLOCK

- Repeat steps 4 to 5 until all ratings and their contents are set.

- When done, press **MENU** to exit.





Parental Control (V-CHIP Operation Continued)

[3] ADDITIONAL MODE (DOWNLOAD)

There will be an additional new rating system. In that case, please set up as follows. Subsequently the new rating system will set up automatically.

1 Repeat steps 1 to 3 of [1] MPAA RATING.

2 Press **VOL (+)** or **(-)** to access V-CHIP BLOCK select mode, then press **CH UP (▲)** or **DOWN (▼)** to move the “●” mark to “OPTION”.

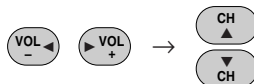

V-CHIP BLOCK

MPAA
TV GUIDELINES
● OPTION
SECRET No. : ----
STATUS : OFF

(V-CHIP BLOCK select mode)

3 Press **VOL (+)** or **(-)** to access OPTION mode, then press **CH UP (▲)** or **DOWN (▼)** to move the “●” mark to “DOWNLOAD”, then press **VOL (+)** or **(-)** to “DOWNLOAD : ON”.



OPTION

● DOWNLOAD : ON
RETURN

(OPTION mode)

4 Press **MENU** to exit.



• DOWNLOAD V-CHIP DATA

1 If you watch the program containing “New Rating System Data”, the DOWNLOAD screen will be displayed.

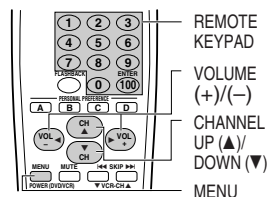

PLEASE WAIT

NOW DOWNLOADING
V-CHIP DATA

(DOWNLOAD screen)

2 The DOWNLOAD screen will disappear, once downloading is finished.

Note:

- DOWNLOAD will not start, if you do not watch a program containing “New Rating System Data”.



Parental Control (V-CHIP Operation Continued)

• How to set Additional mode (Example)

- Repeat steps 1 to 2 of [3] **ADDITIONAL MODE**.
- Press **CH UP (▲)** or **DOWN (▼)** to move the “●” mark to “Cdn. English Ratings”, then press **VOL (+)** or **(-)**.

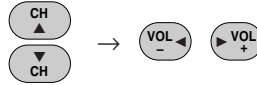

```

OPTION
● Cdn. English Ratings
  Cdn. French Ratings

DOWNLOAD: ON
RETURN
  
```

(After download the rating data)

- You can select “BLOCK” or “-----” (unlock) from each RATING mode by pressing **CH UP (▲)** or **DOWN (▼)** and **VOL (+)** or **(-)**.

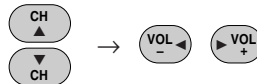

```

CANADIAN ENGLISH
● C8+ :-----
  G   :-----
  PG  :-----
  14+ :-----
  18+ :BLOCK
RETURN (THRESHOLD BLOCK)
  
```

(ENGLISH THRESHOLD BLOCK mode)

- You can select “BLOCK” or “-----” (unlock) from each RATING mode by pressing **CH UP (▲)** or **DOWN (▼)** and **VOL (+)** or **(-)** if you select “Cdn. French Ratings” in step 2.

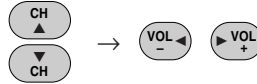

```

CANADIAN FRENCH
● G   :-----
  8ans+ :-----
  13ans+ :-----
  16ans+ :-----
  18ans+ :BLOCK
RETURN (THRESHOLD BLOCK)
  
```

(FRENCH THRESHOLD BLOCK mode)

Note:

• In additional mode

Including two types (English mode, French mode), altogether you are able to download 4 different modes.





Parental Control (V-CHIP Operation Continued)

■ Turning On (Activating) the V-Chip Blocks

- Repeat steps 1 to 3 of [1] **MPAA RATING**.
- Press **VOL (+)** or **(-)** to access V-CHIP BLOCK select mode, then press **CH UP (▲)** or **DOWN (▼)** to move the “●” mark to “SECRET No.”.



V-CHIP BLOCK

MPAA
TV GUIDELINES
OPTION
● SECRET No. : ----
STATUS : OFF

(V-CHIP BLOCK select mode)

- Enter a 4-digit SECRET No. using the **REMOTE KEYPAD**.



V-CHIP BLOCK

MPAA
TV GUIDELINES
OPTION
● SECRET No. : 1234
STATUS : OFF

- Press **CH UP (▲)** or **DOWN (▼)** to move the “●” mark to “STATUS”, then press **VOL (+)** or **(-)** to activate the V-CHIP BLOCK. (If STATUS is OFF, V-CHIP BLOCK will not operate.)

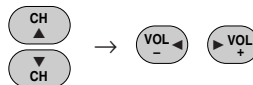

V-CHIP BLOCK

MPAA
TV GUIDELINES
OPTION
● SECRET No. : 1234
● STATUS : OFF

- When done, press **MENU** to exit.



■ To cancel the V-CHIP BLOCK screen while V-CHIP BLOCK has been activated.

- “V-CHIP HAS BEEN ACTIVATED” will be displayed if you view a program containing Program Rating data as same as you configured.

Note:

- “V-CHIP HAS BEEN ACTIVATED” will not be displayed if STATUS is not configured to “ON”.

V-CHIP HAS BEEN ²³
ACTIVATED

TV-Y7
FV

- Press **MENU**, then “INPUT SECRET No.” will be displayed.



INPUT SECRET No.
- - - -

- Enter the 4-digit SECRET No. using the **REMOTE KEYPAD**, then V-CHIP BLOCK temporarily will be canceled. If the wrong SECRET No. is chosen, “SECRET No. IS INCORRECT” will be displayed. Input the SECRET No. again in this case.



INPUT SECRET No.
* * * *

Note:

- If you turn the power from OFF, the V-CHIP BLOCK will automatically reset to ON again.





Parental Control (V-CHIP Operation Continued)

- To change the V-CHIP BLOCK setting. (Secret No. is registered.)

- 1 Repeat steps 1 to 3 of [1] MPAA RATING, then "INPUT SECRET No." will be displayed.

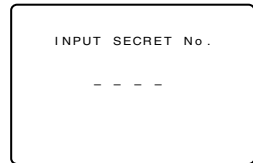

- 2 Enter the 4-digit "INPUT SECRET No." using the **REMOTE KEYPAD** and the V-CHIP select mode will be displayed. Repeat configuration of the V-CHIP BLOCK.

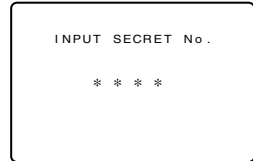

- If you forget or need to change your Secret No., clear the original Secret No. and set up a new one.

- 1 Repeat steps 1 to 3 of [1] MPAA RATING, or 1 to 2 of [■ To cancel the V-CHIP BLOCK screen while V-CHIP BLOCK has been activated], then "INPUT SECRET No." will be displayed.

- 2 Press and hold both **VOL (+)** and **CH UP (▲)** on the TV set simultaneously until the message "INPUT SECRET No." disappears.

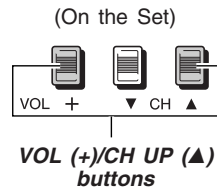

- 3 Press the **MENU** button to exit.





Parental Control (VIEW TIMER)

VIEW TIMER

This function allows you to restrict TV viewing time and also allows you to control TV usage. This function is to prevent your children from watching too much TV.

VIEWING TIME (an accumulative timer: counts only the time duration acquired while the TV is on.)

- VIEWING TIME can be set from 30M (30 minutes) to 10H00M (10 hours) in 30 minutes intervals.

OFF TIME (Restricts TV watching after the VIEWING TIME reaches zero.)

- OFF TIME can be set from 30M (30 minutes) to 10H00M (10 hours) in 30 minutes intervals.

STATUS (ON/OFF setting of VIEW TIMER)

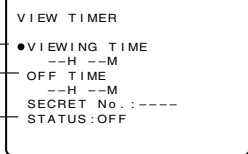

How to set VIEW TIMER.

1 Press **MENU** to access the MAIN MENU screen.

2 Press **CH UP** (▲) or **DOWN** (▼) to move the “●” mark to “PARENTAL CONTROL”.

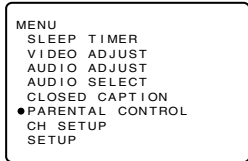
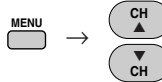

(MAIN MENU screen)

3 Press **VOL (+)** or **(-)** to access PARENTAL CONTROL mode.

4 Press **CH UP** (▲) or **DOWN** (▼) to move the “●” mark to “VIEW TIMER”.

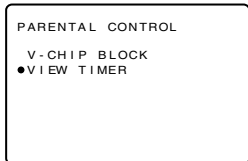

(PARENTAL CONTROL mode)

5 Press **VOL (+)** or **(-)** to access VIEW TIMER mode.

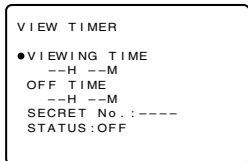

(VIEW TIMER mode)

6 Press **CH UP** (▲) or **DOWN** (▼) to select “VIEWING TIME” and “OFF TIME”. For each selection, press **VOL (+)** or **(-)** to set the time duration.

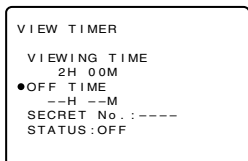
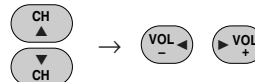

7 Press **CH UP** (▲) or **DOWN** (▼) to select “SECRET No.”. Enter a 4-digit SECRET No. using **REMOTE KEYPAD**.

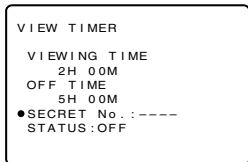
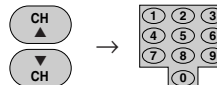

8 Press **CH UP** (▲) or **DOWN** (▼) to select “STATUS”. Press **VOL (+)** or **(-)** to turn ON the “VIEW TIMER”. (If STATUS is OFF, VIEW TIMER will not operate.)

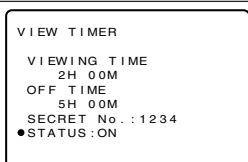
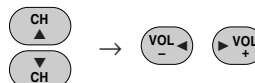



Parental Control (VIEW TIMER Continued)

9 Press **MENU** to exit.



Example

- To restrict anybody from watching the TV for 5 hours, after watching the TV for 2 hours, your settings would look like this:
- They can choose to watch the 2 hours of TV however they wish. For example, they could watch 1 hour of TV, turn TV off for 30 minutes, then turn TV on and watch the remaining 1 hour on the VIEWING TIMER.

```
VIEW TIMER
VIEWING TIME
 2H 00M
OFF TIME
 5H 00M
SECRET No. : 1234
●STATUS:ON
```

■ To change the VIEW TIMER settings. (SECRET No. is registered)

1 Repeat “How to set VIEW TIMER” steps and select “PARENTAL CONTROL VIEW TIMER” during step 3. Press **VOL (+)** or **(-)**, and “INPUT SECRET No.” will be displayed.



INPUT SECRET No.

- - - -

2 Enter the 4-digit SECRET No. using the **REMOTE KEYPAD**, and the VIEW TIMER mode will be displayed. Repeat step 6 ~ 9.



```
VIEW TIMER
VIEWING TIME
 2H 00M
OFF TIME
 5H 00M
SECRET No. : 1234
●STATUS:OFF
```

Note:

- When you choose the correct SECRET No., the VIEW TIMER mode is displayed. If the wrong SECRET No. is chosen, “SECRET No. IS INCORRECT” is displayed. Input the SECRET No. again in this case.

SECRET No. IS
INCORRECT

■ To cancel the VIEW TIMER (While the TV set is OFF but the VIEW TIMER is set)

1 Turn on TV; a blue screen message “TIME OVER” will appear. If you do nothing, the TV will turn off in approximately 30 seconds.

TIME OVER
INPUT SECRET No.
- - - -

2 Enter the 4-digit SECRET No. using the **REMOTE KEYPAD**. When you choose the correct SECRET No., the VIEW TIMER is canceled. If the wrong SECRET No. is chosen, “SECRET No. IS INCORRECT” is displayed. Input the SECRET No. again in this case.



TIME OVER
INPUT SECRET No.
* * * *

■ To cancel the VIEW TIMER setting or change the SECRET No. (When you forget the SECRET No.)

1 Repeat “How to set VIEW TIMER” steps and select “PARENTAL CONTROL VIEW TIMER” during step 3. Press **VOL (+)** or **(-)**, and “INPUT SECRET No.” will be displayed.

INPUT SECRET No.

- - - -





Parental Control (VIEW TIMER Continued)

- 2** Press and hold both **VOL (+)** and **CH UP (▲)** on the TV set simultaneously until the VIEW TIMER mode is displayed. Now you can cancel the VIEW TIMER settings or change the SECRET No. while "INPUT SECRET No." is displayed.

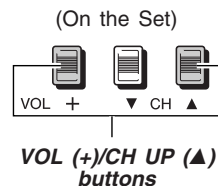

■ Notice of Remaining VIEWING TIME

- For every 30 minute interval, the "remaining time" will be displayed for 4 seconds. For the last 5 minutes, the "remaining time" will be displayed every minute.
- "0H00M REMAIN" will be displayed for 10 seconds just before the VIEWING TIME is complete.

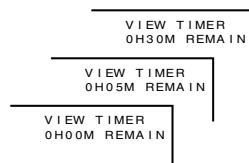



Ch Setup

■ EZ SETUP

By operating the channel preset functions, you can preset your TV to the desired channels for viewing.

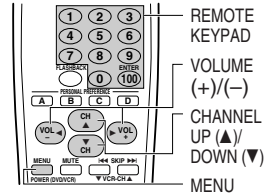

- 1 Press **MENU** to access the MAIN MENU screen.
- 2 Press **CH UP (▲)** or **DOWN (▼)** to move the "●" mark to "CH SETUP".

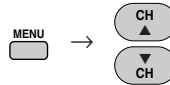

```

MENU
SLEEP TIMER
VIDEO ADJUST
AUDIO ADJUST
AUDIO SELECT
CLOSED CAPTION
PARENTAL CONTROL
● CH SETUP
SETUP
  
```

(MAIN MENU screen)

- 3 Press **VOL (+)** or **(-)** to access CH SETUP mode, then press **CH UP (▲)** or **DOWN (▼)** to move the "●" mark to "EZ SETUP".



```

CH SETUP
AIR / CABLE
CH MEMORY
CH SEARCH
PERSONAL PREF.
UNIVERSAL PLUS
● EZ SETUP
  
```

(CH SETUP mode)

- 4 Press **VOL (+)** or **(-)** to access EZ SETUP mode.



```

CONNECT ANTENNA OR
CABLE
START EZ SETUP?
● STOP      START
  
```

(EZ SETUP mode)

- 5 Press **VOL (+)**.
The tuner will automatically search for the broadcasting and cable TV channels. (The CH No. will automatically increase when it appears.)

If you want to stop the EZ SETUP process once it has started, press **VOL (-)**. Search will be canceled.

To cancel EZ SETUP

Press **VOL (-)**.



```

PLEASE WAIT
AUTO PROGRAMMING
125
STOP      ● START
  
```

- 6 Once EZ SETUP is completed, the lowest channel number memorized will be displayed.

2





Ch Setup (Continued)

■ CHANNEL SETTING

If EZ SETUP does not memorize all the channels in your region, follow the instructions below to manually memorize the channel.

1 AIR/CABLE setting

- 1 Press **MENU** to access the MAIN MENU screen.
- 2 Press **CH UP (▲)** or **DOWN (▼)** to move the "●" mark to "CH SETUP".

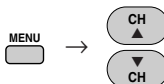

```

MENU
SLEEP TIMER
VIDEO ADJUST
AUDIO ADJUST
AUDIO SELECT
CLOSED CAPTION
PARENTAL CONTROL
● CH SETUP
SETUP
  
```

(MAIN MENU screen)

- 3 Press **VOL (+)** or **(-)** to access CH SETUP mode.



```

CH SETUP
● AIR / CABLE
CH MEMORY
CH SEARCH
PERSONAL PREF.
UNIVERSAL PLUS
EZ SETUP
  
```

(CH SETUP mode)

- 4 Press **VOL (+)** or **(-)** to access AIR/CABLE mode.



```

AIR / CABLE
● AIR
CABLE STD
CABLE HRC
CABLE IRC
  
```

(AIR/CABLE mode)

- 5 Press **CH UP (▲)** or **DOWN (▼)** to move the "●" mark to the desired mode.

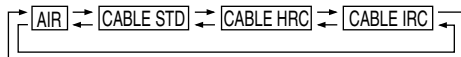

```

AIR / CABLE
| AIR
| CABLE STD
● CABLE HRC
| CABLE IRC
  
```

(AIR/CABLE mode)

- 6 Press **MENU** to exit.



Note:

- Receivable channels of your TV set are:

AIR channels:

VHF: 2 through 13.
UHF: 14 through 69.

CABLE channels:

1 (HRC and IRC mode only)
2 through 125 (STD, HRC and IRC)





Ch Setup (Continued)

2 How to save broadcast TV channels into memory.

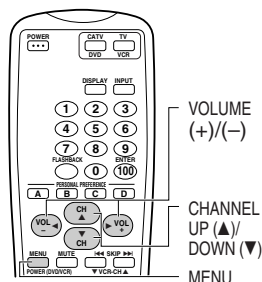

1.1 Press **MENU** to access the MAIN MENU screen, then press **CH UP (▲)** or **DOWN (▼)** to move the “●” mark to “CH SETUP”.

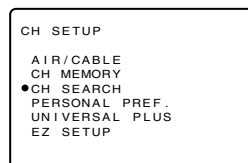
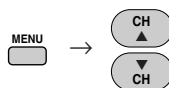

(CH SETUP mode)

1.2 Press **VOL (+)** or **(-)** to access CH SETUP mode, then press **CH UP (▲)** or **DOWN (▼)** to move the “●” mark to “CH SEARCH”.

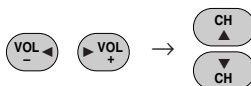

1.3 Press **VOL (+)** or **(-)** to access CH SEARCH mode.



START

2.1 Press **VOL (+)**. The tuner will search through all available channels in your area and add them into the TV's memory.

(START)



(CH SEARCH mode)

STOP

2.2 Press **VOL (-)**. CH SEARCH will stop at the current channel and will not add any higher channels.

(STOP)



2.3 Press **MENU** to exit.



Note:

- If you press **VOL (+)** again while in the CH SEARCH mode, auto-program will start again, and the previously memorized channels will be lost.





Ch Setup (Continued)

3 How to add or erase weak, additional or unwanted channels from TV memory.

- 1 Press **MENU** to access the MAIN MENU screen, then press **CH UP (▲)** or **DOWN (▼)** to move the “●” mark to “CH SETUP”.

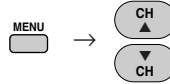

```

MENU
SLEEP TIMER
VIDEO ADJUST
AUDIO ADJUST
AUDIO SELECT
CLOSED CAPTION
PARENTAL CONTROL
● CH SETUP
SETUP
  
```

(MAIN MENU screen)

- 2 Press **VOL (+)** or **(-)** to access CH SETUP mode, then press **CH UP (▲)** or **DOWN (▼)** to move the “●” mark to “CH MEMORY”.

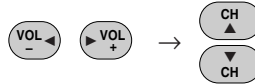

```

CH SETUP
AIR / CABLE
● CH MEMORY
CH SEARCH
PERSONAL PREF.
UNIVERSAL PLUS
EZ SETUP
  
```

(CH SETUP mode)

- 3 Press **VOL (+)** or **(-)** to access CH MEMORY mode.



```

CH MEMORY

AIR 12

ERASE ● ADD
  
```

(CH memory mode)

- 4 Use **CH UP (▲)** or **DOWN (▼)** or **REMOTE KEYPAD** to select each desired channel to add or erase.

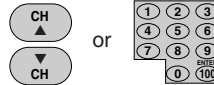

- 5 Press **VOL (+)** to add a channel to the TV's memory or press **VOL (-)** to erase a channel from the TV's memory.



- 6 Press **MENU** to exit.





Ch Setup (Continued)

PERSONAL PREFERENCE

By setting the **PERSONAL PREFERENCE** channels in advance, you can select your favorite channels easily.

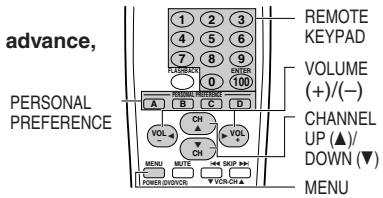

- 1 Press **MENU** to access the MAIN MENU screen.
- 2 Press **CH UP (▲)** or **DOWN (▼)** to move the “●” mark to “CH SETUP”.

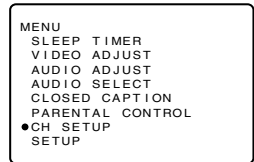
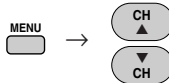

(MAIN MENU screen)

- 3 Press **VOL (+)** or **(-)** to access CH SETUP mode, then press **CH UP (▲)** or **DOWN (▼)** to move the “●” mark to “PERSONAL PREFERENCE”.

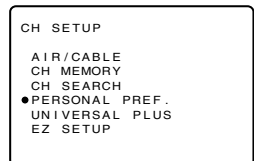

(SETUP mode)

- 4 Press **VOL (+)** or **(-)** to select PERSONAL PREFERENCE select mode in which you can program 4 favorite channels, in 4 different categories. (total of 16 channels)

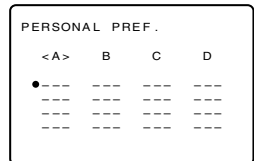

(PERSONAL PREFERENCE select mode)

- 5 Press **CH UP (▲)** or **DOWN (▼)** to move the “●” mark to the desired position.

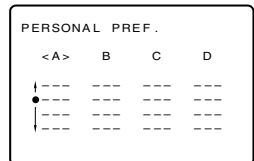

- 6 Press **REMOTE KEYPAD** on the Remote to input the CHANNEL Number into the memory.

Example:

- 125 — Press “100” followed by “2” and then “5”.
- 25 — Press “2” and then “5”.
- 4 — Press “0” and then “4”.

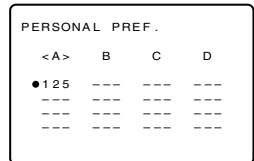

- 7 Repeat steps 4 to 6 to input the next CHANNEL Number.

- 8 Press **MENU** to exit.



To select the PERSONAL PREFERENCE channel.

If the channels are memorized as shown to the right, press the Remote’s “A” button to select the Channels below.

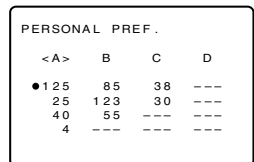
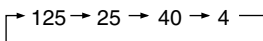



Ch Setup (Continued)

■ UNIVERSAL PLUS FUNCTION

VCR or DVD input mode will be selected automatically by pressing the VCR or DVD PLAY buttons on the UNIVERSAL REMOTE CONTROL.

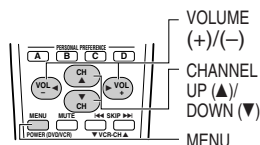

1 Press **MENU** to access the MAIN MENU screen.

2 Press **CH UP (▲)** or **DOWN (▼)** to move the “●” mark to “CH SETUP”.

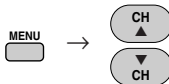

```

MENU
SLEEP TIMER
VIDEO ADJUST
AUDIO ADJUST
AUDIO SELECT
CLOSED CAPTION
PARENTAL CONTROL
● CH SETUP
SETUP
  
```

(MAIN MENU screen)

3 Press **VOL (+)** or **(-)** to access CH SETUP mode, then press **CH UP (▲)** or **DOWN (▼)** to move the “●” mark to “UNIVERSAL PLUS”.

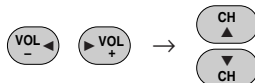

```

CH SETUP
AIR / CABLE
CH MEMORY
CH SEARCH
PERSONAL PREF.
● UNIVERSAL PLUS
EZ SETUP
  
```

(CH SETUP mode)

4 Press **VOL (+)** or **(-)** to access UNIVERSAL PLUS to select VCR or DVD mode.



```

UNIVERSAL PLUS
● VCR: OFF
DVD: OFF
  
```

(EZ SETUP mode)

5 Press **CH UP (▲)** or **DOWN (▼)** to select the VCR or DVD, and press **VOL (+)** or **(-)** to select “CH3, CH4”, “INPUT 1 (or COMPONENT)”, “INPUT 2” or “OFF”.

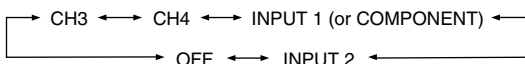

Set model to the input in which your VCR or DVD is connected to. If done through RF, select either channel 3 or 4 to match the setting of the VCR or DVD.

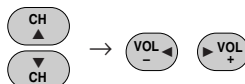

```

UNIVERSAL PLUS
● VCR: CH3
DVD: OFF
  
```

(UNIVERSAL PLUS select mode)

6 Press **MENU** to exit.





Set Up

ENERGY SAVE

This feature lets you lower the power consumption of your TV set which in turn saves you money and minimizes the impact on the environment. When this feature is turned on, it reduce the brightness of the TV to a level that consumes approximately 20 percent less energy than when the feature is turned off. The reduction in brightness will be less noticeable under low room lighting conditions.

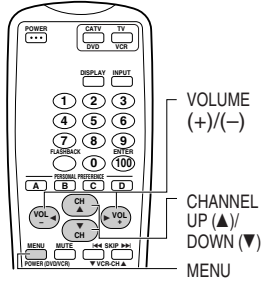

- 1 Press **MENU** to access the MAIN MENU screen.
- 2 Press **CH UP (▲)** or **DOWN (▼)** to move the “●” mark to “SETUP”.

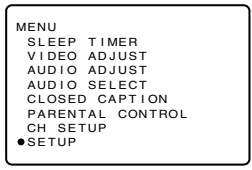
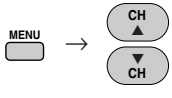

(MAIN MENU screen)

- 3 Press **VOL (+)** or **(-)** to access SETUP select mode, then press **CH UP (▲)** or **DOWN (▼)** to move the “●” mark to “ENERGY SAVE”.

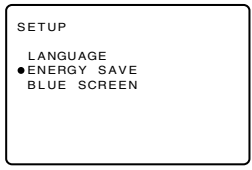
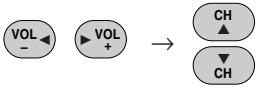

(SETUP mode)

- 4 Press **VOL (+)** or **(-)** to access ENERGY SAVE select mode.

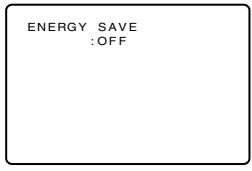

(ENERGY SAVE select mode)

- 5 Press **VOL (+)** or **(-)** to select “ON”.

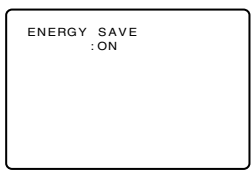

- 6 Press **MENU** to exit.





Set Up (Continued)

■ BLUE SCREEN

Automatically turns the screen blue if a broadcast signal is not received.

1 Press **MENU** to access MAIN MENU screen.

2 Press **CH UP** (▲) or **DOWN** (▼) to move the “●” mark to “SETUP”.

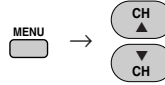

```
MENU
SLEEP TIMER
VIDEO ADJUST
AUDIO ADJUST
AUDIO SELECT
CLOSED CAPTION
PARENTAL CONTROL
CH SETUP
●SETUP
```

(MAIN MENU screen)

3 Press **VOL (+)** or **(-)** to access SETUP mode, then press **CH UP** (▲) or **DOWN** (▼) to move the “●” mark to “BLUE SCREEN”.



```
SETUP
LANGUAGE
ENERGY SAVE
●BLUE SCREEN
```

(SETUP mode)

4 Press **VOL (+)** or **(-)** to access BLUE SCREEN select mode.



```
BLUE SCREEN
: OFF
```

(BLUE SCREEN select mode)

5 Press **VOL (+)** or **(-)** to select “ON”.



```
BLUE SCREEN
: ON
```

6 Press **MENU** to exit.



When BLUE SCREEN is set to “ON”.

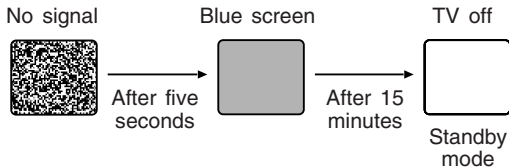

Note:

- Poor reception due to weak signals, or too much noise might activate the BLUE SCREEN function despite the presence of a broadcast signal. To continue watching TV under these conditions, switch the BLUE SCREEN “OFF”.





Using the Video and Audio Input Jacks

■ Connecting video equipment for playback of video material.

- When the television is connected to video equipment as shown below, the material being played back on the video equipment can be seen on the television screen.

Connecting video device equipped with video output terminals.

CONNECTIONS

VIDEO EQUIPMENT



CAMCORDER

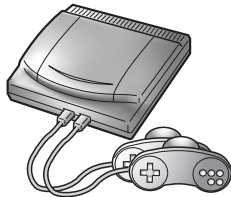

TV GAME



VCR



DVD

(Front connection terminals of TV)

(Pull open for inside door)

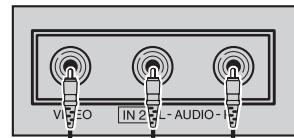

To VIDEO OUTPUT

To AUDIO OUTPUT (L)

To AUDIO OUTPUT (R)

(Rear connection terminals of TV)

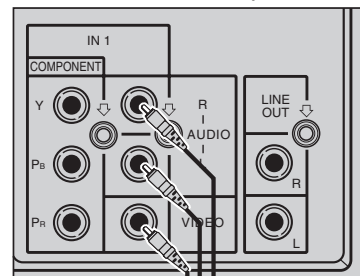

To VIDEO OUTPUT

To AUDIO OUTPUT (L)

To AUDIO OUTPUT (R)





Using the Video and Audio Input Jacks (Continued)

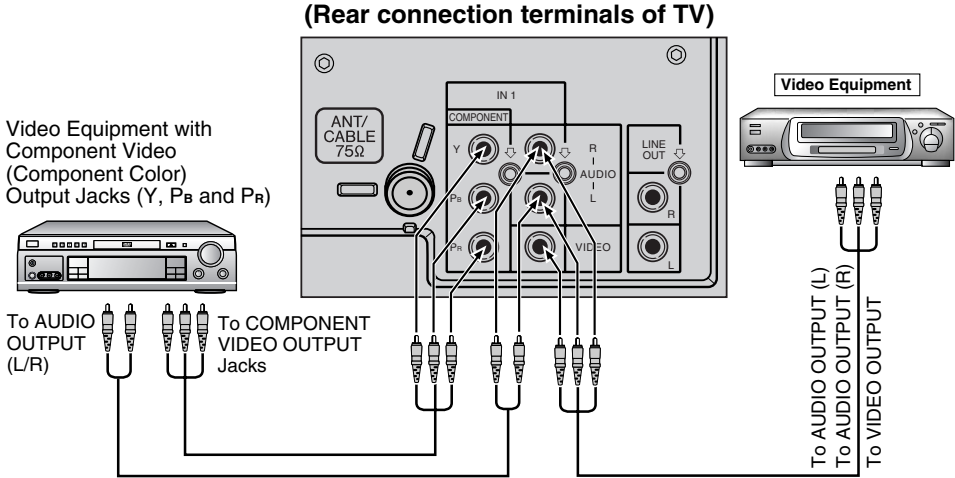

■ To watch video material playback.

- Press the Remote's **INPUT** button to select the VIDEO INPUT mode for the video equipment you wish to play.
- The external VIDEO INPUT mode will change as follows each time the **INPUT** button is pressed.

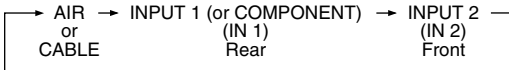

- When the AV cables are being connected to the VIDEO INPUT 1 and COMPONENT Y terminals simultaneously, the COMPONENT terminal has priority over the VIDEO terminal.
- INPUT mode can be selected by pressing either the **CH UP (▲)** on the TV remote control when the TV is set to the highest channel stored in memory, or by pressing the **CH DOWN (▼)** when it is set to the lowest channel.

Note:

- When connecting video or audio equipment to the television, be sure that the power is turned off in order to prevent damage to either the television or the equipment being connected.
- It is the intent of SHARP that this product be used in full compliance with the copyright law of the United States and that prior permission be obtained from copyright owners whenever necessary.
- For detailed information on the connection and use of auxiliary equipment, refer to the instruction manuals of the equipment being used.
- The connection cords can be obtained from your local video store.





Using the Audio Output Jacks

- These jacks are used for connecting an external audio amplifier. The STEREO/MONO/SAP, VOLUME, MUTE and FAO functions can all be controlled via the television's remote control or directly on the TV itself. These jacks relay the audio signal of all programs being displayed on the TV screen.

(AUDIO OUTPUT JACKS are located on the rear of the cabinet.)

CONNECTIONS

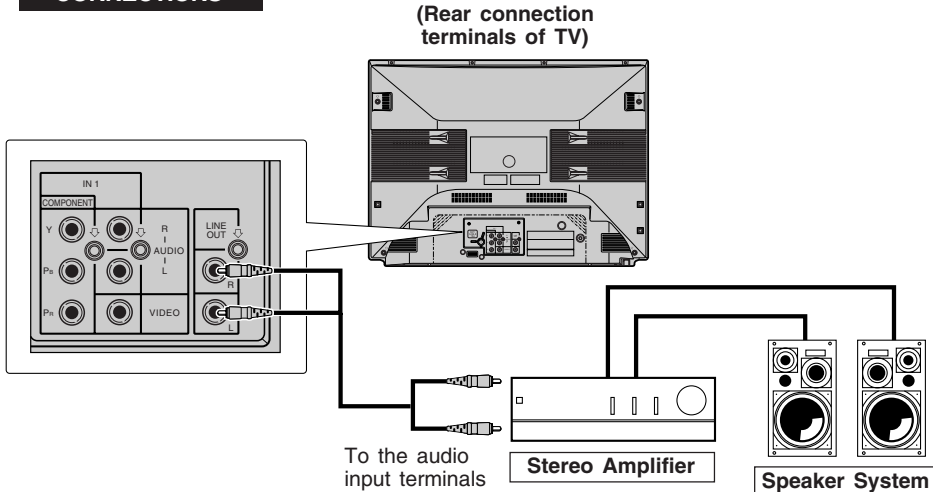

- Before connecting the cables, turn on the TV and adjust the VOLUME control on the TV to a moderate listening level.
- Turn off the TV and connect the audio cables to the AUDIO LINE OUTPUT JACKS on the TV.
- Turn the TV set and stereo amplifier on.
- If you desire, you can turn off the sound to the TV's internal speakers by accessing the TV's AUDIO SELECT mode. See page 22 ~ 23.
- Adjust the VOLUME control on the stereo amplifier for a moderate listening level.
- Control of the audio can be adjusted using the audio controls (STEREO/MONO/SAP, VOLUME, MUTE and FAO), from either the remote control, or directly from the TV set.

Note:

- For detailed information on the connection and use of auxiliary equipment, refer to the operation manuals of the equipment being used.
- When connecting monaural equipment to the AUDIO INPUT or OUTPUT of this set, use an audio connection cord and plug adaptor as shown below.
- For optimal sound quality, we recommend you to keep the TV's audio output level high.

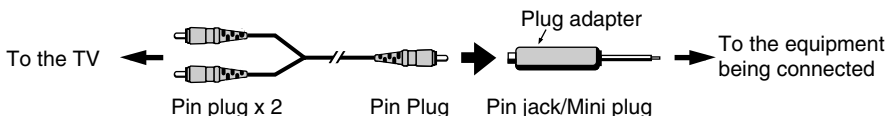



Operation of Remote Control

■ Universal Remote Control

With the purchase of your television set you also have received the latest innovation in remote control technology. With its easy-to-use push button keyboard, your Remote can control your television set and most infrared remote controlled VCRs, cable TV converters and DVDs as well.

Note:

- Depending on the model, year produced, brand and type of VCR, cable TV converter and DVD, some models may not be compatible with the remote control.
- Some brands may not enable channel selection until the ENTER button is pressed.

Example:

When you select channel 24,

- (1) Press REMOTE KEYPAD "2".
- (2) Press REMOTE KEYPAD "4".
- (3) Press ENTER.

For detailed information on the use of the Cable TV converter Box refer to their operating manuals.

■ Using Your Remote With Your TV

After installing the batteries, press the **TV/VCR** on the remote to select the TV mode. (If you can change the channel of the TV by pressing **CH UP (▲)** or **DOWN (▼)** on the Remote Control, it is the TV mode.)

■ "Identifying" Remote VCRs, cable TV converters and DVDs

Your Remote Control has been set at the factory to operate your TV and many remote control VCRs, cable TV converters and DVDs. However, in some cases an easy one-time set-up step may be necessary before the Remote will operate accessory VCRs, cable TV converters and DVDs.

- In this set-up step, the Remote locates and memorizes the remote control transmitter code for the VCR, cable TV converters and DVDs.
- Once "identified", the Remote sends the proper remote signals to operate your accessory.
- This identify step will not have to be repeated until power to the Remote is interrupted due to a battery failure.

■ USING YOUR REMOTE CONTROL WITH A VCR

Once you make certain the Remote Control has "identified" your remote controlled VCR or DVD, the Remote Control is ready to operate your unit. The various VCR or DVD function buttons on the Remote Control will not operate your VCR or DVD if those features are not already found on your unit.

- All VCR buttons will operate whether the Remote Control is in TV or VCR modes.
- For detailed information on the use of the VCR or DVD, refer to the operation manual of the VCR or DVD.

PLAY ▶

Press to playback a tape or disc.

POWER (DVD/VCR)

Press to turn the VCR or DVD on and off.

REWIND ◀◀

Press to rewind a tape or reverse a disc. For some VCRs or DVDs you may need to press STOP first, then REWIND.

STOP ■

Press to stop the tape or disc.

PAUSE II

Press to temporarily stop the tape or disc during playback or recording (VCR only). Press again to release Pause.

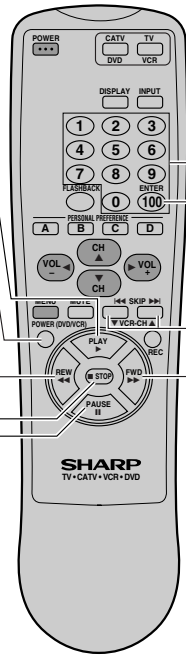

REMOTE KEYPAD

Use to enter two-digit code numbers when identifying your VCR.

ENTER

VCR CHANNEL UP (▲)/DOWN (▼)
Press to scan up or down through channels on the VCR.

DVD SKIP

Press to jump forward to the beginning of the next chapter/track, or backward to the beginning of the current chapter/track, and automatically start to play that chapter/track.

FF ▶▶

Press to rapidly advance the tape or disc. For some VCRs or DVDs, you may need to press STOP first, then FF.



Operation of Remote Control (Continued)

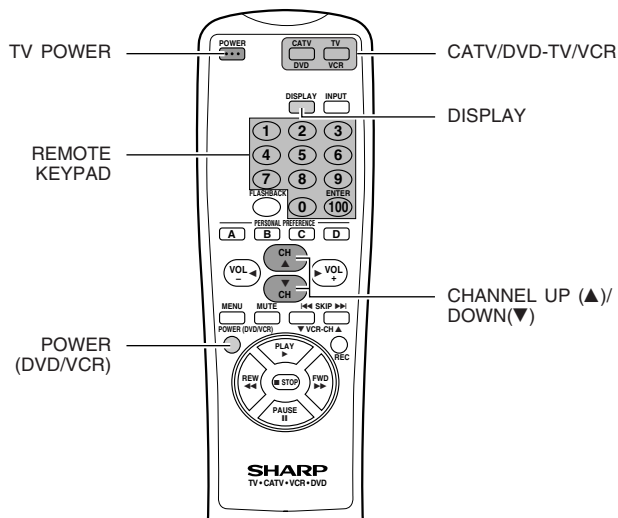

■ HOW TO IDENTIFY A VCR

The remote control may already be set to operate your VCR. Try this initial check before going on to the following "identify" section.

- (1) Press **TV/VCR** button.
- (2) Point remote towards VCR and press **POWER (DVD/VCR)**.
- (3) Does the remote turn the VCR ON and OFF?
 - If yes, the remote is ready to operate the VCR and no further steps are needed.
 - If no, continue to the "identify" section.

■ To Identify Your VCR – Direct Entry Method.

Use the following steps and list to quickly find the remote control code for your accessory VCR.

- First look up your VCR's remote control code number before going through the direct code entry steps control.
- If this procedure does not identify your accessory VCR, use the Search method of identification (described in the next section).

- (1) Press **TV/VCR** button.
- (2) Press and hold down **DISPLAY** and **CH DOWN (▼)** on your remote control. Then release both buttons.
- (3) Within ten seconds after releasing **DISPLAY** and **CH DOWN (▼)**, enter your VCR's two-digit remote control code number using the **REMOTE KEYPAD** (refer to list).
 - The remote control is now ready to send commands to your VCR.

Some brands have more than one remote code listed, due to changes in the remote codes from early to later model years, or due to format differences (VHS/BETA). In such cases, you may have to try more than one code to find the code your VCR accepts.

Note:

Depending on the model, year produced, brand, and type of VCR, some models may not be compatible with the remote control.

■ To Identify Your VCR – Search Method.

- (1) Press **TV/VCR** button.
- (2) Press **POWER** on the VCR to ON.
- (3) Stand at least six feet away from the front of the VCR.

Point the remote towards the VCR.

Hold down **DISPLAY** and **CH UP (▲)** at the same time. KEEP HOLDING THE BUTTONS DOWN.

- (4) Watch the Channel Number indicator on the VCR, Channel numbers will scan up when the VCR has been identified.

Release **DISPLAY** and **CH UP (▲)** as soon as the channel numbers start to scan up.

The VCR's remote control code number has been identified, and the remote is ready to operate the VCR.



Operation of Remote Control (Continued)

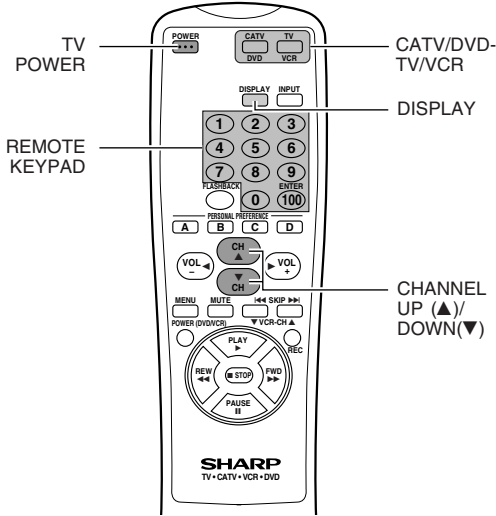

TIPS ON IDENTIFYING YOUR VCR:

If your VCR model does not have the CHANNEL UP function on its remote control, it cannot be identified using the SEARCH method for identifying. For such models, please try the DIRECT ENTRY method of identifying.

Be Patient: a minute or two can seem a lot longer when you're waiting for something to happen, but the code should be identified within 2 minutes. Remember, it is only a one-time set-up.

Be careful not to let the VCR scan more than five channels when the indicator starts to move up. If you continue holding down the **DISPLAY** and **CH UP (▲)** after five channel scans, the proper remote code can be passed up, and the two minutes identify cycle will have to be repeated.

If a channel change does not occur on the VCR within two minutes, read the identifying instructions again and repeat the steps. Should a channel change still not occur the remote will not operate with the desired VCR.

VCR BRAND	REMOTE CONTROL CODE NUMBER
Akai	25, 26, 37
Audio Dynamics	15, 22, 30
Broksonic	32
Canon	04
Capehart	34
Craig	10, 31
Curtis Mathis	04
Daewoo	34
DBX	15, 22, 30
Dynatech	29
Emerson	21, 32, 35
Fisher	09, 10, 11
Funai	28, 29
GE	04
Goldstar	24
Hitachi	06
Instant Replay	04
JC Penney	04, 06, 24, 30
JVC	15, 41, 42
Kenwood	14, 15
Lloyds	29
Magnavox	04, 05, 08
Magnin	31
Marantz	30
Memorex	04, 10, 24, 29
Minolta	06
Mitsubishi	17, 18, 39, 40
Montgomery Ward	02, 43
Multitech	29
NEC	15, 22, 30
Panasonic	04, 44
Pentax	05, 06
Philco	04, 05
Philips	04, 05, 08
Quasar	04
RCA	06, 07, 33
Realistic	01, 02, 10, 24
Samsung	23, 31
Sanyo	14, 10
Scott	20
Sears	06, 11, 24
Sharp	01, 02, 03
Shintom	36
Sony	12, 13, 38
Sound Design	29
Sylvania	04, 05, 08
Symphonic	29
Tatung	15
Teac	15, 29
Teknika	27, 29
Thomas	29
TMK	21
Toshiba	19, 20
Video Concepts	30
Yamaha	15, 29, 30
Zenith	16



Operation of Remote Control (Continued)

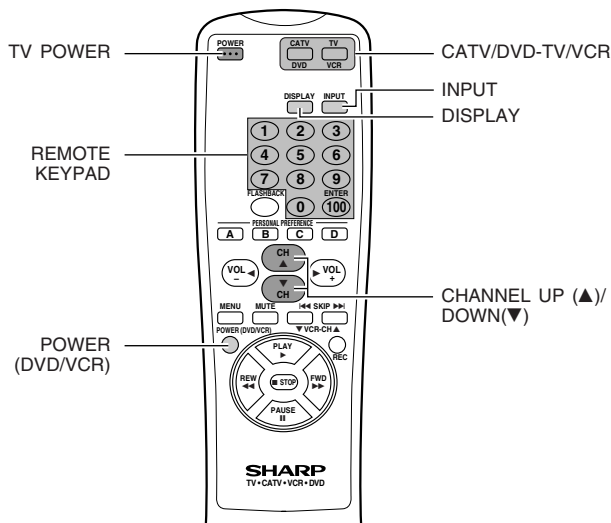

■ HOW TO IDENTIFY A DVD

The remote control may already be set to operate your DVD. Try this initial check before going on to the following "identify" section.

- Press **CATV/DVD** button.
- Point remote towards DVD and press **POWER (DVD/VCR)**.
- Does the remote turn the DVD ON and OFF?
 - If yes, the remote is ready to operate the DVD and no further steps are needed.
 - If no, continue to the "identify" section.

■ To identify your DVD – Direct Entry Method.

Use the following steps and list to quickly find the remote control code for your accessory DVD.

- First look up your DVD's remote control code number before going through the direct code entry steps control.
- Press **CATV/DVD** button.
 - Press and hold down **INPUT** and **CH DOWN (▼)** on your remote control. Then release both buttons.
 - Within ten seconds after releasing **INPUT** and **CH DOWN (▼)**, enter your DVD's two-digit remote control code number using **REMOTE KEYPAD** (refer to list).
 - The remote control is now ready to send commands to your DVD.

DVD BRAND	REMOTE CONTROL CODE NUMBER
Denon	02
JVC	09
Magnavox	04
Marantz	04
Mitsubishi	06
Panasonic	02
Philips	04
Pioneer	08
Proscan	03
RCA	03
Samsung	07
Sharp	01, 10
Sony	05
Toshiba	04
Yamaha	02
Zenith	04

Note:

Depending on the model, year produced, brand, and type of DVD, some models may not be compatible with the remote control.



Operation of Remote Control (Continued)

■ HOW TO IDENTIFY A CABLE CONVERTER

■ To Identify Your Cable Converter –Direct Entry Method.

Use the following steps and list to quickly find the remote control code for your cable TV converter.

- First look up your converter's remote code number before going through the direct code entry steps below.
- If this procedure does not identify your converter, use the Search method for identification.

- (1) Press **CATV/DVD** button.
- (2) Press and hold down **DISPLAY** and **CH DOWN (▼)** on your remote control. Then release both buttons.
- (3) Within ten seconds after releasing **DISPLAY** and **CH DOWN (▼)**, enter your converter's two-digit code number using **REMOTE KEYPAD** (refer to list).

- The remote control is now ready to send commands to your converter.
- Some brands have more than one remote code listed due to changes in the remote codes from early to later model years. In such cases, you may have to try more than one code to find the code your converter accepts.

Note: ➤

Depending on the model, year produced, brand, and type of CATV converter, some models may not be compatible with the remote control.

■ To Identify Your Cable Converter – Search Method.

- (1) Press **CATV/DVD** button.
- (2) Press the POWER button on the cable converter to ON.
- (3) Stand at least six feet away from the converter. Point the remote towards the converter. Hold down the **DISPLAY** and **CH UP (▲)** at the same time. KEEP HOLDING THE BUTTONS DOWN.
- (4) Watch the Channel Number indicator on the converter. Channel numbers will scan up when the converter has been identified. Release the **DISPLAY** and **CH UP (▲)** as soon as the channel numbers start to scan up. The converter's remote control code number has been identified, and the remote is ready to operate the converter.

CATV CONVERTER BRAND	REMOTE CONTROL CODE NUMBER
Anvision	07, 08
Cable Star	07, 08
Eagle	08
General Instrument	04, 05, 15, 23, 24, 25, 30, 36
Jerrold	04, 05, 15, 23, 24, 25, 30, 36
Magnavox	07, 08, 19, 25, 28, 29, 32, 33, 40, 41
Oak Sigma	18
Panasonic	27, 39
Philips	07, 08, 19, 26, 28, 29, 32, 33, 40, 41
Pioneer	18, 20
Randtek	07, 08
RCA	27, 43
Scientific Atlanta	03, 22, 42
Sony	44
Viewstar	07, 08, 19, 26, 28, 29, 32, 33, 40, 41
Zenith	14

TIPS ON IDENTIFYING YOUR CABLE CONVERTER:

Be Patient: a minute or two can seem a lot longer when you're waiting for something to happen, but the code should be identified within 2 minutes. Remember, it is only a one-time set-up.

Be careful not to let the CATV converter scan more than five channels when the indicator starts to move up. If you continue holding down the **DISPLAY** and **CH UP (▲)** after five channel scans, the proper remote code can be passed up, and the two minute identify cycle will have to be repeated.

If a channel change does not occur on the cable converter within two minutes, read the identifying instructions again and repeat the steps. Should a channel change still not occur, the remote will not operate with the desired converter.

Note: ➤

Some satellite receivers can be operated by the REMOTE CONTROL. If you have a Satellite Receiver, you can use the above method to search for available channels.



Before Calling for Service

Check these items and see if you can correct the trouble with a slight adjustment of the controls.

QUICK SERVICE CHECK LIST	PROBLEM																	
	No Playback of VCR and Disc Player	No Picture or Sound from External Video/Audio Products	Remote Control Doesn't Work	Bars on Screen	Picture Distorted	Picture Rolls Vertically	No Color	Poor Reception on Some Channels	Weak Picture	Lines or Streaks in Picture	Ghosts in Picture	Picture Blurred	Sound OK, Picture Poor	Picture OK, Sound Poor	No Picture or Sound	Dark and Blank Picture	External Electrical Noise Interfering with TV's Operation	Color on Part of the Screen Appears Distorted
Try a new channel, if OK, then there is possible station trouble.					X	X	X	X	X	X	X	X	X	X	X			
Is TV plugged in? Power at outlet?		X	X													X		
Is TV's POWER button on?		X														X		
Is antenna connected to terminal on the back of the set?							X	X	X		X		X		X			
If outside antenna is being used, check for broken wire.				X	X	X	X	X	X	X	X	X	X		X			
Check for local interference or external electrical noise.				X	X		X		X	X		X	X				X	
Turn off with POWER button and then turn it on after about a minute.		X													X			
Adjust COLOR control.							X											
Adjust PICTURE control.									X				X					
Check external Video/Audio products: look for loose/broken connection leads. (Refer to page 44 ~ 45)	X	X											X	X	X			
Check batteries of Remote Control.			X															
Press TV/VCR button on the remote to select TV mode.			X															
Are audio cables connected firmly? Check the volume level.															X			
Is SPEAKER ON ? See page 22 ~ 23.															X			
Change CLOSED CAPTION mode to "OFF" / ENERGY SAVE mode to "OFF".																X		
Unplug the TV and plug it in again after two minutes or longer.			X		X	X	X	X					X	X	X	X	X	X

Note:

- When viewing in **TEXT** mode, if no **TEXT** broadcast is being received, the screen may become dark and blank. Should this occur, set the **CLOSED CAPTION** mode to "OFF".



(Dark and Blank Picture)

Calling for Service

For location of the nearest Sharp Authorized Servicer, or to obtain product literature accessories, supplies, or customer assistance, please call 1-800-BE-SHARP.



(ESPAÑOL)

Antes de llamar al servicio de reparaciones

Verifique estos puntos para ver si usted mismo puede solucionar el problema.

LISTA DE COMPROBACIONES DE SERVICIO RAPIDO	PROBLEMA																	
	El video o el reproductor de discos de video no reproducen imágenes	El equipo de video/audio externo no produce imágenes ni sonido	El mando a distancia no funciona	Barras en la pantalla	Imagen distorsionada	La imagen se desplaza verticalmente	No hay color	Malta recepción de algunos canales	Imagen débil	Franjas en la imagen	Imagen fantasma	Imagen borrosa	Sonido adecuado, imagen mala	Imagen adecuada, sonido malo	No hay imagen ni sonido	Imagen oscura y en blanco	Interferencia de ruido eléctrico externo con el funcionamiento del televisor	El color se ve distorsionado en parte de la pantalla
POSIBLE SOLUCIÓN																		
Pruebe con otro canal y si todo está bien, el problema puede ser de la emisora.				X	X	X	X	X	X	X	X	X	X	X	X			
Está conectado el televisor? Llega electricidad al tomacorrientes?	X	X													X			
Está conectado el interruptor POWER del televisor?	X														X			
Está conectado la antena al terminal del panel posterior del televisor?						X	X	X		X		X	X					
Si utiliza una antena exterior, cerciórese de que el cable no esté dañado.				X	X	X	X	X	X	X	X	X	X		X			
Compruebe si hay interferencia local.				X	X			X		X	X		X	X			X	
Desconecte el interruptor POWER y vuelva a conectarlo después de transcurrir un minuto.	X														X			
Ajuste el control de COLOR .							X											
Ajuste el control de MATIZ .									X				X					
Verifique los productos externos de Video/Audio, revise si hay conexiones sueltas o rotas. (Ver pág. 44 - 45)	X	X											X	X	X			
Compruebe el estado de las pilas del mando a distancia.			X															
Deslice CATV/DVD-TV/VCR selector para situarlo sobre la posición TV .			X															
Están bien conectados los cables de sonido? Compruebe el nivel del volumen.															X			
Está conectado el altavoz? Ver pág. 22 - 23.															X			
Desactive (OFF) el modo CLOSED CAPTION / Desactive (OFF) el modo AHORRO DE ENERGÍA (Energy Save).																X		
Desenchufe el televisor y vuelva a enchufarlo después de dos minutos o más.			X		X	X	X	X					X	X	X	X	X	

Nota:

- Cuando se ve en modo **TEXTO** sin recibir emisiones de **TEXTO**, la pantalla puede ponerse en blanco y negro. Si ocurriera ésto, ponga el modo **CLOSED CAPTION** en **OFF**.



(Imagen oscura y en blanco)

Solicitud de servicio técnico

Para la localización del Servicio Técnico Autorizado de Sharp más próximo o para conseguir material de información, repuestos o asistencia técnica, llame a 1-800-BE-SHARP.





(FRANÇAIS)

Avant d'appeler un réparateur

Vérifier les points suivants afin de déterminer s'il est possible de remédier au problème par un simple réglage des commandes.

LISTE DES VÉRIFICATIONS POUR UN DÉPANNAGE RAPIDE	PROBLEME																		
	Pas de reproduction d'un magnéscope ou lecteur de disque	Pas d'image ou de son d'un appareil vidéo/audio externe	La télécommande ne fonctionne pas	Barres sur l'écran	Distorsion de l'image	L'image défile verticalement	Pas de couleur	Faible réception de certains canaux	Image affaiblie	Lignes ou rayures dans l'image	Images fantômes	Image brouillée	Son normal, image médiocre	Image normale, son médiocre	Ni son, ni image	Image sombre et vide	Bruit électrique extérieur interférant avec le fonctionnement du téléviseur	Couleur sur une partie de l'écran semble altérée	
SOLUTION POSSIBLE																			
Essayer un nouveau canal. S'il fonctionne, il s'agit probablement d'une panne de la chaîne.					X	X	X	X	X	X	X	X	X	X	X				
Le téléviseur est-il branché? La prise secteur fonctionne-t-elle?		X	X													X			
L'interrupteur POWER du téléviseur est-il sous tension?		X													X				
L'antenne est-elle raccordée aux bornes à l'arrière de l'appareil?							X	X	X		X		X	X					
Si l'antenne extérieure est utilisée, s'assurer qu'il n'y a pas de fils sectionnés.				X	X	X	X	X	X	X	X	X	X		X				
Vérifier s'il n'y a pas d'interférence locale ou de bruit électrique extérieur.				X	X			X	X	X	X	X	X				X		
Mettre l'interrupteur POWER hors tension puis de nouveau sous tension au bout d'une minute.		X													X				
Régler la commande de COULEUR.							X												
Régler la commande de CONTRASTE.									X				X						
Vérifier l'appareil vidéo/audio externe: s'assurer que les câbles de connexion ne sont pas desserrés ou cassés. (Se reporter à la page 44 - 45)	X	X											X	X	X				
Vérifier les piles de la télécommande.			X																
Appuyez sur la touche TV/VCR de la télécommande pour sélectionner le mode TV.			X																
Les câbles audio sont-ils fermement connectés? Vérifier le niveau du volume.															X				
Les haut-parleurs fonctionnent-ils? Voir pages 22 - 23.															X				
Mettre le mode sous-titrage hors service "ARRÊT" / Mode d'économie d'énergie sur "ARRÊT".																X			
Débrancher le téléviseur et le rebrancher après deux minutes.			X			X	X	X	X				X	X	X	X	X	X	X

Remarque:

- En mode TEXTE, s'il n'y a pas d'émission TEXTE à recevoir, l'écran du téléviseur pourrait être sombre et vide. Dans ce cas, placer le mode Sous-titrage hors service.



(Image sombre et vide)

Appel au service après-vente

Pour connaître l'emplacement du centre de service après-vente agréé Sharp le plus proche ou pour obtenir de la documentation sur les produits, des accessoires, des consommables ou une aide au consommateur, appelez le 1-800-BE-SHARP.





Specifications

MODEL	20F630	
Receiving System	NTSC	
Stereo Broadcast	MTS/SAP	
Reception Channels		
AIR	VHF	2-13 ch
	UHF	14-69 ch
CATV	1-125 ch	
Channel Tuning	181-channel Reception PLL tuning system	
Antenna Input Impedance	VHF/UHF 75 ohm Unbalanced	
Screen Size (Visible Area)	21" Diagonally Measured (50.8 cm)	
Terminals	Audio/Video input × 2 (Front x 1, Rear x 1), COMPONENT-IN × 1 (Rear), Audio Output × 1 (Rear)	
Sound Output	2.5 W (RMS) × 2	
Power Source	AC 120 V, 60 Hz	
Power Consumption	90 W	
Dimensions (W) x (H) x (D)	23 ²⁵ / ₆₄ " × 18 ¹ / ₂ " × 19 ³ / ₃₂ " [594 mm × 470 mm × 485 mm]	
Weight (approx.)	56.22 lbs. (25.5 kg)	

- Design and specifications are subject to change without notice.



Limited Warranty

CONSUMER LIMITED WARRANTY

SHARP ELECTRONICS CORPORATION warrants to the first consumer purchaser that this Sharp brand product (the "Product"), when shipped in its original container, will be free from defective workmanship and materials, and agrees that it will, at its option, either repair the defect or replace the defective Product or part thereof with a new or remanufactured equivalent at no charge to the purchaser for parts or labor for the period(s) set forth below.

This warranty does not apply to any appearance items of the Product nor to the additional excluded item(s) set forth below nor to any Product the exterior of which has been damaged or defaced, which has been subjected to improper voltage or other misuse, abnormal service or handling, or which has been altered or modified in design or construction.

In order to enforce the rights under this limited warranty, the purchaser should follow the steps set forth below and provide proof of purchase to the servicer.

The limited warranty described herein is in addition to whatever implied warranties may be granted to purchasers by law. ALL IMPLIED WARRANTIES INCLUDING THE WARRANTIES OF MERCHANTABILITY AND FITNESS FOR USE ARE LIMITED TO THE PERIOD(S) FROM THE DATE OF PURCHASE SET FORTH BELOW. Some states do not allow limitations on how long an implied warranty lasts, so the above limitation may not apply to you.

Neither the sales personnel of the seller nor any other person is authorized to make any warranties other than those described herein, or to extend the duration of any warranties beyond the time period described herein on behalf of Sharp.

The warranties described herein shall be the sole and exclusive warranties granted by Sharp and shall be the sole and exclusive remedy available to the purchaser. Correction of defects, in the manner and for the period of time described herein, shall constitute complete fulfillment of all liabilities and responsibilities of Sharp to the purchaser with respect to the Product, and shall constitute full satisfaction of all claims, whether based on contract, negligence, strict liability or otherwise. In no event shall Sharp be liable or in any way responsible, for any damages or defects in the Product which were caused by repairs or attempted repairs performed by anyone other than an authorized servicer. Nor shall Sharp be liable or in any way responsible for any incidental or consequential economic or property damage. Some states do not allow the exclusion of incidental or consequential damages, so that above exclusion may not apply to you.

THIS WARRANTY GIVES YOU SPECIFIC LEGAL RIGHTS. YOU MAY ALSO HAVE OTHER RIGHTS WHICH VARY FROM STATE TO STATE.

Model Specific Section

Your Product Model Number & Description:

20F630, 20 inch Color Television
(Be sure to have this information available when you need service for your Product.)

Warranty Period for this Product:

One (1) year parts and 90 days labor. The warranty period continues for an additional one (1) year, for a total of two (2) years, with respect to the picture tube(s) in the Product for parts only. Labor and service are not provided free of charge for this additional period.

Additional Item(s) Excluded from Warranty Coverage (if any):

Non-rechargeable batteries.

Where to Obtain Service:

From a Sharp Authorized Servicer located in the United States. To find the location of the nearest Sharp Authorized Servicer, call Sharp toll free at 1-800-BE-SHARP.

What to Do to Obtain Service:

Contact your Sharp Authorized Servicer to obtain in-home service for this Product. The Servicer will come to your home and if it is necessary to remove the Product, the Servicer will reinstall it. Be sure to have **Proof of Purchase** available.

TO OBTAIN ACCESSORY OR PRODUCT INFORMATION, CALL 1-800-BE-SHARP OR VISIT www.sharp-usa.com

SHARP®

SHARP ELECTRONICS CORPORATION

Sharp Plaza, Mahwah, New Jersey 07430-2135

Printed in Mexico
TINS-A725WJZZ
03P05-MMP