

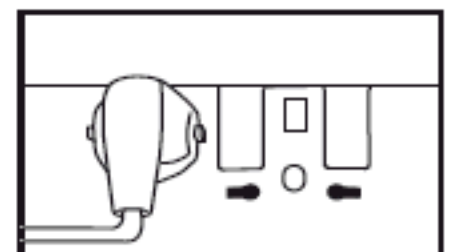

FRY 'N TWIST 1,5KG

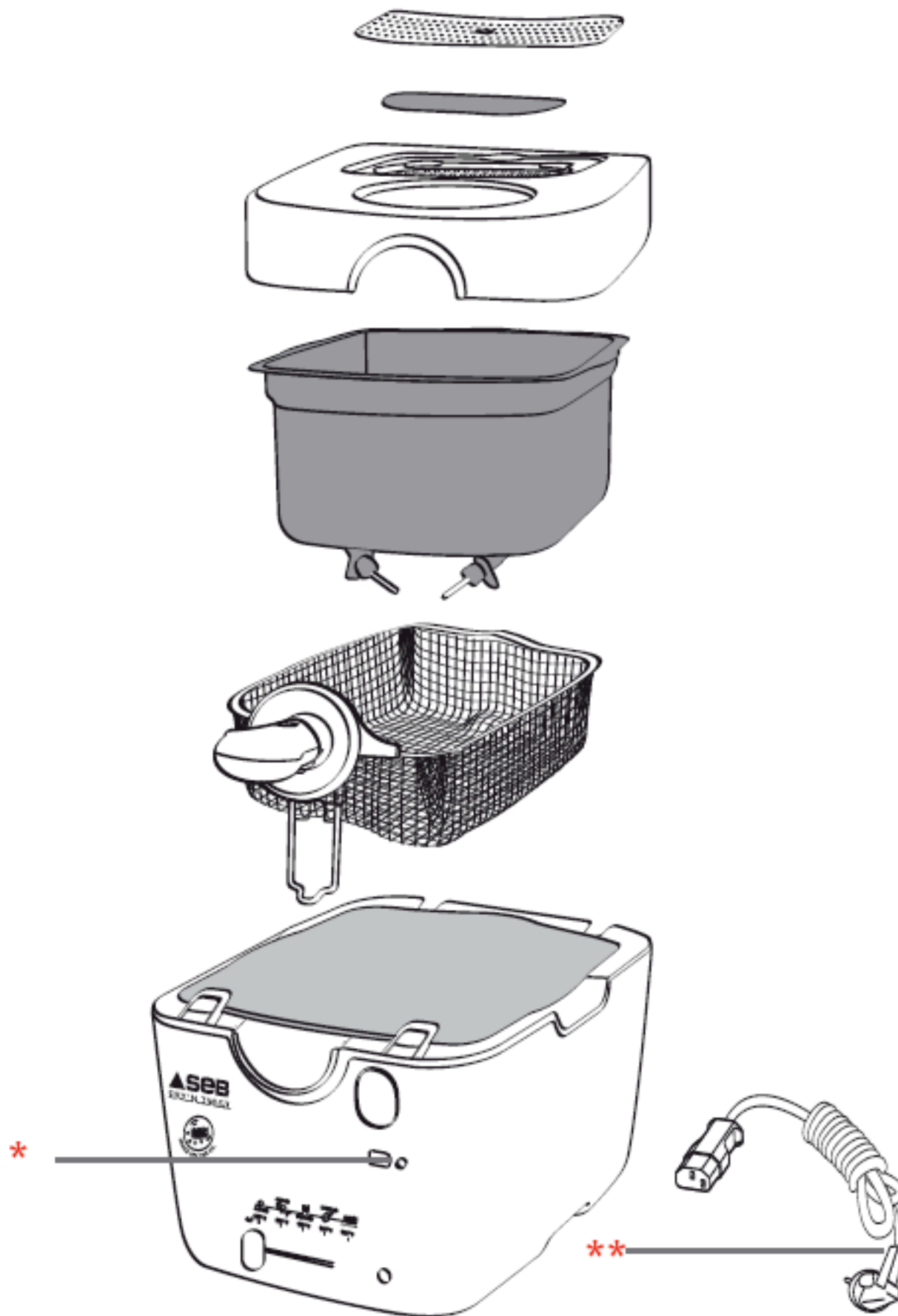



- * Selon modèle • depending on model • Afhankelijk van het model • je nach Modell
- ** Cordon amovible • removable cord • Afneembaar snoer • abnehmbare Zuleitung



1

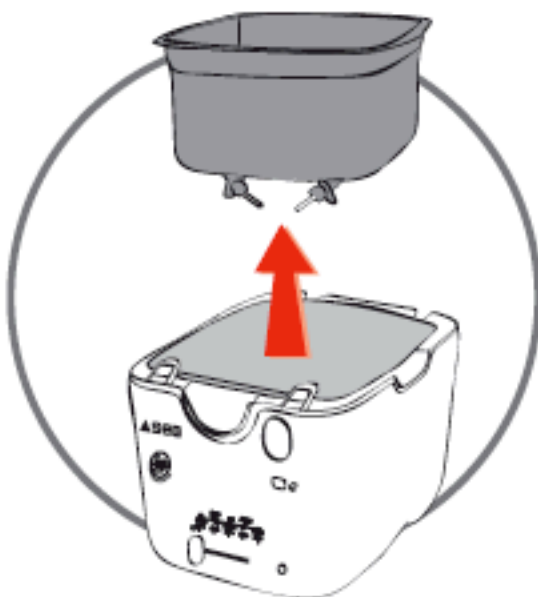
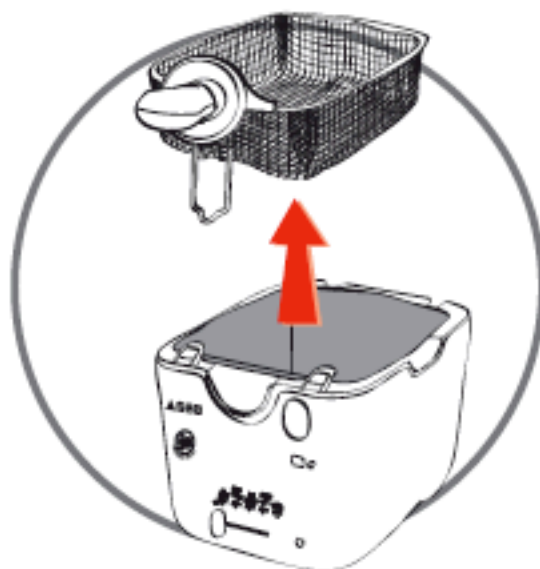
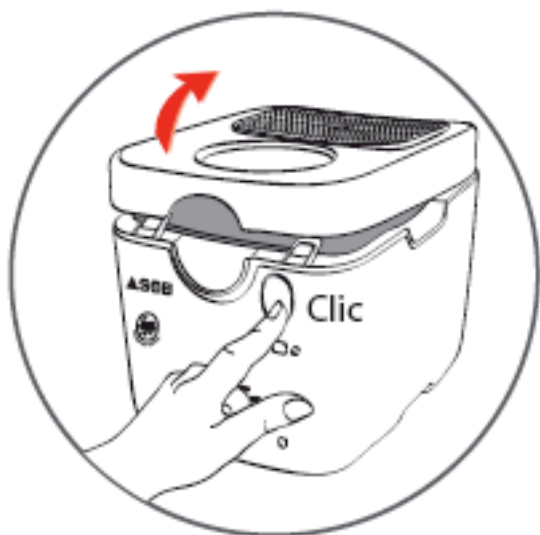

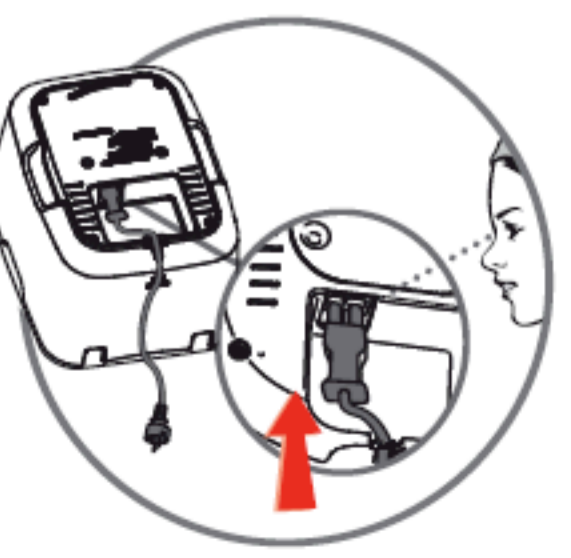
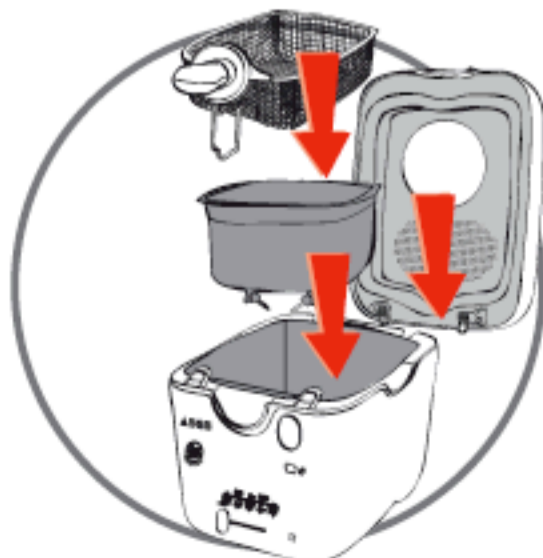
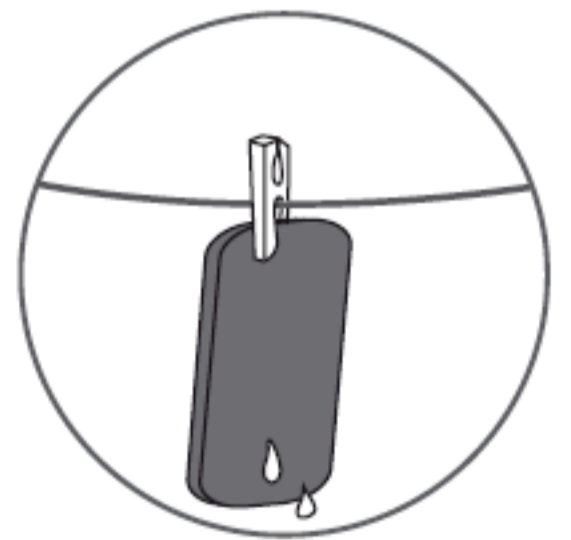
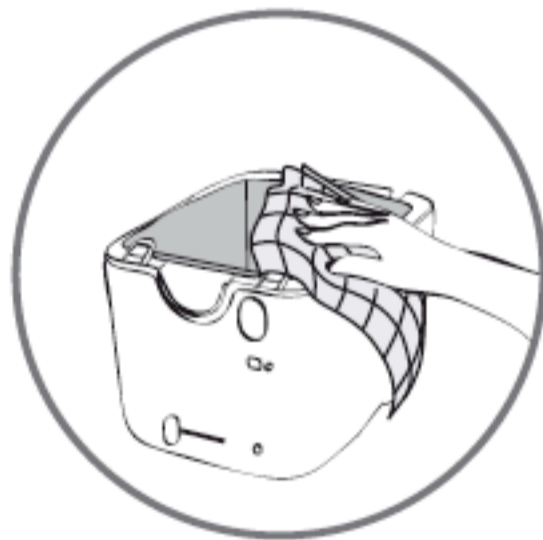
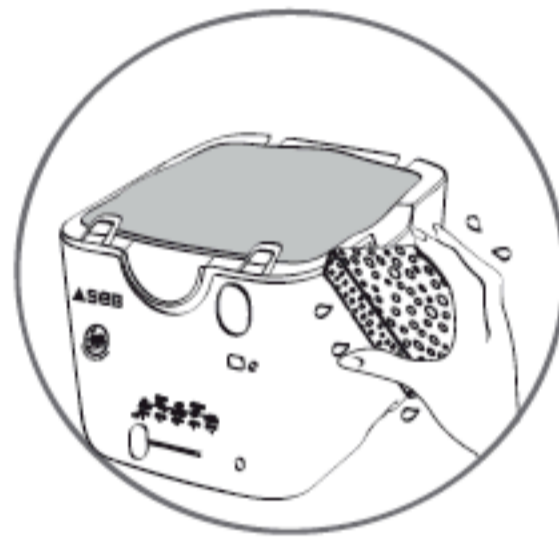



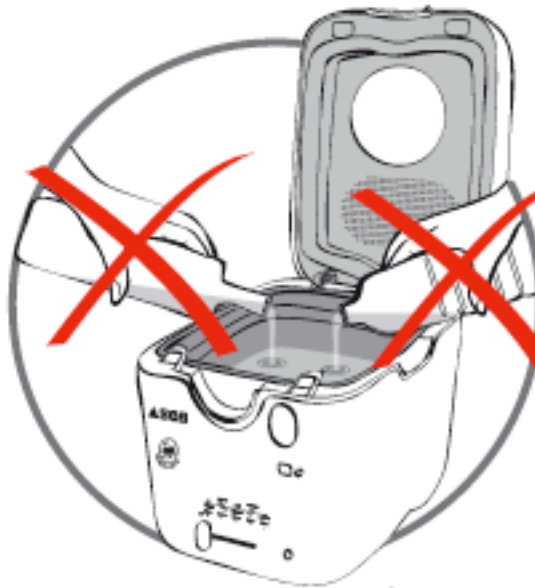
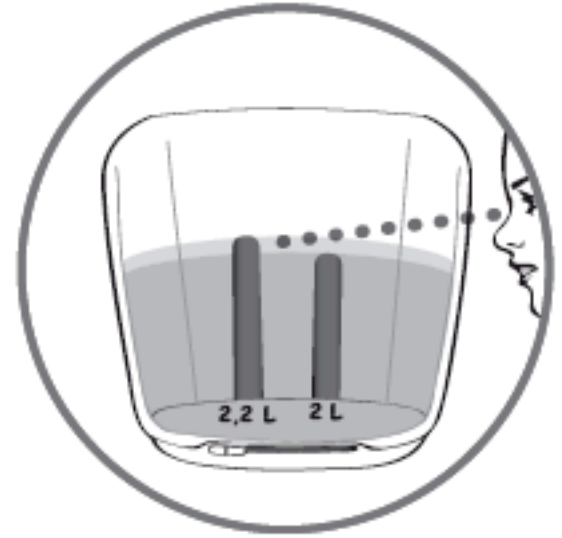
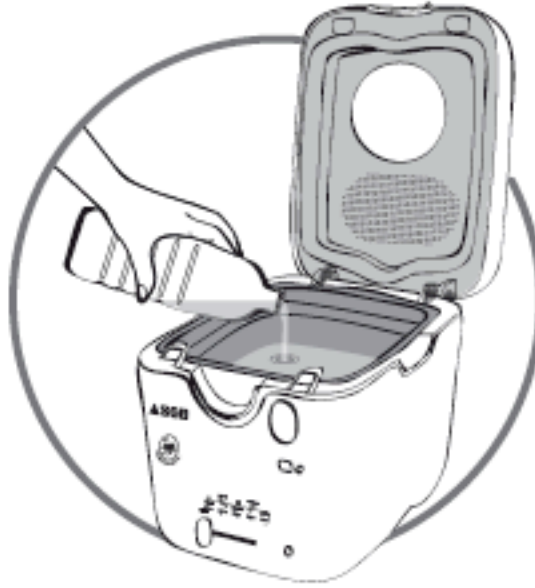

Min	2 L
↓	
Max	2,2 L



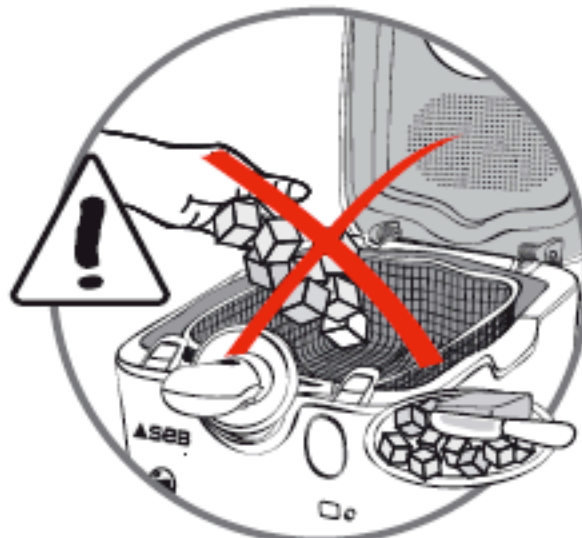
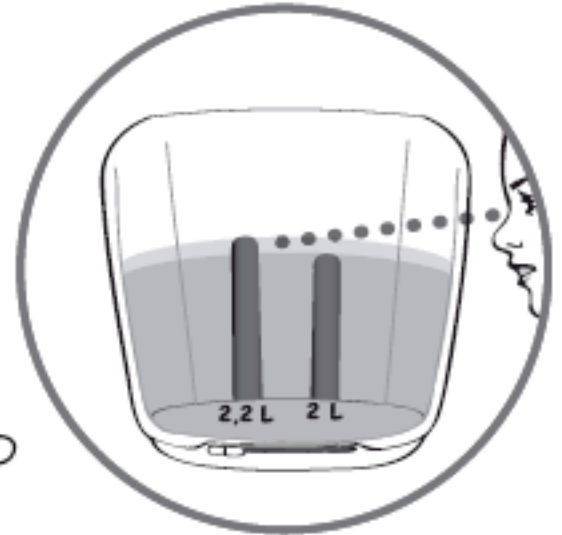
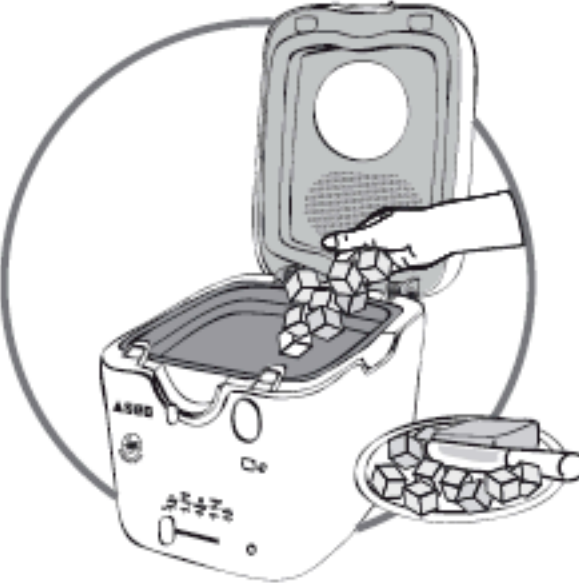

Min	1750 g
↓	
Max	2000 g



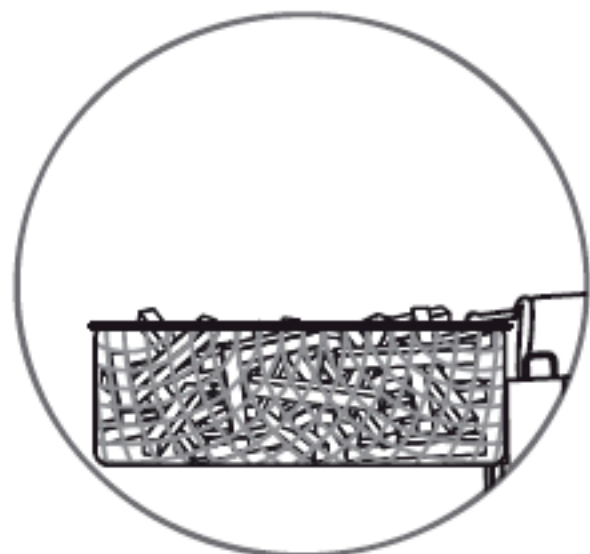

	
Max.	1,4 kg
	700 g





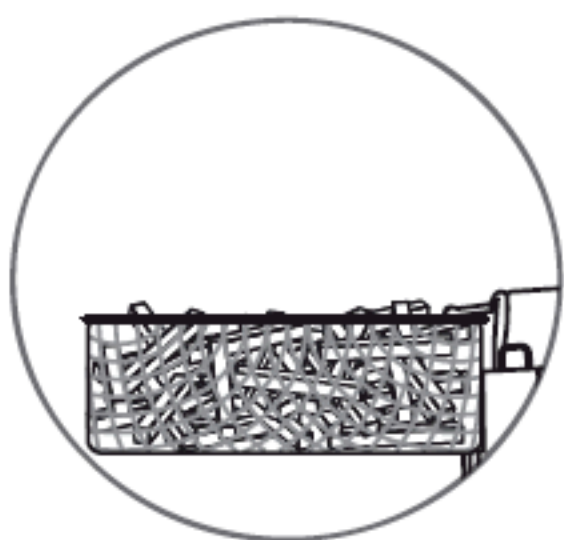

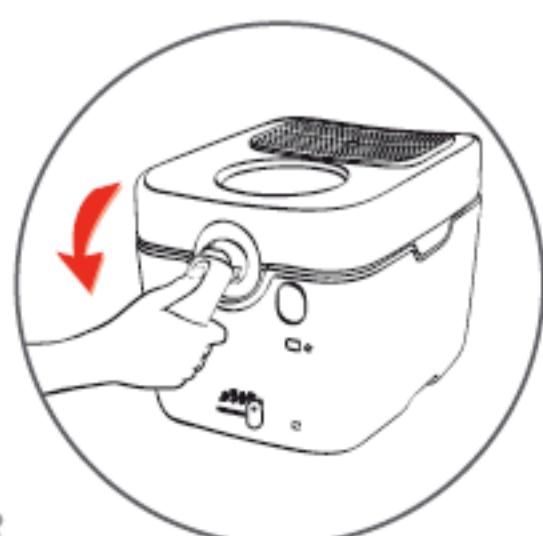
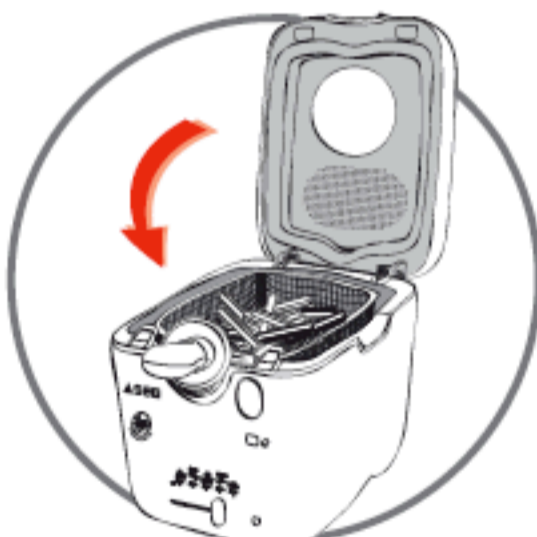
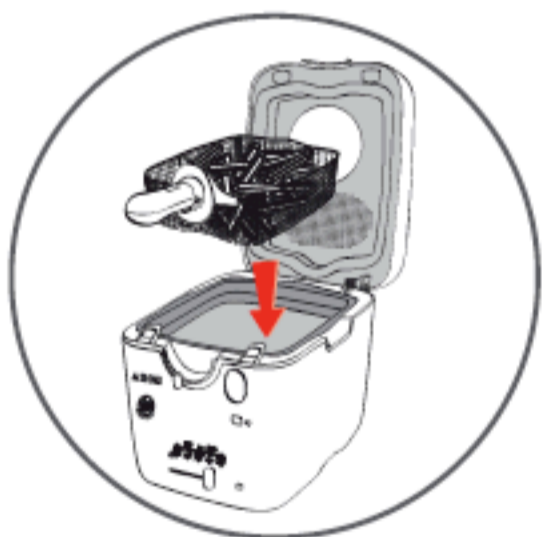
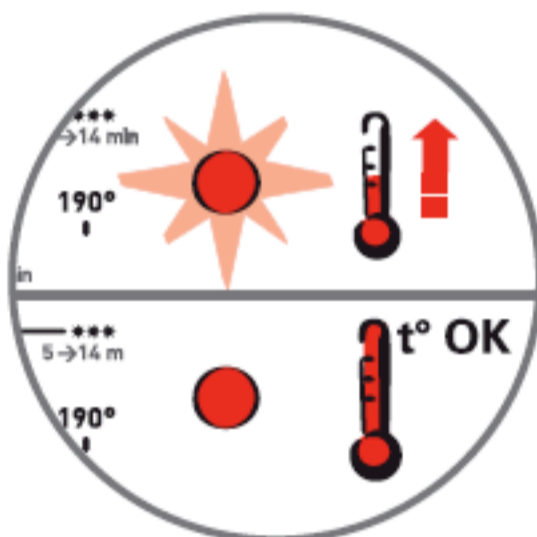
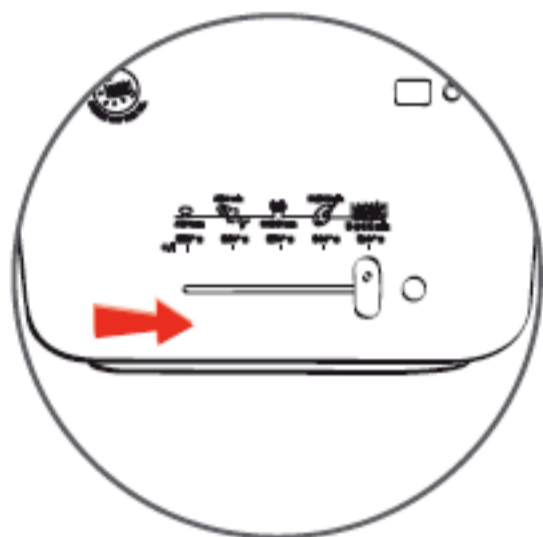
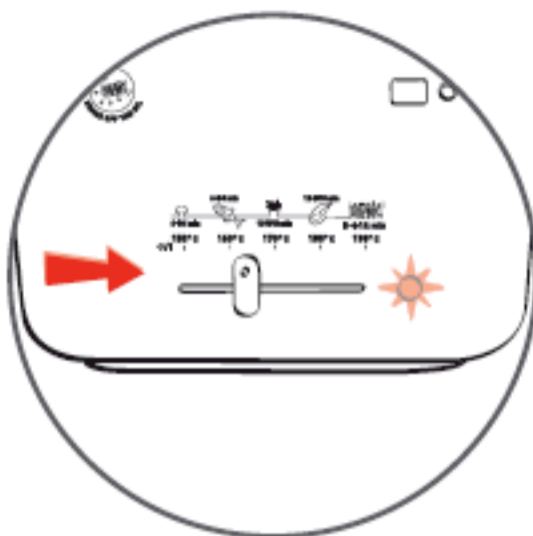
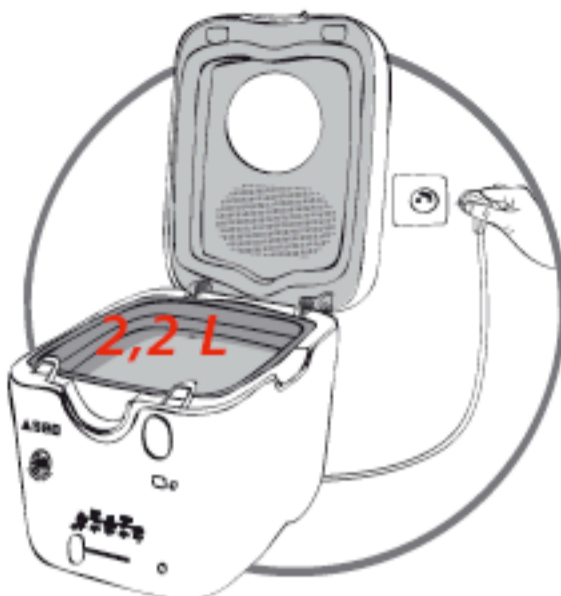
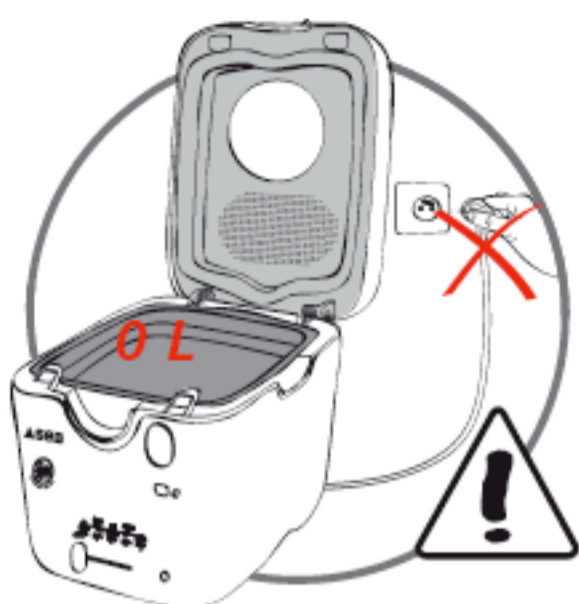



















	
Max.	1 kg
	500 g







7	Nb		 °C	
		1400 g	190°C	+/- 18 - 20 min.
		1400 g	① 160°C ② 190°C	+/- 11 - 14 min. +/- 7 - 9 min.
		700 g	170°C	+/- 11 - 15 min.
	8 - 10		190°C	+/- 9 - 10 min.
	3/4		180°C	+/- 14 - 16 min.
	1 - 2		170°C	+/- 6 - 8 min.
	6		170°C	+/- 3 - 4 min.
		200 g	150 °C	+/- 5 - 7 min.
	10 - 12		180°C	+/- 11 - 13 min.
	4		180°C	+/- 5 - 6 min.
* * *	Nb		 °C	
		1000 g	190°C	+/- 11 - 15 min.
		500 g	170°C	+/- 7 - 10 min.
	8 p		190°C	+/- 5 - 7 min.
	3/4 p		190°C	+/- 14 - 15 min.
		1500 g	190°C	+/- 12 - 16 min.
	12	180 g	190°C	+/- 3 - 4 min.

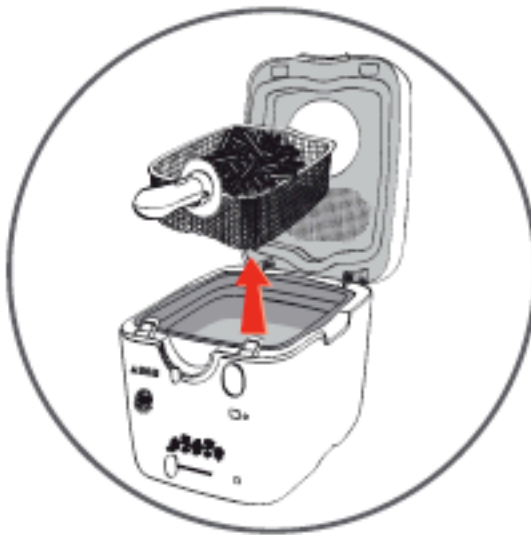
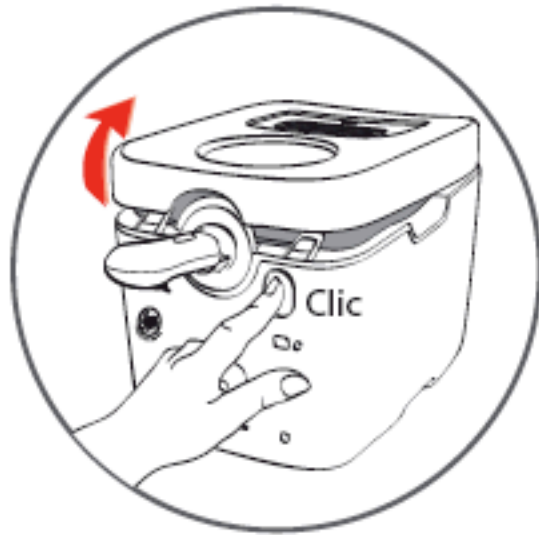
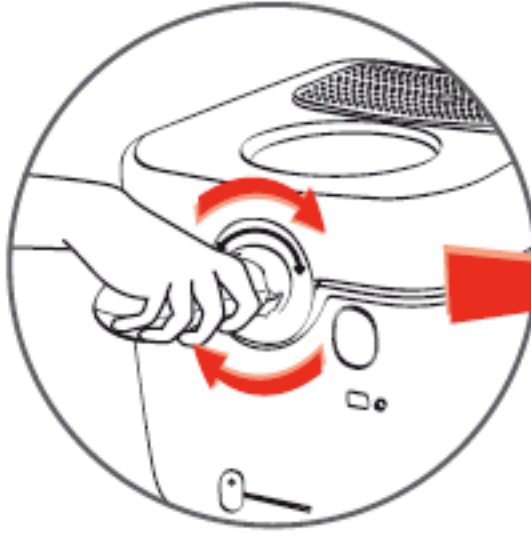
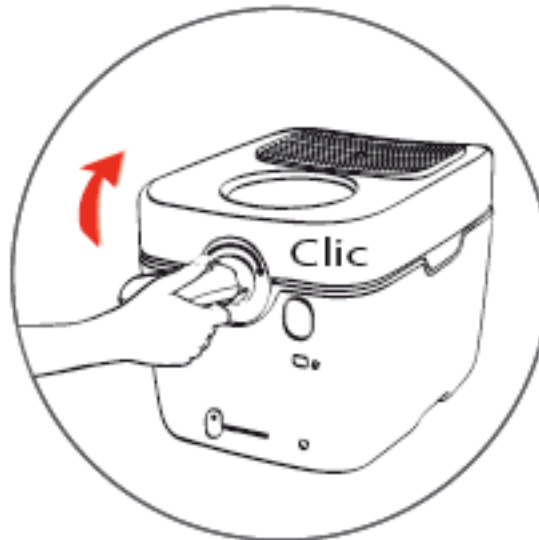
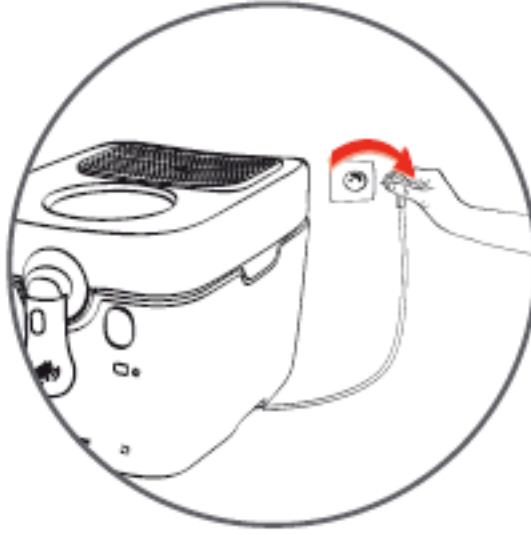
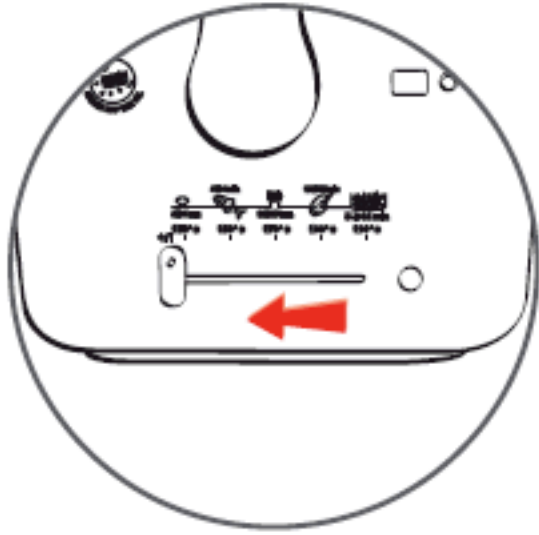

* Secouage des frites, Shake off the oil, Abtropfen des Fetts, Overtollig vet wordt afgeschud.

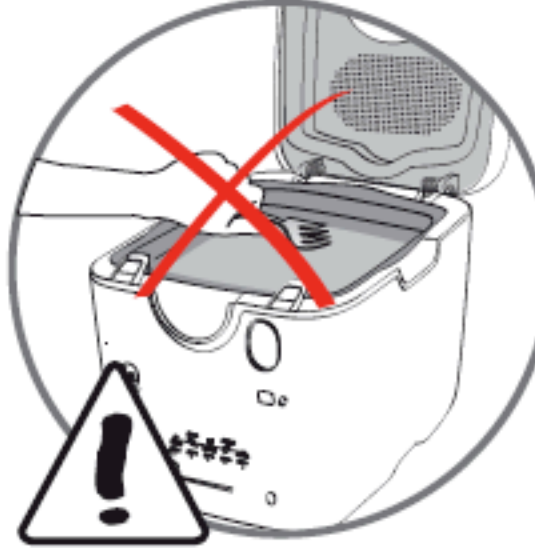

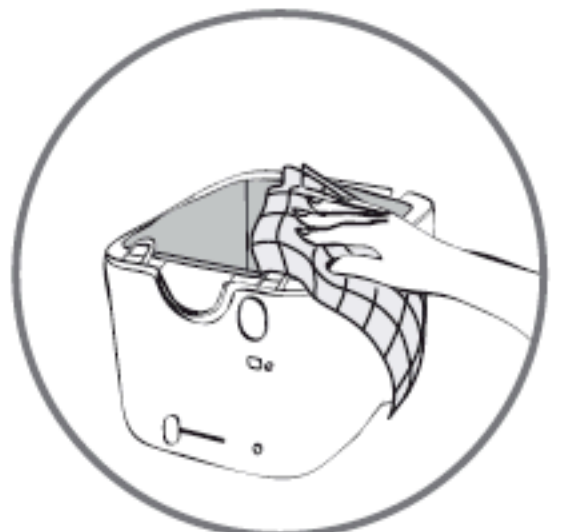
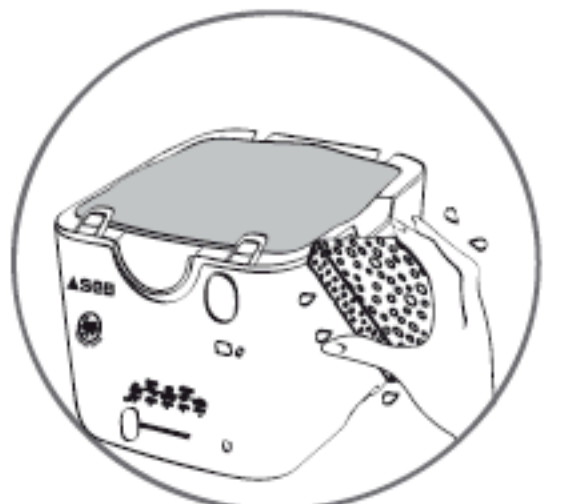
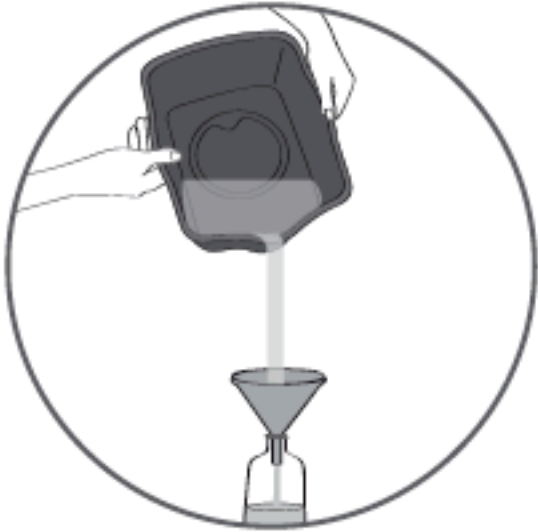
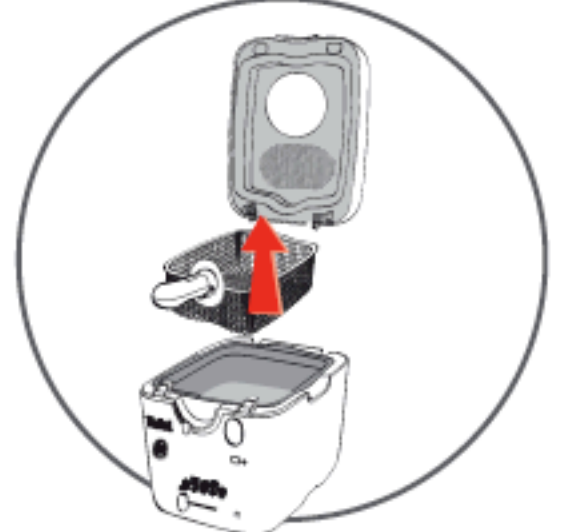
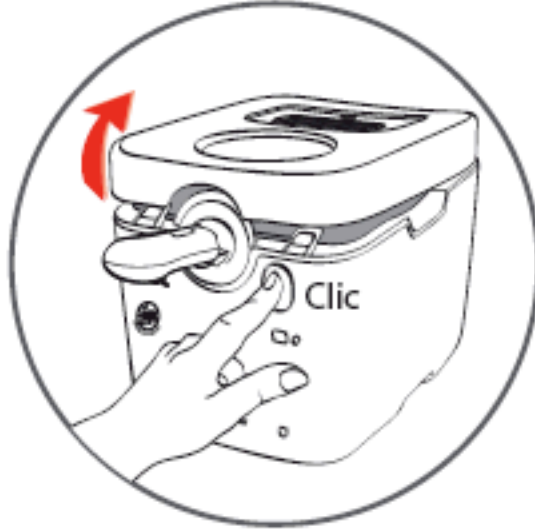

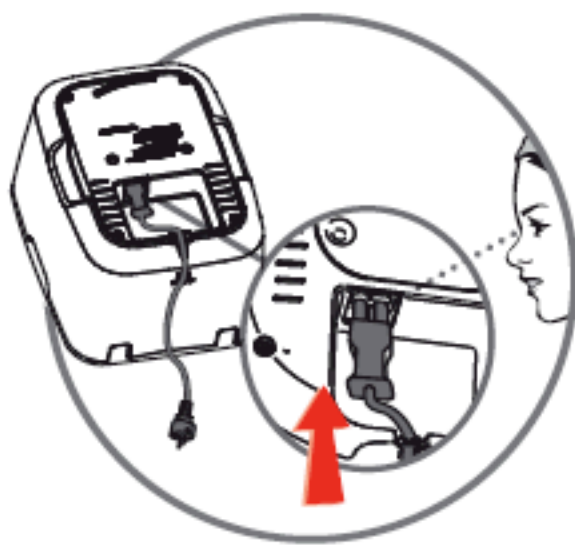
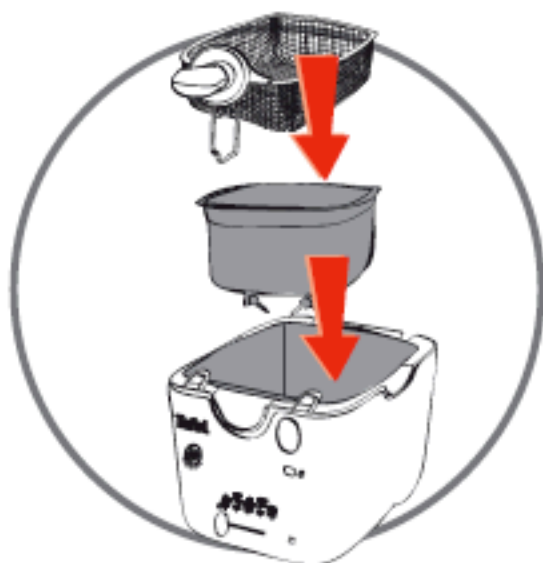
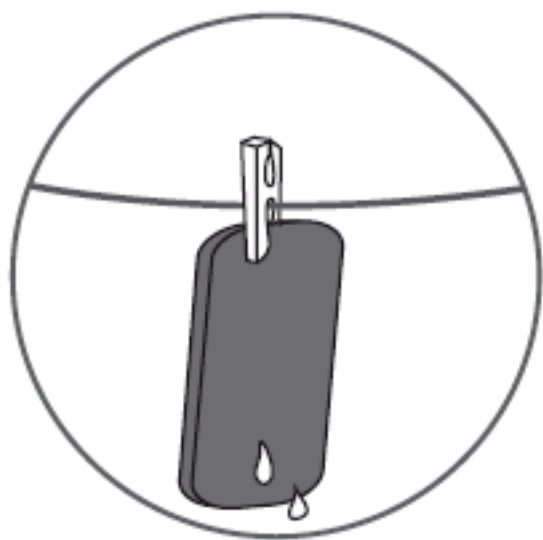

8

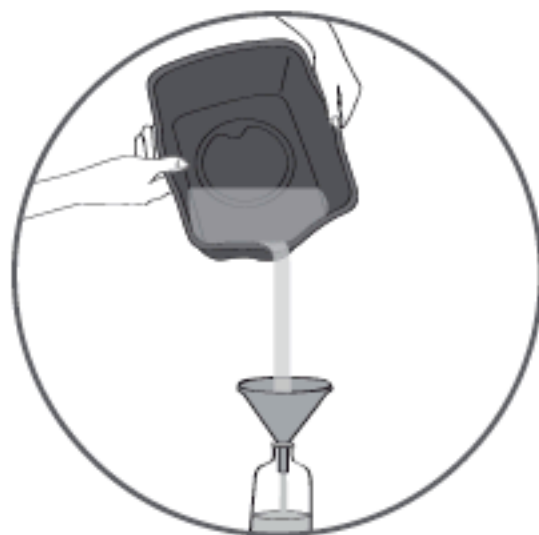

9

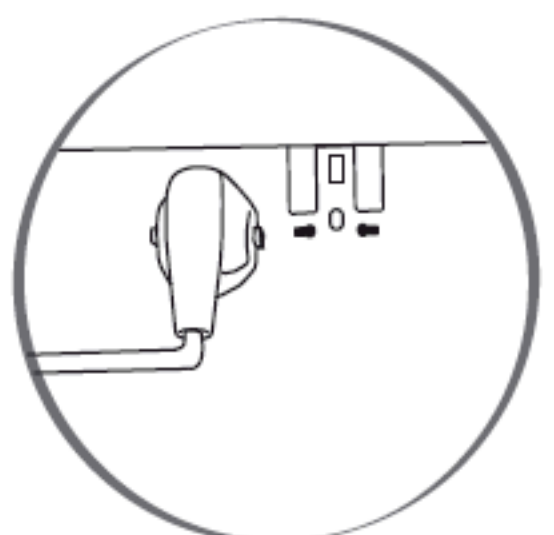
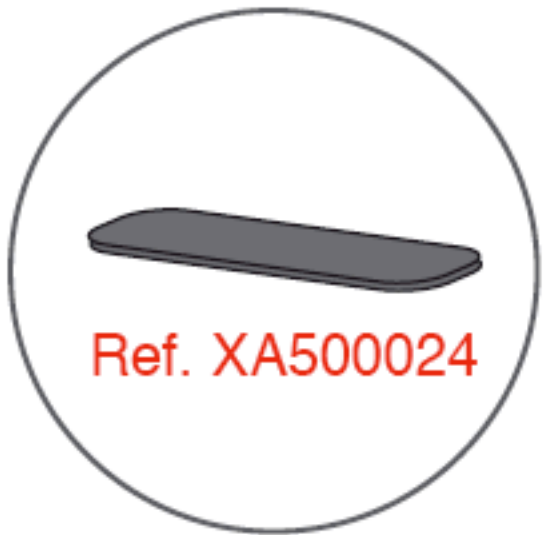

10

