

Fitra

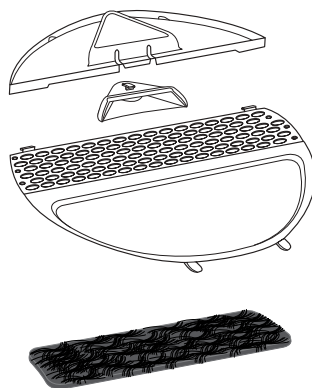

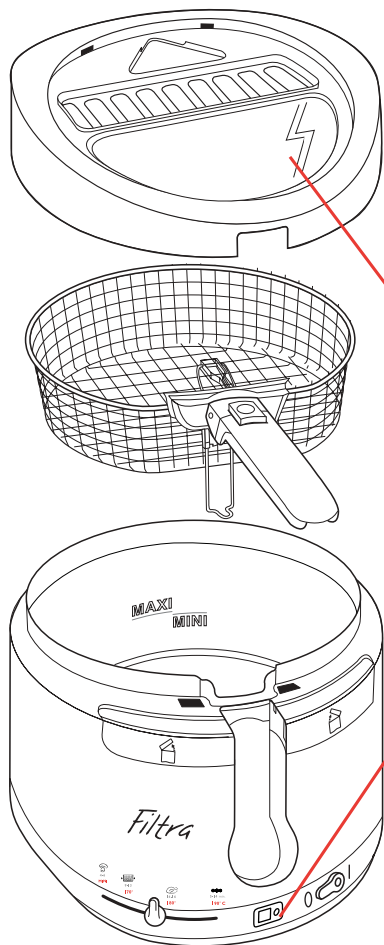

* selon modèle, je nach Modell, niet op alle modellen aanwezig, a seconda del modello, según modelo, conforme o modelo, bazı modellerde, afhængig af model, beroende på modell, kun på noen modeller, mallista riippuen, **ανάλογα με το μοντέλο**, в зависимости от модели, w zależności od modelu, podle modelu, podl'a modelu, modeltöl függően, според модела, حسب الموديل

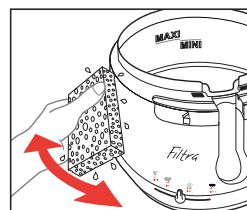
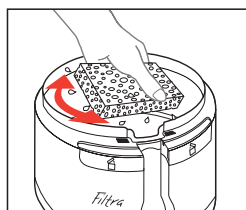
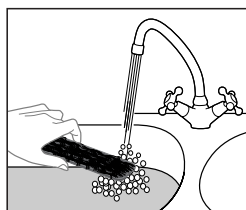
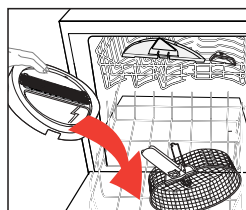
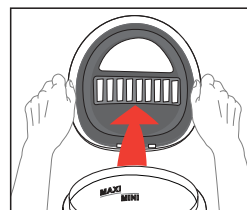
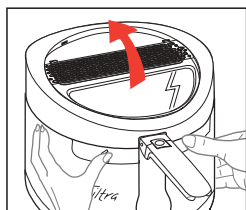
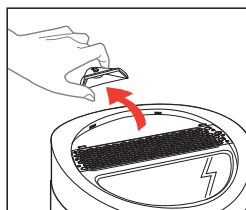
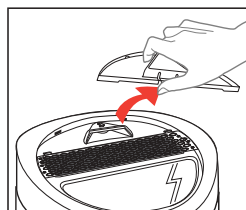
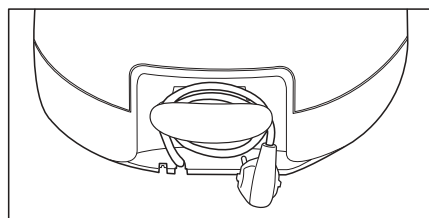

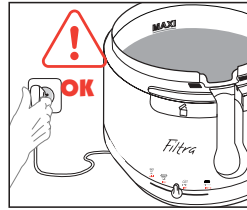
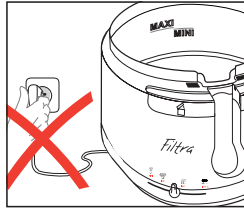
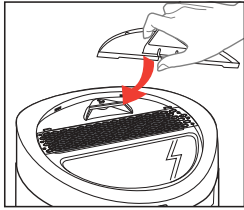
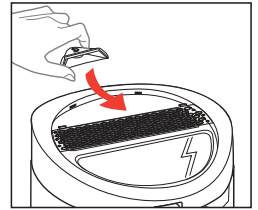
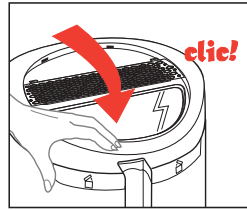
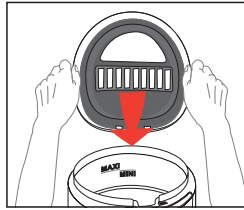
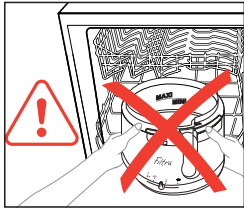

2 -



Min. 1,9 l

Max. 2,1 l

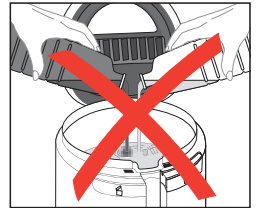
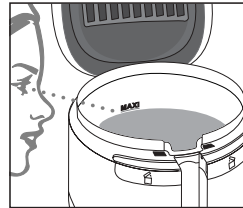
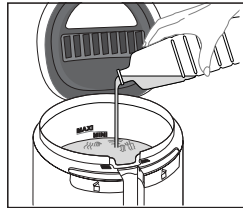
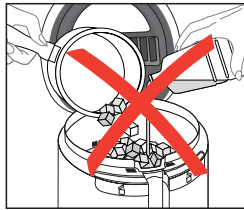

Min. 1660 g

Max. 1910 g

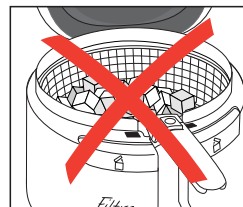
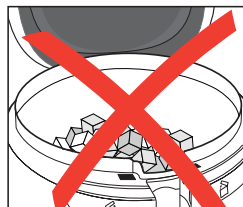
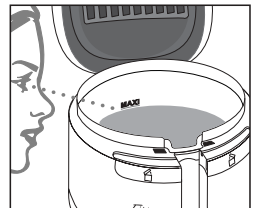
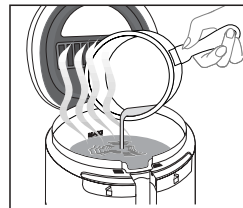
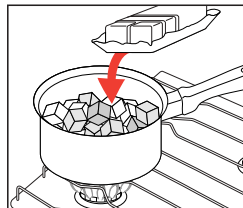

3 -

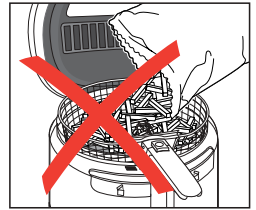
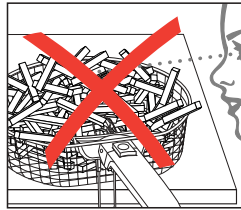
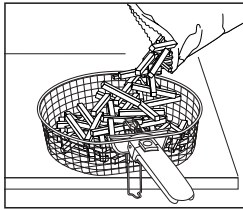
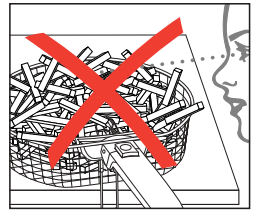
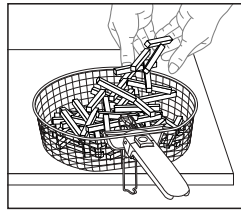
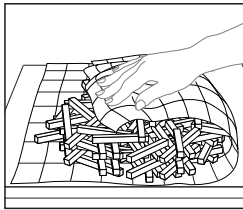
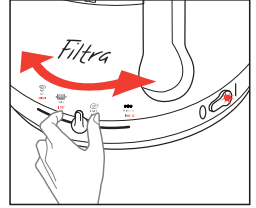
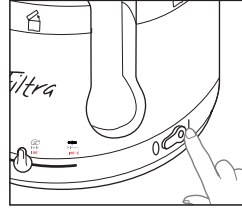
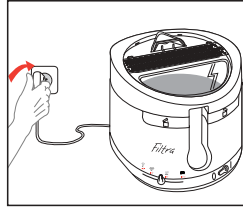
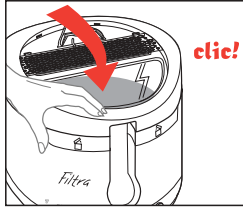

4 -

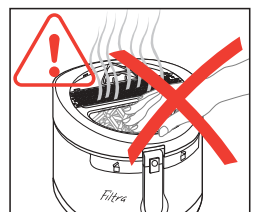
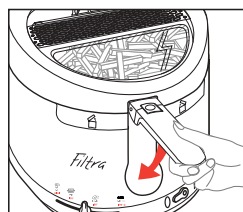
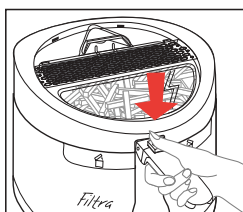
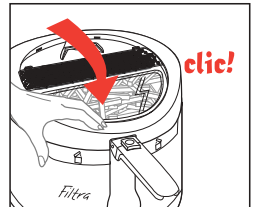
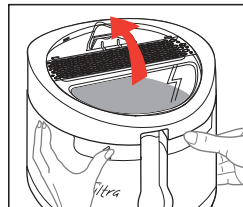
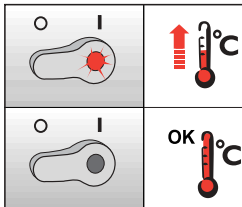

5 -

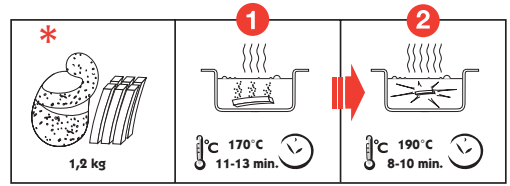

	Nb			
		1000 g	190°C	+/- 11 - 16 min.
		1200 g*	① 170°C ② 190°C	+/- 11 - 13 min. +/- 8 - 10 min.
	8 - 10		190°C	+/- 9 - 10 min.
	2		180°C	+/- 14 - 16 min.
	1 - 2		170°C	+/- 6 - 8 min.
	6		170°C	+/- 3 - 4 min.
		200 g	MINI	+/- 5 - 7 min.
	10 - 12		180°C	+/- 11 - 13 min.
	4		180°C	+/- 5 - 6 min.

	Nb			
		900 g	190°C	+/- 12 - 14 min.
		450 g	170°C	+/- 9 - 13 min.
	2	300 g	190°C	+/- 5 - 7 min.
	2		190°C	+/- 14 - 15 min.
	16	275 g	190°C	+/- 4 - 5 min.
	12	180 g	190°C	+/- 3 - 4 min.

6 -

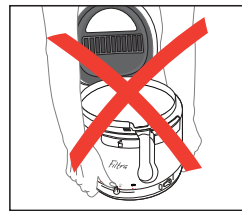
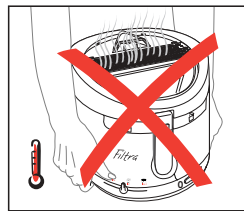
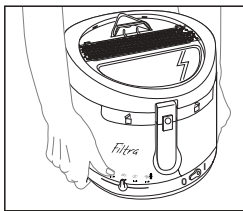
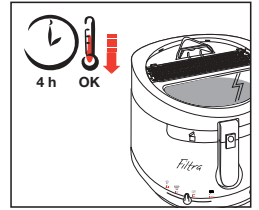
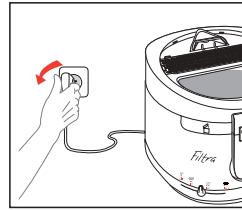
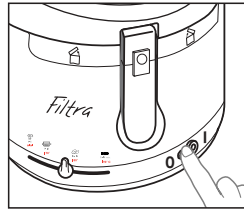
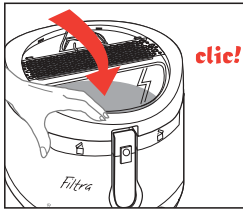
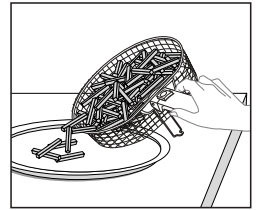
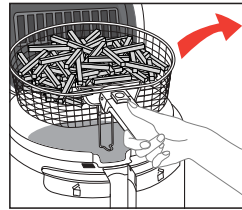
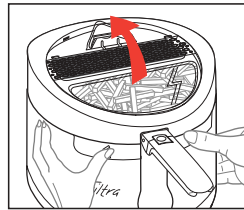
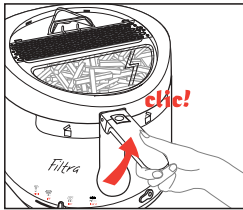

7 -

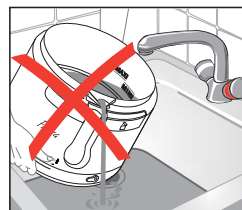
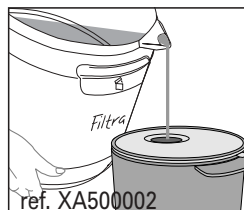
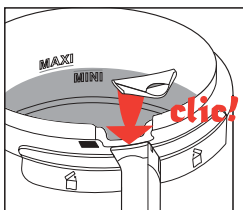
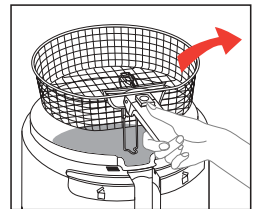
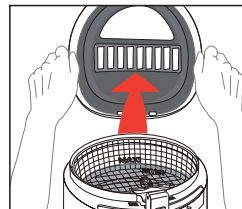
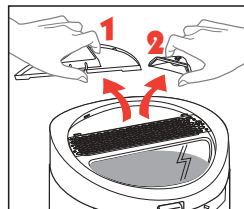
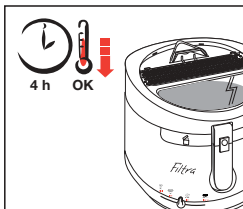
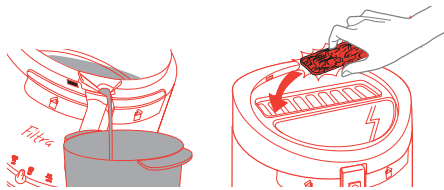

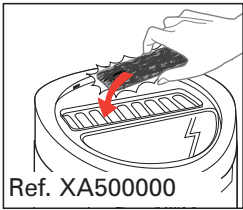
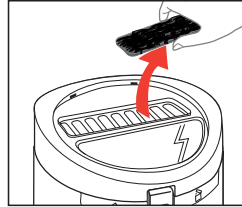
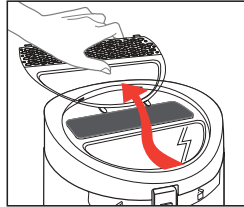
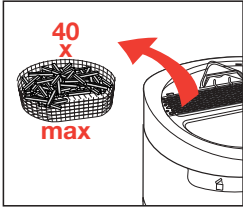
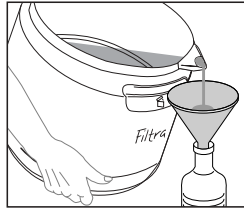
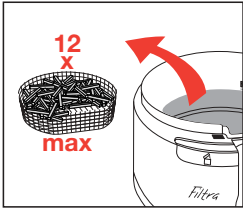

8 -

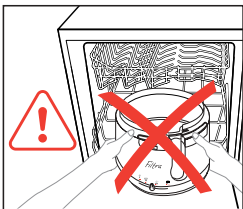
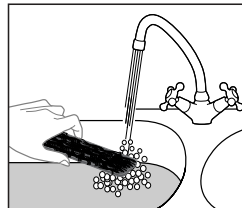
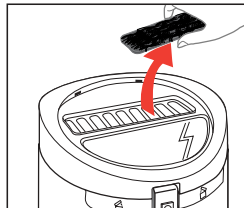
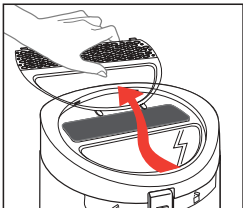
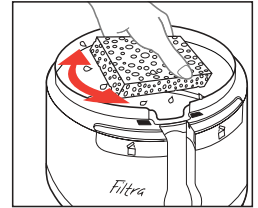
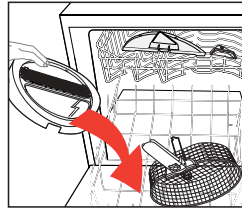
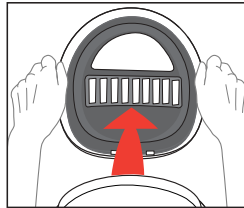
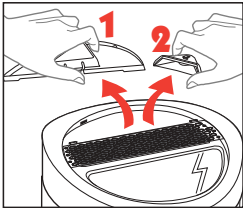

Filtra

