

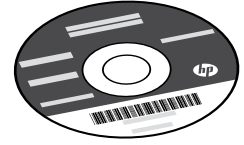

DESKJET 2050 ALL-IN-ONE J510 SERIES DESKJET 1050 ALL-IN-ONE J410 SERIES

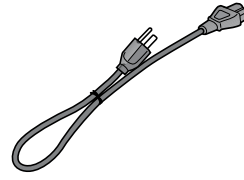

Start Here
Comience aquí
Commencez ici
Comece aqui
Lea Esto

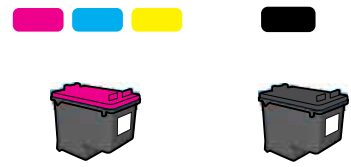

CH350-90048

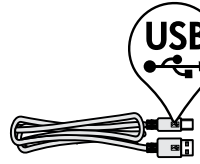

You might need to purchase a USB cable separately.
Puede que tenga que adquirir un cable USB por separado.
Il se peut que vous deviez acheter un câble USB séparément.
É preciso adquirir um cabo USB separadamente.

EN
ES
FR
PT

1 ①



Remove tape and cardboard.
Retire la cinta adhesiva y el cartón.

2



Retirez le carton et le ruban adhésif.
Remova a fita adesiva e os pedaços de papelão.

3

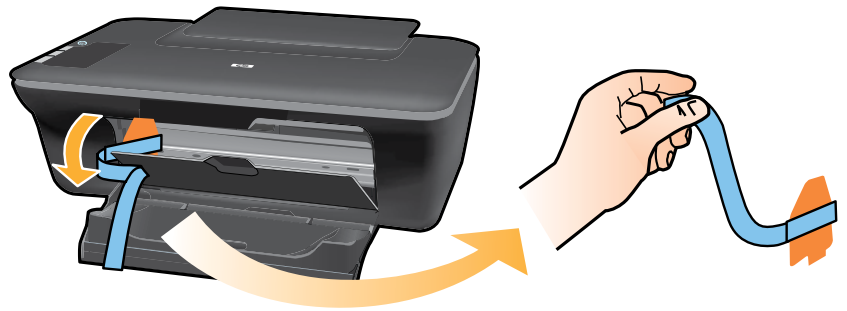

2

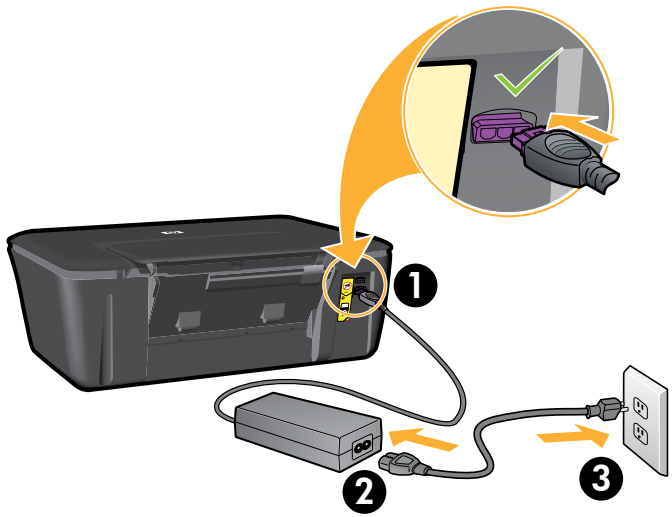

Connect power.

Do not connect USB until prompted.

Conecte la alimentación.

No conecte el USB, hasta que se le solicite.

Connectez l'alimentation.

Ne branchez pas le câble USB avant d'y avoir été invité.

Conecte o cabo de alimentação.

Não conecte o cabo USB até isso ser solicitado.

3

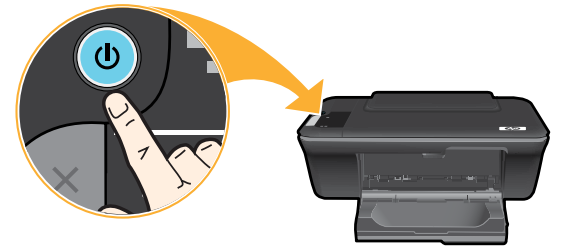

Press On button.

Pulse el botón Encender.

Appuyez sur le bouton Marche/arrêt.

Pressione o botão Liga/Desliga .

4 ①



Raise input tray.
Levante la bandeja de entrada.
Soulevez le bac d'alimentation.
Levante a bandeja de entrada.

2

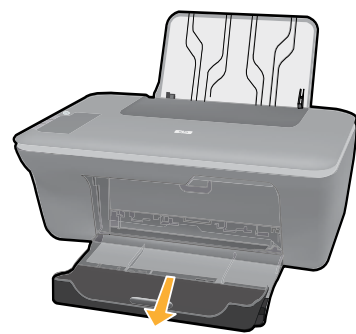

Pull out tray extender.
Tire del extensor de la bandeja.
Déployez l'extension du bac.
Puxe o extensor da bandeja.

3



Slide guide. Load white paper.
Deslice la guía. Coloque papel blanco.
Faites glisser le guide. Chargez du papier blanc.
Deslize a guia. Coloque papel branco.

5



Open cartridge door.
Abra la puerta del cartucho.
Ouvrez la trappe d'accès aux cartouches.
Abra a porta de acesso aos cartuchos.

6 ①

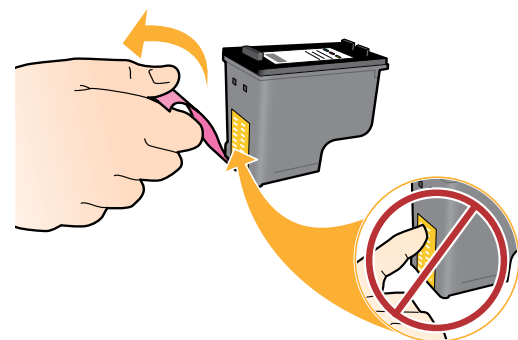

Pull pink tab to remove clear tape.
Tire de la pestaña rosa para quitar la cinta adhesiva transparente.
Tirez sur la languette rose pour retirer l'adhésif.
Puxe a tira rosa e remova a fita adesiva transparente.

2

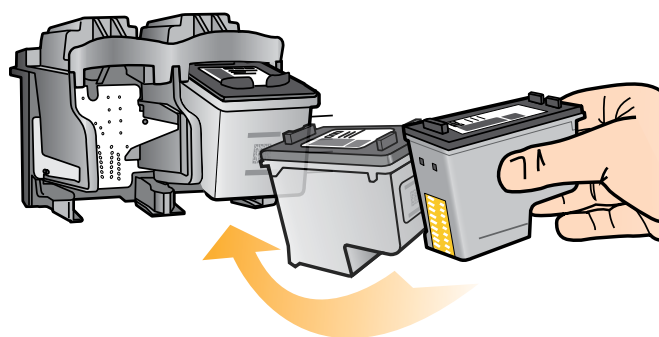

Push both cartridges into carriage until they snap.
Empuje los cartuchos en la guía hasta que encajen.
Introduisez les deux cartouches dans leur logement jusqu'à ce qu'elles émettent un déclic.
Empurre os dois cartuchos para dentro do compartimento no carro até eles se encaixarem.

3

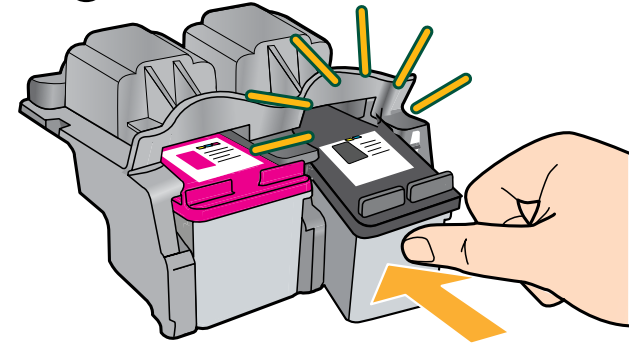

7

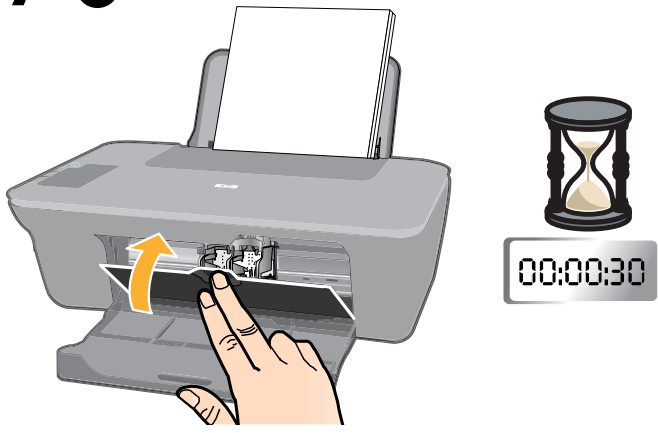
7 1

Close cartridge door. Wait 30 seconds for alignment page to automatically print.

Cierre la puerta del cartucho. Espere 30 segundos a que se imprima automáticamente la página de calibrado.

Refermez la trappe d'accès aux cartouches. Patientez 30 secondes te temps que la page d'alignement s'imprime automatiquement.

Feche a porta de acesso aos cartuchos. Aguarde 30 segundos para que a página de alinhamento seja impressa automaticamente.

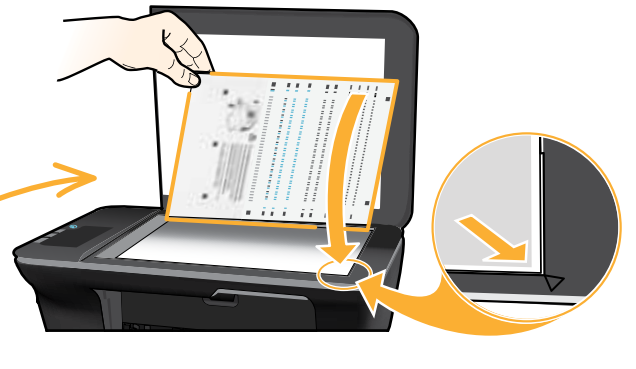
2**3**

Open lid. Place alignment page face down.

Abra la tapa. Coloque la página de calibrado hacia abajo.

Ouvrez le capot. Placez la page d'alignement face vers le bas.

Abra a tampa. Coloque a página de alinhamento voltada para baixo.

8

Close lid. Press Start Copy Color button.

Wait until On button light stops blinking, this means the alignment has been completed. Completing the alignment ensures better print quality.

Cierre la tapa. Pulse el botón Iniciar copia color.

Cuando el botón Encender deje de parpadear, se habrá completado el calibrado. Completando el calibrado, se asegura una mejor calidad de impresión.

Refermez le capot. Appuyez sur le bouton de lancement d'une copie couleur.

Attendez que le voyant d'alimentation ait cessé de clignoter : cela signifie que l'alignement est terminé. Attendre la fin de l'alignement assurera une meilleure qualité d'impression.

Feche a tampa. Pressione o botão Iniciar cópia Cor.

Aguarde até a luz do botão liga/Desliga parar de piscar, isso significa que o alinhamento foi concluído. Concluir o alinhamento garante melhor qualidade da impressão.

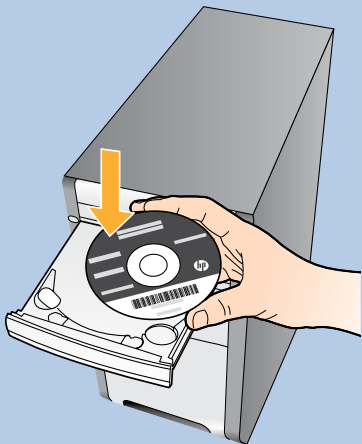
9**Windows:****1**

IMPORTANT: Do not connect USB until prompted on screen.

IMPORTANTE: No conecte el USB, hasta que se le solicite en la pantalla.

IMPORTANT : Ne branchez pas le câble USB avant d'y avoir été invité à l'écran.

IMPORTANTE: Não conecte o cabo USB até isso ser solicitado na tela.

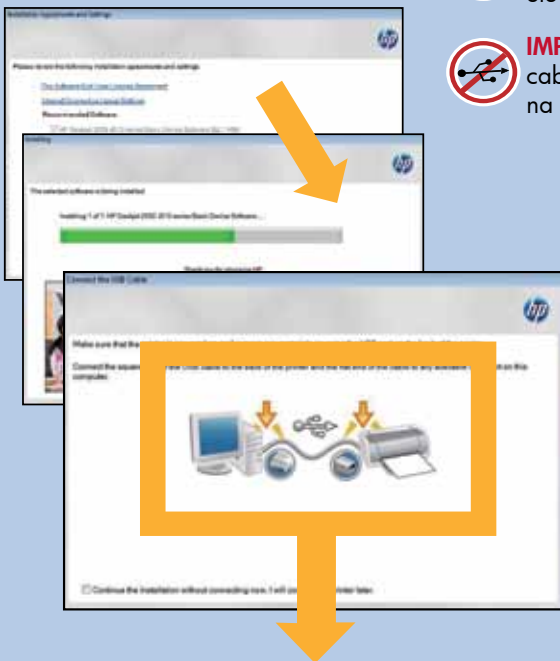
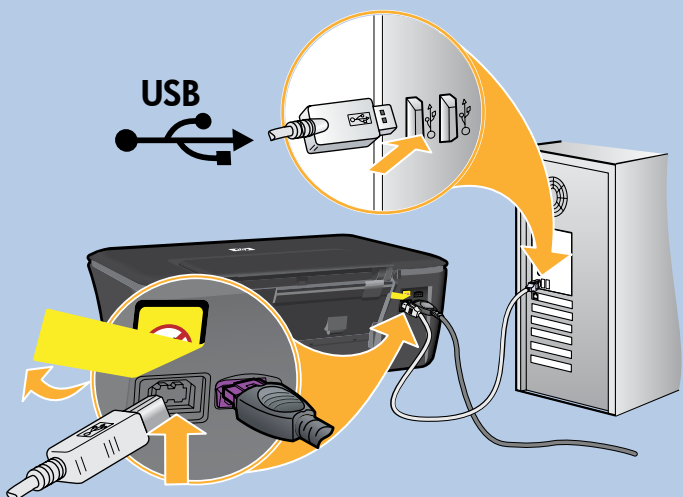
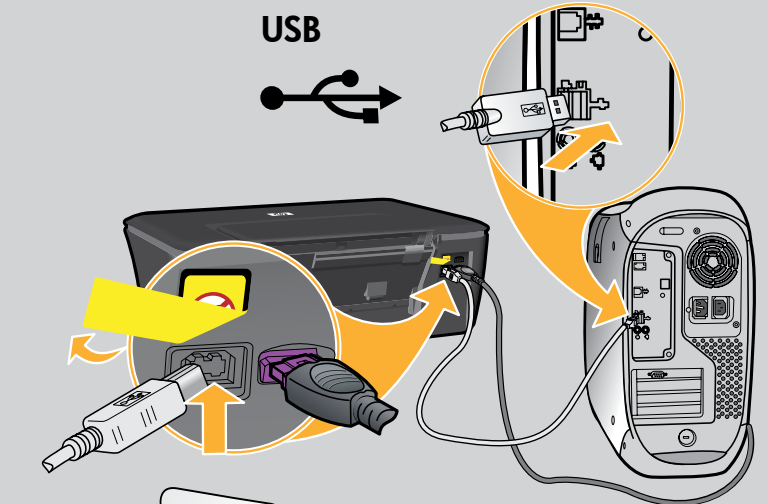
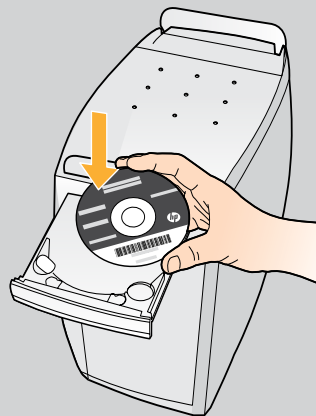
2**3****Mac:****1****USB****2****3**

For computers without a CD/DVD drive, please go to www.hp.com/support to download and install the printer software.

Si no dispone de una unidad de CD/DVD, visite www.hp.com/support para descargar e instalar el software de la impresora.

Sur les ordinateurs non équipés d'un lecteur de CD/DVD, visitez le site www.hp.com/support pour télécharger et installer le logiciel d'imprimante.

Para computadores sem uma unidade de CD/DVD, acesse www.hp.com/support para baixar e instalar o software da impressora.

© 2010 Hewlett-Packard Development Company, L.P.

Printed in [English]
Printed in [French]
Printed in [Spanish]
Printed in [Portuguese]

www.hp.com

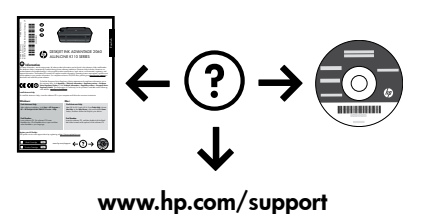

www.hp.com/support