

Panasonic[®]

Model No.
TX-P42ST31B
TX-P50ST31B

Operating Instructions Plasma Television



VIERA

Thank you for purchasing this Panasonic product.
Please read these instructions carefully before operating this
product and retain them for future reference.
The images shown in this manual are for illustrative purposes only.

English UK and Ireland model



TQB0E2160

Features

3D technology - Step into the 3D World.™

Viewing 3D images on the Full HD panel

You can enjoy viewing 3D images on this TV by wearing the 3D Eyewear.

RealID 3D

This TV and 3D Eyewear use the 3D technology of RealID. RealID is one of the inventors in 3D technology.

DVB-T tuner built-in

Receives DVB (Digital Video Broadcasting) digital terrestrial broadcasts.

DVB-T2 tuner built-in (UK only)

DVB-T2 is an advanced digital terrestrial system for more efficient transmission.

Available DVB-T2 broadcasts will be tuned automatically when you perform DVB Auto Setup.

GUIDE Plus+ (p. 22) (UK only)

This TV supports the TV Guide services sent from the GUIDE Plus+ system.

Sharp pictures and clear sound with HDMI connection (p. 91)

Enjoy high definition digital picture and high quality sound by using an HDMI cable.

Using USB devices

Enjoy the photo, video and music in the USB Flash Memory on Media Player. (p. 59)

Wireless LAN Adaptor for the network connection. (p. 6, 12, 14)

USB keyboard, gamepad, etc. are available. (p. 92)

Timer Programming (p. 23, 51)

Timer Programming enables you to use functions such as programme reminder and programme recording to the external recorder.

SDXC Card

This TV supports SDXC Card. SDXC is the latest standard of SD Card and a higher storage capacity card.

VIERA Connect - Enjoy great web entertainment (p. 17, 75)

VIERA Connect allows you to access some specific websites supported by Panasonic, and enjoy internet contents such as photos, videos, games, etc. from VIERA Connect home screen.

Link up and control the connected equipment with “Q-Link” and “VIERA Link” (p. 76)

Q-Link and VIERA Link provide easy recording and playback, creation of a home theatre without complicated settings, etc.

VIERA TOOLS - Display special feature icons for easy accessibility (p. 34)

Special features (such as VIERA Link and Media Player) can be accessed easily by using the VIERA TOOLS button.

Dolby Digital Plus / Dolby Pulse decoders

It is possible to decode Dolby Digital Plus / Dolby Pulse multi-channel audio tracks and output as Dolby Digital Bitstream (multi-channel sound signal) from DIGITAL AUDIO OUT / HDMI2 (ARC function) terminals.

Owner ID (p. 56)

Owner ID is an anti-theft function. Entering the PIN number and owner's personal information will help the Police to determine the owner in the case of theft.

Supports Audio Description signal (p. 19, 38) (UK only)

Audio Description (when broadcast) adds an additional soundtrack to describe events on screen (narration) and aids understanding and enjoyment, particularly for visually-impaired viewers.

Digital Switchover for Terrestrial broadcasts (UK only)

Starting in late 2007 and ending in 2012, TV services in the UK will go completely digital, TV region by TV region.

If you have any questions, please call Digital UK on **08456 50 50 50** or visit **www.digitaluk.co.uk**
Digital Switchover will cover a period of several weeks. When it starts you will lose all Analogue TV channels and some Digital TV channels will be missing.

You will need to retune your TV each time this happens to recover your digital channels. Analogue channels are permanently turned off, it will not be possible to recover them.

• To retune your TV ➔ [Auto Setup] in [DVB Tuning Menu]-DVB mode (p. 46)

Users of cable or satellite boxes should still retune the TV to continue to receive Freeview channels via their aerial. (Your Analogue channel for viewing Cable or Satellite services will change to a new position.)

• Due to the digital reception technologies involved, quality of the digital signals may be relatively low in some cases, despite good reception of analogue channels.

Contents

Do not display a still picture for a long time

This causes the image to remain on the plasma screen ("image retention"). This is not considered a malfunction and is not covered by the warranty.

Typical still images

- Channel number and other logos
- Image displayed in 4:3 mode



- Video game
- Computer image

To prevent image retention, contrast is lowered automatically after a few minutes if no signals are sent or no operations are performed. (p. 94)

Panasonic does not guarantee operation and performance of peripheral devices made by other manufacturers; and we disclaim any liability or damage arising from operation and/or performance from usage of such other maker's peripheral devices.

This product is licensed under the AVC patent portfolio license for the personal and non-commercial use of a consumer to (i) encode video in compliance with the AVC Standard ("AVC Video") and/or (ii) decode AVC Video that was encoded by a consumer engaged in a personal and non-commercial activity and/or was obtained from a video provider licensed to provide AVC Video. No license is granted or shall be implied for any other use.

Additional information may be obtained from MPEG LA, LLC.

See <http://www.mpegla.com/>.

ROVI CORPORATION AND/OR ITS RELATED AFFILIATES ARE NOT IN ANY WAY LIABLE FOR THE ACCURACY OF THE PROGRAM SCHEDULE INFORMATION PROVIDED BY THE GUIDE PLUS+ SYSTEM. IN NO EVENT SHALL ROVI CORPORATION AND/OR ITS RELATED AFFILIATES BE LIABLE FOR ANY AMOUNTS REPRESENTING LOSS OF PROFITS, LOSS OF BUSINESS, OR INDIRECT, SPECIAL, OR CONSEQUENTIAL DAMAGES IN CONNECTION WITH THE PROVISION OR USE OF ANY INFORMATION, EQUIPMENT, OR SERVICES RELATING TO THE GUIDE PLUS+ SYSTEM. <http://www.europe.guideplus.com/>

Notice for DVB / Data broadcasting / IPTV functions

This TV is designed to meet the standards (as of August, 2009) of digital services.

- The compatibility with future services is not guaranteed.
- Check the latest information on the available services at the following website. <http://panasonic.jp/support/global/cs/tv/>

Be Sure to Read

Safety Precautions 4

Quick Start Guide

Accessories / Options 6

Identifying Controls 9

Basic Connection 11

Auto Setup 13

Enjoy your TV!

Basic Features

Using "VIERA Connect" 17

Watching TV 18

Using TV Guide 22

Viewing Teletext 25

Watching External Inputs 28

Viewing 3D images 30

How to Use VIERA TOOLS 34

How to Use Menu Function 35

Advanced Features

Retuning from Setup Menu 46

Tuning and Editing Channels 47

Timer Programming 51

Child Lock 53

Input Labels 54

Shipping Condition 55

Owner ID 56

Using Common Interface 57

Updating the TV Software 58

Using Media Player 59

Using Network Services 69

Link Functions
(Q-Link / VIERA Link) 76

External Equipment 84

FAQs, etc.

Technical Information 87

FAQs 94

On screen messages 96

Maintenance 99

Glossary 99

Index 100

Licence 101

Specifications 102

Safety Precautions

Warning

■ Mains plug and lead

To help avoid risk of electrical shock, fire, damage or injury, please follow the warnings below:

- This TV is designed to operate on AC 220-240 V, 50 / 60 Hz.
- Insert the mains plug fully into the socket outlet.
- Ensure that the mains plug is easily accessible.
- Remove the mains plug when cleaning the TV.

- Do not touch the mains plug with a wet hand.



- Do not damage the mains lead.

- Do not place a heavy object on the lead.



- Do not place the lead near a high temperature object.



- Do not pull on the lead. Hold onto the mains plug body when disconnecting the plug.



- Do not move the TV with the lead plugged into a socket outlet.
- Do not twist the lead, bend it excessively or stretch it.
- Do not use a damaged mains plug or socket outlet.
- Ensure the TV does not crush the mains lead.
- Ensure the earth pin on the mains plug is securely connected to prevent electrical shock.
- An apparatus with CLASS I construction shall be connected to a mains socket outlet with a protective earthing connection.

If you detect anything unusual, immediately switch off the mains supply switch and remove the mains plug.

AC 220-240 V
50 / 60 Hz

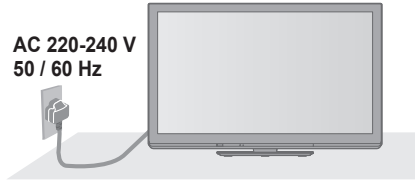

IMPORTANT: THE MOULDED MAINS PLUG

FOR YOUR SAFETY, PLEASE READ THE FOLLOWING TEXT CAREFULLY.

This TV is supplied with a moulded three pin mains plug for your safety and convenience. A 10 amp fuse is fitted in this mains plug. Shall the fuse need to be replaced, please ensure that the replacement fuse has a rating of 10 amps and that it is approved by ASTA or BSI to BS1362.

Check for the ASTA mark  or the BSI mark  on the body of the fuse.

If the mains plug contains a removable fuse cover, you must ensure that it is refitted when the fuse is replaced.

If you lose the fuse cover the mains plug must not be used until a replacement cover is obtained.

A replacement fuse cover may be purchased from your local dealer.

Do not cut off the mains plug.

Do not use any other type of mains lead except the one supplied with this TV.

The supplied mains lead and moulded plug are designed to be used with this TV to avoid interference and for your safety.

If the socket outlet in your home is not suitable, get it changed by a qualified electrician.

If the plug or mains lead becomes damaged, purchase a replacement from an authorized dealer.

WARNING: – THIS TV MUST BE EARTHED.

How to replace the fuse.



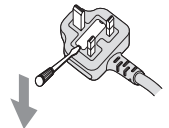

Open the fuse compartment with a screwdriver and replace the fuse.



Warning

Take care

To help avoid risk of electrical shock, fire, damage or injury, please follow the warnings below:

- Do not remove covers and never modify the TV yourself as live parts are accessible when they are removed. There are no user serviceable parts inside. 
- Do not expose the TV to rain or excessive moisture. This TV must not be exposed to dripping or splashing water and objects filled with liquid, such as vases, must not be placed on top of or above the TV. 
- Do not expose the TV to direct sunlight and other sources of heat. To prevent fire never place any type of candle or naked flame on top or near the TV. 
- Do not place the TV on sloped or unstable surfaces, and ensure that the TV does not hang over the edge of the base. 
- Do not insert foreign objects into the TV through the air vents.
- Do not use an unapproved pedestal / mounting equipment. Be sure to ask your local Panasonic dealer to perform the setup or installation of approved wall-hanging brackets.
- Do not apply strong force or impact to the display panel.

To prevent the spread of fire, keep candles or other open flames away from this product at all times



Small object

This product contains possibly dangerous parts that can be breathed in or swallowed by young children accidentally.

- Keep the dangerous parts out of reach of young children.
- Do not allow children to handle SD Card. As with any small object, the SD Card could be swallowed by young children. Please remove SD Card immediately after use and store out of reach of young children.



Caution

Ventilation

Allow sufficient space around the TV in order to help prevent excessive heat, which could lead to early failure of some electronic components.

- Ventilation should not be impeded by covering the ventilation openings with items such as newspapers, tablecloths and curtains. 
- Whether you are using the pedestal or not, always ensure the vents in the bottom of the TV are not blocked and there is sufficient space to enable adequate ventilation.

Minimum distance

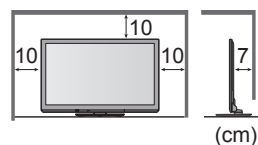

Moving the TV

Before moving the TV, disconnect all cables.

- The TV is heavy. Move the TV with at least two people. Support as shown to avoid injury by the TV tipping or falling.
- Transport only in upright position. Transporting the TV with its display panel facing upward or downward may cause damage to the internal circuitry.

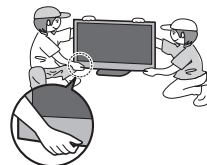

When not in use for a long time

This TV will still consume some power even in the Off mode, as long as the mains plug is still connected to a live socket outlet.

- Remove the mains plug from the wall socket when the TV is not in use for a prolonged period of time.

Excessive volume

Do not expose your ears to excessive volume from the headphones. Irreversible damage can be caused.



Accessories / Options

Standard accessories

Remote Control



- N2QAYB000572

Batteries for the Remote Control (2)

- R6
- ➔ (p. 7)



Pedestal

- TX-P42ST31B : TX-P50ST31B :
- TBL5ZX0065
 - TBL5ZX0069
 - TXFBL5Z0007
 - TXFBL5Z0009
 - TXFBL5Z0017
 - TXFBL5Z0019
- ➔ (p. 7)

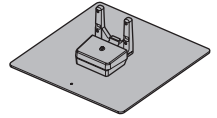

Ferrite core (2) (Large size)

- J0KG00000014
- ➔ (p. 12, 85)



Ferrite core (Small size)

- J0KG00000011
- ➔ (p. 86)



(TX-P42ST31B)

Operating Instructions

Product Registration Leaflet

Use the Ferrite cores to comply with the EMC standard.

- Accessories may not be placed all together. Take care not to throw them away unintentionally.
- This product contains possibly dangerous parts (such as plastic bags), that can be breathed in or swallowed by young children accidentally. Keep these parts out of reach of young children.

Optional accessories

Please contact your nearest Panasonic dealer to purchase the recommended optional accessories. For additional details, please refer to the manual of the optional accessories.

3D Eyewear set

(Battery type)

- TY-EW3D10E



(Rechargeable type)

- TY-EW3D2LE
- TY-EW3D2ME
- TY-EW3D2SE

- If you need 3D Eyewears additionally, please purchase this optional accessory.
- For more information :
<http://panasonic.net/avc/viera/3d/eu.html>

Wireless LAN Adaptor

- DY-WL10E-K

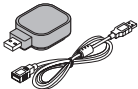

Caution

- To use the Wireless LAN Adaptor, an access point needs to be obtained.
- It is recommended to use the Wireless LAN Adaptor with the extension cable.
- To avoid malfunctions caused by radio wave interference, keep the TV away from the devices such as other wireless LAN devices, microwaves and the devices that use 2.4 GHz and 5 GHz signals when using the Wireless LAN Adaptor.
- Depending on the area, this optional accessory may not be available.
- Additional information for Wireless LAN Adaptor and access point may be on the following website.
<http://panasonic.jp/support/global/cs/tv/>

Communication Camera

- TY-CC10W



Caution

- This camera can be used on VIERA Connect (p. 17, 75).
- Please also read the manual of the camera.
- Depending on the area, this optional accessory may not be available. For details, consult your local Panasonic dealer.

Wall-hanging bracket

• TY-WK4P1RW

The angle of wall-hanging bracket can be adjusted in “zero tilting (vertical)” and “15-degree tilting” for this TV.

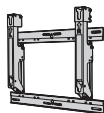

Rear of the TV

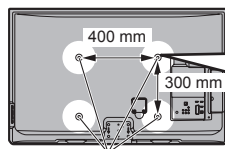

Holes for wall-hanging bracket installation

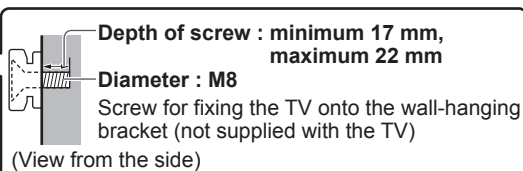

Warning

- Using other wall-hanging brackets, or installing a wall-hanging bracket by yourself have the risk of personal injury and product damage. In order to maintain the unit's performance and safety, be absolutely sure to ask your dealer or a licensed contractor to secure the wall-hanging brackets. Any damage caused by installing without a qualified installer will void your warranty.
- Carefully read the instructions accompanying optional accessories, and be absolutely sure to take steps to prevent the TV from falling off.
- Handle the TV carefully during installation since subjecting it to impact or other forces may cause product damage which will void your warranty.
- Take care when fixing wall brackets to the wall. Always ensure that there are no electrical cables or pipes in the wall before hanging bracket.
- To prevent fall and injury, remove the TV from its fixed wall position when it is no longer in use for an extended period of time.

Installing / removing remote's batteries

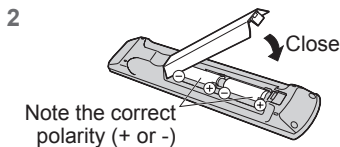
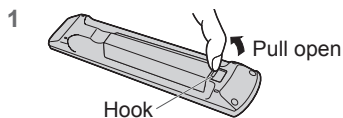

Caution

- Incorrect installation may cause battery leakage and corrosion, resulting in damage to the remote control.
- Do not mix old and new batteries.
- Do not mix different battery types (such as alkaline and manganese batteries).
- Do not use rechargeable (Ni-Cd) batteries.
- Do not burn or break up batteries. Batteries must not be exposed to excessive heat such as sunshine, fire, etc.
- Make sure you dispose of batteries correctly.
- Do not disassemble or modify the remote control.

Attaching / removing the pedestal





To help avoid risk of damage or injury by the TV tipping or falling, please follow the warnings and cautions below:

Warning

- Do not disassemble or modify the pedestal.

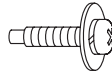
Caution

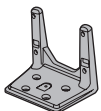
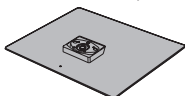
- Do not use any pedestal other than the one provided with this TV.
- Do not use the pedestal if it becomes warped or physically damaged. If this occurs, contact your nearest Panasonic dealer immediately.
- During setup, make sure that all screws are securely tightened.
- Ensure that the TV does not suffer any impact during installation of the pedestal.
- Ensure that children do not climb onto the pedestal.
- Install or remove the TV from the pedestal with at least two people.

- (A) Assembly screw (4)**
(silver)
• XYN5+F20FN

M5 × 20
- (B) Assembly screw (4)**
(black)
• THEL087N (TX-P42ST31B)
• THEL088N (TX-P50ST31B)

M5 × 25
- (C) Assembly screw**
(black)
• XSB4+8FNK

M4 × 8
- (D) Pole**
• TBL5ZA3055 (TX-P42ST31B)
• TBL5ZA3065 (TX-P50ST31B)

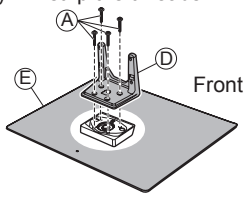
- (E) Base**
• TBL5ZX0065 (TX-P42ST31B)
• TBL5ZX0069 (TX-P50ST31B)

- (F) Cover**
• TBL5ZB3045-1 (TX-P42ST31B)
• TBL5ZB3054-1 (TX-P50ST31B)

1 Assembling the pedestal

Use the assembly screws (A) to fasten the pole (D) to the base (E) securely.

- Make sure that the screws are securely tightened.
- Forcing the assembly screws the wrong way will strip the threads.



Attach the cover (F) with assembly screw (C)

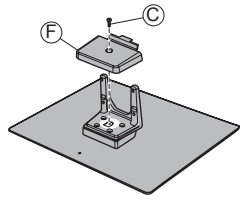

2 Securing the TV

Use the assembly screws (B) to fasten securely.

- Tighten the four assembly screws loosely at first, then tighten them firmly to fix securely.
- Carry out the work on a horizontal and level surface.

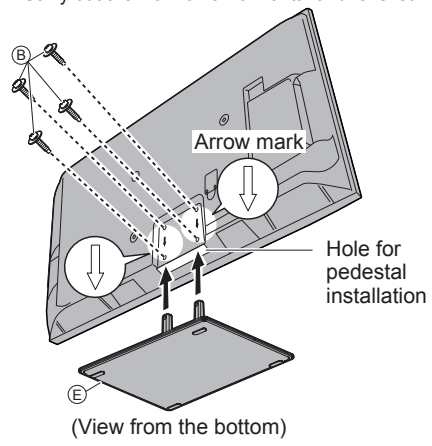

Removing the pedestal from the TV
Be sure to remove the pedestal in the following way when using the wall-hanging bracket or repacking the TV.

- 1 Remove the assembly screws (B) from the TV.
- 2 Pull out the pedestal from the TV.
- 3 Remove the assembly screw (C) from the cover.
- 4 Pull out the cover.
- 5 Remove the assembly screws (A) from the pole.

Adjusting the panel to your desired angle

- Do not place any objects within the full rotation range.

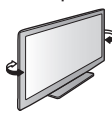
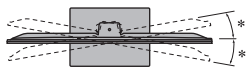
*: 15°
(TX-P42ST31B)

*: 10°
(TX-P50ST31B)

(View from the top)

Identifying Controls

Remote Control

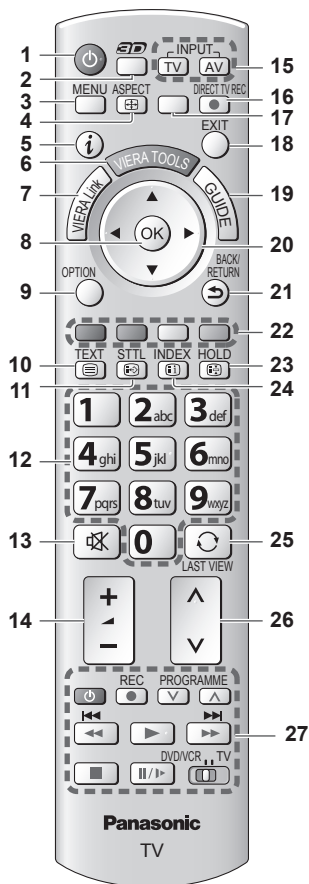

1 Standby On / Off switch

- Switches TV On or Off standby

2 3D button → (p. 32)

- Switches to the viewing mode between 2D and 3D

3 [Main Menu] → (p. 35)

- Press to access Picture, Sound, Timer and Setup Menus

4 Aspect → (p. 21)

- Changes aspect ratio

5 Information → (p. 18)

- Displays channel and programme information

6 VIERA TOOLS → (p. 34)

- Displays some special feature icons and accesses easily

7 [VIERA Link Menu] → (p. 80)

8 OK

- Confirms selections and choices
- Press after selecting channel positions to quickly change channel
- Displays the Channel List

9 [Option Menu] → (p. 20)

- Easy optional setting for viewing, sound, etc.

10 Teletext → (p. 25)

- Switches to teletext mode

11 Subtitles → (p. 21)

- Displays subtitles

12 Numeric buttons

- Changes channel and teletext pages
- Sets characters
- When in Standby mode, switches TV On (Press for about 1 second)

13 Sound Mute

- Switches sound mute On or Off

14 Volume Up / Down

15 Input mode selection

- TV - switches DVB / Analogue mode → (p. 18)
- AV - switches to AV input mode from Input Selection list → (p. 28)

16 Direct TV Recording → (p. 78, 80)

- Records programme immediately in DVD Recorder / VCR with Q-Link or VIERA Link connection

17 [VIERA Connect] → (p. 17, 75)

- Displays VIERA Connect home screen

18 Exit

- Returns to the normal viewing screen

19 TV Guide → (p. 22)

20 Cursor buttons

- Makes selections and adjustments

21 Return

- Returns to the previous menu / page

22 Coloured buttons (red-green-yellow-blue)

- Used for the selection, navigation and operation of various functions

23 Hold

- Freeze / unfreeze picture → (p. 20)
- Holds the current teletext page (teletext mode) → (p. 26)

24 Index → (p. 27)

- Returns to the teletext index page (teletext mode)

25 Last view → (p. 19)

- Switches to previously viewed channel or input mode

26 Channel Up / Down

27 Connected equipment operations

- (p. 29, 60, 82)

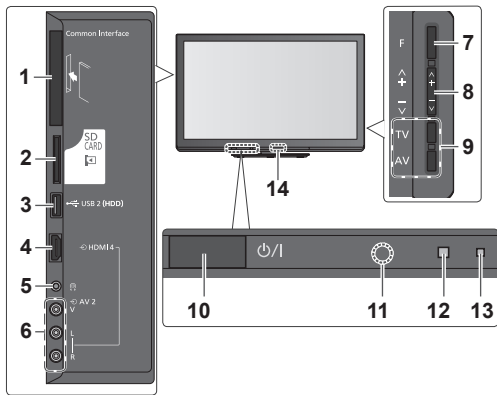

- 1 CI slot ➔ (p. 57)
- 2 SD Card slot ➔ (p. 59)
- 3 USB 2 port ➔ (p. 59)
- 4 HDMI4 terminal ➔ (p. 86)
- 5 Headphones jack ➔ (p. 86)
- 6 AV2 terminals ➔ (p. 86)
- 7 Function select
 - [Volume] / [Contrast] / [Brightness] / [Colour] / [Sharpness] / [Tint] (NTSC signal) / [Bass]* / [Treble]* / [Balance] / [Auto Setup] (p. 46)
 - *[Music] or [Speech] mode in the Sound Menu
- 8 Channel Up / Down, Value change (when using the F button), Switching the TV On (press either button for about 1 second when in Standby mode)

9 Changes the input mode

10 Mains power On / Off switch

- Use to switch the mains power. If you turned the TV Off during Standby mode by the remote control last time, the TV will be in Standby mode when you turn the TV On with Mains power On / Off switch.

11 Remote control signal receiver

- Do not place any objects between the TV remote control signal receiver and remote control.

12 C.A.T.S. (Contrast Automatic Tracking System) sensor

- Senses brightness to adjust picture quality when [C.A.T.S.] in the Picture Menu is set to [On] ➔ (p. 36)

13 Power and Timer LED

- **Red** : Standby
- **Green** : On
- **Orange** : Timer Programming On
- **Orange (flash)** :
 - Recording of Timer Programming or Direct TV Recording in progress
- **Red with orange flash** :
 - Standby with Timer Programming On or Direct TV Recording
- The LED blinks when the TV receives a command from the remote control.

14 Infrared transmitter for 3D Eyewear

- Do not place any objects between the transmitter and 3D Eyewear.

Using the On Screen Displays - Operation guide

Many features available on this TV can be accessed via the On Screen Display menu.

Operation guide

Operation guide will help you to operate by using the remote control.

Example : [Owner ID]

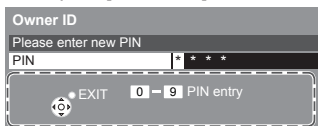

Operation guide

How to use remote control



Open the main menu



Move the cursor / select the menu item / select from a range of options



Move the cursor / adjust levels / select from a range of options



Access the menu / store settings after adjustments have been made or options have been set



Return to the previous menu



Exit the menu system and return to the normal viewing screen

Auto power standby function

The TV will automatically go to Standby mode in the following conditions:

- no signal is received and no operation is performed for 30 minutes in Analogue TV mode
 - [Off Timer] is active in the Timer Menu (p. 20)
 - no operation is performed for the period selected in [Auto Standby] (p. 39)
- 10 • This function does not affect the recording of Timer Programming and Direct TV Recording.

Basic Connection

External equipment and cables shown are not supplied with this TV.

Please ensure that the unit is disconnected from the mains socket before attaching or disconnecting any leads.

There are some restrictions on placement for viewing 3D images. For details ➔ (p. 30, 31)

Example 1

Connecting aerial

TV only

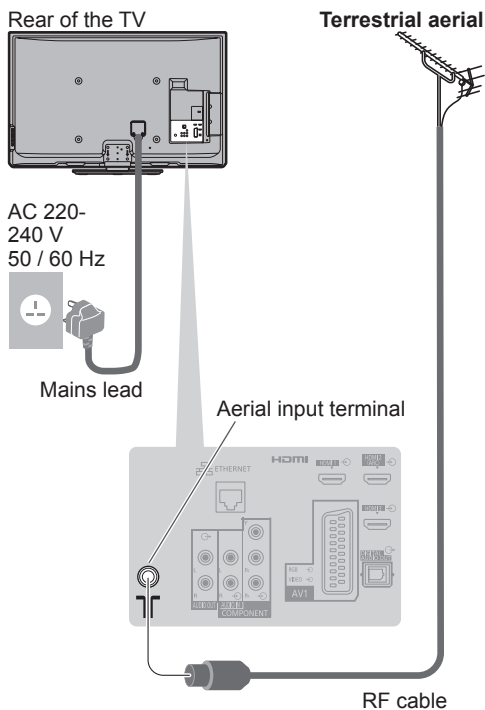

Example 2

Connecting DVD Recorder / VCR and Player

TV, DVD Recorder / VCR and Player

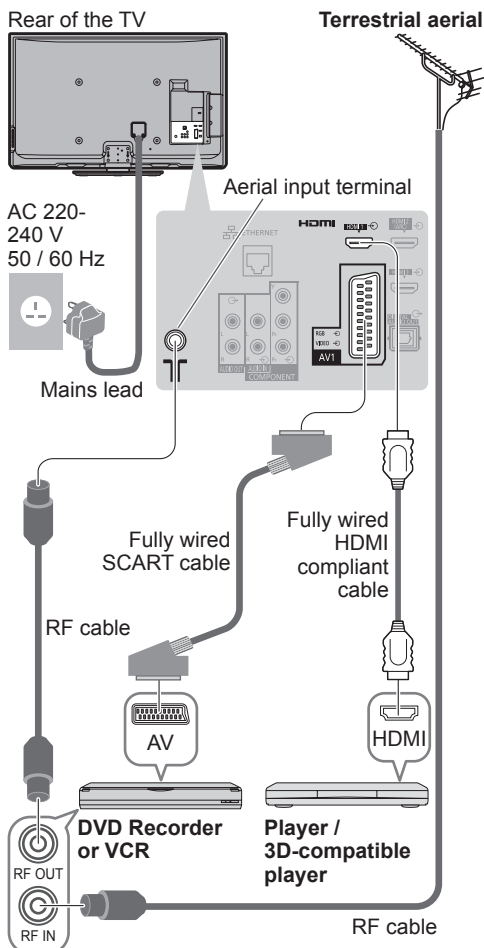

Note

- To watch 3D contents ➔ (p. 30)
- Connect to the TV's AV1 for a DVD Recorder / VCR supporting Q-Link (p. 78).
- For HDMI-compatible equipment, possible to connect to HDMI terminals (HDMI1 / HDMI2 / HDMI3 / HDMI4) by using HDMI cable (p. 84).
- Q-Link and VIERA Link connection ➔ (p. 76, 77)
- Please also read the manual of the equipment being connected.
- Keep the TV away from electronic equipment (video equipment, etc.) or equipment with an infrared sensor. Otherwise, distortion of image / sound may occur or operation of other equipment may be interfered.

Example 3

Connecting DVD Recorder / VCR and Satellite receiver

TV, DVD Recorder / VCR and Satellite

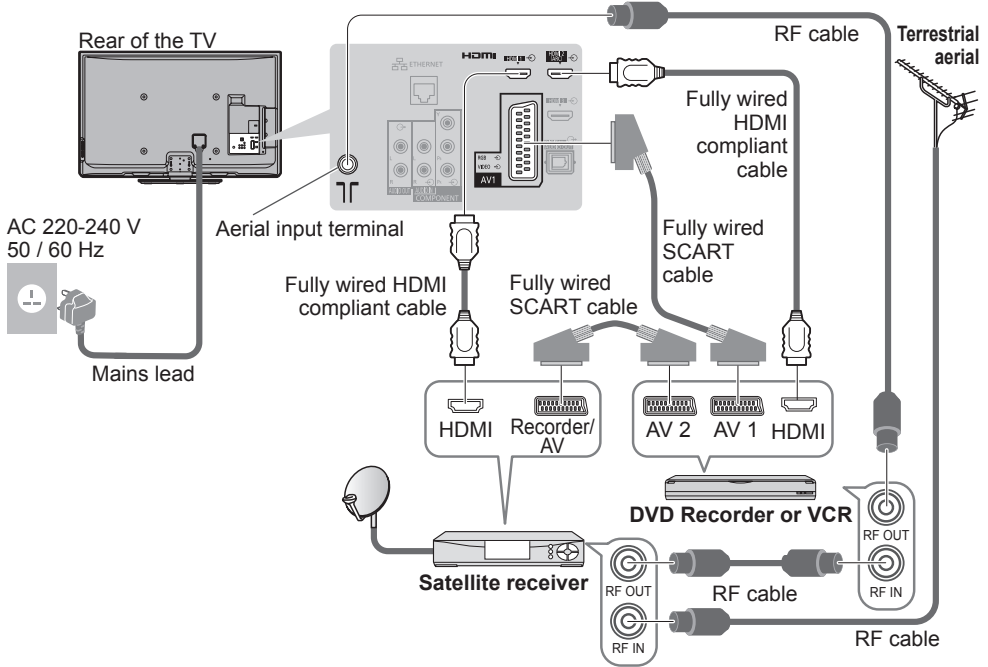

■ Connecting to the network environment (Network connections)

To enable the network service functions (VIERA Connect, etc.), you need to connect the TV to a broadband network environment.

- If you do not have any broadband network services, please consult your retailer for assistance.
- Connect with LAN cable (Wired connection) or Wireless LAN Adaptor (Wireless connection).
- Setup of the network connection will start after the tuning (when first using the TV) ➔ (p. 14, 15)

Rear of the TV

Wireless connection

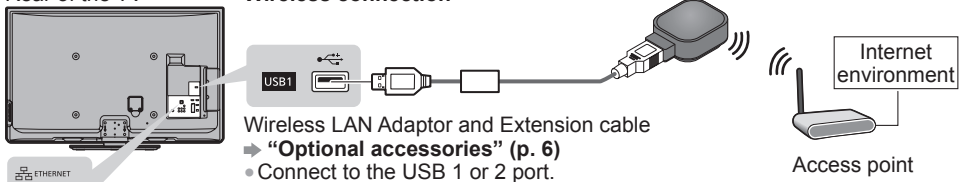

Wired connection

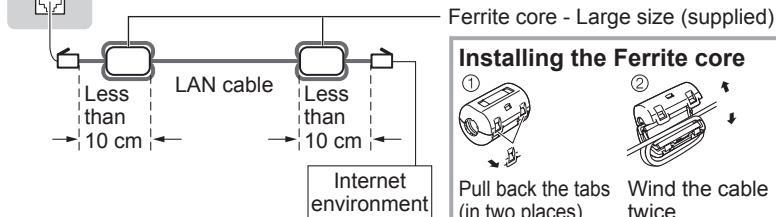

Installing the Ferrite core

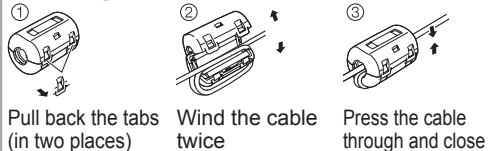

Note

- For more information of the network connections ➔ (p. 69)

Auto Setup

Search and store TV channels automatically.

- These steps are not necessary if the setup has been completed by your local dealer.
- Please complete connections (p. 11, 12) and settings (if necessary) of the connected equipment before starting Auto Setup. For details of settings for the connected equipment, read the appropriate manual.



1

Plug the TV into mains socket and switch On



- Takes a few seconds to be displayed.
- If the red LED shows on the TV, press the Standby On / Off switch on the remote control for at least 1 second to turn the TV On.

2

Select your country



Example : [UK]

Auto Setup - DVB and Analogue

| CH | Channel Name | Type | Quality |
|----|-----------------|----------|---------|
| 62 | BBC Channel | Free TV | 10 |
| 62 | BBC Radio Wales | Free TV | 10 |
| 62 | E4 | Free TV | 10 |
| 62 | Cartoon Nwk | Free TV | 10 |
| 29 | [| Analogue | - |
| 33 | BBC1 | Analogue | - |

Free TV: 8 Play TV: 0 Radio: 0 Data: 0 Analogue: 2



Example : [Ireland]

Auto Setup - DVB and Analogue

| CH | Channel Name | Type | Quality |
|------|-----------------|----------|---------|
| 62 | CSBC Channel | Free TV | 10 |
| 62 | BBC Radio Wales | Free TV | 10 |
| 62 | E4 | Free TV | 10 |
| 62 | Cartoon Nwk | Free TV | 10 |
| CH29 | [| Analogue | - |
| CH33 | BBC1 | Analogue | - |

Free TV: 8 Play TV: 0 Radio: 0 Analogue: 2



Auto Setup will start to search for TV channels and store them.

- Actual number of channels may differ due to channel duplication.

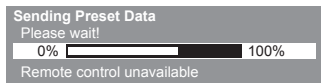

If Q-Link or similar technology (p. 78) compatible recorder with analogue tuner is connected, analogue channel setting is automatically downloaded to the recorder. (Digital channel setting is not downloaded.)

- If downloading has failed, you can download later through the Setup Menu.

➔ "Q-Link Download" (p. 39)

3

Enter your postcode UK only

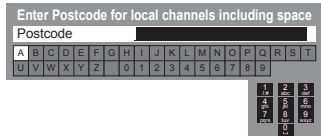

- Your postcode is required to receive local services and sort the channel order. Please ensure to include a space when entering your postcode.
- If you skip this step, the default postcode (central London) will be set.

■ How to enter the postcode

Set characters

Exit to go to next step



- You can set characters by using numeric buttons.

➔ "Characters table for numeric buttons" (p. 91)

4 Setup the network connection

Setup the network connection to enable the network service functions such as VIERA Connect, etc. (p. 17, 75).

- To setup the wireless connection, the Wireless LAN Adaptor (optional accessory) is required. Please note that this TV does not support wireless public access points.
- Ensure the network connections (p. 12) and network environment are completed before starting setup.

Select the network type

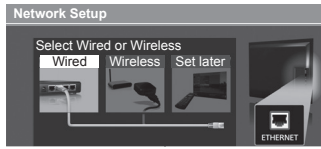

[Wired] → “Wired connection” (p. 12)

[Wireless] → “Wireless connection” (p. 12)



• To setup later on or skip this step

→ Select [Set later] or

■ [Wired]

1. Select [Auto]



2. Go to the next step **4**

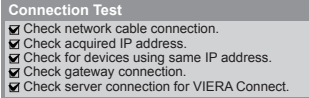

Automatically setup is done and the test of the network connection starts.

- To set manually, select [Manual] and set each item. For details → (p. 71)

: **succeeded**

The test is successful and the TV is connected to the network.

: **failed**

Check the settings and connections. And then select [Retry].

■ [Wireless]

Select the connection type

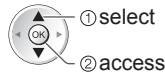
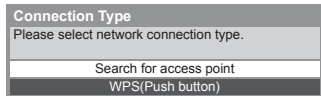

[Search for access point]

Access points found automatically are listed.

1. Select your desired access point

| Available Access Points | | | | |
|-------------------------|----------------|---------------|---------|-----------|
| No. | SSID | Wireless type | Encrypt | Reception |
| 1 | Access Point A | 11n(2.4GHz) | | |
| 2 | Access Point B | 11n(5GHz) | | |
| 3 | Access Point C | 11n(5GHz) | | |

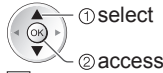

: Encrypted access point

• To search access points again

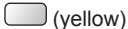

• For the information of the highlighted access point



• To set manually (p. 74)



2. Access the encryption key input mode

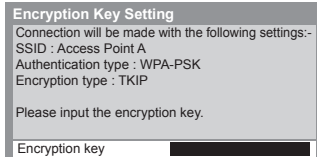

• If the selected access point is not encrypted, the confirmation screen will be displayed. It is recommended to select the encrypted access point.

3. Enter the encryption key of the access point

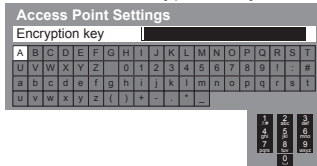

Set characters



• You can set characters by using numeric buttons.

→ “Characters table for numeric buttons” (p. 91)

Store



4. Select [Yes]

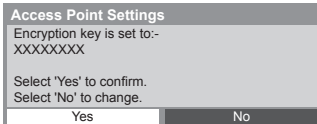

- To re-enter the encryption key, select [No].
- If the connection has failed, check the encryption key, settings and positions of your access point. And then, follow the on screen instructions.

5. After the access point setting is finished, perform the connection test

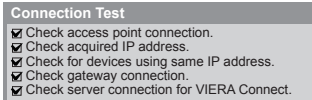

: **succeeded**

The test is successful and the TV is connected to the network.

: **failed**

Check the settings and connections. And then select [Retry].

- To set manually, select [Manual] and set each item. For details ➔ (p. 71)

6. Go to the next step **4**



(Press twice)

[WPS(Push button)]

1. Press the WPS button on the access point until the light flashes
2. Connect the Wireless LAN Adaptor and the access point

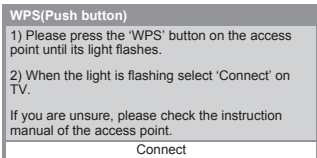

- Ensure that your access point supports WPS for this setup.
- WPS : Wi-Fi Protected Setup™
- If the connection has failed, check the settings and positions of your access point. And then, follow the on screen instructions.

3. After the access point setting is finished, perform the connection test

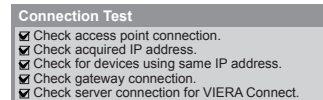

: **succeeded**

The test is successful and the TV is connected to the network.

: **failed**

Check the settings and connections. And then select [Retry].

- To set manually, select [Manual] and set each item. For details ➔ (p. 71)

4. Go to the next step **4**



(Press twice)

5 Input Owner ID



Please enter your own choice of PIN number, name, etc. to help the police to crack crime.

- Make a note of the PIN number in case you forget it. The PIN number cannot be reset.
- You can input or change the Owner ID later. ➔ [Owner ID] (p. 56)
- To skip this step

EXIT



- This step will be skipped in the Auto Setup after [Shipping Condition] (p. 55) is performed.

How to input Owner ID

1 Enter the PIN number (4 digits)



- Enter the PIN number twice at first setting.

2 Select the item (NAME / HOUSE NO / POSTCODE)



3 Enter your name, house number and postcode

Set characters

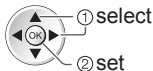
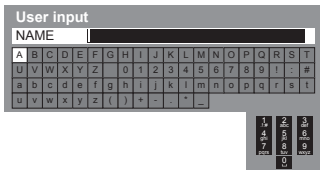

- You can set characters by using numeric buttons.
- ➔ **“Characters table for numeric buttons” (p. 91)**

Return to select other items



- Select the next item and repeat the operations.

4 Exit to go to next step



Select [Home]

Select [Home] viewing environment (highlight [Home] in yellow) to use in your home environment.



■ [Shop] viewing environment (for shop display only)

[Shop] viewing environment is the demonstration mode to explain main features of this TV.

Select [Home] viewing environment to use in your home environment.

- You can return to viewing environment selection screen at the stage of Shop confirmation screen and Automatic Demo Off / On selection screen.

1 Return to viewing environment selection screen

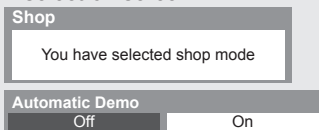

2 Select [Home]

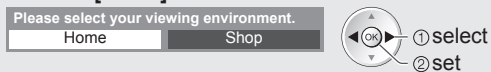

To change viewing environment later on, you will need to initialise all settings by accessing Shipping Condition. ➔ **[Shipping Condition] (p. 55)**

Auto Setup is now complete and your TV is ready for viewing.

If tuning has failed, check the connection of the RF cable, and then, follow the on screen instructions.

- To check channel list at-a-glance ➔ **“Using TV Guide” (p. 22)**
- To edit or hide (skip) channels ➔ **“Tuning and Editing Channels” (p. 47 - 50)**
- To retune all channels ➔ **[Auto Setup] (p. 46)**
- To initialise all settings ➔ **[Shipping Condition] (p. 55)**

If you connect the Wireless LAN Adaptor later on, the confirmation screen will be displayed for the setup.

- To setup the wireless connection ➔ **(p. 72 - 74)**

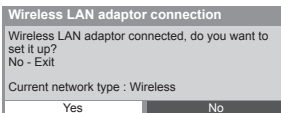

Using "VIERA Connect"

VIERA Connect is a gateway to the internet services unique to Panasonic and has expanded VIERA CAST features greatly.

VIERA Connect allows you to access some specific websites supported by Panasonic, and enjoy internet contents such as photos, videos, games, etc. from VIERA Connect home screen.

• This TV has no full browser function and all features of websites may not be available.



1 Turn power on



- Press for about 1 second
- Mains power On / Off switch should be On. (p. 10)

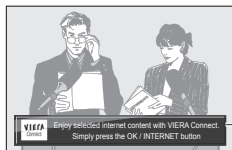

Every time you turn on the TV, VIERA Connect introduction banner appears. The banner is subject to change.

2 Access VIERA Connect

While the banner is displayed



- The button marking varies depending on the remote control supplied with your TV.

Example :



- Depending on the usage conditions, it may take a while to read all the data.
- Messages might be displayed before VIERA Connect home screen. Please read these instructions carefully and follow the on screen instructions.

Example : VIERA Connect home screen



- To go to the next level
➔ [MORE]
- To back to the previous level
➔ [BACK]

■ To exit from VIERA Connect



- To set the VIERA Connect instruction banner display off
➔ [VIERA Connect Banner] (p. 41)

■ How to operate VIERA Connect (current as of January, 2011)

- To move the cursor / select the item



- When the key words are displayed on colour bar
■ (red) ■ (green) □ (yellow) ■ (blue)

- To access



- When options with numbers are displayed



- To return to the previous screen



- To return to VIERA Connect home screen



- Video communication (ex. Skype™) requires an exclusive Communication Camera TY-CC10W.
➔ "Optional accessories" (p. 6)

For details, read the manual of the Communication Camera.

- You can connect a keyboard and a gamepad via USB port for character input and playing games in VIERA Connect. You can also operate the TV with a keyboard or a gamepad other than VIERA Connect features.

For more information ➔ "USB connection" (p. 92)

Note

- If you cannot access VIERA Connect, check the network connections (p. 12) and settings (p. 14, 15).
- For more information of VIERA Connect ➔ (p. 75)

Watching TV

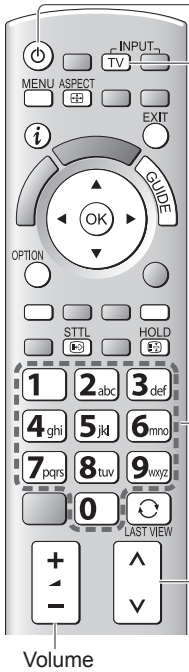

1 Turn power on



- Press for about 1 second
- Mains power On / Off switch should be On. (p. 10)

■ VIERA Connect introduction banner appears

You can access to VIERA Connect and enjoy the various contents. → (p. 17)

- To remove this banner, leave for about 5 seconds or press any buttons (except the buttons to access VIERA Connect).
- To set this banner display off → [VIERA Connect Banner] (p. 41)



2 Select DVB or Analogue



- Also possible to select the mode pressing the TV button repeatedly on the remote control or side panel of the TV (p.10).

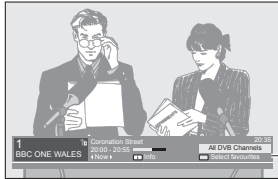

Information banner → (p. 19)

3 Select a channel



- DVB channel position numbers run from 1 onwards.
 Analogue channel position numbers run in the ranges 0 - 99.
- To select a two or three-digit channel position number, e.g. 399

3 def → **9** amp → **9** amp

■ Select a channel using Information banner (p. 19)

It is possible to confirm the channel name and programme information by using the Information banner before changing channels.

1 Display Information banner if it is not displayed



2 While the banner is displayed, select the channel

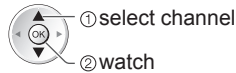

■ Select a channel using TV Guide (p. 22)

It is possible to confirm the channel and programme information by using the TV Guide (EPG) before changing channels.

1 Display TV Guide



2 Select a current programme or channel



3 Select [View] (DVB mode)

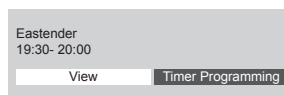

Note

- To watch pay-TV → "Using Common Interface" (p. 57)

Other useful functions

Display Information banner

Display Information banner

-  • Also appears when changing a channel

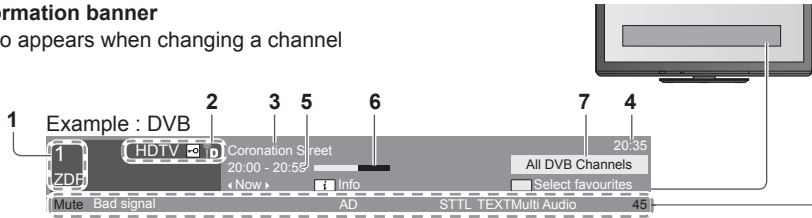

- | | |
|---|---|
| 1 Channel position and name | 5 Programme Start / Finish time (DVB) Channel number, etc. (Analogue) |
| 2 Channel type ([Radio], [Data], [HDTV], etc.) / Encrypted channel (Ⓜ) / TV mode (ID, YA) | 6 Progress time indicator of the selected programme (DVB) |
| 3 Programme | 7 [All DVB Channels] or [Favourites 1-4] (p. 48) (DVB) • To switch  (blue) |
| 4 Current time | |

Features available / Message meanings

[Mute]

Sound mute On

[Bad signal]

Poor TV signal quality

[Also in HD] UK only

Same programme available as HD broadcast

- To display the extra information for details



[AD] UK only

Audio Description service available

- This function can aid visually-impaired viewers by adding an additional audio track to describe events on screen.
- For settings ➔ (p. 38)

[STTL]

Subtitle service available

[TEXT]

Teletext service available

[Multi Audio]

Multiple audio available

[Stereo], [Mono], [NICAM]
Audio mode

1 - 90

Off Timer remaining time
• For settings ➔ (p. 20)

- To confirm another tuned channel name



- To watch the channel listed in the banner



- Information on the next programme (DVB)



- To hide



- Extra information (DVB)
 (Press again to hide the banner)

- To set display timeout
➔ [Banner Display Timeout] (p. 41)

- [AD], [STTL], [TEXT], [Multi Audio] indications are displayed as available on particular programmes, but may not be available for all individual programmes being broadcast. Display the extra information to confirm availability of these functions.

Example :



Last view

Switch to previously viewed channel or input mode easily

-  • Press again to return to the present view.

LAST VIEW

Note

- Switching channel is not available while the recording of Timer Programming or Direct TV Recording is in progress.
- Watching less than 10 seconds is not regarded as the previously viewed channel or input mode.

Hold

Freeze / unfreeze picture

HOLD



Display the selectable settings for the current status

Check or change the current status instantly

OPTION



- To change

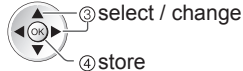
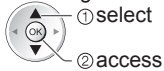

[Audio Description] **UK only**

(DVB mode)

Set to [Auto] if the programme has Audio Description service, then you will hear an additional audio track to describe events on screen

- To adjust the volume for Audio Description

➔ **[Audio Description Menu]** (p. 38)

[Multi Audio]

(DVB mode)

Allows you to select between alternative language for sound tracks (if available)

- This setting is not memorized and it will return to the default setting once you exit the current programme.

[Monaural Audio]

(DVB mode)

Allows you to select stereo / monaural (if available)

- This setting is not memorized and it will return to the default setting once you exit the current programme.

[Subtitle Language]

(DVB)

Allows you to select the language in which subtitles should appear (if available)

- This setting is not memorized and it will return to the default setting once you exit the current programme.

[Teletext Character Set]

Ireland only

Sets the teletext language font

➔ **[Setup Menu]** (p. 40)

[Teletext Language]

Ireland only

(DVB)

Allows you to select between alternative language for teletext (if available)

[NICAM]

(Analogue mode)

Switches NICAM sound (if available)

➔ **[Sound Menu]** (p. 38)

[Volume Correction]

Adjusts volume of individual channel or input mode

Off Timer

Turn the TV off automatically after a fixed period (Off / 15 / 30 / 45 / 60 / 75 / 90 minutes)

1 Display the menu

MENU



2 Select [Timer]



- select
- access

3 Select [Off Timer] and set the time

| Timer Programming | Off |
|-------------------|------------|
| Off Timer | 15 minutes |
| Auto Standby | 30 minutes |
| | 45 minutes |
| | 60 minutes |
| | 75 minutes |
| | 90 minutes |



- select [Off Timer]
- access



- select the time
- store

- To cancel ➔ Set to [Off] or turn the TV off.
- To display the remaining time ➔ **"Display Information banner"** (p. 19)
- When the remaining time is within 3 minutes, the remaining time will flash on the screen.

Aspect

Change the aspect ratio (image size)

ASPECT  Enjoy viewing the image at its optimum size and aspect. Programmes usually contain an “Aspect Control Signal” (Widescreen signal, etc.), and the TV will choose the aspect ratio automatically according to the “Aspect Control Signal” (p. 87).

■ If you would like to change the aspect ratio manually

1 Display Aspect Selection list



Aspect Selection list

2 While the list is displayed, select the mode

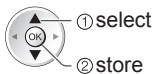

• You can also change the mode only using the ASPECT button.

ASPECT  (Press repeatedly until you reach the desired mode)

[Auto]



The best ratio is chosen and the image expanded to fill the screen. For details ➔ (p. 87)

[16:9]



Directly displays the image at 16:9 without distortion (anamorphic).

[Zoom1]



Displays a 16:9 letterbox or 4:3 image without distortion.

[14:9]

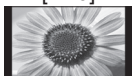

Displays the image at the standard 14:9 without distortion.

[Zoom2]

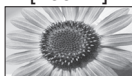

Displays a 16:9 letterbox (anamorphic) image full-screen without distortion.

[4:3]



Displays the image at the standard 4:3 without distortion.

[Zoom3]

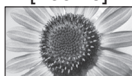

Displays a 2.35:1 letterbox (anamorphic) image full-screen without distortion. At 16:9, displays the image at its maximum (with slight enlargement).

Note

- Aspect is fixed to [16:9] when [Viewing Mode] is set to [Game] in the Picture Menu.
- Aspect cannot be changed in teletext service and 3D mode (except for [2D → 3D] mode in [3D Mode Selection] (p. 32)).
- Aspect mode can be memorized separately for SD (Standard definition) and HD (High definition) signals.

Display subtitles

- Subtitles may not be displayed properly in 3D images.

■ DVB mode

Display / hide subtitles (if available)

STTL  • To change the language for DVB (if available)
➔ [Preferred Subtitles] (p. 40)

■ Analogue mode

Display subtitles



Hide subtitles



Note

- This is the same as switching to Analogue teletext service and selecting “P888” (subtitle service). (p. 27)
- You cannot change the channel when this function is active.

Using TV Guide

TV Guide—Electronic Programme Guide (EPG) provides an on screen listing of the programmes currently broadcast and the forthcoming broadcasts over the next seven days (depending on the broadcasters).

- This TV supports the GUIDE Plus+ system. **UK only**
- The Rovi branding partner will supply the rating information in the programme information and the recommended group in the Search list. **UK only**
- DVB and Analogue channels are displayed on the same TV Guide screen. [D] means DVB channel and [A] means Analogue channel. There will be no programme listings for Analogue channels.
- When this TV is turned on for the first time, or the TV is switched off for more than a week, it may take some time before TV Guide is completely shown.

Using TV Guide

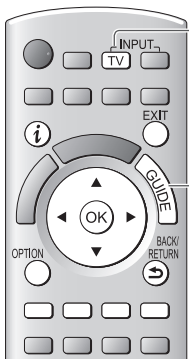

1 Select DVB or Analogue

→ (p. 18)

2 View TV Guide

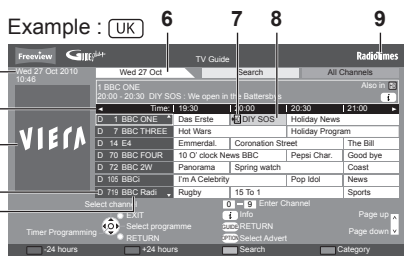

- 1 Current date and time
- 2 TV Guide time
- 3 Advertisement
- 4 [D] : DVB
[A] : Analogue
- 5 Channel position and name
- 6 TV Guide date

■ To return to TV

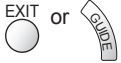

- 7 Some programmes may also be broadcast in HD **UK only**
 - You can select HD or SD broadcast before viewing or setting Timer Programming.
- 8 Programme
- 9 Logo of the Rovi branding partner **UK only**

■ To change the layout of TV Guide → [TV Guide View] (p. 39)

■ To watch the programme

1 Select a current programme or channel



2 Select [View] (DVB mode)

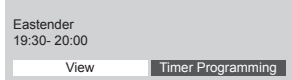

• If a programme exists in both HD and SD broadcasts, the [View Options] screen will be displayed to select HD or SD broadcast. (DVB mode) **UK only**

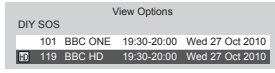

• To use Timer Programming → (p. 23)

■ To the previous day (DVB mode)



■ To the next day (DVB mode)



■ View details of the programme (DVB mode)

1 Select the programme



2 View details

• Press again to return to TV Guide.

■ To view a channel list of the selected category



(Category list)



— Only Analogue channels are listed

• To list favourite channels → (p. 48)

■ To search programme types and view a channel list of the searched programmes (DVB mode)

(yellow)

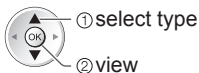
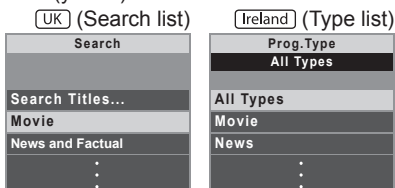

■ To search programme titles and view a list of the searched programmes (DVB mode) **UK only**

(yellow)



1 Select [Search Titles...]

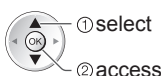

2 Set characters (maximum: 19 characters)



• To use numeric buttons
→ "Characters table for numeric buttons" (p. 91)

3 Start [Search] (green)

- All the programme titles including the word you set will be listed.
- Searching without any characters will list all programmes including current programmes.

Timer Programming (DVB mode)

Timer Programming can remind you to watch a programme or record one on an external recorder.

1 Select the forthcoming programme



2 Select the function ([Ext Rec.] or [Reminder])

(Timer Programming screen)

| Function | No. | Channel Name | Date | Start | End |
|------------|-----|--------------|------------|-------|-----------------|
| [Ext Rec.] | 119 | BBC HD | Wed 27 Oct | 19:30 | 20:00 (30 min.) |
| [Reminder] | 119 | BBC HD | Wed 27 Oct | 19:30 | 20:00 (30 min.) |

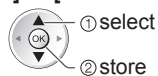

LED will turn to orange if Timer Programming is set. (Orange LED will flash if the recording of Timer Programming is in progress.)

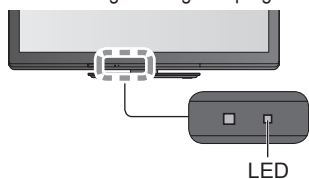

[Ext Rec.] :

to record the programme to the external recorder
When the start time comes, the channel will be switched automatically and the video and audio signals will be output. 2 minutes before the starting time, a reminder message appears if you are watching TV.

[Reminder] :

to remind you to watch the programme
When you are watching TV, a reminder message appears 2 minutes before the start time. Press the OK button to switch to the programmed channel.

■ To check / change / cancel a timer programming event

→ "Timer Programming" (p. 51, 52)

■ If you select a current programme

A confirmation screen asking whether you wish to watch or record the programme will appear. Select [Timer Programming] and set [Ext Rec.] to record from the time you finish the timer programming event setting.

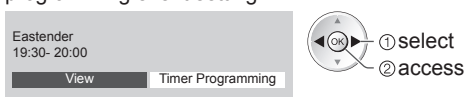

■ To return to TV Guide



■ If a programme exists in both HD and SD broadcasts

UK only

The [Timer Options] screen will be displayed to select HD or SD broadcast.



HD will be displayed if HD broadcast is set.

Note

- This function is not available in Analogue mode.
- Timer Programming reminder messages will remain displayed until one of the following occurs:
 - You press the OK button to view the programme or the EXIT button to cancel the reminder.
 - The timer programming event that the reminder is set for ends.
- No other channel can be selected while the recording of Timer Programming is in progress.
- When recording programmes, be sure to make the proper settings on the recorder connected to the TV. ➔ (p. 51)

Guide link programming (Timer Programming from the TV Guide signal) **UK only**

Guide link programming is Timer Programming which is controlled by information from the TV Guide; if programme start and end times are changed by the broadcaster, the timer programming event will follow the change. A Split Programme programming is a Guide link programming which is interrupted by one or more other programmes.

Note that Guide link programming (including Split Programme programming) only works reliably if correct information is received from broadcasters.

(Timer Programming screen)

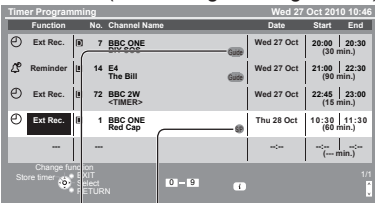

"S/P" is displayed if the timer is set from the TV Guide and the programme is a Split Programme

"Guide" is displayed if the timer is set from the TV Guide (Guide link programming)

Example : **UK**



"S/P" or "G" will be displayed in the TV Guide if Timer Programming is set as the Guide link programming.

Note

- If you edit the start time or end time of a Guide link programming event by more than 10 minutes, it will no longer follow the broadcaster's changes to the start or end time. The start and end times will become fixed.
- Whilst making the Split Programme programming event for [Ext Rec.], you cannot record any channels between the interrupted programmes.
- The Split Programme programming event for Reminder will be cleared by pressing the OK button once to view.
- The Split Programme programming event for Reminder will switch to the programmed channel by pressing the OK button even if it is between the interrupted programmes.
- The Split Programme programming does not work if the separated parts are broadcast on different channels.

View advertisement **UK only**

Enter your postcode when using this function for the first time

➔ **[Guide Plus+ Postcode]** in **[TV Guide Settings]** (p. 39)

If you have already entered your postcode in "Auto Setup" - when first using the TV (p. 13 - 16), you do not have to enter it again.

If you enter an incorrect postcode for your area, or no postcode is entered, advertisements may not be displayed correctly.

Display advertisement information

OPTION



- To display the latest advertisement, you will need to update the information.
- To update the information continuously, the TV must be left in Standby mode.

■ To change advertisements



■ To return to TV Guide

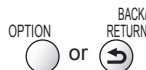

Note

- Some advertisements are for future programmes. In this case it is possible to use the Guide link programming function.
- The advertisements displayed on the TV Guide are sent from the GUIDE Plus+ system so that they cannot be deleted manually or will not be lost even when the TV is turned Off with Mains power On / Off switch.

Viewing Teletext

You can enjoy news, weather forecasts and subtitles, etc. (depending on the broadcaster)

- The availability of teletext services for a programme is indicated by [TEXT] in the information banner.

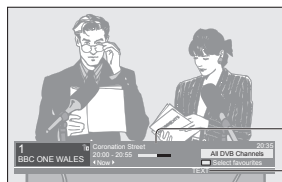

Information banner → (p. 19)

Displayed if programme has teletext service

Ireland

Depending on the broadcaster, the digital teletext (MHEG) services may not be available. In this case, the operation of the teletext services may be the same as the analogue teletext services (p. 26).

Digital teletext (MHEG)

Digital teletext services differ greatly from analogue teletext.

When you switch to a digital teletext service, the images you see can contain graphics and text, laid out and controlled in a manner decided by the broadcaster.



1 Select DVB → (p. 18)



- DVB programmes have digital teletext services (MHEG).

2 Switch to Teletext



Example :

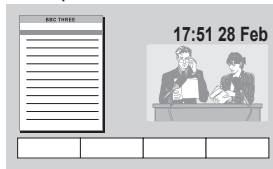

■ How to operate services

In all cases, it is possible to navigate the pages using buttons on the remote control, but because the commands available must apply to all manufacturers of digital equipment, some on screen commands may not correspond exactly to the remote control buttons.

- Select, go



- Back key



- Symbol : ◀▶▲▼



- Coloured characters



Coloured button

- When options with numbers are displayed



Note

- As soon as you switch to a digital channel with links to a teletext service, software is downloaded in the background to enable the teletext function. This means that when switching to a digital channel, you should wait for approximately 5 seconds before pressing the TEXT button - this will allow the software to download. If you press the TEXT button before download is complete, it will be ignored and you will have to press the TEXT button again when the download is complete.
- While navigating digital teletext, you will find there is a short delay when moving between pages while the page downloads. There is often a prompt shown somewhere on the page (for example "Loading") to let you know that this is happening.

■ To return to TV



Analogue teletext

Analogue teletext services are the text information provided by the broadcasters. The features may vary depending on the broadcasters.

What is FASTEXT mode?

In FASTEXT mode, four differently coloured subjects are situated at the bottom of the screen. To access more information about one of these subjects, press the appropriately coloured button. This facility enables fast access to information on the subjects shown.

What is List mode?

In List mode, four differently coloured page numbers are situated at the bottom of the screen. Each of these numbers can be altered and stored in the TV's memory. → **"Store frequently viewed pages"** (p. 27)

■ To change mode → [Teletext] (p. 40)

Viewing Teletext

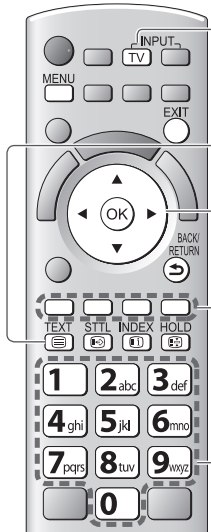

1 Select Analogue
→ (p. 18)



2 Switch to Teletext



• Displays the index page (content varies depending on the broadcasters)

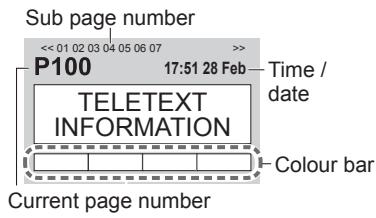

3 Select the page



or Coloured button
(Corresponds to the colour bar)

■ To return to TV



■ To adjust contrast



As the blue bar is displayed



FULL / TOP / BOTTOM

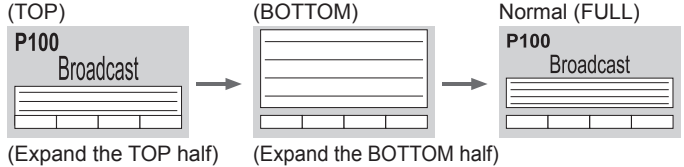

Reveal hidden data

Reveal hidden words e.g. quiz page answers



• Press again to rehide

HOLD

Stop automatic updating

(If you wish to hold the current page without updating)



• Press again to resume

INDEX

Return to the main index page



Subtitles

View a favourite page stored



- Factory setting is "P888" (subtitle service) on the blue button (List mode).

View in multi window

Watch TV and Teletext in two windows at once



- Operations can be made only in Teletext screen.
- Each time pressed: Teletext → TV and Teletext ← TV

Store frequently viewed pages

Store frequently viewed pages in the colour bar (List mode only)

As page is displayed



(Corresponding coloured button)



press and hold

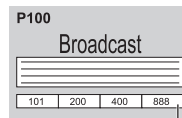

- If you wish to use Subtitles, do not change number on blue button.

The number changes to white.

■ To change stored pages



Coloured button you want to change



Enter new page number



press and hold

View sub page

View sub page (Only when teletext is more than one page)



<<01 02 03 04 05

Appears at top of the screen

- The number of sub pages varies depending on the broadcasters (up to 79 pages).
- It may take some time for searching, during which time you can watch TV.

■ To view specific sub page



(blue)



Enter the 4-digit number example : P6

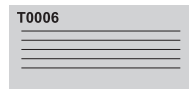

Watch TV while waiting for update

View the TV picture while searching for a teletext page

Teletext automatically updates itself when new information becomes available.

Changes to TV screen temporarily



(yellow)



Appears when updating is completed



View the updated page (yellow)

(You cannot change the channel.)

- The news page provides a function that indicates arrival of latest news ("News Flash").

Watching External Inputs

Connect the external equipment (VCRs, DVD equipment, etc.) and you can watch through the AV input.

- To connect the equipment ➔ (p.11, 12, 84 - 86)

The Remote Control is capable of operating some functions of selected external equipment.

- ➔ **“Operating the equipment with the TV remote control”** (p. 29)



1 Turn the TV on



When connecting with SCART as example 2 or 3 (p. 11, 12)

Receives input signals automatically when playback starts

- Input signals are automatically identified by the SCART (pin 8) terminal.
- This function is also available for HDMI connections (p. 91).

If input mode is not switched automatically

Perform **2** and **3**

- Check the setup of the equipment.

2 Display the input selection menu



3 Select the input mode connected to the equipment

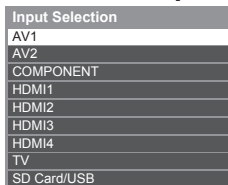

- You can also select the input using the AV button on the remote control or the side panel of the TV (except [SD Card/USB]). Press the button repeatedly until the desired input is selected.

- [SD Card/USB] : Switches to Media Player ➔ **[Using Media Player]** (p. 59)
- You can label or skip each input mode (except [SD Card/USB]).

- ➔ **“Input Labels”** (p. 54)

Skipped inputs will not be displayed when the AV button is pressed.

4 View

AV1 ————— Displays the selected mode

- To return to TV



| Terminal | AV1 | AV2 | COMPONENT | HDMI1 | HDMI2 | HDMI3 | HDMI4 |
|--|----------------------|-----|-----------|---|---------------------------------------|---------------------------------------|---------------------------------------|
| Manual input (default setting in "Input Labels") | AV1 AV1-RGB | AV2 | COMPONENT | HDMI1 | HDMI2 | HDMI3 | HDMI4 |
| Auto input (EC mode or VIERA Link) | EC/AV1 EC/AV1-RGB | - | - | EC/HDMI1 Applicable for EC mode and VIERA Link | EC/HDMI2 Applicable for VIERA Link | EC/HDMI3 Applicable for VIERA Link | EC/HDMI4 Applicable for VIERA Link |









- If the above information is permanently displayed on the top left of the screen, press the **i** button to clear.

Note

- If the external equipment has an aspect adjustment function, set it to [16:9].
- For details, see the manual of the equipment or ask your local dealer.

Operating the equipment with the TV remote control

The equipment connected to the TV can be directly operated with the below buttons of this TV remote control.

| | |
|---|---|
|  | <p>Selection Switch for operating the connected equipment Select "DVD/VCR" to operate Panasonic DVD Recorder, DVD Player, Player theatre, Blu-ray Disc theatre or VCR ➔ "How to change the code for the type of the equipment" (see below) Select "TV" to use Media Player or VIERA Link ➔ "Media Player" (p. 60) ➔ "VIERA Link Control" (p. 82)</p> |
|  | <p>Standby Set to Standby mode / Turn on</p> |
|  | <p>Play Playback videocassette / DVD / video content</p> |
|  | <p>Stop Stop the operations</p> |
|  | <p>Rewind / Skip / Search VCR : Rewind, view the picture rapidly in reverse DVD / video content : Skip to the previous track, title or chapter Press and hold to search backward</p> |
|  | <p>Fast-forward / Skip / Search VCR : Fast-forward, view the picture rapidly forward DVD / video content : Skip to the next track, title or chapter Press and hold to search forward</p> |
|  | <p>Pause Pause / Resume DVD : Press and hold to play at slow speed</p> |
|  | <p>Channel Up / Down Select channel</p> |
|  | <p>Record Start recording</p> |

How to change the code for the type of the equipment

Each type of the Panasonic equipment has its own remote control code.
 Please change the code according to the equipment you want to operate.

1 Set the position to "DVD/VCR"



2 Press and hold during the following operations

Enter the appropriate code, see table below



| Type of the equipment | Code |
|---|--------------|
| DVD Recorder, DVD Player, Blu-ray Disc Player | 70 (default) |
| Player theatre, Blu-ray Disc theatre | 71 |
| VCR | 72 |

Note

- Confirm if the remote control works correctly after changing the code.
- The codes may be reset to default values if batteries are replaced.
- Some operations may not be possible on some equipment models.

Viewing 3D images

You can enjoy viewing 3D images with contents or programmes corresponding to the 3D effect by wearing the 3D Eyewear. ➔ **“Optional accessories” (p. 6)**

This TV supports [Frame Sequential]*1, [Side by Side]*2 and [Top and Bottom]*3 3D formats.

*1 : The 3D format that the images for the left and right eyes are recorded with the high definition quality and alternately played back

*2, *3 : Other available 3D formats

• How to view the 3D images ➔ **(see below)**

Caution

To enjoy 3D images safely and comfortably, please read these instructions fully.

Viewing 3D Content

- Do not use the 3D Eyewear if you have a history of over-sensitivity to light, heart problems, or have any other existing medical conditions.
- Please stop using the 3D Eyewear immediately, if you feel tired, are not feeling well or experience any other uncomfortable sensation.
- When you set the effect by using [3D Adjustment], take into account that the vision of 3D images varies among different individuals.
- Take an appropriate break after viewing a 3D movie.
- Take a break of between 30 - 60 minutes after viewing 3D content on interactive devices such as 3D games or computers.
- Be careful not to strike the TV screen or other people unintentionally. When using the 3D Eyewear the distance between the user and screen can be misjudged.
- The 3D Eyewear must only be worn when viewing 3D content.
- If you do not look toward the TV screen for a while when viewing 3D images, the 3D Eyewear may be turned off automatically.
- If you suffer from any eyesight problems (short / far-sighted, astigmatism, eyesight differences in left and right), please ensure to correct your vision before using the 3D Eyewear.
- Stop using the 3D Eyewear if you can clearly see double images when viewing 3D content.
- Do not use the 3D Eyewear at a distance less than the recommended distance.

The recommended viewing distance is at least 3 times of image height.

TX-P42ST31B : 1.6 m or more

TX-P50ST31B : 1.9 m or more

When the top and bottom area of the screen is blackened, such as movies, view the screen at a distance at least 3 times further than the height of the actual image. (That makes the distance closer than above recommended figure.)

3D Eyewear Use

- Pay special attention when children are using the 3D Eyewear.
3D Eyewear should not be used by children younger than about 5 - 6 years old, as a guideline. All children must be fully supervised by parents or guardians who must ensure their safety and health throughout the using 3D Eyewear.
- Before using the 3D Eyewear, ensure no breakable objects surrounding the user to avoid any accidental damage or injury.
- Remove the 3D Eyewear before moving around to avoid falling or accidental injury.
- Always store the 3D Eyewear in the case supplied with the 3D Eyewear when not in use.
- Use the 3D Eyewear only for the intended purpose and nothing else.
- Do not use 3D Eyewear in the condition of high temperature.
- Do not use if the 3D Eyewear is physically damaged.
- Do not use any devices that emit the infrared signals near the 3D Eyewear, as this may cause the 3D Eyewear false operations.
- Do not use devices (such as mobile phones or personal transceivers) that emit strong electromagnetic waves near the 3D Eyewear as this may cause the 3D Eyewear to malfunction.
- Do not expose the infra-red receiver section to bright light such as direct sunshine and fluorescent light. The 3D image may not be displayed correctly.
- Stop using the 3D Eyewear immediately if a malfunction or fault occurs.
- Stop using the 3D Eyewear immediately if you experience any redness, pain, or skin irritation around the nose or temples.
- In rare cases, the materials used in the 3D Eyewear may cause an allergic reaction.

To view the 3D images

You can enjoy the 3D images in a variety of ways.

(Frame Sequential, Side by Side and Top and Bottom are the supported 3D format.)

■ Playing back 3D-compatible Blu-ray disc (Frame Sequential format)

- Connect the 3D-compatible player via a fully wired HDMI compliant cable.
- If input mode is not switched automatically, select the input mode connected to the player. (p. 28)
- If you use the non 3D-compatible player, the images will be displayed on 2D mode.

■ 3D-supported broadcast

- Please consult the suppliers of contents or programmes for availability of this service.

■ 3D photos and 3D videos taken by 3D-compatible Panasonic products

- Available in Media Player (p. 59)

■ 2D images converted to 3D

Set to [2D→3D] mode in [3D Mode Selection] (p. 32)

1 Turn the 3D Eyewear on

2 Put on the 3D Eyewear

3 Watch the 3D images

- Safety precautions will be displayed when you first watch the 3D image. Select [Yes] or [No] to continue to view 3D images. If you select [Yes], this message will be displayed again in the same condition after Mains power On / Off switch is next turned On. Select [No] if you do not wish to display this message again.

Example :

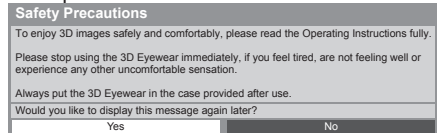

4 Turn off the 3D Eyewear after using it

Note

- 3D Eyewear is not included. Please purchase as necessary. (p. 6)
- For more detail about using and wearing the 3D Eyewear, please refer to the manual of the 3D Eyewear.
- The 3D image or 3D effect may not be available while VIERA Connect home screen (p. 17) is displayed or Ext Rec. of Timer Programming (p. 52) / Direct TV Recording (p. 78, 80) is in progress. As for the contents of the Frame Sequential format and Side by Side (Full), no images will be displayed in these conditions.
- If the room is lit by fluorescent lights / dimmers (50 Hz) and light appears to flicker when using the 3D Eyewear, switch off the fluorescent light or set [3D Refresh Rate] to [100Hz] (p.37).
- 3D content will not be correctly visible if the 3D Eyewear is worn upside down or back-to-front.
- Do not wear the 3D Eyewear when watching anything other than 3D images. Liquid crystal displays (such as computer screens, digital clocks or calculators, etc.) may be difficult to see while wearing the 3D Eyewear.
- Do not use the 3D Eyewear as sunglasses.
- 3D effects may be perceived differently depending on the person.

Available range for the 3D Eyewear

If the 3D Eyewear is placed outside the coverage area for about 5 minutes, the 3D Eyewear will be turned off automatically.

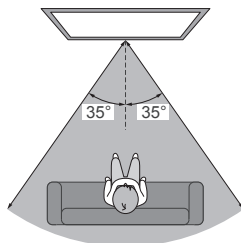

View from the top

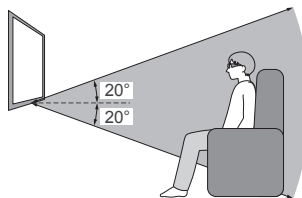

View from the side

● : Coverage area for using the 3D Eyewear

Note

- You cannot view the 3D images with the 3D Eyewear too far from the TV, because of the difficulty of receiving infrared signals from the TV.
- The range may be shortened depending on the obstacles between the infrared sensors on the TV and the 3D Eyewear, the dirt on the infrared sensors or the surrounding environment.
- If you do not look toward the TV screen for a while when viewing 3D images, the 3D Eyewear may be turned off automatically even if in the coverage area.

Changing 2D - 3D mode

You can easily change the viewing mode between 2D and 3D using the 3D button.



Select the mode

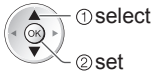

- Items of [3D Mode Selection] vary depending on the condition.

[3D] / [2D] / [2D→3D] :

Displays the appropriate image that you desire without selecting 3D format

- This mode may not work properly depending on the source image format. In this case, select the appropriate 3D format manually.

■ To change 3D format manually

When the image is not changed properly using [3D], [2D] or [2D→3D] mode, use this manual setting.

During the above operation



Select the mode

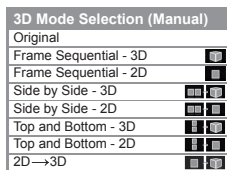

[Original] :

Displays the source image as it is

- Use to identify the format type of the source image.

➔ "Table of images that can be seen for each [3D Mode Selection (Manual)] and the source image format" (see below)

[Frame Sequential - 3D] / [Frame Sequential - 2D] / [Side by Side - 3D] / [Side by Side - 2D] / [Top and Bottom - 3D] / [Top and Bottom - 2D] :

Displays the mode you select

- Not valid on Analogue and AV mode

[2D→3D] :

Converts 2D images into 3D

- For DVB, Analogue, AV, Component, HDMI, Media Player and VIERA Connect
- On-screen displays are also seen in 3D in this mode.
- Please note the 3D images appear slightly different from the originals.
- Using this function for profit-making purposes, or publically showing images converted from 2D to 3D in places such as shops or hotels etc. may infringe on the rights of the copyright holder protected under copyright law.

Table of images that can be seen for each [3D Mode Selection (Manual)] and the source image format
If the picture appears to be abnormal, refer to the table below to choose the correct 3D mode.

| [3D Mode Selection] | [Original] | [Frame Sequential - 3D] | [Side by Side - 3D] | [Top and Bottom - 3D] | [2D→3D] |
|---------------------|------------|-------------------------|---------------------|-----------------------|---------------|
| Source image format | | | | | |
| Frame Sequential | | Normal 3D*1 | | | |
| Side by Side (Full) | | | Normal 3D*1 | | |
| Side by Side | | | Normal 3D*1 | | |
| Top and Bottom | | | | Normal 3D*1 | |
| Normal format (2D) | | | | | Normal 3D |

*1 : When selecting [Frame Sequential - 2D], [Side by Side - 2D] or [Top and Bottom - 2D], the images will be displayed without 3D effect.

If the 3D images are not displayed correctly or seem unusual, please adjust and setup the 3D settings.



1 Display the menu



2 Select [Picture]

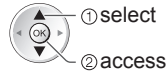
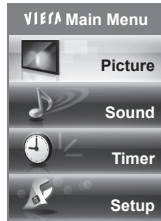

3 Select [3D Settings]

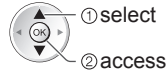
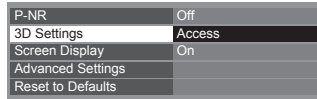

4 Select one of the following functions and set

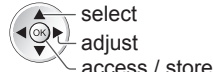
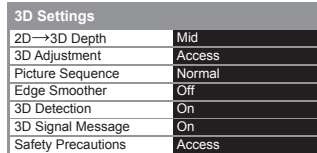

■ To return to TV



| Item | Adjustments / Configurations (alternatives) |
|---------------------------|--|
| 2D→3D Depth | Selects a level of 3D-image depth for viewing converted 2D images [Min] / [Mid] / [Max] |
| 3D Adjustment | Adjustment of the 3D effect (except in [2D→3D] mode) [Off] / [On] • Set to [On] to enable [Effect] setting. • When setting to [On], a safety precaution message will appear. Read it carefully and then press the BACK/RETURN button to go to [Effect] setting. [Effect] : Adjust the 3D depth according to the contents or to your preference. |
| Picture Sequence | Select [Reverse] if you feel that the sense of depth is unusual (except in [2D→3D] mode) [Normal] / [Reverse] |
| Edge Smoother | Set to [On] if you feel the contoured parts of an image are not smooth enough (except in [2D→3D] mode) [Off] / [On] |
| 3D Detection | Automatically detects the 3D format signals [Off] / [On] / [On (Advance)] [On (Advance)] : Detects all the 3D format signals and displays the 3D image automatically. [On] : Detects the particular 3D format signals (Frame Sequential, etc.) and displays the 3D image automatically. • To view 3D images without any notifications and operations, set to [On (Advance)]. |
| 3D Signal Message | Selects whether to give a notification message when a signal of 3D format is found [Off] / [On] • For DVB, Component and HDMI • This function is not available when [3D Detection] is set to [On (Advance)]. |
| Safety Precautions | Displays the precautions for viewing 3D images |

Note

• [3D Adjustment] and [Picture Sequence] will not be memorized when changing the input mode or channel.

How to Use VIERA TOOLS

You can access some special features easily by using the VIERA TOOLS function.

- For [VIERA Link Control] function to operate correctly, ensure the connections and settings are completed.
 - ➔ **“Summary of Q-Link and VIERA Link features” (p. 76, 77), “Preparations” (p. 79)**
After connection, turn the equipment on and then switch the TV on.
- For [Photo], [Video] and [Music] functions to operate correctly, ensure the device has photo, video or music data on it and insert it into the SD Card slot or USB port properly.
 - ➔ **“Using Media Player” (p. 59)**



1 Display icons of the feature



2 Select a feature



■ To return to TV



■ Follow the operations of each feature

[VIERA Link Control]

➔ **“VIERA Link Control” (p. 81)**



When two or more compatible equipment are connected, a selection screen will be displayed. Please select the correct description and access.

[Photo]*

➔ **“Photo mode” (p. 60)**



[Video]*

➔ **“Video mode” (p. 65)**



[Music]*

➔ **“Music mode” (p. 67)**



* When two or more available devices are connected, a selection screen will be displayed. Please select the correct description and access.

Note

- If the selected feature is not available, the demonstration to explain how to use it can be displayed. Press the OK button to view the demonstration after selecting the unavailable feature.

How to Use Menu Functions

Various menus allow you to make settings for the picture, sound, and other functions.



1 Display the menu



• Displays the functions that can be set (varies according to the input signal)

2 Select the menu

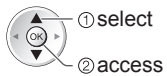
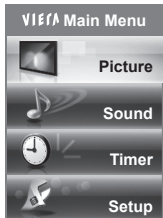

3 Select the item

Example : [Picture Menu]

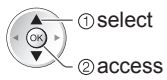
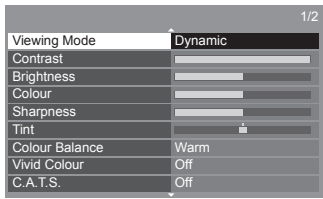

■ Choose from among alternatives

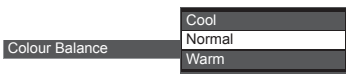

■ Adjust using the slide bar



■ Go to the next screen

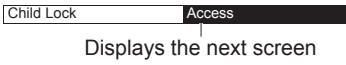

■ Enter characters by free input menu

You can enter names or numbers freely for some items.

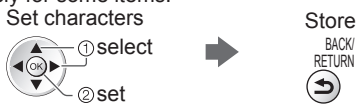
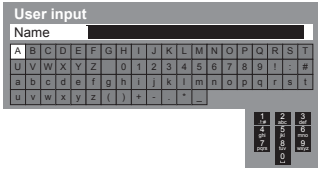

■ To return to TV at any time



■ To return to the previous screen



■ To change menu pages



- You can set characters by using numeric buttons.
- ➔ “Characters table for numeric buttons” (p. 91)

Note

• If “Demo Settings” item is displayed in the Setup Menu, the TV is in “Shop” viewing environment. To return to “Home” viewing environment initialise all settings by accessing Shipping Condition. ➔ (p. 55)

Menu list

| Menu | Item | Adjustments / Configurations (alternatives) |
|----------------|--|---|
| Picture | Viewing Mode | <p>Basic picture mode [Dynamic] / [Normal] / [Cinema] / [True Cinema] / [Game] / [Photo] In each Viewing Mode, [Contrast], [Brightness], [Colour], [Sharpness], [Tint], [Colour Balance], [Vivid Colour], [C.A.T.S.], [P-NR] and [3D-COMB] can be adjusted and stored to suit your particular viewing requirement.</p> <ul style="list-style-type: none"> • Set for each input signal. <p>[Dynamic] : Provides enhanced picture contrast and sharpness when viewing in a bright room.</p> <p>[Normal] : Recommended for viewing under normal ambient room lighting conditions.</p> <p>[Cinema] : For watching movies in a darkened room with the improved performance of contrast, black and colour reproduction</p> <p>[True Cinema] : Precisely reproduces the original quality of the image without any revision.</p> <p>[Game] : Fast response signal specifically to provide suitable images for playing games</p> <ul style="list-style-type: none"> • Not valid on TV mode • A continuous record of time spent using Game mode can be displayed in the top right of the screen. ➔ [Playing Time Display] (p. 41) <p>[Photo] : Set [Reversal Film Effect] to [On] to provide the suitable image quality for photos</p> <ul style="list-style-type: none"> • For HDMI input, Media Player and VIERA Connect |
| | Contrast, Brightness, Colour, Sharpness | Increases or decreases the levels of these options according to your personal preference |
| | Tint | <p>With an NTSC signal source connected to the TV, the picture hue can be adjusted to suit your taste</p> <ul style="list-style-type: none"> • For NTSC signal reception only |
| | Colour Balance | <p>Allows you to set the overall colour tone of the picture [Cool] / [Normal] / [Warm]</p> <ul style="list-style-type: none"> • Not valid when [Viewing Mode] is set to [True Cinema]. |
| | Vivid Colour | Automatically adjusts colours to vivid ones [Off] / [On] |
| | Reversal Film Effect | <p>Provides the picture effect such as the reversal film [Off] / [On]</p> <ul style="list-style-type: none"> • This function is available when [Viewing Mode] is set to [Photo]. |
| | C.A.T.S. | <p>Contrast Automatic Tracking System (Automatic Brightness Control function) Adjusts picture settings automatically dependent on ambient lighting conditions [Off] / [On]</p> <ul style="list-style-type: none"> • Set to [On] to make the suitable contrast setting automatically. The default setting is [On] when [Viewing Mode] is set to [Normal]. |
| | P-NR | <p>Picture Noise Reduction Automatically reduces unwanted picture noise and flicker noise in the contoured parts of a picture [Off] / [Min] / [Mid] / [Max]</p> |
| | 3D-COMB | <p>Makes still or slow moving pictures look more vivid [Off] / [On]</p> <ul style="list-style-type: none"> • Occasionally, whilst viewing still or slow moving pictures, colour patterning may be seen. Set to [On] to display sharper and more accurate colours. • For PAL or NTSC signal reception only • Not valid on RGB, Component, HDMI and Media Player |
| | 3D Settings | Adjusts and sets to view 3D images (p. 33) |
| Screen Display | <p>Turns the screen off when you select [Off] [Off] / [On]</p> <ul style="list-style-type: none"> • The sound is active even if the screen turns off. • Press any buttons (except Standby) to turn the screen on. • This function is effective in reducing power consumption when listening to the sound without watching the TV screen. | |

| Menu | Item | Adjustments / Configurations (alternatives) |
|---------|---|--|
| Picture | Advanced Settings | Intelligent Frame Creation Automatically compensates the picture frame rate and removes juddering movements to make the images smooth [Off] / [Mid] / [Max] <ul style="list-style-type: none"> Depending on the contents, images may be noisy. To prevent the noise, change the setting. This function is not available for selection (default to [Off]) when [Viewing Mode] is set to [Game] or in the mode of VIERA Connect. |
| | | 24p Smooth Film Automatically compensates the picture frame rate to make the 24p source movie images smooth [Off] / [Mid] / [Max] <ul style="list-style-type: none"> This is available only for 24p signal input and displayed instead of [Intelligent Frame Creation]. This function is not available for selection (default to [Off]) when [Viewing Mode] is set to [Game] or in the mode of VIERA Connect. |
| | | Clear Cinema Improves vertical resolution for movie images [Off] / [On] <ul style="list-style-type: none"> This function is available for the interlaced signal (except when [Viewing Mode] is set to [Game]). |
| | | 3D Refresh Rate Reduces juddering and flicker noises of the 3D images [Auto] / [100Hz] <ul style="list-style-type: none"> If the room is lit by fluorescent lights / dimmers (50 Hz) and light appears to flicker when using the 3D Eyewear, set to [100Hz]. |
| | | Resolution Enhancer Enhances the picture resolution to make the image sharper [Off] / [Mid] / [Max] <ul style="list-style-type: none"> This function is available for SD (Standard definition) signal. As for HD (High definition) signal, this function is available when aspect mode is set to [16:9] ([16:9 Overscan] is set to [On]) or [Zoom]. Not valid on Media Player and VIERA Connect |
| | | Side Panel Increases the brightness of the side panel [Off] / [Low] / [Mid] / [High] <ul style="list-style-type: none"> The recommended setting is [High] to prevent panel "image retention". |
| | | 16:9 Overscan Selects the screen area displaying the image [Off] / [On] [On] : Enlarges the image to hide the edge of the image. [Off] : Displays the image in the original size. <ul style="list-style-type: none"> Set to [On] if noise is generated on the edge of the screen. This function is available when aspect is set to [Auto] (16:9 signal only) or [16:9]. This function can be memorized separately for SD (Standard definition) and HD (High definition) signals. Not valid on VIERA Connect |
| | | DVI Input Setting Changes the black level in the image for HDMI input mode with DVI input signal manually [Normal] / [Full] <ul style="list-style-type: none"> When the DVI input signal from the external equipment, especially from PC, is displayed, the black level may not be suitable. In this case, select [Full]. The black level for HDMI input signal will be adjusted automatically. For HDMI input mode with DVI input signal only |
| | | Pixel Orbiter Selects the mode for wobbling of the image to prevent panel "image retention" [Auto] / [On] [Auto] : Automatically works only for the appropriate images and you rarely recognise the wobbling. |
| | | Scrolling Bar Scrolls the vertical bar to prevent panel "image retention" <ul style="list-style-type: none"> Press the OK button to start scrolling and press any buttons (except Standby) to exit this mode. |
| | Reset to Defaults Press the OK button to reset the present Picture Viewing Mode to the default settings | |
| Sound | Mode | Selects the basic sound mode [Music] / [Speech] / [User] <ul style="list-style-type: none"> The selected mode affects all input signals. [Music] : Improves sound quality for watching music videos, etc. [Speech] : Improves sound quality for watching news, drama, etc. In Music and Speech modes, you can adjust [Bass] and [Treble] settings, and those settings will be stored for each mode. [User] : Adjusts the sounds manually by using the equaliser to suit your favourite sound quality. For the User mode, [Equaliser] will appear on the Sound Menu instead of [Bass] and [Treble]. Select the [Equaliser] and adjust the frequency. ➔ [Equaliser] (p. 38) |
| | | Bass Increases or decreases level to enhance or minimise lower, deeper sound output |
| | | Treble Increases or decreases level to enhance or minimise sharper, higher sound output |
| | | |

| Menu | Item | Adjustments / Configurations (alternatives) | |
|------------|--------------------------|---|---|
| Sound | Equaliser | Adjusts the frequency level to suit your favourite sound quality <ul style="list-style-type: none"> • This function is available when [Mode] is set to [User]. • Select the frequency and change the frequency level by using the cursor button. • If you want to enhance the bass sound, raise the level of the lower frequency. • If you want to enhance the treble sound, raise the level of the higher frequency. • To reset the levels of each frequency to the default settings, select the [Reset to Defaults] by using the cursor button, and then press the OK button. | |
| | Balance | Adjusts volume level of right and left speakers | |
| | Headphone Volume | Adjusts the volume of the headphones | |
| | Surround | Surround sound settings [Off] / [V-Audio] / [V-Audio Surround] [V-Audio] : Provides a dynamic enhancer of width to simulate improved spatial effects [V-Audio Surround] : Provides a dynamic enhancer of width and depth to simulate improved spatial effects | |
| | Auto Gain Control | Automatically regulates large sound level differences between channels and inputs [Off] / [On] | |
| | Volume Correction | Adjusts the volume of individual channel or input mode | |
| | Speaker Distance to Wall | Compensates for the distance between the speakers and the wall [Over 30cm] / [Up to 30cm] <ul style="list-style-type: none"> • If the distance between the TV and wall is over 30 cm, [Over 30cm] is recommended. • If the distance between the TV and wall is within 30 cm, [Up to 30cm] is recommended. | |
| | Preferred Multi Audio | <ul style="list-style-type: none"> • Selects the preferred language for digital channel multi audio (depending on the broadcaster) [English] / [Welsh] / [Gaelic] / [Irish] | |
| | NICAM | Near Instantaneous Companded Audio Multiplex Reproduces NICAM stereo sound [Off] / [On] <ul style="list-style-type: none"> • Off if reception is poor (FM monaural sound) • Analogue mode only | |
| | SPDIF Selection | SPDIF : A standard audio transfer file format Selects the initial setting for digital audio output signal from DIGITAL AUDIO OUT and HDMI2 (ARC function) terminals [Auto] / [PCM] [Auto] : Dolby Digital Plus, Dolby Digital and HE-AAC (48 kHz) multi-channel are output as Dolby Digital Bitstream. MPEG is output as PCM. [PCM] : Digital output signal is fixed to PCM. <ul style="list-style-type: none"> • For DVB mode, VIERA Connect (p. 17, 75) or Video mode of Media Player (p. 65) • ARC (Audio Return Channel) : A function of digital audio output using HDMI cable | |
| | HDMI1 / 2 / 3 / 4 Input | Select to fit the input signal [Digital] / [Analogue] (p. 91) [Digital] : When sound is carried via the HDMI cable connection [Analogue] : When sound is not carried via the HDMI cable connection <ul style="list-style-type: none"> • HDMI input mode only | |
| | Audio Description Menu | Audio Description | [UK only] Narration settings for visually impaired users [Off] / [Auto] Set to [Auto] to activate the narration sound track when available on the broadcast <ul style="list-style-type: none"> • The availability of audio description sound track is indicated by [AD] in the information banner (p. 19). • DVB mode only |
| | | Volume | [UK only] Adjusts the volume for Audio Description <ul style="list-style-type: none"> • DVB mode only |
| | | Speakers | [UK only] Set to [On] to activate the description sound track from TV speakers [Off] / [On] <ul style="list-style-type: none"> • DVB mode only |
| Headphones | | [UK only] Set to [On] to activate the description sound track from headphones [Off] / [On] <ul style="list-style-type: none"> • DVB mode only | |
| | Reset to Defaults | Press the OK button to reset the present Sound Mode, [Balance], [Headphone Volume] and [Surround] to the default settings | |

| Menu | Item | Adjustments / Configurations (alternatives) |
|-------------------|--------------------------|---|
| Timer | Timer Programming | Sets programme reminders and records forthcoming programmes (p. 51) |
| | Off Timer | Sets the time until the TV automatically goes to Standby mode [Off] / [15] / [30] / [45] / [60] / [75] / [90] (minutes) (p. 20) |
| | Auto Standby | Sets the duration of time that the TV will remain On when no operation is received from the user [Off] / [2] / [4] (hours) <ul style="list-style-type: none"> Starting Timer Programming automatically does not affect this function. Automatic input switching with the connected equipment affects this function and time-count will be reset. The notification message will appear 3 minutes before going to Standby mode. |
| TV Guide Settings | TV Guide View | Changes the layout of TV Guide [Normal] / [Full] / [Info] [Normal] : Default TV Guide screen [Full] : Displays channels and programmes full-screen without the operation guide [Info] : Displays details of the selected programme at the bottom without the operation guide |
| | GUIDE Plus+ Postcode | UK only Sets your postcode to display advertisements in the GUIDE Plus+ system (p. 24) |
| | GUIDE Plus+ Information | UK only Displays the system information of the GUIDE Plus+ system |
| Setup | Eco Navigation | Automatically sets the TV to the most suitable energy-saving mode <ul style="list-style-type: none"> If you press the OK button, the following items are set as below : [C.A.T.S.], [VIERA Link], [Standby Power Save], [Power Save] ➔ [On] [Intelligent Auto Standby] ➔ [On (No reminder)] [Auto Standby] ➔ [2 hours] |
| | VIERA Link | Settings for VIERA Link functions [Off] / [On] (p. 79) |
| | HDMI Content Detection | Automatically adjusts picture according to received HDMI content [Off] / [Auto] <ul style="list-style-type: none"> This function is available if the connected equipment supports HDMI Content Type. The content type information will be displayed for several seconds when this function works. |
| | AV1 out | Chooses the signal to be transmitted from the TV to Q-Link [TV] / [AV2] / [Monitor] [Monitor] : Image displayed on screen <ul style="list-style-type: none"> Component and HDMI signals cannot be output. |
| | Standby Power Save | Controls the connected equipment to reduce power consumption in Standby [Off] / [On] (p. 80) <ul style="list-style-type: none"> This function is available when [VIERA Link] is set to [On]. |
| | Intelligent Auto Standby | Makes non-watched or non-used connected equipment go into Standby mode to reduce the power consumption [Off] / [On (With reminder)] / [On (No reminder)] (p. 80) <ul style="list-style-type: none"> This function is available when [VIERA Link] is set to [On]. |
| | Q-Link Download | Downloads analogue channel information to a Q-Link compatible equipment connected to the TV |
| | Child Lock | Applies access control for channels or AV inputs to prevent unwanted access (p. 53) |

| Menu | Item | Adjustments / Configurations (alternatives) | |
|-------------------------------|----------------------|---|---|
| Setup | DVB Tuning Menu | Favourites Edit | Creates a list of favourite DVB channels (p. 48) |
| | | Channel List | Skips the unwanted DVB channels or edits DVB channels (p. 49) |
| | | Auto Setup | Automatically searches for the DVB channels received in the area (p. 46) |
| | | Channel Sorting by Region | UK only Automatically sorts tuned channels according to the available region (p. 47) |
| | | Manual Tuning | Searches for the DVB channels manually (p. 47) |
| | | Update Channel List | Updates DVB Channel List while keeping your settings (p. 49) |
| | | New Channel Message | Searches for whether to give a notification message when a new DVB channel is found [Off] / [On] (p. 48) |
| | | Signal Condition | Checks the DVB signal condition (p. 48) |
| | Analogue Tuning Menu | Channel List | Skips the unwanted Analogue channels or edits Analogue channels (p. 50) |
| | | Auto Setup | Automatically searches for the Analogue channels received in the area (p. 46) |
| | | Manual Tuning | Searches for the Analogue channels manually (p. 50) |
| | Display Settings | Teletext | Analogue teletext display mode [FASTEXT] / [List] (p. 26) |
| | | Teletext Character Set | Ireland only Selects teletext language font [West] / [East1] / [East2] [West] : English, French, German, Greek, Italian, Spanish, Swedish, Turkish, etc. [East1] : Czech, English, Estonian, Lettish, Rumanian, Russian, Ukrainian, etc. [East2] : Czech, Hungarian, Lettish, Polish, Rumanian, etc. |
| | | Preferred Teletext | Ireland only Selects the preferred language for digital channel teletext service (depending on the broadcaster) [English] / [Welsh] / [Gaelic] / [Irish] |
| Preferred Subtitles | | Selects the preferred language for digital channel subtitles (depending on the broadcaster) [English] / [Welsh] / [Gaelic] / [Irish] To display subtitles ⇒ (p. 21) <input checked="" type="checkbox"/> provides aids in understanding and enjoyment with DVB subtitles (depending on the broadcaster). | |
| Input Labels | | Labels or skips each input terminal (p. 54) | |
| Banner Display Timeout | | Sets how long the Information banner (p. 19) stays on screen [0 (No display)] / [1] / [2] / [3] / [4] / [5] / [6] / [7] / [8] / [9] / [10] (seconds) | |

| Menu | Item | Adjustments / Configurations (alternatives) | |
|---------------------------|------------------------------|---|---|
| Setup | Display Settings | VIERA Connect Banner Sets the VIERA Connect introduction banner display [Off] / [On] (p. 17, 18) | |
| | | Playing Time Display Set to [On] to display a continuous record of time spent using Game mode every 30 minutes [Off] / [On] • This function is available when [Game] is selected in [Viewing Mode] ➔ (p. 36) | |
| | | Radio Mode Sets the timer for turning off the screen automatically when a radio channel is selected [Off] / [5] / [10] / [15] / [20] (seconds) • The sound is active even if the screen turns off. • Press any buttons except Standby, Volume Up / Down and Sound Mute buttons to turn the screen on. • This function is effective in reducing power consumption when listening to a radio channel. | |
| | Network Setup | Sets the network setting to use in your network environment (p. 70) | |
| | DivX® VOD | Displays DivX VOD registration code (p. 89) | |
| | System Menu | USB Keyboard Layout | Selects the language that your USB Keyboard supports • For the information of using USB Keyboard ➔ (p. 92) |
| | | Shipping Condition | Resets all settings, for example, when moving house (p. 55) |
| | | Owner ID | Inputs the owner ID (p. 56) |
| | | Common Interface | Settings for watching encrypted channels (p. 57) |
| | | System Update | Downloads new software to this TV (p. 58) |
| Software Licence | | Displays the software licence information | |
| System Information | | Displays the system information of this TV | |
| Other Settings | Power on Preference | Automatically selects the input when the TV is turned on [TV] / [AV] Set to [TV] to view picture from TV tuner. Set to [AV] to view input from an external equipment connected to a SCART terminal, e.g. satellite receiver. • The external equipment must be switched on and sending a control signal for automatic switching at power on to occur. | |
| | Power on Channel List | Automatically selects All Channels or Favourites list in the Information banner (p. 19) when the TV is turned on [All Channel List] / [Last] Set to [All Channel List] to display all the channels. Set to [Last] to display the one you selected last time. • Not available on analogue mode | |
| | USB Charge in Standby | Enables to supply the power from the USB terminal in Standby mode [Off] / [On] • Available for charging 3D Eyewear (optional) • This function is available when in Standby mode. | |
| | Power Save | Reduces brightness of picture to economise on power consumption [Off] / [On] | |

- A different menu will be displayed in the mode of Media Player (p. 59 - 68) / VIERA Connect (p. 17, 75).
- Only available items can be selected.

Overview (Picture, Sound, Timer, Setup)

How to operate → (p. 35)



| | |
|----------------------|----------|
| Viewing Mode | Dynamic |
| Contrast | [Slider] |
| Brightness | [Slider] |
| Colour | [Slider] |
| Sharpness | [Slider] |
| Tint | [Slider] |
| Colour Balance | Warm |
| Vivid Colour | Off |
| Reversal Film Effect | Off |

1/2

| | |
|-------------------|--------|
| C.A.T.S. | Off |
| P-NR | Off |
| 3D-COMB | Off |
| 3D Settings | Access |
| Screen Display | On |
| Advanced Settings | Access |
| Reset to Defaults | Reset |

2/2

(p. 36, 37)

Available in NTSC
Not available when [Viewing Mode] is set to [True Cinema]

Available when [Viewing Mode] is set to [Photo]

Available in NTSC / PAL

| | |
|----------------------------|--------|
| Intelligent Frame Creation | Off |
| 24p Smooth Film | Off |
| Clear Cinema | Off |
| 3D Refresh Rate | Auto |
| Resolution Enhancer | Off |
| Side Panel | Off |
| 16:9 Overscan | Off |
| DVI Input Setting | Normal |
| Pixel Orbiter | Auto |

1/2

| | |
|-------------------|-------|
| Advanced Settings | 2/2 |
| Scrolling Bar | Start |

(p. 37)

| | |
|--------------------|--------|
| 2D→3D Depth | Mid |
| 3D Adjustment | Access |
| Picture Sequence | Normal |
| Edge Smoother | Off |
| 3D Detection | On |
| 3D Signal Message | On |
| Safety Precautions | Access |

(p. 33)

| | |
|--------------------------|-----------|
| Mode | Music |
| Bass | [Slider] |
| Treble | [Slider] |
| Equaliser | Access |
| Balance | [Slider] |
| Headphone Volume | [Slider] |
| Surround | Off |
| Auto Gain Control | Off |
| Volume Correction | [Slider] |
| Speaker Distance to Wall | Over 30cm |

1/2

| | |
|-----------------------|---------|
| Preferred Multi Audio | English |
| NICAM | Off |
| SPDIF Selection | Auto |
| HDMI1 Input | Digital |
| Audio Description | Access |
| Reset to Defaults | Reset |

2/2

(p. 37, 38)

Available when [Mode] is set to [Music] or [Speech]

| | | |
|-----------|--------------------------------|-------------------|
| Equaliser | [7 sliders] | Reset to Defaults |
| | 150 250 500 1k 2k 4k 8k 12k Hz | |

Available when [Mode] is set to [User]

Available in DVB

Available in Analogue

Available in DVB, VIERA Connect or Video mode

Available in HDMI input

| | |
|-------------------|--------|
| Timer Programming | Access |
| Off Timer | Off |
| Auto Standby | Off |

(p. 39)

| | |
|------------------------|----------|
| Audio Description Menu | |
| Audio Description | Off |
| Volume | [Slider] |
| Speakers | Off |
| Headphones | Off |

Available in DVB (UK only) (p. 38)

| Timer Programming | | | | | | Wed 27.10.2010 10:46 | |
|-------------------|-----|-----------------|-----------------|-------|-----------------|----------------------|--|
| Function | No. | Channel Name | Date | Start | End | | |
| Ext Rec. | 72 | BBC 2W <TIMER> | Wed 27 Oct | 20:00 | 21:30 (90 min.) | | |
| Reminder | 14 | E4 The Bill | Wed 27 Oct | 21:00 | 22:00 (60 min.) | | |
| Ext Rec. | 1 | BBC ONE DIY SOS | Wed 27 Oct | 22:45 | 23:00 (15 min.) | | |
| Ext Rec. | 1 | BBC ONE <TIMER> | STTL Thu 28 Oct | 10:30 | 11:30 (60 min.) | | |

Change function: EXIT Select RETURN
Store timer: [Icon]
Remaining Capacity: 500GB (50%)

1/1

(p. 51)

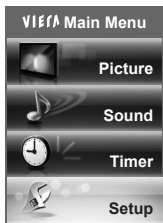

| | |
|----------------------|--------|
| TV Guide Settings | Access |
| Eco Navigation | Access |
| Link Settings | Access |
| Child Lock | Access |
| DVB Tuning Menu | Access |
| Analogue Tuning Menu | Access |
| Display Settings | Access |
| Network Setup | Access |
| DivX® VOD | Access |

(p. 39 - 41)

TV Guide Settings Menu

| | |
|-------------------------|--------|
| TV Guide View | Normal |
| GUIDE Plus+ Postcode | Access |
| GUIDE Plus+ Information | Access |

UK only (p. 39)

Enter Postcode

Postcode

| | | | | | | | | | | | | | | | | | | | |
|---|---|---|---|---|---|---|---|---|---|---|---|---|---|---|---|---|---|---|---|
| A | B | C | D | E | F | G | H | I | J | K | L | M | N | O | P | Q | R | S | T |
| U | V | W | X | Y | Z | 0 | 1 | 2 | 3 | 4 | 5 | 6 | 7 | 8 | 9 | | | | |

1 2 3
4 5 6
7 8 9
0

(p. 39)

Child Lock-PIN Entry

Please enter new PIN

PIN * * * *

(p. 53)

Child Lock

| | |
|-----------------|----------|
| Change PIN | Access |
| Child Lock List | Access |
| Parental Rating | No limit |

Available in DVB (p. 53)
Ireland only

Child Lock List - TV and AV

| Name | Input | Type | Lock |
|-----------------|----------|----------|------|
| 101 BBC 1 Wales | DVB | Free TV | 🔒 |
| 7 BBC THREE | DVB | Free TV | 🔒 |
| 14 E4C | DVB | Free TV | 🔒 |
| VCR | Analogue | Analogue | |
| 1 BBC1 | Analogue | Analogue | |
| 2 **** | Analogue | Analogue | |
| AV1 | External | AV | |
| AV2 | External | AV | |

(p. 53)

Link Settings

| | |
|--------------------------|------------------|
| VIERA Link | On |
| HDMI Content Detection | Off |
| AV1 out | TV |
| Standby Power Save | On |
| Intelligent Auto Standby | On (No reminder) |
| Q-Link Download | Access |

(p. 39)

Sending Preset Data

Please wait!

0% 100%

Remote control unavailable

(p. 39)

Overview (Setup)

How to operate → (p. 35)

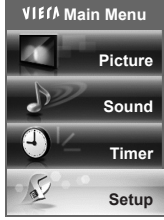

| | |
|----------------------|--------|
| 1/2 | |
| TV Guide Settings | Access |
| Eco Navigation | Access |
| Link Settings | Access |
| Child Lock | Access |
| DVB Tuning Menu | Access |
| Analogue Tuning Menu | Access |
| Display Settings | Access |
| Network Setup | Access |
| DivX® VOD | Access |

| | |
|----------------|--------|
| 2/2 | |
| System Menu | Access |
| Other Settings | Access |

(p. 39 - 41)

| | |
|---------------------------|--------|
| DVB Tuning Menu | |
| Favourites Edit | Access |
| Channel List | Access |
| Auto Setup | Access |
| Channel Sorting by Region | Access |
| Manual Tuning | Access |
| Update Channel List | Access |
| New Channel Message | On |
| Signal Condition | Access |

Available in DVB (p. 46 - 49)

| | | | |
|---------------------------------|--------------|----------|---------|
| DVB Update Channel List | | | |
| Progress | CH 21 | 68 | |
| This will take about 3 minutes. | | | |
| CH | Channel Name | Type | Quality |
| Free TV: 0 | Pay TV: 0 | Radio: 0 | Data: 0 |
| Searching | | | |

(p. 49)

| | |
|-----------------------|------|
| Other Settings | |
| Power on Preference | TV |
| Power on Channel List | Last |
| USB Charge in Standby | Off |
| Power Save | Off |

---Available in DVB
(p. 41)

| | |
|----------------------|--------|
| Analogue Tuning Menu | |
| Channel List | Access |
| Auto Setup | Access |
| Manual Tuning | Access |

Available in Analogue (p. 46, 49, 50)

| | |
|---------------------|-------------|
| System Menu | |
| USB Keyboard Layout | English(UK) |
| Shipping Condition | Access |
| Owner ID | Access |
| Common Interface | Access |
| System Update | Access |
| Software Licence | Access |
| System Information | Access |

(p. 41)

| | |
|-------------------------------|--------|
| System Update | |
| Auto Update Search in Standby | Off |
| System Update Search Now | Access |

(p. 58)

| | |
|------------------|-----------------|
| Common Interface | |
| Slot 1: | Module inserted |

Available in DVB (p. 57)

| | |
|----------------------|---------|
| Owner ID | |
| Please enter new PIN | |
| PIN | * * * * |

(p. 56)

Shipping Condition

All tuning data will be erased

Are you sure ?

Are you sure ?

(p. 55)

| | |
|-----------------------|-------------------|
| Network Setup | |
| Connection Test | Access |
| Network Type | Wired |
| Access Point Settings | Access |
| IP/DNS Settings | Access |
| Network Link Settings | Access |
| Software Update | Access |
| MAC Address | ab-cd-ef-gh-ij-kl |

(p. 70)

How to Use Menu Functions

DVB Manual Tuning

Frequency [CH21] 474.00 MHz

Signal Quality 0 10

Signal Strength 0 10

| No. | Channel Name | Type | New |
|------------|--------------|----------|---------|
| Free TV: 0 | Pay TV: 0 | Radio: 0 | Data: 0 |

Stopped

(p. 47)

All DVB Channels

- 70 CBBC Channel
- 72 Cartoon Nwk
- 105 BBCi
- 719 BBC Radio Wales
- 720 BBC Radio Cymru
- 1 BBC ONE Wales
- 7 BBC THREE

(p. 49)

DVB Favourites Editor

| All DVB Channels | Favourites1 |
|---------------------|-------------|
| 1 BBC One Wales | |
| 7 BBC THREE | |
| 14 E4 | |
| 70 CBBC Channel | |
| 72 Cartoon Nwk | |
| 105 BBCi | |
| 719 BBC Radio Wales | |
| 720 BBC Radio Cymru | |

(p. 48)

Channel Sorting by Region

GBR->

Best signal quality (All Regions)

England Regions->

Region choice available

(p. 47)

DVB Auto Setup

Progress CH 21 68

This will take about 3 minutes.

| CH | Channel Name | Type | Quality |
|----|-----------------|---------|---------|
| 62 | CBBC Channel | Free TV | 10 |
| 62 | BBC Radio Wales | Free TV | 10 |
| 62 | E4 | Free TV | 10 |
| 62 | Cartoon Nwk | Free TV | 10 |

Free TV: 4 Pay TV: 0 Radio: 0 Data: 0

Searching

(p. 46)

UK only

Analogue Manual Tuning

1 BBC1 Manual Tuning 21 Store CH33 -08

(p. 50)

Analogue Auto Setup

Scan CH 21 68

This will take about 3 minutes.

| CH | Channel Name |
|----|--------------|
| 29 | |
| 30 | |

Analogue: 2 Searching

(p. 46)

Analogue Channel List

- 1 BBC1
- 2 *****
- 3 *****
- 4 *****
- 5 *****
- 6 *****
- 7 *****

(p. 50)

Display Settings

| | |
|------------------------|-----------|
| Teletext | FASTTEXT |
| Teletext Character Set | West |
| Preferred Teletext | Irish |
| Preferred Subtitles | English |
| Input Labels | Access |
| Banner Display Timeout | 3 seconds |
| VIERA Connect Banner | On |
| Playing Time Display | On |
| Radio Mode | Off |

(p. 40, 41)

----- Available in Analogue

----- Ireland only

----- Available in DVB Ireland only

----- Available DVB

Input Labels

| | |
|-----------|-----------|
| AV1 | DVD |
| AV2 | AV2 |
| COMPONENT | COMPONENT |
| HDMI1 | HDMI1 |
| HDMI2 | HDMI2 |
| HDMI3 | HDMI3 |
| HDMI4 | HDMI4 |
| DVB | DVB |
| Analogue | Analogue |

(p. 54)

Retuning from Setup Menu

Automatically retune the channels received in the area.

- This function is available if channel tuning is already performed.
- Only the selected mode is retuned. All the previous tuning settings are erased.
- If Child Lock PIN number (p. 53) has been set, the PIN number is required.
- If tuning has not been done completely → **[Manual Tuning]** (p. 47, 50)

DVB or Analogue channels



1 Select DVB or Analogue

→ (p. 18)



2 Display the menu

MENU



3 Select [Setup]

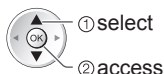
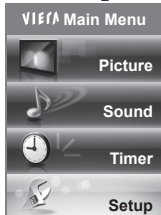

4 Select [DVB Tuning Menu] or [Analogue Tuning Menu]

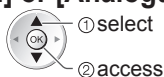
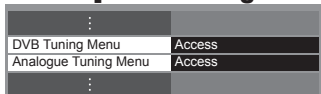

- The displayed item depends on the selected mode.

5 Select [Auto Setup]

Example :

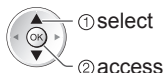
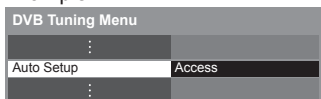

6 Start Auto Setup (Settings are made automatically)

Example : DVB

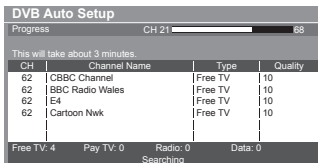
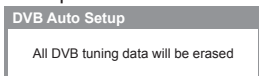

Example : Analogue

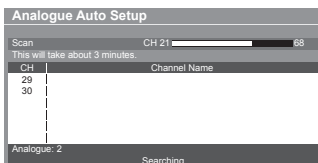
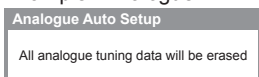

- The analogue settings are downloaded to a Q-Link compatible equipment connected to the TV in Analogue mode.

When the operation is completed, the channel at the lowest position will be displayed.

■ To return to TV

EXIT



For Auto Setup, using the buttons on the side panel of the TV (p. 10)

1 Press repeatedly until [Auto Setup] appears



2 Access [Auto Setup]



3 Start [Auto Setup]



• To return to TV



Tuning and Editing Channels (DVB)

You can retune channels or make your favourite channel lists, skip unwanted channels, etc.



1 Select DVB
→ (p. 18)



2 Display the menu



3 Select [Setup]

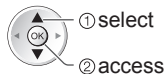
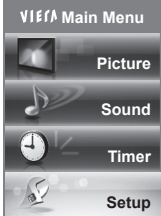

4 Select [DVB Tuning Menu]

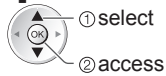

5 Select one of the following functions

| DVB Tuning Menu | |
|---------------------------|--------|
| Favourites Edit | Access |
| Channel List | Access |
| Auto Setup | Access |
| Channel Sorting by Region | Access |
| Manual Tuning | Access |
| Update Channel List | Access |
| New Channel Message | On |
| Signal Condition | Access |

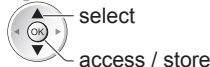

• [Auto Setup] → **"Retuning from Setup Menu"** (p. 46)

■ To return to TV



Sort DVB channels according to the region [Channel Sorting by Region] **UK only**

You can sort DVB channels so that those with the best signal quality, or those for your preferred region, appear nearer the top of your Channel List.

Normally, you should select [Best signal quality (All Regions)].

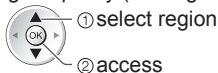
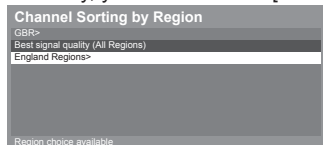

(select repeatedly until you reach the available region)

- If you choose to select your preferred region, you could find channels with a weaker signal appear nearer the top of your Channel List. If you have any image or sound problems, select [Best signal quality (All Regions)] instead.

Set DVB channel manually [Manual Tuning]

Normally use [Auto Setup] or [Update Channel List] to retune DVB channels.

If tuning has not been done completely or for adjusting the direction of the aerial, use this function.

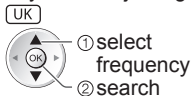
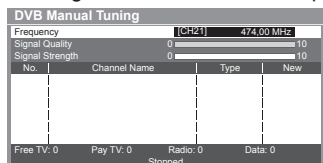

1 Adjust frequency for each channel

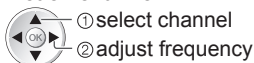

- Set where the level of [Signal Quality] becomes the maximum.

• All channels found will be added to the Channel List.

List favourite DVB channels [Favourites Edit]

Create your favourite channel lists from various broadcasters (up to 4: [Favourites]1 to 4). The DVB Favourites lists are available for switching in the Information banner (p. 19) and from [Category] in the TV Guide screen (p. 22).

1 Select a channel to list ([-]): Encrypted channel)

select

- To display other Favourites (green)

2 Add it to the Favourites list

A channel is added

- To add all channels to the list (yellow)

To edit Favourites list

While the cursor is in the Favourites field to edit

- To delete a channel
- To delete all channels

select (yellow)

select (green)

delete

- To move the channel

(green)

Select the new position

or

Select the turn

Store (green)

- To name the Favourites

(red)

Set characters (maximum: ten characters)

User input

Name

| | | | | | | | | | | | | | | | | | | | |
|---|---|---|---|---|---|---|---|---|---|---|---|---|---|---|---|---|---|---|---|
| A | B | C | D | E | F | G | H | I | J | K | L | M | N | O | P | Q | R | S | T |
| U | V | W | X | Y | Z | 0 | 1 | 2 | 3 | 4 | 5 | 6 | 7 | 8 | 9 | : | # | | |
| a | b | c | d | e | f | g | h | i | j | k | l | m | n | o | p | q | r | s | t |
| u | v | w | x | y | z | (|) | * | - | + | = | | | | | | | | |

Backspace

Enter

select

set

Store

BACK/RETURN

- To use numeric buttons

→ "Characters table for numeric buttons" (p. 91)

3 Store

BACK/RETURN

OK

Note

- Channel position numbers (known as logical channel numbers) can be swapped in Channel List. To swap the channel position number → [Channel List] (p. 49)

Check DVB signal [Signal Condition]

Selects a channel and checks the DVB signal condition.

A good Signal Strength is not an indication of best signal for DVB reception. Please use the Signal Quality indicator as follows :

[Signal Quality] :

- Green bar → Good
- Yellow bar → Poor
- Red bar → Bad (Check the Terrestrial aerial)

Example :

DVB Signal Condition

| | |
|-----------------|----------------------------|
| Channel Name | 70 CBBC Channel |
| Signal Quality | 0 |
| Signal Strength | 0 |
| Bit Error Rate | 0.00E+00 |
| Network Name | Terrestrial |
| Frequency | 502.00 MHz 64 QAM 6940 S/S |

- To change the channel



Display a notification message [New Channel Message]

Selects whether to give a notification message when a new DVB channel is found. [Off] / [On]

New channels found!
Press OK to update channel list.
Press EXIT to ignore.

- Selecting OK will perform [Update Channel List].

Skip unwanted DVB channels, Edit DVB Channels [Channel List]

You can hide unwanted DVB channels. The hidden channels cannot be displayed except in this function. Use this function to skip unwanted channels.

Select a channel and [reveal] / [hide]

| All DVB Channels | |
|-------------------------------------|---------------------|
| <input checked="" type="checkbox"/> | 70 CBBC Channel |
| <input checked="" type="checkbox"/> | 72 Cartoon Nwk |
| <input checked="" type="checkbox"/> | 105 BBCi |
| <input type="checkbox"/> | 719 BBC Radio Wales |
| <input type="checkbox"/> | 720 BBC Radio Cymru |
| <input type="checkbox"/> | 1 BBC ONE Wales |
| <input checked="" type="checkbox"/> | 7 BBC THREE |

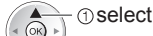

① select



② [reveal] / [hide]



: [reveal]

: [hide] (skip)

• To reveal all channels



To edit channels

You can also edit each channel in Channel List.

• To retune each channel → **[Manual Tuning] (p. 47)**
(only for the revealed channels)

Channel position number



(red)

• To swap the channel position number (logical channel number)



(green)



Enter the new
position number



Store
(green)

Update DVB channel automatically [Update Channel List]

You can add new channels, delete removed channels, update channel name and position automatically to Channel List.

Example : **[UK]**

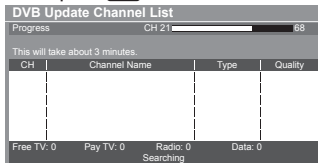

- Channel List is updated while keeping your settings in [Favourites Edit], [Channel List], [Child Lock], [Timer Programming], etc.
- Depending on the signal condition, the update may not work properly.

(Analogue)

You can retune channels or skip unwanted channels, edit channels etc.



1 Select Analogue



2 Display the menu



3 Select [Setup]

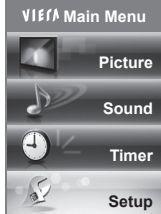

① select

② access

4 Select [Analogue Tuning Menu]

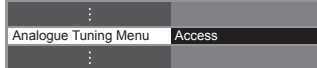

① select

② access

5 Select one of the following functions

| Analogue Tuning Menu | |
|----------------------|--------|
| Channel List | Access |
| Auto Setup | Access |
| Manual Tuning | Access |

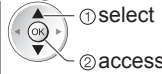

① select

② access

■ To return to TV

EXIT



• [Auto Setup]
→ "Retuning from Setup Menu" (p. 46)

Skip unwanted Analogue channels, Edit Analogue channels [Channel List]

You can hide unwanted Analogue channels.

The hidden channels cannot be displayed except in this function. Use this function to skip unwanted channels.

Select a channel and [reveal] / [hide]

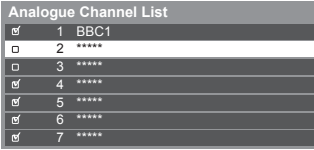

- To reveal all channels (yellow)

To edit channels

You can also edit each channel in Channel List.

- To retune each channel ((Manual Tuning)) (see below)
- To move the channel position



Select the new position



Store



- To rename the channel name



Set characters (maximum: five characters)

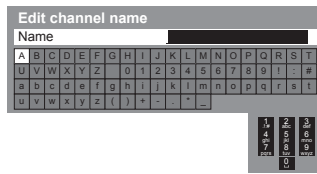

Store



- To use numeric buttons
- “Characters table for numeric buttons” (p. 91)

Channel position

Channel name



Note

- If a VCR is connected only with the RF cable, edit [VCR].

Set Analogue channel manually [Manual Tuning]

[Fine Tuning] (Ireland only)

Use to make small adjustments to the tuning of an individual programme (affected by weather conditions, etc.)

[Manual Tuning]

Set Analogue channel manually after Auto Setup.

- If a VCR is connected only with the RF cable, it is recommended to select channel position [0].

Example : (Ireland)



1 Select the channel position



2 Select the channel



3 Search



4 Select [Store]



Timer Programming

Timer Programming from Menu

The Timer Programming menu allows you to choose programmes that you wish to remind watching or record to the external recorder. At the correct time, the TV will tune to the correct channel automatically to record even if the TV is in Standby mode.

TV Guide may also be used to set timer programming event (p. 23).

- Timer Programming can store up to 15 events.
- For recording using Timer Programming, the TV must be either On or in standby. For reminders to be displayed, the TV must be On.
- No other channel can be selected while the recording of Timer Programming is in progress.
- It may not be possible to record an encrypted programme (which is copy-protected).
- When recording programmes to the external recorder, be sure to make the proper settings on the recorder connected to the TV.

If a compatible recorder with Q-Link or similar technologies is connected to the TV (p. 78) and the [Link Settings] (p. 39) are correct, no setting of the recorder is required. Also read the manual of the recorder.

- If the recorder is not compatible with Q-Link or similar technologies, set the timer of the recorder in addition to the Timer Programming on the TV. For preparations of a recorder, read the manual of the recorder.
- Recordings to the external recorders are always in standard definition composite video via SCART, even if the original programme is in high definition.



1 Select the tuner you want to use (DVB or Analogue)

➔ (p. 18)



2 Display the menu



3 Select [Timer]

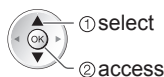
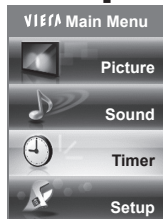

■ To return to TV

EXIT



■ To unlock the tuner and stop recording



4 Select [Timer Programming]

| Timer Programming | Access |
|-------------------|--------|
| Off Timer | Off |
| Auto Standby | Off |

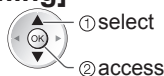

Note

- Check that the LED is orange. If not, timer programmes are not active or not stored.
- Timer Programming reminder messages will remain displayed until one of the following occurs:
 - You press the OK button to view the programme or the EXIT button to cancel the reminder.
 - The timer programming event that the reminder is set for ends.
- “!” identifies that any timer programming events have overlapped. [Ext Rec.] is given priority over [Reminder]. As for the overlapped two or more [Ext Rec.], the first timer programming event starts and finishes as programmed. The next timer programming event can then start.
- 2 minutes before the starting time, a reminder message appears if you are watching TV.
 - To remove the message and start the programme
 - To cancel the Timer Programming

- The recording of Timer Programming will automatically change to the programmed channel 10 seconds before the start time.
- To stop recording of the timer programming event, it may be necessary to stop the recorder manually.
- The recording of Timer Programming will be performed even if the TV is in Pause Live TV recording (p. 81). In this case, these recordings will be cancelled.

Set timer programming event details [Timer Programming]

1 Start making the settings



2 Select the function ([Ext Rec.] or [Reminder])



[Ext Rec.] :

to record the programme to the external recorder

When the start time comes, the channel will be switched automatically and the video and audio signals will be output. 2 minutes before the starting time, a reminder message appears if you are watching TV.

[Reminder] :

to remind you to watch the programme. When you are watching TV, a reminder message appears 2 minutes before the start time. Press the OK button to switch to the programmed channel.

3 Set the channel, date and time (repeat the operations as below)

Set items in the order of 1 to 4.



• 1, 3 and 4 can also be entered with numeric buttons.



Store



! : Displayed if the timer programming events are overlapped

Timer programming - Programmes according to the time setting

| Function | No. | Channel Name | Date | Start | End |
|----------|-----|--------------------|------------|--------------------|-------|
| Ext Rec. | 72 | BBC 2W <TIMER> | Wed 27 Oct | 20:00 (90 min.) | 21:30 |
| Reminder | 14 | E4 The Bill | Wed 27 Oct | 21:00 (60 min.) | 22:00 |
| Ext Rec. | 1 | BBC ONE DIY SOS | Wed 27 Oct | 22:45 (15 min.) | 23:00 |
| Ext Rec. | 30 | BBC ONE <TIMER> | Thu 28 Oct | 10:30 (60 min.) | 11:30 |

Duration (automatic display)

Records with subtitles (if available)

• To indicate this

(yellow) (Press again to remove subtitles)

2 Date



one day ahead

daily or weekly (press repeatedly)

- [Daily Sun-Sat] : Sunday to Saturday
- [Daily Mon-Sat] : Monday to Saturday
- [Daily Mon-Fri] : Monday to Friday
- [Weekly Sat/Fri/Thu/Wed/Tue/Mon/Sun] : Same time on the same day every week

1 Channel number

3 Starting time

: DVB / : Analogue (UK)

: DVB / : Analogue (Ireland)

• You cannot change the mode within the menu.

UK only

: Guide link programming - Programmes according to the TV Guide signal (p. 24)

: Split Programme programming (p. 24)

• These functions are not available in Analogue mode.

Guide link programming is Timer Programming which is controlled by information from the TV Guide; if programme start and end times are changed by the broadcaster, the timer programming event will follow the change.

A Split Programme programming is a Guide link programming which is interrupted by one or more other programmes.

Note that Guide link programming (including Split Programme programming) only works reliably if correct information is received from broadcasters.

■ To change a timer programming event

Select the programme to be changed



① select

Correct as necessary (as above)

② access

■ To cancel a timer programming event

Select the programme to be deleted



(red)



■ To record with subtitles (if available)

Select the programme to record with subtitles



(yellow)

• Each time pressed:
auto ↔ off

■ To cancel a timer programming event temporarily

Select the programme to be cancelled



(blue)

• Each time pressed:
cancel ↔ stop cancelling

■ To view details of the programming (only for Guide link programming) UK only

Select the programme to be viewed



• Press again to return to Timer Programming menu.

Child Lock

You can lock specific channels / AV input terminals and control who watches them. When the locked channel / input is selected, a message appears; by entering the PIN number, you can watch it.



1 Display the menu



2 Select [Setup]

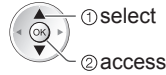
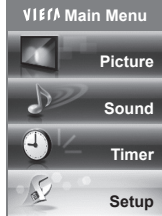

■ To return to TV



3 Select [Child Lock]

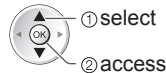

Control channel audience [Child Lock]

1 Enter the PIN number (4 digits)

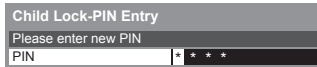

- Enter the PIN number twice at first setting.
- Make a note of the PIN number in case you forget it.

2 Select [Child Lock List]

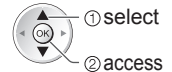

3 Select the channel / input to be locked

| Name | Input | Type | Lock |
|----------------|----------|----------|------|
| 101 BBC1 Wales | DVB | Free TV | ● |
| 7 BBC THREE | DVB | Free TV | ● |
| 14 E4C | DVB | Free TV | ● |
| VCR | Analogue | Analogue | |
| 1 BBC1 | Analogue | Analogue | |
| 2 **** | Analogue | Analogue | |
| AV1 | External | AV | ● |
| AV2 | External | AV | ● |



- To lock all (green)
- To cancel all locks (yellow)
- To jump to the top of the next input (blue)

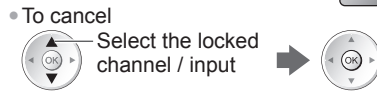

🔒 : Appears when the channel / input is locked

■ To change the PIN number

1. Select [Change PIN]

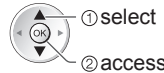

2. Enter a new PIN number twice



■ To set Parental Rating Ireland only

If the DVB programme has the rated information for over the selected age, you have to enter the PIN number to watch (depending on the broadcaster).

Select [Parental Rating] and set an age for the restriction of programmes.



Note

- Setting [Shipping Condition] (p. 55) erases the PIN number and all settings.

Input Labels

For easier identification and selection of the input mode, you can label each input mode or skip terminals that are not connected to any equipment.

- To select the input mode → (p. 28)



Input Labels

1 Display the menu



2 Select [Setup]

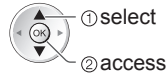

3 Select [Display Settings]



4 Select [Input Labels]



5 Select an input terminal

| Input Labels | |
|--------------|-----------|
| AV1 | DVD |
| AV2 | AV2 |
| COMPONENT | COMPONENT |
| HDMI1 | HDMI1 |
| HDMI2 | HDMI2 |
| HDMI3 | HDMI3 |
| HDMI4 | HDMI4 |
| DVB | DVB |
| Analogue | Analogue |

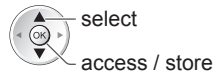

The labels you set will be displayed in the [Input Selection] menu (p. 28), [TV Selection] menu or banner.

- If [Skip] is selected, the input will not be displayed in the [Input Selection] menu and you cannot select the mode.

■ To return to TV



■ User input

You can name each input mode yourself.

1 Select [User input] 2 Set characters (maximum : ten characters)

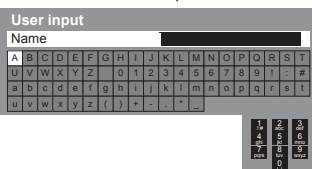

3 Store



- To use numeric buttons
→ “Characters table for numeric buttons” (p. 91)

Shipping Condition

Resets the TV to its original condition with no channels tuned in.

All settings other than [Owner ID] are reset (channels, picture, sound settings, etc.).

• To retune TV channels only, e.g. after moving house → “Retuning from Setup Menu” (p. 46)



1 Display the menu



2 Select [Setup]

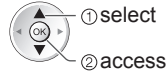
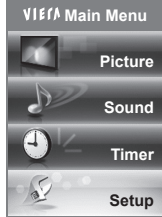

3 Select [System Menu]

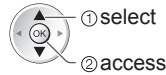

4 Select [Shipping Condition]

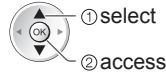
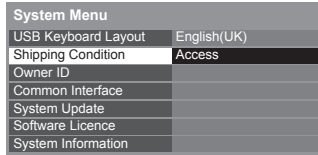

■ To return to TV



Restore Settings [Shipping Condition]

1 Check the message and initialise

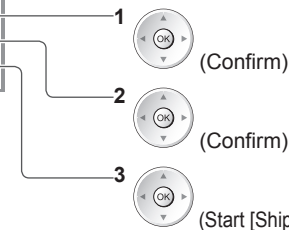
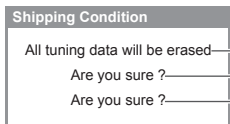

2 Follow the on screen instructions

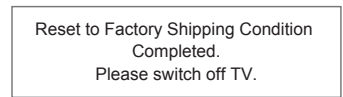

• [Auto Setup] will automatically start when Mains power On / Off switch is next turned On. (p. 13)

Owner ID

Entry of the PIN number and personal information (your name, address and postcode). In the unfortunate event of theft, the Owner ID will help the Police to determine the owner.



1 Display the menu



2 Select [Setup]

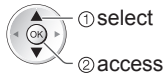
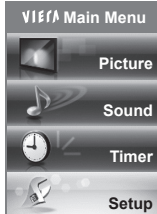

3 Select [System Menu]

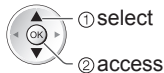

4 Select [Owner ID]

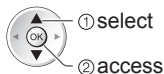

■ To return to TV



Input owner ID [Owner ID]

1 Enter the PIN number (4 digits)



- Enter the PIN number twice at first setting.
- Make a note of the PIN number in case you forget it. The PIN number cannot be reset.

2 Select the item (NAME / HOUSE NO / POSTCODE) and set characters

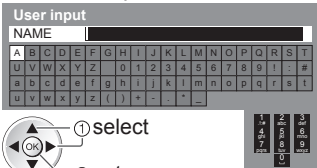
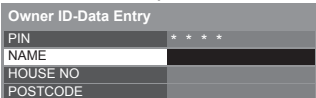

Return to select other items
BACK/RETURN

- Select the next item and repeat the operations.

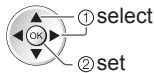
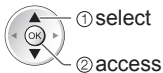

- To use numeric buttons

➔ "Characters table for numeric buttons" (p. 91)

3 Exit the menu



■ To check the personal information stored

Hold down for about 5 seconds



- The PIN number is not displayed.

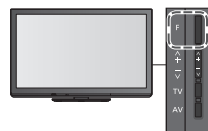

■ To change the PIN number

1. Select [PIN]

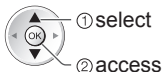
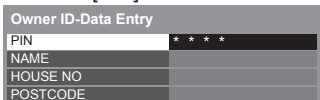

2. Enter a new PIN number twice



Using Common Interface

The Common Interface Module menu provides access to software contained on Common Interface (CI) Modules. This TV works only for Pay TV modules complying with CI standard.

- This function is not available for BskyB's Sky channels.
- Video and audio signals may not be output depending on broadcasts or services.

Caution

- Turn Off Mains power On / Off switch whenever inserting or removing the CI module.
- If a viewing card and a card reader come as a set, first insert the card reader, then insert the viewing card into the card reader.
- Insert the module in the correct direction.

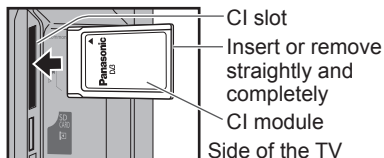

Insert the CI module (optional)

- The features that appear on screen are dependent on the contents of the selected CI module.
- Follow the instructions that came with the viewing card to tune in the encrypted channels. If encrypted channels do not appear, perform the below to verify the card is recognised by the TV.
- For more details, see the manual of the CI module, or check with the broadcaster.

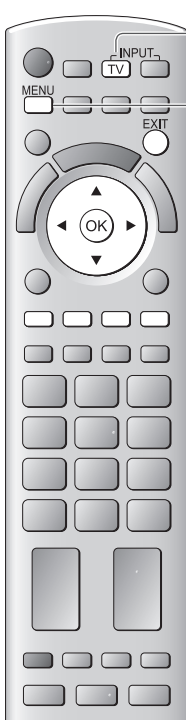

1 Select DVB

➔ (p. 18)



2 Display the menu



3 Select [Setup]

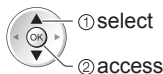
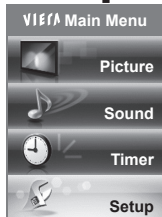

4 Select [System Menu]

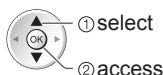

5 Select [Common Interface]

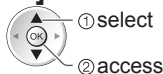
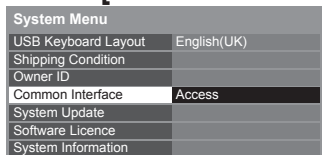

6 Access Common Interface



■ To return to TV

EXIT



■ How to operate services by following the on screen operation guide

(Check the instructions provided with the CI module.)

Example :

- Select, go



- Symbol : ◀▶▼▲



- Coloured characters

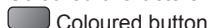

- On screen operation guide may not correspond to the remote control buttons.

Updating the TV Software

From time to time, a new version of software may become available for download to enhance the performance or operations of the TV.

In DVB mode, a notification banner will appear when one of the BBC channels is turned to if a new available software is found.

• To download



• If you choose not to download



You can update any new software automatically or manually.



1 Display the menu



2 Select [Setup]

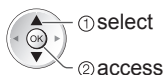
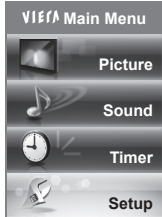

3 Select [System Menu]

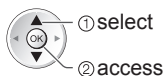

4 Select [System Update]

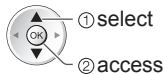
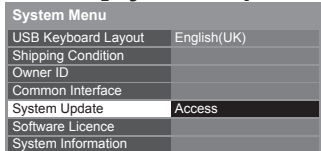

■ To return to TV



Update TV's software system [System Update]

■ To update automatically

Select [Auto Update Search in Standby] and set to [On]

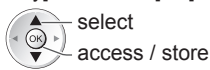

• Automatically performs a search in standby and downloads an update, if any software updates are available.

• The automatic updating is performed at night under the following conditions:

- Standby (TV turned Off with the remote control)
- Recording of Timer Programming or Direct TV Recording is not in progress.

If System Update is performed, the software will be updated (it may change TV functions).

If you do not wish to do so, set [Auto Update Search in Standby] to [Off]. The notification banner will keep appearing during the period of new software availability, usually 2 to 3 days.

■ To update immediately

1 Select [System Update Search Now]

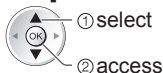

2 Searches for an update (for several minutes) and displays a corresponding message if any



Note

• Download may take up to 60 minutes.

• During software download and update, DO NOT perform any operations on the TV or switch Off the TV.

Using Media Player

Media Player allows you to enjoy photo, video or music recorded on an SD Card and a USB Flash Memory.

VIERA IMAGE VIEWER is the function of the easy viewing for photos or videos recorded on an SD Card on the TV screen by simply inserting into the SD Card slot.

Photo mode : Still pictures recorded by digital cameras will be displayed.

Video mode : Moving pictures recorded by digital video cameras will be played back.

Music mode : Digital music data will be played back.

- During the operation, audio signal is output from AV1, AUDIO OUT, DIGITAL AUDIO OUT and HDMI2 (ARC function) terminals. But no video signals are output. AV1 can output audio signal if [AV1 out] is set to [Monitor] in the Setup Menu (p. 39). To use HDMI2 with ARC function, connect an amplifier that has ARC function (p. 77) and set to use theatre speakers (p. 83).
- [Date] shows the date on which the recording was made by the recording equipment. The file without record of the date is shown "***/**/*****".
- The picture may not appear correctly on this TV depending on the recording equipment used.
- Display may take some time when there are many files and folders.
- Partly degraded files might be displayed at a reduced resolution.
- Picture setting may not work depending on the conditions.
- The folder and file names may be different depending on the digital camera or digital video camera used.

To insert or remove the SD Card / USB Flash Memory

■ USB Flash Memory

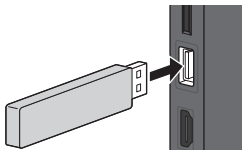

- Insert or remove straightly and completely.
- Connect to the USB 1 or 2 port.

■ SD Card

To insert the SD Card

- ① Gently insert the SD Card label surface facing front.
 - ② Push until a click is heard
-
- Cutout

To remove the SD Card

- Push the centre of the card
-

- For the information of the devices ➔ **“Devices for recording or playing back” (p. 90)**
- For the supported file format ➔ **“Supported file format in Media Player” (p. 88, 89)**



Starting Media Player



1 Insert the SD Card or USB Flash Memory to the TV
 → (p. 59)

2 Start Media Player

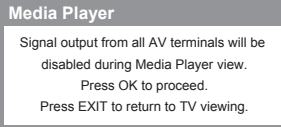

• Also possible by pressing following buttons.

AV → “Watching External Inputs” (p. 28)

3 Select the device you want to access to



① select
 ② access

• If two or more devices are not connected, this step will be skipped.

Selected device name

4 Select the content



① select
 ② access

[Photo] → “Photo mode” (see below)

[Video] → “Video mode” (p. 65)

[Music] → “Music mode” (p. 67)

Note

- You can also access each mode directly by using VIERA TOOLS.
 → “How to Use VIERA TOOLS” (p. 34)
- Select the appropriate device and content for playing back each file.
- You can use the following buttons during playback.
 Set the position to “TV”

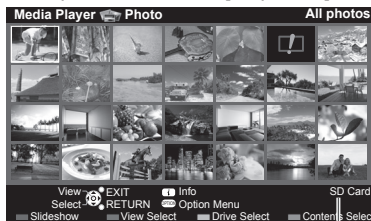

Photo mode

Photo mode will read all “.jpg” extension files in the SD Card or USB Flash Memory.

The thumbnail of all the photos in the SD Card or USB Flash Memory will be displayed.

Example : Thumbnail - [All photos]



• To change the back ground music
 → “Photo Settings” (p. 63, 64)

• To display the information of the highlighted photo



| | |
|-----------|--------------|
| File name | 1/48 |
| Date | p1010001.JPG |
| Pixel | 23/10/2010 |
| | 1600X1200 |

File number /
 Total file number

7 : Error display Selected device name

• To change the size of photos on a thumbnail screen



① select [Change Size]
 ② change

■ To sort by folder, recorded date or recorded month

1 Display the view selection

 (green)

2 Select the sort type

| |
|---------------|
| Folder view |
| Sort by Date |
| Sort by Month |

[Folder view] :

- Displays the thumbnail grouped by folder
- The files which are not into a folder will be collected to the folder named “/”.

[Sort by Date] :

- Displays the thumbnail grouped by the same date
- The group of the photos without recorded date is shown as [Unknown].

[Sort by Month] :

- Displays the thumbnail grouped by the same month
- The group of the photos without recorded date is shown as [Unknown].

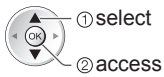

3 Select one of the sorted groups to display the thumbnail of the selected group

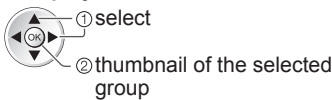

- To return to the thumbnail of all photos

 (green)

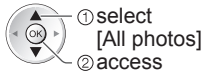

- To display the information of the highlighted group

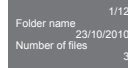

- Group number / Total group number
- Folder name, date or month

[Single view] - Photos are displayed one at a time.

Select the file from the thumbnail of photos to be viewed



Example :



Operation guide

- To display / hide the operation guide



- To return to thumbnail



- To operate Single view



To the previous photo

Slideshow

To the next photo

Stop

(return to thumbnail)

- To rotate 90°

 (blue)

[Slideshow] - Slideshow will complete when all photos have been viewed within the present thumbnail.

1 Select the file from the thumbnail of photos for the first view



2 Start Slideshow

 (red)



- To display / hide the operation guide



- To pause (return to Single view)



- To return to thumbnail



Multi Shot 3D

This TV can create the 3D photo using a pair of photos in the SD Card and save it into the same SD Card.

- This TV can also create the 3D photo from photos in the USB Flash Memory, but cannot save it.
- This function is available with photos recorded by digital cameras.
- Depending on the photos you select, the created 3D photo may not be suitable or the 3D photo creation may not be possible. It is recommended to take a photo (for L) and then move your camera to the right about 5 cm and take another photo (for R).
- To view the created 3D photo with 3D effect, you need the 3D Eyewear ➔ **“Optional accessories”** (p. 6)

1 Display the option menu in the thumbnail view



2 Select [Multi Shot 3D]

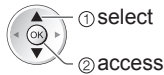
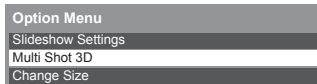

3 Select two photos for L (left) and R (right)

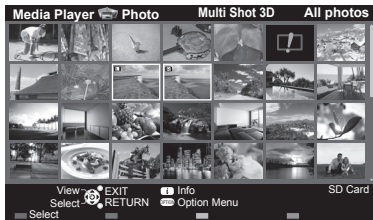

- You can only select photos of the same recorded date and same pixels.
- You may not be able to view the created 3D photo properly if you select the photos for L and R oppositely.

4 Create the 3D photo



- If your selected photos are not suitable for the 3D photo, the error message will be displayed and will return to the photo selection screen (step 3).
- To save the 3D photo in the SD Card

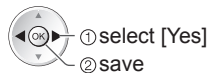
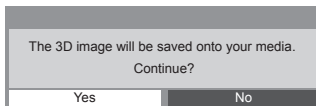

After finishing saving the photo, the photo selection screen will be displayed (step 3). Select photos again to create another 3D photo or exit from [Multi Shot 3D] mode.

■ To enjoy the saved 3D photos

You can enjoy viewing the saved 3D photos.

Example : Thumbnail

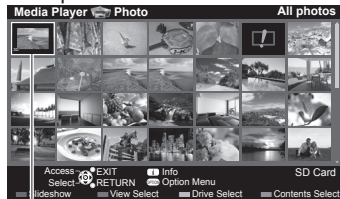

- Single view ➔ (p. 61)
- Slideshow ➔ (p. 61)

Saved 3D photo

Photo Settings

Setup the settings for Photo mode.

1 Display the option menu



2 Select [Slideshow Settings]

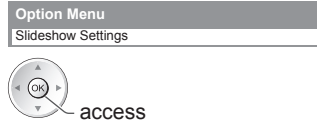

3 Select the items and set

| Slideshow Settings | |
|--------------------|-----------|
| Frame | Off |
| Colour Effect | Off |
| Transition Effect | Fade |
| Aspect | Original |
| Burst Playback | Off |
| Interval | 5 seconds |
| Repeat | On |
| Back Ground Music | |

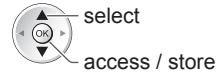

Note

- Picture quality may become lower depending on the slideshow settings.
- Picture setting may not work depending on the slideshow settings.

| Menu | Item | Adjustments / Configurations (alternatives) |
|--------------------|-------------------|--|
| Slideshow Settings | Frame | <p>Selects the frame type of the slideshow [Off] / [Multi] / [Collage] / [Drift (+ calendar)] / [Drift] / [Gallery (+ calendar)] / [Gallery] / [Cinema] [Multi] : 9 photos are displayed orderly at once. [Collage] : Each photo is displayed at a random position and random scale. [Drift (+ calendar)] / [Drift] : Photos are displayed like flow images. • You can select to display the calendar or not. The month of calendar is turned by pressing left or right cursor button. [Gallery (+ calendar)] / [Gallery] : The various sizes of photos in the frame are displayed. • You can select to display the calendar or not. The month of calendar is turned by pressing left or right cursor button. [Cinema] : Photos are displayed like old films (sepia tone)</p> |
| | Colour Effect | <p>Selects the colour effect of photos on Single view and Slideshow [Off] / [Sepia] / [Gray scale] • This function is not available when [Frame] is set to [Drift], [Gallery] or [Cinema].</p> |
| | Transition Effect | <p>Selects the transition effect for switching the photo during the slideshow [Off] / [Fade] / [Slide] / [Dissolve] / [Motion] / [Random] [Fade] : The next photo fades in gradually. [Slide] : The next photo slides and appears from the left side. [Dissolve] : Each photo is dissolved when switching to the next photo. [Motion] : Each photo is displayed with an effect of enlarging, reducing, moving up or moving down. [Random] : Each transition is selected at random. • This function is available when [Frame] is set to [Off].</p> |
| | Aspect | <p>Selects whether enlarged or normal viewing on Single view and Slideshow [Original] / [Zoom] • This function is not available when [Frame] is set to [Collage], [Drift], [Gallery] or [Cinema]. • This function is not available when [Transition Effect] is set to [Motion]. • Depending on the photo size, it may not be fully enlarged to fill the screen, e.g. portrait style picture.</p> |
| | Burst Playback | <p>Selects whether to display burst photos in a fast-paced slideshow mode [Off] / [On] • This function is not available when [Frame] is set to [Drift], [Gallery] or [Cinema]. • This function is not available when [Transition Effect] is set to [Motion].</p> |
| | Interval | <p>Selects slideshow interval [5] / [10] / [15] / [30] / [60] / [90] / [120] (seconds) • This function is not available when [Frame] is set to [Drift], [Gallery] or [Cinema]. • This function is not available when [Transition Effect] is set to [Motion].</p> |
| | Repeat | <p>Slideshow repeat [Off] / [On]</p> |

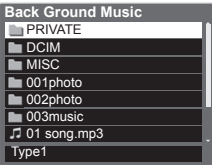
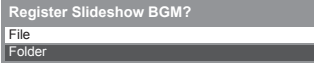
| Menu | Item | Adjustments / Configurations (alternatives) |
|--------------------|-------------------|--|
| Slideshow Settings | Back Ground Music | <p>Selects the back ground music during Photo mode [Off] / [Type1] / [Type2] / [Type3] / [User] / [Auto]</p> <ul style="list-style-type: none"> • [Type1], [Type2] and [Type3] are the fixed music each installed in this TV. • [User] : Music data in the device registered by yourself will be played back. <p>To register the music</p> <ol style="list-style-type: none"> 1. Select the music file Depending on the condition of the device, select folders until you reach the desired music file.  <ol style="list-style-type: none"> ① select ② access <ul style="list-style-type: none"> • If no music has been registered or the device which has the registered music is removed, no sound will be produced. <p>[Auto] : Music data stored in the root folder of the current device will be played back randomly.</p> <ul style="list-style-type: none"> • If there is no available music data, no sound will be produced. |
| | | <ol style="list-style-type: none"> 2. Select [File] or [Folder]  <ol style="list-style-type: none"> ① select ② set <p>[File] : The selected music file will be registered as back ground music.</p> <p>[Folder] : All the music in the folder which contains the selected music file will be registered as back ground music.</p> |

Change the device

You can change to the other device directly in the same mode if two or more devices are connected.

- 1 While the thumbnail is displayed, display the device selection
- 2 Select the device you want to access to

(yellow)

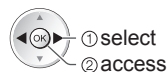
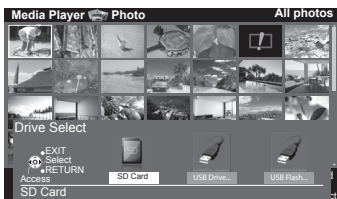

Selected device name

Change the contents

You can switch to the other mode of Media Player from the thumbnail view.

- The mode can be switched in the current device.

- 1 While the thumbnail is displayed, display the contents selection

(blue)

- 2 Select the contents

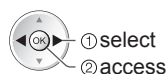

- [Photo] ⇒ "Photo mode" (p. 60)
 [Video] ⇒ "Video mode" (p. 65)
 [Music] ⇒ "Music mode" (p. 67)

• Supported file format → (p. 88)



■ To return to TV



■ To return to the previous screen



Note

- The structure of titles and scenes may vary depending on the digital video camera used.

The thumbnail of video titles in the SD Card or USB Flash Memory will be displayed.

Example : Thumbnail - [Title view]



Selected device name



: Error display



: The file does not support thumbnail view.

- To view the scenes of the title

Select the title

Example : Thumbnail - [Scene view]



① select
② access

■ Playback from Title view

Playback of the selected title will start.

- To repeat playback → “Video Setup” (p. 66)

1 Select the title

2 Start playback



select



(red)

■ Playback from the selected scene in the title (SD-Video or AVCHD)

Playback will start from the selected scene to the end of the title.

- To repeat playback → “Video Setup” (p. 66)

1 Select the title

2 Select the scene

3 Start playback



① select
② access



select



(red)

The preview will start when the title is highlighted if it supports a preview.

- To turn off the preview → “Video Setup” (p. 66)
- To display the information of the highlighted title



File format

Title number / Total title number

The preview will start when the scene is highlighted if it supports a preview.

- To turn off the preview → “Video Setup” (p. 66)
- To display the information of the highlighted scene

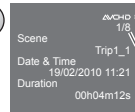

File format

Scene number / Total scene number

■ How to operate in the playback

Example : Playback



Operation guide Information banner

• To the next title / scene
 (green)

• To the previous title / scene
 (red)

• To display / hide the operation guide and information banner



• To operate the playback
 Rewind



Pause / Playback

Fast forward

Stop

• To change aspect



• To return to thumbnail



■ To change the device → “Change the device” (p. 64)

■ To change the content in the current device → “Change the contents” (p. 64)

■ Video Setup

Setup the settings for Video mode.

1 Display the option menu in the thumbnail view



2 Select [Video Setup]



access

3 Select the items and set

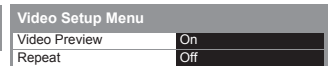

access / store

| Menu | Item | Adjustments / Configurations (alternatives) |
|-------------|---------------|---|
| Video Setup | Video Preview | Sets to start the preview of the title or scene in the thumbnail view [Off] / [On] • Image may not be displayed for an instant in the thumbnail view. Set the preview [Off] to resolve this. |
| | Repeat | Playback repeat within the title or selected file (depending on the content) [Off] / [On] |

■ Confirm or change the current status

You can confirm or change the current status of the content.

• Menu items and selectable options vary depending on the content.

1 Display the option menu during playback



2 Select [Video Setup]



access

3 Select the items and set

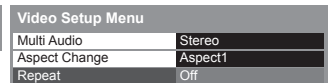

access / store

| Menu | Item | Adjustments / Configurations (alternatives) |
|-------------|---------------|--|
| Video Setup | Multi Audio | Allows you to select between selectable sound tracks (if available) • It may take several seconds to change the sound. |
| | Aspect Change | [Aspect1] : Displays the content enlarged without distortion [Aspect2] : Displays the content full-screen [Original] : Displays the content original size • You can also change the aspect using the ASPECT button. • Aspect change may not work depending on the content. |

Audio output Settings

You can enjoy the multi-channel sound via an amplifier connected to DIGITAL AUDIO OUT or HDMI2 (ARC function) terminal.

- To confirm or change the current sound status → **“Confirm or change the current status”** (p. 66)

1 Display the menu



2 Select [Sound]

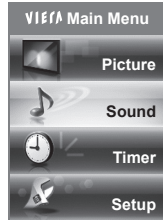

3 Select [SPDIF Selection] and set

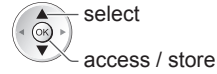

| Menu | Item | Adjustments / Configurations (alternatives) |
|-------|-----------------|--|
| Sound | SPDIF Selection | <p>SPDIF : A standard audio transfer file format Selects the initial setting for digital audio output signal from DIGITAL AUDIO OUT and HDMI2 (ARC function) terminals [Auto] / [PCM] [Auto] : Dolby Digital Plus, Dolby Digital and HE-AAC (48 kHz) multi-channel are output as Dolby Digital Bitstream. DTS is output as DTS. MPEG is output as PCM. [PCM] : Digital output signal is fixed to PCM.</p> |

Music mode

- Supported file format → (p. 89)

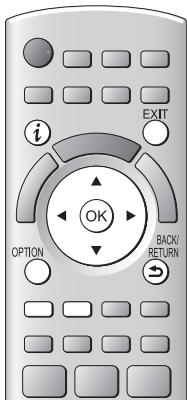

The thumbnail of music folders in the SD Card or USB Flash Memory will be displayed.

Example : Thumbnail - [Folder view]

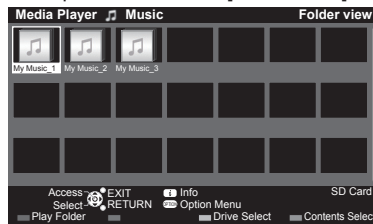

Selected device name

- To display the information of the highlighted folder



■ To return to TV



■ To return to the previous screen



■ Playback from Folder view

All the files in the selected folder will be played back.

1 Select the folder



2 Start playback



■ Playback from File view

Selected file will be played back.

1 Select the folder

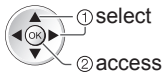

2 Select the file

Example : Thumbnail - File view

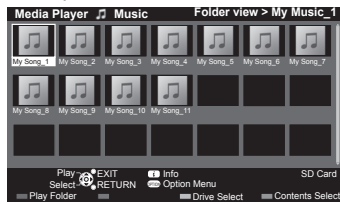

3 Start playback



- To display the information of the highlighted file

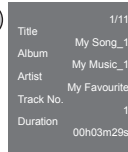

File number / Total file number

■ How to operate in the playback

Example : Playback

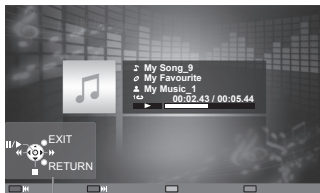

Operation guide

- To display / hide the operation guide



- To operate the playback



- ◀◀ Rewind
- ⏸ Pause / Playback
- ▶▶ Fast forward
- Stop

- To the previous track



- To the next track



- To return to thumbnail



- To change the device ➔ “Change the device” (p. 64)

- To change the content in the current device ➔ “Change the contents” (p. 64)

Music Setup

Setup the setting for Music mode (only available in the thumbnail view).

1 Display the option menu



2 Select [Music Setup]

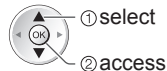

3 Set

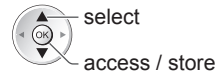

[Folder] : Playback repeat within the selected folder

[One] : Playback repeat of the selected one file

Using Network Services

VIERA Connect

VIERA Connect is a gateway to the internet services unique to Panasonic and has expanded VIERA CAST features greatly.

VIERA Connect allows you to access some specific websites supported by Panasonic, and enjoy internet contents such as photos, videos, games, etc. from VIERA Connect home screen.

- This TV has no full browser function and all features of websites may not be available.

Network Link

Enables to control the TV from the network equipment (Smartphone, etc.)

Network connection → (see below)

Network setup → (p. 70 - 74)

VIERA Connect operations → (p. 75)

Network Link Settings → (p. 70)

Network connections

To use VIERA Connect features, you need a broadband network environment.

- If you do not have any broadband network services, please consult your retailer for assistance.
- Set up and connect any equipment required for the network environment. You cannot make settings for the equipment on this TV. Read the manual of the equipment.
- Required speed (effective) : at least 1.5 Mbps for SD and 6 Mbps for HD picture quality, respectively. If the transfer speed is not enough, contents may not be played back properly.

Example 1

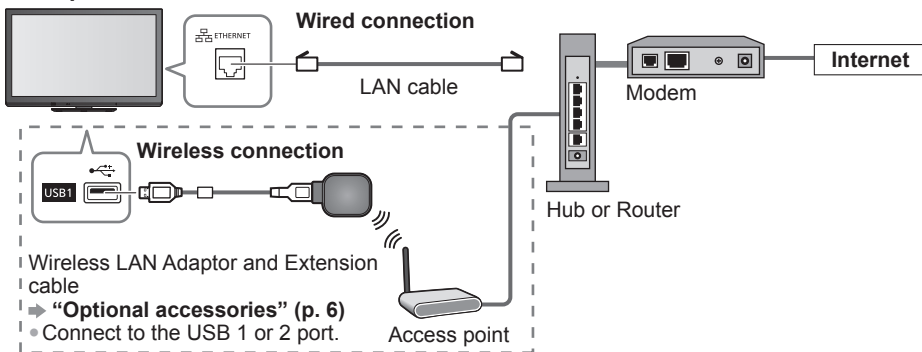

- Ensure to use a LAN straight cable for this connection.
- If your modem has no broadband router functions, use a broadband router.
- If your modem has broadband router functions but there are no vacant ports, use a hub.
- Ensure that the broadband routers and hubs are compatible with 10BASE-T / 100BASE-TX.
- If you use the equipment compatible only with 100BASE-TX, category 5 LAN cables are required.

Example 2

You can connect the TV and the telecommunication equipment directly to use VIERA Connect features.

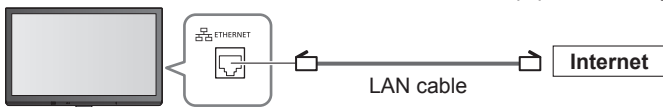

Note

- Contact your Internet Service Provider (ISP) telecommunications company for further assistance regarding the network equipment.
- Confirm the terms and conditions of the contracts with your Internet Service Provider (ISP) or telecommunications company. Depending on the contracts, additional fees may be charged or multiple connections to the internet may be impossible.

Network Setup

- Ensure the connections are completed before starting Network Setup.
➔ “Network connections” (p. 69)



1 Display the menu



2 Select [Setup]

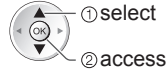
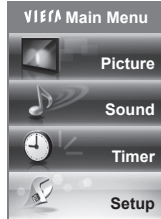

3 Select [Network Setup]

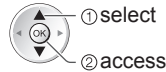

■ To return to TV



Network Link settings

Settings which allow the TV to be controlled by the equipment connected to the network.

1 Select [Network Link Settings]

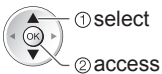
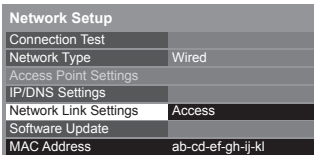

2 Select the items and set

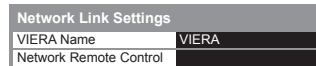

| Menu | Item | Adjustments / Configurations (alternatives) |
|-----------------------|-------------------------------|--|
| Network Link Settings | VIERA Name | Sets your favourite name for this TV <ul style="list-style-type: none"> • This name will be used as the name of this TV on the screen of the other network equipment. |
| | Network Remote Control | Enables to control the TV from the network equipment (Smartphone, etc.) [Off] / [On] <ul style="list-style-type: none"> • Depending on the area, this function may not be available. For details, consult your local Panasonic dealer. • For more information of this function, visit the following website. http://panasonic.jp/support/global/cs/tv/ |

Wired connection settings

This setting is for the network connection by using the LAN cable.

1 Select [Network Type] and set to [Wired]

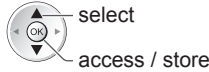
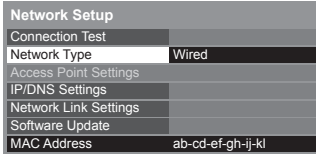

2 Select [IP/DNS Settings] and set the items

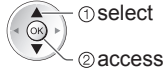

■ [Acquire IP Address] / [Acquire DNS Address]

Sets [IP Address], [Subnet Mask], [Gateway], [Primary DNS] and [Secondary DNS].
Select [Acquire IP Address] / [Acquire DNS Address] and set to [Auto] (recommended)

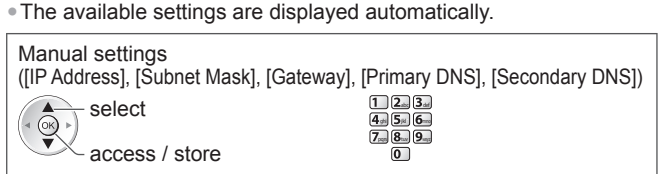
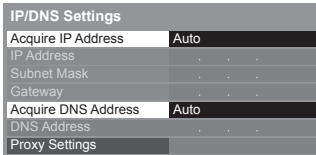

- The available settings are displayed automatically.

3 Select [Proxy Settings] and set the items

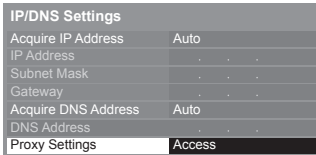

- After settings, return to [Network Setup] screen



■ [Proxy]

Sets Proxy address.

- This is the address of the relay server that is connected to the target server instead of the browser and sends data to the browser. Setting is required if specified by the provider.

1. Select [Proxy]

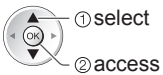
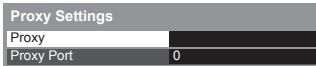

2. Enter the address



- To use numeric buttons
➔ “Characters table for numeric buttons” (p. 91)

3. Store



■ [Proxy Port]

Sets Proxy port number.

- This number is also specified by the provider with the Proxy address.

1. Select [Proxy Port]



2. Move the cursor and enter the number



4 Select [Connection Test] and access to test

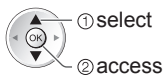
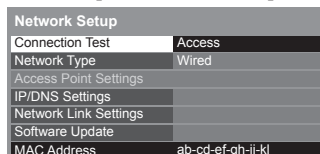

- Performs automatic testing of the network connection for the TV. (It takes a while to test.)

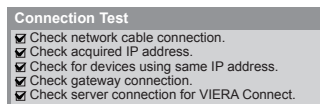

- : **succeeded**
The test is successful and the TV is connected to the network.

- : **failed**
Check the settings and connections, and then perform this function again.

Wireless connection settings

This setting is for the network connection by using the Wireless LAN Adaptor. (Wireless connection)

- Confirm the encryption key, settings and positions of your access point before starting setup. For details, read the manual of the access point.

1 Select [Network Type] and set to [Wireless]

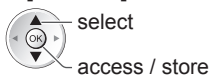
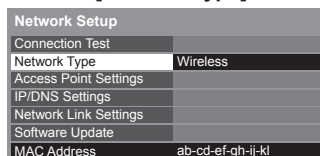

2 Select [Access Point Settings]

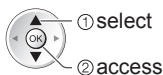
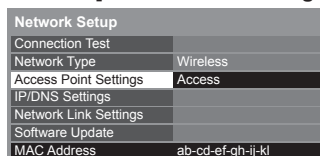

3 Select the connection type and set

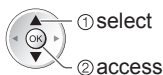
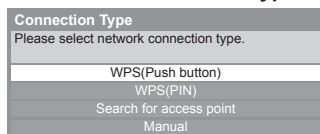

- For details of each connection type ➔ (p. 73, 74)
- After settings, return to [Network Setup] screen



4 Select [Connection Test] and access to test

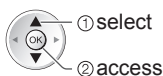
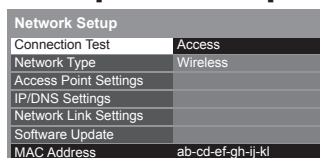

Performs automatic testing of the network connection for the TV. (It takes a while to test.)

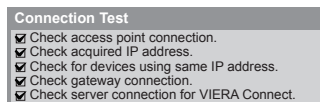

- : **succeeded**
The test is successful and the TV is connected to the network.

- : **failed**
Check the settings and connections, and then perform this function again.
If you continue to have difficulty, please contact your internet service provider.

■ [WPS(Push button)]

WPS(Push button)

1) Please press the 'WPS' button on the access point until its light flashes.

2) When the light is flashing select 'Connect' on TV.

If you are unsure, please check the instruction manual of the access point.

Connect

① press the WPS button on the access point until the light flashes



② connect the Wireless LAN Adaptor and the access point

- Ensure that your access point supports WPS for this setup.
- WPS : Wi-Fi Protected Setup™

■ [WPS(PIN)]

1 Select your desired access point

Available Access Points

| No. | SSID | Wireless type | Encrypt | Reception |
|-----|----------------|---------------|-------------------------------------|-----------|
| 1 | Access Point A | 11n(2.4GHz) | <input checked="" type="checkbox"/> | |
| 2 | Access Point B | 11n(5GHz) | <input checked="" type="checkbox"/> | |
| 3 | Access Point C | 11n(5GHz) | <input type="checkbox"/> | |
| | | | | |
| | | | | |



① select

② access

- Ensure that your access point supports WPS for this setup.

• To search access points again

(yellow)

• For the information of the highlighted access point



• To set manually

(red)

2 Enter the PIN code to the access point, and then select [Connect]

WPS(PIN)

Please register the following PIN codes on the access point.

PIN code : 12345678

Select 'Connect' after entering and saving the settings on the access point.

Connect



■ [Search for access point]

Access points found automatically are listed.

1 Select your desired access point

Available Access Points

| No. | SSID | Wireless type | Encrypt | Reception |
|-----|----------------|---------------|-------------------------------------|-----------|
| 1 | Access Point A | 11n(2.4GHz) | <input checked="" type="checkbox"/> | |
| 2 | Access Point B | 11n(5GHz) | <input checked="" type="checkbox"/> | |
| 3 | Access Point C | 11n(5GHz) | <input type="checkbox"/> | |
| | | | | |
| | | | | |



① select

② access

: Encrypted access point

• To search access points again

(yellow)

• For the information of the highlighted access point



• To set manually

(red)

2 Access the encryption key input mode

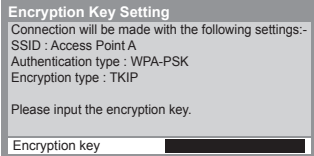

- If the selected access point is not encrypted, the confirmation screen will be displayed. It is recommended to select the encrypted access point.

3 Enter the encryption key of the access point (Set characters one by one)



- To use numeric buttons
- ➔ **“Characters table for numeric buttons” (p. 91)**



4 Select [Yes]

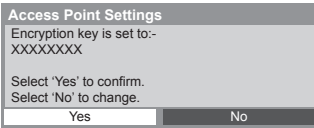

- To re-enter the encryption key, select [No].

■ [Manual]

You can setup SSID, authentication type, encryption type, and encryption key manually.

Follow the on screen instructions and set manually.

- When you use 11n (5 GHz) for the wireless system between the Wireless LAN Adaptor and access point, please select [AES] for the encryption type.

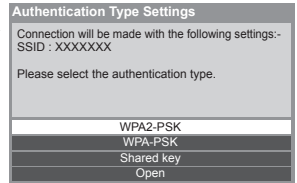
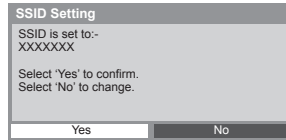
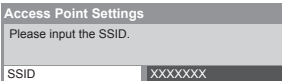

Update TV's software

Check for available software updates from the Panasonic website.

Select [Software Update]

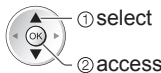
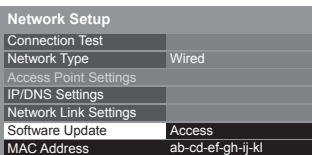

- Follow the on screen instructions

Note

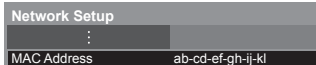

[MAC Address]

- MAC address is a unique address that identifies hardware in the network.
(for information only)

VIERA Connect

You can access VIERA Connect and enjoy various network contents.

- VIERA Connect requires a broadband internet connection. Dial-up internet connections cannot be used.
- Ensure the network connections and network settings are completed.
 - ➔ “**Network connections**” (p. 69), [**Network Setup**] (p. 70 - 74)
- For details about VIERA Connect operation ➔ “**Using “VIERA Connect”**” (p. 17)
- Setup menu (Items in [Setup] may change without notice.)

| | |
|-----------------------------|--|
| Customize HomeScreen | Changes the position of each services on VIERA Connect home screen |
| My Account | Confirms or removes the account information of the TV you entered on VIERA Connect |
| Lock | Sets to restrict access to some services |
| Beep | Sets beep sound On or Off when operating VIERA Connect |
| Notices | Displays the information of VIERA Connect |

Note

- Be sure to update the software when a software update notice is displayed on the TV screen. If the software is not updated, you will not be able to use VIERA Connect. You can update the software later manually ➔ [**Software Update**] in [**Network Setup**] (p. 74)
- VIERA Connect home screen is subject to change without notice.
- The services through VIERA Connect are operated by their respective service providers, and service may be discontinued either temporarily or permanently without notice. Therefore, Panasonic will make no warranty for the content or the continuity of the services.
- Some content may be inappropriate for some viewers.
- Some content may only be available for specific countries and may be presented in specific languages.
- Depending on the connection environment, the internet connection may be slow or may not be successful.
- During the operation, audio signal is output from AV1, AUDIO OUT, DIGITAL AUDIO OUT and HDMI2 (ARC function) terminals. But no video signals are output. AV1 can output audio signal if [AV1 out] is set to [Monitor] in the Setup Menu (p. 39). To use HDMI2 with ARC function, connect an amplifier that has ARC function (p. 77) and set to use theatre speakers (p. 83).
- You can restrict access to VIERA Connect ➔ [**Child Lock**] (p. 53)
- Turn the TV off, and then on again when changing or reconnecting the network connection.

Link Functions (Q-Link / VIERA Link)

Q-Link connects the TV and DVD Recorder / VCR, and enables easy recording, playback, etc. ➔ (p. 78)
 VIERA Link (HDAVI Control™) connects the TV and the equipment with VIERA Link function, and enables easy control, convenient recording, playback, energy saving, creation of a home theatre, etc., without complicated setting. ➔ (p. 79 - 83)
 You can use Q-Link and VIERA Link functions together.

- This TV supports "HDAVI Control 5" function. But available features are depending on the connected equipment's version of HDAVI Control. Please refer to the manual of the equipment to confirm the version.
- VIERA Link features may be available even with other manufacturers' equipment supporting HDMI CEC.

Summary of Q-Link and VIERA Link features

Q-Link (SCART connection only)

| Features | Connected equipment DVD Recorder / VCR with Q-Link function |
|---------------------------|---|
| Analogue channel download | ○ |
| Easy playback | ○ |
| Power on link | ○ |
| Power off link | ○ |
| Direct TV Recording | ○ |

Connection

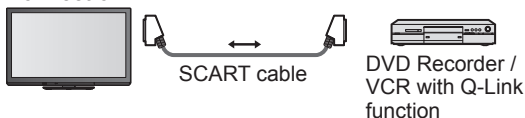

- Use a fully wired SCART cable.
- Connect the DVD Recorder / VCR supporting Q-Link to the TV's AV1 terminal via a SCART cable.

VIERA Link (HDMI connection only)

| Features | Connected equipment DIGA Recorder with VIERA Link function | DVD Player / Blu-ray Disc Player with VIERA Link function | HD Video Camera / LUMIX Camera with VIERA Link function |
|---|--|---|---|
| Analogue channel download | — | — | — |
| Easy playback | ○ | ○ | ○ |
| Power on link | ○ | ○ | ○ |
| Power off link | ○ | ○ | ○ |
| Reduce unnecessary power consumption in standby | ○*3 | ○*3 | — |
| Auto standby for unnecessary equipment | ○*3 | ○*3 | — |
| Pause Live TV programme | ○*3 *4 | — | — |
| Direct TV Recording | ○*3 | — | — |
| Control the menu of the connected equipment by VIERA remote control | ○*1 | ○*1 | ○*1 |
| Speaker control | — | — | — |

Connection

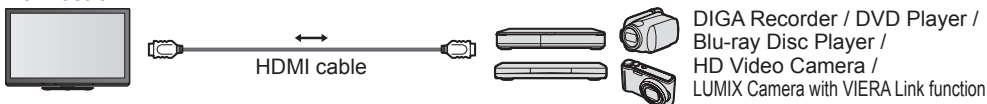

- Use a fully wired HDMI compliant cable.
- Connect the equipment supporting VIERA Link to the TV's HDMI1, HDMI2, HDMI3 or HDMI4 terminal via an HDMI cable.
- For information about using HDMI cables for connecting Panasonic HD Video Camera or LUMIX Camera, read the manual of the equipment.

VIERA Link (HDMI and SCART connections)

| Features | Connected equipment DIGA Recorder with VIERA Link function |
|---|--|
| Analogue channel download | ○ |
| Easy playback | ○ |
| Power on link | ○ |
| Power off link | ○ |
| Reduce unnecessary power consumption in standby | ○*3 |
| Auto standby for unnecessary equipment | ○*3 |
| Pause Live TV programme | ○*2 *4 |
| Direct TV Recording | ○*2 |
| Control the menu of the connected equipment by VIERA remote control | ○*1 |
| Speaker control | — |

Connection

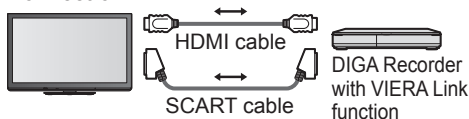

- Use a fully wired HDMI compliant cable.
- Connect the equipment supporting VIERA Link to the TV's HDMI1, HDMI2, HDMI3 or HDMI4 terminal via an HDMI cable.
- Use a fully wired SCART cable.
- Connect the equipment supporting VIERA Link to the TV's AV1 terminal via a SCART cable.

VIERA Link (HDMI and Audio out connections)

| Features | Connected equipment | Player theatre with VIERA Link function | Blu-ray Disc theatre with VIERA Link function | Amplifier with VIERA Link function |
|---|---------------------|---|---|------------------------------------|
| Analogue channel download | | — | — | — |
| Easy playback | | ○*5 | ○*5 | — |
| Power on link | | ○ | ○ | — |
| Power off link | | ○ | ○ | ○ |
| Reduce unnecessary power consumption in standby | | — | ○*3 | — |
| Auto standby for unnecessary equipment | | ○*3 *6 | ○*3 *6 | ○*3 |
| Pause Live TV programme | | — | — | — |
| Direct TV Recording | | — | — | — |
| Control the menu of the connected equipment by VIERA remote control | | ○*1 | ○*1 | — |
| Speaker control | | ○ | ○ | ○ |

Connection

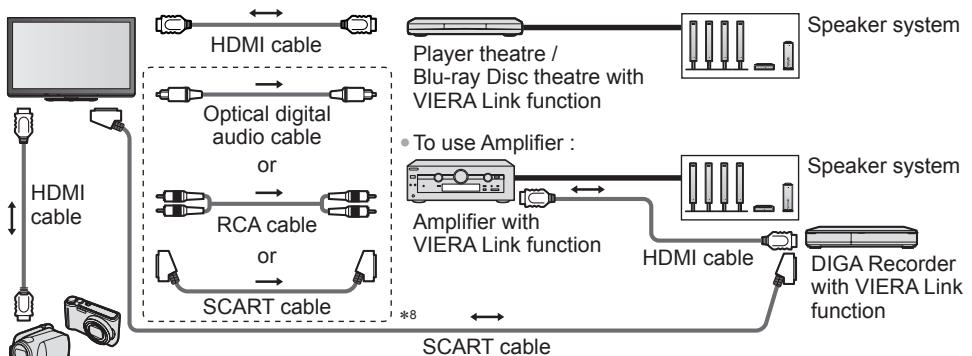

• To use Player theatre / Blu-ray Disc theatre :

Player theatre / Blu-ray Disc theatre with VIERA Link function

• To use Amplifier :

Amplifier with VIERA Link function

Speaker system

Speaker system

DIGA Recorder with VIERA Link function

HD Video Camera / LUMIX Camera with VIERA Link function

- Use fully wired HDMI compliant cable.
- Connect the equipment supporting VIERA Link to the TV's HDMI2, HDMI3 or HDMI4 terminal via an HDMI cable.
- Use fully wired SCART cable.
- If you use a SCART cable for audio output, connect the equipment supporting VIERA Link to the TV's AV1 terminal and set [AV1 out] to [Monitor] in the Setup Menu (p. 39).
- Use the optical digital audio cable, RCA cable or SCART cable for audio output from the TV.

*1 : Available with the equipment which has "HDAVI Control 2 or later" function.

*2 : Available with the equipment which has "HDAVI Control 3 or later" function.

*3 : Available with the equipment which has "HDAVI Control 4 or later" function.

*4 : Available with DIGA Recorder which has HDD.

*5 : While playing a disc

*6 : Except for watching a disc

*7 : If the connected equipment has "HDAVI Control 5" function, you do not have to use this audio cable (Optical digital audio cable, RCA cable or SCART cable). In this case, connect the equipment to the TV's HDMI2 terminal via an HDMI cable.

VIERA Link Control of compatible equipment ([VIERA Link Control] ▶ p. 81)

- Table below displays maximum number of compatible equipment that can be controlled by VIERA Link Control.

This includes connections to equipment already connected to the TV.

For example, DIGA Recorder connected to Amplifier which is connected to the TV via an HDMI cable.

| Type of the equipment | Maximum number |
|---|----------------|
| Recorder (DIGA Recorder, etc.) | 3 |
| Player (DVD Player, Blu-ray Disc Player, HD Video Camera, LUMIX Camera, Digital Camera, Player theatre, Blu-ray Disc theatre, etc.) | 3 |
| Audio system (Player theatre, Blu-ray Disc theatre, Amplifier, etc.) | 1 |
| Tuner (Set top box, etc.) | 4 |

Preparations

- Connect the DVD Recorder / VCR with the following logos :
 “Q-Link”, “NEXTVIEWLINK”, “DATA LOGIC (a trademark of Metz Corporation)”, “Easy Link (a trademark of Philips Corporation)”, “Megalogic (a trademark of Grundig Corporation)” or “SMARTLINK (a trademark of Sony Corporation)”
- Q-Link connection ➔ (p. 76)
- Use fully wired SCART cable.
- Set up the DVD Recorder / VCR. Read the manual of the recorder.
- Q-Link terminal setup in the Setup Menu ➔ **[AV1 out] (p. 39)**
- Download Analogue channel setting ➔ **“Analogue channel download” (see below)**

Features available

Analogue channel download

Analogue channel settings can be downloaded to a recorder with an analogue tuner (where Analogue is still broadcast). Digital channel settings are not downloaded.

- To download the Analogue channel settings
 ➔ **[Q-Link Download] (p. 39) or [Auto Setup] in Analogue mode (p. 46) or “Auto Setup” - when first using the TV (p. 13)**

Direct TV Recording - What you see is What you record

Recording the current programme on a DVD Recorder / VCR immediately.

- Available conditions :



| Picture source | Mode | Recording from |
|---|------|---------------------------|
| Analogue | TV | TV monitor out |
| | AV | Recorder's tuner |
| DVB | TV | TV monitor out |
| AV (watching recorder's tuner) | AV | Recorder's tuner |
| AV (watching recorder's external input) | AV | Recorder's external input |
| AV (watching TV's external input) | AV | TV monitor out |

- When Direct TV Recording is performed, the recorder is automatically turned on if it is in Standby mode.
- Changing channel or turning off the TV is available while the recorder is recording from its own tuner.
- Changing channel is not available while the recorder is recording from the TV tuner.

■ To stop recording

Unlock the tuner

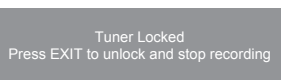

Power on link and Easy playback

When the DVD Recorder / VCR starts playback or the direct navigator / function menu for the equipment is activated, the TV is turned on and the input mode is switched automatically so that you can view the content. (Only when the TV is in Standby mode.)

Power off link

When the TV is set to Standby mode, the recorder is also automatically set to Standby. (Only when the videocassette or disc is not active.)

- This function will work even if the TV enters Standby mode automatically by auto power standby function.

Note

- Some recorders are not compatible. Read the manual of the recorder.

***Enjoy additional HDMI Inter-Operability with Panasonic products which have “HDAVI Control” function.**

This TV supports “HDAVI Control 5” function.

Connections to the equipment (DIGA Recorder, HD Video Camera, Player theatre, Amplifier, etc.) with HDMI and SCART cables allow you to interface them automatically (p. 76, 77).

These features are limited to models incorporating “HDAVI Control” and “VIERA Link”.

- Some functions are not available depending on the equipment’s version of HDAVI Control. Please confirm the connected equipment’s version of HDAVI Control.

- VIERA Link “HDAVI Control”, based on the control functions provided by HDMI which is an industry standard known as HDMI CEC (Consumer Electronics Control), is a unique function that we have developed and added.

As such, its operation with other manufacturers’ equipment that supports HDMI CEC cannot be guaranteed.

- Please refer to individual manuals for other manufacturers’ equipment supporting VIERA Link function.

- For information about applicable Panasonic equipment, consult your local Panasonic dealer or refer to www.panasonic.co.uk

Preparations

- Connect the equipment that supports VIERA Link.

- VIERA Link connection ➔ (p. 76, 77)

Use a fully wired HDMI compliant cable. Non-HDMI-compliant cables cannot be utilised.

Recommended Panasonic HDMI cables’ part numbers :

- RP-CDHS15 (1.5 m) • RP-CDHS30 (3.0 m) • RP-CDHS50 (5.0 m)

- Use a fully wired SCART cable.

- Set up the connected equipment. Read the manual of the equipment.

- For optimal recording, the settings of the recorder may need to be changed. For details, read the manual of the recorder.

- Download Analogue channel setting ➔ “Analogue channel download” (see below)

- Set [VIERA Link] [On] in the Setup Menu ➔ [VIERA Link] (p. 39)

- Set up the TV

➔ **After connection, turn the equipment on and then switch the TV on.**

Select the input mode to HDMI1, HDMI2, HDMI3 or HDMI4 (p. 28), and make sure that an image is displayed correctly.

This setup should be done each time when the following conditions occur :

- for the first time
- when adding or reconnecting equipment
- when changing setup

Features available

Analogue channel download

Analogue channel settings can be downloaded to a recorder with an analogue tuner (where Analogue is still broadcast). Digital channel settings are not downloaded.

- To download the Analogue channel settings

➔ [Q-Link Download] (p. 39) or [Auto Setup] in Analogue mode (p. 46) or “Auto Setup” - when first using the TV (p. 13)

Easy playback

Automatic Input switching - When the connected equipment is operated (during playback or menu operations, etc.), the input mode is switched automatically. When playback is stopped or menus are exited, the input mode returns to the original setting.

Power on link

When the connected equipment starts playback or the direct navigator / function menu for the equipment is activated, the TV is automatically turned on and the input mode is switched automatically so that you can view the content. (Only when the TV is in Standby mode.)

Power off link

When the TV is set to Standby mode, the connected equipment is also automatically set to Standby.

- This function will work even if the TV enters Standby mode automatically by auto power standby function.

Reduce unnecessary power consumption in standby [Standby Power Save]

Set Standby Power Save [On] in the Setup Menu to use this function → [Standby Power Save] (p. 39)

The power consumption in Standby mode of the connected equipment is controlled in synchronization with the TV On / Off state.

When the TV is set to Standby mode, the connected equipment is automatically set to Standby and the power consumption in Standby mode of the connected equipment is automatically minimised.

When the TV is turned on and the connected equipment is still in Standby mode, the power consumption of the connected equipment is increased to reduce the startup time.

- This function is effective if the connected equipment can change the power consumption in Standby mode and is set to higher consumption.

Auto standby for unnecessary equipment [Intelligent Auto Standby]

Set Intelligent Auto Standby [On (With reminder)] or [On (No reminder)] in the Setup Menu to use this function → [Intelligent Auto Standby] (p. 39)

When the TV is On, non-watched or non-used connected equipment goes into Standby mode automatically to reduce power consumption. For example, when the input mode is switched from HDMI, the connected equipment will go into Standby mode / when Speaker Selection is changed to [TV], the Player theatre will go into Standby mode (except when watching a disc).

- If you select [On (With reminder)], the on screen message will be displayed before the connected equipment turns to Standby.
- This function may not work properly depending on the connected equipment. If required, set to [Off].

Direct TV Recording - What you see is What you record [Direct TV Rec]

Recording the current programme on a DIGA Recorder immediately.

- If you connect a variety of recorders including other manufacturers' recorders at the same time, please connect the DIGA Recorder to the TV's lower HDMI terminal number. For example, if you use HDMI1 and HDMI2 for two recorders, connect the DIGA Recorder to HDMI1.
- If Direct TV Recording does not operate, check the settings and the equipment → "Summary of Q-Link and VIERA Link features" (p. 76, 77), "Preparations" (p. 79)
- If you wish to record a programme that the DIGA Recorder does not support, a SCART connection is required and the programme is recorded by Q-Link function (p. 78).
- Depending on the programme, a SCART connection may be required to record.
- Changing channel or turning off the TV is available while the recorder is recording from its own tuner.
- Changing channel is not available while the recorder is recording from the TV tuner.

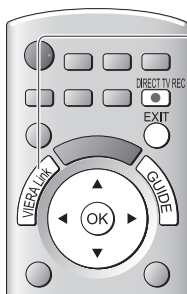

1 Display [VIERA Link Menu]

2 Select [Direct TV Rec] and start recording

| VIERA Link Menu | |
|--------------------|-------------|
| Pause Live TV | Start |
| Direct TV Rec | Start |
| VIERA Link Control | Recorder |
| Speaker Selection | Home Cinema |

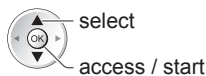

- You can also start recording directly.



■ To stop recording

Select [Stop] in [Direct TV Rec]

| VIERA Link Menu | |
|--------------------|-------------|
| Pause Live TV | Start |
| Direct TV Rec | Stop |
| VIERA Link Control | Recorder |
| Speaker Selection | Home Cinema |

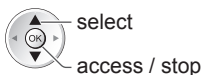

- You can also stop recording directly.

Unlock the tuner

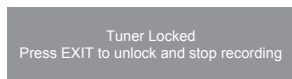

Pause Live TV programme [Pause Live TV]

You can pause the live TV programme and resume the programme later.

The live TV programme will be recorded on HDD of the connected DIGA Recorder.

- This function is available with a DIGA Recorder which has HDD.
- If you connect a variety of recorders including other manufacturers' recorders at the same time, please connect the DIGA Recorder which has HDD to the TV's lower HDMI terminal number. For example, if you use HDMI1 and HDMI2 for two recorders, connect the DIGA Recorder which has HDD to HDMI1.
- If Pause Live TV does not operate, check the settings and the equipment
 - ➔ "Summary of Q-Link and VIERA Link features" (p. 76, 77), "Preparations" (p. 79)

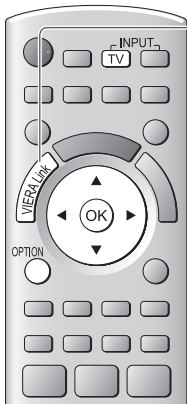

1 Display [VIERA Link Menu]

2 Select [Pause Live TV] and pause

The TV picture will be paused.

| VIERA Link Menu | |
|--------------------|-------------|
| Pause Live TV | Start |
| Direct TV Rec | Start |
| VIERA Link Control | Recorder |
| Speaker Selection | Home Cinema |



- Live TV programme is recorded on HDD from where it was paused.
- If the paused TV picture disappears after a few minutes.

OPTION



(the paused picture will be restored)

- Follow the operation guide to operate Pause Live TV function.

■ To operate Pause Live TV

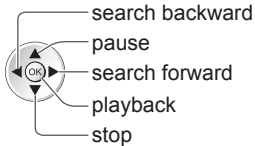

- search backward
- pause
- search forward
- playback
- stop
- If you stop playback, the recorded programme will be deleted from HDD.

- Operations may be different depending on the recorder. In this case, follow the operation guide or read the manual of the recorder.

■ To return to Live TV (stop playback of Pause Live TV / cancel pause)

Select [Yes]

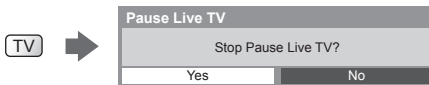

- If you stop playback or cancel pause, the recorded programme will be deleted from HDD.

Control the menu of the connected equipment by VIERA remote control [VIERA Link Control]

You can control some functions of the connected equipment with this TV remote control (point the remote control at the TV's signal receiver).

- If you cannot operate the menu of the connected equipment, check the settings and the equipment
 - ➔ "Summary of Q-Link and VIERA Link features" (p. 76, 77), "Preparations" (p. 79)
- For details of the operations for the connected equipment, read the manual of the equipment.



1 Display [VIERA Link Menu]

2 Select [VIERA Link Control]

| VIERA Link Menu | |
|--------------------|-------------|
| Pause Live TV | Start |
| Direct TV Rec | Start |
| VIERA Link Control | Recorder |
| Speaker Selection | Home Cinema |

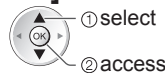

3 Select the equipment you want to access

The type of the connected equipment is displayed. Select the type of the equipment and access.



[Recorder] / [Player] / [Home Cinema] / [Video Camera] / [LUMIX] / [Digital Camera] / [Other]

- You can also access directly by using VIERA TOOLS ➔ “How to Use VIERA TOOLS” (p. 34)
- The displayed item may vary depending on the connected equipment.
- [Home Cinema] means Player theatre, Blu-ray Disc theatre or Recorder theatre.
- [Other] means Tuner set top box.

The menu of the accessed equipment (Input mode will be changed automatically)

4 Operate the menu of the equipment

Available VIERA remote control buttons :
(depending on the connected equipment)



1 Set the position to “TV”



2 Follow the operation guide

- To display the operation guide



If other manufacturers' equipment is accessed, Setup / Contents Selection menu may be displayed.

- When the key words are displayed on colour bar
 (red) (green) (yellow) (blue)

Note

- Some operations may not be available depending on the equipment. In this case use its own remote control to operate the equipment.

■ If multiple recorders or players are connected

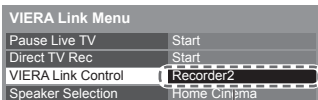

The number is given from the TV's lower HDMI terminal number connected to the same type equipment. For example, two recorders to HDMI2 and HDMI3, in this case the recorder connected to HDMI2 is displayed as [Recorder1], and the recorder connected to HDMI3 is displayed as [Recorder2].

[Recorder1-3 / Player1-3]

■ If you access non-VIERA Link equipment



The type of the connected equipment is displayed. You can access the menu of the equipment. But you cannot operate it. Use its own remote control to operate the equipment.

Speaker control [Speaker Selection]

You can control the home theatre speakers with this TV remote control (point the remote control at the TV's signal receiver).

- If you cannot operate, check the settings and the equipment
➔ **“Summary of Q-Link and VIERA Link features” (p. 76, 77), “Preparations” (p. 79)**



1 Display [VIERA Link Menu]



2 Select [Speaker Selection]

| VIERA Link Menu | |
|--------------------|-------------|
| Pause Live TV | Start |
| Direct TV Rec | Start |
| VIERA Link Control | Recorder |
| Speaker Selection | Home Cinema |

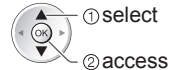

3 Set to [Home Cinema] or [TV]



[Home Cinema]

The Player theatre, Blu-ray Disc theatre or Amplifier will be automatically turned on if it is in Standby mode and the sound will be output from the theatre speakers connected to the equipment.

- Volume up / down
- Mute



- The sound of the TV speakers is muted.
- When the equipment is turned off, the TV speakers will be activated.

[TV]

TV speakers are active.

Multi-channel sound

If you wish to enjoy multi-channel sound (e.g. Dolby Digital 5.1ch) via an Amplifier, connect the Amplifier to the TV with an HDMI cable and an Optical digital audio cable (p. 77), and then select “Home Cinema”. If your Amplifier has “HDAVI Control 5” function, you only need to connect with an HDMI cable. In this case, connect your Amplifier to the TV's HDMI2 terminal. To enjoy the sound from the DIGA Recorder in multi-channel sound, connect an HDMI cable from the DIGA Recorder to the Amplifier (p. 75).

Note

- These functions may not work properly depending on the connected equipment.
- Image or sound may not be available for the first few seconds when input mode is switched.
- Easy playback may be available by using the remote control for Player theatre, Blu-ray Disc theatre or Amplifier. Read the manual of the equipment.
- “HDAVI Control 5” is the newest standard (current as of December, 2010) for HDAVI Control compatible equipment. This standard is compatible with conventional HDAVI equipment.
- To confirm this TV's version of HDAVI Control ➔ **[System Information] (p. 41)**

External Equipment

These diagrams show our recommendations for connection of your TV to various pieces of equipment. For other connections, consult the instructions for each piece of equipment, the table (p. 86), and the specifications (p. 102, 103).

To record / playback

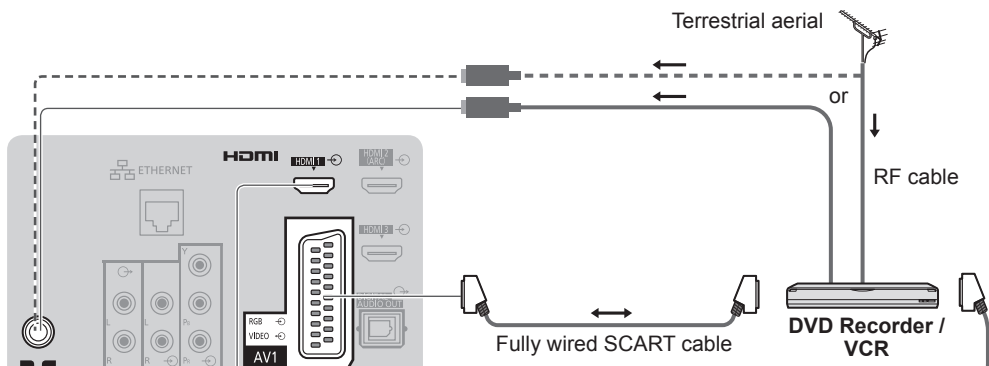

To watch satellite broadcasts

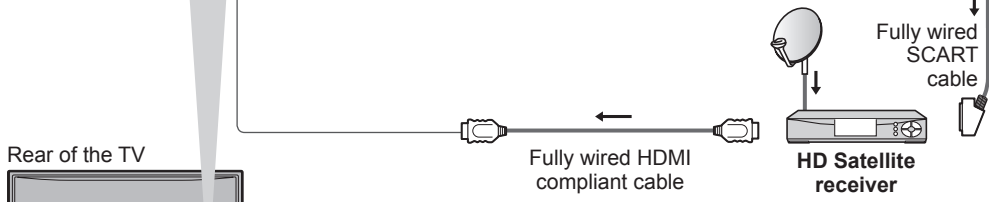

HDMI equipment

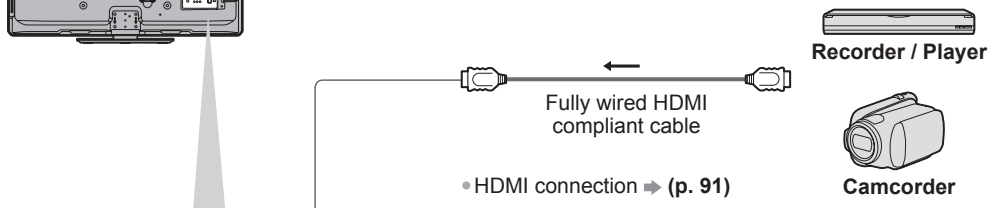

To watch DVDs

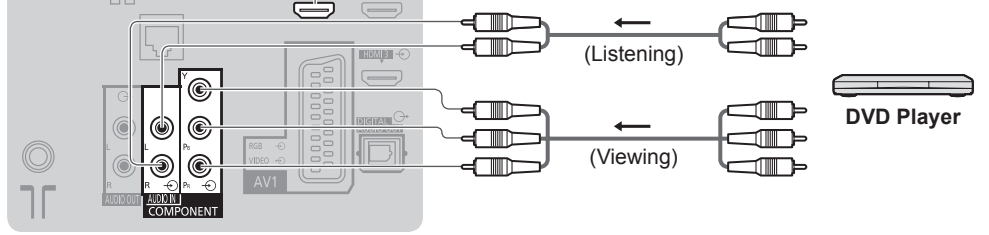

External Equipment

Network (wired)

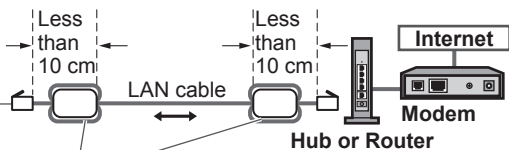

Ferrite core - Large size (supplied)

Installing the Ferrite core

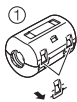

Pull back the tabs (in two places)



Wind the cable twice

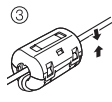

Press the cable through and close

USB devices



Camcorder / Game equipment

Rear of the TV

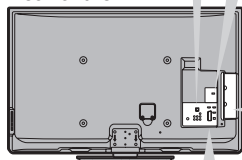

Side panel of the TV

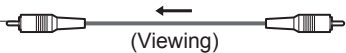
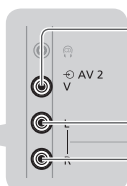

Camcorder

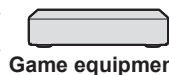

Game equipment

To listen with speakers

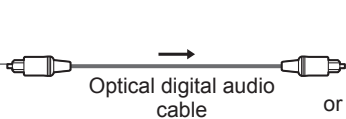

Amplifier with speaker system

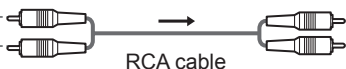

To enjoy the sound from the external equipment in multi-channel sound (e.g. Dolby Digital 5.1ch), connect the equipment to the amplifier. For the connections, read the manuals of the equipment and amplifier.

Headphones

Rear of the TV

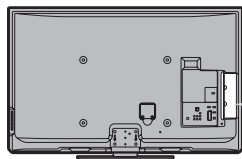

Side panel of the TV



(M3 stereo mini plug)

Less than 10 cm

Ferrite core - Small size (supplied)
(TX-P42ST31B)

Installing the Ferrite core



Pull back the tab





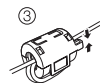





Wind the cable twice



Press the cable through and close

- To adjust volume
➔ **[Headphone Volume]** (p. 38)

Types of connectable equipment to each terminal

| Recording / Playback (equipment) | Terminal | | | | | | | |
|---|---|---|---|---|---|---|---|---|
| | AV 1 | AV 2 | COMPONENT | AUDIO OUT | DIGITAL AUDIO OUT | ETHERNET | HDMI 1 - 4 | USB 1 - 2 |
| To record / playback videocassettes / DVDs (VCR / DVD Recorder) |  |  |  |  |  |  |  |  |
| To record / playback videocassettes / DVDs (VCR / DVD Recorder) | <input type="radio"/> | | | | | | | |
| To watch 3D contents (Blu-ray Disc Player) | | | | | | | <input type="radio"/> | |
| To watch satellite broadcasts (Set top box) | <input type="radio"/> | <input type="radio"/> | | | | | <input type="radio"/> *1 | |
| To watch DVDs (DVD Player) | <input type="radio"/> | <input type="radio"/> | <input type="radio"/> | | | | <input type="radio"/> | |
| To watch camcorder images (Video camera) | <input type="radio"/> | <input type="radio"/> | | | | | <input type="radio"/> | |
| To play games (Game equipment) | <input type="radio"/> | <input type="radio"/> | | | | | <input type="radio"/> | |
| To use amplifier with speaker system | | | | <input type="radio"/> | <input type="radio"/> | | <input type="radio"/> *2 | |
| To use network services | | | | | | <input type="radio"/> | | <input type="radio"/> |
| Q-Link | <input type="radio"/> | | | | | | | |
| VIERA Link | <input type="radio"/> (with HDMI) | | | | | | <input type="radio"/> | |
| Direct TV Recording | <input type="radio"/> | | | | | | <input type="radio"/> | |

○ : Recommended Connection

*1 : Use HDMI1 for automatic input switching.

*2 : Use HDMI2 for connecting an amplifier. This connection is applicable when using an amplifier that has ARC (Audio Return Channel) function.

Technical Information

Auto Aspect

The optimum size and aspect can be chosen automatically, and you can enjoy finer images. ➔ (p. 21)

Aspect Control Signal

[WIDE] will appear in the top left of the screen if a Widescreen signal (WSS) or a Control signal through SCART / HDMI terminal is found.

The aspect will switch to the appropriate 16:9 or 14:9 widescreen ratio.

This function will work in any aspect mode.

| Input terminal | Input signal format | Aspect Control Signal | |
|----------------------------------|-------------------------------|-------------------------|---|
| | | Widescreen signal (WSS) | Control signal through SCART (pin8) / HDMI terminal |
| RF | DVB | ○ | |
| | PAL I | ○ | |
| | PAL 525/60 6.0 MHz | – | |
| | M.NTSC 6.0 MHz | – | |
| AV1 / AV2 (Composite) | PAL | ○ | ○ |
| | PAL 525/60 | – | ○ |
| | M.NTSC | – | ○ |
| | NTSC | – | ○ |
| COMPONENT | 525 (480) / 60i, 60p | – | |
| | 625 (576) / 50i, 50p | ○ | |
| | 750 (720) / 60p, 50p | – | |
| | 1,125 (1,080) / 60i, 50i | – | |
| HDMI1 HDMI2 HDMI3 HDMI4 | 525 (480) / 60i, 60p | – | ○ |
| | 625 (576) / 50i, 50p | – | ○ |
| | 750 (720) / 60p, 50p | – | ○ |
| | 1,125 (1,080) / 60i, 50i | – | ○ |
| | 1,125 (1,080) / 60p, 50p, 24p | – | ○ |

Auto mode

Auto mode determines the best aspect ratio to fill the screen. It does this using a four step process (WSS, Control signal through SCART / HDMI terminal, Letterbox detection or Justify to fill the screen). This process may take several minutes, depending on the darkness of the image.

Letterbox detection:

If black bands at the top and bottom of the screen are detected, Auto mode chooses the best ratio and expands the image to fill the screen.

If no aspect signals are detected, Auto mode enhances the image for optimum viewing pleasure.

Note

- The ratio varies depending on the programme, etc. If the ratio is out of the standard 16:9, black bands at the top and bottom of the screen may appear.
- If the screen size looks unusual when a widescreen-recorded programme is played back on a VCR, adjust the tracking of the VCR. Read the manual of the VCR.

Supported file format in Media Player

■ Photo

| Format | File extension | Image resolution (pixel) | Details / Restrictions |
|--------|----------------|--------------------------------|--|
| JPEG | .jpg .mpo | 8 × 8 to 30,719 × 17,279 | DCF*1 and EXIF*2 standards Sub-sampling : 4:4:4, 4:2:2, 4:2:0 • Progressive JPEG is not supported. |

*1 : Design rule for Camera File system - unified standard established by Japan Electronics and Information Technology Industries Association (JEITA)

*2 : Exchangeable Image File - image file format used by digital cameras

■ Video

| Container | File extension | Video codec | Audio codec | Details / Restrictions |
|-----------|----------------|---|---|--|
| SD-Video | .mod | MPEG1 MPEG2 | MPEG Dolby Digital | SD-Video Standard Ver. 1.3 (Entertainment Video Profile) • The data may not be available if a folder structure on the device is modified. |
| AVCHD | .mts | H.264 | Dolby Digital | AVCHD Standard (including 3D videos recorded by the 3D-compatible Video Camera) • The data may not be available if a folder structure on the device is modified. |
| AVI | .avi .divx | DIV3 DIV4 DIVX DX50 DIV6 XviD MPEG4 SP / ASP | MPEG MP3 Dolby Digital | • Certified to play DivX Plus HD video file in Media Player For details of DivX ➡ “DivX” (p. 89) |
| MKV | .mkv | H.264 BP / MP / HP | MPEG MP3 Dolby Digital DTS core | |
| ASF | .asf .wmv | Windows Media Video Ver. 9 VC-1 | WMA | • Copy-protected files cannot be played back. • WMA Pro and WMA Lossless are not supported. |
| MP4 | .mp4 | H.264 BP / MP / HP | AAC MP3 Dolby Digital | • This TV supports this container recorded by Panasonic products. For details, read the manual of the products. |
| MOV | .mov | MotionJPEG H.264 BP / MP / HP | Linear PCM (RAW / TWOS / SOWT) AAC MP3 Dolby Digital | • This TV supports Motion JPEG recorded by Panasonic LUMIX Camera*3. |
| PS | .mpg .mpeg | MPEG1 MPEG2 | MPEG MP3 Linear PCM | — |

*3 : Some products of before the year 2004 may not be available. The compatibility with future products is not guaranteed.

■ Music

| Codec | File extension | Restrictions |
|-------|----------------|--|
| MP3 | .mp3 | – |
| AAC | .m4a | • Copy-protected files cannot be played back. |
| WMA | .wma | • Copy-protected files cannot be played back. • WMA Pro and WMA Lossless are not supported. |

Note

- Some files may not be played back even if they fulfill these conditions.
- Do not use two-byte characters or other special codes for data.
- The device may become unusable with this TV if the file or folder names are changed.

DivX

DivX Certified® to play DivX® and DivX Plus™ HD (H.264/MKV) video up to 1080p HD including premium content.

ABOUT DIVX VIDEO :

DivX® is a digital video format created by DivX, Inc. This is an official DivX Certified® device that plays DivX video.

Visit divx.com for more information and software tools to convert your files into DivX video.

Subtitle text file of DivX

Subtitles format - MicroDVD, SubRip, TMLPlayer

- The DivX video file and subtitles text file are inside the same folder, and the file names are the same except for the file extensions.
- If there are more than one subtitles text files inside the same folder, they are displayed in the following order of priority :
“.srt”, “.sub”, “.txt”.
- To confirm or change the current subtitle status while playing DivX content, press the OPTION button to display Option Menu.
- Depending on the methods used to create the file or the state of recording, only parts of the subtitles may be displayed, or the subtitles may not be displayed at all.

Note

- Depending on how you make SD Card or USB Flash Memory, files and folders may not be displayed in the order you numbered.
- Depending on how you create the files and the structure of folders, the files and folders may not be displayed.
- When there are many files and folders, operation may take time to complete or some files may not be displayed or played.

ABOUT DIVX VIDEO-ON-DEMAND :

This DivX Certified® device must be registered in order to play purchased DivX Video-on-Demand (VOD) movies. To obtain your registration code, locate the DivX VOD section in the Setup Menu. Go to vod.divx.com for more information on how to complete your registration.

To show DivX VOD registration code

➔ [DivX® VOD] in the Setup Menu (p. 41)

- If you want to generate the new registration code, you have to deregister the present registration code. After playing DivX VOD content once, the confirmation screen to deregister will be displayed in [DivX® VOD] in the Setup Menu. If you press the OK button on the confirmation screen, the deregistration code will be generated and you will not be able to play any contents that you purchased using the present registration code.

You will obtain the new registration code by pressing the OK button on the deregistration code screen.

- If you purchase DivX VOD content using a registration code different from this TV's code, you will not be able to play this content. ([Your device is not authorized to play this DivX protected video.] is displayed.)

Regarding DivX content that can only be played a set number of times

Some DivX VOD content can only be played a set number of times.

When you play this content, the remaining number of plays is displayed. You cannot play this content when the number of remaining plays is zero. ([This DivX rental has expired.] is displayed.)

- When playing this content, the number of remaining plays is reduced by one in the following conditions :
 - If you exit the current application.
 - If you play the other content.
 - If you go to the next or previous content.

Devices for recording or playing back

■ SD Card (for playing back in Media Player)

Card format : SDXC Card - exFAT SDHC Card / SD Card - FAT16 or FAT32

Compliant card type (maximum capacity) :

SDXC Card (64 GB), SDHC Card (32 GB), SD Card (2 GB),
miniSD Card (2 GB) (requiring miniSD adaptor)

- If miniSD Card is used, insert / remove it together with the adaptor.
- Check the latest information on the card type at the following website.
<http://panasonic.jp/support/global/cs/tv/>
- Use an SD Card which meets SD standards. If not, it may cause the TV to malfunction.

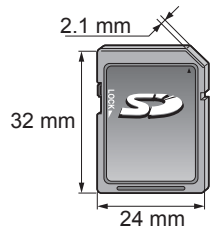

■ USB Flash Memory (for playing back in Media Player)

USB Flash Memory format : FAT16, FAT32 or exFAT

- A USB HDD formatted by PC is not supported in Media Player.

Note

- Data modified with a PC may not be displayed.
- Do not remove the device while the TV is accessing data (this can damage device or TV).
- Do not touch the pins on the device.
- Do not subject the device to a high pressure or impact.
- Insert the device in the correct direction (otherwise, device or TV may be damaged).
- Electrical interference, static electricity, or erroneous operation may damage the data or device.
- Back up the recorded data at regular intervals in case of deteriorated or damaged data or erratic operation of the TV. (Panasonic is not liable for any deterioration or damage of recorded data.)

SCART and HDMI terminal information

AV1 SCART terminal (RGB, VIDEO, Q-Link)

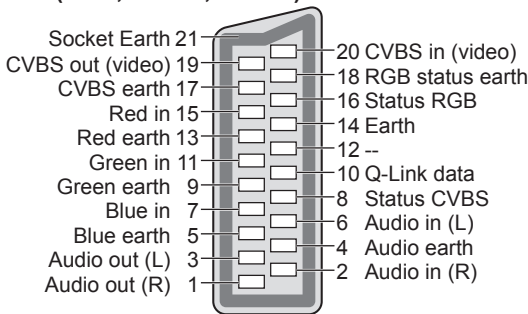

HDMI terminal

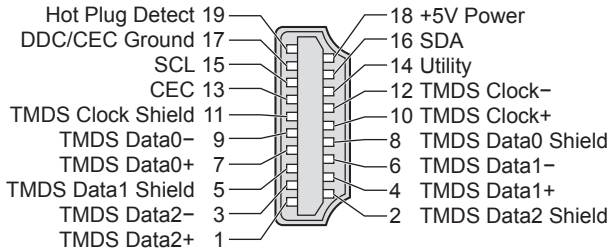

Characters table for numeric buttons

You can enter characters by using numeric buttons for free input items.

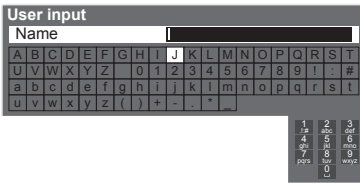

Press the numeric button repeatedly until you reach the desired character.

- The character is set automatically if you do not press the button for 1 second.
- You can also set the character by pressing the OK button or other numeric buttons within 1 second.

Characters table :

| Numeric buttons | The number of times to press | | | | | | | | | | |
|-----------------|------------------------------|---|---|---|---|---|---|---|---|----|----|
| | 1 | 2 | 3 | 4 | 5 | 6 | 7 | 8 | 9 | 10 | 11 |
| 1 | . | 1 | ! | : | # | + | - | * | _ | (|) |
| 2 | a | b | c | 2 | A | B | C | | | | |
| 3 | d | e | f | 3 | D | E | F | | | | |
| 4 | g | h | i | 4 | G | H | I | | | | |
| 5 | j | k | l | 5 | J | K | L | | | | |
| 6 | m | n | o | 6 | M | N | O | | | | |
| 7 | p | q | r | s | 7 | P | Q | R | S | | |
| 8 | t | u | v | 8 | T | U | V | | | | |
| 9 | w | x | y | z | 9 | W | X | Y | Z | | |
| 0 | Space | 0 | | | | | | | | | |

HDMI connection

HDMI (high-definition multimedia interface) is the world's first complete digital consumer AV interface complying with a non-compression standard.

HDMI allows you to enjoy high-definition digital images and high-quality sound by connecting the TV and the equipment.

HDMI-compatible equipment*1 with an HDMI or DVI output terminal, such as a DVD player, a cable TV Box or a game equipment, can be connected to the HDMI terminal using an HDMI compliant (fully wired) cable. For information about connections, see "External Equipment" (p. 84).

Applicable HDMI features

- Input audio signal :
 - 2ch Linear PCM (sampling frequencies - 48 kHz, 44.1 kHz, 32 kHz)
- Input video signal :
 - 480i, 480p, 576i, 576p, 720p, 1080i and 1080p
 - ➔ **"Input signal that can be displayed"** (p. 93)
 - Match the output setting of the digital equipment.
- Input PC signal :
 - ➔ **"Input signal that can be displayed"** (p. 93)
 - Match the output setting of the PC.
- VIERA Link (HDAVI Control 5)
 - ➔ **[VIERA Link] (p. 79)**
- 3D
- Content Type
- Deep Colour
- x.v.Colour™
- Audio Return Channel*2 (HDMI2 terminal only)

DVI connection

If the external equipment has only a DVI output, connect to the HDMI terminal via a DVI to HDMI adaptor cable*3. When the DVI to HDMI adaptor cable is used, connect the audio cable to the audio input terminal (HDMI1 / 2 / 3 : use AUDIO IN terminals / HDMI4 : use AV2 audio terminals).

Note

- Audio settings can be made on the [HDMI1 / 2 / 3 / 4 Input] in the Sound Menu. (p. 38)
- If the connected equipment has an aspect adjustment function, set the aspect ratio to [16:9].
- These HDMI connectors are "type A".
- These HDMI connectors are compatible with HDCP (High-Bandwidth Digital Content Protection) copyright protection.
- Equipment having no digital output terminal may be connected to the input terminal of "COMPONENT" or "VIDEO" to receive analogue signals.
- This TV incorporates HDMI™ technology.

*1 : The HDMI logo is displayed on HDMI-compliant equipment.

*2 : Audio Return Channel (ARC) is a function to be able to send digital sound signals via an HDMI cable.

*3 : Enquire at your local digital equipment retailer shop.

USB connection

- It is recommended to connect the USB Flash Memory directly to the TV's USB ports.
- Some USB devices or USB HUB may not be used with this TV.
- You cannot connect any devices by using USB card reader.
- You cannot use two or more same kind of USB devices simultaneously except USB Flash Memory.
- Additional information for USB devices may be on the following website.
<http://panasonic.jp/support/global/cs/tv/>

USB Keyboard

- The USB Keyboard which requires the driver is not supported.
- To change the language type ➔ **[USB Keyboard Layout] (p. 41)**
- Characters may not be displayed correctly on the TV screen depending on the connected keyboard or the keyboard layout setting.
- Some of the keys of USB keyboards may correspond to the operation of the remote control.

| USB Keyboard | Remote Control | USB Keyboard | Remote Control |
|-------------------|-----------------|----------------------|-------------------|
| ↑ / ↓ / ← / → | Cursor buttons | F2 | VIERA TOOLS |
| Enter | OK | F3 | MENU |
| Backspace | BACK/RETURN | F4 | INPUT (AV) |
| Esc | EXIT | F5 / F6 | Channel Down / Up |
| 0 - 9 / Character | Numeric buttons | F7 / F8 | Volume Down / Up |
| F1 | GUIDE | F9 / F10 / F11 / F12 | Coloured buttons |

Gamepad

- Check the gamepads that have been tested for the performance with this TV at the following website.
<http://panasonic.jp/support/global/cs/tv/>
- Some of the keys of gamepads correspond to the operation of the remote control.

Example :

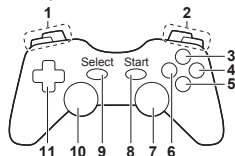

| | Remote Control | | Remote Control |
|---|-------------------|----|----------------|
| 1 | Volume Up / Down | 7 | VIERA TOOLS |
| 2 | Channel Up / Down | 8 | EXIT |
| 3 | GUIDE | 9 | INPUT (AV) |
| 4 | OK | 10 | MENU |
| 5 | BACK/RETURN | 11 | Cursor buttons |
| 6 | VIERA Connect | | |

Input signal that can be displayed

COMPONENT (Y, P_B, P_R), HDMI

| Signal name | COMPONENT | HDMI |
|-------------------------------|-----------|------|
| 525 (480) / 60i, 60p | ○ | ○ |
| 625 (576) / 50i, 50p | ○ | ○ |
| 750 (720) / 60p, 50p | ○ | ○ |
| 1,125 (1,080) / 60i, 50i | ○ | ○ |
| 1,125 (1,080) / 60p, 50p, 24p | | ○ |

○ Mark : Applicable input signal

PC (from HDMI terminal)

| Signal name | Horizontal frequency (kHz) | Vertical frequency (Hz) |
|---------------------|----------------------------|-------------------------|
| 640 × 480 @60 Hz | 31.47 | 60.00 |
| 750 (720) / 60p | 45.00 | 60.00 |
| 1,125 (1,080) / 60p | 67.50 | 60.00 |

Applicable input signal for PC is basically compatible to HDMI standard timing.

Note

- Signals other than above may not be displayed properly.
- The above signals are reformatted for optimal viewing on your display.
- PC signal is magnified or compressed for display, so that it may not be possible to show fine detail with sufficient clarity.

FAQs

Before requesting service or assistance, please follow these simple guides to resolve the problem. If the problem still persists, please contact your local Panasonic dealer or Panasonic Customer Care Centre for assistance. For details ➔ (p. 104)

Block noise, frozen or disappearing image occurs in digital mode / White spots or shadow image (ghosting) occurs in Analogue mode / Some channels cannot be tuned

- Check the position, direction and connection of the aerial.
- Check [Signal Condition] (p. 48). If [Signal Quality] is displayed in red, the digital signal is weak.
- Check your postcode area is able to receive the Freeview channels at www.freeview.co.uk
- Digital signals may be relatively low to prevent interference with analogue signals for the period of Digital Switchover. Check the schedule of Digital Switchover at www.digitaluk.co.uk
- Weather conditions will affect signal reception (heavy rain, snow, etc.), in particular in poor reception areas. Even during good weather, high pressure can cause poor reception of some channels.
- Due to the digital reception technologies involved, quality of the digital signals may be relatively low in some cases, despite good reception of analogue channels.
- Turn the TV off with the Mains power On / Off switch, and then on again.
- If problem persists, consult your local dealer.

Neither image nor sound is produced

- Is the TV in AV mode?
- Check the correct AV input mode is selected.
- Check the mains lead is plugged into the socket outlet.
- Has the TV been turned On?
- Check the Picture Menu (p.36, 37) and volume.
- Check all required cables and connections are firmly in place.

Auto aspect

- Auto aspect is designed to provide you with the best ratio to fill the screen. ➔ (p. 87)
- Press the ASPECT button if you would like to change the aspect ratio manually ➔ (p. 21)

Black and white picture

- When connecting with SCART, ensure the output setting of the external equipment is not S-Video.

Input mode, i.e. EC/AV1 remains on the screen

- Press the **i** button to clear this message.
Press again to redisplay.

Q-Link function does not work

- Confirm SCART cable and connection.
Also set [AV1 out] in the Setup Menu ➔ (p. 39)

[VIERA Link] function does not work and an error message appears

- Confirm the connection. ➔ (p. 76, 77)
- Turn the connected equipment on and then switch the TV on. ➔ (p. 79)

Recording does not start immediately

- Check the settings of the recorder. For details, read the manual of the recorder.

Contrast is reduced

- Contrast is lowered in the following conditions without any user operation for a few minutes:
 - no signal in DVB or AV mode
 - selection of a locked channel
 - selection of an invalid channel
 - selection of a radio channel
 - displayed menu
 - digital teletext (no video contents)
 - thumbnail or still picture in Media Player

| | Problem | Actions |
|-----------------|---|---|
| Screen | Chaotic image, noisy | <ul style="list-style-type: none"> Set [P-NR] in the Picture Menu (to remove noise). ➔ (p. 36) Check nearby electrical products (fluorescent lamp, DECT phones, mobile phones, microwave, etc.). |
| | No image can be displayed | <ul style="list-style-type: none"> Is [Contrast], [Brightness] or [Colour] in the Picture Menu set to the minimum? ➔ (p. 36) Please also refer to “Neither image nor sound is produced” ➔ (p. 94) |
| | Blurry or distorted image (no sound or low volume) | <ul style="list-style-type: none"> Reset channels. ➔ (p. 46) Please also refer to “Neither image nor sound is produced” ➔ (p. 94) |
| | Unusual image is displayed | <ul style="list-style-type: none"> Turn the TV Off with Mains power On / Off switch, then turn it On again. If the problem persists, initialise all settings ➔ [Shipping Condition] (p. 55) |
| Sound | No sound is produced | <ul style="list-style-type: none"> Is Sound Mute active? ➔ (p. 9) Is the volume set to the minimum? Is Speaker Selection (VIERA Link) set to [TV]? Please also refer to “Neither image nor sound is produced” ➔ (p. 94) |
| | Sound level is low or sound is distorted | <ul style="list-style-type: none"> Sound signal reception may be deteriorated. Set [NICAM] (p. 38) in the Sound Menu to [Off]. (Analogue only) Please also refer to “Neither image nor sound is produced” ➔ (p. 94) |
| | Unusual sound from the TV | <ul style="list-style-type: none"> When power is on, whirring sound of cooling fan or drive noise may be heard from inside the TV (not a sign of faulty operation). |
| 3D | Cannot see 3D images | <ul style="list-style-type: none"> Has the 3D Eyewear been switched On? Ensure that [3D Mode Selection] is set to [3D]. ➔ (p. 32) Some 3D image signals may not be automatically recognised as 3D images. Set [3D Mode Selection (Manual)] to match the picture format. ➔ (p. 32) Check that there are no obstacles between the infrared sensors on the TV and the 3D Eyewear. If the 3D Eyewear stops receiving the infrared signal for about 5 minutes, the 3D Eyewear will be turned off automatically. Check the available area to use the 3D Eyewear. ➔ (p. 31) Depending on the person, the 3D images may be difficult to see, or cannot be seen, especially in users that have a different level of eyesight between the left and right eyes. Take the necessary steps (wearing glasses etc.) to correct your eyesight before use. |
| | 3D Eyewear is turned off automatically | <ul style="list-style-type: none"> Check that there are no obstacles between the infrared sensors on the TV and the 3D Eyewear or that the 3D Eyewear is placed inside the coverage area (p. 31). If the 3D Eyewear stops receiving the infrared signal for about 5 minutes, the 3D Eyewear will be turned off automatically. |
| | There is something wrong with the 3D images | <ul style="list-style-type: none"> Check the setting of [Picture Sequence] or [Edge Smoother]. ➔ (p. 33) |
| | The indicator lamp does not light when pressing the power button on the 3D Eyewear | <ul style="list-style-type: none"> The battery may be running low or flat. Replace it. |
| Digital Channel | No programmes shown on TV Guide | <ul style="list-style-type: none"> Reset channels. ➔ (p. 46) Check the digital transmission by contacting Digital UK on 08456 50 50 50 or at www.digitaluk.co.uk Check the analogue broadcast (if still available in your area). Consult an aerial engineer to check the alignment of your aerial. |
| | Cannot find a channel you have previously watched | <ul style="list-style-type: none"> The channel may broadcast for part of the day. Check the channel in the TV Guide. ➔ (p. 22) Channel position numbers may be changed by broadcasters. Reset channels. ➔ (p. 46) |
| HDMI | Sound is unusual | <ul style="list-style-type: none"> Set the sound setting of the connected equipment to “2ch L.PCM”. Check the [HDMI1 / 2 / 3 / 4 Input] setting in the Sound Menu. ➔ (p. 38) If digital sound connection has a problem, select analogue sound connection. ➔ (p. 91) |
| | Pictures from external equipment are unusual when the equipment is connected via HDMI | <ul style="list-style-type: none"> Check the HDMI cable is connected properly. ➔ (p. 84) Turn the TV and equipment Off, then turn them On again. Check an input signal from the equipment. ➔ (p. 93) Check the output resolution of the equipment. Use equipment compliant with EIA/CEA-861/861D. |

| Problem | | Actions |
|---------|---|---|
| Network | Cannot connect to the network | <ul style="list-style-type: none"> • Check the LAN cable is connected properly. ➔ (p. 69) • Check the connections and settings. ➔ (p. 69 - 74) • Check the network equipment and network environment. • The router may not be set to issue IP address automatically. If the network administrator prefers to allocate an IP address, set an IP address manually. ➔ (p. 71) • The router may be using MAC address filtering (security setting). Confirm the MAC Address of this TV (p. 74) and set the router to be able to use it. • If the problem persists, consult your Internet Service Provider or telecommunications company. |
| | Cannot operate VIERA Connect | <ul style="list-style-type: none"> • Check the connections and settings. ➔ (p. 69 - 74) • The server or connected line might be busy now. |
| Other | The TV does not switch On | <ul style="list-style-type: none"> • Press and hold the standby On / Off switch on the remote control for about 1 second if Power LED is red. • Check the mains lead is plugged into the socket. • The fuse in the mains plug may have blown. Replace it with one of an identical rating ➔ (p. 4) |
| | The TV goes into Standby mode | <ul style="list-style-type: none"> • Auto power standby function is activated. ➔ (p. 10) • The TV enters Standby mode about 30 minutes after analogue broadcast ends. |
| | The remote control does not work or is intermittent | <ul style="list-style-type: none"> • Are the batteries installed correctly? ➔ (p. 7) • Has the TV been switched On? • The batteries may be running low. Replace them. • Point the remote control directly at the front of the TV (within about 7 m and a 30 degree angle of the front of the TV). • Situate the TV so that sunshine or other sources of bright light do not shine on the TV's remote control signal receiver. |
| | Parts of the TV become hot | <ul style="list-style-type: none"> • Temperature rises of parts of the front, top and rear panels will not pose any problems in terms of performance or quality of the TV. |
| | Overcurrent error message appears | <ul style="list-style-type: none"> • The connected USB device might cause this error. Remove the device and turn the TV Off with Mains power On / Off switch, then turn it On again. • Check if foreign objects are inside the USB port. |
| | An error message appears | <ul style="list-style-type: none"> • Follow the message's instructions. • If the problem persists, contact your local Panasonic dealer or the authorized Service Centre. |

On screen messages

| Message | Meaning / Action |
|--|--|
| All tuning data will be erased | • [Shipping Condition] will erase all tuning data ➔ (p. 55) |
| Are you sure ? | • Confirm correct operation. |
| Are you sure you want to delete this timer ? Press OK to delete timer. Press RETURN to return. | • Confirm correct operation. |
| Bad signal | <ul style="list-style-type: none"> • The signal is weak. Check the aerial is plugged in properly. It may be necessary to have an aerial installer check the signal and aerial alignment. • Reset channels. ➔ (p. 46) |
| Child Lock is active! Press OK to enter PIN. | • The selected channel is locked in Child Lock (p. 53). You must enter the PIN number before the channel will be displayed. |

| Message | Meaning / Action |
|---|---|
| Feature not available. | <ul style="list-style-type: none"> It is not possible to record from COMPONENT or HDMI. Connect the recorder to the TV using a fully wired SCART cable for recording from the TV tuner. Confirm Q-Link or VIERA Link settings ➔ (p. 76 - 79) |
| Feature not available. Press OK to view how it works. | <ul style="list-style-type: none"> The selected feature on VIERA TOOLS is not available. Press the OK button to view the demonstration to explain how to use it. |
| Found new software version ***. Press OK to start update (may take over 40 mins) or press EXIT to ignore and you can update when TV is in standby | <ul style="list-style-type: none"> There is a new software available. |
| Invalid operation - Please check settings and connections. | <ul style="list-style-type: none"> Check the Q-Link or VIERA Link connection and setting ➔ (p. 76 - 79) |
| Invalid system time. Please exit ! | <ul style="list-style-type: none"> Cannot get the time information and cannot edit Timer Programming screen. Check the connection of the RF cable. |
| Invalid system time, Timer Programming will not work. Please press TV button on remote control and check time display on Banner | <ul style="list-style-type: none"> Cannot get the time information. If there is no time displayed on the Information banner, check the connection of the RF cable. |
| Max. number of timers already set ! | <ul style="list-style-type: none"> The maximum number of timer programming events is 15. |
| New channels found! Press OK to update channel list. Press EXIT to ignore. | <ul style="list-style-type: none"> There may be new channels available. This message will appear each time a change is made by the broadcasters. This message can be deactivated by setting [New Channel Message] to Off in [DVB Tuning Menu]. Selecting OK will perform [Update Channel List]. |
| No channel found. Please check aerial or local signal availability. Press OK to start Auto Setup. | <ul style="list-style-type: none"> Follow the on screen instructions. Please also refer to p. 94. If channels are still not found, consult your local Panasonic dealer. |
| No module inserted | <ul style="list-style-type: none"> Check the CI module is inserted completely (p. 57). |
| No recording - Already recording | <ul style="list-style-type: none"> The equipment may already be recording. |
| No recording - Check media | <ul style="list-style-type: none"> The tape or disc may be "write protected", full, missing or damaged. |
| No recording - Playing | <ul style="list-style-type: none"> The equipment may be playing the tape or disc. |
| No recording - Unknown reason | <ul style="list-style-type: none"> The recording may not be performed. Check the equipment. |
| No service | <ul style="list-style-type: none"> The broadcaster has stopped the service. Check the channel in the TV Guide. (p. 22) |
| No signal | <ul style="list-style-type: none"> The TV cannot detect the signal. Check the connection of the RF cable. |
| Overcurrent error on USB device occurred. Please remove the USB device, and switch off the TV by mains power switch. | <ul style="list-style-type: none"> The connected USB device might cause overcurrent error. Follow the on screen instructions. Check if foreign objects are inside the USB port. |
| PIN incorrect! | <ul style="list-style-type: none"> The PIN number you entered is wrong. |
| Please check settings and connections on HDMI devices. | <ul style="list-style-type: none"> Communication error in VIERA Link function (p. 79). |
| Please wait. | <ul style="list-style-type: none"> A function is in progress. |
| Recording this channel now | <ul style="list-style-type: none"> The recorder is recording the programme from its own tuner. You can turn the TV off and leave the equipment recording in the normal way. |

| Message | Meaning / Action |
|---|--|
| Reset to Factory Shipping Condition Completed. Please switch off TV. | <ul style="list-style-type: none"> • [Auto Setup] will automatically start when Mains power On / Off switch is next turned On. (p. 13) |
| Sending Preset Data | <ul style="list-style-type: none"> • Q-Link or VIERA Link channel download is in progress. |
| Software successfully updated. Press EXIT to continue. | <ul style="list-style-type: none"> • The software updating is finished. |
| Software update failed. Please try again later. Press EXIT to continue. | <ul style="list-style-type: none"> • Perform [System Update Search Now] in System Update (p. 58). If this is still unsuccessful, there may not be any new software available. |
| The device is not directly connected to the TV. The device may not work correctly. | <ul style="list-style-type: none"> • Please do not connect the device via a USB HUB. |
| This timer will not follow the TV Guide information. Press OK to continue, RETURN to restore original timer. | <p>UK only</p> <ul style="list-style-type: none"> • If you edit the start time or end time of Guide link programming by more than 10 minutes, it will no longer be performed as Guide link programming. The programming will be performed according to the time setting. |
| Timer already expired ! | <ul style="list-style-type: none"> • The starting time in Timer Programming has already passed. Set the timer correctly (p. 52). |
| Timer incorrect ! | <ul style="list-style-type: none"> • Set the start and end times in Timer Programming correctly (p. 52). |
| Timer overlap. Press OK to keep, RETURN to edit. | <ul style="list-style-type: none"> • Timer programming events are overlapped. Press the OK button to keep the overlapped setting. [Ext Rec.] are given priority over [Reminder]. When two or more [Ext Rec.] overlap, the first timer programming event starts and finishes as programmed. The next timer programming event can then start. |
| Tuner Locked Press EXIT to unlock and stop recording | <ul style="list-style-type: none"> • If you want to unlock the tuner, cancel Direct TV Recording (p. 78, 80) or the recording of Timer Programming (p. 52). |
| Unable to download, please check equipment | <ul style="list-style-type: none"> • The tape or disc is active. Stop the equipment and try again. |
| 3D image not available. | <ul style="list-style-type: none"> • You may use a function not available for 3D effect. Exit the function to view the 3D images. |

■ Media Player

| Message | Meaning / Action |
|---------------------------------------|---|
| Cannot read file | <ul style="list-style-type: none"> • The file is broken or unreadable. Check applicable data format. (p. 88, 89) |
| No Device Inserted | <ul style="list-style-type: none"> • Confirm the SD Card or USB device is inserted correctly. |
| No valid file to play | <ul style="list-style-type: none"> • The card has no data. |
| This operation is not possible | <ul style="list-style-type: none"> • The selected operation is not available. |

■ Network

| Message | Meaning / Action |
|--|---|
| The software update is not completed. | <ul style="list-style-type: none"> • Network download failed. Check the connections and settings. (p. 69 - 74) |
| Ethernet cable not connected | <ul style="list-style-type: none"> • Check the connection of the LAN cable. If you use a hub, also check the light on the hub is lit. • The LAN cable might be defective. |

Maintenance

First, remove the mains plug from the socket outlet.

Display panel, Cabinet, Pedestal

Regular care:

Gently wipe the surface of the display panel, cabinet, or pedestal by using a soft cloth to clean the dirt or fingerprints.

For stubborn dirt:

Dampen a soft cloth with clean water or diluted neutral detergent (1 part detergent to 100 parts water). Then wring the cloth and wipe the surface. Finally, wipe away all the moisture.

Caution

- Do not use a hard cloth or rub the surface too hard. This may cause scratches on the surface.
- Take care not to subject the TV's surfaces to water or detergent more than requires. A liquid inside the TV could lead to product failure.
- Take care not to subject the surfaces to insect repellent, solvent, thinner or other volatile substances. This may degrade surface quality or cause peeling of the paint.
- The surface of the display panel is specially treated and may be easily damaged. Take care not to tap or scratch the surface with your fingernail or other hard objects.
- Do not allow the cabinet or pedestal to make contact with a rubber or PVC substance for a long time. This may degrade surface quality.

Mains plug

Wipe the mains plug with a dry cloth at regular intervals. Moisture and dust may lead to fire or electrical shock.

Glossary

- DVI**
Digital Visual Interface - A high quality video interface standard to connect to the display
- ETHERNET**
One of the popular standards of LAN
- EPG**
Electronic Programme Guide - A digital guide showing scheduled programmes
- Frame Sequential**
The 3D format that the separated images for the left and right eyes are recorded with the high definition quality and alternately played back at the high speed
- HDMI**
High-Definition Multimedia Interface - A digital audio and video interface for transmitting uncompressed digital signals on a single cable
- LAN**
Local Area Network
- MAC Address**
Media Access control Address
- NICAM**
Near Instantaneous Companded Audio Multiplex - A format for digital sound over television
- NTSC**
National Television System Committee - One of the television signals used in USA, etc.
- RF**
Radio Frequency - Signal received from terrestrial aerial
- RGB / Video**
Choose between these three video formats depending on personal preference and equipment requirement (RGB - Red, Green and Blue)
- SCART**
21 pin connection used for video, audio and switching signals (Also known as Euro SCART and Peritel)
- Shop viewing environment**
Shop viewing environment is the demonstration mode to explain main features of this TV in an easy understandable way. This mode will work if you select [Shop] in "Auto Setup" (p. 16).
- Side by Side**
One of the types of 3D format available for broadcasts
- SPDIF**
A standard audio transfer file format
- Top and Bottom**
One of the types of 3D format available for broadcasts
- USB**
Universal Serial Bus - An interface specification to connect devices
- VCR**
Video Cassette Recorder
- 24p**
Progressive images recorded at a rate of 24 frames per second (film source)

Index

- A** Accessories 6
- Analogue Tuning Menu 46, 49, 50
- Aspect 21, 87
- Audio Description 20, 38
- Auto Gain Control 38
- Auto Setup 13, 46
- Auto Standby 39
- AV1 out 39, 78
- B** Banner Display Timeout 40
- C** Category list 22
- C.A.T.S. 36
- Channel List 49, 50
- Channel Sorting by Region 47
- Child Lock 53
- Common Interface 57
- COMPONENT 86, 93
- Connection 11, 12, 76, 77, 84 - 86
- D** Direct TV Recording 78, 80
- DivX 89
- DTS 67
- DVB Tuning Menu 46 - 49
- DVD Recorder 11, 12, 29, 76, 84
- DVI 91
- DVI Input Setting 37
- E** EPG 22
- External equipment 11, 12, 28, 84 - 86
- External input 28, 29
- F** FAQs 94 - 96
- Favourites Edit 48
- Frame Sequential 30, 32
- Free input menu 35, 91
- G** Glossary 99
- Guide link programming 24
- H** HDMI 90, 91, 103
- HDMI Content Detection 39
- Hold 20, 26
- Home Cinema 83
- I** Information banner 19
- Input Labels 54
- Input signal 93
- Intelligent Frame Creation 37
- L** Last view 19
- M** Mains Lead 11
- Mains power On / Off switch 10, 13
- Maintenance 99
- Manual Tuning 47, 50
- Media Player 59 - 68
- Menu Functions 35 - 45
- Monaural Audio 20
- Multi Audio 20
- Music mode 67
- N** Network connections 12, 69
- Network Setup 70 - 74
- New Channel Message 48
- NICAM 38
- NTSC 36, 87
- O** Off Timer 20, 39
- Optional accessories 6
- Owner ID 15, 56
- P** PAL 87
- Pixel Orbiter 37
- Pedestal 7
- Photo mode 60
- PIN number 15, 53, 56
- Playing Time Display 41
- P-NR 36
- Power and Timer LED 10, 23, 51
- Q** Q-Link 76, 78
- Q-Link Download 13, 39
- Quick Start Guide 6 - 16
- R** Radio Mode 41
- Remote control 6, 7, 9
- Reset to Defaults 37, 38
- Reversal Film Effect 36
- RGB 103
- S** Sales and Support Information 104
- SCART 90, 103
- SD Card 59, 90
- Search list 23
- Shipping Condition 55
- Side by Side 30, 32
- Signal Condition 48
- Slideshow 61
- Software Update 58, 74
- Specifications 102, 103
- Split Programme 24
- Subtitles 21, 27
- System Update 58
- T** Teletext 25 - 27
- Timer Programming 23, 51
- Top and Bottom 30, 32
- True Cinema 36
- TV Guide 22 - 24
- TV Guide Settings 39
- U** Update Channel List 49
- USB Charge in Standby 41
- USB Flash Memory 59, 90
- USB connection 92
- V** V-Audio Surround 38
- VCR 11, 12, 29, 84
- Video mode 65
- VIERA Connect 17, 75
- VIERA Link 76, 77, 79 - 83
- VIERA TOOLS 34
- Viewing Mode 36
- Vivid Colour 36
- Volume Correction 20, 38
- W** Wireless LAN Adaptor 6, 12, 14, 15, 69
- WSS 87
- Z** Zoom 21, 63
- 24p Smooth Film 37
- 3D Eyewear 6, 30, 31
- 3D Refresh Rate 37
- 3D Settings 33

Licence

Even if no special notation has been made of company or product trademarks, these trademarks have been fully respected.

- DVB and the DVB logos are trademarks of the DVB Project.
- SDXC Logo is a trademark of SD-3C, LLC.
- HDMI, the HDMI Logo, and High-Definition Multimedia Interface are trademarks or registered trademarks of HDMI Licensing LLC in the United States and other countries.
- HDAVI Control™ is a trademark of Panasonic Corporation.
- "AVCHD" and the "AVCHD" logo are trademarks of Panasonic Corporation and Sony Corporation.
- x.v.Colour™ is a trademark.
- Manufactured under license from Dolby Laboratories.
Dolby and the double-D symbol are trademarks of Dolby Laboratories.
- Manufactured under license under U.S. Patent #'s: 5,451,942; 5,956,674; 5,974,380; 5,978,762; 6,487,535 & other U.S. and worldwide patents issued & pending. DTS and the Symbol are registered trademarks, & DTS 2.0+ Digital Out and the DTS logos are trademarks of DTS, Inc. Product includes software. © DTS, Inc. All Rights Reserved.
- VIERA Connect is a trademark of Panasonic Corporation.
- Windows is a registered trademark of Microsoft Corporation in the United States and other countries.
- DivX®, DivX Certified®, DivX Plus™ HD and associated logos are trademarks of DivX, Inc. and are used under license.
- The Skype name, associated trade marks and logos and the "S" symbol are trade marks of Skype Limited.
- "RealD 3D" is a trademark of RealD. This product is covered by U.S. Patent 5,193,000 until 28 August, 2011.
- QuickTime and the QuickTime logo are trademarks or registered trademarks of Apple Inc., used under license therefrom.
- GUIDE Plus+ is (1) a registered trademark or trademark of, (2) manufactured under license from and (3) subject of various international patents and patent applications owned by, or licensed to, Rovi Corporation and/or its related affiliates.



Specifications

| | | TX-P42ST31B | TX-P50ST31B |
|--------------------------------------|------------------------------------|--|---|
| Power Source | | AC 220-240 V, 50 / 60 Hz | |
| Rated Power Consumption | | 295 W | 355 W |
| Standby Power Consumption | | 0.30 W 16.00 W (With monitor out recording) | |
| Dimensions (W × H × D) | | 1,020 mm × 675 mm × 320 mm (With Pedestal) 1,020 mm × 640 mm × 69 mm (TV only) | 1,204 mm × 779 mm × 335 mm (With Pedestal) 1,204 mm × 744 mm × 69 mm (TV only) |
| Mass | | 23.0 kg Net (With Pedestal) 19.5 kg Net (TV only) | 30.0 kg Net (With Pedestal) 26.0 kg Net (TV only) |
| Display panel | Aspect Ratio | 16:9 | |
| | Visible screen size | 106 cm (diagonal) 921 mm (W) × 518 mm (H) | 127 cm (diagonal) 1,105 mm (W) × 622 mm (H) |
| | Number of pixels | 2,073,600 (1,920 (W) × 1,080 (H)) [5,760 × 1,080 dots] | |
| Sound | Speaker | (140 mm × 35 mm) × 2, 6 Ω | |
| | Audio Output | 20 W (10 W + 10 W) | |
| | Headphones | M3 (3.5 mm) stereo mini Jack × 1 | |
| Operating Conditions | | Temperature: 0 °C - 35 °C Humidity: 20 % - 80 % RH (non-condensing) | |
| Aerial input | | <input type="checkbox"/> UK UHF | <input type="checkbox"/> Ireland VHF / UHF |
| Receiving Systems / Band name | <input type="checkbox"/> UK | DVB-T / T2 | Digital terrestrial services. |
| | | PAL I | UHF E21-68 |
| | | PAL 525/60 | Playback of NTSC tape from some PAL Video recorders (VCR) or NTSC disc playback from DVD player and recorder. |
| | | M.NTSC | Playback from M.NTSC Video recorders (VCR). |
| | | NTSC (AV input only) | Playback from NTSC Video recorders (VCR). |

| | | | | | |
|--------------------------------------|--|---|---|---|--|
| Receiving Systems / Band name | Ireland | DVB-T | Digital terrestrial services. | | |
| | | PAL I | VHF A -J | UHF E21 - E69 CATV S1 - S20 CATV S21 - S41 (Hyperband) | |
| | | PAL 525/60 | Playback of NTSC tape from some PAL Video recorders (VCR) or NTSC disc playback from DVD player and recorder. | | |
| | | M.NTSC | Playback from M.NTSC Video recorders (VCR). | | |
| | | NTSC (AV input only) | Playback from NTSC Video recorders (VCR). | | |
| Connection Terminals | AV1 (SCART) | 21 Pin terminal (Audio/Video in, Audio/Video out, RGB in, Q-Link) | | | |
| | AV2 input | VIDEO | RCA PIN Type × 1 | 1.0 V[p-p] (75 Ω) | |
| | | AUDIO L - R | RCA PIN Type × 2 | 0.5 V[rms] | |
| | COMPONENT input | Y | 1.0 V[p-p] (including synchronization) | | |
| | | P_B, P_R | ±0.35 V[p-p] | | |
| | HDMI 1 / 2 / 3 / 4 input | TYPE A Connectors HDMI1 / 3 / 4 : 3D, Content Type, Deep Colour, x.v.Colour™ HDMI2 : 3D, Content Type, Audio Return Channel, Deep Colour, x.v.Colour™ • This TV supports "HDAVI Control 5" function. | | | |
| | Card slot | SD Card slot × 1 Common Interface slot × 1 | | | |
| | ETHERNET | RJ45, IEEE802.3 10BASE-T / 100BASE-TX | | | |
| | USB 1 / 2 | USB2.0 DC 5 V, Max. 500 mA | | | |
| | AUDIO IN | RCA PIN Type × 2 | 0.5 V[rms] | | |
| AUDIO OUT | RCA PIN Type × 2 | 0.5 V[rms] (high impedance) | | | |
| DIGITAL AUDIO OUT | PCM / Dolby Digital / DTS, Fiber optic | | | | |

Note

- Design and Specifications are subject to change without notice. Mass and Dimensions shown are approximate.
- This equipment complies with the EMC standards listed below.
EN55013, EN61000-3-2, EN61000-3-3, EN55020, EN55022, EN55024

Information for Users on Collection and Disposal of Old Equipment and used Batteries



These symbols on the products, packaging, and/or accompanying documents mean that used electrical and electronic products and batteries should not be mixed with general household waste. For proper treatment, recovery and recycling of old products and used batteries, please take them to applicable collection points, in accordance with your national legislation and the Directives 2002/96/EC and 2006/66/EC.

By disposing of these products and batteries correctly, you will help to save valuable resources and prevent any potential negative effects on human health and the environment which could otherwise arise from inappropriate waste handling.



For more information about collection and recycling of old products and batteries, please contact your local municipality, your waste disposal service or the point of sale where you purchased the items. Penalties may be applicable for incorrect disposal of this waste, in accordance with national legislation.

For business users in the European Union

If you wish to discard electrical and electronic equipment, please contact your dealer or supplier for further information.

[Information on Disposal in other Countries outside the European Union]

These symbols are only valid in the European Union. If you wish to discard these items, please contact your local authorities or dealer and ask for the correct method of disposal.



Note for the battery symbol (bottom two symbol examples) :

This symbol might be used in combination with a chemical symbol. In this case it complies with the requirement set by the Directive for the chemical involved.

Cd

Sales and Support Information

Customer Care Centre

- For customers within the UK: **0844 844 3852**
- For customers within Ireland: **01 289 8333**
- Visit our website for product information: www.panasonic.co.uk
- E-mail: customer.care@panasonic.co.uk

Direct Sales at Panasonic UK

- For customers: **0844 844 3856**
- Order accessory and consumable items for your product with ease and confidence by phoning our Customer Care Centre Monday – Thursday 9:00am – 5:30pm, Friday 9:30am – 5:30pm (Excluding public holidays).
- Or go on line through our Internet Accessory ordering application at www.pas-europe.com.
- Most major credit and debit cards accepted.
- All enquiries transactions and distribution facilities are provided directly by Panasonic UK Ltd.
- It couldn't be simpler!
- Also available through our Internet is direct shopping for a wide range of finished products, take a browse on our website for further details.



Declaration of Conformity (DoC)

Authorized Representative :
Panasonic Testing Centre
Panasonic Marketing Europe GmbH
Winsbergring 15, 22525 Hamburg, Germany

Customer's Record

The model number and serial number of this product may be found on its rear panel. You should note this serial number in the space provided below and retain this book, plus your purchase receipt, as a permanent record of your purchase to aid in identification in the event of theft or loss, and for Warranty Service purposes.

Model Number

Serial Number

Panasonic UK Ltd.

Willoughby Road, Bracknell, Berkshire, RG12 8FP

Web Site : <http://panasonic.net>

© Panasonic Corporation 2011

M0311-0

Printed in Czech Republic