

CD/DVD Player

Operating Instructions _____ **EN**

C1 _____ **C1**

C2 _____ **C2**



DVP-M35

WARNING

To prevent fire or shock hazard, do not expose the unit to rain or moisture. To avoid electrical shock, do not open the cabinet. Refer servicing to qualified personnel only.

Mains cord must only be changed at qualified service shop.

CAUTION

The use of optical instruments with this product will increase eye hazard. As the laser beam used in this CD/DVD Player is harmful to eyes, do not attempt disassemble the cabinet.

Refer servicing to qualified personnel only.



This label is located on the Laser protective housing inside the enclosure.

Precautions

Safety

- The power requirements of this unit is indicated on the back of the unit. Check that the unit's operating voltage is identical with your local power supply.

Power requirements →



- If anything falls into the cabinet, unplug the unit and have it checked by qualified personnel before operating it any further.
- The unit is not disconnected from the mains as long as it is connected to the mains outlet, even if the unit itself has been turned off.
- Unplug the unit from the wall outlet if you do not intend to use it for an extended period of time. To disconnect the cord, pull it out by the plug, never by the cord.

Installing

- Allow adequate air circulation to prevent internal heat buildup.
- Do not place the unit on surfaces (rugs, blankets, etc.) or near materials (curtains, draperies) that may block the ventilation slots.
- Do not install the unit near heat sources such as radiators or air ducts, or in a place subject to direct sunlight, excessive dust, mechanical vibration or shock.
- Do not install the unit in an inclined position. It is designed to be operated in a horizontal position only.
- Keep the unit and discs away from equipment with strong magnets, such as microwave ovens or large loudspeakers.
- Do not place heavy objects on the unit.
- If the unit is brought directly from a cold to a warm location, moisture may condense inside the CD/DVD player and cause damage to the lenses. When you first install the unit, or when you move it from a cold to a warm location, wait for about 30 minutes before operating the unit.

For the model supplied with the AC plug adaptor

If the AC plug of your unit does not fit into the wall outlet, attach the supplied AC plug adaptor.

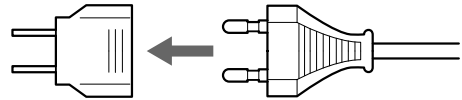

Welcome!

Thank you for purchasing the Sony CD/DVD Player. Before operating the unit, please read this manual thoroughly and retain it for future reference.

TABLE OF CONTENTS

This Player Can Play the Following Discs	4
--	---

Getting Started	
Unpacking	6
Hooking Up the System	6
Necessary Setup Before Using the Player	9
Selecting the Language for On-screen Display	9

Basic Operations	
Playing a DVD	10
Playing a CD/VIDEO CD	14

Playing Discs in Various Modes	
Using the On-Screen Display	18
Using the Front Panel Display	20
Playing Repeatedly (Repeat Play)	22
Playing in Random Order (Shuffle Play)	24
Creating Your Own Program (Program Play)	24
Resuming Playback from the Point Where You Stopped a Disc (Resume Play)	26
Reducing the Picture Noise (DNR: Digital Video Noise Reduction)	26
Changing the Sounds	27
Displaying the Subtitles	28
Changing the Angles	29
Limiting Playback by Children (Parental Control)	29
Controlling the TV or the AV Amplifier (Receiver) with the Supplied Remote	32

Settings and Adjustments	
Using the Setup display	34
Setting the Language for Display and Sound (LANGUAGE SETUP)	35
Settings for Display (INITIAL SETUP 1)	36
Settings for Sound (INITIAL SETUP 2)	37

Additional Information	
Precautions	38
Notes on Discs	38
Troubleshooting	39
Self-diagnosis function	41
Specifications	42
Glossary	42
Index to Parts and Controls	44
Setup Display Item List	47
Language Code List	48





Index	49
--------------------	----

About This Manual



The instructions in this manual are for model DVP-M35.

Conventions

- Instructions in this manual describe the controls on the player.
You can also use the controls on the remote if they have the same or similar names as those on the player.
- The icons on the right are used in this manual:

Icon	Meaning
	Indicates that you can use only the remote to do the task.
	Indicates tips and hints for making the task easier.
	Indicates the functions for DVD VIDEOS.
	Indicates the functions for VIDEO CDs.
	Indicates the functions for Audio CDs.

This Player Can Play the Following Discs

	DVD VIDEOS		VIDEO CDs		Audio CDs	
Disc logo						
Contents	Audio + Video		Audio + Video		Audio	
Disc size	12 cm	8 cm	12 cm	8 cm	12 cm	8 cm (CD single)
Play time	About 4 h (for single-sided DVD)/ about 8 h (for double-sided DVD)	About 80 min. (for single-sided DVD)/ about 160 min. (for double-sided DVD)	74 min.	20 min.	74 min.	20 min.

“DVD VIDEO” logo is a trademark.

This player switches the color system, PAL or NTSC, according to the connected TV. (For details, see page 9.)

Region code of DVDs you can play on this unit

Your DVD player has a region code printed on the back of the unit and will only play DVDs that are labeled with identical region codes.

DVDs labeled  will also play on this unit.

If you try to play any other DVD, the message “Playing this disc prohibited by area limits.” will appear on the TV screen.

Depending on the DVD, no region code indication may be labeled even though playing the DVD is prohibited by the area limits.



Note on playback operations of DVDs and VIDEO CDs

Some playback operations of DVDs and VIDEO CDs may be intentionally fixed by software producers. Since this player plays DVDs and VIDEO CDs according to the disc contents the software producers designed, some playback features may not be available. Also refer to the instructions supplied with the DVDs or VIDEO CDs.

Terms for discs

- **Title**
The longest sections of a picture or a music piece on a DVD; a movie, etc, for a picture piece on a video software; or an album, etc, for a music piece on an audio software. Each title is assigned a title number enabling you to locate the title you want.
- **Chapter**
Sections of a picture or a music piece that are smaller than titles. A title is composed of several chapters. Each chapter is assigned a chapter number enabling you to locate the chapter you want. Depending on the disc, no chapters may be recorded.
- **Track**
Sections of a picture or a music piece on a VIDEO CD or a CD. Each track is assigned a track number enabling you to locate the track you want.

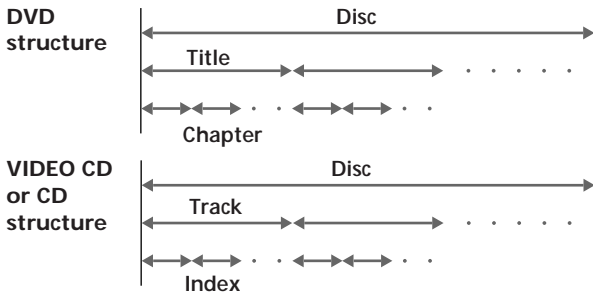

- **Index (CD) / Video Index (VIDEO CD)**
A number that divides a track some sections to easily locate the point you want on a VIDEO CD or a CD. Depending on the disc, no indexes may be recorded.
- **Scene**
On a VIDEO CD with PBC functions, the menu screens, moving pictures and still pictures are divided into sections called “scenes.” Each scene is assigned a scene number enabling you to locate the scene you want.

Note on PBC (Playback Control) (VIDEO CDs)

This player conforms to Ver. 1.1 and Ver. 2.0 of VIDEO CD standards. You can enjoy two kinds of playback according to the disc type.

Disc type	You can
VIDEO CDs without PBC functions (Ver. 1.1 discs)	Enjoy video playback (moving pictures) as well as music.
VIDEO CDs with PBC functions (Ver. 2.0 discs)	Play interactive software using menu screens displayed on the TV screen (PBC Playback), in addition to the video playback functions of Ver 1.1 discs. Moreover, you can play high-resolution still pictures, if they are included on the disc.

Discs that the player cannot play

The player cannot play discs other than the ones listed in the table on page 4. CD-ROMs including PHOTO CDs, data sections in CD-EXTRAS and DVD-ROMs, etc. can not be played.

This product incorporates copyright protection technology that is protected by method claims of certain U.S. patents and other intellectual property rights owned by Macrovision Corporation and other rights owners. Use of this copyright protection technology must be authorized by Macrovision Corporation, and is intended for home and other limited viewing uses only unless otherwise authorized by Macrovision Corporation. Reverse engineering or disassembly is prohibited.

Unpacking

Check that you have the following items:

- Audio/Video connecting cord (1)
- S video cable (1)
- Remote commander (remote) RMT-D102E (1)
- Size AA (R6) batteries (2)

Inserting batteries into the remote

You can control the player using the supplied remote. Insert two R6 (size AA) batteries by matching the + and - on the batteries. When using the remote, point it at the remote sensor  on the player.

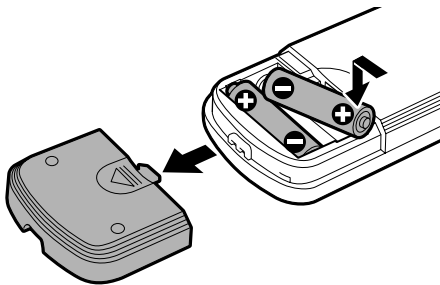

 You can control Sony TVs and AV amplifiers using the supplied remote
See page 32.

Notes

- Do not leave the remote in an extremely hot or humid place.
- Do not drop any foreign object into the remote casing, particularly when replacing the batteries.
- Do not expose the remote sensor to direct sunlight or lighting apparatuses. Doing so may cause a malfunction.
- If you will not use the remote for an extended period of time, remove the batteries to avoid possible damage from battery leakage and corrosion.

Hooking Up the System

Overview

This section describes how to hook up the CD/DVD player to a TV (with audio/video input jacks) and/or an amplifier. You cannot connect this player to a TV without a video input connector. Be sure to turn off the power of each component before making the connections.

■ To listen to the sound through TV speakers

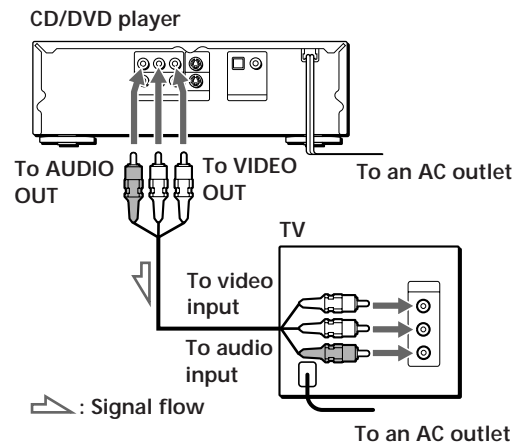

■ To listen to the sound through speakers connected to an amplifier

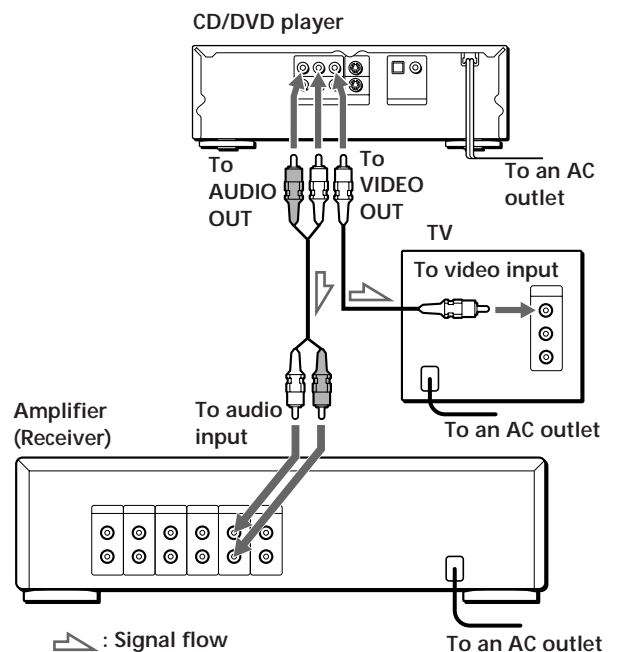

What cords will I need?

Audio/Video connecting cord (supplied) (1)

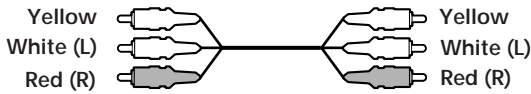

Hookups

When connecting the cords, be sure to match the color-coded cord to the appropriate jacks on the components: Yellow (video) to Yellow, Red (right) to Red and White (left) to White. Be sure to make connections firmly to avoid hum and noise.

- To listen to the sound through TV speakers
Connect the TV using the audio/video connecting cord (supplied).

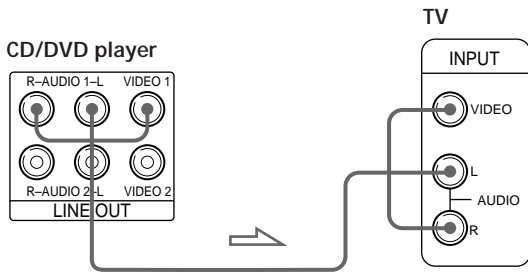

- To listen to the sound through speakers connected to an amplifier
Connect the TV using a video connecting cord (not supplied), and the amplifier using an audio connecting cable (not supplied).

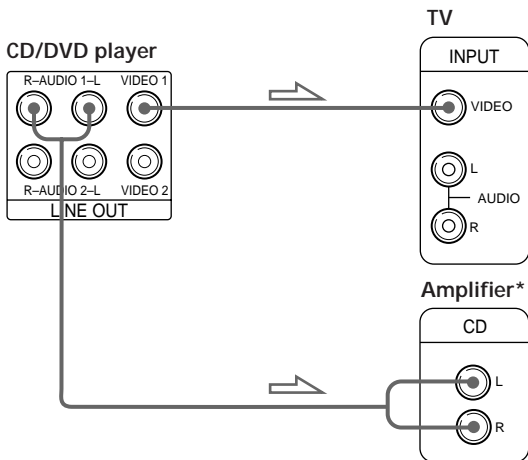

* Make the same connections when your amplifier conforms to "Pro Logic."

Notes

- Do not connect this player to a video deck. If you view the pictures on your TV after making the connections shown on the right, a picture noise may appear.
- Depending on the TV or amplifier, sound distortion may occur because the audio output level is high. In this case, set "AUDIO ATT" in "INITIAL SETUP 2" to "ON" in the setup display. For details, see page 37.

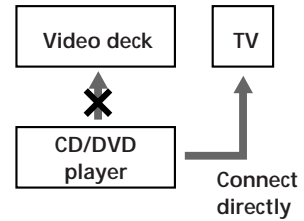

- 💡 If your TV has an S video input connector
Connect the component via the S VIDEO OUT connector using the S video cable (supplied) instead of the video connecting cord. You will get a better picture.

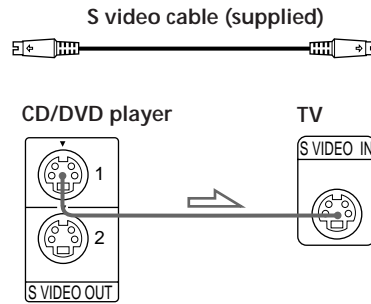

(Continued)

Getting Started

- 💡** If you have a digital component such as an amplifier with a digital connector, DAT or MD
Connect the component via the DIGITAL OUT OPTICAL or COAXIAL connector using an optical or coaxial digital connecting cord (not supplied).
When you play a DVD, set "DIGITAL OUT" in "INITIAL SETUP 2" to "PCM" in the setup display. (page 37)

■ When using an optical digital connecting cord

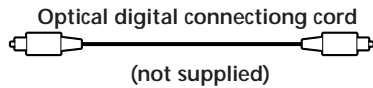

Take off the cap and plug in the optical digital connecting cord.

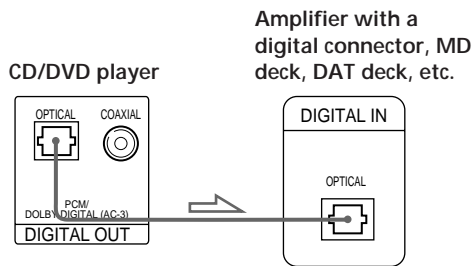

■ When using a coaxial digital connecting cord

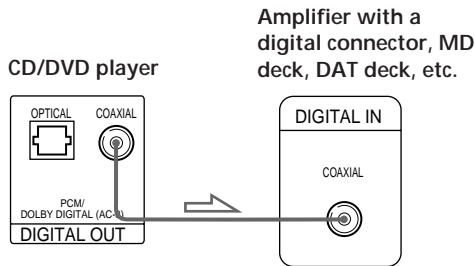
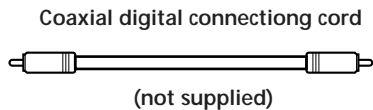

Notes

- Refer to the instructions supplied with the component to be connected.
- You cannot make digital audio recordings of discs recorded in Dolby* Digital (AC-3) format directly using an MD deck or DAT deck.

When you make the connections above, do not set "DIGITAL OUT" in "INITIAL SETUP 2" to "DOLBY DIGITAL/PCM." If you do, a loud noise will suddenly come out from the speakers, affecting your ears or causing the speakers to be damaged.

- 💡** If you have a digital component with a built-in Dolby Digital decoder
Connect the component via the DIGITAL OUT OPTICAL or COAXIAL connector using an optical or coaxial digital connecting cord (not supplied). When the component with a built-in Dolby Digital decoder is connected, the player plays DVDs with sound recorded in Dolby Digital (AC-3) format while producing the effect of being in a movie theater or a concert hall.
In the setup display, set "DIGITAL OUT" in "INITIAL SETUP 2" to "DOLBY DIGITAL/PCM." (page 37)

■ When using an optical digital connecting cord

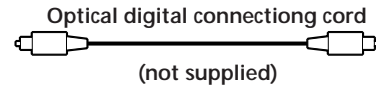

Take off the cap and plug in the optical digital connecting cord.

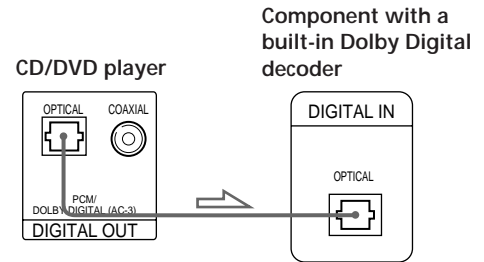

■ When using a coaxial digital connecting cord

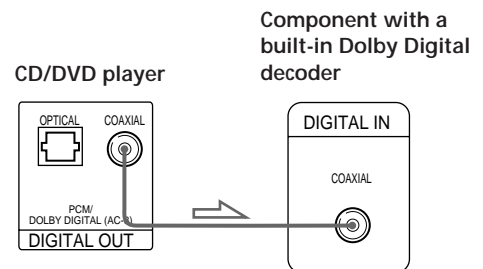
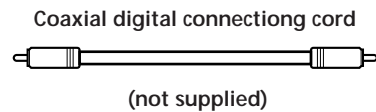

Note

Refer to the instructions supplied with the component to be connected.

* Manufactured under license from Dolby Laboratories. "Dolby", "Pro Logic" and the double-D symbol are trademarks of Dolby Laboratories. Confidential Unpublished Works. ©1992-1997 Dolby Laboratories, Inc. All rights reserved.

Necessary Setup Before Using the Player

Some setups are necessary for the player depending on the TV or other components to be connected.

For details on using the setup display, see page 34.

For details on each setup display item, see pages 35 to 37.

■ If the color system of the TV is PAL or DUAL

Since the color system of the unit is set to PAL, you can use the unit as it is.

■ If the color system of the TV is NTSC

To set the TV to NTSC, turn on the unit while pressing the **00** button of the unit. To reset to PAL, turn off the unit and then turn on as described above.

■ To connect the player to a wide-screen TV

In the setup display, set "TV TYPE" in "INITIAL SETUP 1" to "16:9." This is default setting.

■ To connect the player to a normal TV

In the setup display, set "TV TYPE" in "INITIAL SETUP 1" to "4:3 LETTER BOX" or "4:3 PAN SCAN." For details, see page 36.

■ To listen to the sound through speakers connected to an amplifier with a digital connector or to output the sound to a digital component such as a DAT or MD deck

When you play a DVD, set "DIGITAL OUT" in "INITIAL SETUP 2" to "PCM" in the setup display. This is default setting.

■ To connect the player to a digital component with a built-in Dolby Digital decoder

In the setup display, set "DIGITAL OUT" in "INITIAL SETUP 2" to "DOLBY DIGITAL/PCM."

Use the setup display to change the various settings for the picture and sound.

For details, see page 34.

Selecting the Language for On-screen Display

You can select the language for the setup display or the messages displayed on the screen. Default setting is "ENGLISH."

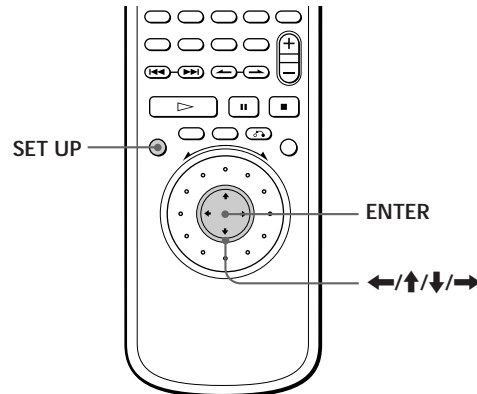

- 1 Press SET UP and select "⏏" using **←/→**, and then press ENTER.

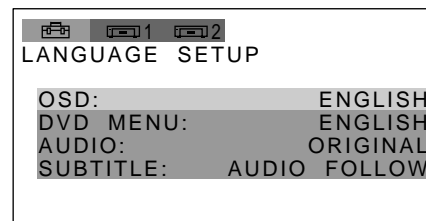

- 2 Select "OSD" using **↑/↓**, then press **→** or ENTER.

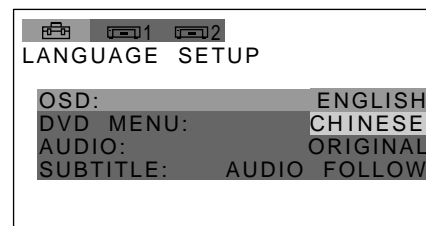

- 3 Select the language you want using **↑/↓**, then press ENTER.

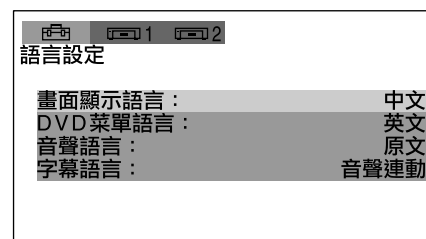

To cancel using the setup display on the way
Press SET UP.

Note

The languages you can select are the ones displayed in step 2.
For details, see page 35.

Playing a DVD

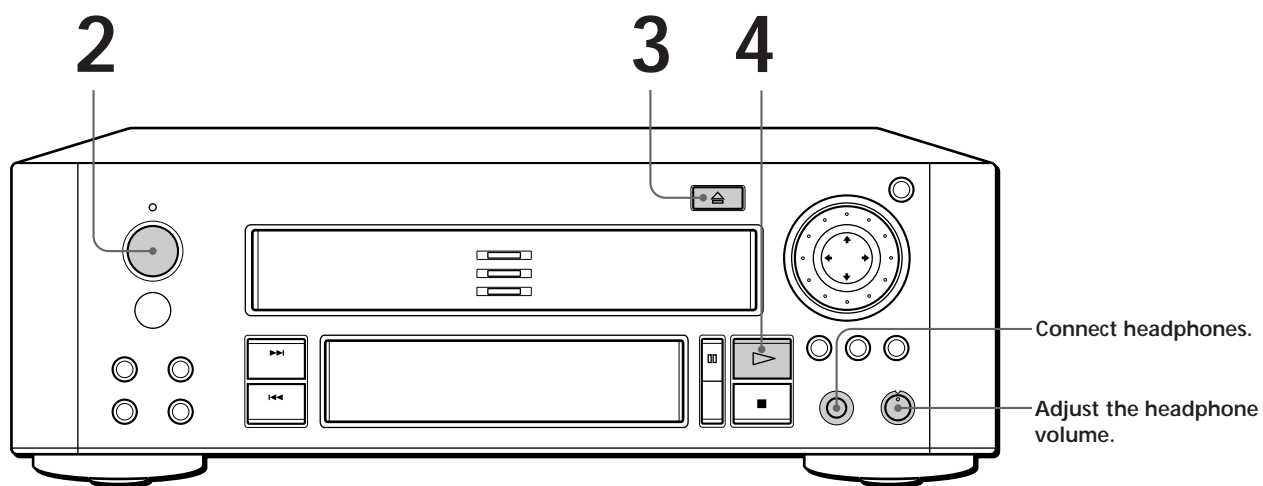

- The operating procedure of CDs or VIDEO CDs is different from that of DVDs. For details, see pages 14 to 17.

You can turn on the player using the remote. Press POWER when the indicator above the POWER button on the front panel is lit in red.

After following Step 4 A DVD menu or title menu may appear on the TV screen (see page 13).

Notes

- If you use an FM/AM tuner by the player, turn off the player.
- If you leave the player or the remote in pause mode for 15 minutes, the screen saver image appears automatically. To disappear the screen saver, press . (If you want to set the screen saver function to off, see page 36.)
- If you don't operate the player or the remote for more than 30 minutes when a disc is not being played, the power is automatically turned off (Auto Power Off function.)

- 1** **Make settings on your TV.**
Turn on the TV and select the video input so that you can view the pictures from this player.

When using an amplifier

Turn on the amplifier and select the appropriate position so that you can listen to the sound from this player.

- 2** Press POWER to turn on the player.
The indicator (red) above the POWER button changes to green and the front panel display lights up.

- 3** Press and place the disc on the disc tray.



With the playback side facing down

- 4** Press .
- The disc tray closes, and the player starts playback (Continuous Play). Adjust the volume on the TV or the amplifier.

Depending on the DVD, some operations may be different or restricted. Refer to the instructions supplied with your disc.

💡 When "RESUME" appears on the front panel display
 You can resume playback from the point where you stopped the DVD (page 26).
 To play from the beginning of the disc, see page 26.

Note
 You may not be able to do Resume Play depending on the DVD.

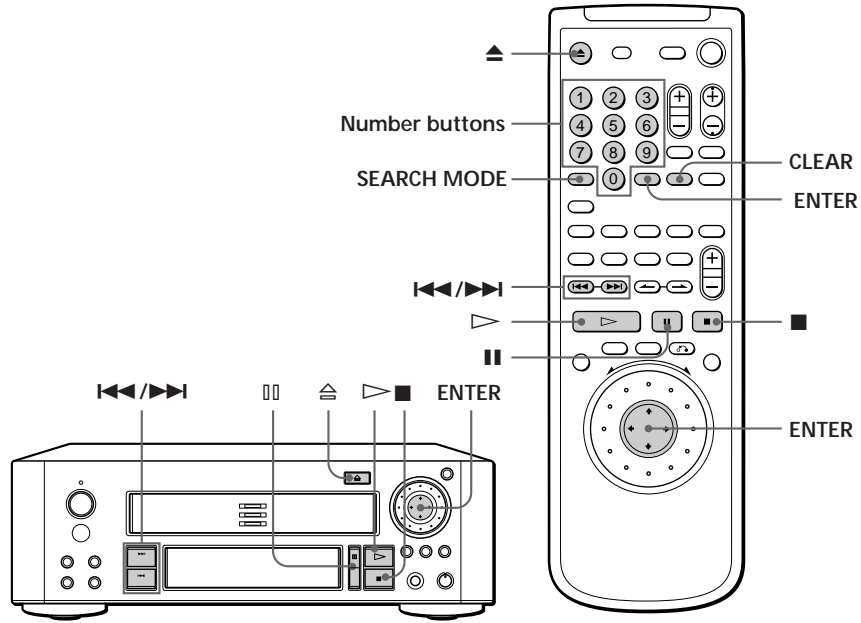

💡 What are chapter and title?
 See page 5.

Notes
 Depending on the DVD, you may not be able to do some of the operations described on the right.

💡 Each time you press SEARCH MODE
 "CHAPTER SEARCH,"
 "TITLE SEARCH" and
 "TIME SEARCH" appear on the TV screen.

To	Press
Stop	■
Pause	
Resume play after pause	or ▶
Go to the next chapter in Continuous Play mode	▶▶
Go back to the preceding chapter in Continuous Play mode	◀◀
Select the chapter	1 SEARCH MODE repeatedly until "CHAPTER SEARCH" appears on the TV screen. 2 Number buttons to select the chapter number, then ENTER or ▶.
Select the title	1 SEARCH MODE repeatedly until "TITLE SEARCH" appears on the TV screen. 2 Number buttons to select the title number, then ENTER or ▶.
Locate a point using the time code	1 SEARCH MODE repeatedly until "TIME SEARCH" appears on the TV screen. 2 Number buttons to enter a time code, then ENTER or ▶.
Stop play and remove the disc	▲

If you have made a mistake when you press the number button
 Press CLEAR, then the correct number button.

To play at various speeds/frame-by-frame

Using the click shuttle and the JOG button/indicator, you can playback a DVD with various speed or frame-by-frame. Each time you press JOG, it changes between shuttle mode and jog mode.

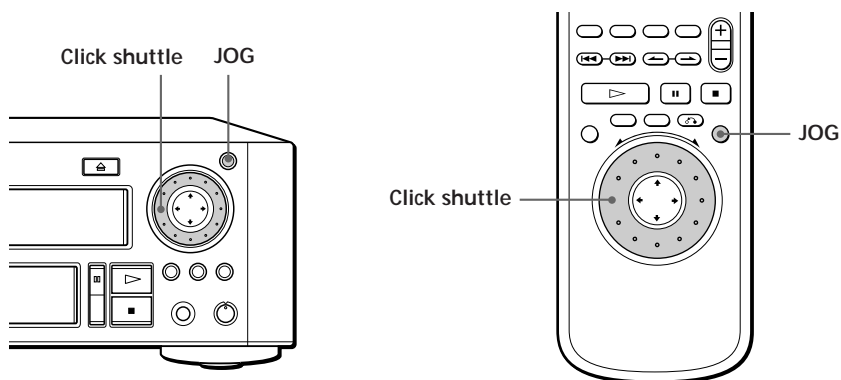

Notes

- Depending on the DVD, you may not be able to do some of the operations described on the right.
- When you play back a DVD at twice the normal speed in either direction, the sounds of the picture will come out from the LINE OUT (AUDIO 1, 2) connectors. The sounds are lower than the ones at normal speed. In this case, no sounds come out from the DIGITAL OUT OPTICAL and COAXIAL connectors.

■ To change the playback speed (Shuttle mode)

Turn the click shuttle. The playback speed changes depending on the turning direction and angle as follows:

- FF2▶▶ (about 30 times the normal speed)
- ↕
- FF1▶▶ (about 10 times the normal speed)
- ↕
- ×2▶ (about twice the normal speed)
- ↕
- PLAY▶ (Normal speed)
- ↕
- SLOW1▶▶ (playback direction)
- ↕
- SLOW2▶▶ (playback direction
– slower than “SLOW1▶▶”)
- ↕
- PAUSE ||
- ↕
- SLOW2◀◀ (opposite direction
– slower than “SLOW1◀◀”)
- ↕
- SLOW1◀◀ (opposite direction)
- ↕
- ×2◀ (about twice the normal speed : opposite direction)
- ↕
- FR1◀◀ (about 10 times the normal speed)
- ↕
- FR2◀◀ (about 30 times the normal speed)

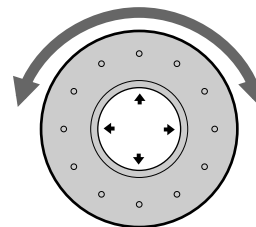

If you turn the click shuttle quickly, the playback speed goes to FF2/FR2 at once.

■ To play the DVDs frame-by-frame changing the playback speed (Jog mode)

- 1 Press JOG.
The JOG button lights up during jog mode. When you press JOG, the playback is paused.
- 2 Turn the click shuttle.

Depending on the turning speed, the playback goes to frame-by-frame toward the turning direction of the click shuttle. If you turn the click shuttle with constant speed for a while, the playback speed goes to slow or normal.

To return to Continuous Play

Press ▷.

Notes

- The JOG indicator shows the mode of the click shuttle close to the indicator only. When the indicator on the remote does not light up, it keeps shuttle mode on the remote even if the indicator on the player lights up.
- If you don't operate the click shuttle for about 20 seconds after pressing JOG, it returns to shuttle mode on the remote. On the player, it keeps jog mode.

Notes

- Depending on the DVD, you may not be able to select the title.
- Depending on the DVD, a “title menu” may simply be called a “menu” or “title” in the instructions supplied with the disc. “Press ENTER.” may also be expressed as “Press SELECT.”

Using the Title Menu

A DVD is divided into long sections of a picture or a music piece called “titles.” When you play the DVD which contains several titles, you can select the title you want using the title menu.

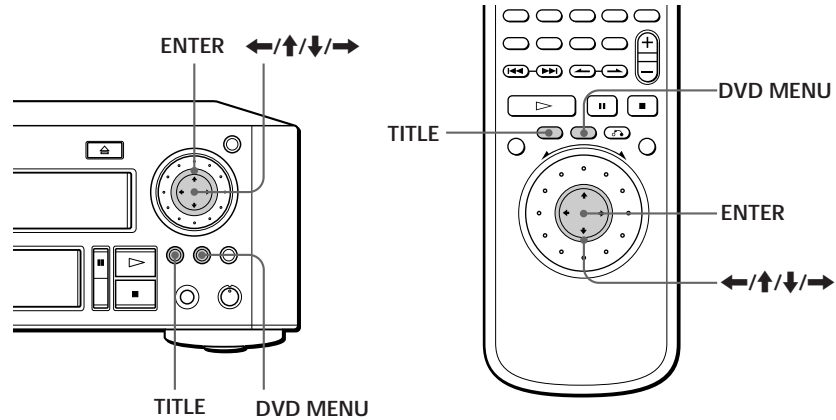

- 1 Press TITLE.
The title menu appears on the TV screen. The contents of the menu varies from disc to disc.
- 2 Press ←/↑/↓/→ to select the title you want to play.
Depending on the disc, you can use the number buttons to select the title.
- 3 Press ENTER.
The player starts playing the selected title.

Using the DVD menu

Some DVDs allow you to select the disc contents using the menu. When you play these DVDs, you can select the language for the subtitles, the language for the sound, etc., using the DVD menu.

- 1 Press DVD MENU.
The DVD menu appears on the TV screen. The contents of the menu vary from disc to disc.
- 2 Press ←/↑/↓/→ to select the item you want to change.
Depending on the disc, you can use the number buttons to select the item.
- 3 To change other items, repeat Step 2.
- 4 Press ENTER.

 If you want to select the language for the DVD menu Change the setting using “LANGUAGE SETUP” in the setup display (see page 35).

Note
Depending on the DVD, a “DVD menu” may simply be called a “menu” in the instructions supplied with the disc.

Playing a CD/VIDEO CD

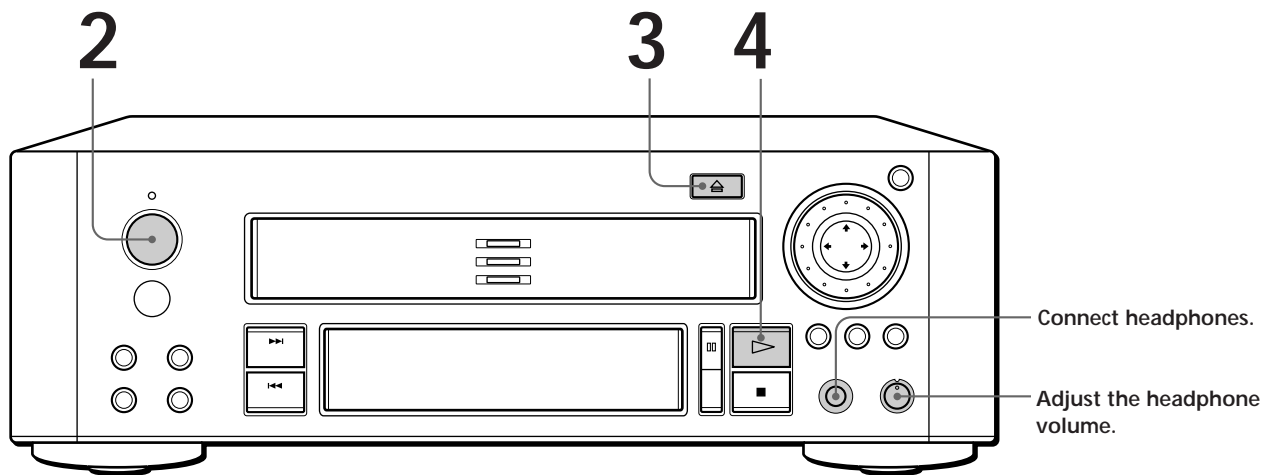

- The operating procedure of DVDs is different from that of CDs or VIDEO CDs. For details, see pages 10 to 13.

You can turn on the player using the remote
Press POWER when the indicator above the POWER button on the front panel is lit in red.

After following Step 4
The menu screen may appear on the TV screen depending on the VIDEO CD. You can play the disc interactively, following the instructions on the menu screen. (PBC Playback, see page 17.)

Notes

- If you use an FM/AM tuner by the player, turn off the player.
- If you leave the player or the remote in pause mode for 15 minutes, the screen saver image appears automatically. To disappear the screen saver, press ▷. (If you want to set the screen saver function to off, see page 36.)
- If you don't operate the player or the remote for more than 30 minutes when a disc is not being played, the power is automatically turned off (Auto Power Off function.)

1 **Make settings on your TV.**
Turn on the TV and select the video input so that you can view the pictures from this player.

When using an amplifier

Turn on the amplifier and select the appropriate position so that you can listen to the sound from this player.

2 Press POWER to turn on the player.
The indicator (red) above the POWER button changes to green and the front panel display lights up.

3 Press and place the disc on the disc tray.

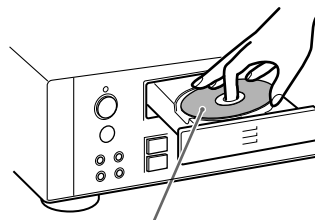



With the label side facing up

4 Press .
The disc tray closes and the player starts playback (Continuous Play). Adjust the volume on the TV or the amplifier.

Depending on the VIDEO CD, some operations may be different or restricted. Refer to the instructions supplied with your disc.

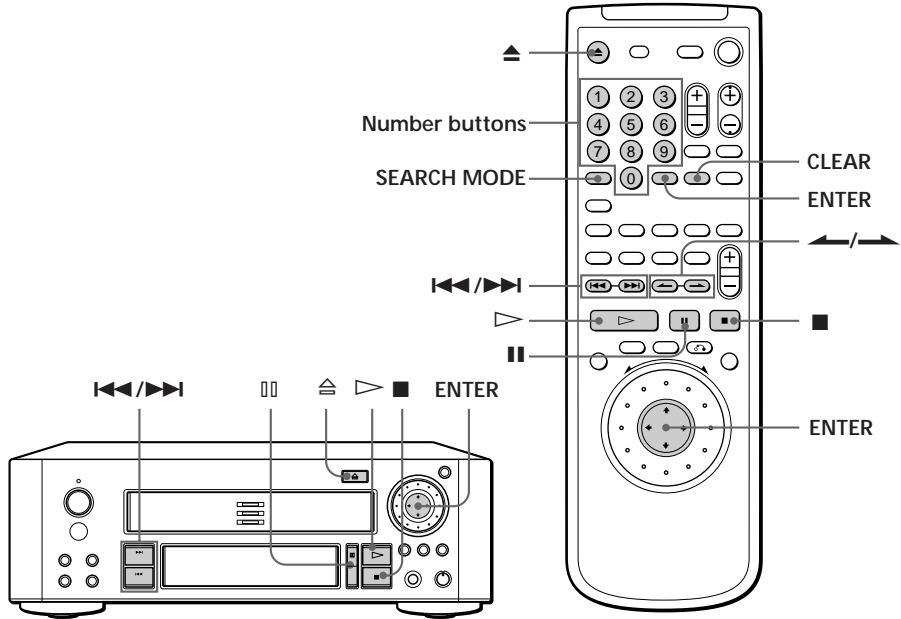
 When "RESUME" appears on the front panel display
You can resume playback from the point where you stopped the CD/VIDEO CD (page 26).
To play from the beginning of the disc, see page 26.



 What is a track?
See page 5.

 What is an index?
See page 5.

 What is a scene?
See page 5.

 If you want to change the search mode
Press SEARCH MODE. Each time you press in case of a VIDEO CD, "SCENE SEARCH," "TRACK SEARCH" and "V. INDEX SEARCH" appear on the TV screen. In case of a CD, only "TRACK SEARCH" appears.

Note
Some discs do not allow you to start playing from a particular scene. In this case, if you do Scene Search before you start playing, the player starts playing from scene 1. If you do Scene Search while playing a disc, the player starts playing from the current scene.

To	Press
Stop	■
Pause	⏸
Resume play after pause	⏸ or ▷
Go to the next track in Continuous Play mode	▶▶
Go back to the preceding track in Continuous Play mode	◀◀
Go to the next index	➡
Go back to the preceding index	➡
Select the track	1 SEARCH MODE repeatedly until "TRACK SEARCH" appears on the TV screen. 2 Number buttons to select the track number, then ENTER or ▷.
Select the scene before you start playing a VIDEO CD with PBC functions and during PBC playback (Scene Search)	1 SEARCH MODE repeatedly until "SCENE SEARCH" appears on the TV screen. 2 Number buttons to select the scene number, then ENTER or ▷. (To check the current scene number, press DISPLAY. The scene number appears at the left top of the TV screen.)
Stop play and remove the disc	▲

If you have made a mistake when you press the number button
Press CLEAR, then the correct number button.

To play at various speeds / frame-by-frame

Using the click shuttle and the JOG button/indicator, you can playback a CD/VIDEO CD with various speed or frame-by-frame. Each time you press JOG, it changes between shuttle mode and jog mode.

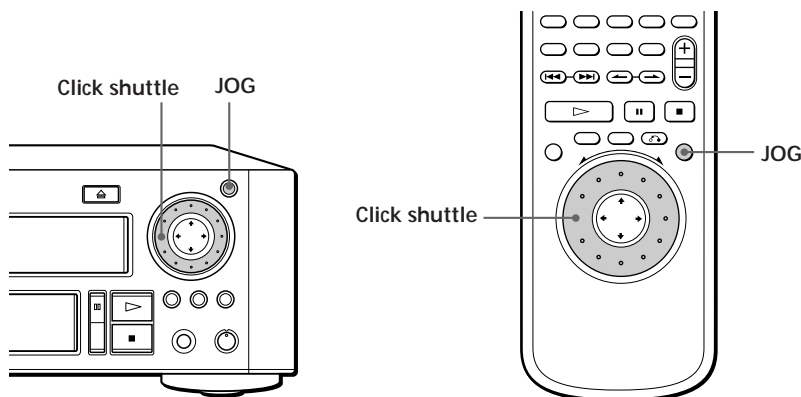

Notes

- Depending on the VIDEO CD, you may not do some of the operations described on the right.
- When you play a VIDEO CD, there is no sound except for the playback at normal speed.

■ To change the playback speed (Shuttle mode)

Turn the click shuttle. The playback speed changes depending on the turning direction and angle as follows:

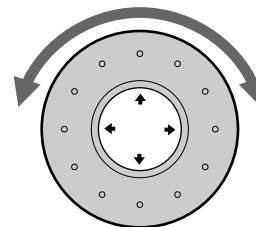
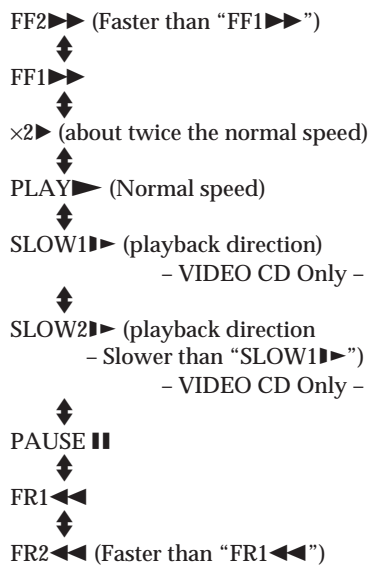

Notes

- The JOG indicator shows the mode of the click shuttle close to the indicator only. When the indicator on the remote does not light up, it keeps shuttle mode on the remote even if the indicator on the player lights up.
- If you don't operate the click shuttle for about 20 seconds after pressing JOG, it returns to shuttle mode on the remote. On the player, it keeps jog mode.

If you turn the click shuttle quickly, the playback speed goes to FF2/FR2 at once.

■ To play the VIDEO CDs frame-by-frame changing the playback speed (Jog mode – VIDEO CD Only)

- 1 Press JOG.
The JOG button lights up during jog mode. When you press JOG, the playback is paused.
- 2 Turn the click shuttle.





Depending on the turning speed, the playback goes to frame-by-frame toward the playback direction only. If you turn the click shuttle with constant speed for a while, the playback speed goes to slow or normal.

To return to Continuous Play

Press ▷.

 When playing VIDEO CDs with PBC functions PBC playback starts automatically.

 To cancel PBC playback of a VIDEO CD with PBC functions and play the disc in Continuous Play mode There are two ways.

- Before you start playing, select the track you want using  or , then press ENTER or .
- Before you start playing, select the track number using the number buttons on the remote, then press ENTER or .





“Play without PBC” appears on the TV screen and the player starts Continuous Play. You cannot play still pictures such as a menu screen.

To return to PBC playback, press  twice then press .

Playing VIDEO CDs with PBC Functions (PBC Playback – VIDEO CD Only)

When playing VIDEO CDs with PBC functions (Ver. 2.0 discs), you can enjoy simple interactive operations, operations with search functions, etc.

PBC Playback allows you to play VIDEO CDs interactively, following the menu screen on the TV screen.

On this player, you can use the number buttons, ENTER or , , ,  and  (RETURN) during PBC Playback.

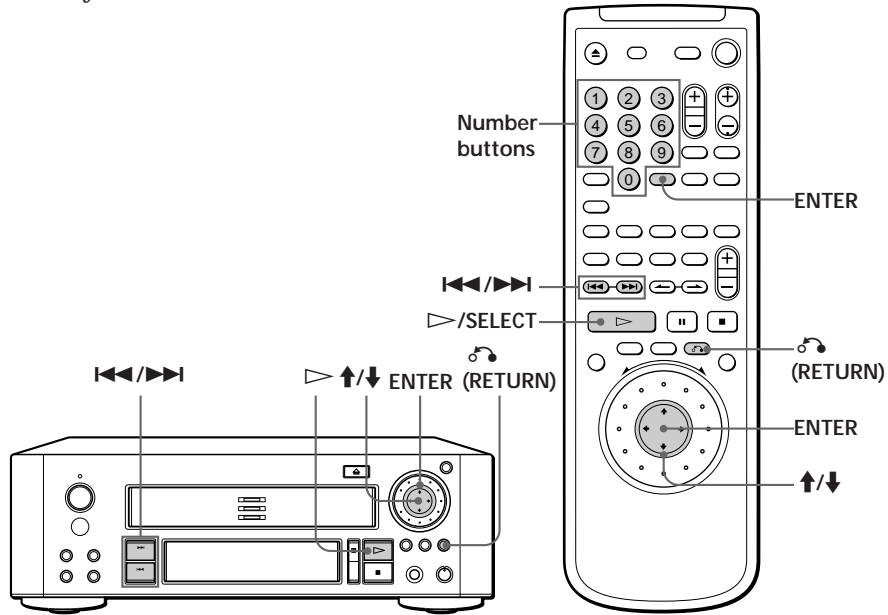

Note

Depending on the VIDEO CD, “Press ENTER” in Step 3 may be expressed as “Press SELECT” in the instructions supplied with the disc.

1 Start playing a VIDEO CD with PBC functions, following Steps 1 to 4 in “Playing a CD/VIDEO CD” on page 14.

2 Select the item number you want.
On the player
Press  to select the item number.

On the remote
Press the number button of the item you want.

3 Press ENTER or .

4 Follow the instructions on the menu screen for interactive operations.
Refer to the instructions supplied with the disc, as the operating procedure may differ according to the VIDEO CD.

Going back to the menu screen

Press , , or .

Using the On-Screen Display



You can check the operating status of the player and the information about the disc using the on-screen display on the TV screen.

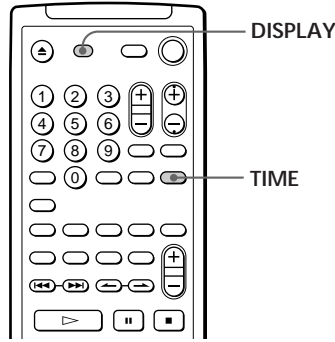

When playing back or stopping a DVD



Press DISPLAY.

Each time you press the DISPLAY button, the on-screen display changes as follows:

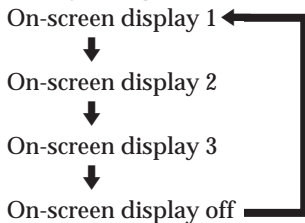

■ Display information of the on-screen display 1 mode

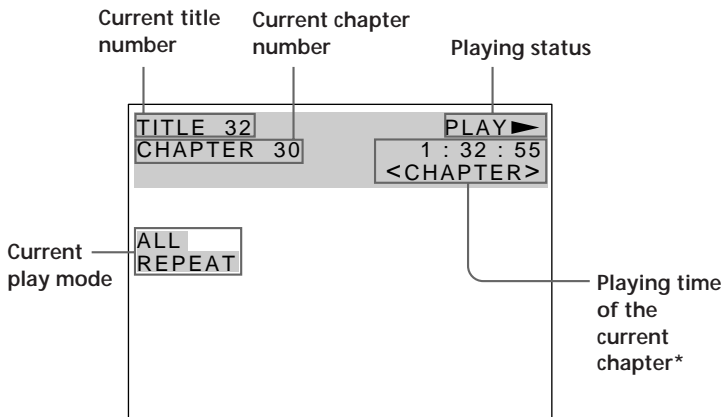

■ Display information of the on-screen display 2 mode

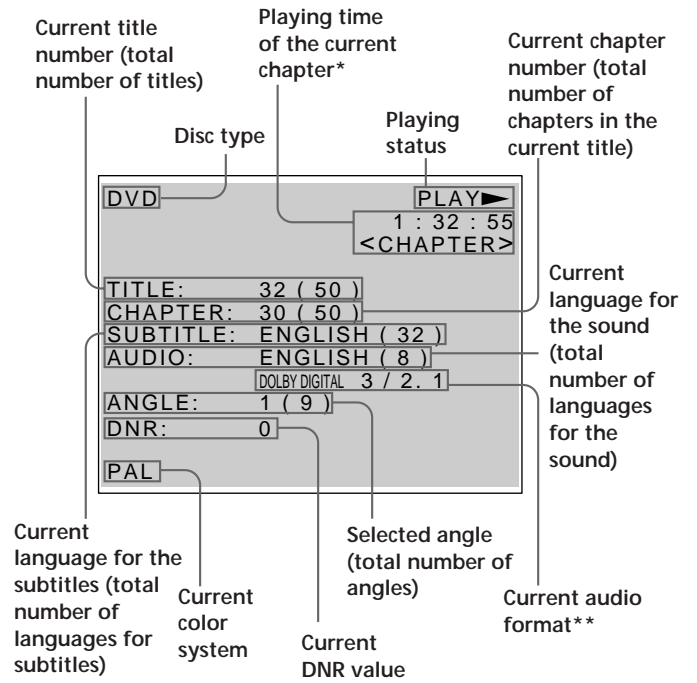

Note

Some information may not be displayed depending on a DVD.

* In display 1 or 2 mode, each time you press TIME the information changes as shown below.

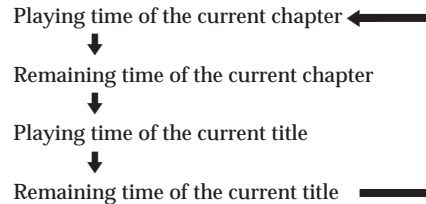

** "PCM", "MPEG" or "DOLBY DIGITAL" is displayed. In "DOLBY DIGITAL" case, the channels in the playing track are displayed by number as follows.

The case of Dolby Digital (AC-3) 5.1 ch:

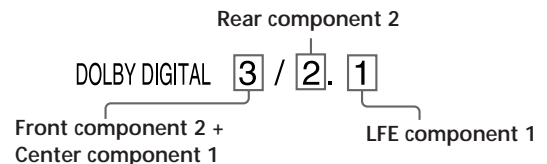

■ Display information of the on-screen display 3 mode

While playing a disc, the approximate bit rate of the playback picture is always displayed by Mbps (Mega bit per second).

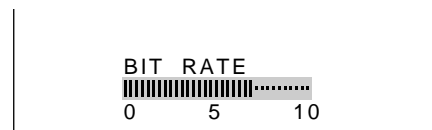

Bit rate of the playback picture

💡 What is bit rate?

Bit rate refers to the amount of video data per second in a disc. The higher the bit rate is, the larger the amount of data. However, this does not always mean that you can get higher quality pictures.

■ Display information of the on-screen display off mode

No information is displayed. (Messages, etc., will be displayed.)

When playing back or stopping a CD/VIDEO CD



Press DISPLAY.

Each time you press the button, the on-screen display changes as follows:

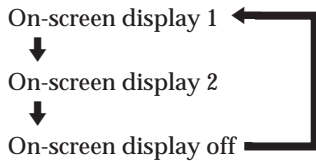

■ Display information of the on-screen display 1 mode

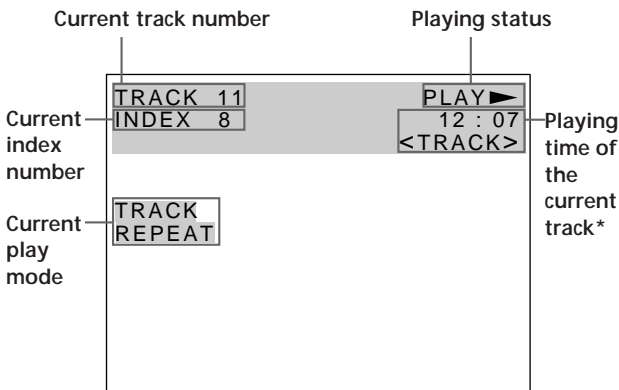

• During PBC playback (VIDEO CD Only)

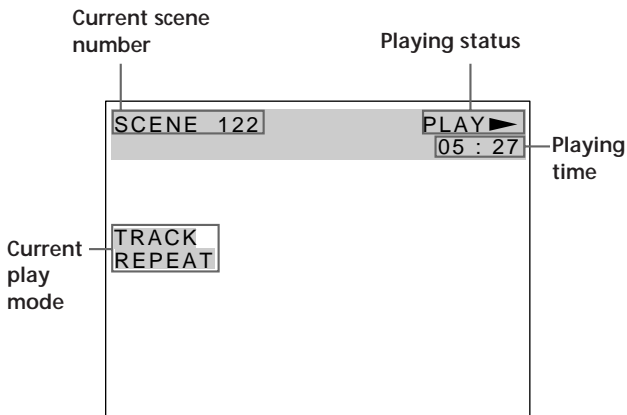

■ Display information of the on-screen display 2 mode

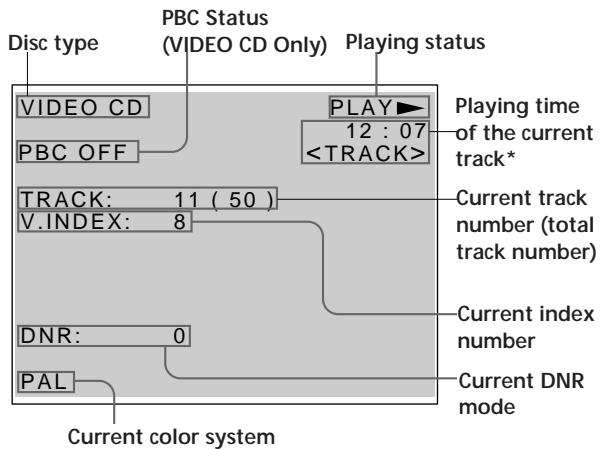

• During PBC playback (VIDEO CD Only)

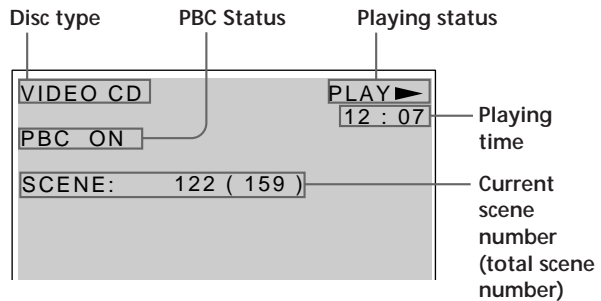

* In display 1 or 2 mode, each time you press TIME, the information changes as shown below.

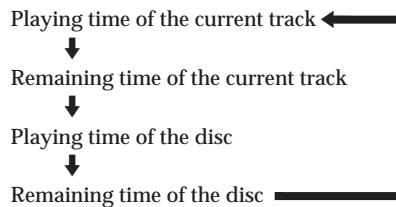

While you are doing Shuffle Play, Program Play, or PBC Playback, the playing time of the disc and the remaining time of the disc are not displayed.

■ Display information of the on-screen display off mode

No information is displayed. (Messages, etc., will be displayed.)

Using the Front Panel Display



You can check information about the disc, such as the total number of the titles or the tracks or remaining time, using the front panel display.

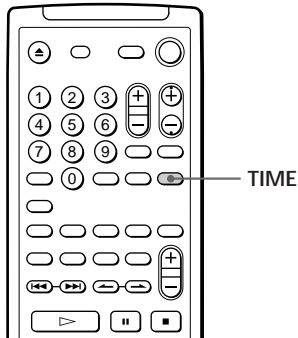

When playing back a DVD

- Display information while playing the disc
The DVD indicator on the disc tray lights up.

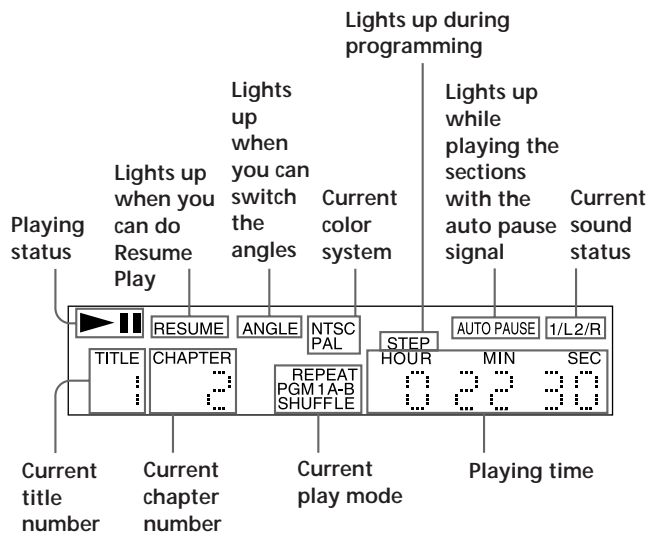
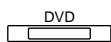

- Checking the remaining time

Press TIME.

Each time you press TIME while playing the disc, the display changes as shown in the chart to the right. The time information in the on-screen display (1 and 2) also changes each time you press TIME.

Playing time and number of the current chapter

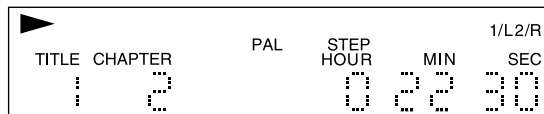

Remaining time of the current chapter

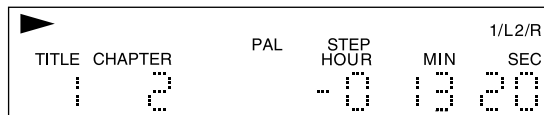

Playing time and number of the current title

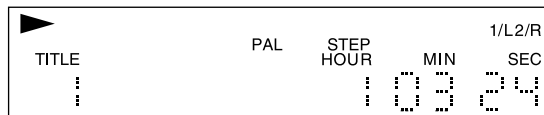

Remaining time of the current title

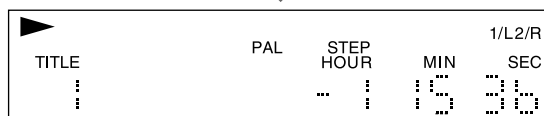

Press TIME

Notes

- Depending on the DVD, the chapter number or time may not appear.
- While you are doing Shuffle Play or Program Play, the playing time of the disc and the remaining time of the disc are not displayed.

When playing back a CD/VIDEO CD

- Display information while playing a disc

The CD indicator for the CD or the VIDEO CD indicator for the VIDEO CD lights up.

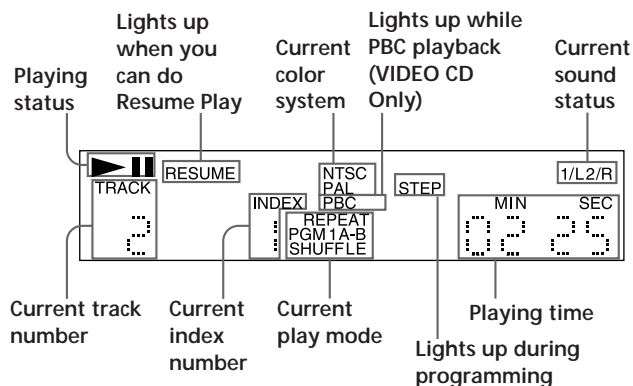
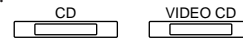

When playing VIDEO CDs with PBC functions

The current scene number is displayed instead of the current track number and the current index number. In this case, the front panel display does not change when you press TIME.

■ Checking the remaining time

Press TIME.

Each time you press TIME while playing a disc, the display changes as shown in the chart below. The time information in the on-screen display (1 and 2) also changes each time you press TIME.

Playing time and number of the current track

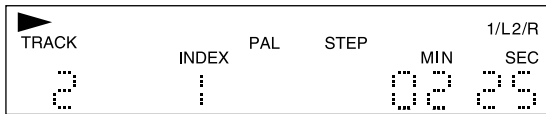

Remaining time of the current track

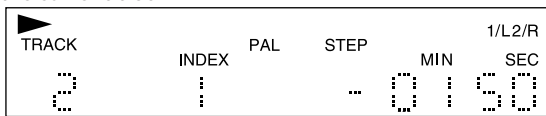

Playing time of the disc

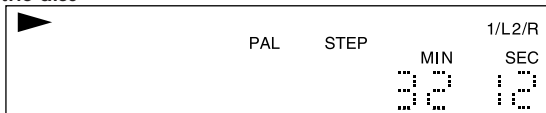

Remaining time of the disc

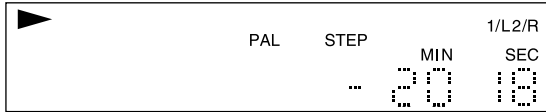

Press TIME

Note

While you are doing Shuffle Play, Program Play or PBC playback, the playing time of the disc and the remaining time of the disc are not displayed.

Playing Repeatedly (Repeat Play)

You can play all the titles/tracks on a disc, a single title/chapter/track or a specific portion repeatedly.

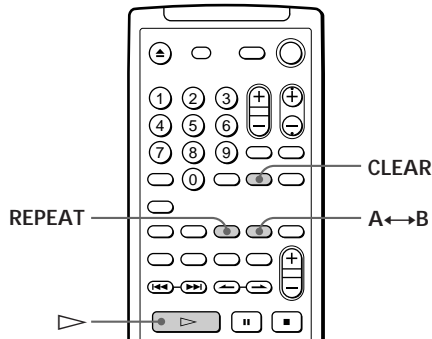

Repeating all the titles or all the tracks on a disc **DVD** **VIDEO CD** **CD**

In Shuffle or Program Play mode, the player repeats the titles or tracks in the shuffled or programmed order.

You cannot do Repeat Play during PBC playback of VIDEO CDs (page 17). You may not be able to do Repeat Play depending on the DVD.

Press REPEAT during playback.

“ALL REPEAT” appears on the screen and “REPEAT” appears on the front panel display. The player repeats the titles/chapters/tracks as follows:

When the disc is played in	The player repeats
Continuous Play (page 10, 14)	All the titles/all the tracks
Shuffle Play (page 24)	All the titles or tracks in random order
Program Play (page 24)	Programmed titles/chapters/tracks

To cancel repeating all the titles or all the tracks on a disc Press CLEAR.

Repeating the current title or chapter



You can repeat only the current title or chapter in Continuous Play mode. You may not be able to do Repeat Play depending on the DVD.

■ Repeating the current title

While the title you want is being played, press REPEAT repeatedly until “TITLE REPEAT ” appears on the TV screen.

The player repeats the current title.

■ Repeating the current chapter

While the chapter you want is being played, press REPEAT repeatedly until “CHAPTER REPEAT ” appears on the TV screen.

The player repeats the current chapter.

“REPEAT 1” appears on the front panel display.

“CHAPTER” is displayed when you select the current chapter

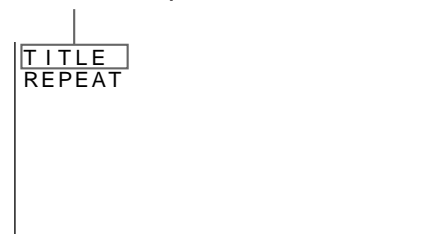

To cancel repeating the current title or chapter Press CLEAR.

Repeating the current track **VIDEO CD** **CD**

You can repeat only the current track in Continuous Play mode.

While the track you want is being played, press REPEAT until “TRACK REPEAT ” appears on the TV screen.

“REPEAT 1” appears on the front panel display and the player repeats the current track.

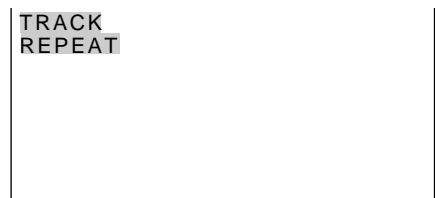

To cancel repeating the current track Press CLEAR.

Note

Repeat play is canceled when you turn the power off.

Repeating a specific portion

(A↔B Repeat)   

You can play a specific portion of a title, chapter, track repeatedly. This is useful when you want to memorize lyrics.

During PBC Playback of VIDEO CDs (page 17), this function is available only while playing moving pictures.

You may not be able to do Repeat Play depending on the DVD.

- 1 During playback, when you find the starting point (point A) of the portion to be played repeatedly, press A↔B.

The starting point (point A) is set. "A-B REPEAT" appears on the TV screen and "B" flashes.

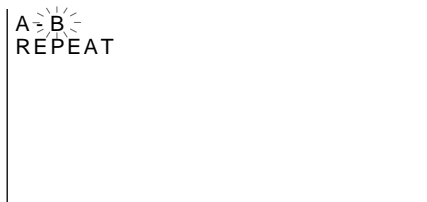

"REPEAT A-" also appears on the front panel display and "B" flashes.

- 2 When you reach the ending point (point B), press A↔B again.

"A-B REPEAT" on the TV screen disappears and the player starts repeating this specific portion.

"REPEAT A-B" appears on the front panel display during A↔B repeat play.

To cancel A↔B Repeat
Press CLEAR.

To cancel setting halfway
Press CLEAR.

Notes

- A↔B Repeat is canceled when:
 - you open or close the disc tray
 - you turn the power off
- When you set A↔B Repeat, the settings for Shuffle Play and Program Play are canceled.
- You may not be able to set A↔B Repeat, depending on the scene of a DVD or a VIDEO CD.

Playing in Random Order (Shuffle Play)



You can have the player “shuffle” titles or tracks and play them in a random order.

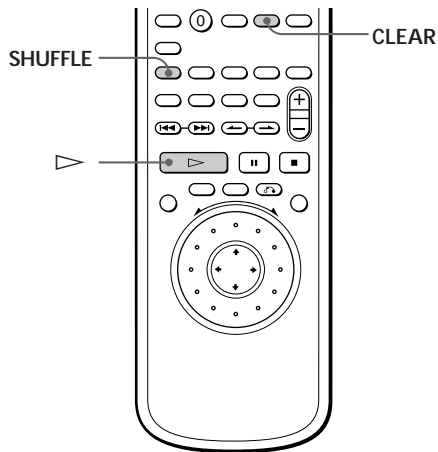

- 1 Press SHUFFLE.
 - 2 Press ▷.
- (During playback, the player starts Shuffle Play when you follow the step 1.)

To cancel Shuffle Play
Press CLEAR

Notes

- The Shuffle Play is canceled when:
 - you open or close the disc tray
 - you turn the power off
- You may not be able to do Shuffle Play depending on the DVD.
- When you play a DVD, you can do Shuffle Play only by titles.

Creating Your Own Program (Program Play)



You can arrange the order of the titles, chapters or tracks on the disc and create your own program. The program can contain up to 99 titles, chapters and tracks.

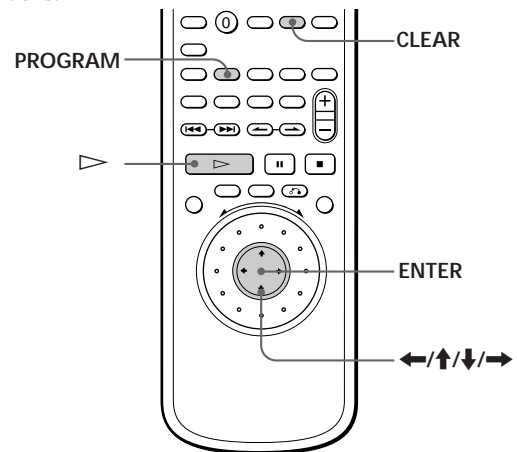

- 1 Press PROGRAM.
The programming display appears.

“TRACK_” is displayed when you play a VIDEO CD or a CD.

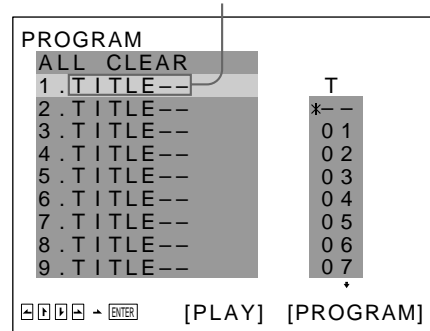

- 2 Press →.
“01” is highlighted.

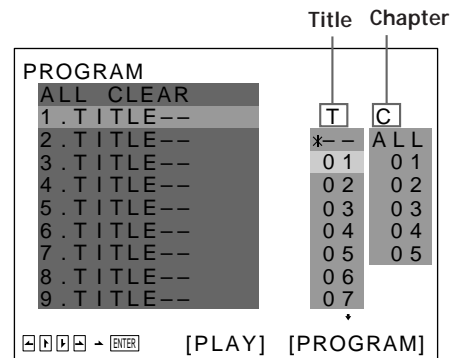

- 3** Select the title, chapter or track you want to program using \uparrow/\downarrow , then press ENTER. For example, select title or track 2. (You can also use the number buttons and ENTER button to select. In this case, the selected number is displayed on the screen.)

■ When playing a DVD

When both titles and chapters are recorded on the disc, select the title, then the chapter.

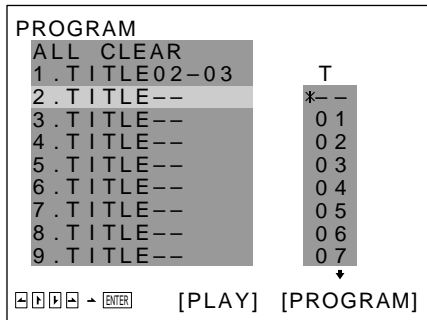
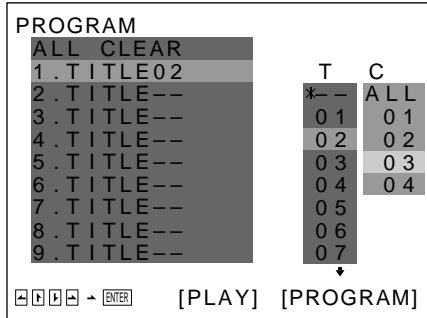

■ When playing a VIDEO CD or CD

Select the track you want to program.

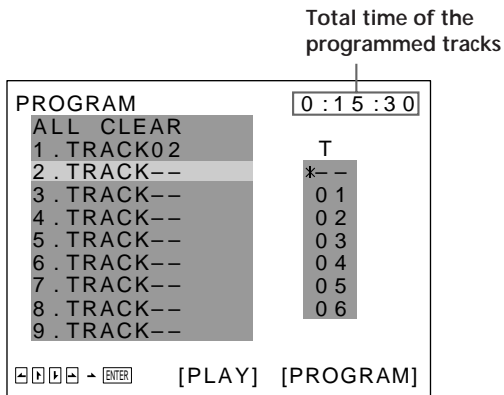

- 4** To program other titles, chapters or tracks, repeat Step 3. The programmed titles, chapters or tracks are displayed from 02 in order.

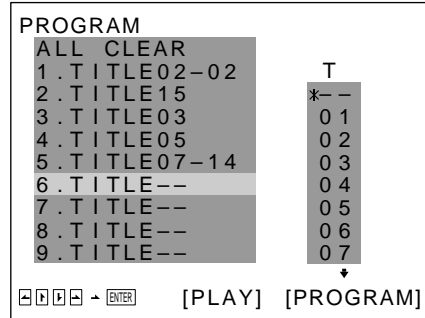

- 5** Press \triangleright to start Program Play.

To cancel Program Play

Press CLEAR.

To cancel programming

Press PROGRAM.

To change programming

- In Step 2, select the program number of the title, chapter or track you want to change using \uparrow/\downarrow .
- Follow Step 3 for new programming.

To cancel the programmed order

To cancel all the titles, chapters or tracks in the programmed order, select "ALL CLEAR" in Step 2.

To cancel the selected program, select the program using \uparrow/\downarrow in Step 2 then press CLEAR, or select "--" in Step 3 and then press ENTER.



The program remains even after the Program Play ends

When you press \triangleright , you can play the same program again.



You can do Repeat Play or Shuffle Play of the programmed titles, chapters or tracks

During Program Play, press REPEAT or SHUFFLE.

Notes

- The number of titles, chapters or tracks displayed are that of the titles, chapters or tracks recorded on a disc.
- The program is canceled when:
 - you open or close the disc tray
 - you turn the power off
- You may not be able to do Program Play depending on the DVD.
- While you are doing PBC playback, you cannot set a program unless you stop playback once.

Resuming Playback from the Point Where You Stopped a Disc (Resume Play)



The player stores the point where you stopped a disc if “RESUME” appears on the front panel display. In this case, you can resume playback from that point. As long as you do not open the disc tray, Resume Play is available even if you turn the power off.

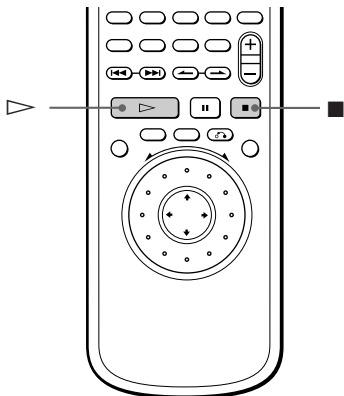

1 While playing a disc, press ■ to stop playback. “RESUME” appears in the front panel display and “When playing next time, disc restarts from point you stopped.” appears on the TV screen. If “RESUME” does not appear, Resume Play is not available.

2 Press ▷.
The player starts playback from the point you stopped the disc in Step 1.

To play from the beginning of the disc
When “RESUME” appears on the front panel display before you start playing, press ■ to turn off “RESUME,” then press ▷.

Notes

- You may not do Resume Play depending on the DVD.
- Resume Play is not available in Shuffle or Program Play mode.
- Depending on where you stopped the disc, the player may resume playback from a different point.
- The point where you stopped playing is cleared when:
 - you open or close the disc tray
 - you disconnect the AC power cord
 - you change the play mode
 - you start playback after selecting a title, chapter or track
 - you change the settings of “DVD MENU”, “AUDIO” or “SUBTITLE” in “LANGUAGE SETUP” in the setup display
 - you change the settings of “TV TYPE”, “PARENTAL CONTROL” in “INITIAL SETUP 1” in the setup display

Reducing the Picture Noise (DNR: Digital Video Noise Reduction)



You can make the picture clearer by reducing the picture noise.

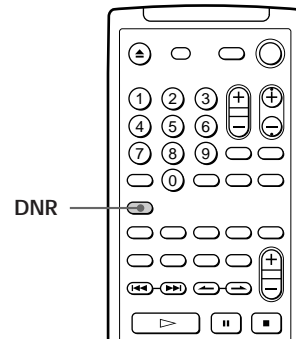

Press DNR.

Each time you press the button, the value for DNR changes as follows:

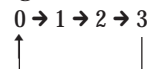

* 0 means DNR is off.

As the value increases, the picture noise will be reduced. However, afterimages may increase.

Notes

- Depending on the disc, the effect may be difficult to tell.
- If the afterimages appear on the TV screen, set the noise reduction function to off on your TV. Then set DNR to “0” on the player.

Changing the Sounds



With DVDs on which multilingual sounds are recorded, you can select the language you want while playing the DVD.

With multiplex VIDEO CDs, you can select the sound from the right or left channel and listen to the sound of the selected channel through both the right and left speakers. In this case, the sound loses the stereo effect.

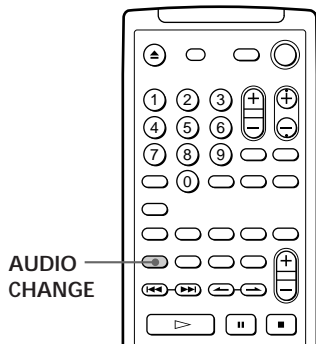

Press AUDIO CHANGE while playing a disc. Each time you press the button, the indication and the language/sound from the speakers change as follows:

■ When playing a DVD

AUDIO 1 → AUDIO 2 →



■ When playing a VIDEO CD or a CD

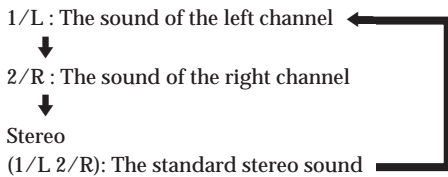

Notes

- Depending on the DVD, you may not be able to change the languages even if multilingual sounds are recorded on the DVD.
- While playing the CD/VIDEO CD, if you turn off the player the standard stereo playback will be resumed.
- If the language is indicated in a four-digit number, refer to the Language Code List on page 48.

Displaying the Subtitles

DVD

With DVDs on which subtitles are recorded, you can turn the subtitles on and off whenever you want while playing the DVD. With DVDs on which multilingual subtitles are recorded, you can change the subtitles whenever you want while playing the DVD.

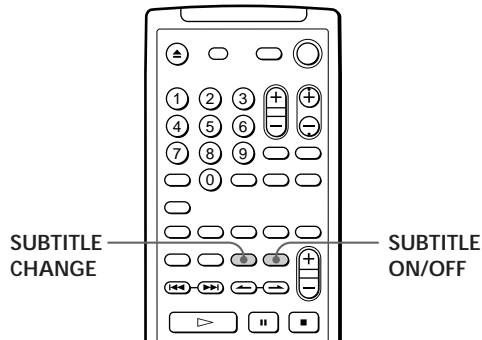

Turning the Subtitles On and Off

Press SUBTITLE ON/OFF while playing a DVD. Subtitles appear on the TV screen.

To turn off the subtitles
Press SUBTITLE ON/OFF again.

Notes

- When playing the DVD on which no subtitles are recorded, no subtitles appear even if you press SUBTITLE ON/OFF.
- Depending on the DVD, you may not be able to turn the subtitles on even if they are recorded on the DVD.
- Depending on the DVD, you may not be able to turn the subtitles off.
- If the language is indicated in a four-digit number, refer to the Language Code List on page 48.

Changing the Subtitle Language

When subtitles are turned off, press SUBTITLE ON/OFF to turn on the subtitles.

While playing a DVD, press SUBTITLE CHANGE repeatedly until the subtitles you want appear on the TV screen.

SUBTITLE 1 → SUBTITLE 2 → ...



Notes

- The type and number of languages for subtitles vary from disc to disc.
- Depending on the DVD, you may not be able to change the subtitles even if multilingual subtitles are recorded on the DVD.

Changing the Angles

With DVDs on which various angles (multi-angles) for a scene are recorded, you can change the angles whenever you want while playing the DVD.

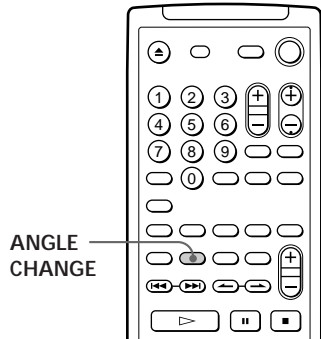

When "ANGLE" appears on the front panel display while playing a DVD, press ANGLE CHANGE repeatedly until you get the angle you want.



ANGLE 1 → ANGLE 2 → ...



You can specify the angle beforehand

Specify the angle when "ANGLE" is not displayed on the front panel display. When a scene on which multi-angles are recorded comes, the angle is automatically selected.

Notes

- The number of angles varies from disc to disc or from scene to scene. The number of angles that can be changed on a scene is that of angles recorded for that scene.
- Depending on the DVD, you may not be able to change the angles even if multi-angles are recorded on the DVD.

Limiting Playback by Children (Parental Control)

Playing some DVDs can be limited depending on the age of users. The "Parental Control" function allows you to set a playback limitation level.

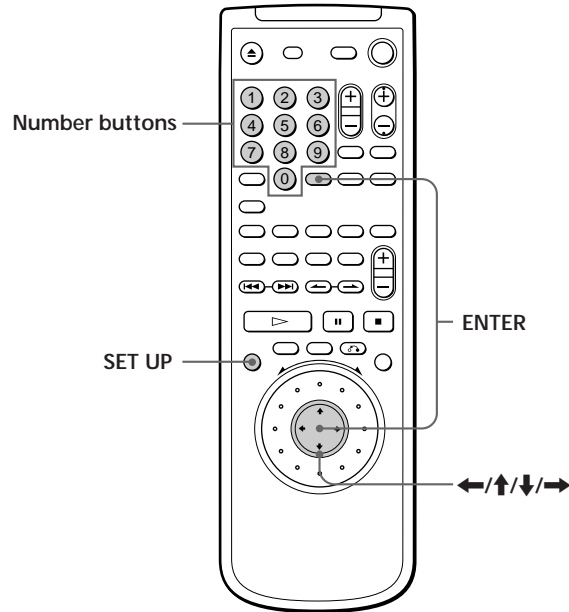

- 1 Press SET UP to display the setup display on the TV screen before playing.

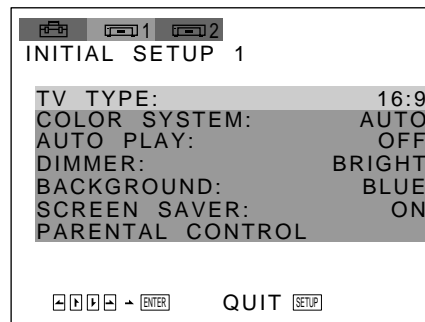

(Continued)

Playing Discs in Various Modes

- 2 Select "INITIAL SETUP 1" using ←/→, then press ENTER or ↓.

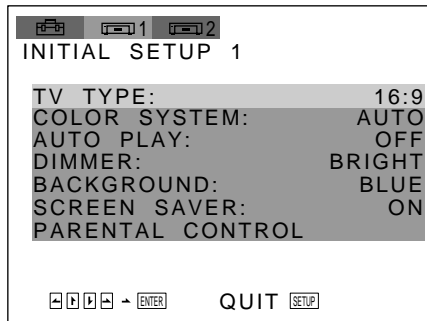

- 3 Select "PARENTAL CONTROL" using ↑/↓, then press ENTER.

- When you have not entered a password yet
The display for entering a password appears.



- When you have already entered a password
The display for confirming the password appears.
Skip Step 4.

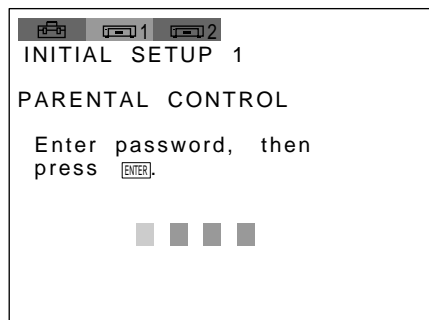

- 4 Enter a password in 4 figures using the number buttons, then press ENTER.
The figures change to asterisks (*), and the display for confirming the password appears.

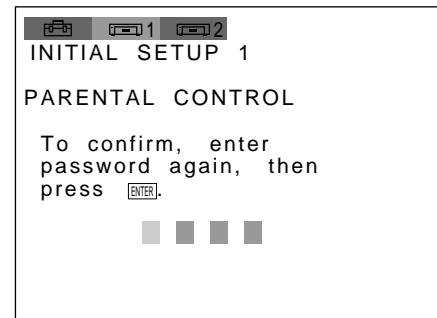

- 5 To confirm your password, enter it using the number buttons, then press ENTER.
The display for setting the playback limitation level and changing the password appears.

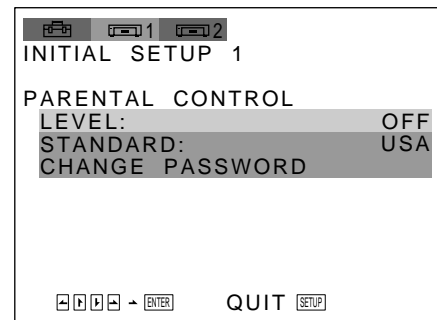

- 6 Select "STANDARD" using ↑/↓, then press →.

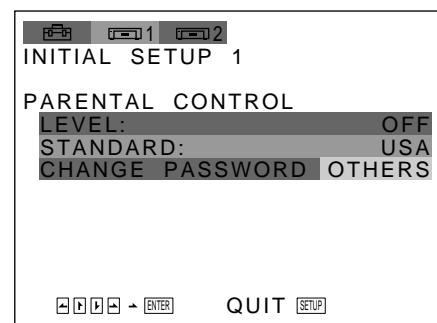

- 7 Select an area as the standard for playback limitation level using \uparrow/\downarrow , then press \rightarrow . When you select "OTHERS", select and enter the standard code in the table below using number buttons.

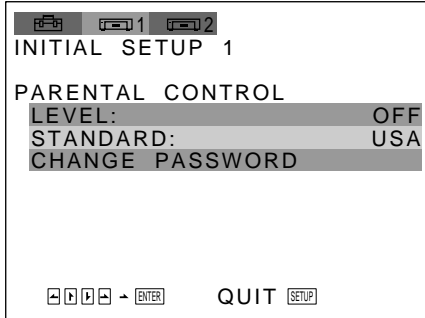

- 8 Select "LEVEL" using \uparrow/\downarrow , then press \rightarrow .

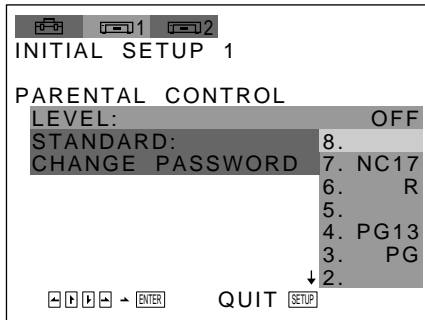

- 9 Select the level you want using \uparrow/\downarrow , then press ENTER.

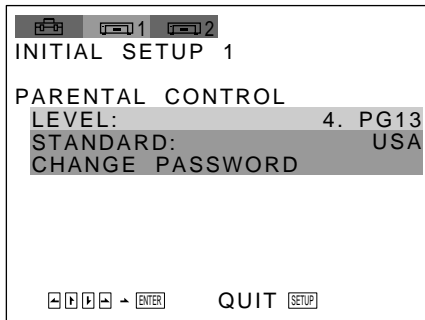

The lower the value is, the more strict the limitation.

To return to the normal screen
Press SET UP.

To turn off the Parental Control function and play the DVD after entering your password
Set "LEVEL" to "OFF" in Step 9, then press \triangleright .

To change the password

- In Step 5, select "CHANGE PASSWORD" using \uparrow/\downarrow , then press \rightarrow or ENTER.
The display for changing the password appears.
- Follow Steps 4 and 5 to enter a new password.



If you have forgot your password

Enter six digits number "199703" in Step 4 to clear the current password. To enter a new password, follow the procedure from Step 4 again.

Notes

- When you play DVDs which do not have the Parental Control function, playback cannot be limited on this player.
- When you do not set a password, you cannot change the settings for playback limitation.
- Depending on the DVD, you may be asked to change the parental control level while playing the disc. In this case, enter the password, then change the level.
When you stop playing the DVD, the level returns to the original level.

Standard	Code number
Austria	2046
Belgium	2057
Canada	2079
China	2092
Denmark	2115
Finland	2165
France	2174
Germany	2109
Hong Kong	2219
Indonesia	2238
Italy	2254
Japan	2276
Malaysia	2363
Netherlands	2376
Norway	2379
Philippines	2424
Singapore	2501
Spain	2149
Sweden	2499
Switzerland	2086
Taiwan	2543
Thailand	2528
United Kingdom	2184

Controlling the TV or the AV Amplifier (Receiver) with the Supplied Remote

If you adjust the remote signal, you can control your TVs with the supplied remote. Default setting is to control Sony TVs with the  mark.

When you connect the player to a Sony amplifier, you can also set the input of the amplifier to this player with the supplied remote .

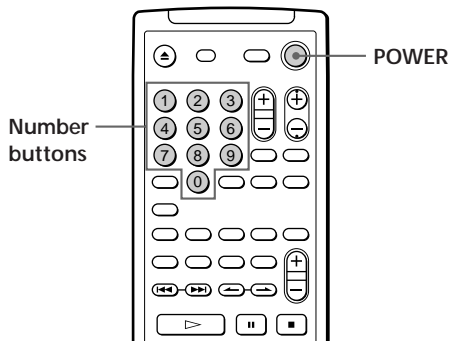

Controlling TVs with the remote

Hold down POWER, and enter your TV's manufacturer's code in the table below using the number buttons. Then release POWER.

Code numbers of controllable TVs

If more than one code number is listed, try entering them one at a time until you find the one that works with your TV.

Notes

- If you enter a new code number, the code number previously entered will be erased.
- When you replace the batteries of the remote commander, the code number automatically resets to 01 (Sony). Reset the appropriate code number.

Manufacturer	Code number	Manufacturer	Code number
Sony (default)	01	Sharp	29
Gold Star	03, 04	Aiwa	32
Philips	06, 08	JVC	33
Miver	09	Toshiba	38
Blaupunkt	10, 21	Siemens	39
Grundig	11	Thomson	43
Saba	12, 13	Loewe	45
Panasonic	17, 49	Orion	47, 48
Samsung	23	Ferguson	52
Hitachi	24	NEC	66
Sanyo	25	TEAC	67
Pioneer	26	Akai	68
Mitsubishi	27, 28, 50	Nokia	69

You can control your TV using the buttons below.

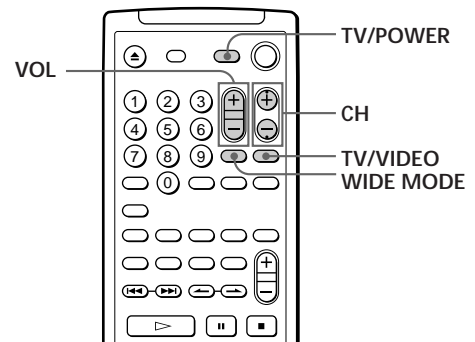

By pressing	You can
TV POWER	Turn on or off the TV
TV/VIDEO	Select the input source for the TV
WIDE MODE	Switches the wide mode of the TV
VOL	Adjust the volume of the TV
CH	Change the channel of the TV

Note

Depending on the TV, you may not be able to control your TV or to use some buttons above.

Controlling Sony AV amplifier with the remote

Hold down POWER, and enter your AV amplifier's input connector code in the table below using the number buttons.* Then release POWER.

Amplifier connector	Code number
VIDEO 1	91
VIDEO 2	92
VIDEO 3	93
AUX 1	94
LD/DVD (default setting)	95
AC-3	96
TV	97

* If you connect the player to the SONY Mini Hi-Fi Component System, enter "98".

When you press AV CENTER on the supplied remote, you can set the input of AV amplifier to the player.** You can also change the volume of the sound using AV VOL.

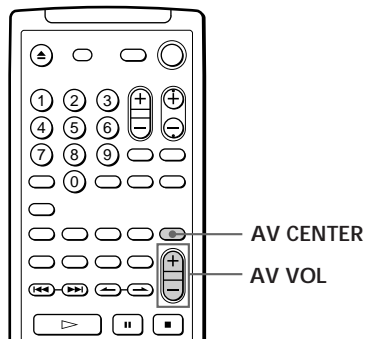

** If you connect the player to the SONY Mini Hi-Fi Component System, press AV CENTER repeatedly to change the input of the system.

Using the Setup display

Using the setup display, you can do the initial setup, adjusting the picture and sound quality, setting the various outputs, etc. You can also set a language for the sub-titles and the setup display, limit playback by children, etc.

For details on each setup display item, see pages 35 to 37.

The setup display items are listed in page 47.

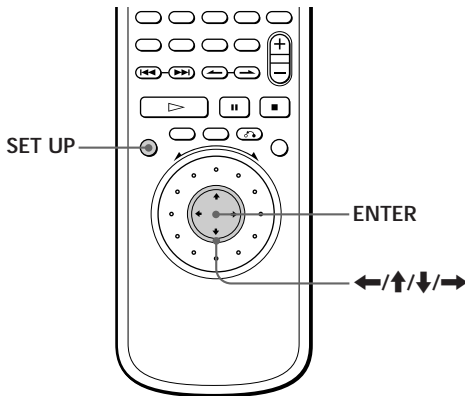

- 1 Press SET UP to display the setup display on the TV screen.

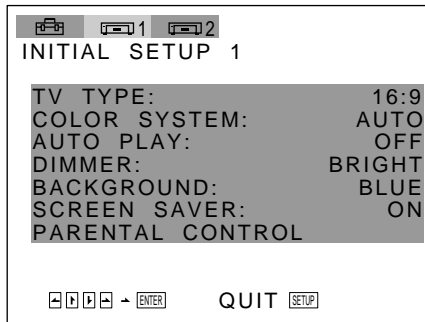

- 2 Select the main item you want using ←/→, and then press ENTER. The selected main item is highlighted.

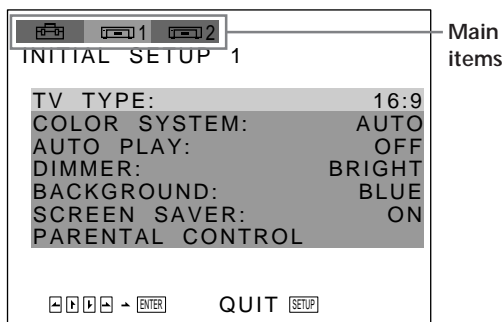

- 3 Select the item you want using ↑/↓, then press → or ENTER.

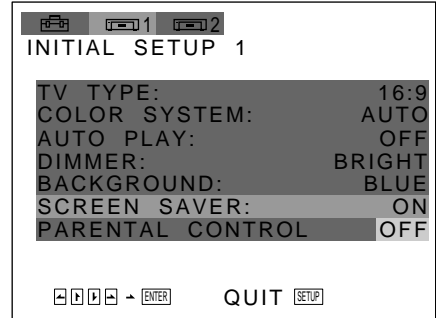

- 4 Select the setting you want using ↑/↓, then press ENTER.

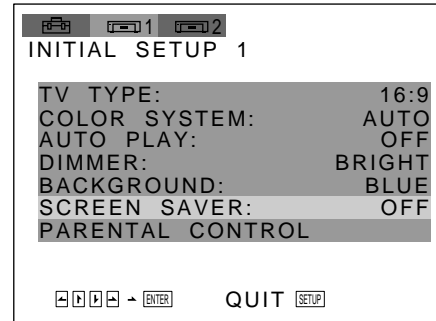

To cancel using the setup display on the way Press SET UP.

Note

Some setup display items require operations other than selecting the setting. For details on these items, see the relevant pages.

Setting the Language for Display and Sound (LANGUAGE SETUP)

Select “

“LANGUAGE SETUP” allows you to set various languages for on-screen display or sound. Default settings are underlined.

Note

When you select a language that is not recorded on the DVD, one of the recorded languages is automatically selected except for “OSD”.

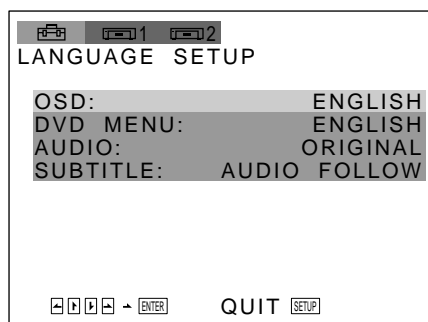

■ OSD (On-Screen Display)

Switches the language for the on-screen display.

- ENGLISH
- CHINESE

■ DVD MENU

Switches the language for the DVD menu.

- ENGLISH
- CHINESE
- SPANISH
- PORTUGUESE
- JAPANESE
- FRENCH
- GERMAN
- ITALIAN
- DUTCH
- OTHERS→

When you select “OTHERS,” select and enter the language code from the list using the number buttons (page 48).

■ AUDIO

Switches the language for the sounds.

- ORIGINAL : the language given the priority in the disc
- ENGLISH
- CHINESE
- SPANISH
- PORTUGUESE
- JAPANESE
- FRENCH
- GERMAN
- ITALIAN
- DUTCH
- OTHERS→

When you select “OTHERS,” select and enter the language code from the list using the number buttons (page 48).

■ SUBTITLE

Switches the language for the subtitles.

- AUDIO FOLLOW*
- ENGLISH
- CHINESE
- SPANISH
- PORTUGUESE
- JAPANESE
- FRENCH
- GERMAN
- ITALIAN
- DUTCH
- OTHERS→

When you select “OTHERS,” select and enter the language code from the list using the number buttons (page 48).

* When you select “AUDIO FOLLOW,” the language for the subtitles change according to the language for the sound.

Settings for Display (INITIAL SETUP 1)

Select "1" after pressing SET UP.

"INITIAL SETUP 1" allows you to set the display according to the playback conditions.

Default settings are underlined.

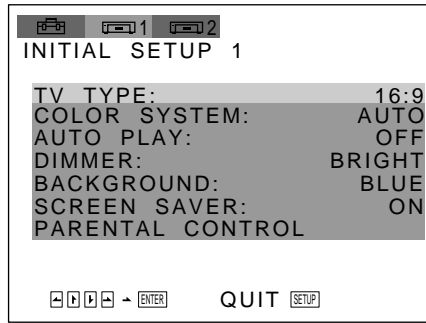

■ TV TYPE

Selects the aspect ratio of the TV to be connected.

- 16:9: when you connect a wide-screen TV to the player
- 4:3 LETTER BOX: when you connect a normal TV to the player. Displays the wide picture with bands displayed on the upper and lower portions of the screen.
- 4:3 PAN SCAN: when you connect a normal TV to the player. Displays the wide picture on the whole screen with a portion automatically cut off.

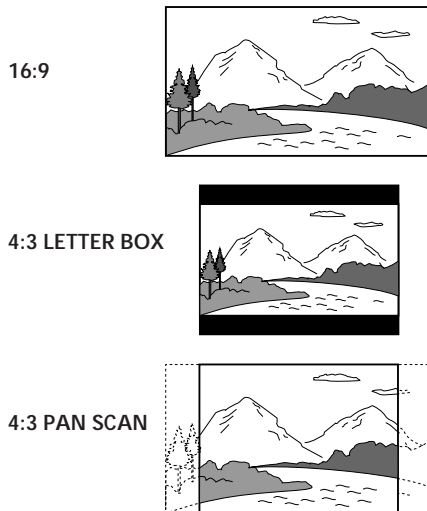

Note

Depending on the DVD, "4.3 LETTER BOX" may be selected automatically instead of "4.3 PAN SCAN" and vice versa.

■ COLOR SYSTEM

Selects the color system when you play a VIDEO CD.

- AUTO: Outputs the video signal in the system of the VIDEO CD, either PAL or NTSC. If your TV is the DUAL system, select AUTO.
- PAL: changes the video signal of an NTSC VIDEO CD and outputs it in PAL system.
- NTSC: changes the video signal of a PAL VIDEO CD and outputs it in NTSC system.

Notes

- You cannot change the color system of the DVD itself.
- You can change the color system of this unit according to the connected TV. See page 9.

■ AUTO PLAY

Selects the setting of Auto Play when you connect the AC power cord to the AC outlet.

- OFF: does not start playing with TIMER, DEMO1 or DEMO2.
- TIMER: starts playing a disc automatically when you connect the AC power cord to the AC outlet. By connecting a timer (not supplied), you can start playing at any time you want.
- DEMO1: starts playing the demonstration 1 automatically.
- DEMO2: starts playing the demonstration 2 automatically.

■ DIMMER

Adjusts the lighting of the front panel display.

- BRIGHT: makes the front panel display bright.
- DARK: makes the front panel display dark.
- OFF: turns off the lighting of the front panel display.

■ BACKGROUND

Selects the background color of the TV screen in stop mode.

- BLUE: The background color is blue.
- BLACK: The background color is black.

■ SCREEN SAVER

Turns on and off the screen saver. If you turn on the screen saver, the screen saver image appears when you leave the player or the remote in pause mode for 15 minutes. The screen saver is useful to prevent your display from damage.

- ON: turns on the screen saver.
- OFF: turns off the screen saver.

■ PARENTAL CONTROL

Sets a password and playback limitation level when you play DVDs with playback limitation for children.

For details, see page 29.

Settings for Sound (INITIAL SETUP 2)

Select “ 2” after pressing SET UP.
“INITIAL SETUP2” allows you to set the sound according to the playback conditions.
Default settings are underlined.

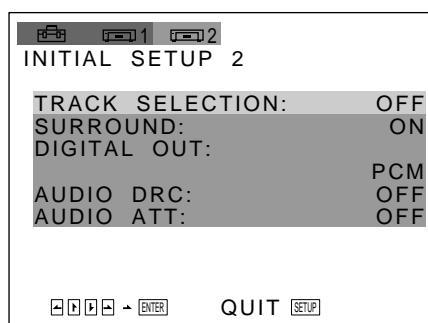

■ TRACK SELECTION

Gives the Dolby Digital (AC-3) format priority when you play a DVD on which multiple audio formats are recorded. If multiple audio channels are recorded in Dolby Digital (AC-3) format, the higher-numbered channel audio recorded in Dolby Digital (AC-3) format is played.

- OFF: No priority given.
- AUTO: Priority given.

Notes

- When you set this item to “ON”, the language may change depending on the “AUDIO” settings in “LANGUAGE SETUP.”
The “TRACK SELECTION” setting has higher priority than that of “AUDIO” settings in “LANGUAGE SETUP” (page 35).
- Depending on the DVD, the audio with priority may be predetermined. In this case, you cannot give priority to the Dolby Digital (AC-3) format by selecting “AUTO.”

■ SURROUND

Switches the mixing down methods when you play a DVD on which the sound in Dolby Digital (AC-3) format is recorded.

- ON: when the player is connected to an audio component that conforms to Dolby surround, Dolby Pro Logic surround, etc.
- OFF : when the player is connected to a normal audio component.

■ DIGITAL OUT

Switches the methods of outputting audio signals from the DIGITAL OUT OPTICAL and COAXIAL connectors on the rear panel of the player.

- PCM: when the player is connected to an audio component without a built-in Dolby Digital (AC-3) decoder. The Dolby Digital track is output also in 2 channels and the surround component depends on the “SURROUND” setting.
- DOLBY DIGITAL/PCM: when the player is connected to audio component with a built-in Dolby Digital (AC-3) decoder.

Note

Select the setting correctly. Otherwise, no sound or strange sound will come out from the speakers, affecting your ears or causing the speakers to be damaged.

■ AUDIO DRC (Dynamic Range Control)

Makes the sound clear with the volume turned down at night, etc. when you play a DVD. This affects the output from the DIGITAL OUT connectors only when “DIGITAL OUT” in “INITIAL SETUP 2” is set to “PCM,” and the output from the LINE OUT (AUDIO 1,2).

- OFF: Normally select this position.
- ON: makes the sound clear even if you turned the volume down.

Note

When you play DVDs without the AUDIO DRC function, there may be no effect on the sound.

■ AUDIO ATT (attenuation)

Selects the setting of the output from the LINE OUT (AUDIO 1, 2) connectors according to audio equipment to be connected.

- OFF: turns off the audio attenuation.
- ON: reduces the audio output level so that no sound distortion occurs.

Note

The setting does not affect the output from the DIGITAL OUT connectors.

Precautions

On safety

- Caution – The use of optical instruments with this product will increase eye hazard.
- Should any solid object or liquid fall into the cabinet, unplug the player and have it checked by qualified personnel before operating it any further.

On power sources

- The player is not disconnected from the AC power source (mains) as long as it is connected to the wall outlet, even if the player itself has been turned off.
- If you are not going to use the player for a long time, be sure to disconnect the player from the wall outlet. To disconnect the AC power cord (mains lead), grasp the plug itself; never pull the cord.
- Should the AC power cord (mains lead) need to be changed, have it done at a qualified service shop only.

On placement

- Place the player in a location with adequate ventilation to prevent heat build-up in the player.
- Do not place the player on a soft surface such as a rug that might block the ventilation holes on the bottom.
- Do not place the player in a location near heat sources, or in a place subject to direct sunlight, excessive dust or mechanical shock.

On operation

- If the player is brought directly from a cold to a warm location, or is placed in a very damp room, moisture may condense on the lenses inside the player. Should this occur, the player may not operate properly. In this case, remove the disc and leave the player turned on for about half an hour until the moisture evaporates.

On adjusting volume

- Do not turn up the volume while listening to a portion with very low level inputs or no audio signals. If you do, the speakers may be damaged when a peak level portion is played.

On cleaning

- Clean the cabinet, panel and controls with a soft cloth slightly moistened with a mild detergent solution. Do not use any type of abrasive pad, scouring powder or solvent such as alcohol or benzine.

If you have any questions or problems concerning your player, please consult your nearest Sony dealer.

IMPORTANT NOTICE

Caution: The enclosed DVD Player is capable of holding a still video image or Setup display image on your television screen indefinitely. If you leave the still video image or Setup display image displayed on your TV for an extended period of time you risk permanent damage to your television screen. Projection televisions are very susceptible.

Notes on Discs

On handling discs

- To keep the disc clean, handle the disc by its edge. Do not touch the surface.
- Do not stick paper or tape on the disc. If there is glue (or a similar substance) on the disc, remove the glue completely before using the disc.

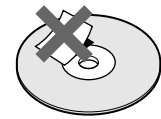
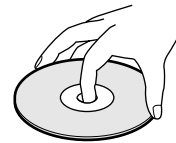

Not this way

- Do not expose the disc to direct sunlight or heat sources such as hot air ducts, or leave it in a car parked in direct sunlight as there can be considerable rise in temperature inside the car.
- After playing, store the disc in its case.

On cleaning

- Before playing, clean the disc with a cleaning cloth. Wipe the disc from the center out.

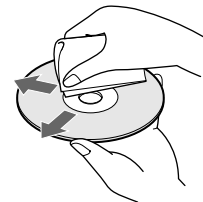

- Do not use solvents such as benzine, thinner, commercially available cleaners or anti-static spray intended for vinyl LPs.

Troubleshooting

If you experience any of the following difficulties while using the player, use this troubleshooting guide to help you remedy the problem. Should any problem persist, consult your nearest Sony dealer.

The power is not turned on.

- ➔ If the indicator above the POWER button is not lit, check that the AC power cord is connected securely.

There is no picture.

- ➔ Check that the player is connected securely.
- ➔ The video connecting cord is damaged. Replace it with a new one.
- ➔ Make sure you connect the player to the video input connector on the TV. (page 6)
- ➔ Make sure you turn on the TV.
- ➔ Make sure you select the video input on the TV so that you can view the pictures from the player.

There is no sound.

- ➔ Check that the player is connected securely.
- ➔ The audio connecting cord is damaged. Replace it with a new one.
- ➔ Make sure you connect the player to the audio input connectors on the amplifier. (page 6)
- ➔ Make sure you turn on the TV and the amplifier.
- ➔ Make sure you select the appropriate position on the amplifier so that you can listen to the sound from the player.
- ➔ The player is in pause mode or in Slow-motion Play mode. Press ▷ to return to normal play mode.
- ➔ Fast forward (FF1 or FF2) or fast reverse (FR1 or FR2) is performed. Press ▷ to return to normal play mode.

The remote does not function.

- ➔ Remove any obstacles between the remote and the player.
- ➔ Use the remote near the player.
- ➔ Point the remote at the remote sensor  on the player.
- ➔ Replace all the batteries in the remote with new ones if they are weak.

The picture noise appears.

- ➔ Clean the disc.
- ➔ If video from your DVD player has to go through your VCR to get to your TV, the copy-protection applied to some DVD programs could affect picture quality. If you still experience problems after checking your connections, please try connecting your DVD player directly to your TV's S-input, if your TV is equipped with that input.

The sound noise is heard.

- ➔ Clean the disc.

The sound distortion occurs.

- ➔ In the setup display, set "AUDIO ATT" in "INITIAL SETUP 2" to "ON."

The disc does not play.

- ➔ There is no disc inside ("INSERT DISC" appears on the TV screen).
Insert a disc.
- ➔ Insert the disc with the playback side facing down on the disc tray correctly.
- ➔ Place the disc on the disc tray correctly.
- ➔ Clean the disc.
- ➔ The player cannot play CD-ROMs, etc. (page 5)
Insert a DVD, a VIDEO CD, or CD.
- ➔ Check the region code of the DVD. (page 4)
- ➔ Moisture has condensed inside the player.
Remove the disc and leave the player turned on for about half an hour. (page 38)

The player does not play from the beginning when playing a disc.

- ➔ Repeat Play, Shuffle Play or Program Play has been selected. Press CLEAR. (page 22 to 25)
- ➔ Resume Play has been selected.
Press ■ on the front panel or on the remote before you start playing. (page 26)
- ➔ A title menu or a DVD menu automatically appears on the TV screen when you play your DVD, or a setup display automatically appears on the TV screen when you play your VIDEO CD with PBC functions.

The DVD does not play when you select a title.

- ➔ The Parental Control functions. (page 29)

The player starts playing the DVD automatically.

- ➔ The DVD features the auto playback function.
- ➔ In the setup display, set "AUTO PLAY" to "OFF" under "INITIAL SETUP 1." Otherwise the player starts playback automatically.

Additional Information

Stopping playback, Search, Slow-motion Play, Repeat Play, Shuffle Play or Program Play, etc., cannot be done.

- ➔ Depending on the disc, you may not do some of the operations above.

Messages do not appear on the TV screen in the language you want.

- ➔ In the setup display, select the language for the on-screen display in "OSD" under "LANGUAGE SETUP." (page 35)

The language for the sound cannot be changed when you play a DVD.

- ➔ Multilingual sound is not recorded on the DVD.
- ➔ Changing the language for the sound is prohibited on the DVD.

The language for the sound changes automatically.

- ➔ When you set the "TRACK SELECTION" in "INITIAL SETUP 2" to "ON" in the setup display, the language may change depending on the "AUDIO" settings in "LANGUAGE SETUP." The "TRACK SELECTION" setting has higher priority than that of "AUDIO" settings. (page 37)

The language for the subtitles cannot be changed when you play a DVD.

- ➔ Multilingual subtitles are not recorded on the DVD.
- ➔ Changing the language for the sub-titles is prohibited on the DVD.

The sub-titles cannot be turned off when you play a DVD.

- ➔ Depending on the DVD, you may not be able to turn the sub-titles off.

The angles cannot be changed when you play a DVD.

- ➔ Multi-angles are not recorded on the DVD.
- ➔ Change the angles when "ANGLE" appears on the front panel display. (page 29)
- ➔ Changing the angles is prohibited on the DVD.

The aspect ratio of the screen cannot be changed even though you set "TV TYPE" in "INITIAL SETUP 1" in the setup display when you play a wide picture.

- ➔ The aspect ratio is fixed on your DVD.

The menu screen does not appear when you play a VIDEO CD.

- ➔ The VIDEO CD does not feature PBC functions.
- ➔ Follow the correct operating procedure. (Also refer to the instructions supplied with the disc.)

The sound loses stereo effect when you play a VIDEO CD or a CD.

- ➔ "1/L" or "2/R" appears on the front panel display.
On the remote, press AUDIO CHANGE repeatedly until "1/L 2/R" appears. (page 27)
- ➔ Make sure you connect the player appropriately. (pages 7, 8)

The player does not operate properly.

- ➔ Static electricity, etc., may affect the player's operation.
Disconnect the AC power cord once, then connect it again.

The numbers or letters of 5 characters is displayed on the screen.

- ➔ Self diagnosis function was activated. See the table in page 41 and treat the player appropriately.

Self-diagnosis function

In the self-diagnosis function works to prevent the CD/DVD player from malfunctioning, a five-digit service number (combination of a letter and figures) flashes on the screen. In this case, check the following table.

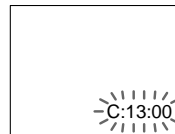

First three digits	Cause and/or Corrective Action
C13	<ul style="list-style-type: none">• The disc is dirty. <p>➔ Clean the disc with a cleaning cloth. (page 38)</p>
C31	<ul style="list-style-type: none">• The disc is not inserted correctly. <p>➔ Open the disc tray and insert the disc correctly.</p>
Exx (xx is any number)	<ul style="list-style-type: none">• To prevent the player from operating malfunctioning, the self-diagnosis function has worked. <p>➔ When you contact your Sony dealer or local authorized Sony service facility, inform the service number with five digits. (example: E:61:10)</p>

Specifications

CD/DVD player	
Signal format system	PAL/NTSC
Audio characteristics	
Frequency response	DVD (PCM96kHz): 2 Hz to 44 kHz (±0.5 dB)* DVD (PCM48kHz): 2 Hz to 22 kHz (±0.5 dB) CD: 2 Hz to 20 kHz (±0.5 dB)
Signal-to-noise ratio	More than 110 dB (LINE OUT (AUDIO 1, 2) connectors only)
Harmonic distortion	Less than 0.0028%
Dynamic range	DVD: More than 100 dB CD: More than 97 dB
Wow and flutter	Less than detected value (±0.001% W PEAK)

Outputs and inputs

	Jack type	Output level	Load impedance
LINE OUT (AUDIO 1, 2)	Phono jacks	2 Vrms (at 50 kilohms)	Over 10 kilohms
DIGITAL OUT (OPTICAL)	Optical output connector	-18 dBm	Wave length: 660 nm
DIGITAL OUT (COAXIAL)	Phono jacks	0.5 Vp-p	75 ohms terminated
LINE OUT (VIDEO 1, 2)	Phono jack	1.0 Vp-p	75 ohms, sync negative
S VIDEO OUT 1, 2	4-pin mini DIN	Y: 1.0 Vp-p C: 0.3 Vp-p	75 ohms, sync negative 75 ohms terminated
PHONES	Phone jack	12 mW	32 ohms

General

Power requirements	220 to 240 V AC, 50 Hz 110 to 240 V AC, 50/60 Hz See page 2 for further informations.
Power consumption	18 W
Dimensions (approx.)	280 × 91 × 333 mm (w/h/d) incl. projecting parts
Mass (approx.)	3.4 kg
Operating temperature	5 °C to 35 °C
Operating humidity	5% to 90%

Supplied accessories

See page 6.

- * When you play the PCM sound tracks with 96 kHz sampling frequency, the output signals from the DIGITAL OUT (OPTICAL, COAXIAL) connectors are converted to 48 kHz (sampling frequency) / 16 bits (quantization bits).

Design and specifications are subject to change without notice.

Glossary

Bit rate

Value indicating the amount of video data compressed in a DVD per second. The unit is Mbps (Mega bit per second). 1 Mbps indicates that the data per second is 1,000,000 bits. The higher the bit rate is, the larger the amount of data. However, this does not always mean that you can get higher quality pictures.

Chapter

Sections of a picture or a music piece on a DVD that are smaller than titles. A title is composed of several chapters. Each chapter is assigned a chapter number enabling you to locate the chapter you want.

Dolby Digital (AC-3)

Digital audio compression technology that the Dolby Laboratories Corporation developed. This technology conforms to 5.1-channel surround. The rear channel is stereo and there is discrete subwoofer channel in this format. The good channel separation is realized because the all channel data is recorded discrete and processed in digital.

Dolby Pro Logic

Audio signal processing technology that Dolby Laboratories Corporation developed for surround sound. When the input signal has the surround component, the Pro Logic process outputs the front, center and rear signals. The rear channel is monaural.

DVD

A disc that contains up to 8 hours of moving pictures even though its diameter is the same as a CD. The data capacity of a single-layer and single-sided DVD, at 4.7 GB (Giga Byte), is 7 times that of a CD. Furthermore, the data capacity of a dual-layer and single-sided DVD is 8.5 GB, a single-layer and double-sided DVD 9.4 GB, and a dual-layer and double-sided DVD 17 GB.

The picture data uses the MPEG 2 format, one of the worldwide standards of digital compression technology. The picture data is compressed to about 1/40 of its original size. The DVD also uses the variable rate coding technology that changes the data to be allocated according to the status of the picture. The audio data is recorded in Dolby Digital (AC-3) as well as in PCM, allowing you to enjoy more real audio presence.

Furthermore, various advanced functions such as the multi-angle, multilingual, and Parental Control functions are provided with the DVD.

Parental Control

A function of the DVD to limit playback of the disc by the age of the users according to the limitation level in each country. The limitation varies from disc to disc; when it is activated, playback is completely prohibited, violent scenes are skipped or replaced with other scenes and so on.

Playback Control (PBC)

Signals encoded on VIDEO CDs (Version 2.0) to control playback.

By using menu screens recorded on VIDEO CDs with PBC functions, you can enjoy playing simple interactive programs, programs with search functions, and so on.

Title

The longest sections of a picture or a music piece on a DVD; a movie, etc., for a picture piece on video software; or an album, etc., for a music piece on an audio software. Each title is assigned a title number enabling you to locate the title you want.

Track

Sections of a picture or a music piece on a CD or VIDEO CD. Each track is assigned a track number enabling you to locate the track you want.

VIDEO CD

A compact disc that contains moving pictures.

The picture data uses the MPEG 1 format, one of the worldwide standards of digital compression technology. The picture data is compressed to about 1/140 of its original size. Consequently, a 12 cm VIDEO CD can contain up to 74 minutes of moving pictures.

VIDEO CDs also contain compact audio data. Sounds outside the range of human hearing are compressed while the sounds we can hear are not compressed.

VIDEO CDs can hold 6 times the audio information of conventional audio CDs.

There are 2 versions of VIDEO CDs.

- Version 1.1: You can play only moving pictures and sounds.
- Version 2.0: You can play high-resolution still pictures and enjoy PBC functions.

This player conforms to both versions.

Index to Parts and Controls

Refer to the pages indicated in parentheses for details.

Front Panel

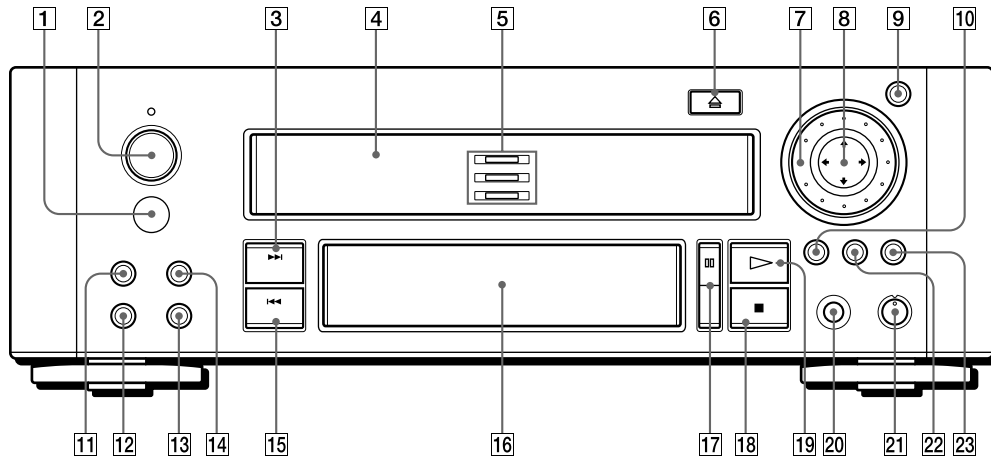

- 1** (remote sensor) (6)
Accepts the remote control signals.
- 2** POWER switch and indicator (10, 14)
Turns on and off the power of the player.
- 3** NEXT button (11, 15)
Press to go to the next chapter or track.
- 4** Disc tray (10, 14)
Place a disc on the tray.
- 5** Disc type indicators (20)
The respective indicator of the disc loaded lights up.
- 6** OPEN/CLOSE button (10, 14)
Opens or closes the disc tray.
- 7** Click shuttle (12, 16)
Changes the playback speed.
- 8** / / / /ENTER button
Selects and executes the items or settings.
- 9** JOG button/indicator (12, 16)
Press to play a disc frame by frame.
- 10** TITLE button (13)
Displays the title menu on the TV screen.
- 11** SHUFFLE button (24)
Press to execute the shuffle play.
- 12** PROGRAM button (24)
Press to execute the program play.
- 13** CLEAR button (22-25)
Press to return to the continuous play etc.
- 14** REPEAT button (22)
Press to execute the repeat play.
- 15** PREV button (11, 15)
Press to go back to the preceding chapter or track.
- 16** Front Panel Display (20)
Indicates the playing time, etc.
- 17** PAUSE button (11, 15)
Pauses playing a disc.
- 18** STOP button (11, 15)
Stops playing a disc.
- 19** PLAY/SELECT button (10, 14)
Plays a disc.
- 20** PHONES connector (10, 14)
Connect the headphones to this connector.
- 21** PHONE LEVEL control (10, 14)
Adjusts the headphone volume.
- 22** DVD MENU button (13)
Displays the DVD menu on the TV screen.
- 23** RETURN button (17)
Press to return to the preceding selection screen, etc.

Rear Panel

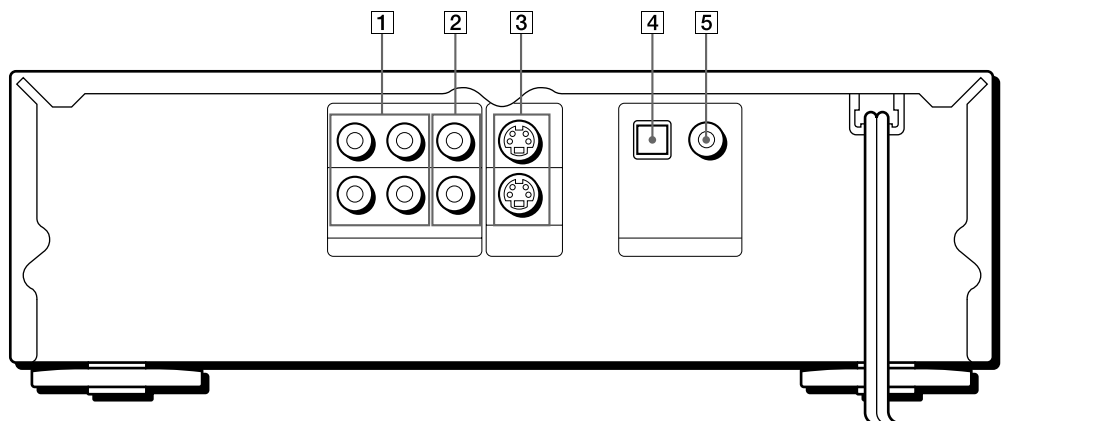

- 1** LINE OUT (AUDIO 1, 2) connectors (7)
Connects to the audio input connector on the TV or amplifier.
- 2** LINE OUT (VIDEO 1, 2) connectors (7)
Connects to the video input connector on the TV or monitor.
- 3** S VIDEO OUT 1, 2 connectors (7)
Connects to the S video input connector on the TV or VCR.
- 4** DIGITAL OUT (OPTICAL) connector (8)
Connects to an audio component using the optical digital connecting cord.
- 5** DIGITAL OUT (COAXIAL) connector (8)
Connects to an audio component using the coaxial digital connection cord.

Remote

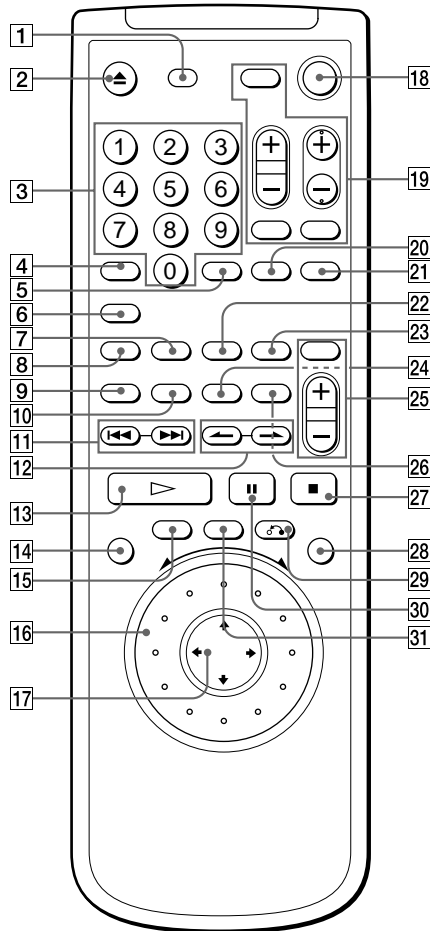

- 1** **DISPLAY button (18)**
Displays the current playing status on the TV screen.
- 2** **▲OPEN/CLOSE button (11, 15)**
Opens or closes the disc tray.
- 3** **Number buttons (11, 15)**
Selects the items or settings.
- 4** **SEARCH MODE button (11, 15)**
Press to select the unit for search (track, index, etc.)
- 5** **ENTER button**
Executes the items or settings.
- 6** **DNR button (26)**
Reduces the picture noise.
- 7** **PROGRAM button (24)**
Press to execute the program play.
- 8** **SHUFFLE button (24)**
Press to execute the shuffle play.
- 9** **AUDIO CHANGE button (27)**
Changes the sound while playing a DVD or VIDEO CD.
- 10** **ANGLE CHANGE button (29)**
Changes the angles when playing a DVD.
- 11** **◀◀/▶▶PREV/NEXT buttons (11, 15)**
Press to go to the next chapter or track or to go back to the preceding chapter or track.
- 12** **◀/▶ INDEX SEARCH buttons (15)**
Press to go to the next index or to go back to the preceding index.
- 13** **▷PLAY/SELECT button (11, 15)**
Plays a disc.
- 14** **SET UP button (29, 34)**
Displays the setup display on the TV screen to set or adjust the items.
- 15** **TITLE button (13)**
Displays the title menu on the TV screen.
- 16** **Click shuttle (12, 16)**
Changes the playback speed.
- 17** **◀/▲/▼/▶/ENTER button**
Selects and executes the items or settings.
- 18** **POWER button (10, 14)**
Turns on and off the power of the player.
- 19** **TV operation buttons (32)**
Controls Sony TVs.
- 20** **CLEAR button (22-25)**
Cancels the number selected with the number buttons.
- 21** **TIME button (20, 21)**
Displays the playing time of the disc, etc., on the front panel display.
- 22** **REPEAT button (22)**
Press to execute the repeat play.
- 23** **A↔B button (23)**
Press to execute the A↔B repeat play.
- 24** **SUBTITLE CHANGE button (28)**
Changes the subtitles when playing a DVD.
- 25** **Amplifier operation buttons (33)**
Controls Sony (AV) amplifiers.
- 26** **SUBTITLE ON/OFF button (28)**
Turns the subtitles on and off when playing a DVD.
- 27** **■STOP button (11, 15)**
Stops playing a disc.
- 28** **JOG button/indicator (12, 16)**
Press to play a disc frame by frame.
- 29** **↶RETURN button (17)**
Press to return to the preceding selection screen, etc.
- 30** **■PAUSE button (11, 15)**
Pauses playing a disc.
- 31** **DVD MENU button (13)**
Displays the DVD menu on the TV screen.

Setup Display Item List

Default settings are underlined.

LANGUAGE SETUP (page 35)

- OSD — ENGLISH
 - CHINESE
- DVD MENU — ENGLISH
 - CHINESE
 - SPANISH
 - PORTUGUESE
 - JAPANESE
 - FRENCH
 - GERMAN
 - ITALIAN
 - DUTCH
 - OTHERS →
- AUDIO — ORIGINAL
 - (same as DVD MENU)
- SUBTITLE — AUDIO FOLLOW
 - (same as DVD MENU)

1 INITIAL SETUP 1 (page 36)

- TV TYPE — 16:9
 - 4:3 LETTER BOX
 - 4:3 PAN SCAN
- COLOR SYSTEM — AUTO
 - PAL
 - NTSC
- AUTO PLAY — OFF
 - TIMER
 - DEMO1
 - DEMO2
- DIMMER — BRIGHT
 - DARK
 - OFF
- BACKGROUND — BLUE
 - BLACK
- SCREEN SAVER — ON
 - OFF
- PARENTAL CONTROL (page 29)

2 INITIAL SETUP 2 (page 37)

- TRACK SELECTION
 - OFF
 - AUTO
- SURROUND — ON
 - OFF
- DIGITAL OUT — PCM
 - DOLBY DIGITAL / PCM
- AUDIO DRC — OFF
 - ON
- AUDIO ATT — OFF
 - ON

Language Code List

For details, see page 35.

The language spellings conform to the ISO 639: 1988 (E/F) standard.

Code	Language	Code	Language	Code	Language	Code	Language
1027	Afar	1186	Scots Gaelic	1350	Malayalam	1513	Siswati
1028	Abkhazian	1194	Galician	1352	Mongolian	1514	Sesotho
1032	Afrikaans	1196	Guarani	1353	Moldavian	1515	Sundanese
1039	Amharic	1203	Gujarati	1356	Marathi	1516	Swedish
1044	Arabic	1209	Hausa	1357	Malay	1517	Swahili
1045	Assamese	1217	Hindi	1358	Maltese	1521	Tamil
1051	Aymara	1226	Croatian	1363	Burmese	1525	Telugu
1052	Azerbaijani	1229	Hungarian	1365	Nauru	1527	Tajik
1053	Bashkir	1233	Armenian	1369	Nepali	1528	Thai
1057	Byelorussian	1235	Interlingua	1376	Dutch	1529	Tigrinya
1059	Bulgarian	1239	Interlingue	1379	Norwegian	1531	Turkmen
1060	Bihari	1245	Inupiak	1393	Occitan	1532	Tagalog
1061	Bislama	1248	Indonesian	1403	(Afan) Oromo	1534	Setswana
1066	Bengali; Bangla	1253	Icelandic	1408	Oriya	1535	Tonga
1067	Tibetan	1254	Italian	1417	Punjabi	1538	Turkish
1070	Breton	1257	Hebrew	1428	Polish	1539	Tsonga
1079	Catalan	1261	Japanese	1435	Pashto; Pushto	1540	Tatar
1093	Corsican	1269	Yiddish	1436	Portuguese	1543	Twi
1097	Czech	1283	Javanese	1463	Quechua	1557	Ukrainian
1103	Welsh	1287	Georgian	1481	Rhaeto-Romance	1564	Urdu
1105	Danish	1297	Kazakh	1482	Kirundi	1572	Uzbek
1109	German	1298	Greenlandic	1483	Romanian	1581	Vietnamese
1130	Bhutani	1299	Cambodian	1489	Russian	1587	Volapük
1142	Greek	1300	Kannada	1491	Kinyarwanda	1613	Wolof
1144	English	1301	Korean	1495	Sanskrit	1632	Xhosa
1145	Esperanto	1305	Kashmiri	1498	Sindhi	1665	Yoruba
1149	Spanish	1307	Kurdish	1501	Sangho	1684	Chinese
1150	Estonian	1311	Kirghiz	1502	Serbo-Croatian	1697	Zulu
1151	Basque	1313	Latin	1503	Singhalese	1703	Not specified
1157	Persian	1326	Lingala	1505	Slovak		
1165	Finnish	1327	Laothian	1506	Slovenian		
1166	Fiji	1332	Lithuanian	1507	Samoan		
1171	Faroese	1334	Latvian; Lettish	1508	Shona		
1174	French	1345	Malagasy	1509	Somali		
1181	Frisian	1347	Maori	1511	Albanian		
1183	Irish	1349	Macedonian	1512	Serbian		

Index

A

- A↔B Repeat 23
- Adjusting
 - volume 10, 14
- Angle 29
- AUDIO ATT 37
- AUDIO DRC 37
- AUTO PLAY 36
- Auto pause 20

B

- Batteries 6

C

- CD 14
- Changing
 - angles 29
 - sound 27
 - subtitles 28
- Chapter 5, 42
- Color system 9
- Connecting 6
- Continuous play
 - CD 14
 - DVD 10
 - VIDEO CD 14

D, E

- Display
 - front panel display 20
 - on-screen display 18
- Digital output 12, 37
- DNR 26
- Dolby Digital (AC-3) 8, 42
- DVD 10
- DVD menu 13
- DVD menu language 35

F, G

- Fast Forward 12, 16
- Fast Reverse 12, 16
- Front panel display
 - CD 20
 - DVD 20
 - VIDEO CD 20

H

- Handling discs 38
- Hi-speed search 11, 15
- Hooking up 6

I, J, K

- INITIAL SETUP 36

L, M, N

- LETTER BOX 36
- Locating
 - a specific point 11, 15
 - by monitoring 12, 16
 - by observing the TV screen 12, 16

O

- On-screen display
 - CD 19
 - DVD 18
 - language 35
 - VIDEO CD 19

P, Q

- PAN SCAN 36
- Parental control 29
- PBC functions 17
- PBC Playback 5, 17, 43
- Playback
 - Continuous Play 10, 14
 - Program Play 24
 - Repeat Play 22
 - Shuffle Play 24
 - Program Play 24

R

- Remote control 6, 32
- Repeating
 - a specific portion 23
 - current title, chapter or track 22
 - disc 22
- Resume Play 26

S

- Scene 5
- Scene Search 15
- Searching. *See* Locating.
- Setup display
 - INITIAL SETUP 36
 - usage 34
- Shuffle Play 24
- Slow-motion Play 12, 16
- S video output 7
- Subtitles
 - changing 28
 - turning on and off 28

T

- Title 5, 43
- Title menu 13
- Track 5, 43
- Troubleshooting 39

U

- Usable discs 4

V, W, X, Y, Z

- VIDEO CD 14

