

SONY®

3-074-928-11(2)

CD/DVD Player

Operating Instructions



DVP-K370

© 2002 Sony Corporation

WARNING

To prevent fire or shock hazard, do not expose the unit to rain or moisture. To avoid electrical shock, do not open the cabinet. Refer servicing to qualified personnel only. Mains lead must only be changed at a qualified service shop.

CAUTION

The use of optical instruments with this product will increase eye hazard. As the laser beam used in this CD/DVD player is harmful to eyes, do not attempt to disassemble the cabinet. Refer servicing to qualified personnel only.

Precautions

Safety

- The power requirements and power consumption of this unit are indicated on the back of the unit. Check that the unit's operating voltage is identical with your local power supply.

Power requirements and power consumption



- To prevent fire or shock hazard, do not place objects filled with liquids, such as vases, on the apparatus.

Installing

- Do not install the unit in an inclined position. It is designed to be operated in a horizontal position only.
- Keep the unit and discs away from equipment with strong magnets, such as microwave ovens, or large loudspeakers.
- Do not place heavy objects on the unit.

Welcome!

Thank you for purchasing this Sony CD/DVD Player. Before operating this player, please read this manual thoroughly and retain it for future reference.

Precautions

On safety

- Caution – The use of optical instruments with this product will increase eye hazard.
- Should any solid object or liquid fall into the cabinet, unplug the player and have it checked by qualified personnel before operating it any further.

On power sources

- The player is not disconnected from the AC power source (mains) as long as it is connected to the wall outlet, even if the player itself has been turned off.
- If you are not going to use the player for a long time, be sure to disconnect the player from the wall outlet. To disconnect the AC power cord (mains lead), grasp the plug itself; never pull the cord.

On placement

- Place the player in a location with adequate ventilation to prevent heat build-up in the player.
- Do not place the player on a soft surface such as a rug that might block the ventilation holes.
- Do not place the player in a location near heat sources, or in a place subject to direct sunlight, excessive dust, or mechanical shock.

On operation

- If the player is brought directly from a cold to a warm location, or is placed in a very damp room, moisture may condense on the lenses inside the player. Should this occur, the player may not operate properly. In this case, remove the disc and leave the player turned on for about half an hour until the moisture evaporates.
- When you move the player, take out any discs. If you don't, the disc may be damaged.

On adjusting volume

Do not turn up the volume while listening to a section with very low level inputs or no audio signals. If you do, the speakers may be damaged when a peak level section is played.

On cleaning

Clean the cabinet, panel, and controls with a soft cloth slightly moistened with a mild detergent solution. Do not use any type of abrasive pad, scouring powder or solvent such as alcohol or benzine.

If you have any questions or problems concerning your player, please consult your nearest Sony dealer.

On cleaning discs

Do not use a commercially available cleaning disc. It may cause a malfunction.

IMPORTANT NOTICE

Caution: This player is capable of holding a still video image or on-screen display image on your television screen indefinitely. If you leave the still video image or on-screen display image displayed on your TV for an extended period of time you risk permanent damage to your television screen. Projection televisions are especially susceptible to this.





Table of Contents

WARNING	2
Welcome!	2
Precautions	3
About this Manual	6
This Player Can Play the Following Discs	6
Notes about the Discs	7
Index to Parts and Controls	8
Guide to the Control Menu Display	12
<hr/>	
Simple Start Guide	15
Quick Overview	15
Step 1: Unpacking	15
Step 2: Inserting Batteries into the Remote	15
Step 3: TV Hookups	16
Step 4: Playing a Disc	17
<hr/>	
Hookups	18
Hooking Up the Player	18
Step 1: Connecting the Video Cords	18
Step 2: Connecting the Audio Cords	20
Step 3: Connecting the Power Cord	25
Step 4: Quick Setup	25
<hr/>	
Playing Discs	28
Playing Discs	28
Searching for a Particular Point on a Disc (Search, Scan, Slow-motion Play, Freeze Frame)	30
Resuming Playback from the Point Where You Stopped the Disc (Multi-disc Resume)	31
Using the DVD's Menu	32
Playing VIDEO CDs with PBC Functions (PBC Playback)	32
Playing an MP3 Audio Track	33
Various Play Mode Functions (Programme Play, Shuffle Play, Repeat Play, A-B Repeat Play)	35
<hr/>	
Searching for a Scene	40
Searching for a Title/Chapter/Track/Index/Scene (Search mode)	40
Searching by Scene (PICTURE NAVIGATION)	41
<hr/>	
Enjoying Karaoke	43
Using Karaoke	43
Selecting the Vocals (Vocal Select)	44
<hr/>	
Viewing Information About the Disc	46
Checking the Playing Time and Remaining Time	46
Checking the Play Information	48

Sound Adjustments	50
Changing the Sound	50
TV Virtual Surround Settings (TVS)	51
<hr/>	
Enjoying Movies	53
Changing the Angles	53
Displaying the Subtitles	53
Adjusting the Picture Quality (BNR)	54
Adjusting the Playback Picture (CUSTOM PICTURE MODE)	55
Enhancing the Playback Picture (DIGITAL VIDEO ENHANCER)	56
<hr/>	
Using Various Additional Functions	58
Locking Discs (CUSTOM PARENTAL CONTROL, PARENTAL CONTROL)	58
Controlling Your TV or AV Amplifier (Receiver) with the Supplied Remote	62
<hr/>	
Settings and Adjustments	64
Using the Setup Display	64
Setting the Display or Sound Track Language (LANGUAGE SETUP)	65
Settings for the Display (SCREEN SETUP)	66
Custom Settings (CUSTOM SETUP)	67
Settings for the Sound (AUDIO SETUP)	69
<hr/>	
Additional Information	71
Troubleshooting	71
Self-diagnosis Function (When letters/numbers appear in the display)	73
Glossary	74
Specifications	75
Language Code List	76
Index	77



About this Manual

- Instructions in this manual describe the controls on the remote. You can also use the controls on the player if they have the same or similar names as those on the remote.
- Displays on the screen are slightly different depending upon where the model is sold.
- The meaning of the icons used in this manual is described below:

Icon	Meaning
	Functions available for DVD VIDEOS or DVD-Rs/DVD-RWs in video mode
	Functions available for VIDEO CDs or CD-Rs/CD-RWs in video CD format
	Functions available for DATA CDs (CD-ROMs/CD-Rs/CD-RWs containing MP3* audio tracks)
	Functions available for music CDs or CD-Rs/CD-RWs in music CD format

* MP3 (MPEG 1 Audio Layer 3) is a standard format defined by ISO/MPEG which compresses audio data.

This Player Can Play the Following Discs

Format of discs	
DVD VIDEO	
VIDEO CD	
Music CD	

The “DVD VIDEO” logo is a trademark.

Region code

Your player has a region code printed on the back of the unit and only will play DVD VIDEO discs (playback only) labelled with identical region codes. This system is used to protect copyrights.

DVDs labelled  will also play on this player.

If you try to play any other DVD, the message “Playback prohibited by area limitations.” will appear on the TV screen. Depending on the DVD, no region code indication may be labelled even though playing the DVD is prohibited by area restrictions.



Example of discs that the player cannot play

The player cannot play the following discs:

- All CD-ROMs (including PHOTO CDs)/CD-Rs/CD-RWs other than those recorded in the following formats:
 - music CD format
 - video CD format
 - MP3 format that conforms to ISO9660* Level 1/Level 2, or its extended format, Joliet
- Data part of CD-Extras
- DVD-RWs in VR mode
- DVD-ROMs
- DVD Audio discs
- HD layer on Super Audio CDs
- * A logical format of files and folders on CD-ROMs defined by ISO (International Standard Organization).

Also, the player cannot play the following discs:

- A DVD with a different region code.
- A disc that has a non-standard shape (e.g., card, heart).
- A disc with paper or stickers on it.
- A disc that has the adhesive of cellophane tape or a sticker still left on it.

Note

Some CD-Rs, CD-RWs, DVD-Rs, or DVD-RWs (in video mode) cannot be played on this player due to the recording quality or physical condition of the disc, or the characteristics of the recording device. Furthermore, the disc will not play if it has not been correctly finalized. For more information, see the operating instructions for the recording device. Note that discs created in the Packet Write format cannot be played.

Note on playback operations of DVDs and VIDEO CDs

Some playback operations of DVDs and VIDEO CDs may be intentionally set by software producers. Since this player plays DVDs and VIDEO CDs according to the disc contents the software producers designed, some playback features may not be available. Also, refer to the instructions supplied with the DVDs or VIDEO CDs.

Copyrights

This product incorporates copyright protection technology that is protected by method claims of certain U.S. patents, other intellectual property rights owned by Macrovision Corporation, and other rights owners. Use of this copyright protection technology must be authorized by Macrovision Corporation, and is intended for home and other limited viewing uses only unless otherwise authorized by Macrovision Corporation. Reverse engineering or disassembly is prohibited.

Notes about the Discs

- To keep the disc clean, handle the disc by its edge. Do not touch the surface.



- Do not expose the disc to direct sunlight or heat sources such as hot air ducts, or leave it in a car parked in direct sunlight as the temperature may rise considerably inside the car.
- After playing, store the disc in its case.
- Clean the disc with a cleaning cloth. Wipe the disc from the centre out.



- Do not use solvents such as benzene, thinner, commercially available cleaners, or anti-static spray intended for vinyl LPs.

Index to Parts and Controls

For more information, refer to the pages indicated in parentheses.

Front panel

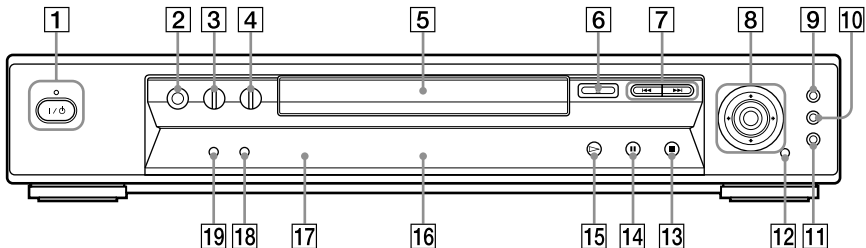

- | | |
|---|------------------------------------|
| 1 (on/standby) button/indicator (28)
Lights up in green when the power is on and lights up in red when the player is in standby mode. | 9 TOP MENU button (32) |
| 2 MIC (microphone) connector (43) | 10 MENU button (32) (33) |
| 3 MIC (microphone) LEVEL control (43) | 11 RETURN button (29) |
| 4 ECHO LEVEL control (43) | 12 DISPLAY button (12) |
| 5 Disc tray (28) | 13 (stop) button (29) |
| 6 (open/close) button (28) | 14 (pause) button (29) |
| 7 (previous/next) buttons (29) | 15 (play) button (28) |
| 8 ENTER buttons (32) | 16 Front panel display (9) |
| | 17 (remote sensor) (15) |
| | 18 SURROUND button (51) |
| | 19 PICTURE MODE button (55) |

Front panel display

When playing back a DVD

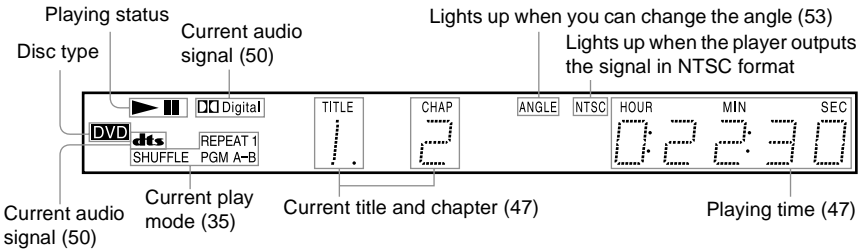

When playing back a VIDEO CD with Playback Control (PBC) (32)

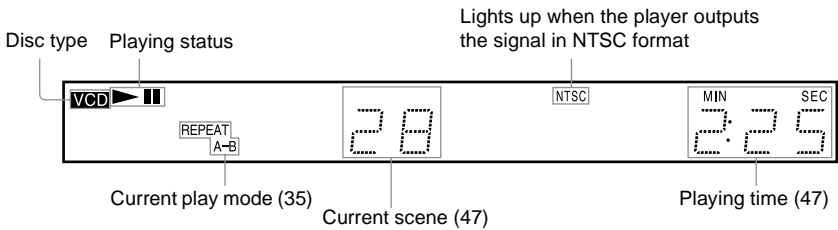

When playing back a CD, DATA CD (MP3 audio), or VIDEO CD (without PBC)

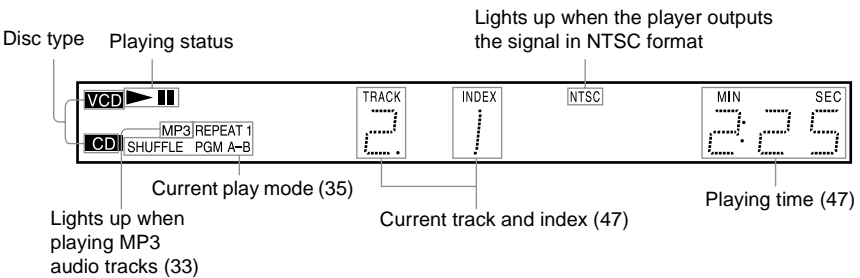

Rear panel

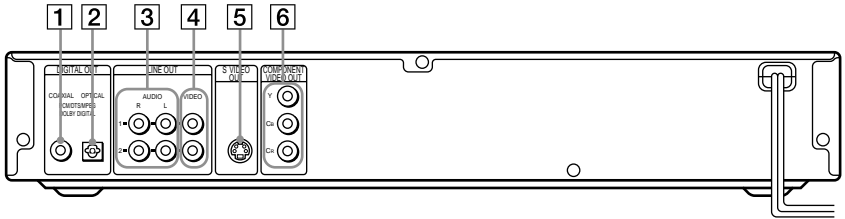

- | | |
|--|--|
| 1 DIGITAL OUT (COAXIAL) jack (22) (23) (24) | 4 LINE OUT (VIDEO) 1/2 jacks (18) |
| 2 DIGITAL OUT (OPTICAL) jack (22) (23) (24) | 5 S VIDEO OUT jack (18) |
| 3 LINE OUT L/R (AUDIO) 1/2 jacks (21) (22) (23) | 6 COMPONENT VIDEO OUT jacks (18) |

Remote

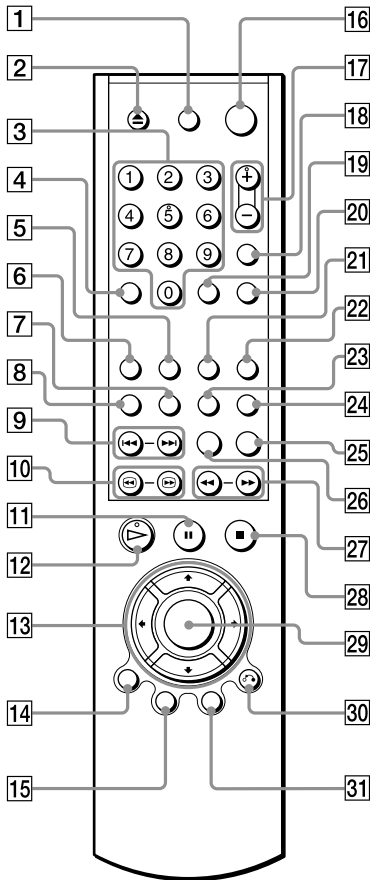

- 1** TV \mathbb{I}/\mathbb{O} (on/standby) button (62)
- 2** \blacktriangle OPEN/CLOSE button (29)
- 3** Number buttons (32)
The number 5 button has a tactile dot.*
- 4** CLEAR button (35)
- 5** SUBTITLE button (53)
- 6** AUDIO button (50)
- 7** REPEAT button (38)
- 8** VOCAL SELECT button (44)
- 9** $\mathbb{L}\mathbb{L}/\mathbb{R}\mathbb{R}$ PREV (previous)/NEXT buttons (29)
- 10** $\mathbb{L}\mathbb{L}\mathbb{L}\mathbb{L}/\mathbb{R}\mathbb{R}\mathbb{R}\mathbb{R}$ SEARCH/STEP buttons (30)
- 11** $\mathbb{L}\mathbb{L}$ PAUSE button (29)
- 12** \mathbb{R} PLAY button (28)
The \mathbb{R} button has a tactile dot.*
- 13** $\mathbb{L}/\mathbb{U}/\mathbb{D}/\mathbb{R}$ buttons (32)
- 14** DISPLAY button (12)
- 15** TOP MENU button (32)
- 16** \mathbb{I}/\mathbb{O} (on/standby) button (28)
- 17** VOL (volume) +/- buttons (62)
The + button has a tactile dot.*
- 18** TV/VIDEO button (62)
- 19** ENTER button (performs the same function as **29**)
- 20** TIME/TEXT button (46)
- 21** ANGLE button (53)
- 22** PICTURE NAVI (navigation) button (41)
- 23** SUR (surround) button (51)
- 24** PICTURE MODE button (55)
- 25** REPLAY button (29)
- 26** SEARCH MODE button (40)
- 27** $\mathbb{L}\mathbb{L}\mathbb{L}\mathbb{L}/\mathbb{R}\mathbb{R}\mathbb{R}\mathbb{R}$ SCAN/SLOW buttons (30)
- 28** \blacksquare STOP button (29)
- 29** ENTER button (25)
- 30** \mathbb{L} RETURN button (29)
- 31** MENU button (32) (33)

* Use the tactile dot as a reference when operating the player.

Guide to the Control Menu Display

Use the Control Menu to select a function and to view related information. Press DISPLAY repeatedly to turn on or change the Control Menu display as follows:

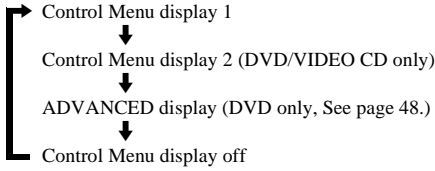

Hint

You can skip the ADVANCED display by setting "OFF" under "ADVANCED" in the Control Menu (page 48).

Control Menu Display

The Control Menu display 1 and 2 will show different items depending on the disc type. For details about each item, please refer to the pages in the parentheses.



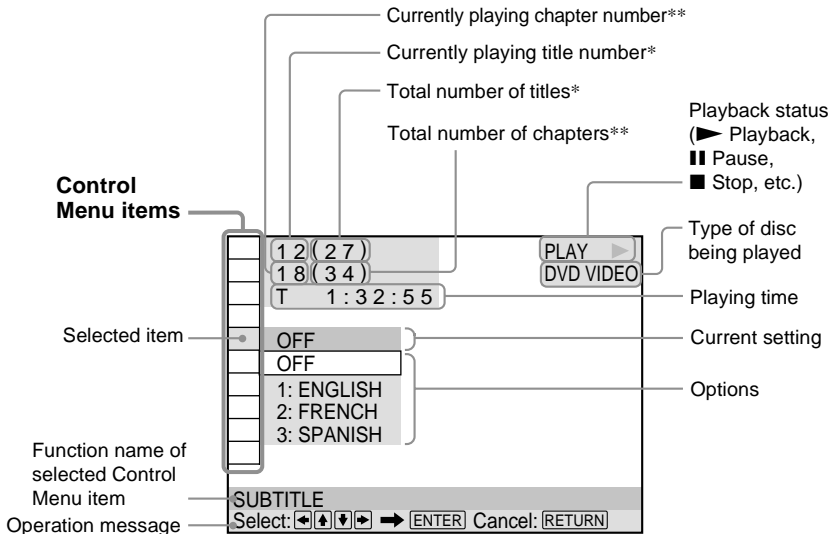













Example: Control Menu display 1 when playing a DVD







* Displays the scene number for VIDEO CDs (PBC is on), track number for VIDEO CDs/CDs, album number for DATA CDs.

** Displays the index number for VIDEO CDs/CDs, MP3 audio track number for DATA CDs.



List of Control Menu Items

Item	Item Name, Function, Relevant Disc Type
	TITLE (page 40)/SCENE (page 40)/TRACK (page 40) Selects the title, scene, or track to be played. DVD VCD
	CHAPTER (page 40)/INDEX (page 40) Selects the chapter or index to be played. DVD VCD
	ALBUM (page 33) Selects the album to be played. DATA CD
	TRACK (page 40) Selects the track to be played. CD DATA CD
	INDEX (page 40) Selects the index to be played. CD
	TIME/TEXT (page 40) Checks the elapsed time and the remaining playback time. Input the time code for picture and music searching. Displays the DVD/CD text or the DATA CD's track name. DVD VCD CD DATA CD
	AUDIO (page 50) Changes the audio setting. DVD VCD CD DATA CD
	SUBTITLE (page 53) Displays the subtitles. Changes the subtitle language. DVD
	ANGLE (page 53) Changes the angle. DVD
	TVS (TV Virtual Surround) (page 51) Selects the surround functions. DVD
	ADVANCED (page 48) Displays the information (bit rate or layer) of the disc currently playing. DVD
	PARENTAL CONTROL (page 58) Set to prohibit playback on this player. DVD VCD CD
	SETUP (page 64) QUICK Setup (page 25) Use Quick Setup to choose the desired language of the on-screen display, the aspect ratio of the TV and the audio output. CUSTOM Setup In addition to the Quick Setup setting, you can adjust other various settings. RESET Returns the settings in "SETUP" to the default setting. DVD VCD CD DATA CD
	PROGRAM (page 35) Selects the title, chapter, or track to play in the order you want. DVD VCD CD
	SHUFFLE (page 37) Plays the title, chapter, or track in random order. DVD VCD CD
	REPEAT (page 38) Plays the entire disc (all titles/all tracks/all albums) repeatedly or one title/chapter/track/album repeatedly. DVD VCD CD DATA CD
	A-B REPEAT (page 39) Specifies the parts you want to play repeatedly. DVD VCD CD

	<p>BNR (page 54) Adjusts the picture quality by reducing the “block noise” or mosaic like patterns that appear on your TV screen. DVD VCD</p>
	<p>CUSTOM PICTURE MODE (page 55) Adjusts the video signal from the player. You can select the picture quality that best suits the programme you are watching. DVD VCD</p>
	<p>DIGITAL VIDEO ENHANCER (page 56) Exaggerates the outline of the image to produce a sharper picture. DVD VCD</p>
	<p>PICTURE NAVIGATION (page 41) Divides the screen into 9 subscreens to help you find the scene you want quickly. DVD VCD</p>

Hint

The Control Menu icon indicator lights up in green

 →  when you select any item except “OFF,” (“TVS,” “PROGRAM,”

“SHUFFLE,” “REPEAT,” “A-B REPEAT,”

“BNR,” “DIGITAL VIDEO ENHANCER” only).

The “ANGLE” indicator lights up in green only when the angles can be changed. The “CUSTOM

PICTURE MODE” indicator lights up in green when any setting other than “STANDARD” is

selected.

Simple Start Guide

Quick Overview

A quick overview presented in this guide will give you enough information to start using the player for your enjoyment. To use the surround sound features of this player, refer to “Hookups” on page 18.

Notes

- You cannot connect this player to a TV that does not have a video input jack.
- Be sure to disconnect the power cord (mains lead) of each component before connecting.

Step 1: Unpacking

Check that you have the following items:

- Audio/video cord (pinplug × 3 ↔ pinplug × 3) (1)
- Remote commander (remote) (1)
- Size R6 (AA) batteries (2)

Step 2: Inserting Batteries into the Remote

You can control the player using the supplied remote. Insert two size R6 (AA) batteries by matching the ⊕ and ⊖ ends on the batteries to the markings inside the compartment. When using the remote, point it at the remote sensor  on the player.

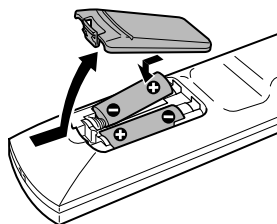

Notes

- Do not leave the remote in an extremely hot or humid place.
- Do not drop any foreign object into the remote casing, particularly when replacing the batteries.
- Do not expose the remote sensor to direct light from the sun or a lighting apparatus. Doing so may cause a malfunction.
- If you do not use the remote for an extended period of time, remove the batteries to avoid possible damage from battery leakage and corrosion.

Step 3: TV Hookups

Connect the supplied audio/video cord and the power cord (mains lead) in the order (1~3) shown below. Be sure to connect the power cord (mains lead) last.

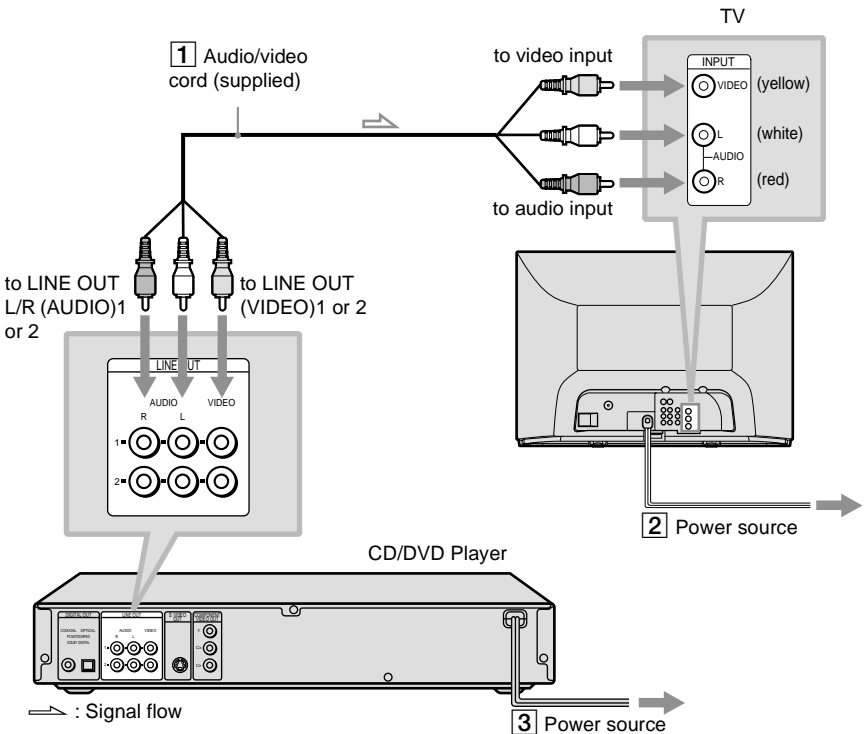

When connecting to a standard 4:3 screen TV

Depending on the disc, the image may not fit your TV screen.

If you want to change the aspect ratio, please refer to page 66.

To change the colour system

The colour system of the player is set to NTSC or PAL. If the on-screen display of the player does not appear on the TV, change the colour system of the player (PAL or NTSC) so that a picture appears on your TV. To change the colour system, hold **1/⏻** down for a few seconds while pressing **||** on the player.

💡 Hints

- To check the current setting of the player's colour system, press **1/⏻** on the player or remote. The power indicator lights up in green. When "NTSC" appears on the front panel display, the colour system of the player is set to NTSC. When "NTSC" does not appear, the colour system is set to PAL.
- When connecting to a monaural TV, use a stereo-mono conversion cord (not supplied). Connect the LINE OUT (VIDEO) 1/2 jacks on the player to the TV's video input jack, and connect the LINE OUT L/R (AUDIO) 1/2 jacks to the TV's audio input jack.

Step 4: Playing a Disc

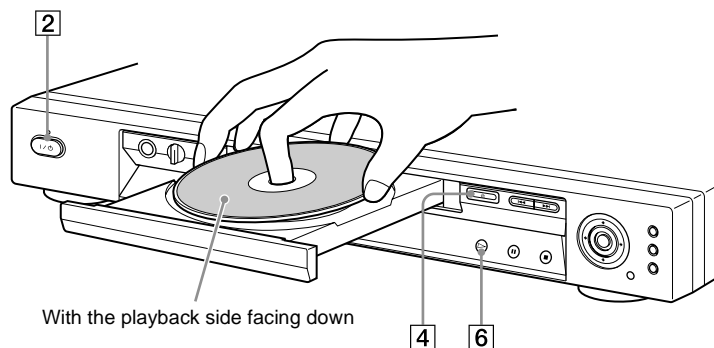

- 1 Turn on the TV.
- 2 Press **I/⏻** on the player.
- 3 Switch the input selector on your TV so that the signal from the player appears on the TV screen.
- 4 Press **⏏** on the player to open the disc tray.
- 5 Place the disc on the tray with the playback side facing down.
- 6 Press **▶**.

The disc tray closes and the player begins playing the disc.

After Step 6

Depending on the disc, a menu may be displayed on the TV screen. If so, select the item you want from the menu and play the DVD (page 32) or VIDEO CD disc (page 32).

To stop playing

Press **■**.

To remove the disc

Press **⏏**.

To turn off the player

Press **I/⏻**. The player enters standby mode and the power indicator lights up in red.

Hooking Up the Player

Follow Steps 1 to 4 to hook up and adjust the settings of the player.
 Before you start, disconnect the power cords (mains leads), check that you have all of the supplied accessories, and insert the batteries into the remote (page 15).

Notes

- Plug cords securely to prevent unwanted noise.
- Refer to the instructions supplied with the components to be connected.

Step 1: Connecting the Video Cords

Connect this player to your TV monitor, projector, or AV amplifier (receiver) using a video cord.
 Select one of the patterns **A** through **C**, according to the input jack on your TV monitor, projector, or AV amplifier (receiver).

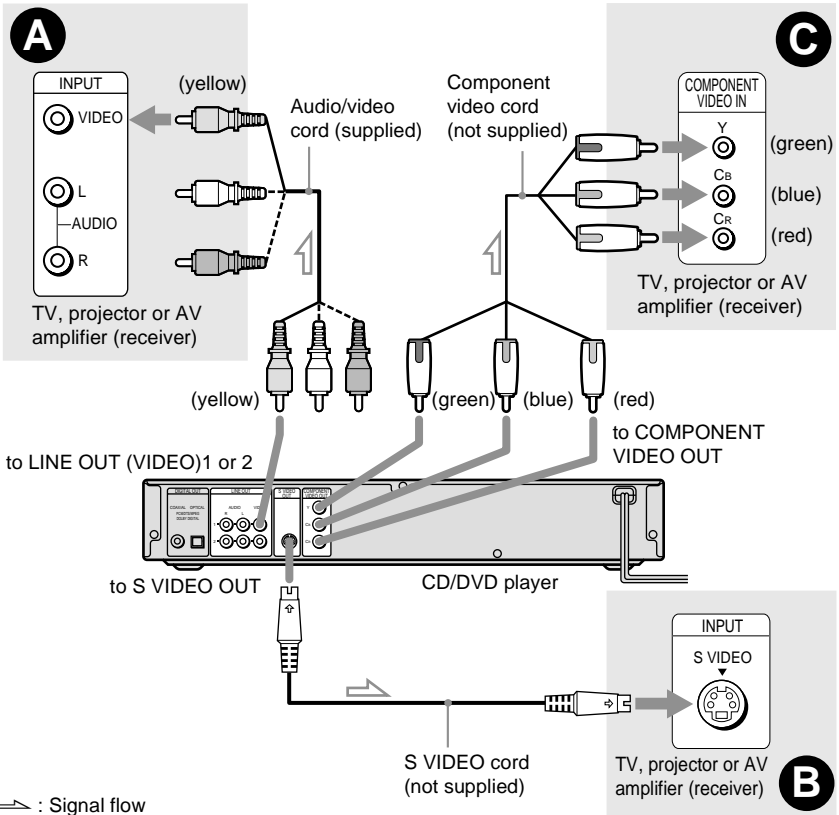

A If you are connecting to a video input jack

Connect the yellow plug of the audio/video cord (supplied) to the yellow (video) jacks. You will enjoy standard quality images.

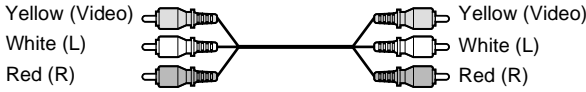

Use the red and white plugs to connect to the audio input jacks (page 21). (Do this if you are connecting to a TV only.)

B If you are connecting to an S VIDEO input jack

Connect an S VIDEO cord (not supplied). You will enjoy high quality images.



C If you are connecting to a monitor, projector, or AV amplifier (receiver) having component video input jacks (Y, C_B, C_R)

Connect the component via the COMPONENT VIDEO OUT jacks using a component video cord (not supplied) or three video cords (not supplied) of the same kind and length. You will enjoy accurate colour reproduction and high quality images.

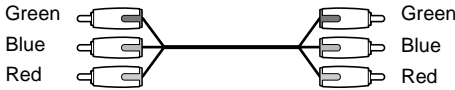

Notes

- You can switch the player's colour system to match the colour system of the connected TV (page 16).
- Do not connect the player to a VCR. If you pass the player signals via the VCR, you may not receive a clear image on the TV screen. If your TV only has one audio/video input jack, connect the player to this jack.

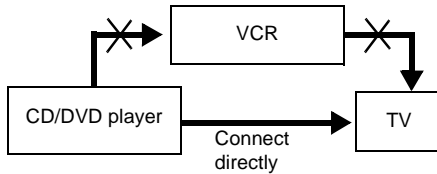

Step 2: Connecting the Audio Cords

Refer to the chart below to select the connection that best suits your system. Be sure to also read the instructions for the components you wish to connect.

Select a connection

Select one of the following connections, **A** through **D**.

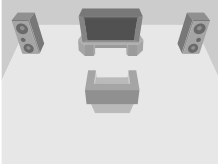
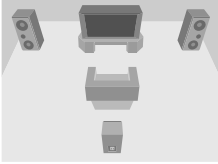
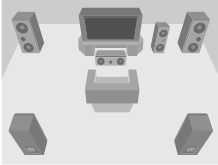
Components to be connected	Connection	Your setup
TV • Surround effects: TVS DYNAMIC (page 52), TVS WIDE (page 52)	A (page 21)	example 
Stereo amplifier (receiver) and two speakers • Surround effects: TVS STANDARD (page 52) or MD deck/DAT deck • Surround effects: none	B (page 22)	example 
AV amplifier (receiver) having a Dolby* Surround (Pro Logic) decoder and 3 to 6 speakers • Surround effects: Dolby Surround (Pro Logic) (page 74)	C (page 23)	example 
AV amplifier (receiver) with a digital input jack having a Dolby Digital, MPEG audio, or DTS** decoder and 6 speakers • Surround effects: Dolby Digital (5.1ch) (page 74), DTS (5.1ch) (page 74), MPEG audio (5.1ch) (page 74)	D (page 24)	example 

* Manufactured under license from Dolby Laboratories. "Dolby," "Pro Logic," and the double-D symbol are trademarks of Dolby Laboratories.

** "DTS" and "DTS Digital Out" are trademarks of Digital Theater Systems, Inc.

A Connecting to your TV

This connection will use your TV speakers for sound.

CD/DVD player

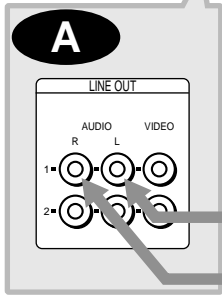
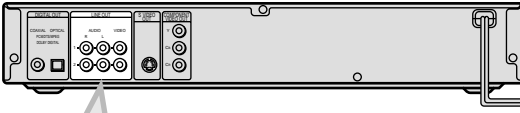

to LINE OUT L/R
(AUDIO) 1 or 2

→ : Signal flow

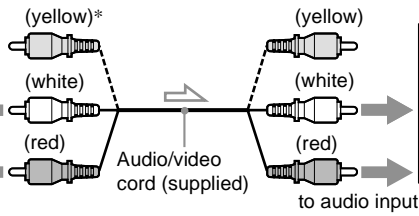

* The yellow plug is used for video signals (page 18).

Hint

When connecting to a monaural TV, use a stereo-mono conversion cord (not supplied). Connect the LINE OUT L/R (AUDIO) 1/2 jacks to the TV's audio input jack.

B Connecting to a stereo amplifier (receiver) and 2 speakers/Connecting to an MD deck or DAT deck

If the stereo amplifier (receiver) has audio input jacks L and R only, use **B-1**. If the amplifier (receiver) has a digital input jack, or when connecting to an MD deck or DAT deck, use **B-2**. In this case, you can also connect the player directly to the MD deck or DAT deck without using your stereo amplifier (receiver).

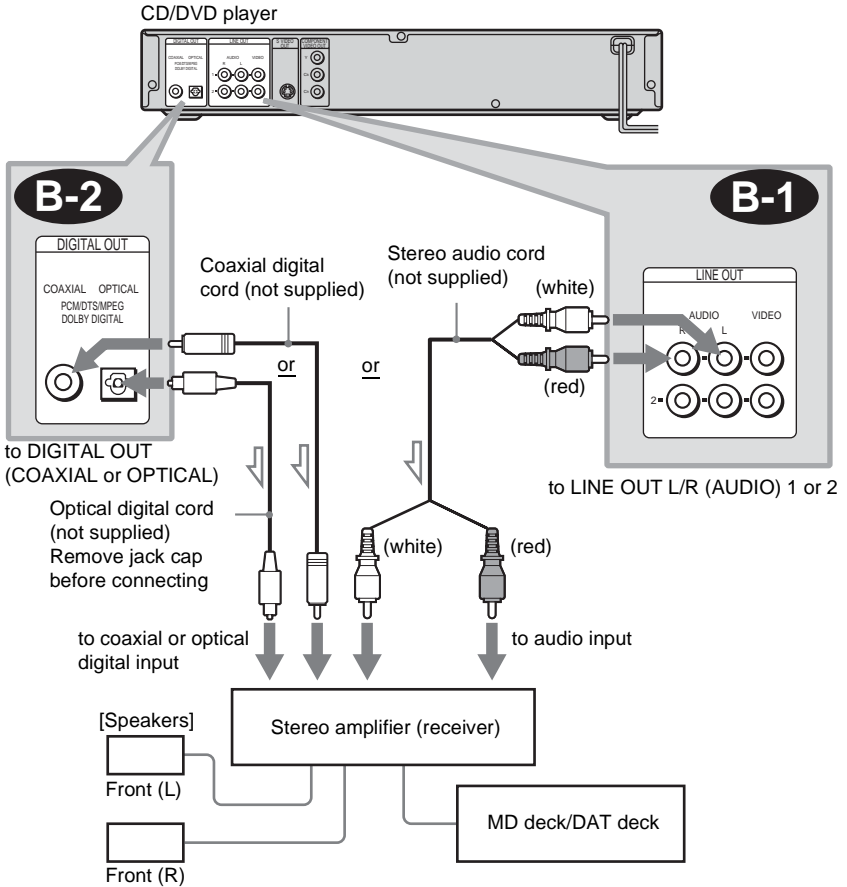

Hint

In connection **B-1**, you can use the supplied audio/video cord instead of using a separate stereo audio cord.

C Connecting to an AV amplifier (receiver) having a Dolby Surround (Pro Logic) decoder and 3 to 6 speakers

You can enjoy the Dolby Surround effects only when playing Dolby Surround audio or multi-channel audio (Dolby Digital) discs.

If your amplifier (receiver) has L and R audio input jacks only, use **C-1**. If your amplifier (receiver) has a digital input jack, use **C-2**.

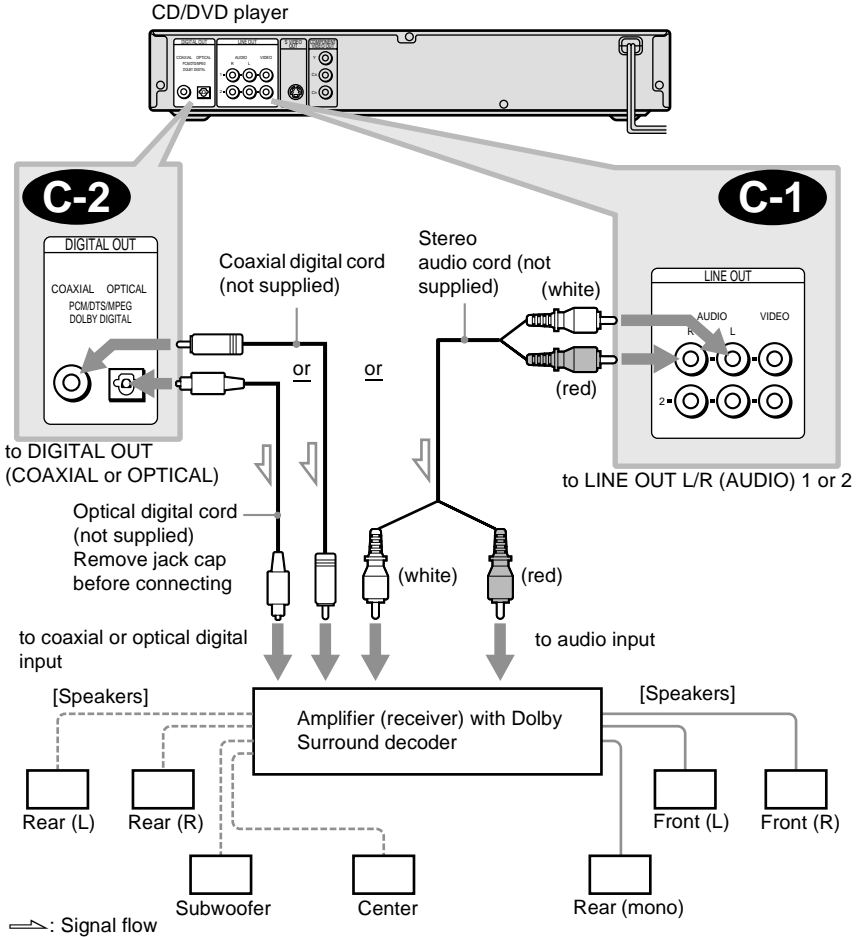

Note

When connecting 6 speakers, replace the monaural rear speaker with a center speaker, 2 rear speakers and a subwoofer.

D Connecting to an AV amplifier (receiver) with a digital input jack having a Dolby Digital, MPEG audio or DTS decoder and 6 speakers

This connection will allow you to use the Dolby Digital, MPEG audio or DTS decoder function of your AV amplifier (receiver). You are unable to enjoy the surround sound effects of this player.

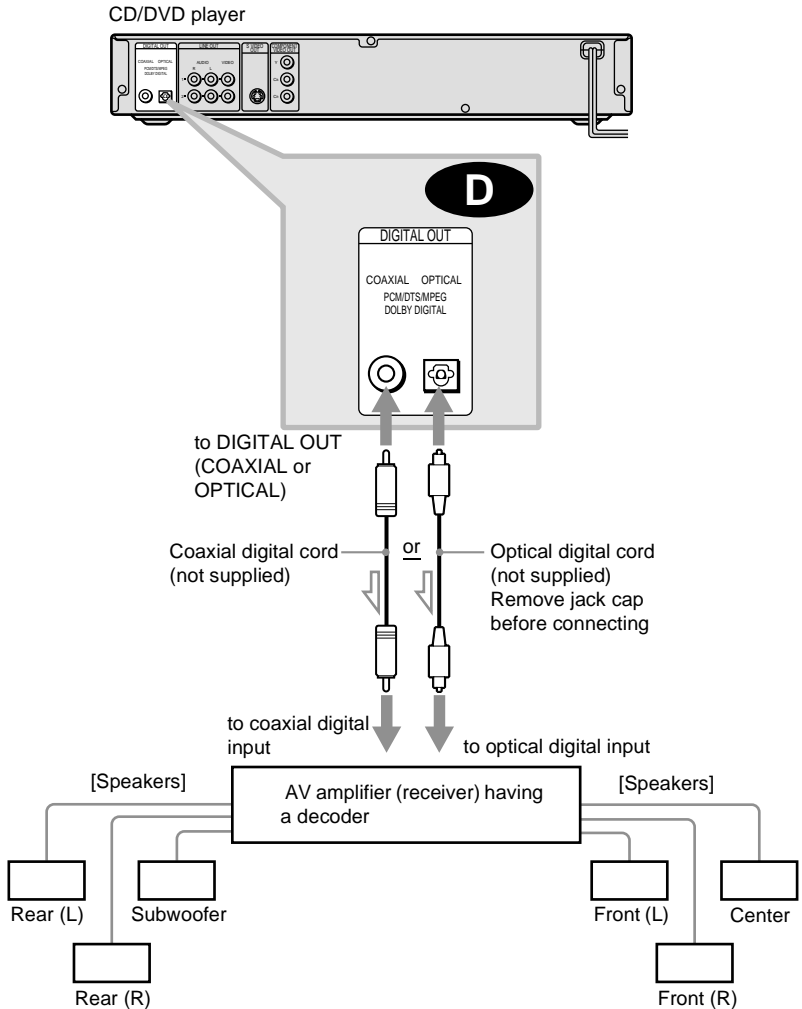

→ : Signal flow

Note

After you have completed the connection, be sure to set "DOLBY DIGITAL" to "DOLBY DIGITAL" and "DTS" to "ON" in Quick Setup (page 25). If your AV amplifier (receiver) has an MPEG audio decoder function, set "MPEG" to "MPEG" (page 70).

Step 3: Connecting the Power Cord

Plug the player and TV power cords into an AC outlet (mains).

Step 4: Quick Setup

Follow the steps below to make the minimum number of basic adjustments for using the player. To skip an adjustment, press **▶▶▶**. To return to the previous adjustment, press **◀◀◀**.

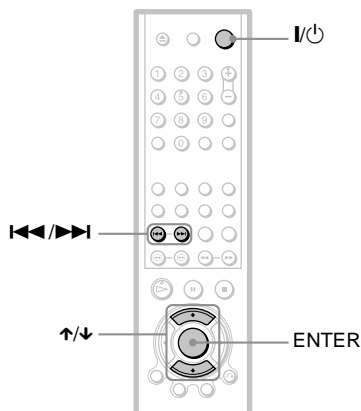

1 Turn on the TV.

2 Press **I/⏻**.

3 Switch the input selector on your TV so that the signal from the player appears on the TV screen.

“Press [ENTER] to run QUICK SETUP” appears at the bottom of the screen. If this message does not appear, select “QUICK” under “SETUP” in the Control Menu to run Quick Setup (page 65).

4 Press **ENTER** without inserting a disc.

The Setup Display for selecting the language used in the on-screen display appears.

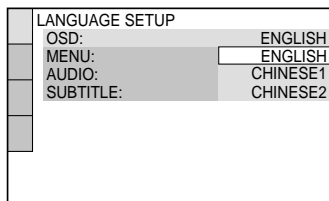

5 Press **↑/↓** to select a language.

The player uses the language selected here to display the menu and subtitles as well.

6 Press **ENTER**.

The Setup Display for selecting the aspect ratio of the TV to be connected appears.

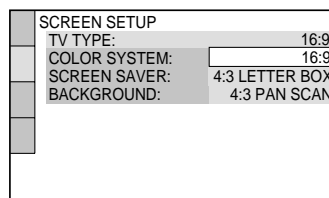

7 Press **↑/↓** to select the setting that matches your TV type.

- ◆ If you have a wide-screen TV or a 4:3 standard TV with a wide-screen mode
 - 16:9 (page 66)
- ◆ If you have a 4:3 standard TV
 - 4:3 LETTER BOX or 4:3 PAN SCAN (page 66)

8 Press **ENTER**.

The Setup Display for selecting the type of jack used to connect your amplifier (receiver) appears.

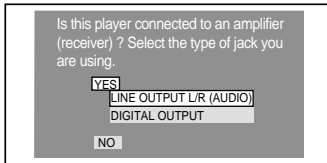

9 Press \uparrow/\downarrow to select the type of jack (if any) you are using to connect to an amplifier (receiver), then press ENTER.

Choose the item that matches the audio connection you selected on pages 21 to 24 (**A** through **D**).

A

- If you connect just a TV and nothing else, select “NO.” Quick Setup is finished and connections are complete.

B-1 C-1

- Select “LINE OUTPUT L/R (AUDIO).” Quick Setup is finished and connections are complete.

B-2 C-2 D

- Select “DIGITAL OUTPUT.” The Setup Display for “DOLBY DIGITAL” appears.

10 Press \uparrow/\downarrow to select the type of Dolby Digital signal you wish to send to your amplifier (receiver).

Choose the signal that matches the audio connection you selected on pages 22 to 24 (**B** through **D**).

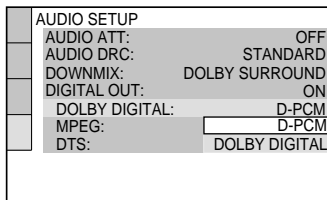

B-2 C-2

- D-PCM (page 70)

D

- DOLBY DIGITAL (only if the amplifier (receiver) has a Dolby Digital decoder) (page 70)

11 Press ENTER.

“DTS” is selected.

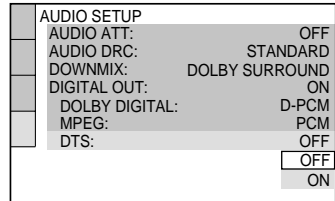

12 Press \uparrow/\downarrow to select whether or not you wish to send a DTS signal to your amplifier (receiver).

Choose the item that matches the audio connection you selected on pages 22 to 24 (**B** through **D**).

B-2 C-2

- OFF (page 70)

D

- ON (only if the amplifier (receiver) has a DTS decoder) (page 70)

13 Press ENTER.

Quick Setup is finished. All connections and setup operations are complete.

If your AV amplifier (receiver) has an MPEG audio decoder, adjust the “MPEG” setting (page 70).

Enjoying the surround sound effects

To enjoy the surround sound effects of this player or your amplifier (receiver), set the following items as described below for the audio connection you selected on pages 22 to 24 (**B** through **D**). Each of these is the default setting and does not need to be adjusted when you first connect the player. Refer to page 64 for using the Setup Display.

Audio Connection (pages 21 to 24)

A

- No additional settings are needed.

B-1 C-1

- Set “DOWNMIX” to “DOLBY SURROUND” (page 69)

- If the sound distorts even when the volume is turned down, set “AUDIO ATT” to “ON” (page 69)

B-2 **C-2** **D**

- Set “DOWNMIX” to “DOLBY SURROUND” (page 69)
- Set “DIGITAL OUT” to “ON” (page 69)

Playing Discs

Playing Discs **DVD** **VCD** **CD**

DATA CD

Depending on the DVD or VIDEO CD, some operations may be different or restricted. Refer to the operating instructions supplied with your disc.

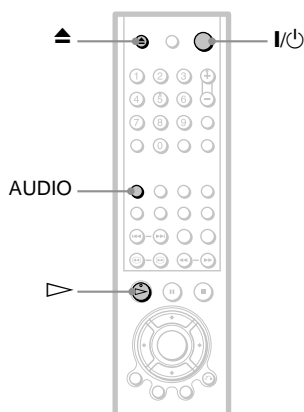
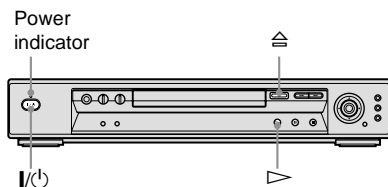

1 Turn on your TV.

2 Press **I/⏻**.

The player turns on and the power indicator lights up in green.

3 Switch the input selector on your TV so that the signal from the player appears on the TV screen.

◆ **When using an amplifier (receiver)**

Turn on the amplifier (receiver) and select the appropriate channel so that you can hear sound from the player.

4 Press **⏮** on the player, and place a disc on the disc tray.

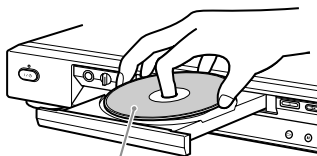

With the playback side facing down

5 Press **▶**.

The disc tray closes, and the player starts playback (continuous play). Adjust the volume on the TV or the amplifier (receiver).

Depending on the disc, a menu may appear on the TV screen. For DVDs, see page 32. For VIDEO CDs, see page 32.

To turn off the player

Press **I/⏻**. The player enters standby mode.

💡 Hint

The player will turn off automatically whenever you leave it in stop mode for more than 30 minutes (Auto Power off function).

Notes on playing DTS sound tracks on a CD

- When playing DTS-encoded CDs, excessive noise will be heard from the analog stereo jacks. To avoid possible damage to the audio system, the consumer should take proper precautions when the analog stereo jacks of the player are connected to an amplification system. To enjoy DTS Digital Surround™ playback, an external 5.1-channel decoder system must be connected to the digital jack of the player.
- Set the sound to “STEREO” using the **AUDIO** button when you play DTS sound tracks on a CD (page 50).
- Do not play DTS sound tracks without first connecting the player to an audio component having a built-in DTS decoder. The player outputs the DTS signal via the **DIGITAL OUT (COAXIAL or OPTICAL)** jack even if “DTS” in “**AUDIO SETUP**” is set to “OFF” in the Setup Display (page 70), and may affect your ears or cause your speakers to be damaged.

Notes on playing DVDs with a DTS sound track

- DTS audio signals are output only through the DIGITAL OUT (COAXIAL or OPTICAL) jack.
- When you play a DVD with DTS sound tracks, set “DTS” to “ON” in “AUDIO SETUP” (page 70).
- If you connect the player to audio equipment without a DTS decoder, do not set “DTS” to “ON” in “AUDIO SETUP” (page 70). A loud noise may come out from the speakers, affecting your ears or causing the speakers to be damaged.

Additional operations

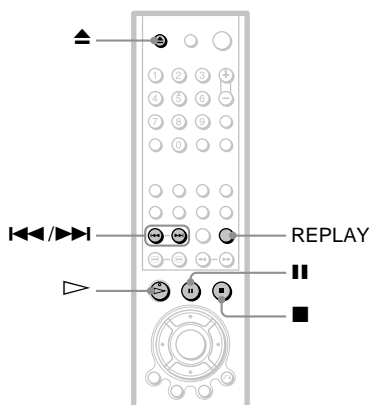

To	Operation
Stop	Press ■
Pause	Press
Resume play after pause	Press or ▷
Go to the next chapter, track, or scene in continuous play mode	Press ►►
Go back to the previous chapter, track, or scene in continuous play mode	Press ◄◄
Stop play and remove the disc	Press ▲
Replay the previous scene (DVD only)	Press REPLAY

Hint

The Replay function is useful when you want to review a scene or dialog that you missed.

Note

You may not be able to use the Replay function with some scenes.

Locking the disc tray (Child Lock)

You can lock the disc tray to prevent children from opening it.

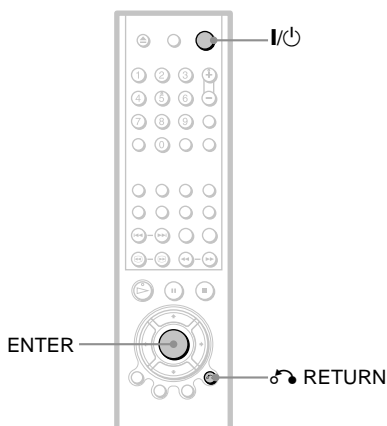

When the player is in standby mode, press RETURN, ENTER, and then I/Power on the remote.

The player turns on and “LOCKED” appears on the front panel display.

The ▲ button on the player or the remote does not work while the Child Lock is set.

To unlock the disc tray

When the player is in standby mode, press RETURN, ENTER, and then I/Power again.

Note

Even if you select “RESET” under “SETUP” in the Control Menu (page 65), the disc tray remains locked.

Searching for a Particular Point on a Disc (Search, Scan, Slow-motion Play, Freeze Frame)

You can quickly locate a particular point on a disc by monitoring the picture or playing back slowly.

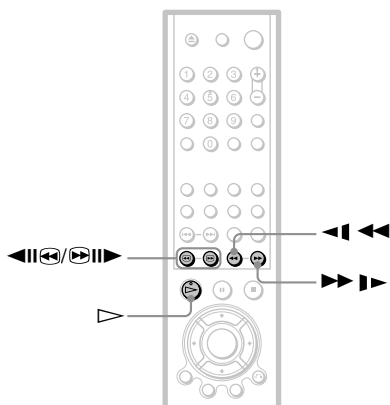

Note

Depending on the DVD/VIDEO CD, you may not be able to do some of the operations described.

Locating a point quickly (Search)

DVD VCD CD DATA CD

During playback, keep pressing **▶▶▶▶** to locate a point in the playback direction or keep pressing **◀◀◀◀** to locate a point in the opposite direction. When you find the point you want, release the button to return to normal playback speed.

Locating a point quickly by playing a disc in fast forward or fast reverse (Scan)

DVD VCD CD DATA CD

Press **◀◀◀◀** or **▶▶▶▶** while playing a disc. When you find the point you want, press **▷** to return to normal speed. Each time you press **◀◀◀◀** or **▶▶▶▶** during scan, the playback speed changes. Three speeds are

available. With each press the indication changes as follows:

Playback direction
×2▶ (DVD/CD only) → FF 1▶▶▶▶ → FF 2▶▶▶▶

Opposite direction
×2◀ (DVD only) → FR 1◀◀◀◀ → FR 2◀◀◀◀

The “×2▶”/“×2◀” playback speed is about twice the normal speed. The “FF 2▶▶▶▶”/“FR 2◀◀◀◀” playback speed is faster than “FF 1▶▶▶▶”/“FR 1◀◀◀◀”.

Watching frame by frame (Slow-motion play) **DVD VCD**

Press **◀◀◀◀** or **▶▶▶▶** when the player is in pause mode. To return to the normal speed, press **▷**.

Each time you press **◀◀◀◀** or **▶▶▶▶** during Slow-motion play, the playback speed changes. Two speeds are available. With each press the indication changes as follows:

Playback direction
SLOW 2▶▶ ↔ SLOW 1▶▶

Opposite direction (DVD only)
SLOW 2◀◀ ↔ SLOW 1◀◀

The “SLOW 2▶▶”/“SLOW 2◀◀” playback speed is slower than “SLOW 1▶▶”/“SLOW 1◀◀”.

Playing one frame at a time (Freeze Frame) **DVD VCD**

When the player is in the pause mode, press **▶▶▶▶** to go to the next frame. Press **◀◀◀◀** to go to the preceding frame (DVD only). If you hold the button down, you can view the frames in succession. To return to normal playback, press **▷**.

Resuming Playback from the Point Where You Stopped the Disc (Multi-disc Resume)

Resume) **DVD** **VCD**

The player stores the point where you stopped the disc for up to 40 discs and resumes playback the next time you insert the same disc. When you store a resume playback point for the 41st disc, the resume playback point for the first disc is deleted.

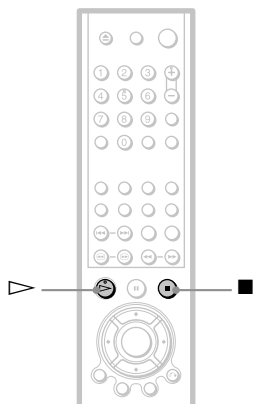

1 While playing a disc, press ■ to stop playback.

“RESUME” appears on the front panel display.

2 Press ▷.

The player starts playback from the point where you stopped the disc in Step 1.

Notes

- “MULTI-DISC RESUME” in “CUSTOM SETUP” must be set to “ON” (default) for this function to work (page 68).
- The resume playback point for the current disc is cleared when:
 - you change the play mode.
 - you change the settings on the Setup Display.
- Resume Play does not work during Shuffle Play and Programme Play.
- This function may not work with some discs.

💡 Hints

- To play from the beginning of the disc, press ■ twice, then press ▷.
- For CDs and DATA CDs, the player remembers the resume playback point for the current disc unless the disc tray is opened, the AC power cord (mains lead) is disconnected, or only for DATA CDs, the player enters standby mode.

Using the DVD's Menu **DVD**

A DVD is divided into long sections of a picture or a music feature called "titles." When you play a DVD which contains several titles, you can select the title you want using the TOP MENU button. When you play DVDs that allow you to select items such as the language for the subtitles and the language for the sound, select these items using the MENU button.

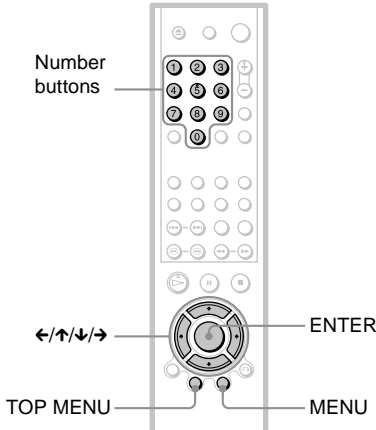

1 Press TOP MENU or MENU.

The disc's menu appears on the TV screen. The contents of the menu vary from disc to disc.

2 Press ←/↑/↓/→ or the number buttons to select the item you want to play or change.

3 Press ENTER.

Hint

The disc's menu also appears when the TOP MENU or MENU button on the player is pressed.

Playing VIDEO CDs with PBC Functions (PBC Playback)

VCD

PBC (Playback Control) allows you to play VIDEO CDs interactively by following the menu on the TV screen.

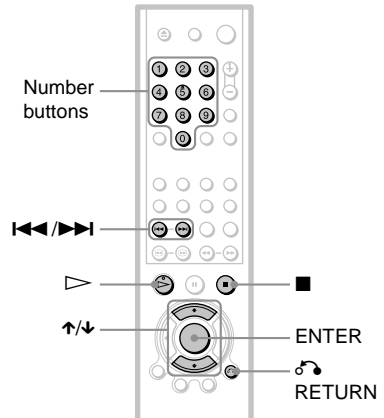

1 Start playing a VIDEO CD with PBC functions.

The menu for your selection appears.

2 Select the item number you want by pressing ↑/↓ or the number buttons.

3 Press ENTER.

4 Follow the instructions in the menu for interactive operations.

Refer to the instructions supplied with the disc, as the operating procedure may differ depending on the VIDEO CD.

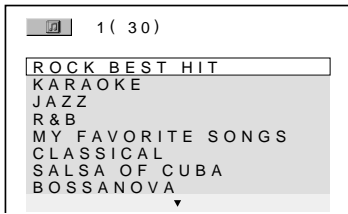

2 Select an album using \uparrow/\downarrow and press ENTER.

The list of tracks contained in the album appears.

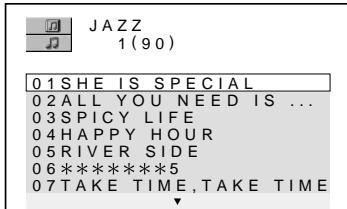

3 Select a track using \uparrow/\downarrow and press ENTER.

The selected track starts playing.
When a track or album is being played, its title is shaded.

To go to the next or previous page

Press \rightarrow or \leftarrow .

To return to the previous display

Press \curvearrowright RETURN.

To turn off the display

Press MENU.

Notes

- Only the letters in the alphabet and numbers can be used for album or track names. Anything else is displayed as “*.”
- ID3 tags cannot be displayed.

About MP3 audio tracks

You can play MP3 audio tracks on CD-ROMs, CD-Rs, or CD-RWs. However, the discs must be recorded according to ISO9660 level 1, level 2, or Joliet format for the player to recognize the tracks.

You can also play discs recorded in Multi Session.

See the instructions of the CD-R/RW device or recording software (not supplied) for details on the recording format.

To play a Multi Session CD

This player can play Multi Session CDs when an MP3 audio track is located in the first session. Any subsequent MP3 audio tracks, recorded in the later sessions, can also be played back.

When audio tracks and images in music CD format or video CD format are recorded in the first session, only the first session will be played back.

Notes

- If you put the extension “.MP3” to data not in MP3 format, the player cannot recognize the data properly and will generate a loud noise which could damage your speaker system.
- The player cannot play audio tracks in MP3PRO format.

The Playback order of MP3 audio tracks

The playback order of albums and tracks recorded on a DATA CD is as follows.

◆Structure of disc contents

Tree 1 Tree 2 Tree 3 Tree 4 Tree 5

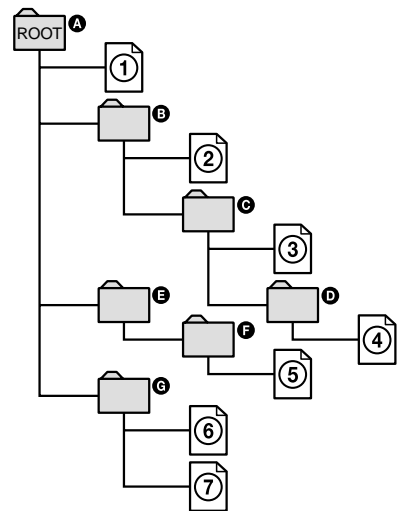

When you insert a DATA CD and press \blacktriangleright , the numbered tracks are played sequentially, from ① through ⑦. Any sub-albums/tracks contained within a currently selected album take priority over the next album in the same tree. (Example: ③ contains ④ so ④ is played before ⑤.)

When you press MENU and the list of MP3 albums appears (page 33), the albums are arranged in the following order: ① → ② → ③ → ④ → ⑤ → ⑥ → ⑦. Albums that do not contain tracks (such as album ⑥) do not appear in the list.

Hints

- If you add numbers (01, 02, 03, etc.) to the front of the track file names, the tracks will be played in that order.
- Since a disc with many trees takes longer to start playback, it is recommended that you create albums of no more than two trees.

Notes

- Depending on the software you use to create the DATA CD, the playback order may differ from the illustration above.
- The playback order above may not be applicable if there are more than a total of 200 albums and tracks in the DATA CD.
- The player can recognize up to 100 albums (the player will count just albums, including albums that do not contain MP3 audio tracks). The player will not play any albums beyond the first 100 albums. Of the first 100 albums, the player will play no more than a combined total of 200 albums and tracks.

Various Play Mode Functions (Programme Play, Shuffle Play, Repeat Play, A-B Repeat Play)

You can set the following play modes:

- Programme Play (page 35)
- Shuffle Play (page 37)
- Repeat Play (page 38)
- A-B Repeat Play (page 39)

Note

The play mode is cancelled when:

- you open the disc tray.
- the player enters standby mode by pressing \mathbb{I}/\mathbb{P} .

Creating your own programme (Programme Play) **DVD** **VCD** **CD**

You can play the contents of a disc in the order you want by arranging the order of the titles, chapters, or tracks on the disc to create your own programme. You can programme up to 99 titles, chapters, and tracks.

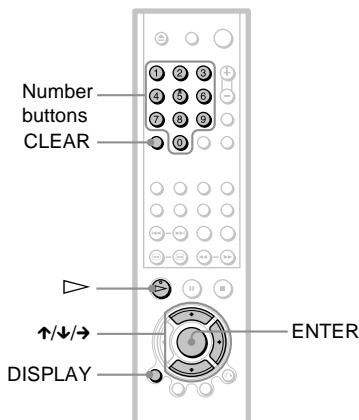

- 1 Press **DISPLAY** twice (when playing a CD, press once).

The Control Menu appears.

- 2 Press **↑/↓** to select  (PROGRAM), then press **ENTER**.

The options for "PROGRAM" appear.

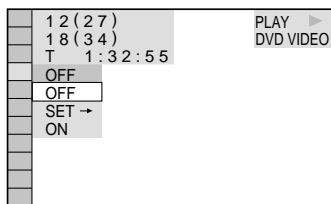

- 3 Press **↑/↓** to select "SET →," then press **ENTER**.

"TRACK" is displayed when you play a VIDEO CD or CD.

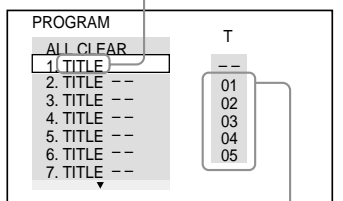

Selected title and chapter

- ◆ When playing a VIDEO CD or CD

For example, select track "02."

Press **↑/↓** or the number buttons to select "02" under "T," then press **ENTER**.

Selected track

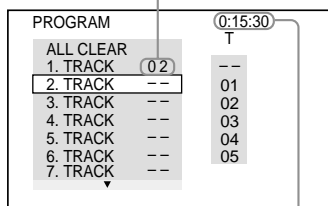

Total time of the programmed tracks

- 4 Press **→**.

The cursor moves to the title or track row "T" (in this case, "01").

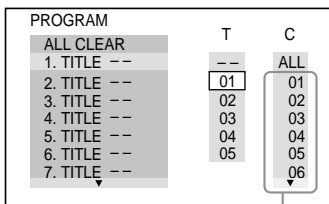

Chapters recorded on a disc

- 5 Select the title, chapter, or track you want to programme.

- ◆ When playing a DVD

For example, select chapter "03" of title "02."

Press **↑/↓** or the number buttons to select "02" under "T," then press **ENTER**.

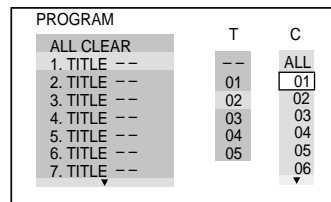

Next, press **↑/↓** or the number buttons to select "03" under "C," then press **ENTER**.

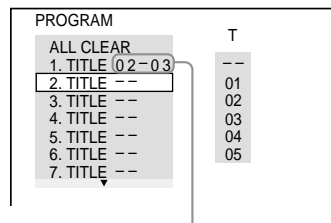

- 6 To programme other titles, chapters, or tracks, repeat Steps 4 to 5.
The programmed titles, chapters, and tracks are displayed in the selected order.
- 7 Press **▷** to start Programme Play.
Programme Play begins.
When the programme ends, you can restart the same programme again by pressing **▷**.

To return to normal play

Press **CLEAR**, or select "OFF" in Step 3. To play the same programme again, select "ON" in Step 3 and press **ENTER**.

To turn off the display

Press DISPLAY repeatedly until the display is turned off.

To change or cancel a programme

- 1 Follow Steps 1 and 3 of “Creating your own programme (Programme Play).”
- 2 Select the programme number of the title, chapter, or track you want to change or cancel using \uparrow/\downarrow or the number buttons, and press \rightarrow .
- 3 Follow Step 5 for new programming. To cancel a programme, select “-” under “T,” then press ENTER.

To cancel all the titles, chapters, or tracks in the programmed order

- 1 Follow Steps 1 through 3 of “Creating your own programme (Programme Play).”
- 2 Press \uparrow and select “ALL CLEAR.”
- 3 Press ENTER.

Hint

You can do Repeat Play or Shuffle Play of the programmed titles, chapters, or tracks. During Programme Play, follow the Steps of “Repeat Play” (page 38) or “Shuffle Play” (page 37).

Note

When playing Super VCDs, the total time of the programmed tracks does not appear on the screen.

Playing in random order (Shuffle Play)

You can have the player “shuffle” titles, chapters, or tracks. Subsequent “shuffling” may produce a different playing order.

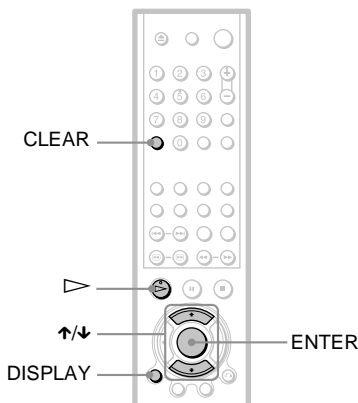

- 1 Press DISPLAY twice during playback (when playing a CD, press once). The Control Menu appears.
- 2 Press \uparrow/\downarrow to select  (SHUFFLE), then press ENTER. The options for “SHUFFLE” appear.

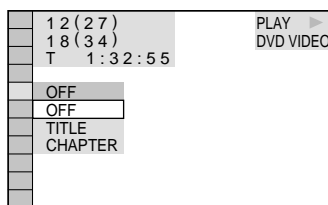

- 3 Press \uparrow/\downarrow to select the item to be shuffled.
 - ◆ When playing a DVD
 - TITLE
 - CHAPTER
 - ◆ When playing a VIDEO CD or CD
 - TRACK
 - ◆ When Programme Play is activated
 - ON: shuffles titles, chapters, or tracks selected in Programme Play.

- 4** Press **ENTER**.
Shuffle Play starts.

To return to normal play

Press **CLEAR**, or select “OFF” in Step 3.

To turn off the Control Menu

Press **DISPLAY** repeatedly until the Control Menu is turned off.

Hints

- You can set Shuffle Play while the player is stopped. After selecting the “SHUFFLE” option, press \triangleright . Shuffle Play starts.
- Up to 200 chapters in a disc can be played in random order when “CHAPTER” is selected.

Playing repeatedly (Repeat Play)

DVD **VCD** **CD** **DATA CD**

You can play all of the titles or tracks on a disc or a single title, chapter, or track repeatedly.

You can use a combination of Shuffle or Programme Play modes.

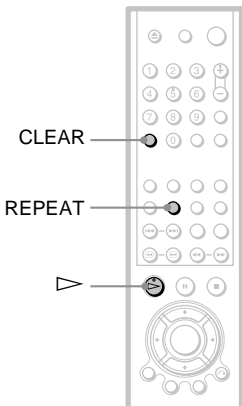

- 1** Press **REPEAT** during playback.
The following display appears.

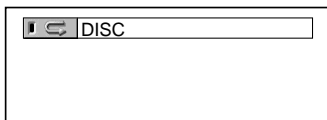

- 2** Press **REPEAT** repeatedly to select the item to be repeated.

◆ When playing a DVD

- **DISC**: repeats all of the titles.
- **TITLE**: repeats the current title on a disc.
- **CHAPTER**: repeats the current chapter.

◆ When playing a VIDEO CD or CD

- **DISC**: repeats all of the tracks.
- **TRACK**: repeats the current track.

◆ When playing a DATA CD (MP3 audio)

- **DISC**: repeats all of the albums.
- **ALBUM**: repeats the current album.
- **TRACK**: repeats the current track.

◆ When Programme Play or Shuffle Play is activated

- **ON**: repeats Programme Play or Shuffle Play.

To return to normal play

Press **CLEAR**, or select “OFF” in Step 2.

Hints

- You can set Repeat Play while the player is stopped. After selecting the “REPEAT” option, press \triangleright . Repeat Play starts.
- You can also select “REPEAT” from the Control Menu (page 12).

Repeating a specific portion (A-B Repeat Play) **DVD VCD CD**

You can play a specific portion of a title, chapter or track repeatedly. (This function is useful when you want to memorize lyrics, etc.)

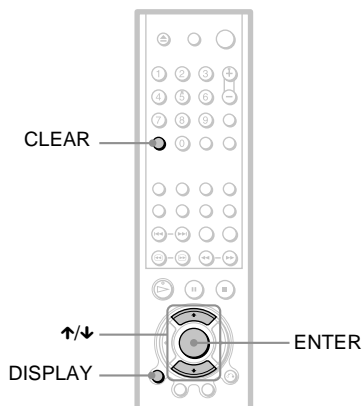

1 Press **DISPLAY** twice during playback (when playing a CD, press once). The Control Menu appears.

2 Press **↑/↓** to select **A-B** (A-B REPEAT), then press **ENTER**.

The options for "A-B REPEAT" appear.

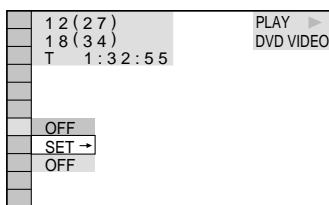

3 Press **↑/↓** to select "SET →," then press **ENTER**.

The "A-B REPEAT" setting display appears.

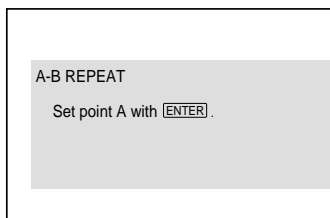

4 During playback, when you find the starting point (point A) of the portion to be played repeatedly, press **ENTER**. The starting point (point A) is set.

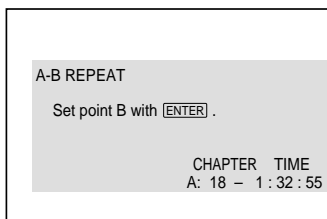

5 When you reach the ending point (point B), press **ENTER** again.

The set points are displayed and the player starts repeating this specific portion.

"A-B" appears on the front panel display during A-B Repeat Play.

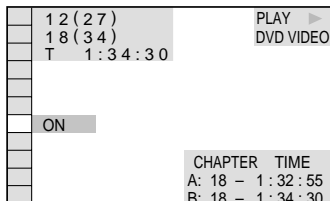

To return to normal play

Press **CLEAR**, or select "OFF" in Step 3.

To turn off the Control Menu

Press **DISPLAY** repeatedly until the Control Menu is turned off.

Notes

- You can set A-B Repeat Play for only one specific section.
- When you set A-B Repeat Play, the settings for Shuffle Play, Repeat Play, and Programme Play are cancelled.

Searching for a Scene

Searching for a Title/ Chapter/Track/Index/ Scene (Search mode) **DVD** **VCD**

CD **DATA CD**

You can search a DVD by title or chapter, and you can search a VIDEO CD/CD by track, index, or scene. As titles and tracks are assigned unique numbers on the disc, you can select the desired one by entering its number. Or, you can search for a scene using the time code.

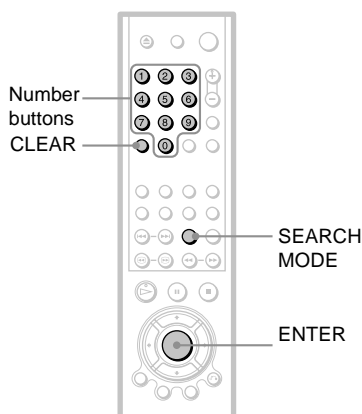

1 Press SEARCH MODE.

The following display appears.

“-- (**)” appears next to the icon (** refers to a number).

The number in parentheses indicates the total number of titles, tracks, indexes, scenes, etc. of the disc.

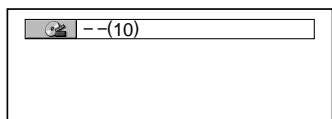

2 Press SEARCH MODE repeatedly to select the search method.

◆ When playing a DVD

- TITLE
- CHAPTER
- TIME/TEXT

Select “TIME/TEXT” to search for a starting point by inputting the time code.

◆ When playing a VIDEO CD

- TRACK
- INDEX

◆ When playing a VIDEO CD with PBC Playback

- SCENE
- INDEX

◆ When playing a CD

- TRACK
- INDEX

◆ When playing a DATA CD (MP3 audio)

- ALBUM
- TRACK

3 Select the number of the title, track, scene, time code, etc. you want by pressing the number buttons to select the digit.

For example, to find the scene at 2 hours, 10 minutes, and 20 seconds after the beginning, select “TIME/TEXT” in Step 2 and enter “2:10:20.”

If you make a mistake

Cancel the number by pressing CLEAR, then select another number.

4 Press ENTER.

The player starts playback from the selected number.

To turn off the display

Press SEARCH MODE repeatedly until the display is turned off.

Hints

- You can display the first scene of titles, chapters or tracks recorded on the disc on a screen divided into 9 sections. You can start playback directly by selecting one of the scenes. For details, see page 41.
- You can also select “TITLE,” “CHAPTER,” “TRACK,” “INDEX,” “SCENE,” “TIME/TEXT,” or “ALBUM” from the Control Menu (page 12).

Searching by Scene

(PICTURE NAVIGATION)

You can divide the screen into 9 subsections and find the desired scene quickly.

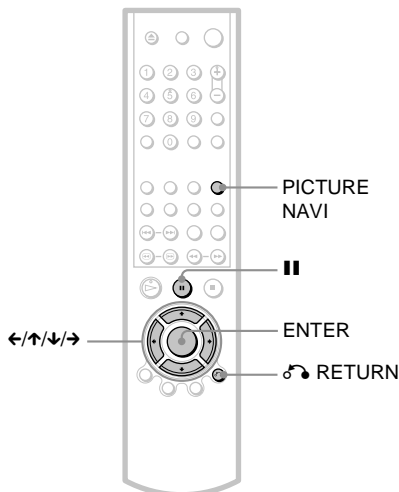

1 Press PICTURE NAVI during playback.

The following display appears.

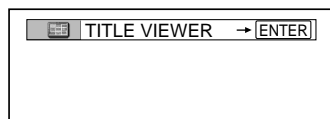

2 Press PICTURE NAVI repeatedly to select the item.

Refer to the explanations given for each item in the following sections.

- TITLE VIEWER (for DVD only)
- CHAPTER VIEWER (for DVD only)
- TRACK VIEWER (for VIDEO CD only)
- STROBE PLAYBACK
- ANGLE VIEWER (for DVD only)

3 Press ENTER.

To return to normal play

Press **↶** RETURN.

Hint

You can also select “PICTURE NAVIGATION” from the Control Menu (page 12).

Notes

- The “PICTURE NAVIGATION” is not available when playing Super VCDs.
- Depending on the disc, you may not be able to select all functions.
- The sound is muted when using this function.

Scanning the title, chapter, or track (TITLE VIEWER, CHAPTER VIEWER, TRACK VIEWER) **DVD** **VCD**

You can divide the screen into 9 subscreens and display the first scene of titles, chapters, or tracks.

You can also play back from the selected title, chapter, or track. After performing Step 3 of “Searching by Scene” above, select the scene using **←/↑/↓/→** and press ENTER.

Hint

If there are more than 9 titles, chapters, or tracks, ▼ is displayed at the bottom right.

To display the additional titles, chapters, or tracks, select the bottom right scene (the position 9) and press **↓**. To return to the previous scene, select the top left scene (the position 1) and press **↑**.

1	2	3
4	5	6
7	8	9

Dividing a scene into 9 sections (STROBE PLAYBACK)

DVD **VCD**

You can display 9 consecutive moving pictures on the screen.

When you press **■** after performing Step 3 of “Searching by Scene” above, the moving pictures pause.

Displaying different angles simultaneously (ANGLE VIEWER)

DVD

If various angles (multi-angles) for a scene are recorded on the DVD, you can display all of the angles recorded on the disc on the screen divided into 9 sections.

You can also play back from the selected angle. After performing Step 3 of “Searching by Scene” above, select the angle using **←/↑/↓/→** and press ENTER.

Using Karaoke

You can enjoy karaoke (singing along with a disc) by connecting a microphone (not supplied) to the player.

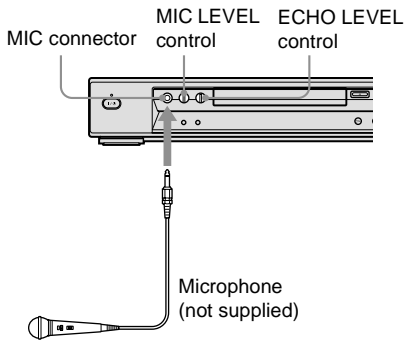

Adjusting the microphone

- 1 Set the MIC LEVEL control of the MIC connector to MIN.
- 2 Plug a microphone (not supplied) into the MIC connector.
- 3 Set the ON/OFF switch on the microphone to ON and turn the MIC LEVEL control to adjust the microphone volume.
- 4 Turn the ECHO LEVEL control to adjust the echo.

Hint

If howling occurs:

- move the microphone away from the speakers.
- lower the MIC LEVEL or ECHO LEVEL.
- lower the overall volume.

Note

The sound input from the microphone is not output from the DIGITAL OUT (OPTICAL and COAXIAL) connectors.

Dolby Digital Karaoke format

Dolby Digital format, which reproduces surround sound using 5 channels, contains the “Dolby Digital Karaoke” format specialized for karaoke. In the Dolby Digital Karaoke format discs, guide melody and guide vocal tracks are recorded in addition to the accompaniment.

Speaker output in normal Dolby Digital format (5 channel surround)

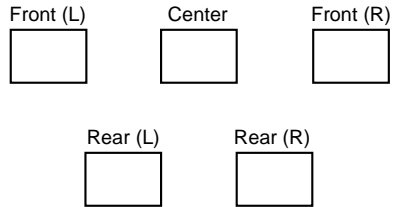

Speaker output in Dolby Digital Karaoke format

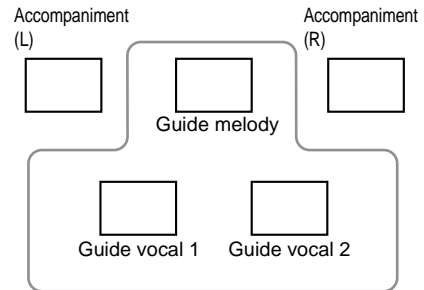

You can select any of these. These are output from the front speakers (L, R).

You can check the audio information using “AUDIO” in the Control Menu display (page 12). When playing a Dolby Digital Karaoke disc, “♪ KARAOKE” appears at the current audio format (page 50).

Example:

DOLBY DIGITAL **3/2**
♪ KARAOKE

- 2/0: Recorded only with accompaniment.
- 3/0: Recorded with guide melody.
- 3/1: Recorded with guide melody and guide vocal.
- 3/2: Recorded with guide melody and two kinds of guide vocals.

Selecting the Vocals (Vocal Select)

DVD VCD CD

You can change the guide vocal channel and select different kinds of vocals.

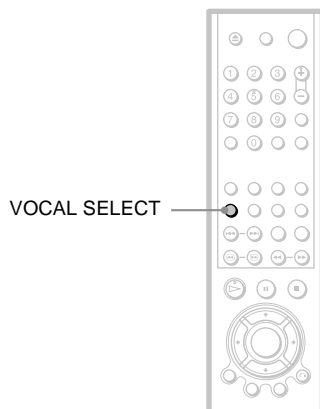

1 Press VOCAL SELECT during playback.

The following display appears.

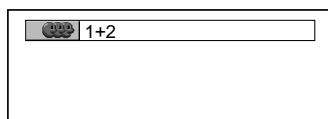

2 Press VOCAL SELECT repeatedly to select the desired vocal channel.

The output channel changes as follows. The default setting is underlined.

◆ When playing a DVD

- OFF
- ↓
- 1+2 (Guide vocal 1+2)
- ↓
- 1 (Guide vocal 1)
- ↓
- 2 (Guide vocal 2)

◆ When playing a VIDEO CD or CD

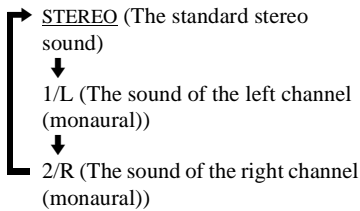

◆ When playing a Super VCD

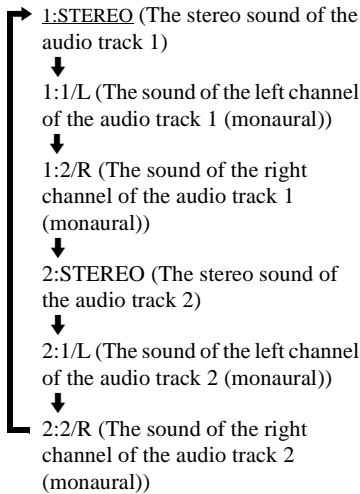

💡 Hints

- The channel returns to the default setting when:
 - you turn off the power.
 - you remove the disc.
- When playing a DVD recorded only with one kind of guide vocal, select “OFF” or “1.”

Notes

- When playing a DVD, the function works only with the Dolby Digital Karaoke format.
- If you select a channel other than “OFF” when playing a DVD, the guide melody is also output.
- Depending on the discs, you may not be able to do the operations above.

Checking the Playing Time and Remaining Time **DVD VCD CD DATA CD**

You can check the playing time and remaining time of the current title, chapter, or track. Also, you can check the DVD/CD text or track name (MP3 audio) recorded on the disc.

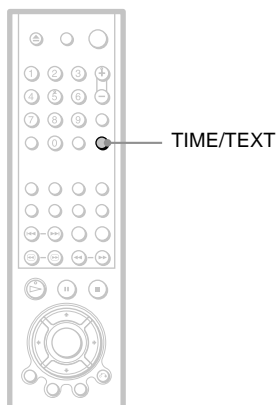

1 Press TIME/TEXT during playback.

The following display appears.

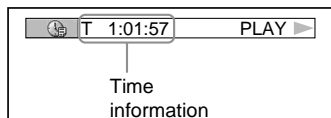

2 Press TIME/TEXT repeatedly to change the time information.

The display and the kinds of time that you can change depend on the disc you are playing.

◆ When playing a DVD

- T **:***
Playing time of the current title
- T-**:***
Remaining time of the current title
- C **:***
Playing time of the current chapter
- C-**:***
Remaining time of the current chapter

◆ When playing a VIDEO CD (with PBC functions)

- **:***
Playing time of the current scene

◆ When playing a VIDEO CD (without PBC functions) or CD

- T **:***
Playing time of the current track
- T-**:***
Remaining time of the current track
- D **:***
Playing time of the current disc
- D-**:***
Remaining time of the current disc

◆ When playing a Super VCD

The remaining time cannot be displayed.

- T **:***
Playing time of the current track

◆ When playing a DATA CD (MP3 audio)

- **:***
Playing time of the current track

To check the DVD/CD text or track and album names (MP3 audio)

Press TIME/TEXT repeatedly in Step 2 to display text recorded on the DVD/CD/DATA CD.

The DVD/CD text appears only when text is recorded in the disc. You cannot change the text. If the disc does not contain text, "NO TEXT" appears.

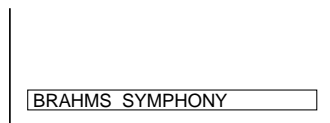

For DATA CDs, the track and album names of the MP3 audio track appears (page 49).

Checking the information on the front panel display

You can view the time information and text displayed on the TV screen also on the front panel display. The information on the front panel display changes as follows when you change the time information on your TV screen.

When playing a DVD

Title playing time and the current title and chapter number

TITLE	CHP	HOUR	MIN	SEC
1.	2	1:03	24	

Remaining time of the current title

TITLE	CHP	HOUR	MIN	SEC
1.	2	-1:15	36	

Playing time and number of the current chapter

CHP	HOUR	MIN	SEC
2	02	23	0

Remaining time of the current chapter

CHP	HOUR	MIN	SEC
2	-01	32	0

Text

SONY HITS/5

When playing a VIDEO CD (without PBC functions) or CD

Track playing time and the current track and index number

TRACK	INDEX	MIN	SEC
2.	1	2:25	

Remaining time of the current track

TRACK	INDEX	MIN	SEC
2.	1	-1:50	

Playing time of the disc

MIN	SEC
32	12

Remaining time of the disc

MIN	SEC
-20	18

Text

SONY HITS/5

Viewing Information About the Disc

Hints

- When playing VIDEO CDs with PBC functions, the scene number and the playing time are displayed.
- Long text that does not fit in a single line will scroll across the front panel display.
- You can also check the time information and text using the Control Menu (page 12).

Notes

- Depending on the type of disc being played, the DVD/CD text or track name may not be displayed.
- The player can only display the first level of the DVD/CD text, such as the disc name or title.
- Playing time of MP3 audio tracks may not be displayed correctly.

When playing a DATA CD (MP3 audio)

Playing time and number of the current track and album

MIN	SEC
10	21

Track name

01HAPPY BIRT

Checking the Play Information

You can check information such as the bit rate or the disc layer that is being played.

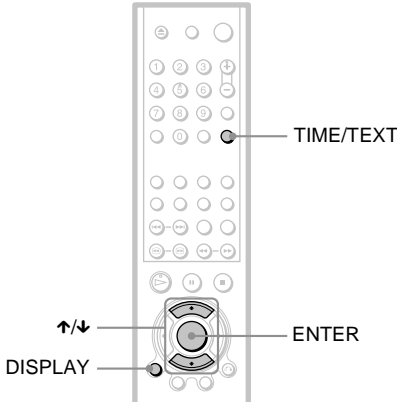

Checking the play information of a DVD (ADVANCED) **DVD**

- 1 Press **DISPLAY** during playback. The Control Menu is displayed.
- 2 Press **↑/↓** to select **BIT RATE** (ADVANCED), then press **ENTER**. The options for “ADVANCED” appear.

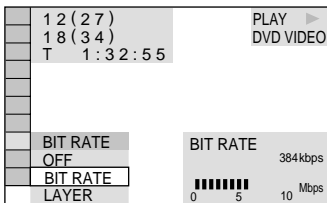

- 3 Press **↑/↓** to select items. For each item, please refer to “Displays of each item.”
 - BIT RATE: displays the bit rate.
 - LAYER: displays the layer and the pick-up point.
- 4 Press **ENTER**.

To close the **ADVANCED** window

Select “OFF” in Step 3.

To turn off the **Control Menu**

Press **DISPLAY** repeatedly until the Control Menu is turned off.

Displays of each item

By pressing **DISPLAY** repeatedly, you can display either “BIT RATE” or “LAYER,” whichever was selected in “ADVANCED.”

◆BIT RATE

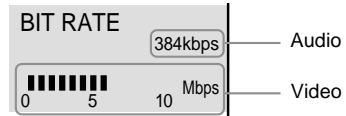

When playing MPEG audio sound tracks

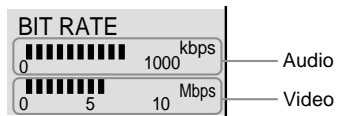

Bit rate refers to the amount of video/audio data per second in a disc. While playing a disc, an approximate bit rate of the playback picture is displayed as Mbps (Mega bit per second) and the audio as kbps (kilo bit per second). The higher the bit rate, the larger the amount of data. However, this does not always mean that you can get higher quality pictures or sounds.

◆LAYER

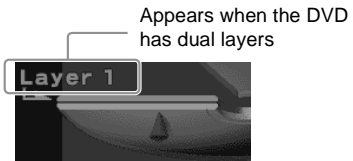

Indicates the approximate point where the disc is playing. If it is a dual-layer DVD, the player indicates which layer is being read (“Layer 0” or “Layer 1”). For details on the layers, see page 74 (DVD).

Checking the play information of a DATA CD **DATA CD**

By pressing TIME/TEXT while playing MP3 audio track on a DATA CD, you can display the audio bit rate (the amount of data per second of the current audio).

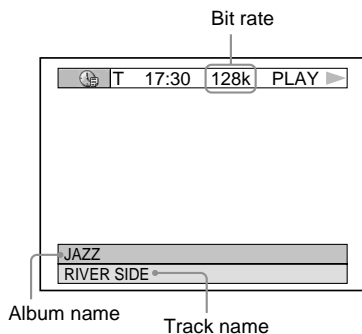

Changing the Sound

DVD VCD CD DATA CD

When playing a DVD recorded in multiple audio formats (PCM, Dolby Digital, MPEG audio, or DTS), you can change the audio format. If the DVD is recorded with multilingual tracks, you can also change the language.

With CDs, DATA CDs, or VIDEO CDs, you can select the sound from the right or left channel and listen to the sound of the selected channel through both the right and left speakers. For example, when playing a disc containing a song with the vocals on the right channel and the instruments on the left channel, you can hear the instruments from both speakers by selecting the left channel.

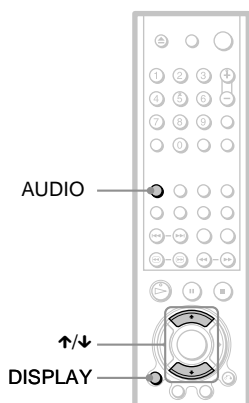

1 Press AUDIO during playback.

The following display appears.

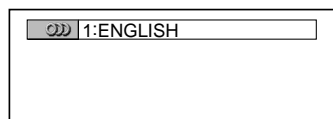

2 Press AUDIO repeatedly to select the desired audio signal.

◆ When playing a DVD

Depending on the DVD, the choice of language varies.

When 4 digits are displayed, they indicate a language code. Refer to “Language Code List” on page 76 to see which language the code represents.

When the same language is displayed two or more times, the DVD is recorded in multiple audio formats.

◆ When playing a VIDEO CD, CD, or DATA CD (MP3 audio)

The default setting is underlined.

- STEREO: The standard stereo sound
- 1/L: The sound of the left channel (monaural)
- 2/R: The sound of the right channel (monaural)

◆ When playing a Super VCD

The default setting is underlined.

- 1: STEREO: The stereo sound of the audio track 1
- 1: 1/L: The sound of the left channel of the audio track 1 (monaural)
- 1: 2/R: The sound of the right channel of the audio track 1 (monaural)
- 2: STEREO: The stereo sound of the audio track 2
- 2: 1/L: The sound of the left channel of the audio track 2 (monaural)
- 2: 2/R: The sound of the right channel of the audio track 2 (monaural)

💡 Hint

You can also select “AUDIO” from the Control Menu (page 12).

Note

While playing a Super VCD on which the audio track is not recorded, no sound will come out when you select “2:STEREO,” “2:1/L,” or “2:2/R.”

Displaying the audio information of the disc **DVD**

Press DISPLAY during playback to display the Control Menu. Select “AUDIO” using ↑/↓. The channels being played are displayed on the screen.

For example, in Dolby Digital format, multiple signals ranging from monaural to 5.1 channel signals can be recorded on a DVD. Depending on the DVD, the number of the recorded channels may differ.

Current audio format*

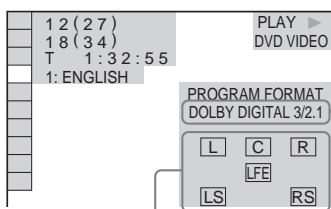

Currently playing program format**

**“PCM,” “MPEG,” “DTS,” or “DOLBY DIGITAL” is displayed. In the case of “DOLBY DIGITAL,” the channels in the playing track are displayed by numbers as follows:

For Dolby Digital 5.1 ch:

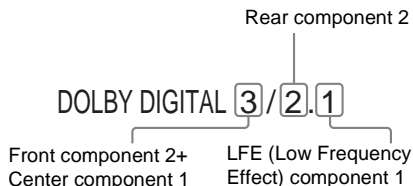

**The letters in the programme format display mean the following sound component:

- L: Front (left)
- R: Front (right)
- C: Centre
- LS: Rear (left)
- RS: Rear (right)
- S: Rear (monaural): The rear component of the Dolby Surround processed signal and the Dolby Digital signal
- LFE: Low Frequency Effect signal

Hint

For Dolby Digital 5.1 ch and DTS, “LFE” is always enclosed in a solid line regardless of the LFE signal component being output.

Note

If “DTS” is set to “OFF” in “AUDIO SETUP” (page 70), the DTS track selection option will not appear on the screen even if the disc contains DTS tracks.

TV Virtual Surround Settings (TVS) **DVD**

When you connect a stereo TV or 2 front speakers, TVS (TV Virtual Surround) lets you enjoy surround sound effects by using sound imaging to create virtual rear speakers from the sound of the front speakers (L: left, R: right) without using actual rear speakers. TVS was developed by Sony to produce surround sound for home use using just a stereo TV.

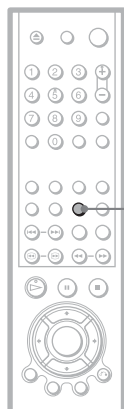

Sound Adjustments

1 Press SUR during playback.

The following display appears.

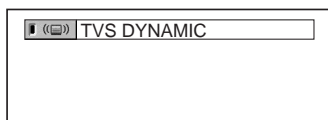

2 Press SUR repeatedly to select one of the TVS sounds.

Refer to the following explanations given for each item.

- TVS DYNAMIC
- TVS WIDE
- TVS NIGHT
- TVS STANDARD

To cancel the setting

Select "OFF" in Step 2.

◆TVS DYNAMIC

Creates virtual rear speakers from the sound of the front speakers (L, R) without using actual rear speakers (shown below).

This mode is effective when the distance between the front L and R speakers is short, such as with built-in speakers on a stereo TV.

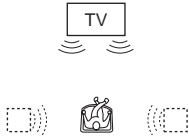

◆TVS WIDE

Creates virtual rear speakers from the sound of the front speakers (L, R) without using actual rear speakers. The virtual speakers are reproduced as shown in the illustration below.

This mode is effective when the distance between the front L and R speakers is short, such as with built-in speakers on a stereo TV.

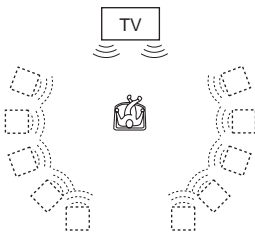

◆TVS NIGHT

Large sounds, such as explosions, are suppressed, but the quieter sounds are unaffected. This feature is useful when you want to hear the dialog and enjoy the surround sound effects of "TVS WIDE" at low volume.

◆TVS STANDARD

Creates virtual rear speakers from the sound of the front speakers (L, R) without using actual rear speakers. The virtual speakers are reproduced as shown in the illustration below. Use this setting when you want to use TVS with 2 separate speakers.

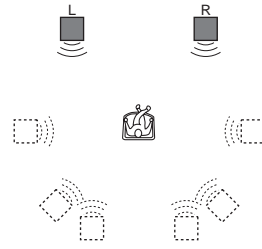

L: Front speaker (left)
R: Front speaker (right)
□: Virtual speaker

💡 Hints

- You can also select "TVS" by pressing SURROUND button on the player.
- You can also select "TVS" from the Control Menu (page 12).

Notes

- When the playing signal does not contain a signal for the rear speakers, the surround effects cannot be heard.
- When you select one of the TVS modes, turn off the surround setting of the connected TV or amplifier (receiver).
- Make sure that your listening position is between and at an equal distance from your speakers, and that the speakers are located in similar surroundings.
- "TVS NIGHT" only works with Dolby Digital discs. However, not all discs will respond to the "TVS NIGHT" function in the same way.
- When you use the DIGITAL OUT (OPTICAL or COAXIAL) jack to listen to MPEG audio signals and set "MPEG" to "MPEG" in "AUDIO SETUP," no sound will come from your speakers if you select one of the TVS modes.

Changing the Angles **DVD**

If various angles (multi-angles) for a scene are recorded on the DVD, “ANGLE” appears in the front panel display. This means that you can change the viewing angle.

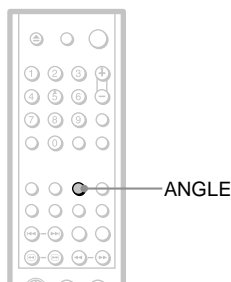

1 Press ANGLE during playback.

The number of the angle appears on the display.

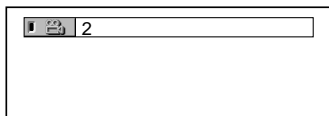

2 Press ANGLE repeatedly to select the angle number.

The scene changes to the selected angle.

Hints

- You can display all the angles recorded on the disc on the same screen, and start playback directly from the chosen angle. The angles are displayed on a screen divided into 9 sections (page 41).
- You can also select “ANGLE” from the Control Menu (page 12).

Note

Depending on the DVD, you may not be able to change the angles even if multi-angles are recorded on the DVD.

Displaying the Subtitles

DVD

If subtitles are recorded on the discs, you can change the subtitles or turn them on and off whenever you want while playing a DVD.

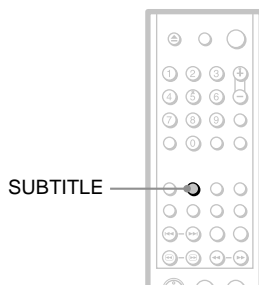

1 Press SUBTITLE during playback.

The following display appears.

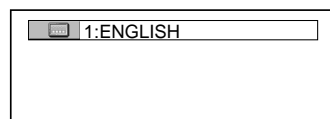

2 Press SUBTITLE repeatedly to select the language.

Depending on the DVD, the choice of language varies.

When 4 digits are displayed, they indicate a language code. Refer to “Language Code List” on page 76 to see which language the code represents.

To turn off the subtitles

Select “OFF” in Step 2.

Hint

You can also select “SUBTITLE” from the Control Menu (page 12).

Note

Depending on the DVD, you may not be able to change the subtitles even if multilingual subtitles are recorded on it. You also may not be able to turn them off.

Adjusting the Picture Quality (BNR) **DVD** **VCD**

The Block Noise Reduction (BNR) function adjusts the picture quality by reducing the “block noise” or mosaic like patterns that appear on your TV screen.

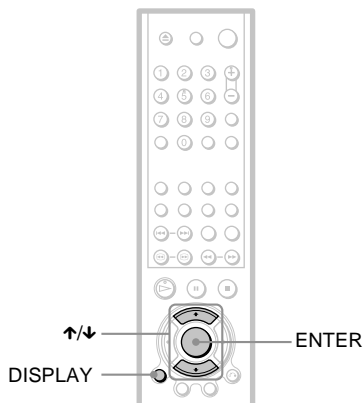

1 Press DISPLAY twice during playback.

The Control Menu appears.

2 Press ↑/↓ to select **BNR** (BNR), then press ENTER.

The options for “BNR” appear.

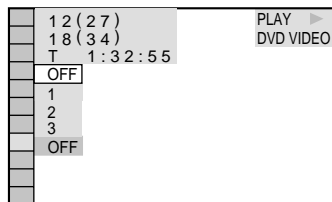

3 Press ↑/↓ to select a level.

- 1: reduces the “block noise.”
- 2: reduces the “block noise” more than 1.
- 3: reduces the “block noise” more than 2.

4 Press ENTER.

The disc plays with the setting you selected.

To cancel the “BNR” setting

Select “OFF” in Step 3.

To turn off the Control Menu

Press DISPLAY repeatedly until the Control Menu is turned off.

Notes

- If the outlines of the images on your screen should become blurred, set “BNR” to “OFF.”
- Depending on the disc or the scene being played, the “BNR” effect may be hard to discern.

Adjusting the Playback Picture (CUSTOM PICTURE MODE)

DVD VCD

You can adjust the video signal of the DVD or VIDEO CD from the player to obtain the picture quality you want. Choose the setting that best suits the programme you are watching.

When you select "MEMORY," you can make further adjustments to each element of the picture (colour, brightness, etc.).

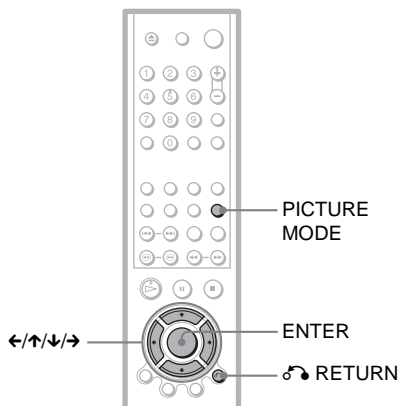

1 Press PICTURE MODE during playback.

The following display appears.

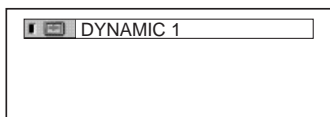

2 Press PICTURE MODE repeatedly to select the setting you want.

The default setting is underlined.

- **STANDARD:** displays a standard picture.
- **DYNAMIC 1:** produces a bold dynamic picture by increasing the picture contrast and the colour intensity.
- **DYNAMIC 2:** produces a more dynamic picture than DYNAMIC 1 by further increasing the picture contrast and the colour intensity.

- **CINEMA 1:** enhances details in dark areas by increasing the black level.
- **CINEMA 2:** White colours become brighter and black colours become richer, and the colour contrast is increased.
- **MEMORY:** adjusts the picture in greater detail.

Hints

- When you watch a movie, "CINEMA 1" or "CINEMA 2" is recommended.
- The picture can be adjusted by pressing PICTURE MODE button on the player as well.
- You can also select "CUSTOM PICTURE MODE" from the Control Menu (page 12).

Adjusting the picture items in "MEMORY"

You can adjust each element of the picture individually.

- **PICTURE:** changes the contrast
- **BRIGHTNESS:** changes the overall brightness
- **COLOR:** makes the colours deeper or lighter
- **HUE:** changes the colour balance

1 Press PICTURE MODE repeatedly to select "MEMORY" and press ENTER. The "PICTURE" adjustment bar appears.



2 Press ←/→ to adjust the picture contrast, then press ENTER.

The adjustment is saved, and "BRIGHTNESS" adjustment bar appears.

3 Repeat Step 2 to adjust "BRIGHTNESS," "COLOR," and "HUE."

The Custom Picture Mode display appears. You can check each adjustment.

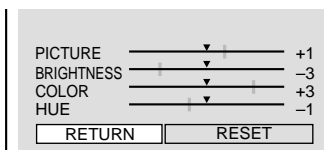

To turn off the display

Press **↶** RETURN, or select "RETURN" in Step 3 and press ENTER.

💡 Hints

- To reset the picture items to the default values, press **→** after Step 3 to select "RESET" and press ENTER.
- When "PLAYBACK MEMORY" in "CUSTOM SETUP" is set to "ON," the player will save a single setting for up to 40 individual discs.
- If you do not want to save the adjustment in Step 2, you can go to the next picture item by pressing **↑/↓** without saving.

Enhancing the Playback Picture (DIGITAL VIDEO

ENHANCER) **DVD** **VCD**

The Digital Video Enhancer (DVE) function makes the picture appear clear and crisp by enhancing the outlines of images on your TV screen. Also, this function can soften the images on the screen.

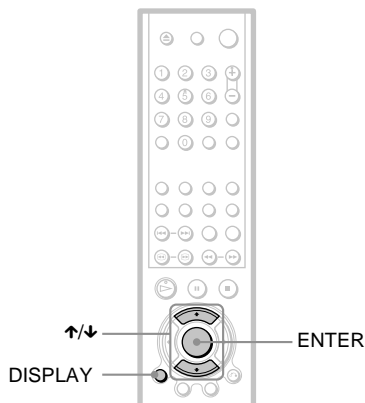

1 Press DISPLAY twice during playback.

The Control Menu appears.

2 Press **↑/↓** to select **[DVE]** (DIGITAL VIDEO ENHANCER), then press ENTER.

The options for "DIGITAL VIDEO ENHANCER" appear.

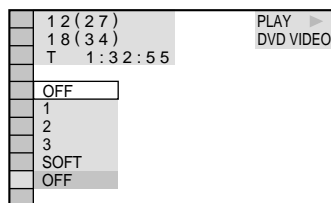

3 Press \uparrow/\downarrow to select a level.

- 1: enhances the outline.
- 2: enhances the outline more than 1.
- 3: enhances the outline more than 2.
- SOFT: softens the image (DVD only).

4 Press ENTER.

The disc plays with the setting you selected.

To cancel the "DIGITAL VIDEO ENHANCER" setting

Select "OFF" in Step 3.

To turn off the Control Menu

Press DISPLAY repeatedly until the Control Menu is turned off.

Note

Depending on the disc or the scene being played, noise found in the disc may become more apparent. If this happens, it is recommended that you use the BNR function (page 54) with the DVE function. If the condition still does not improve, reduce the Digital Video Enhancer level, or select "SOFT" (DVD only) in Step 3 above.

Using Various Additional Functions

Locking Discs (CUSTOM PARENTAL CONTROL, PARENTAL CONTROL)

You can set two kinds of playback restrictions for the desired disc.

- Custom Parental Control
You can set playback restrictions so that the player will not play inappropriate discs.
- Parental Control
Playback of some DVDs can be limited according to a predetermined level such as the age of the users. Scenes may be blocked or replaced with different scenes.



The same password is used for both Parental Control and Custom Parental Control.

Custom Parental Control

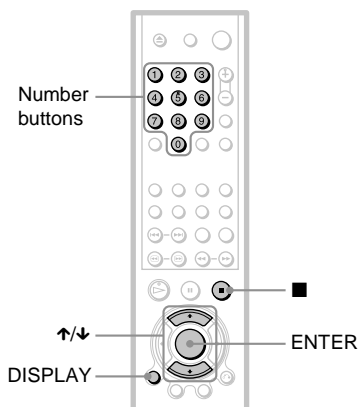
You can set the same Custom Parental Control password for up to 40 discs. When you set the 41st-disc, the first disc is cancelled.



- 1 Insert the disc you want to lock.
If the disc is playing, press  to stop playback.
- 2 Press DISPLAY while the player is in stop mode.
The Control Menu appears.

- 3 Press  to select  (PARENTAL CONTROL), then press ENTER.

The options for "PARENTAL CONTROL" appear.

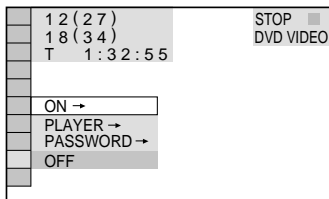

- 4 Press  to select "ON →," then press ENTER.

◆ If you have not entered a password
The display for registering a new password appears.



Enter a 4-digit password using the number buttons, then press ENTER.
The display for confirming the password appears.

◆ When you have already registered a password
The display for entering the password appears.

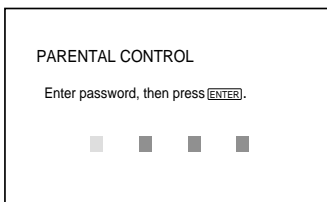

- 5 Enter or re-enter your 4-digit password using the number buttons, then press ENTER.

"Custom parental control is set." appears and then the screen returns to the Control Menu.

To turn off the Custom Parental Control function

- 1 Follow Steps 1 through 3 of “Custom Parental Control.”
- 2 Press \uparrow/\downarrow to select “OFF \rightarrow ,” then press ENTER.
- 3 Enter your 4-digit password using the number buttons, then press ENTER.

To play a disc for which Custom Parental Control is set

- 1 Insert the disc for which Custom Parental Control is set.
The “CUSTOM PARENTAL CONTROL” display appears.

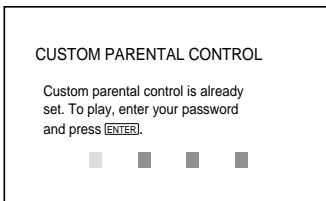

- 2 Enter your 4-digit password using the number buttons, then press ENTER.
The player is ready for playback.

Hint

If you forget your password, enter the 6-digit number “199703” using the number buttons when the “CUSTOM PARENTAL CONTROL” display asks you for your password, then press ENTER. The display will ask you to enter a new 4-digit password.

Parental Control (limited playback)

Playback of some DVDs can be limited according to a predetermined level such as the age of the users. The “PARENTAL CONTROL” function allows you to set a playback limitation level.

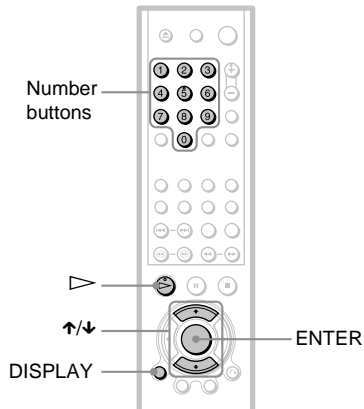

- 1 Press DISPLAY while the player is in stop mode.
The Control Menu appears.
- 2 Press \uparrow/\downarrow to select (PARENTAL CONTROL), then press ENTER.
The options for “PARENTAL CONTROL” appear.

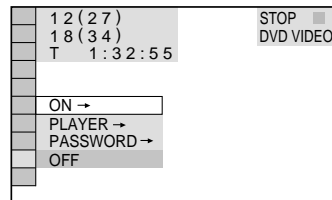

- 3 Press \uparrow/\downarrow to select “PLAYER \rightarrow ,” then press ENTER.
 If you have not entered a password
The display for registering a new password appears.

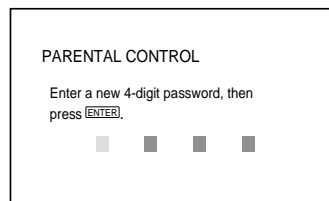

Enter a 4-digit password using the number buttons, then press ENTER. The display for confirming the password appears.

◆ **When you have already registered a password**

The display for entering the password appears.

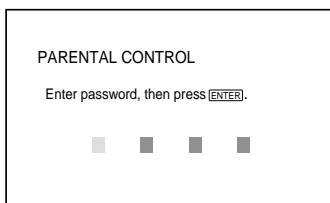

4 Enter or re-enter your 4-digit password using the number buttons, then press ENTER.

The display for setting the playback limitation level appears.

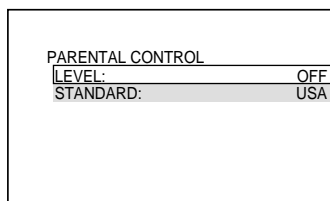

5 Press \uparrow/\downarrow to select "STANDARD," then press ENTER.

The selection items for "STANDARD" are displayed.

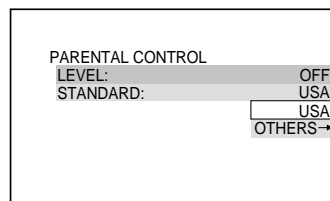

6 Press \uparrow/\downarrow to select a geographic area as the playback limitation level, then press ENTER.

The area is selected.

When you select "OTHERS \rightarrow ," select and enter a standard code in the table on page 61 using the number buttons.

7 Press \uparrow/\downarrow to select "LEVEL," then press ENTER.

The selection items for "LEVEL" are displayed.

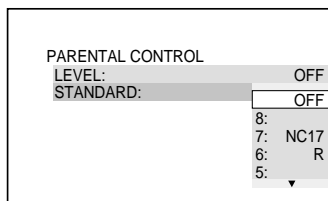

8 Select the level you want using \uparrow/\downarrow , then press ENTER.

Parental Control setting is complete.

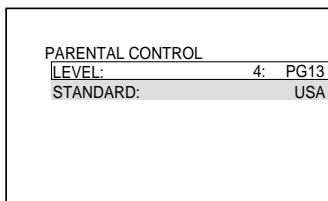

The lower the value, the stricter the limitation.

To turn off the Parental Control function

Set "LEVEL" to "OFF" in Step 8.

To play a disc for which Parental Control is set

- 1 Insert the disc and press \triangleright .
The display for entering your password appears.
- 2 Enter your 4-digit password using the number buttons, then press ENTER.
The player starts playback.

Hint

If you forget your password, remove the disc and repeat Steps 1 to 3 of "Parental Control (limited playback)." When you are asked to enter your password, enter "199703" using the number buttons, then press ENTER. The display will ask you to enter a new 4-digit password. After you enter a new 4-digit password, replace the disc in the player and press \triangleright . When the display for entering your password appears, enter your new password.

Notes

- When you play discs which do not have the Parental Control function, playback cannot be limited on this player.
- Depending on the disc, you may be asked to change the parental control level while playing the disc. In this case, enter your password, then change the level. If the Resume Play mode is cancelled, the level returns to the previous level.

Area Code

Standard	Code number	Standard	Code number
Argentina	2044	Korea	2304
Australia	2047	Malaysia	2363
Austria	2046	Mexico	2362
Belgium	2057	Netherlands	2376
Brazil	2070	New Zealand	2390
Canada	2079	Norway	2379
Chile	2090	Pakistan	2427
China	2092	Philippines	2424
Denmark	2115	Portugal	2436
Finland	2165	Russia	2489
France	2174	Singapore	2501
Germany	2109	Spain	2149
India	2248	Sweden	2499
Indonesia	2238	Switzerland	2086
Italy	2254	Thailand	2528
Japan	2276	United Kingdom	2184

Changing the password

- 1 Press **DISPLAY** while the player is in stop mode.
The Control Menu appears.
- 2 Press **↑/↓** to select  (PARENTAL CONTROL), then press **ENTER**.
The options for "PARENTAL CONTROL" appear.
- 3 Press **↑/↓** to select "PASSWORD →," then press **ENTER**.
The display for entering the password appears.
- 4 Enter your 4-digit password using the number buttons, then press **ENTER**.
- 5 Enter a new 4-digit password using the number buttons, then press **ENTER**.
- 6 To confirm your password, re-enter it using the number buttons, then press **ENTER**.

If you make a mistake entering your password

Press **←** before you press **ENTER** and input the correct number.

If you make a mistake

Press **↶** RETURN.

To turn off the display

Press **DISPLAY** repeatedly until the display is turned off.

Controlling Your TV or AV Amplifier (Receiver) with the Supplied Remote

By adjusting the remote signal, you can control your TV with the supplied remote. If you connect the player with an AV amplifier (receiver), you can control the volume with the supplied remote.

Notes

- Depending on the unit being connected, you may not be able to control your TV or AV amplifier (receiver) using some of the buttons below.
- If you enter a new code number, the code number previously entered will be erased.
- When you replace the batteries of the remote, the code number you have set may be reset to the default setting. Set the appropriate code number again.

Controlling TVs with the remote

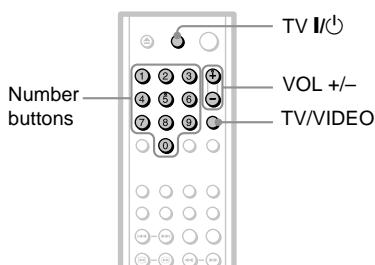

1 Hold down TV I/O, and enter your TV's manufacturer's code (see "Code numbers of controllable TVs" below) using the number buttons.

2 Release TV I/O.

The remote is set to perform the followings:

TV I/O	Turns the TV on or off
VOL +/-*	Adjusts the volume of the TV
TV/VIDEO	Switches the TV's input source between the TV and other input sources

* Once you set a code number for your AV amplifier (receiver), the VOL +/- buttons on the remote control the AV amplifier's volume only. If you would rather control the TV's volume, set the code number to "90" (default) to control the TV's volume again.

Code numbers of controllable TVs

If more than one code number is listed, try entering them one at a time until you find the one that works with your TV.

Manufacturer	Code number
Sony	01 (default), 03, 04
Aiwa	32
Akai	68
Blaupunkt	10, 21
Grundig	10, 11
Hitachi	24
JVC	33
LG	06
Loewe	45
Mitsubishi	27, 28, 50
Mivar	09
NEC	66
Nokia	15, 16, 69
Orion	47, 48
Panasonic	17, 49
Philips	06, 07, 08
Pioneer	26
Saba	12, 13
Samsung	22, 23
Sanyo	25
Sharp	29
Siemens	39
TEAC	67
Telefunken	36
Thomson	43
Toshiba	38

Controlling the volume of your AV amplifier (receiver) with the remote

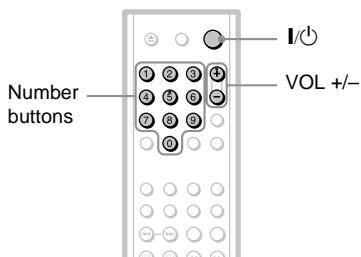

- 1 Hold down I/⏻, and enter your AV amplifier (receiver)'s manufacturer's code (see the table below) using the number buttons.
- 2 Release I/⏻.

You can control the volume of the AV amplifier (receiver) using VOL +/-.

Code numbers of controllable AV amplifiers (receivers)

If more than one code number is listed, try entering them one at a time until you find the one that works with your AV amplifier (receiver).

Manufacturer	Code number
Sony	80, 88, 89, 91
Denon	84, 85, 86
Kenwood	92, 93
Onkyo	81, 82, 83
Pioneer	99
Sansui	87
Technics	97, 98
Yamaha	94, 95, 96

If you would rather control the volume of your TV

Repeat Steps 1 and 2 above and enter the code number 90 (default).

Settings and Adjustments

Using the Setup Display

By using the Setup Display, you can make various adjustments to items such as picture and sound. You can also set a language for the subtitles and the Setup Display, among other things. For details on each Setup Display item, see pages from 65 to 70.

Note

Playback settings stored in the disc take priority over the Setup Display settings and not all the functions described may work.

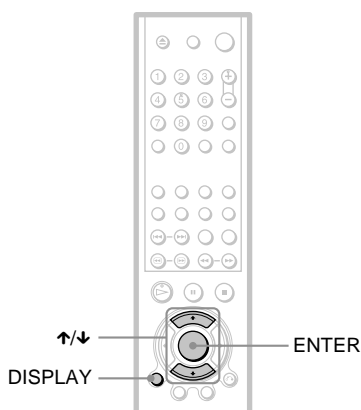

- 1 Press **DISPLAY** when the player is in stop mode.

The Control Menu appears.

- 2 Press **↑/↓** to select  (**SETUP**), then press **ENTER**.

The options for "SETUP" appear.

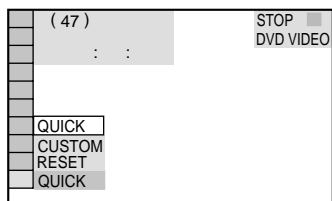

- 3 Press **↑/↓** to select "CUSTOM," then press **ENTER**.

The Setup Display appears.

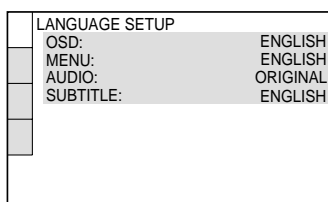

- 4 Press **↑/↓** to select the setup item from the displayed list:

"LANGUAGE SETUP," "SCREEN SETUP," "CUSTOM SETUP," or "AUDIO SETUP." Then press **ENTER**.

The Setup item is selected.

Example: "SCREEN SETUP"

Selected item

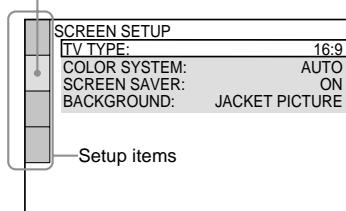

- 5 Select an item using **↑/↓**, then press **ENTER**.

The options for the selected item appear.

Example: "TV TYPE"

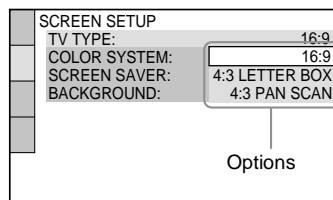

Options

6 Select a setting using \uparrow/\downarrow , then press ENTER.

The setting is selected and setup is complete.

Example: "4:3 PAN SCAN"

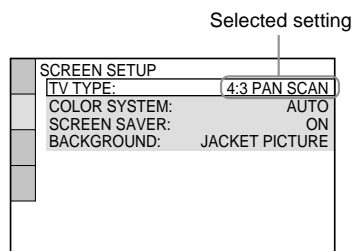

To turn off the display

Press DISPLAY repeatedly until the display is turned off.

To enter the Quick Setup mode

Select "QUICK" in Step 3. Follow from Step 5 of the Quick Setup explanation to make basic adjustments (page 25).

To reset all of the "SETUP" settings

- 1 Select "RESET" in Step 3 and press ENTER.
- 2 Select "YES" using \uparrow/\downarrow .
You can also quit the process and return to the Control Menu by selecting "NO" here.
- 3 Press ENTER.
All the settings explained on pages 65 to 70 return to the default settings. Do not press \mathbb{I}/\mathbb{C} while resetting the player as it takes a few seconds to complete.

Setting the Display or Sound Track Language

(LANGUAGE SETUP)

"LANGUAGE SETUP" allows you to set various languages for the on-screen display or sound track.

Select "LANGUAGE SETUP" in the Setup Display. To use the display, see "Using the Setup Display" (page 64).

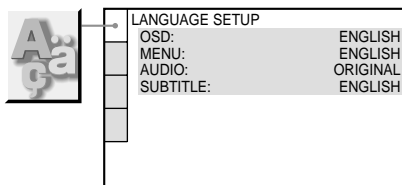

◆ OSD (On-Screen Display)

Switches the display language on the screen.

◆ MENU (DVD only)

You can select the desired language for the disc's menu.

◆ AUDIO (DVD only)

Switches the language of the sound track. When you select "ORIGINAL," the language given priority in the disc is selected.

◆ SUBTITLE (DVD only)

Switches the language of the subtitle recorded on the DVD.

When you select "AUDIO FOLLOW," the language for the subtitles changes according to the language you selected for the sound track.

🔔 Hint

If you select "OTHERS \rightarrow " in "MENU," "SUBTITLE," and "AUDIO," select and enter a language code from "Language Code List" on page 76 using the number buttons.

Note

When you select a language in "MENU," "SUBTITLE," or "AUDIO" that is not recorded on the DVD, one of the recorded languages will be automatically selected.

Settings for the Display

(SCREEN SETUP)

Choose settings according to the TV to be connected.

Select "SCREEN SETUP" in the Setup Display. To use the display, see "Using the Setup Display" (page 64).

The default settings are underlined.

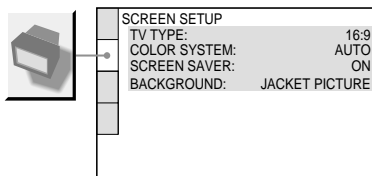

◆ TV TYPE

Selects the aspect ratio of the connected TV (4:3 standard or wide).

<u>16:9</u>	Select this when you connect a wide-screen TV or a TV with a wide mode function.
4:3 LETTER BOX	Select this when you connect a 4:3 screen TV. Displays a wide picture with bands on the upper and lower portions of the screen.
4:3 PAN SCAN	Select this when you connect a 4:3 screen TV. Automatically displays the wide picture on the entire screen and cuts off the portions that do not fit.

16:9

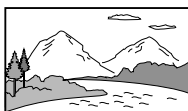

4:3 LETTER BOX



4:3 PAN SCAN

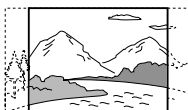

Note

Depending on the DVD, "4:3 LETTER BOX" may be selected automatically instead of "4:3 PAN SCAN" or vice versa.

◆ COLOR SYSTEM (VIDEO CD only)

Select the colour system when you play a VIDEO CD.

<u>AUTO</u>	Outputs the video signal in the system of the VIDEO CD, either PAL or NTSC. If your TV is the DUAL system, select AUTO.
PAL	Changes the video signal of an NTSC VIDEO CD and outputs it in the PAL system.
NTSC	Changes the video signal of a PAL VIDEO CD and outputs it in the NTSC system.

Notes

- You cannot change the colour system for DVDs.
- You can change the colour system of this player according to the connected TV. See page 16.

◆ SCREEN SAVER

The screen saver image appears when you leave the player in pause or stop mode for 15 minutes, or when you play back a CD or DATA CD (MP3 audio) for more than 15 minutes. The screen saver will help prevent your display device from becoming damaged (ghosting). Press \triangleright to turn off the screen saver.

<u>ON</u>	Turns on the screen saver.
OFF	Turns off the screen saver.

◆ BACKGROUND

Selects the background colour or picture on the TV screen in stop mode or while playing a CD or DATA CD (MP3 audio).

<u>JACKET PICTURE</u>	The jacket picture (still picture) appears, but only when the jacket picture is already recorded on the disc (CD-EXTRA, etc.). If the disc does not contain a jacket picture, the "GRAPHICS" picture appears.
GRAPHICS	A preset picture stored in the player appears.

BLUE	The background colour is blue.
BLACK	The background colour is black.

Custom Settings (CUSTOM SETUP)

Use this to set up playback related and other settings.

Select “CUSTOM SETUP” in the Setup Display. To use the display, see “Using the Setup Display” (page 64).

The default settings are underlined.



CUSTOM SETUP	
AUTO PLAY:	<u>OFF</u>
DIMMER:	BRIGHT
PAUSE MODE:	<u>AUTO</u>
PLAYBACK MEMORY:	ON
TRACK SELECTION:	<u>OFF</u>
MULTI-DISC RESUME:	ON

◆ AUTO PLAY

Switches the Auto Play setting on or off. This function is useful when the player is connected to a timer (not supplied).

<u>OFF</u>	Switches this function off.
ON	Automatically starts playback when the player is turned on.

◆ DIMMER

Adjusts the lighting of the front panel display.

<u>BRIGHT</u>	Makes the lighting bright.
DARK	Makes the lighting dark.
OFF	Turns off the lighting.

◆ PAUSE MODE (DVD only)

Selects the picture in pause mode.

<u>AUTO</u>	The picture, including subjects that move dynamically, is output with no jitter. Normally select this position.
FRAME	The picture, including subjects that do not move dynamically, is output in high resolution.

◆ **PLAYBACK MEMORY (DVD/VIDEO CD only)**

The player can store the “SUBTITLE” and other settings of each disc for up to 40 discs (Playback Memory).

Set this function “ON” or “OFF.”

<u>ON</u>	Stores the settings in memory when you eject the disc.
OFF	Does not store the settings in memory.

The following settings are stored in memory.

- ANGLE (page 53)*
- AUDIO (page 50)*
- BNR (page 54)
- DIGITAL VIDEO ENHANCER (page 56)
- SUBTITLE (page 53)*
- CUSTOM PICTURE MODE (page 55)

* DVD only

Note

The player can store the settings of up to 40 discs. When you store the setting of disc number 41, the first disc setting is cancelled.

◆ **TRACK SELECTION (DVD only)**

Gives the sound track which contains the highest number of channels priority when you play a DVD on which multiple audio formats (PCM, MPEG audio, DTS, or Dolby Digital format) are recorded.

<u>OFF</u>	No priority given.
AUTO	Priority given.

Notes

- When you set the item to “AUTO,” the language may change. The “TRACK SELECTION” setting has higher priority than the “AUDIO” settings in “LANGUAGE SETUP” (page 65).
- If you set “DTS” to “OFF” (page 70), the DTS sound track is not played even if you set “TRACK SELECTION” to “AUTO.”
- If PCM, DTS, MPEG audio, and Dolby Digital sound tracks have the same number of channels, the player selects PCM, DTS, Dolby Digital, and MPEG audio sound tracks in this order.

◆ **MULTI-DISC RESUME (DVD/VIDEO CD only)**

Switches the Multi-disc Resume setting on or off. Resume playback point can be stored in memory for up to 40 different DVD/VIDEO CD discs (page 31).

<u>ON</u>	Stores the resume settings in memory for up to 40 discs (The settings remain in memory even if you select OFF.)
OFF	Does not store the resume settings in memory. Playback restarts at the resume point only for the current disc in the player.

Settings for the Sound

(AUDIO SETUP)

“AUDIO SETUP” allows you to set the sound according to the playback and connection conditions.

Select “AUDIO SETUP” in the Setup Display. To use the display, see “Using the Setup Display” (page 64).
The default settings are underlined.

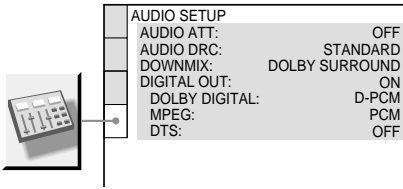

◆ AUDIO ATT (attenuation)

If the playback sound is distorted, set this item to “ON.” The player reduces the audio output level.

This function affects the output of the LINE OUT L/R (AUDIO) 1/2 jacks.

<u>OFF</u>	Normally, select this position.
ON	Select this when the playback sound from the speakers is distorted.

◆ AUDIO DRC (Dynamic Range Control) (DVD only)

Makes the sound clear when the volume is turned down when playing a DVD that conforms to “AUDIO DRC.” This affects the output from the following jacks:

- LINE OUT L/R (AUDIO) 1/2 jacks
- DIGITAL OUT (OPTICAL or COAXIAL) jack only when “DOLBY DIGITAL” is set to “D-PCM” (page 70).

<u>STANDARD</u>	Normally select this position.
TV MODE	Makes the low sounds clear even if you turn the volume down.
WIDE RANGE	Gives you the feeling of being at a live performance.

◆ DOWNMIX (DVD only)

Switches the method for mixing down to 2 channels when you play a DVD which has rear sound elements (channels) or is recorded in Dolby Digital format. For details on the rear signal components, see “Displaying the audio information of the disc” (page 50). This function affects the output of the following jacks:

- LINE OUT L/R (AUDIO) 1/2 jacks
- DIGITAL OUT (OPTICAL or COAXIAL) jack when “DOLBY DIGITAL” is set to “D-PCM” (page 70).

<u>DOLBY SURROUND</u>	Select this when the player is connected to an audio component that conforms to Dolby Surround (Pro Logic).
NORMAL	Select this when the player is connected to an audio component that does not conform to Dolby Surround (Pro Logic).

◆ DIGITAL OUT

Selects if audio signals are output via the DIGITAL OUT (OPTICAL or COAXIAL) jack.

<u>ON</u>	Normally select this position. When you select “ON,” see “Setting the digital output signal” for further settings.
OFF	The influence of the digital circuit upon the analog circuit is minimal.

Setting the digital output signal

Switches the method of outputting audio signals when you connect a component such as an amplifier (receiver) or MD deck with a digital input jack.

For connection details, see page 20. Select “DOLBY DIGITAL,” “MPEG,” and “DTS” after setting “DIGITAL OUT” to “ON.”

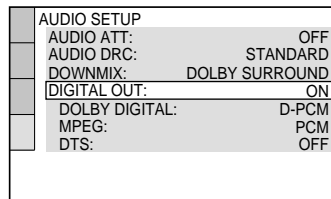

If you connect a component that does not conform to the selected audio signal, a loud noise (or no sound) will come out from the speakers, affecting your ears or causing the speakers to be damaged.

◆ **DOLBY DIGITAL (DVD only)**

Selects the type of Dolby Digital signal.

<u>D-PCM</u>	Select this when the player is connected to an audio component lacking a built-in Dolby Digital decoder. You can select whether the signals conform to Dolby Surround (Pro Logic) or not by making adjustments to the "DOWNMIX" item in "AUDIO SETUP" (page 69).
DOLBY DIGITAL	Select this when the player is connected to an audio component with a built-in Dolby Digital decoder.

◆ **MPEG (DVD only)**

Selects the type of MPEG audio signal.

<u>PCM</u>	Select this when the player is connected to an audio component lacking a built-in MPEG decoder. If you play MPEG audio sound tracks, the player outputs stereo signals via the DIGITAL OUT (OPTICAL or COAXIAL) jack.
MPEG	Select this when the player is connected to an audio component with a built-in MPEG decoder.

◆ **DTS (DVD only)**

Selects whether or not to output DTS signals.

<u>OFF</u>	Select this when the player is connected to an audio component lacking a built-in DTS decoder.
ON	Select this when the player is connected to an audio component with a built-in DTS decoder.

Note

When you use the DIGITAL OUT (OPTICAL or COAXIAL) jack to listen to MPEG audio signals and set "MPEG" to "MPEG" in "AUDIO SETUP," no sound will come from your speakers if you select one of the TVS modes.

Troubleshooting

If you experience any of the following difficulties while using the player, use this troubleshooting guide to help remedy the problem before requesting repairs. Should any problem persist, consult your nearest Sony dealer.

Power

The power is not turned on.

- ➔ Check that the power cord (mains lead) is connected securely.

Picture

There is no picture/picture noise appears.

- ➔ Re-connect the connecting cord securely.
- ➔ The connecting cords are damaged.
- ➔ Check the connection to your TV (page 18) and switch the input selector on your TV so that the signal from the player appears on the TV screen.
- ➔ The disc is dirty or flawed.
- ➔ If the picture output from your player goes through your VCR to get to your TV or if you are connected to a combination TV/VIDEO player, the copy-protection signal applied to some DVD programmes could affect picture quality. If you still experience problems even when you connect your player directly to your TV, please try connecting your player to your TV's S VIDEO input (page 18).
- ➔ If the colour system of your player does not match with that of your TV, change the colour system of the player. For details, see page 16. (You cannot change the colour system of the DVD disc itself.)

Even though you set the aspect ratio in "TV TYPE" of "SCREEN SETUP," the picture does not fill the screen.

- ➔ The aspect ratio of the disc is fixed on your DVD.

Sound

There is no sound.

- ➔ Re-connect the connecting cord securely.
- ➔ The connecting cord is damaged.
- ➔ The player is connected to the wrong input jack on the amplifier (receiver) (page 22, 23, 24).
- ➔ The amplifier (receiver) input is not correctly set.
- ➔ The player is in pause mode or in Slow-motion Play mode.
- ➔ The player is in fast forward or fast reverse mode.
- ➔ If the audio signal does not come through the DIGITAL OUT (OPTICAL or COAXIAL) jack, check the audio settings (page 69).
- ➔ While playing a Super VCD on which the audio track 2 is not recorded, no sound will come out when you select "2:STEREO," "2:1/L," or "2:2/R."

Sound is noisy.

- ➔ When playing a CD with DTS sound tracks, noise will come from the LINE OUT L/R (AUDIO) 1/2 jacks or DIGITAL OUT (OPTICAL or COAXIAL) jack (page 28).

Sound distortion occurs.

- ➔ Set "AUDIO ATT" in "AUDIO SETUP" to "ON" (page 69).

The sound volume is low.

- ➔ The sound volume is low on some DVDs. The sound volume may improve if you set "AUDIO DRC" to "TV MODE" (page 69).
- ➔ Set "AUDIO ATT" in "AUDIO SETUP" to "OFF" (page 69).

Operation

The remote does not function.

- ➔ There are obstacles between the remote and the player.
- ➔ The distance between the remote and the player is too far.
- ➔ The remote is not pointed at the remote sensor on the player.
- ➔ The batteries in the remote are weak.

The disc does not play.

- ➔ The disc is turned over.
Insert the disc with the playback side facing down on the disc tray.
- ➔ The disc is skewed.
- ➔ The player cannot play certain discs (page 6).
- ➔ The region code on the DVD does not match the player.
- ➔ Moisture has condensed inside the player (page 3).
- ➔ The player cannot play CD-Rs, CD-RWs, DVD-Rs, or DVD-RWs (video mode) that are not finalized (page 6).

The MP3 audio track cannot be played (page 34).

- ➔ The DATA CD is not recorded in the MP3 format that conforms to ISO9660 Level 1/Level 2 or Joliet.
- ➔ The MP3 audio track does not have the extension “.MP3.”
- ➔ The data is not formatted in MP3 even though it has the extension “.MP3.”
- ➔ The data is not MPEG1 Audio Layer 3 data.
- ➔ The player cannot play audio tracks in MP3PRO format.

The title of the MP3 audio album or track is not correctly displayed.

- ➔ The player can only display numbers and alphabet. Other characters are displayed as “*.”

The disc does not start playing from the beginning.

- ➔ Programme Play, Shuffle Play, Repeat Play, or A-B Repeat Play has been selected (page 35).
- ➔ Resume play has taken effect (page 31).

The player starts playing the disc automatically.

- ➔ The disc features an auto playback function.
- ➔ “AUTO PLAY” in “CUSTOM SETUP” is set to “ON” (page 67).

Playback stops automatically.

- ➔ While playing discs with an auto pause signal, the player stops playback at the auto pause signal.

You cannot perform some functions such as Stop, Search, Slow-motion Play, Repeat Play, Shuffle Play, or Programme Play.

- ➔ Depending on the disc, you may not be able to do some of the operations above. See the operating manual that comes with the disc.

The language for the sound track cannot be changed.

- ➔ Try using the DVD’s menu instead of the direct selection button on the remote (page 32).
- ➔ Multilingual tracks are not recorded on the DVD being played.
- ➔ The DVD prohibits the changing of the language for the sound track.

The subtitle language cannot be changed or turned off.

- ➔ Try using the DVD’s menu instead of the direct selection button on the remote (page 32).
- ➔ Multilingual subtitles are not recorded on the DVD being played.
- ➔ The DVD prohibits the changing of the subtitles.

The angles cannot be changed.

- ➔ Try using the DVD’s menu instead of the direct selection button on the remote (page 32).
- ➔ Multi-angles are not recorded on the DVD being played.
- ➔ The angle can only be changed when the “ANGLE” indicator lights up on the front panel display (page 9).
- ➔ The DVD prohibits changing of the angles.

The player does not operate properly.

- ➔ When static electricity, etc., causes the player to operate abnormally, unplug the player.

Nothing is displayed on the front panel display.

- ➔ "DIMMER" in "CUSTOM SETUP" is set to "OFF." Set "DIMMER" to "BRIGHT" or "DARK" (page 67).

5 numbers or letters are displayed on the screen and on the front panel display.

- ➔ The self-diagnosis function was activated. (See the table on page 73.)

The disc tray does not open and "LOCKED" appears on the front panel display.

- ➔ Child Lock is set (page 29).

The disc tray does not open and "TRAY LOCKED" appears on the front panel display.

- ➔ Contact your Sony dealer or local authorized Sony service facility.

"Data error" appears on the TV screen when playing a DATA CD.

- ➔ The MP3 audio track you want to play is broken.
- ➔ The data is not MPEG 1 Audio Layer 3 data.

Self-diagnosis Function

(When letters/numbers appear in the display)

When the self-diagnosis function is activated to prevent the player from malfunctioning, a five-character service number (e.g., C 13 50) with a combination of a letter and four digits appears on the screen and the front panel display. In this case, check the following table.

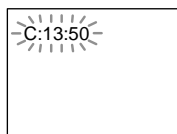

First three characters of the service number	Cause and/or corrective action
C 13	The disc is dirty. ➔ Clean the disc with a soft cloth (page 7).
C 31	The disc is not inserted correctly. ➔ Re-insert the disc correctly.
E XX (xx is a number)	To prevent a malfunction, the player has performed the self-diagnosis function. ➔ Contact your nearest Sony dealer or local authorized Sony service facility and give the 5-character service number. Example: E 61 10

Glossary

Chapter (page 9)

Sections of a picture or a music feature that are smaller than titles. A title is composed of several chapters. Depending on the disc, no chapters may be recorded.

Dolby Digital (page 24, 70)

Digital audio compression technology developed by Dolby Laboratories. This technology conforms to 5.1-channel surround sound. The rear channel is stereo and there is a discrete subwoofer channel in this format. Dolby Digital provides the same 5.1 discrete channels of high quality digital audio found in Dolby Digital cinema audio systems. Good channel separation is realized because all of the channel data are recorded discretely and little deterioration is realized because all channel data processing is digital.

Dolby Surround (Pro Logic) (page 23)

Audio signal processing technology that Dolby Laboratories developed for surround sound. When the input signal contains a surround component, the Pro Logic process outputs the front, centre and rear signals. The rear channel is monaural.

DTS (page 24, 70)

Digital audio compression technology that Digital Theater Systems, Inc. developed. This technology conforms to 5.1-channel surround sound. The rear channel is stereo and there is a discrete subwoofer channel in this format. DTS provides the same 5.1 discrete channels of high quality digital audio. Good channel separation is realized because all of the channel data is recorded discretely and little deterioration is realized because all channel data processing is digital.

DVD (page 6)

A disc that contains up to 8 hours of moving pictures even though its diameter is the same as a CD.

The data capacity of a single-layer and single-sided DVD is 4.7 GB (Giga Byte), which is 7 times that of a CD. The data capacity of a double-layer and single-sided DVD is 8.5

GB, a single-layer and double-sided DVD is 9.4 GB, and double-layer and double-sided DVD is 17GB.

The picture data uses the MPEG 2 format, one of the worldwide standards of digital compression technology. The picture data is compressed to about 1/40 (average) of its original size. The DVD also uses a variable rate coding technology that changes the data to be allocated according to the status of the picture. Audio information is recorded in a multi-channel format, such as Dolby Digital, allowing you to enjoy a more real audio presence.

Furthermore, various advanced functions such as the multi-angle, multilingual, and Parental Control functions are provided with the DVD.

Index (CD)/Video Index (VIDEO CD) (page 9)

A number that divides a track into sections to easily locate the point you want on a CD or VIDEO CD. Depending on the disc, no index may be recorded.

MPEG audio (page 24, 70)

International standard coding system used to compress audio digital signals authorized by ISO/IEC. MPEG 1 conforms to up to 2-channel stereo. MPEG 2, used on DVDs, conforms to up to 7.1-channel surround.

Scene (page 9)

On a VIDEO CD with PBC (playback control) functions, the menu screens, moving pictures and still pictures are divided into sections called "scenes."

Title (page 9)

The longest section of a picture or music feature on a DVD, movie, etc., in video software, or the entire album in audio software.

Track (page 9)

Sections of a picture or a music feature on a CD or VIDEO CD (the length of a song).

Specifications

System

Laser: Semiconductor laser

Signal format system: NTSC/PAL (See page 16 to switch)

Audio characteristics

Frequency response: DVD VIDEO (PCM 96 kHz): 2 Hz to 44 kHz (± 1.0 dB)/DVD VIDEO (PCM 48 kHz): 2 Hz to 22 kHz (± 0.5 dB)/CD: 2 Hz to 20 kHz (± 0.5 dB)

Signal-to-noise ratio (S/N ratio): 115 dB (LINE OUT L/R (AUDIO) 1/2 jacks only)

Harmonic distortion: 0.003 %

Dynamic range: DVD VIDEO: 103 dB/CD: 99 dB

Wow and flutter: Less than detected value ($\pm 0.001\%$ W PEAK)

The signals from LINE OUT L/R (AUDIO) 1/2 jacks are measured. When you play PCM sound tracks with a 96 kHz sampling frequency, the output signals from the DIGITAL OUT (OPTICAL or COAXIAL) jack are converted to 48 kHz sampling frequency.

Outputs and Input

(**Jack name:** Jack type/Output level/Load impedance)

LINE OUT (AUDIO) 1/2: Phono jack/
2 V_{rms}/10 kilohms

DIGITAL OUT (OPTICAL): Optical output jack/ -18 dBm (wave length: 660 nm)

DIGITAL OUT (COAXIAL): Phono jack/
0.5 V_{p-p}/75 ohms

COMPONENT VIDEO OUT (Y, C_B, C_R):
Phono jack/Y: 1.0 V_{p-p}, C_B, C_R:
0.7 V_{p-p}/75 ohms

LINE OUT (VIDEO) 1/2: Phono jack/
1.0 V_{p-p}/75 ohms

S VIDEO OUT: 4-pin mini DIN/Y:
1.0 V_{p-p}, C: 0.3 V_{p-p} (PAL), 0.286 V_{p-p} (NTSC)/75 ohms

MIC: Phone jack

General

Power requirements:

220 – 240 V AC, 50/60 Hz

110 V AC, 60 Hz

See page 2 for further information.

Power consumption:

 11 W/13 W

See page 2 for further information.

Dimensions (approx.): 430 × 74 × 260 mm (width/height/depth) incl. projecting parts

Mass (approx.): 2.5 kg

Operating temperature: 5 °C to 35 °C

Operating humidity: 25 % to 80 %

Supplied accessories

See page 15.

Specifications and design are subject to change without notice.

Language Code List

For details, see pages 50, 53, 65.

The language spellings conform to the ISO 639: 1988 (E/F) standard.

Code Language	Code Language	Code Language	Code Language
1027 Afar	1183 Irish	1347 Maori	1507 Samoan
1028 Abkhazian	1186 Scots Gaelic	1349 Macedonian	1508 Shona
1032 Afrikaans	1194 Galician	1350 Malayalam	1509 Somali
1039 Amharic	1196 Guarani	1352 Mongolian	1511 Albanian
1044 Arabic	1203 Gujarati	1353 Moldavian	1512 Serbian
1045 Assamese	1209 Hausa	1356 Marathi	1513 Siswati
1051 Aymara	1217 Hindi	1357 Malay	1514 Sesotho
1052 Azerbaijani	1226 Croatian	1358 Maltese	1515 Sundanese
1053 Bashkir	1229 Hungarian	1363 Burmese	1516 Swedish
1057 Byelorussian	1233 Armenian	1365 Nauru	1517 Swahili
1059 Bulgarian	1235 Interlingua	1369 Nepali	1521 Tamil
1060 Bihari	1239 Interlingue	1376 Dutch	1525 Telugu
1061 Bislama	1245 Inupiak	1379 Norwegian	1527 Tajik
1066 Bengali;	1248 Indonesian	1393 Occitan	1528 Thai
Bangla	1253 Icelandic	1403 (Afan)Oromo	1529 Tigrinya
1067 Tibetan	1254 Italian	1408 Oriya	1531 Turkmen
1070 Breton	1257 Hebrew	1417 Punjabi	1532 Tagalog
1079 Catalan	1261 Japanese	1428 Polish	1534 Setswana
1093 Corsican	1269 Yiddish	1435 Pashto;	1535 Tonga
1097 Czech	1283 Javanese	Pushto	1538 Turkish
1103 Welsh	1287 Georgian	1436 Portuguese	1539 Tsonga
1105 Danish	1297 Kazakh	1463 Quechua	1540 Tatar
1109 German	1298 Greenlandic	1481 Rhaeto-	1543 Twi
1130 Bhutani	1299 Cambodian	Romance	1557 Ukrainian
1142 Greek	1300 Kannada	1482 Kirundi	1564 Urdu
1144 English	1301 Korean	1483 Romanian	1572 Uzbek
1145 Esperanto	1305 Kashmiri	1489 Russian	1581 Vietnamese
1149 Spanish	1307 Kurdish	1491 Kinyarwanda	1587 Volapük
1150 Estonian	1311 Kirghiz	1495 Sanskrit	1613 Wolof
1151 Basque	1313 Latin	1498 Sindhi	1632 Xhosa
1157 Persian	1326 Lingala	1501 Sangho	1665 Yoruba
1165 Finnish	1327 Laothian	1502 Serbo-	1684 Chinese
1166 Fiji	1332 Lithuanian	Croatian	1697 Zulu
1171 Faroese	1334 Latvian;	1503 Singhalese	
1174 French	Lettish	1505 Slovak	
1181 Frisian	1345 Malagasy	1506 Slovenian	1703 Not specified

Index

Numerics

- 16:9 66
- 4:3 LETTER BOX 66
- 4:3 PAN SCAN 66
- 5.1 Channel Surround 20

A

- A-B REPEAT 39
- ADVANCED 48
 - album 33
- ANGLE 53
- ANGLE VIEWER 42
- AUDIO 50, 65
- AUDIO ATT 69
- AUDIO DRC 69
- AUDIO SETUP 69
- AUTO PLAY 67

B

- BACKGROUND 66
- Batteries 15
- BNR 54

C

- CD 28
- CHAPTER 40
 - Chapter 74
- CHAPTER VIEWER 42
- Child Lock 29
- COLOR SYSTEM
 - adjusting for VIDEO CD 66
 - changing the output signal 16
- Connecting 18
- Continuous play
 - CD/VIDEO CD 28
 - DVD 28
- Control Menu 12
- CUSTOM 64
- CUSTOM PARENTAL CONTROL 58
- CUSTOM PICTURE MODE 55
- CUSTOM SETUP 67

D

- DATA CD 6, 33
- DIGITAL OUT 69
- Digital output 69
- DIGITAL VIDEO ENHANCER 56
- DIMMER 67
- Display
 - Control Menu display 12

- Front panel display 9
 - Setup Display 64

- DOLBY DIGITAL 24, 50, 70, 74
- DOWNMIX 69
- DTS 24, 50, 70, 74
- DVD 6, 28, 74

F

- Fast forward 30
- Fast reverse 30
- Front panel display 9

H

- Handling discs 7
- Hooking up 18

I

- INDEX 40
- Index 74

K

- Karaoke 43

L

- LANGUAGE SETUP 65
- Locating
 - a specific point by watching the TV screen 30

M

- MENU 65
- Menu
 - DVD's menu 32
 - top menu 32
- MP3 6, 33
- MPEG 24, 50, 70, 74
- MULTI-DISC RESUME 31, 68

O

- On-screen display
 - Control Menu display 12
 - Setup Display 64
- OSD 65

P

- PARENTAL CONTROL 59
- PAUSE MODE 67
- PBC Playback 32
- PICTURE NAVIGATION 41
- PLAYBACK MEMORY 68
- PRO LOGIC 23, 69, 74
- PROGRAM 35
- Programme Play 35

Q

- QUICK 65
- Quick Setup 25, 65

R

- Remote 15, 62
- REPEAT 38
- Repeat Play 38
- REPLAY 29
- Resume Play 31

S

- S VIDEO output 18
- SCENE 40
- Scene 74
- SCREEN SAVER 66
- SCREEN SETUP 66
- Searching 30
- SETUP 64
- Setup Display 64
- SHUFFLE 37
- Shuffle Play 37
- Slow-motion Play 30
- Speakers
 - Hooking up 20
- STROBE PLAYBACK 42
- SUBTITLE 53, 65
- SURROUND 20, 51

T

- TIME/TEXT 40, 46
- TITLE 40
- Title 74
- TITLE VIEWER 42
- TOP MENU 32
- TRACK 40
- Track 74
- TRACK SELECTION 68
- TRACK VIEWER 42
- Troubleshooting 71
- TV TYPE 66
- TVS (TV Virtual Surround) 51

U

- Usable discs 6

V

- VIDEO CD 6, 28
- VOCAL SELECT 44

