

Multi Channel AV Receiver

Operating Instructions

STR-DG820

©2008 Sony Corporation

WARNING

To reduce the risk of fire or electric shock, do not expose this apparatus to rain or moisture.

To reduce the risk of fire, do not cover the ventilation opening of the apparatus with newspapers, tablecloths, curtains, etc. Do not place the naked flame sources such as lighted candles on the apparatus.

To reduce the risk of fire or electric shock, do not expose this apparatus to dripping or splashing, and do not place objects filled with liquids, such as vases, on the apparatus.

Do not install the appliance in a confined space, such as a bookcase or built-in cabinet.

As the main plug is used to disconnect the unit from the mains, connect the unit to an easily accessible AC outlet. Should you notice an abnormality in the unit, disconnect the main plug from the AC outlet immediately.

Do not expose batteries or apparatus with battery-installed to excessive heat such as sunshine, fire or the like.

For customers in Europe



Disposal of Old Electrical & Electronic Equipment (Applicable in the European Union and other European countries with separate collection systems)

This symbol on the product or on its packaging indicates that this product shall not be treated as household waste. Instead it shall be handed over to the applicable collection point for the recycling of electrical and electronic equipment. By ensuring this product is disposed of correctly, you will help prevent potential negative consequences for the environment and human health, which could otherwise be caused by inappropriate waste handling of this product. The recycling of materials will help to conserve natural resources. For more detailed information about recycling of this product, please contact your local Civic Office, your household waste disposal service or the shop where you purchased the product.



Disposal of waste batteries (applicable in the European Union and other European countries with separate collection systems)

This symbol on the battery or on the packaging indicates that the battery provided with this product shall not be treated as household waste.

By ensuring these batteries are disposed of correctly, you will help prevent potentially negative consequences for the environment and human health which could otherwise be caused by inappropriate waste handling of the battery. The recycling of the materials will help to conserve natural resources.

In case of products that for safety, performance or data integrity reasons require a permanent connection with an incorporated battery, this battery should be replaced by qualified service staff only.

To ensure that the battery will be treated properly, hand over the product at end-of-life to the applicable collection point for the recycling of electrical and electronic equipment.

For all other batteries, please view the section on how to remove the battery from the product safely. Hand the battery over to the applicable collection point for the recycling of waste batteries. For more detailed information about recycling of this product or battery, please contact your local Civic Office, your household waste disposal service or the shop where you purchased the product.

Notice for the customer in the countries applying EU Directives

The manufacturer of this product is Sony Corporation, 1-7-1 Konan Minato-ku Tokyo, 108-0075 Japan. The Authorized Representative for EMC and product safety is Sony Deutschland GmbH, Hedelfinger Strasse 61, 70327 Stuttgart, Germany. For any service or guarantee matters please refer to the addresses given in separate service or guarantee documents.

About This Manual

- The instructions in this manual are for model STR-DG820. Check your model number by looking at the lower right corner of the front panel. In this manual, models of area code CEL is used for illustration purposes unless stated otherwise. Any difference in operation is clearly indicated in the text, for example, “Models of area code CEK only”.
- The instructions in this manual describe the controls on the supplied remote. You can also use the controls on the receiver if they have the same or similar names as those on the remote.

About area codes

The area code of the receiver you purchased is shown on the lower right portion of the rear panel (see the illustration below).

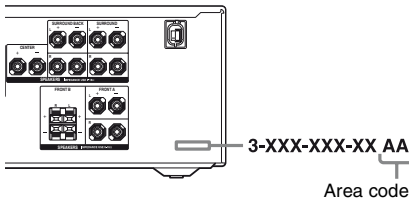

Any differences in operation, according to the area code, are clearly indicated in the text, for example, “Models of area code AA only”.

This receiver incorporates Dolby* Digital and Pro Logic Surround and the DTS** Digital Surround System.

- * Manufactured under license from Dolby Laboratories. Dolby, Pro Logic, Surround EX, and the double-D symbol are trademarks of Dolby Laboratories.
- ** Manufactured under license under U.S. Patent #'s: 5,451,942; 5,956,674; 5,974,380; 5,978,762; 6,226,616; 6,487,535 & other U.S. and worldwide patents issued & pending. DTS is a registered trademark and the DTS logos, Symbol, DTS-HD and DTS-HD Master Audio are trademarks of DTS, Inc. © 1996-2007 DTS, Inc. All Rights Reserved.

This receiver incorporates High-Definition Multimedia Interface (HDMI™) technology. HDMI, the HDMI logo and High-Definition Multimedia Interface are trademarks or registered trademarks of HDMI Licensing LLC.

This product is manufactured under license from Neural Audio Corporation and THX Ltd. Sony Corporation hereby grants the user a non-exclusive, non-transferable, limited right of use to this product under USA and foreign patent, patent pending and other technology or trademarks owned by Neural Audio Corporation and THX Ltd. “Neural Surround”, “Neural Audio”, “Neural” and “NRL” are trademarks and logos owned by Neural Audio Corporation, THX is a trademark of THX Ltd., which may be registered in some jurisdictions. All rights reserved.

“x.v.Colour” and “x.v.Colour” logo are trademarks of Sony Corporation.

“BRAVIA” and BRAVIA are trademarks of Sony Corporation.

Table of Contents

Getting Started

Description and location of parts.....	6
1: Installing the speakers	16
2: Connecting the speakers	17
3: Connecting the TV	19
4a: Connecting the audio components.....	21
4b: Connecting the video components	22
5: Connecting the antennas (aerials).....	28
6: Preparing the receiver and the remote	29
7: Selecting the speaker system.....	30
8: Calibrating the appropriate settings automatically (AUTO CALIBRATION).....	31
9: Adjusting the speaker levels and balance (TEST TONE)	37

Playback

Selecting a component.....	38
Listening/Watching a component	40

Amplifier Operations

Navigating through menus.....	42
Adjusting the level (LEVEL menu).....	47
Settings for the speakers (SPEAKER menu).....	48
Settings for the surround sound (SURROUND menu).....	51
Adjusting the equalizer (EQ menu)	52
Settings for the tuner (TUNER menu).....	52
Settings for the audio (AUDIO menu).....	53
Settings for the HDMI (HDMI menu).....	54
Settings for the system (SYSTEM menu).....	55

Enjoying Surround Sound

Enjoying a pre-programmed sound field	56
Enjoying the surround effect at low volume levels (NIGHT MODE)	61
Using only the front speakers (2CH STEREO)	62
Listening to the sound without any adjustment (ANALOG DIRECT).....	62
Resetting sound fields to the initial settings	63

Tuner Operations

Listening to FM/AM radio.....	63
Presetting radio stations	65
Using the Radio Data System (RDS).....	68
(Models of area code CEL, CEK, ECE only)	

Control for HDMI

Using the Control for HDMI function for “BRAVIA” Sync	70
Preparing Control for HDMI function	72
Watching a DVD (One-Touch Play)	73
Enjoying the TV sound from the speakers connected to the receiver (System Audio Control).....	74
Turning off the receiver with the TV (System Power Off)	75

Other Operations

Switching between digital and analog audio (INPUT MODE)	75
Listening to digital sound from other inputs (DIGITAL ASSIGN)	76
Enjoying the DIGITAL MEDIA PORT (DMPORT)	78
Naming inputs	80
Changing the display	81
Using the Sleep Timer	81
Recording using the receiver.....	82

Using the Remote

Programming the remote.....	83
-----------------------------	----

Additional Information

Glossary	88
Precautions	91
Troubleshooting	92
Specifications	97
Index.....	99

Description and location of parts

Front panel

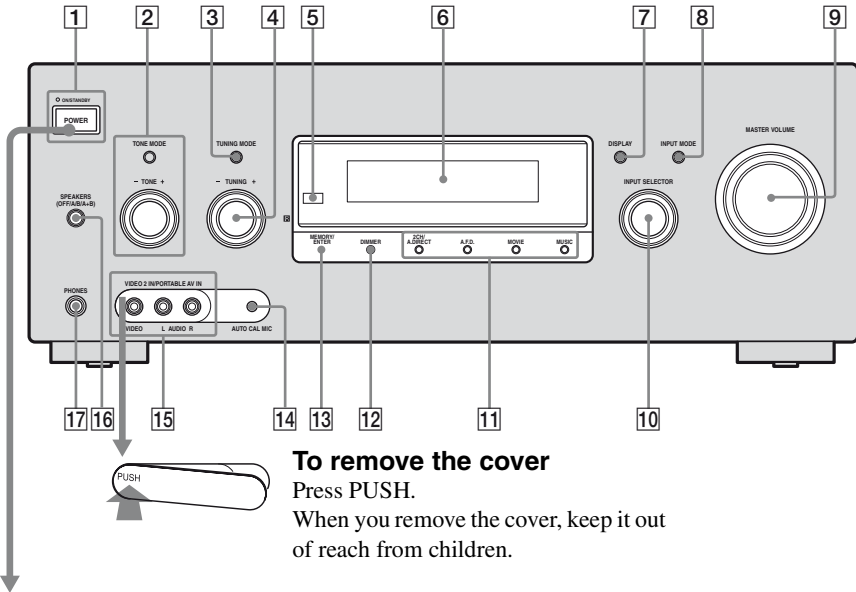

To remove the cover

Press PUSH.

When you remove the cover, keep it out of reach from children.

Status of the POWER button

Off

The receiver is turned off (initial setting).

The ON/STANDBY lamp lights off.

Press POWER to turn the receiver on.

You cannot turn the receiver on using the remote.

On/Standby

Press I/⏻ on the remote to turn the receiver on or set it to the standby mode.

When you press POWER on the receiver, the receiver will be turned off.

The ON/STANDBY lamp lights up in green when the receiver is on.

The ON/STANDBY lamp lights up in red when the receiver is set to standby mode.

Name	Function
1 POWER	Press to turn the receiver on or off (page 6, 29, 40, 41, 98).
ON/STANDBY lamp	Show the status of the receiver (page 6).
2 TONE MODE	Adjusts the tonal quality (bass/treble level) of the front speakers.
TONE +/-	Press TONE MODE repeatedly to select bass or treble level, then turn TONE +/- to adjust the level (page 29, 52).
3 TUNING MODE	Press to select the tuning mode (page 64, 67, 98).
4 TUNING +/-	Turn to scan a station (page 64, 67).
5 Remote sensor	Receives signals from remote commander.
6 Display window	The current status of the selected component or a list of selectable items appears here (page 8).
7 DISPLAY	Press repeatedly to select information displayed on the display (page 81, 94).
8 INPUT MODE	Press to select the input mode when the same components are connected to both digital and analog jacks (page 75).
9 MASTER VOLUME	Turn to adjust the volume level of all speakers at the same time (page 37, 38, 40, 41).
10 INPUT SELECTOR	Turn to select the input source to playback (page 38, 64, 67, 75, 80, 82).
11 2CH/A.DIRECT	Press to select a sound field (page 29, 57, 59, 62).
A.F.D.	
MOVIE	
MUSIC	
12 DIMMER	Press repeatedly to adjust the brightness of the display.

Name	Function
13 MEMORY/ ENTER	Press to store a station or enter the selection when selecting the settings (page 65, 66).
14 AUTO CAL MIC jack	Connects to the supplied optimizer microphone for the Digital Cinema Auto Calibration function (page 32).
15 VIDEO 2 IN/ PORTABLE AV IN jacks	Connects to a portable audio/video component such as a camcorder or video game (page 27, 38).
16 SPEAKERS (OFF/A/B/A+B)	Switch to OFF, A, B, A+B of the front speakers (page 30).
17 PHONES jack	Connects to headphones (page 92).

About the indicators on the display

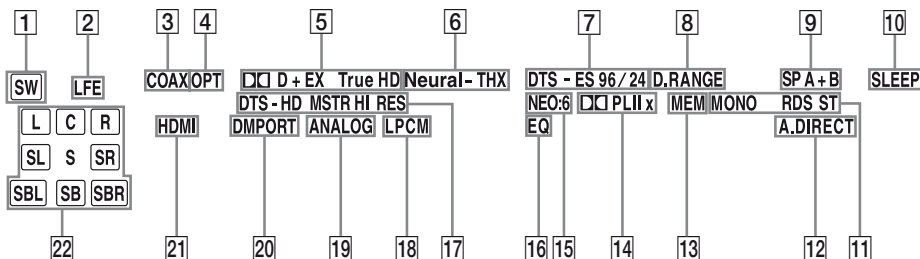

Name	Function
1 SW	Lights up when the audio signal is output from the SUBWOOFER jacks.
2 LFE	Lights up when the disc being played back contains an LFE (Low Frequency Effect) channel and the LFE channel signal is actually being reproduced.
3 COAX	Lights up when INPUT MODE is set to "AUTO" and the source signal is a digital signal being input through the COAXIAL jack or when INPUT MODE is set to "COAX" (page 75).
4 OPT	Lights up when INPUT MODE is set to "AUTO" and the source signal is a digital signal being input through the OPTICAL jack or when INPUT MODE is set to "OPT" (page 75).
5 <input type="checkbox"/> D/ <input type="checkbox"/> D EX/ <input type="checkbox"/> D+/ <input type="checkbox"/> TrueHD	<p>"<input type="checkbox"/> D" lights up when the receiver is decoding Dolby Digital signals.</p> <p>"<input type="checkbox"/> D EX" lights up when the receiver is decoding Dolby Digital Surround EX signals.</p> <p>"<input type="checkbox"/> D+" lights up when the receiver is decoding Dolby Digital Plus signals.</p> <p>"<input type="checkbox"/> TrueHD" lights up when the receiver is decoding Dolby TrueHD signals.</p> <p>Note When playing a Dolby Digital format disc, be sure that you have made digital connections and that INPUT MODE is set to "AUTO" (page 75).</p>

Name	Function
6 Neural - THX	Lights up when the receiver applies Neural - THX processing to input signals.
7 DTS/ DTS-ES/ DTS 96/24	<p>"DTS" lights up when the receiver is decoding DTS signals.</p> <p>"DTS-ES" lights up when the receiver is decoding DTS-ES signals.</p> <p>"DTS 96/24" lights up when the receiver is decoding DTS 96 kHz/24 bit signals.</p> <p>Note When playing a DTS format disc, be sure that you have made digital connections and that INPUT MODE is set to "AUTO" (page 75).</p>
8 D.RANGE	Lights up when dynamic range compression is activated (page 48).
9 SP A/SP B/ SP A+B	Lights up according to the speaker system used (page 30). However, these indicators do not light up if the speaker output is turned off or if headphones are connected.
10 SLEEP	Lights up when the sleep timer is activated (page 81).
11 Tuner indicators	<p>Lights up when using the receiver to tune in radio stations (page 63), etc.</p> <p>Note "RDS" appears for models of area code CEL, CEK, ECE only.</p>

Name	Function
12 A.DIRECT	Lights up when the receiver is processing Analog Direct signals.
13 MEM	Lights up when a memory function, such as Preset Memory (page 65), etc., is activated.
14 □□ PL/ □□ PL II/ □□ PL IIX	“□□ PL” lights up when the receiver applies Pro Logic processing to 2 channel signals in order to output the center and surround channel signals. “□□ PL II” lights up when the Pro Logic II decoder is activated. “□□ PL IIX” lights up when the Pro Logic IIX decoder is activated.
15 NEO:6	Lights up when DTS Neo:6 Cinema/Music decoder is activated (page 59).
16 EQ	Lights up when the equalizer is activated.
17 DTS-HD MSTR/ DTS-HD HI RES	“DTS-HD MSTR” lights up when the receiver is decoding DTS-HD Master Audio signals. “DTS-HD HI RES” lights up when the receiver is decoding DTS-HD High Resolution signals.
18 LPCM	Lights up when Linear PCM signals are detected.
19 ANALOG	Lights up when INPUT MODE is set to “ANALOG” or no digital signals are detected when INPUT MODE is set to “AUTO” (page 75).
20 DMPORT	Lights up when DIGITAL MEDIA PORT adapter is connected and “DMPORT” is selected.
21 HDMI	Lights up when the receiver recognizes a component connected via an HDMI IN jack (page 23).

Name	Function
22 Playback channel indicators	The letters (L, C, R, etc.) indicate the channels being played back. The boxes around the letters vary to show how the receiver downmixes the source sound (based on the speaker settings).
L	Front Left
R	Front Right
C	Center (monaural)
SL	Surround Left
SR	Surround Right
S	Surround (monaural or the surround components obtained by Pro Logic processing)
SBL	Surround Back Left
SBR	Surround Back Right
SB	Surround Back (the surround back components obtained by 6.1 channel decoding)
	Example: Speaker pattern: 3/0.1 Recording format: 3/2.1 Sound Field: A.F.D. AUTO

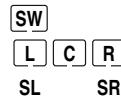

Rear panel

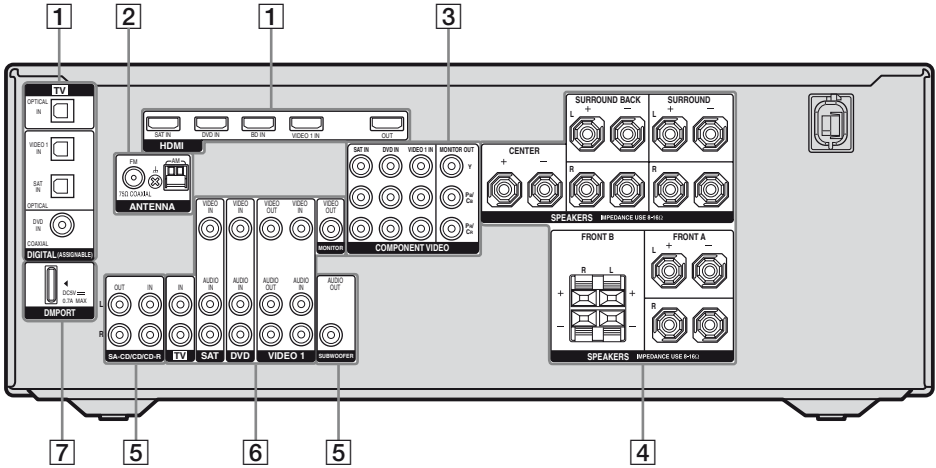

1 DIGITAL INPUT/OUTPUT section



OPTICAL IN Connects to a DVD player, etc. The



COAXIAL IN jack provides a better sound quality (page 19, 25, 26, 27).



HDMI IN/OUT* jacks Connects to a DVD player, satellite tuner, or a Blu-ray disc player, etc. The image is output to a TV or a projector while the sound can be output from a TV or/and speakers connected to this receiver (page 23).

2 ANTENNA section



FM ANTENNA jack Connects to the supplied FM wire antenna (page 28).



AM ANTENNA terminals Connects to the supplied AM loop antenna (page 28).

3 COMPONENT VIDEO INPUT/OUTPUT section



Green (Y) Connects to a DVD player, TV, satellite tuner, etc. (page 19, 25, 26, 27).



Blue (Pb/Cb)



Red (Pr/Cr)

4 SPEAKERS section

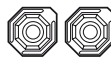

Connects to speakers (page 17).

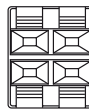

5 AUDIO INPUT/OUTPUT section



White (L) **AUDIO IN/OUT** jacks Connects to a Super Audio CD player, etc. (page 19, 21).





Red (R)



Black **AUDIO OUT** jack Connects to a subwoofer (page 17).

6 VIDEO/AUDIO INPUT/OUTPUT section

	White (L) AUDIO IN/ OUT jacks	Connects to a VCR, DVD player, etc. (page 25 – 27).
	Red (R)	
	Yellow VIDEO IN/ OUT* jacks	

7 DMPORT section



DMPORT jack	Connects to a DIGITAL MEDIA PORT adapter (page 79).
----------------	--

* You can watch the selected input image when you connect the HDMI OUT or MONITOR OUT jack to a TV (page 19, 23).

Remote commander

You can use the supplied remote to operate the receiver and to control the Sony audio/video components that the remote is assigned to operate.

You can also program the remote to control non-Sony audio/video components. For details, see “Programming the remote” (page 83).



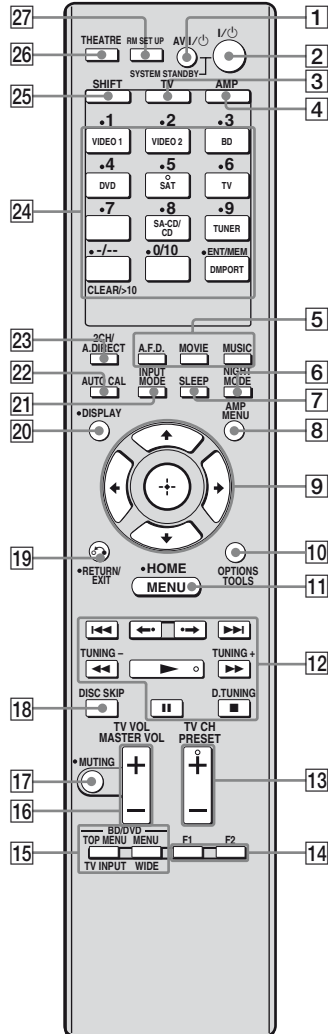

RM-AAP022













continued



Name	Function
1 AV I/⏻ (on/standby)	<p>Press to turn on or off the audio/video components that the remote is programmed to operate.</p> <p>To turn the TV on or off, press TV (3) and then press AV I/⏻.</p> <p>If you press I/⏻ (2) at the same time, it will turn off the receiver and other components (SYSTEM STANDBY).</p> <p>Note The function of the AV I/⏻ switch changes automatically each time you press the input buttons (24).</p>
2 I/⏻ (on/standby)	<p>Press to turn the receiver on or set it to standby mode.</p> <p>To turn off all components, press I/⏻ and AV I/⏻ (1) at the same time (SYSTEM STANDBY).</p> <p>To save the power in standby mode, set "CTRL:HDMI" to "CTRL OFF" (page 46).</p>
3 TV	<p>Press to light up the button. It changes the remote key function to activate the buttons with yellow printing. It also activate the + (9), ↕/↔/↔ (9), OPTIONS TOOLS (10), MENU/HOME (11), RETURN/EXIT ↶ (19), and DISPLAY (20) buttons to perform menu operations for Sony TVs only.</p>
4 AMP	<p>Press to light up the button to activate the receiver operation (page 33).</p>
5 A.F.D. MOVIE MUSIC	<p>Press to select a sound field (page 57, 59).</p>
6 NIGHT MODE	<p>Press to activate the Night Mode function (page 61).</p>
7 SLEEP	<p>Press to activate the Sleep Timer function and the duration which the receiver turns off automatically.</p>
8 AMP MENU	<p>Press to display the menu to operate the receiver.</p>

Name	Function
9 + , ↕/↔/↔	<p>After pressing AMP (4), press MENU/HOME (11) for receiver operation, then press ↕/↔/↔ to select the settings.</p> <p>After pressing BD/DVD TOP MENU (15) or BD/DVD MENU (15), press ↕/↔/↔ to select the settings, and then press + to enter the selection.</p> <p>Press + also to enter the selection of the receiver, VCR, satellite tuner, DVD player, Blu-ray disc recorder, PSX, DVD/VHS COMBO, or DVD/HDD COMBO.</p>
10 OPTIONS TOOLS	<p>Press to display and select items from the options menus for DVD player or Blu-ray disc player.</p> <p>To display the options of Sony TV, press TV (3) and then press OPTIONS TOOLS.</p>
11 MENU/HOME	<p>Press to display the menus of the receiver, VCR, DVD player, satellite tuner, Blu-ray disc recorder, PSX, DVD/VHS COMBO, or DVD/HDD COMBO on the TV screen.</p> <p>Then, use ↕/↔/↔ and + to perform menu operations.</p> <p>To display the menus of Sony TV, press TV (3) and then press MENU.</p>
12 ⏮/⏭/⏪^a	<p>Press to skip tracks of the VCR, CD player, VCD player, LD player, DVD player, MD deck, DAT deck, tape deck, Blu-ray disc recorder, PSX, DVD/VHS COMBO, or DVD/HDD COMBO.</p>
↶/↷	<p>Press to replay the previous scene or fast forward the current scene of the DVD player, Blu-ray disc recorder, DVD/VHS COMBO, or DVD/HDD COMBO.</p>

Name	Function
 a)	Press to – search tracks in the forward/backward direction of the CD player, VCD player, DVD player, LD player, MD deck, Blu-ray disc recorder, PSX, DVD/VHS COMBO, or DVD/HDD COMBO. – fast forward/rewind of the VCR, DAT deck, or tape deck.
 a)b)	Press to start playback of the VCR, CD player, VCD player, LD player, DVD player, MD deck, DAT deck, tape deck, Blu-ray disc recorder, PSX, DVD/VHS COMBO, or DVD/HDD COMBO.
 a)	Press to pause playback or recording of the VCR, CD player, VCD player, LD player, DVD player, MD deck, DAT deck, tape deck, Blu-ray disc recorder, PSX, DVD/VHS COMBO, or DVD/HDD COMBO. (Also starts recording with components in recording standby.)
 a)	Press to stop playback of the VCR, CD player, VCD player, LD player, DVD player, MD deck, DAT deck, tape deck, Blu-ray disc recorder, PSX, DVD/VHS COMBO, or DVD/HDD COMBO.
TUNING +/-	Press to scan a station.
D.TUNING	Press to enter direct tuning mode.
13 TV CH +^b)/-	Press TV [3] and then press TV CH +/- to select preset TV channels.
PRESET +^b)/-	Press to – select preset stations. – select preset channels of the VCR, satellite tuner, Blu-ray disc recorder, DVD player, DVD/VHS COMBO, or DVD/HDD COMBO.

Name	Function
14 F1, F2	Press F1 or F2 to select a component. • DVD/HDD COMBO F1: HDD mode F2: DVD mode • DVD/VHS COMBO F1: DVD mode F2: VHS mode
15 BD/DVD TOP MENU	Press to display the menu or on-screen guide of the DVD or Blu-ray disc on the TV screen. Then, use  ,  ,  ,  and  to perform menu operations.
BD/DVD MENU	Press to display the menu of the DVD or Blu-ray disc on the TV screen. Then, use  ,  ,  ,  and  to perform menu operations.
TV INPUT	Press TV [3] and then press TV INPUT to select the input signal (TV input or video input).
WIDE	Press TV [3] and then press WIDE to select the wide picture mode.
16 TV VOL +/-	Press TV [3] and then press TV VOL +/- to adjust the TV volume level.
MASTER VOL +/-	Press to adjust the volume level of all speakers at the same time.
17 MUTING	Press to turn off the sound temporarily. Press MUTING again to restore the sound. Press TV [3] and then press MUTING to activate the TV's muting function.
18 DISC SKIP	Press to skip disc of the CD player, VCD player, DVD player, or MD deck (multi-disc changer only).

continued

Name	Function
19 RETURN/ EXIT 	<p>Press to</p> <ul style="list-style-type: none"> – return to the previous menu. – exit the menu while the menu or on-screen guide of the VCD player, LD player, DVD player, Blu-ray disc recorder, PSX, DVD/VHS COMBO, or satellite tuner is displayed on the TV screen. <p>To return to the previous menu of Sony TV, press TV (3) and then press RETURN/EXIT .</p>
20 DISPLAY	<p>Press to select information displayed on the display window or TV screen of the VCR, VCD player, LD player, DVD player, CD player, MD deck, Blu-ray disc recorder, PSX, satellite tuner, DVD/VHS COMBO, or DVD/HDD COMBO.</p> <p>To select information of Sony TV, press TV (3) and then press DISPLAY.</p>
21 INPUT MODE	<p>Press AMP (4), then press INPUT MODE to select the input mode when the same components are connected to both digital and analog jacks (page 75).</p>
22 AUTO CAL	<p>Press to activate the Digital Cinema Auto Calibration function.</p>
23 2CH/ A.DIRECT	<p>Press to select sound field (page 62) or to switch the audio of the selected input to analog signal without any adjustment (page 62).</p>

Name	Function
24 Input buttons	<p>Press one of the buttons to select the component you want to use. When you press any of the input buttons, the receiver turns on. The buttons are factory assigned to control Sony components as follows. You can program the remote to control non-Sony components following the steps in “Programming the remote” on page 83.</p>
Button	Assigned Sony component
VIDEO 1	VCR (VTR mode 3)
VIDEO 2	VCR (VTR mode 2)
BD	Blu-ray disc player
DVD	DVD player
SAT	Satellite tuner
TV	TV
SA-CD/CD	Super Audio CD/CD player
TUNER	Built-in tuner
DMPORT	DIGITAL MEDIA PORT adapter

Numeric buttons (number 5^b)	<p>Press SHIFT (25) and then press numeric buttons to</p> <ul style="list-style-type: none"> – preset/tune to preset stations. – select track numbers of the CD player, VCD player, LD player, DVD player, MD deck, DAT deck, or tape deck. Press 0/10 to select track number 10. – select channel numbers of the VCR, satellite tuner, Blu-ray disc recorder, PSX, DVD/VHS COMBO, or DVD/HDD COMBO. <p>Press TV (3) and then press the numeric buttons to select the TV channels.</p>
---	---

Name	Function
ENT/MEM	<p>Press SHIFT (25) and then press ENT/MEM to enter the value after selecting a channel, disc or track using the numeric buttons of the VCR, CD player, VCD player, LD player, MD deck, DAT deck, tape deck, satellite tuner, Blu-ray disc recorder, or PSX.</p> <p>To enter the value of Sony TV, press TV (3) and then press ENT/MEM.</p> <p>Press SHIFT (25) and then press ENT/MEM to store a station during tuner operation.</p>
CLEAR/>10	<p>Press SHIFT (25) and then press CLEAR/>10 to clear a mistake when you press the incorrect numeric button of the DVD player, Blu-ray disc recorder, PSX, satellite tuner, DVD/VHS COMBO, or DVD/HDD COMBO.</p> <p>Press SHIFT (25) and then press CLEAR/>10 to select track numbers over 10 of the CD player, VCD player, LD player, MD deck, tape deck, TV, VCR, or satellite tuner.</p>
-/--	<p>Press SHIFT (25) and then press -/-- to select the channel entry mode, either one or two digit of the VCR or satellite tuner.</p> <p>To select the channel entry mode of the TV, press TV (3) and then press -/--.</p>
25 SHIFT	<p>Press to light up the buttons. It changes the remote button function to activate the buttons with pink printing.</p>

Name	Function
26 THEATRE	<p>Press to enjoy optimal image suited for movies and to output the sound from the speakers connected to this receiver automatically.</p> <p>Note This button will only function if your TV is compatible with Theatre Mode. Refer to the operating instructions supplied with the TV for details.</p>
27 RM SET UP	<p>Press to set up the remote.</p>

a) This button is also available for DIGITAL MEDIA PORT adapter operation. For details on the function of the button, refer to the operating instructions supplied with the DIGITAL MEDIA PORT adapter.

b) The number 5/SAT, TV CH +/PRESET + and ▷ buttons have tactile dots. Use the tactile dots as references when operating the receiver.

Notes

- Some functions explained in this section may not work depending on the model.
- The above explanation is intended to serve as an example only. Therefore, depending on the component, the above operation may not be possible or may operate differently than described.

1: Installing the speakers

This receiver allows you to use a 7.1 channel system (7 speakers and one subwoofer).

Enjoying a 5.1/7.1 channel system

To fully enjoy theater-like multi channel surround sound requires five speakers (two front speakers, a center speaker, and two surround speakers) and a subwoofer (5.1 channel).

Example of a 5.1 channel speaker system configuration

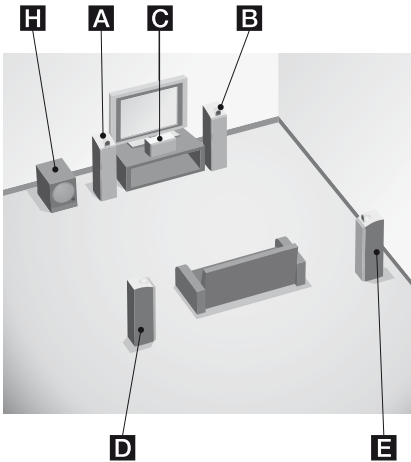

- A** Front speaker (Left)
- B** Front speaker (Right)
- C** Center speaker
- D** Surround speaker (Left)
- E** Surround speaker (Right)
- H** Subwoofer

You can enjoy high fidelity reproduction of DVD software recorded sound in the Surround EX format if you connect one additional surround back speaker (6.1 channel) or two surround back speakers (7.1 channel).

Example of a 7.1 channel speaker system configuration

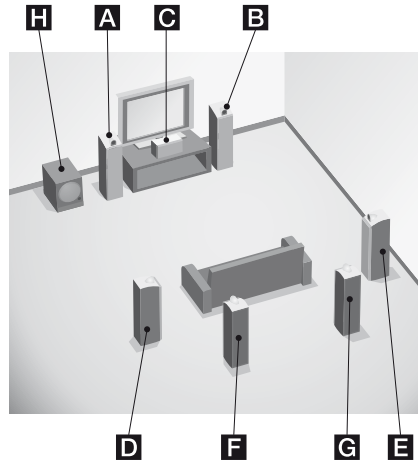

- A** Front speaker (Left)
- B** Front speaker (Right)
- C** Center speaker
- D** Surround speaker (Left)
- E** Surround speaker (Right)
- F** Surround back speaker (Left)
- G** Surround back speaker (Right)
- H** Subwoofer

Tips

- When you connect a 6.1 channel speaker system, place the surround back speaker behind the listening position (page 49).
- Since the subwoofer does not emit highly directional signals, you can place it wherever you want.

2: Connecting the speakers

Before connecting the cords, be sure to disconnect the AC power cord (mains lead).

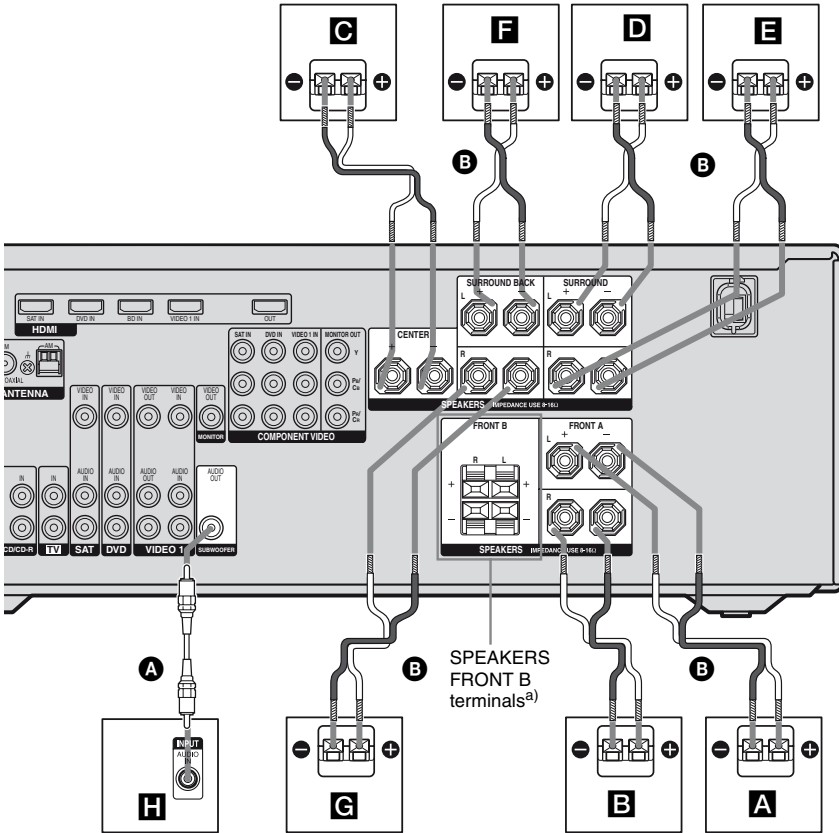

- A** Monaural audio cord (not supplied)
- B** Speaker cord (not supplied)

- A** Front speaker A (Left)
- B** Front speaker A (Right)
- C** Center speaker
- D** Surround speaker (Left)

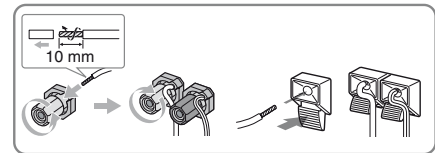

- E** Surround speaker (Right)
- F** Surround back speaker (Left)^{b)}
- G** Surround back speaker (Right)^{b)}
- H** Subwoofer^{c)}

continued

- a) If you have an additional front speaker system, connect them to the SPEAKERS FRONT B terminals. You can select the front speakers you want to use with the SPEAKERS (OFF/A/B/A+B) button on the receiver (page 30).
- b) If you connect only one surround back speaker, connect it to the SPEAKERS SURROUND BACK L terminals.
- c) When you connect a subwoofer with an auto standby function, turn off the function when watching movies. If the auto standby function is set to on, it turns to standby mode automatically based on the level of the input signal to a subwoofer, then sound may not be output.

Note

Before connecting the AC power cord (mains lead), make sure that metallic wires of the speaker cords are not touching each other between the SPEAKERS terminals.

Selecting a speaker pattern

After you have install and connect your speaker, be sure to select the speaker pattern from SPEAKER menu (page 44).

Select the speaker pattern according to your speaker setting. For details of each parameter, see the table as follows.

Speaker pattern	Speaker connected					
	Front left/right	Center	Surround left/right	Surround back left	Surround back right	Subwoofer
3/4.1	<input type="radio"/>	<input type="radio"/>	<input type="radio"/>	<input type="radio"/>	<input type="radio"/>	<input type="radio"/>
3/4	<input type="radio"/>	<input type="radio"/>	<input type="radio"/>	<input type="radio"/>	<input type="radio"/>	
3/3.1	<input type="radio"/>	<input type="radio"/>	<input type="radio"/>	<input type="radio"/>		<input type="radio"/>
3/3	<input type="radio"/>	<input type="radio"/>	<input type="radio"/>	<input type="radio"/>		
2/4.1	<input type="radio"/>		<input type="radio"/>	<input type="radio"/>	<input type="radio"/>	<input type="radio"/>
2/4	<input type="radio"/>		<input type="radio"/>	<input type="radio"/>	<input type="radio"/>	
3/2.1	<input type="radio"/>	<input type="radio"/>	<input type="radio"/>			<input type="radio"/>
3/2	<input type="radio"/>	<input type="radio"/>	<input type="radio"/>			
2/3.1	<input type="radio"/>		<input type="radio"/>	<input type="radio"/>		<input type="radio"/>
2/3	<input type="radio"/>		<input type="radio"/>	<input type="radio"/>		
2/2.1	<input type="radio"/>		<input type="radio"/>			<input type="radio"/>
2/2	<input type="radio"/>		<input type="radio"/>			
3/0.1	<input type="radio"/>	<input type="radio"/>				<input type="radio"/>
3/0	<input type="radio"/>	<input type="radio"/>				
2/0.1	<input type="radio"/>					<input type="radio"/>
2/0	<input type="radio"/>					

3: Connecting the TV

You can watch the selected input image when you connect the HDMI OUT or MONITOR OUT jack to a TV.

It is not necessary to connect all the cords. Connect audio and video cords according to the jacks of your components. Before connecting cords, be sure to disconnect the AC power cord.

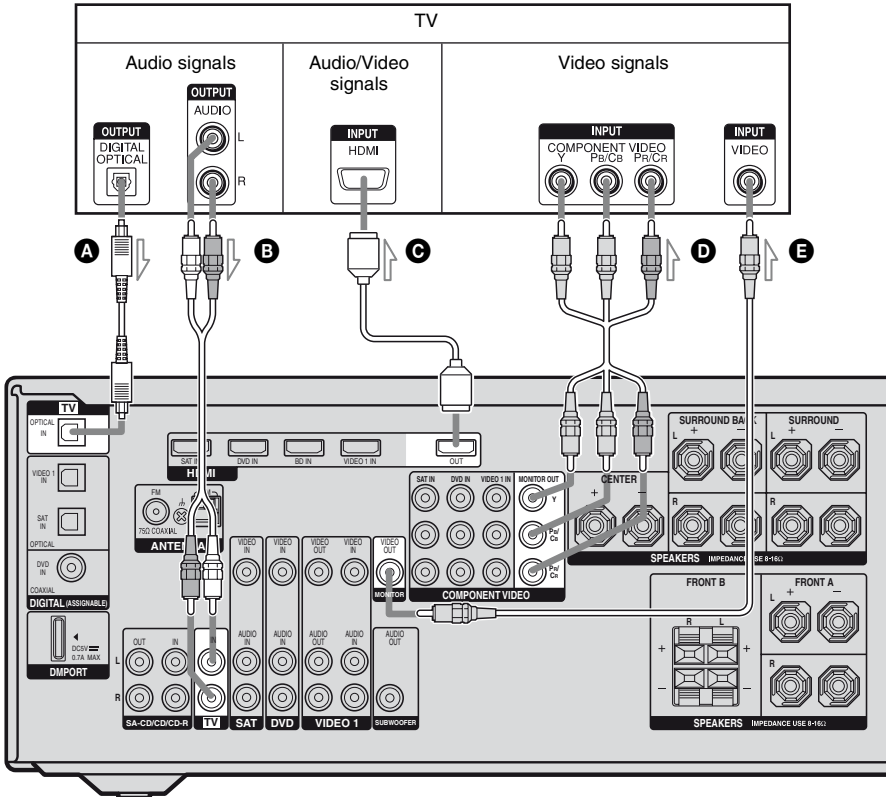

- A** Optical digital cord (not supplied)
- B** Audio cord (not supplied)
- C** HDMI cable (not supplied)

We recommend that you use a Sony HDMI cable.

- D** Component video cord (not supplied)
- E** Video cord (not supplied)

continued

Notes

- Be sure to turn on the receiver when the video and audio signals of a playback component are being output to a TV via the receiver. Unless the power is turned on, neither video nor audio signals will be transmitted.
- Connect image display components such as a TV monitor or a projector to the HDMI OUT or MONITOR OUT jack on the receiver. You may not be able to record, even if you connect recording components.
- Depending on the status of the connection between the TV and the antenna (aerial), the image on the TV screen may be distorted. In this case, place the antenna (aerial) farther away from the receiver.
- When connecting optical digital cords, insert the plugs straight in until they click into place.
- Do not bend or tie optical digital cords.

Tips

- To output the sound of the TV from the speakers connected to the receiver, be sure to
 - connect the audio output jacks of the TV to the TV IN jacks of the receiver.
 - turn off the TV's volume or activate the TV's muting function.
- All the digital audio jacks are compatible with 32 kHz, 44.1 kHz, 48 kHz, and 96 kHz sampling frequencies.

4a: Connecting the audio components

Connecting a Super Audio CD/CD player or CD recorder

The following illustration shows how to connect a Super Audio CD player, CD player or CD recorder. Before connecting cords, be sure to disconnect the AC power cord. After connecting your audio component, proceed to “4b: Connecting the video components” (page 22).

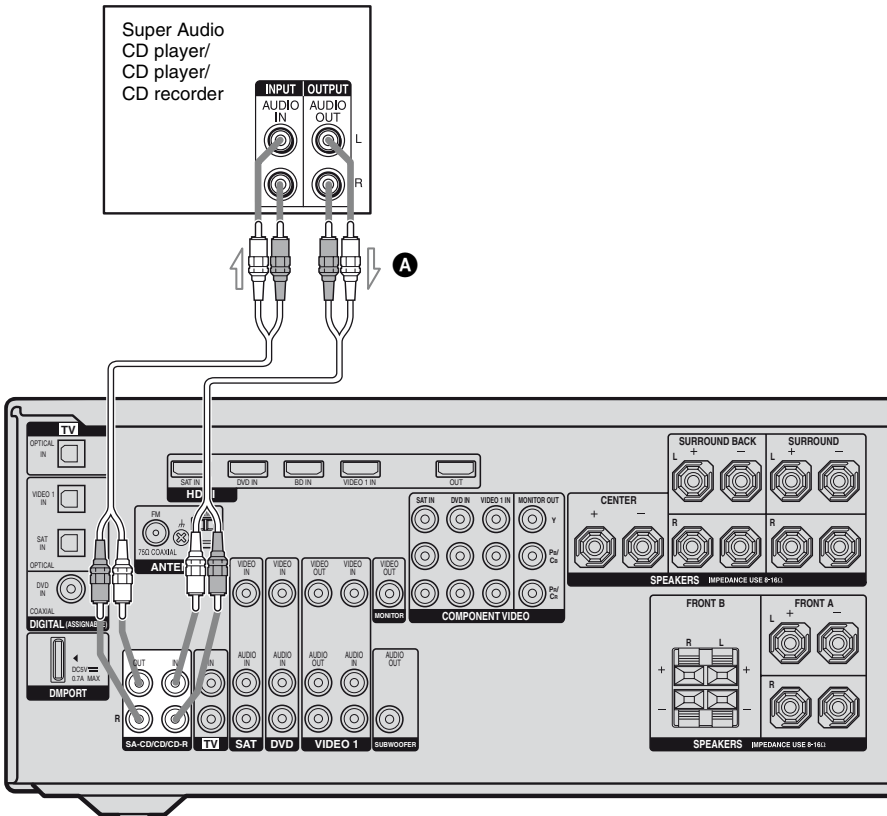

A Audio cord (not supplied)

4b: Connecting the video components

How to connect your components

This section describes how to connect your video components to this receiver. Before you begin, see “Component to be connected” below for the pages which describe how to connect each component.

After connecting all your components, proceed to “5: Connecting the antennas (aerials)” (page 28).

Component to be connected

Component	Page
TV	19
With HDMI jack	23
DVD player	25
Satellite tuner/Set-top box	26
VCR, DVD recorder	27
Camcorder, video game, etc.	27

If you want to connect several digital components, but cannot find an unused input

See “Listening to digital sound from other inputs (DIGITAL ASSIGN)” (page 76).

Video input/output jack to be connected

The image quality depends on the connecting jack. See the illustration that follows. Select the connection according to the jacks on your components.

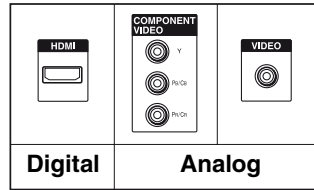

Notes

- Before connecting cords, be sure to disconnect the AC power cord.
- Be sure to turn on the receiver when the video and audio signals of a playback component are being output to a TV via the receiver. Unless the power is turned on, neither video nor audio signals will be transmitted.

Connecting components with HDMI jacks

HDMI is the abbreviated name for High-Definition Multimedia Interface. It is an interface which transmits video and audio signals in digital format.

HDMI features

- A digital audio signals transmitted by HDMI can be output from the speakers connected to the receiver. This signal supports Dolby Digital, DTS, and Linear PCM.

- This receiver can receive multi channel Linear PCM (up to 8 channels) with a sampling frequency of 192 kHz or less with an HDMI connection.
- This receiver supports High Bitrate Audio (DTS-HD Master Audio, Dolby TrueHD) and HDMI (Deep Color, x.v. Color).
- This receiver supports the Control for HDMI function. For details, see “Control for HDMI” (page 70).

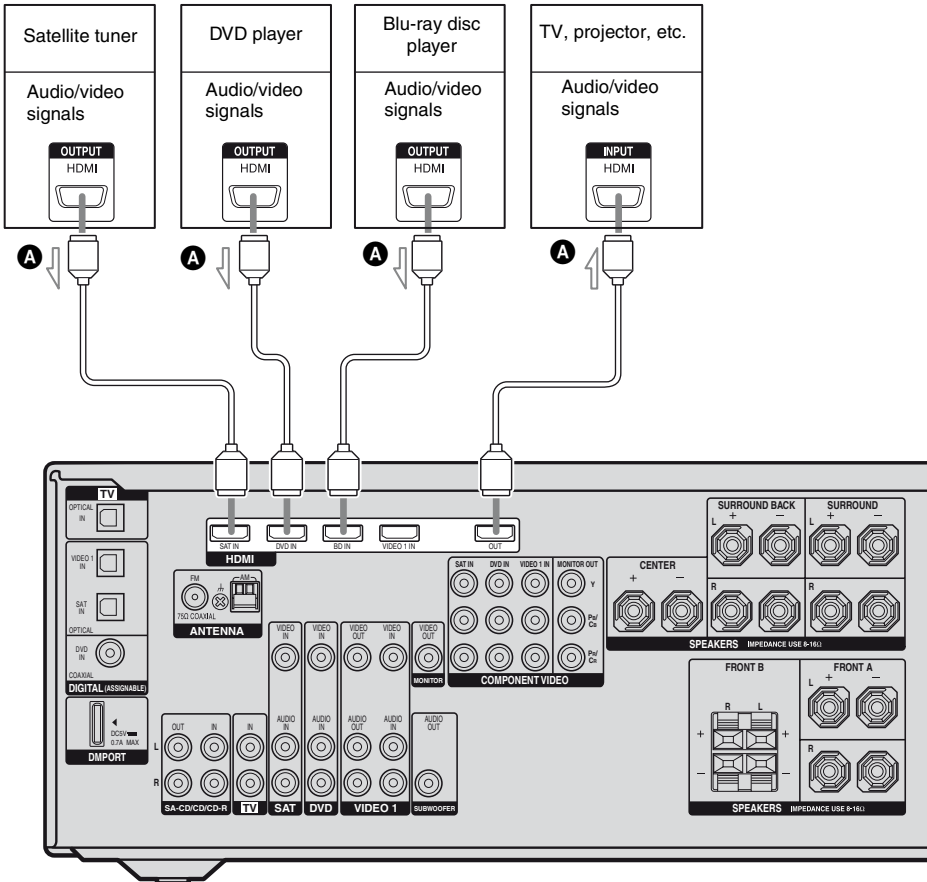

A HDMI cable (not supplied)

continued

Notes on connecting cables

- We recommend that you use a Sony HDMI cable.
- We recommend that you use an HDMI cable with the HDMI logo (made by Sony) for the HDMI jack corresponding to high speed (an HDMI version 1.3, category 2 cable) when you view images or listen to sound during a Deep Color transmission or when you watch a video image of 1080p or higher.
- We do not recommend using an HDMI-DVI conversion cable. When you connect an HDMI-DVI conversion cable to a DVI-D component, the sound and/or the image may not be output. Connect other audio cords or digital connecting cords, then set “Digital Assign” when the sound is not output correctly.

Notes on HDMI connections

- An audio signal input to the HDMI IN jack is output from the SPEAKERS jacks and HDMI OUT jack. It is not output from any other audio jacks.
- Video signals input to the HDMI IN jack can only be output from the HDMI OUT jack. The video input signals cannot be output from the VIDEO OUT jacks or MONITOR OUT jacks.
- When you want to listen to the sound from the TV speaker, set “AUDIO OUT” to “TV+AMP” in the HDMI menu (page 54). If you cannot play back multi channel software, set to “AMP”. However, the sound will not output from the TV speaker.
- DSD signals of Super Audio CD are not input and output.
- The multi/stereo area audio signals of a Super Audio CD are not output.

- Audio signals (sampling frequency, bit length, etc.) transmitted from an HDMI jack may be suppressed by the connected component. Check the setup of the connected component if the image is poor or the sound does not come out of a component connected via the HDMI cable.
- Sound may be interrupted when the sampling frequency or the number of channels of audio output signals from the playback component is switched.
- When the connected component is not compatible with copyright protection technology (HDCP), the image and/or the sound from the HDMI OUT jack may be distorted or may not be output. In this case, check the specification of the connected component.
- You can enjoy High Bitrate Audio (DTS-HD Master Audio, Dolby TrueHD), multi-channel Linear PCM only with an HDMI connection.
- Set the image resolution of the player to more than 720p/1080i to enjoy High Bitrate Audio (DTS-HD Master Audio, Dolby TrueHD).
- The image resolution of player may need certain settings be made before you can enjoy multi channel Linear PCM. Refer to the operating instructions of the player.
- Not every HDMI component supports all functions that are defined by the specified HDMI version. For example, components that support HDMI, version 1.3, may not support Deep Color.
- Refer to the operating instructions of each connected component for details.

Connecting a DVD player

The following illustration shows how to connect a DVD player.

It is not necessary to connect all the cords. Connect audio and video cords according to the jacks of your components.

Note

To input multi channel digital audio from the DVD player, set the digital audio output setting on the DVD player. Refer to the operating instructions supplied with the DVD player.

Tip

All the digital audio jacks are compatible with 32 kHz, 44.1 kHz, 48 kHz, and 96 kHz sampling frequencies.

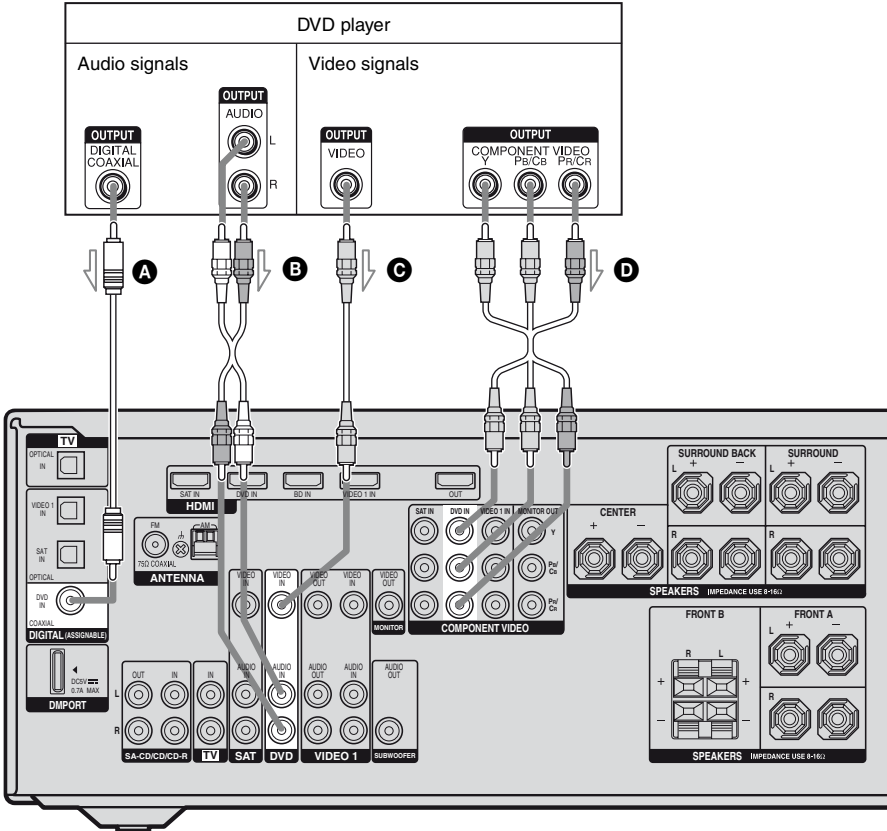

- A** Coaxial digital cord (not supplied)
- B** Audio cord (not supplied)
- C** Video cord (not supplied)
- D** Component video cord (not supplied)

Connecting a satellite tuner/ set-top box

The following illustration shows how to connect a satellite tuner or set-top box. It is not necessary to connect all the cords. Connect audio and video cords according to the jacks of your components.

Notes

- When connecting optical digital cords, insert the plugs straight in until they click into place.
- Do not bend or tie optical digital cords.

Tip

All the digital audio jacks are compatible with 32 kHz, 44.1 kHz, 48 kHz, and 96 kHz sampling frequencies.

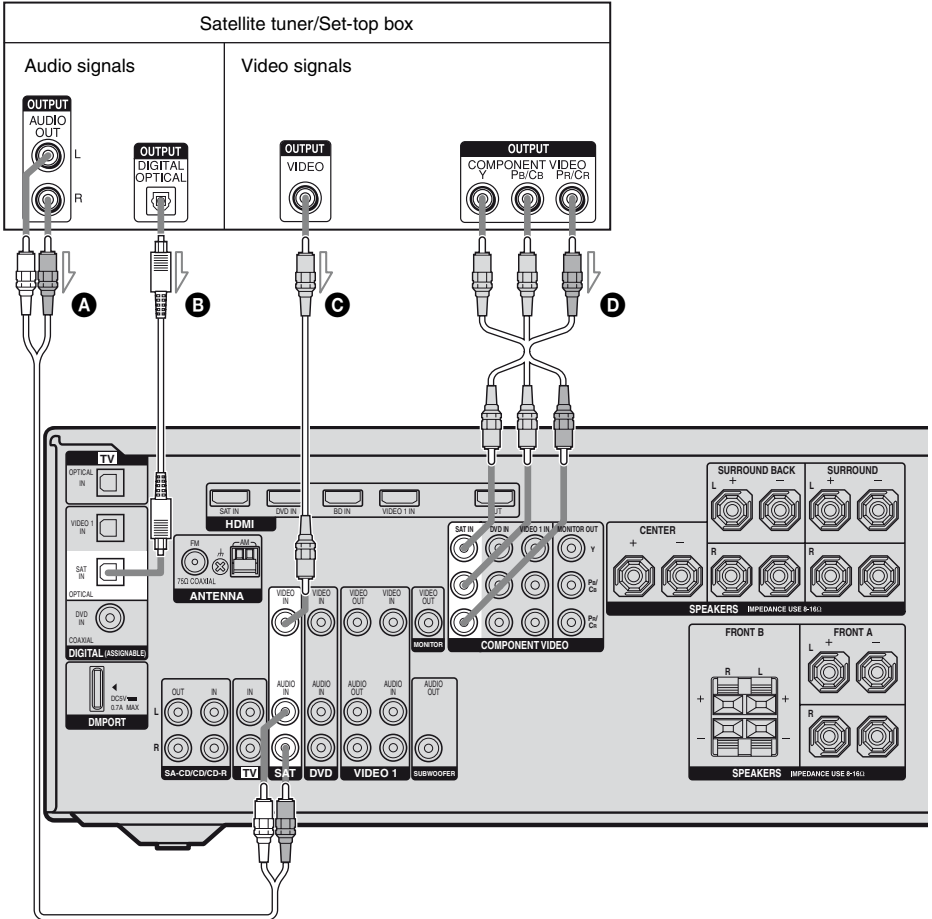

- A** Audio cord (not supplied)
- B** Optical digital cord (not supplied)
- C** Video cord (not supplied)
- D** Component video cord (not supplied)

Connecting components with analog video and audio jack

The following illustration shows how to connect a component which has analog jacks such as a VCR, DVD recorder, etc.

It is not necessary to connect all the cords. Connect audio and video cords according to the jacks of your components.

Notes

- Be sure to change the factory setting of the VIDEO 1 input button on the remote so that you can use the button to control your DVD recorder. For details, see “Programming the remote” (page 83).
- You can also rename the VIDEO 1 input so that it can be displayed on the receiver’s display. For details, see “Naming inputs” (page 80).
- When connecting optical digital cords, insert the plugs straight in until they click into place.
- Do not bend or tie optical digital cords.

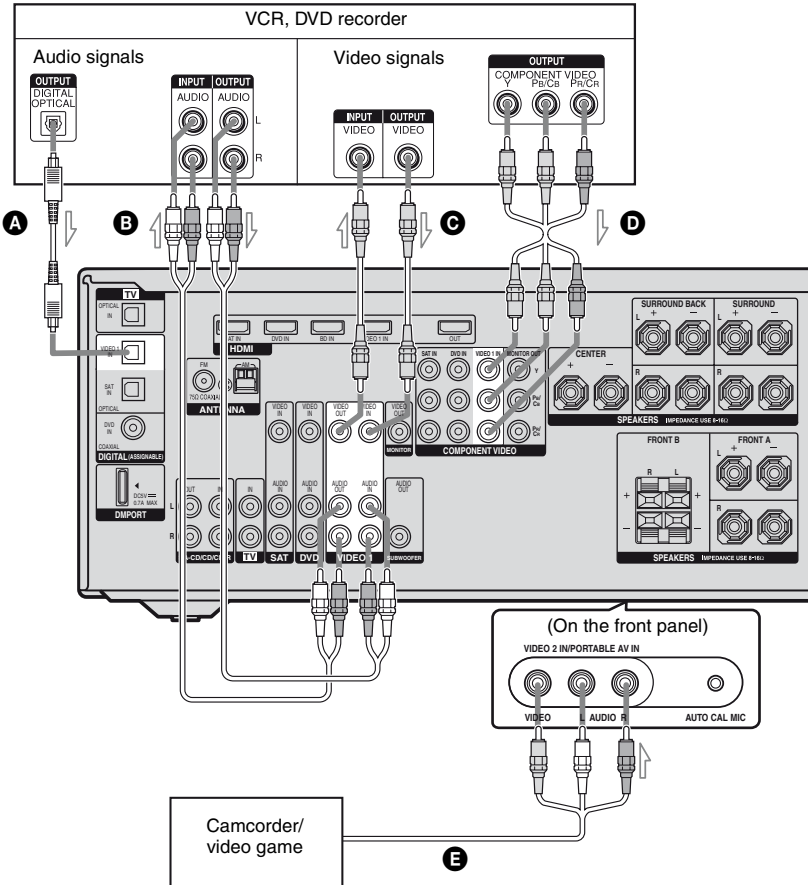

- A** Optical digital cord (not supplied)
- B** Audio cord (not supplied)
- C** Video cord (not supplied)
- D** Component video cord (not supplied)
- E** Audio/video cord (not supplied)

5: Connecting the antennas (aerials)

Connect the supplied AM loop antenna (aerial) and FM wire antenna (aerial).
 Before connecting antennas (aerials), be sure to disconnect the power cord.

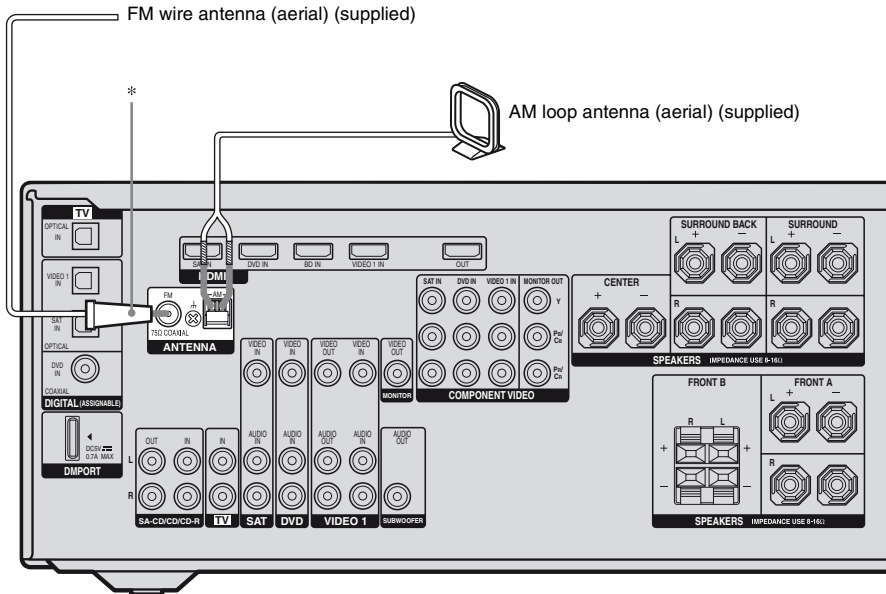

* The shape of the connector varies depending on the area code of this receiver.

Notes

- To prevent noise pickup, keep the AM loop antenna (aerial) away from the receiver and other components.
- Be sure to fully extend the FM wire antenna (aerial).
- After connecting the FM wire antenna (aerial), keep it as horizontal as possible.

6: Preparing the receiver and the remote

Connecting the AC power cord (mains lead)

Connect the AC power cord (mains lead) to a wall outlet.

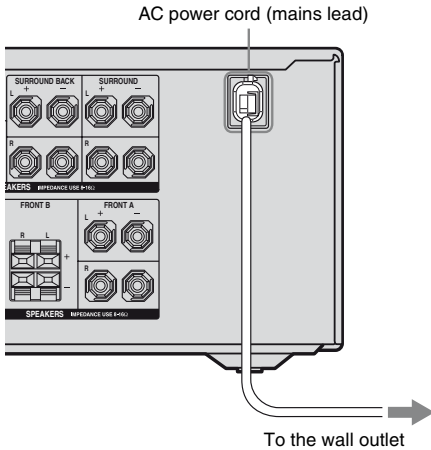

Performing initial setup operations

Before using the receiver for the first time, initialize the receiver by performing the following procedure. This procedure can also be used to return settings you have made to their factory defaults.

Be sure to use the buttons on the receiver for this operation.

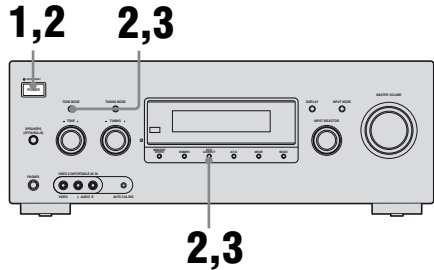

- 1** Press **POWER** to turn off the receiver.
- 2** Hold down **TONE MODE** and **2CH/A.DIRECT** and then press **POWER** to turn on the receiver.
- 3** Release the **TONE MODE** and **2CH/A.DIRECT** after a few seconds.

After “CLEARING” appears on the display for a while, “CLEARED” appears.

All the settings you have changed or adjusted are reset to the initial settings.

Inserting batteries into the remote

Insert two R6 (size-AA) batteries in the RM-AAP022 Remote Commander. Observe the correct polarity when installing batteries.

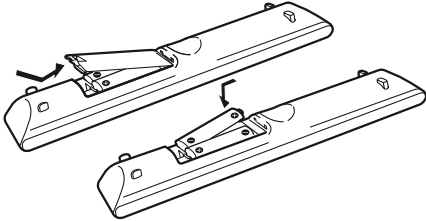

Notes

- Do not leave the remote in an extremely hot or humid place.
- Do not use a new battery with old ones.
- Do not mix manganese batteries and other kinds of batteries.
- Do not expose the remote sensor to direct sunlight or lighting apparatuses. Doing so may cause a malfunction.
- If you do not intend to use the remote for an extended period of time, remove the batteries to avoid possible damage from battery leakage and corrosion.
- When you replace the batteries, the programmed remote codes may be cleared. If this happens, program the remote codes again (page 83).

Tip

Under normal conditions, the batteries should last for about 3 months. When the remote no longer operates the receiver, replace all the batteries with new ones.

7: Selecting the speaker system

You can select the front speakers you want to drive.

Be sure to use the buttons on the receiver for this operation.

SPEAKERS (OFF/A/B/A+B)

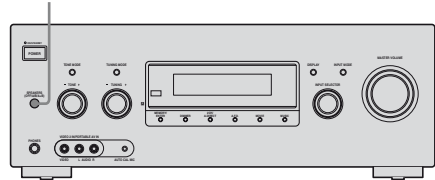

Press SPEAKERS (OFF/A/B/A+B) repeatedly to select the front speaker system you want to drive.

To select	Light up
The speakers connected to the SPEAKERS FRONT A terminals	SP A
The speakers connected to the SPEAKERS FRONT B terminals	SP B
The speakers connected to both the SPEAKERS FRONT A and B terminals (parallel connection)	SP A + B

To turn off the speaker output

Press SPEAKERS (OFF/A/B/A+B) repeatedly until the “SP A”, “SP B” and “SP A+B” indicators on the display do not light up. “ALL OFF” appears on the display for a while.

Note

You cannot switch the front speaker system by pressing SPEAKERS (OFF/A/B/A+B) when the headphones are connected.

8: Calibrating the appropriate settings automatically

(AUTO CALIBRATION)

This receiver is equipped with DCAC (Digital Cinema Auto Calibration) Technology which allows you to perform automatic calibration as follows:

- Check the connection between each speaker and the receiver.^{a)}
- Adjust the speaker level.
- Measure the distance of each speaker from your listening position.^{a)}
- Measure the speaker size.^{a)}
- Measure the speaker polarity.
- Measure the frequency characteristics.^{a)b)}

^{a)}The measurement result is not utilized in the following cases.

- ANALOG DIRECT is selected.

^{b)}The measurement result is not utilized in the following cases.

- Dolby TrueHD signals with a sampling frequency of more than 96 kHz are being received.
- PCM signals with a sampling frequency of more than 96 kHz are being received.

The DCAC is designed to obtain proper sound balance in your room. However, you can adjust the speaker levels and balance manually according to your preference. For details, see “9: Adjusting the speaker levels and balance (TEST TONE)” (page 37).

Before you perform Auto Calibration

Before you perform the Auto Calibration, set up and connect the speakers (page 16, 17).

- The AUTO CAL MIC jack is used for the supplied optimizer microphone only. Do not connect other microphones to this jack. Doing so may damage the receiver and the microphone.
- During the calibration, the sound that comes out of the speakers is very loud. The volume of the sound cannot be adjusted. Pay attention to the presence of children or to the effect on your neighborhood.
- Perform the Auto Calibration in a quiet environment to avoid the effect of noise and get a more accurate measurement.
- If there are any obstacles in the path between the optimizer microphone and the speakers, the calibration cannot be performed correctly. Remove any obstacles from the measurement area to avoid measurement error.

Notes

- The Auto Calibration function does not work in the following cases.
 - SPEAKERS (OFF/A/B/A+B) is set to off.
 - Headphones are connected.
- If you activate the muting function during Auto Calibration, the muting function will automatically be set to off.

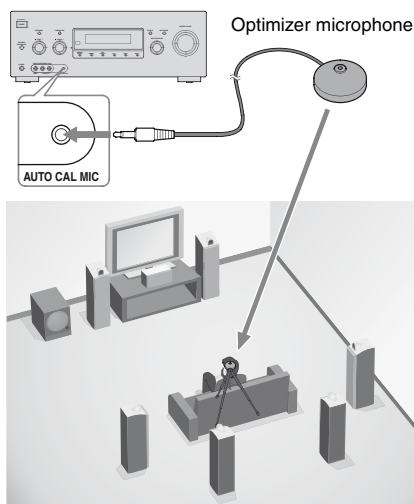

continued

1 Connect the supplied optimizer microphone to the AUTO CAL MIC jack.

2 Set up the optimizer microphone.

Place the optimizer microphone at your listening position. Use a stool or tripod so that the optimizer microphone remains at the same height as your ears.

On setting up the active subwoofer

- When a subwoofer is connected, turn on the subwoofer and turn up the volume beforehand. Turn the MASTER VOLUME knob to just before the mid-point.
- If you connect a subwoofer with a crossover frequency function, set the value to the maximum.
- If you connect a subwoofer with an auto standby function, set this function to off (deactivated).

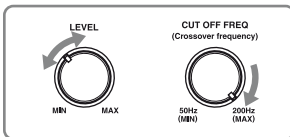

Note

Depending on the characteristics of the subwoofer you are using, the setup distance value may be further away from the actual position.

Performing Auto Calibration

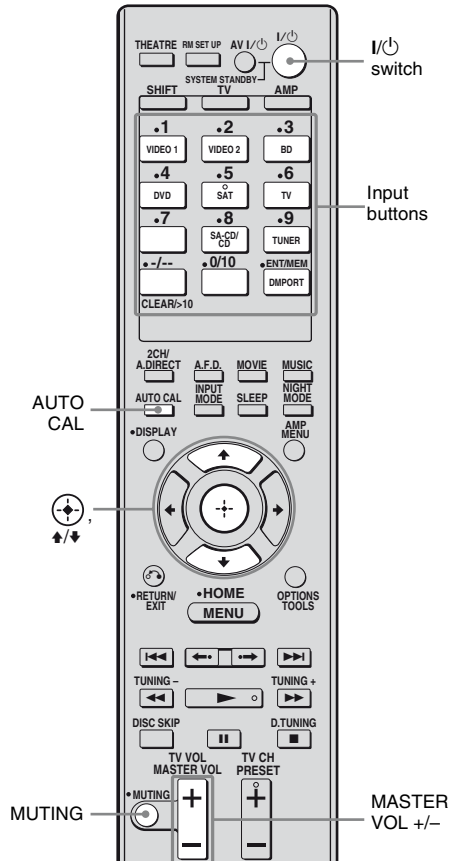

Press AUTO CAL.

Measurement starts in 5 seconds. A count down is displayed.

The measurement process will take approximately 30 seconds to complete. The table below shows the display when measurement starts.

Measurement for	Display
Speaker existence	TONE
Speaker gain, distance, frequency response	T.S.P.
Subwoofer gain and distance	WOOFER

Tips

- Operations other than turning the receiver on or off are deactivated during the measurement.
- The measurements may not be performed correctly or Auto Calibration cannot be performed when special speakers, such as dipole speakers are used.

To cancel Auto Calibration

The Auto Calibration function will be canceled when you do the following during the measurement process:

- Press I/⏻ or POWER on the receiver.
- Press the input buttons or turn the INPUT SELECTOR on the receiver.
- Change the volume level.
- Press MUTING.
- Change the setting of the SPEAKERS (OFF/A/B/A+B).
- Connect headphones.
- Press AUTO CAL again.

Confirming/saving the measurement results

1 Confirm the measurement result.

When the measurement ends, a beep sounds and the measurement result appears on the display.

Measurement result	Display	Explanation
When the measurement process completes properly	SAVE EXIT	Proceed to step 2.
When the measurement process fails	E - ■■■■:■■■	See “Message list after Auto Calibration measurement” (page 35).

2 Press AMP and then press \uparrow/\downarrow repeatedly to select the item. Then, press \oplus .

Item	Explanation
EXIT	Exits the setting process without saving the measurement results.
LEVEL INFO.	Displays the measurement result for speaker level.
DIST. INFO.	Displays the measurement result for speaker distance.
PHASE INFO.	Displays the phase of each speaker (in phase/out of phase). See “When you select “PHASE INFO.”” (page 34).
WARN CHECK	Displays warning concerning the measurement results. See “When you select “WARN CHECK”” (page 36).
SAVE EXIT	Saves the measurement results and exits the setting process.
RETRY	Performs the Auto Calibration again.

continued

3 Save the measurement result.

Select “SAVE EXIT” in step 2.

The measurement results are saved and you can select the calibration type in the AUTO CAL menu.

For details on calibration type, see page 36.

When measurement ends, “COMPLETE” appears on the display and the settings are registered as selected position number.

Note

You can select the position number to save the Auto Calibration result. Select a position number before you perform Auto Calibration. For details, see page 36.

If you do not select the position number, the Auto Calibration result will automatically save as POS. 1 (initial setting).

Tip

The size of a speaker (LARGE/SMALL) is determined by the low frequency characteristics.

The measurement results may vary, depending on the position of the optimizer microphone and speakers, and the shape of the room. It is recommended that you follow the measurement results. However, you can change those settings in the SPEAKER menu (page 48). Save the measurement results first, then try to change the settings if you want.

When you select “PHASE INFO.”

You can check the phase of each speaker (in phase/out of phase).

Press \uparrow/\downarrow repeatedly to select a speaker, then press \oplus to return to step 2 in “Confirming/saving the measurement results”.

Display	Explanation
■■■■* - IN	The speaker is in phase.
■■■■* - OUT	The speaker is out of phase. The “+” and “-” terminals of the speaker may be connected the other way around. However, depending on the speakers, “■■■■ - OUT” appears on the display even though the speakers are connected properly. This is because of the speakers’ specifications. In this case, you can continue to use the receiver.

* ■■■■ represent a speaker channel.

F	Front
FL	Front left
FR	Front right
CNT	Center
S	Surround
SL	Surround left
SR	Surround right
SB	Surround back
SBL	Surround back left
SBR	Surround back right
SW	Subwoofer

Tip

Depending on the position of the subwoofer, the measurement results for polarity may vary. However, there will be no problems even if you continue to use the receiver with that value.

After you have finished

Disconnect the optimizer microphone from the receiver.

Note

If you have reposition your speaker, we recommend that you perform Auto Calibration again to enjoy the surround sound.

Message list after Auto Calibration measurement

Display	Explanation
E - ■■■■* : 31	SPEAKERS (OFF/A/B/A+B) is set to OFF. Set it to others and perform the measurement again.
E - ■■■■* : 32	None of the speakers were detected. Make sure that the optimizer microphone is connected properly and perform the measurement again. If the optimizer microphone is connected properly but the error code appears, the optimizer microphone cable may be damaged or improperly connected.
E - ■■■■* : 33	<ul style="list-style-type: none"> • None of the front speakers are connected or only one front speaker is connected. • The optimizer microphone is not connected. • Either the left or right surround speakers is not connected. • Surround back speakers are connected even though surround speakers are not connected. Connect the surround speaker(s) to the SURROUND terminals. • The surround back speaker is connected only to the SPEAKERS SURROUND BACK R terminals. When you connect only one surround back speaker, connect it to the SPEAKERS SURROUND BACK L terminals.
W - ■■■■* : 40	The measurement has completed. However, the noise level is high. You may be able to perform the measurement properly if you try it again, even though the measurement cannot be performed in all environments. Try to perform the measurement in a quiet environment.
W - ■■■■* : 41	The sound input from the optimizer microphone is outside the acceptable range. It is louder than the loudest sound that can be measured. Try to perform the measurement when the environment is quiet enough to allow proper measurement.
W - ■■■■* : 42	The volume of the receiver is out of the acceptable range. Try to perform the measurement when the environment is quiet enough to allow proper measurement.
W - ■■■■* : 43	The distance and position of a subwoofer cannot be detected. This may be caused by noise. Try to perform the measurement in a quiet environment.
NO WARNING	There is no warning information.

* ■■■■ represent a speaker channel (F, FL, FR, CNT, S, SL, SR, SB, SBL, SBR, SW).

•Code 31

- 1 Press \oplus .
- 2 Perform the Auto Calibration again.

•Code 32, 33

- 1 When you press \oplus , “RETRY? YES” appears.
- 2 Press $\blacktriangle/\blacktriangledown$ to select “RETRY? YES”, then press \oplus .
- 3 Perform the Auto Calibration again.

When you select “WARN CHECK”

If a warning on the measurement result is present, detailed information is displayed.

Press \oplus to return to step 1 of “Confirming/saving the measurement results” (page 33).

AUTO CAL menu parameters

You can use the AUTO CAL menu to make various adjustments for Auto Calibration settings and to name inputs. Select “AUTO CAL” in the amplifier menus. For details on adjusting the parameters, see “Navigating through menus” (page 42) and “Overview of the menus” (page 43).

■ A.CAL START (Auto Calibration)

■ CAL TYPE (Calibration type)*

- FULL FLAT
Makes the measurement of frequency from each speaker flat.
- ENGINEER
Sets the frequency characteristics to a set that matches that of the Sony listening room standard.
- FRONT REF
Adjusts the characteristics of all speakers to match the characteristics of the front speaker.
- OFF
Sets the Auto Calibration equalizer level to off.

* You can select this parameter only when you have performed the Auto Calibration and saved the settings.

■ POSITION (Position)

You can register 3 patterns as position 1, 2 and 3 (POS. 1, POS. 2 and POS. 3), depending on the seating position, listening environment and measurement conditions. You can also load the registered setting.

■ NAME IN (Naming inputs)

You can rename the position name. For details, see “Naming inputs” (page 80).

9: Adjusting the speaker levels and balance (TEST TONE)

You can adjust the speaker levels and balance while listening to the test tone from your listening position.

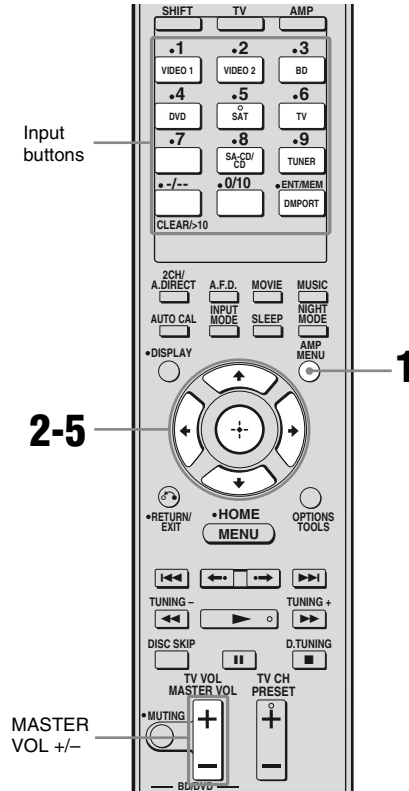

- 1 Press AMP MENU.
- 2 Press \uparrow/\downarrow repeatedly to select "LEVEL", then press \leftarrow or \rightarrow .
- 3 Press \uparrow/\downarrow repeatedly to select "TEST TONE" then press \leftarrow .

- 4 Press \uparrow/\downarrow to select the test tone type and the speaker you want to adjust.

You can select "FIX" or "AUTO". For details, see "TEST TONE (Test tone)" (page 47).

Tips

- To adjust the level of all speakers at the same time, press MASTER VOL +/- . You can also use MASTER VOLUME on the receiver.
- The adjusted value are shown on the display during adjustment.

- 5 Repeat steps 1 to 4 to select "OFF".

You can also press any input buttons. The test tone turns off.

When a test tone is not output from the speakers

- The speaker cords may not be connected securely.
- The speaker cords may have the short-circuit problem.

When a test tone is output from a different speaker than the speaker indicator showed in the front panel display.

The speaker pattern to the connected speaker is not set up correctly. Make sure the speaker connection and the speaker pattern match.

Selecting a component

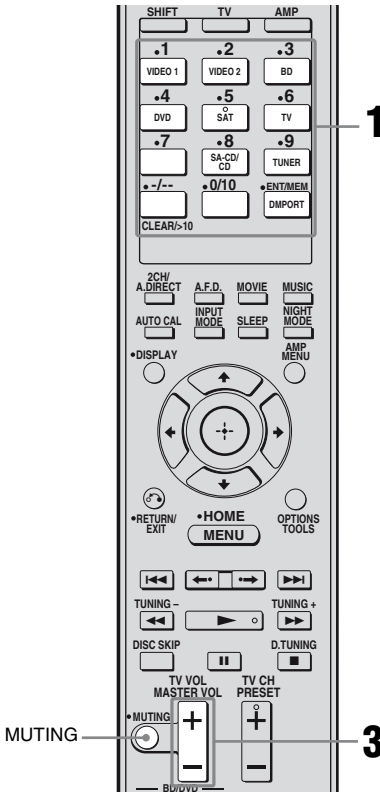

Selected input [Display]	Components that can be played back
VIDEO 1 [VIDEO 1]	VCR, etc., connected to the VIDEO 1 jack
VIDEO 2 [VIDEO 2]	Camcorder, video game, etc., connected to the VIDEO 2/PORTABLE AV IN jack
BD [BD]	Blu-ray disc player, etc., connected to the BD jack
DVD [DVD]	DVD player, etc., connected to DVD jack
SAT [SAT]	Satellite tuner, set-top box, etc., connected to SAT jack
TV [TV]	TV, etc., connected to TV jack
SA-CD/CD [SA-CD/CD/CD-R]*	Super Audio CD player, CD player, etc., connected to the SA-CD/CD/CD-R jack
TUNER [FM TUNER/AM TUNER]	Built-in radio tuner
DMPORT [DMPORT]	DIGITAL MEDIA PORT adapter connected to DMPORT jack

* "SA-CD/CD/CD-R" scroll across the display, then "SA-CD/CD" appears.

1 Press one of the input buttons to select the component you want.

You can also use INPUT SELECTOR on the receiver.
The selected input appears on the display.

2 Turn on the component and start playback.

3 Press MASTER VOL +/- to adjust the volume.

You can also use MASTER VOLUME on the receiver.

To activate the muting function

Press **MUTING** on the remote.

The muting function will be canceled when you do the following.

- Press **MUTING** again.
- Increase the volume.
- Turn off the receiver.

To avoid damaging your speakers

Before you turn off the receiver, be sure to turn down the volume level.

Listening/Watching a component

Listening to a Super Audio CD/CD

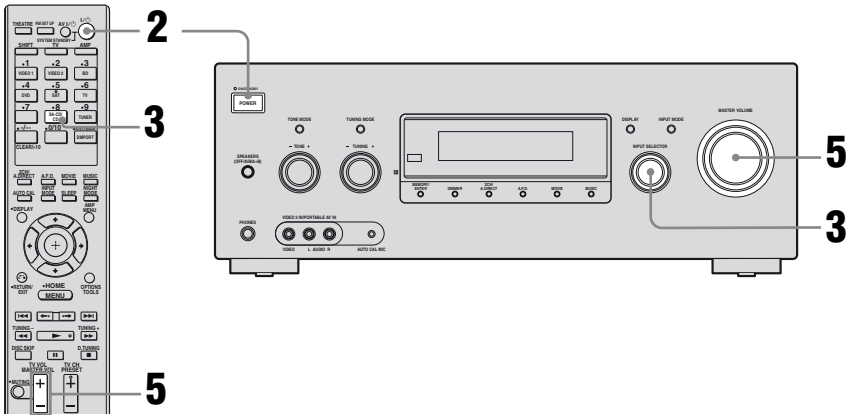

Notes

- The operation is described for a Sony Super Audio CD player.
- Refer to the operating instructions supplied with the Super Audio CD player or CD player.

Tips

- You can select the sound field to suit the music. See page 59 for details.
Recommended sound fields:
Classical: HALL
Jazz: JAZZ
Live concert: CONCERT
- You can listen to the sound that was recorded in the 2 channel format from all speakers (multi channel). See page 56 for details.

1 Turn on the Super Audio CD player or CD player, then place the disc on the tray.

2 Turn on the receiver.

3 Press SA-CD/CD.

You can also use INPUT SELECTOR on the receiver to select "SA-CD/CD/CD-R".

4 Play back the disc.

5 Adjust to a suitable volume.

6 After you have finished listening to the Super Audio CD/CD, eject the disc and turn off the receiver and Super Audio CD player or CD player.

Watching a DVD/Blu-ray Disc

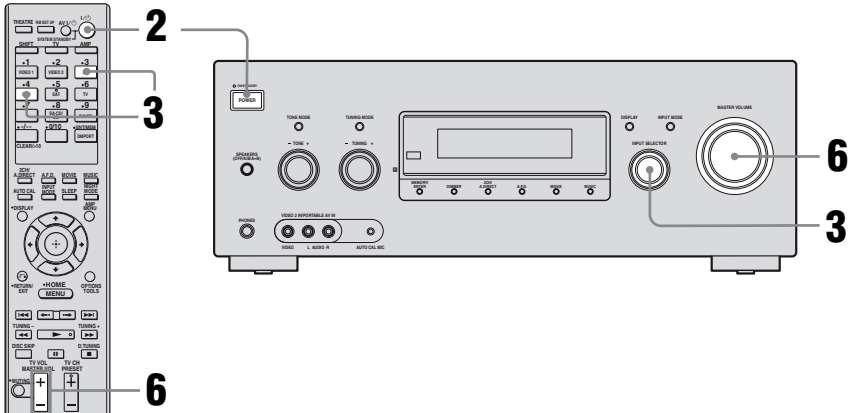

Notes

- Refer to the operating instructions supplied with the TV and DVD player/Blu-ray disc player.
- Check the following if you cannot listen to multi channel sound.
 - Be sure this receiver is connected to the DVD player/Blu-ray disc player via a digital connection.
 - Be sure the digital audio output of the DVD player/Blu-ray disc player is set up properly.

Tips

- Select the audio format of the disc to be played back, if necessary.
- You can select the sound field to suit the movie or music. See page 56 for details.
Recommended sound fields:
Movie: C.ST.EX
Music: CONCERT

- 1** Turn on the TV and DVD player/Blu-ray disc player.
- 2** Turn on the receiver.
- 3** Press DVD to watch a DVD or press BD to watch a Blu-ray disc.
You can also use INPUT SELECTOR on the receiver to select “DVD” or “BD”.
- 4** Switch the input of the TV so that an image of the DVD/Blu-ray disc is displayed.
- 5** Play back the disc.
- 6** Adjust to a suitable volume.
- 7** After you have finished watching the DVD/Blu-ray disc, eject the disc and turn off the receiver, TV and DVD player/Blu-ray disc player.

Amplifier Operations

Navigating through menus

By using the amplifier menus, you can make various adjustments to customize the receiver.

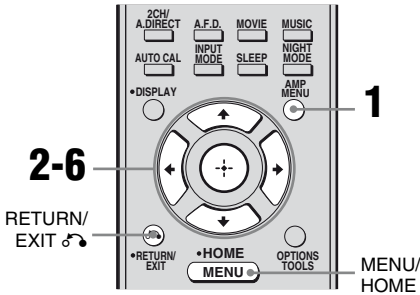

- 1** Press AMP MENU.
- 2** Press \uparrow/\downarrow repeatedly to select the menu you want.
- 3** Press \oplus or \rightarrow to enter the menu.
- 4** Press \uparrow/\downarrow repeatedly to select the parameter you want to adjust.
- 5** Press \oplus or \rightarrow to enter the parameter.
- 6** Press \uparrow/\downarrow repeatedly to select the setting you want.
The setting is entered automatically.

To return to the previous display

Press \leftarrow or RETURN/EXIT \curvearrowright .

To exit the menu

Press MENU/HOME or AMP MENU.

Note

Some parameters and settings may appear dimmed on the display. This means that they are either unavailable or fixed and unchangeable.

Overview of the menus

The following options are available in each menu. For details on navigating through menus, see page 42.

Menu [Display]	Parameters [Display]	Settings	Initial setting
AUTO CAL [AUTO CAL] (page 36)	Auto calibration [A.CAL START]		
	Calibration type ^{a)} [CAL TYPE]	FULL FLAT, ENGINEER FRONT REF, OFF	FULL FLAT
	Position ^{a)} [POSITION]	POS. 1, POS. 2, POS. 3	POS. 1
	Naming inputs ^{a)} [NAME IN]	For details, see “Naming inputs” (page 80).	
LEVEL [LEVEL] (page 47)	Test tone ^{a)(c)} [TEST TONE]	OFF, FIX ■■■■ ^{b)} , AUTO ■■■■ ^{b)}	OFF
	Phase noise ^{a)(c)} [P. NOISE]	OFF, FL/SR, SL/FL, SBL/SL, SBR/SBL, SR/SBR, SR/SL, FR/SR, FR/SL, FL/FR, CNT/FR, FL/CNT	OFF
	Phase audio ^{a)(c)} [P. AUDIO]	OFF, FL/SR, SL/FL, SBL/SL, SBR/SBL, SR/SBR, SR/SL, FR/SR, FR/SL, FL/FR, CNT/FR, FL/CNT	OFF
	Front left speaker level ^(c) [FL LEVEL]	FL -10 dB to FL +10 dB (0.5 dB per step)	0 dB
	Front right speaker level ^(c) [FR LEVEL]	FR -10 dB to FR +10 dB (0.5 dB per step)	0 dB
	Center speaker level ^(c) [CNT LEVEL]	CNT -20 dB to CNT +10 dB (0.5 dB per step)	0 dB
	Su+rround left speaker level ^(c) [SL LEVEL]	SL -20 dB to SL +10 dB (0.5 dB per step)	0 dB
	Surround right speaker level ^(c) [SR LEVEL]	SR -20 dB to SR +10 dB (0.5 dB per step)	0 dB
	Surround back speaker level ^(c) [SB LEVEL]	SB -20 dB to SB +10 dB (0.5 dB per step)	0 dB
	Surround back left speaker level ^(c) [SBL LEVEL]	SBL -20 dB to SBL +10 dB (0.5 dB per step)	0 dB
	Surround back right speaker level ^(c) [SBR LEVEL]	SBR -20 dB to SBR +10 dB (0.5 dB per step)	0 dB
	Subwoofer level ^(c) [SW LEVEL]	SW -20 dB to SW +10 dB (0.5 dB per step)	0 dB
	Dynamic range compressor ^{a)} [D. RANGE]	COMP. MAX, COMP. STD, COMP. AUTO, COMP. OFF	COMP. AUTO

Menu [Display]	Parameters [Display]	Settings	Initial setting
SPEAKER [SPEAKER] (page 48)	Speaker pattern ^{a)} [SP PATTERN]	3/4.1, 3/4, 3/3.1, 3/3, 2/4.1, 2/4, 3/2.1, 3/2, 2/3.1, 2/3, 2/2.1, 2/2, 3/0.1, 3/0, 2/0.1, 2/0	3/4.1
	Front speakers ^{a)} [FRT SP]	LARGE, SMALL	LARGE
	Center speaker ^{a)} [CNT SP]	LARGE, SMALL	LARGE
	Surround speakers ^{a)} [SUR SP]	LARGE, SMALL	LARGE
	Front left speaker distance ^{a)c)} [FL DIST.]	FL 1.00 m to FL 10.00 m (0.01 m step)	FL 3.00 m
	Front right speaker distance ^{a)c)} [FR DIST.]	FR 1.00 m to FR 10.00 m (0.01 m step)	FR 3.00 m
	Center speaker distance ^{a)c)} [CNT DIST.]	CNT 1.00 m to CNT 10.00 m (0.01 m step)	CNT 3.00 m
	Surround left speaker distance ^{a)c)} [SL DIST.]	SL 1.00 m to SL 10.00 m (0.01 m step)	SL 3.00 m
	Surround right speaker distance ^{a)c)} [SR DIST.]	SR 1.00 m to SR 10.00 m (0.01 m step)	SR 3.00 m
	Surround back speaker distance ^{a)c)} [SB DIST.]	SB 1.00 m to SB 10.00 m (0.01 m step)	SB 3.00 m
	Surround back left speaker distance ^{a)c)} [SBL DIST.]	SBL 1.00 m to SBL 10.00 m (0.01 m step)	SBL 3.00 m
	Surround back right speaker distance ^{a)c)} [SBR DIST.]	SBR 1.00 m to SBR 10.00 m (0.01 m step)	SBR 3.00 m
	Subwoofer distance ^{a)c)} [SW DIST.]	SW 1.00 m to SW 10.00 m (0.01 m step)	SW 3.00 m
	Distance unit ^{d)} [DIST. UNIT]	FEET, METER	METER
	Front speaker crossover frequency ^{a)} [FRT CROSS]	CROSS 40 Hz to CROSS 200 Hz (10 Hz step)	CROSS 120 Hz
	Center speaker crossover frequency ^{a)} [CNT CROSS]	CROSS 40 Hz to CROSS 200 Hz (10 Hz step)	CROSS 120 Hz
	Surround speaker crossover frequency ^{a)} [SUR CROSS]	CROSS 40 Hz to CROSS 200 Hz (10 Hz step)	CROSS 120 Hz

Menu [Display]	Parameters [Display]	Settings	Initial setting
SURROUND [SURROUND] (page 51)	Sound field selection [S.F. SELECT]	For details, see “Enjoying Surround Sound” (page 56).	
	Enhanced surround mode [E.SUR MODE]	PLII ^(d) , PLIIX ^(d) , NEO6 CIN, NEO6 MUS, NEURAL-THX	PLIIX
	Effect level ^(a) [EFFECT]	EFCT. 50%, EFCT. 80%, EFCT. 100%, EFCT. 150%	EFCT. 100%
EQ [EQ] (page 52)	Front speakers bass level [BASS]	BASS -10 dB to BASS +10 dB (1dB per step)	BASS 0 dB
	Front speakers treble level [TREBLE]	TREBLE -10 dB to TREBLE +10 dB (1dB per step)	TREBLE 0 dB
TUNER [TUNER] (page 52)	FM station receiving mode ^(a) [FM MODE]	STEREO, MONO	STEREO
	Naming preset stations ^(a) [NAME IN]	For details, see “Naming preset stations” (page 67).	
AUDIO [AUDIO] (page 53)	Synchronizes audio with video output ^(a) [A/V SYNC]	0 ms to 300 ms (10 ms per step)	0 ms
	Digital broadcast language selection ^(a) [DUAL MONO]	MAIN/SUB, MAIN, SUB	MAIN
	Digital audio input decoding priority ^(a) [DEC. PRIO.]	DEC. AUTO, DEC. PCM	DEC. AUTO
	Digital audio input assignment ^(a) [D. ASSIGN]	For details, see “Listening to digital sound from other inputs (DIGITAL ASSIGN)” (page 76).	

Menu [Display]	Parameters [Display]	Settings	Initial setting
HDMI [HDMI] (page 54)	Control for HDMI ^{a)} [CTRL:HDMI]	CTRL ON, CTRL OFF	CTRL OFF
	Setting HDMI audio input ^{a)} [AUDIO OUT]	AMP, TV+AMP	AMP
	Subwoofer level for HDMI ^{a)e)} [SW LEVEL]	SW AUTO, SW 0 dB, SW +10 dB	SW 0 dB
SYSTEM [SYSTEM] (page 55)	Naming inputs [NAME IN]	For details, see “Naming inputs” (page 80).	
	Brightness of the display ^{a)} [DIMMER]	100% DOWN, 60% DOWN, 0% DOWN	0% DOWN

a) For details, see the page in the parentheses.

b) ■■■ represent a speaker channel (FL, FR, CNT, SL, SR, SB, SBL, SBR, SW).

c) Depends on the speaker pattern setting, some parameters may not be available.

d) Depends on the speaker pattern setting, some settings may not be available.

e) This parameter is only available when HDMI input signals is detected.

Adjusting the level

(LEVEL menu)

You can use the LEVEL menu to adjust the balance and level of each speaker. These settings are applied to all sound fields. Select “LEVEL” in the amplifier menus. For details on adjusting the parameters, see “Navigating through menus” (page 42) and “Overview of the menus” (page 43).

LEVEL menu parameters

■ TEST TONE (Test tone)

Lets you adjust the speaker levels and balance while listening to the test tone from your listening position.

- OFF
The test tone is turned off.
 - FIX ■■■■*
The test tone is output from the speaker you have selected.
 - AUTO ■■■■*
The test tone is output from each speaker in sequence.
- * ■■■■ represent a speaker channel.

■ P. NOISE (Phase noise)

- OFF
The phase noise is turned off.
- FL/SR, SL/FL, SBL/SL, SBR/SBL, SR/SBR, SR/SL, FR/SR, FR/SL, CNT/FR, FL/CNT
Lets you output the test tone sequentially from adjacent speakers. Some items may not be displayed, depending on the setting of the speaker pattern.

■ P. AUDIO (Phase Audio)

- OFF
- FL/SR, SL/FL, SBL/SL, SBR/SBL, SR/SBR, SR/SL, FR/SR, FR/SL, CNT/FR, FL/CNT

Lets you output front 2 channel source sound (instead of the test tone) sequentially from adjacent speakers.

Some items may not be displayed, depending on the setting of the speaker pattern.

■ FL LEVEL (Front left speaker level)

■ FR LEVEL (Front right speaker level)

■ CNT LEVEL (Center speaker level)

■ SL LEVEL (Surround left speaker level)

■ SR LEVEL (Surround right speaker level)

■ SB LEVEL (Surround back speaker level)

■ SBL LEVEL (Surround back left speaker level)

■ SBR LEVEL (Surround back right speaker level)

■ SW LEVEL (Subwoofer level)

Note

Depends on the speaker pattern setting, some parameters may not be available.

■ D. RANGE (Dynamic range compressor)

Lets you compress the dynamic range of the sound track. This may be useful when you want to watch movies at low volumes late at night. Dynamic range compression is possible with Dolby Digital sources only.

- **COMP. MAX**
The dynamic range is compressed dramatically.
- **COMP. STD**
The dynamic range is compressed as intended by the recording engineer.
- **COMP. AUTO**
The dynamic range is compressed automatically.
- **COMP. OFF**
The dynamic range is not compressed.

Tip

Dynamic range compressor lets you compress the dynamic range of the soundtrack based on the dynamic range information included in the Dolby Digital signal.

“COMP. STD” is the standard setting, but it only enacts light compression. Therefore, we recommend using the “COMP. MAX” setting. This greatly compresses the dynamic range and lets you view movies late at night at low volumes. Unlike analog limiters, the levels are predetermined and provide a very natural compression.

Settings for the speakers (SPEAKER menu)

You can use the SPEAKER menu to set the size and distance of the speakers connected to this receiver.

Select “SPEAKER” in the amplifier menus. For details on adjusting the parameters, see “Navigating through menus” (page 42) and “Overview of the menus” (page 43).

SPEAKER menu parameters

■ SP PATTERN (Speaker pattern)

Lets you set the number of the speakers connected to this receiver. It should be synchronize with the subwoofer, front speakers, center speaker, surround speakers and surround back speakers settings. For details, see “Selecting a speaker pattern” (page 18).

■ FRT SP (Front speakers)

- **LARGE**
If you connect large speakers that will effectively reproduce bass frequencies, select “LARGE”. Normally, select “LARGE”. However, if you have selected a speaker pattern without subwoofer, the front speakers are automatically set to “LARGE”.
- **SMALL**
If the sound is distorted, or you feel a lack of surround effects when using multi channel surround sound, select “SMALL” to activate the bass redirection circuitry and output the front channel bass frequencies from the subwoofer. When the front speakers are set to “SMALL”, the center and surround speakers are also automatically set to “SMALL”.

■ CNT SP (Center speaker)

- LARGE

If you connect a large speaker that will effectively reproduce bass frequencies, select “LARGE”. Normally, select “LARGE”. However, if the front speakers are set to “SMALL”, you cannot set the center speaker to “LARGE”.

- SMALL

If the sound is distorted, or you feel a lack of surround effects when using multi channel surround sound, select “SMALL” to activate the bass redirection circuitry and output the center channel bass frequencies from the front speakers (if set to “LARGE”) or subwoofer.

■ SUR SP (Surround speakers)

The surround back speakers will be set to the same setting.

- LARGE

If you connect large speakers that will effectively reproduce bass frequencies, select “LARGE”. Normally, select “LARGE”. However, if the front speakers are set to “SMALL”, you cannot set the surround speakers to “LARGE”.

- SMALL

If the sound is distorted, or you feel a lack of surround effects when using multi channel surround sound, select “SMALL” to activate the bass redirection circuitry and output the surround channel bass frequencies from the subwoofer or other speaker that is set to “LARGE”.

Tip

The “LARGE” and “SMALL” settings for each speaker determine whether the internal sound processor will cut the bass signal from that channel. When the bass is cut from a channel, the bass redirection circuitry sends the corresponding bass frequencies to the subwoofer or other “LARGE” speakers.

However, since bass sounds have a certain amount of directionality, it is best not to cut them, if possible. Therefore, even when using small speakers, you can set them to “LARGE” if you want to output the bass frequencies from that speaker. On the other hand, if you are using a large speaker, but prefer not to have bass frequencies output from that speaker, set it to “SMALL”.

If the overall sound level is lower than you prefer, set all speakers to “LARGE”. If there is not enough bass, you can use the equalizer to boost the bass levels. For details, see page 52.

■ FL DIST. (Front left speaker distance)

■ FR DIST. (Front right speaker distance)

Lets you set the distance from your listening position to the front speakers (A).

If both front speakers are not placed an equal distance from your listening position, set the distance to the closest speaker.

With only one surround back speaker

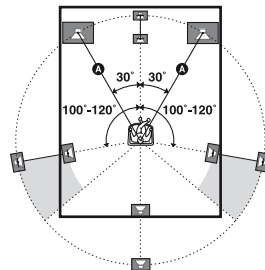

**With two surround back speakers
(The angle **B** should be the same)**

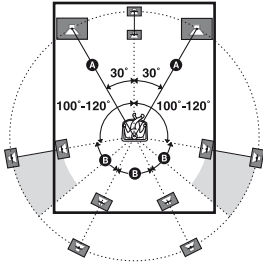

■ CNT DIST. (Center speaker distance)

Lets you set the distance from your listening position to the center speaker.

■ SL DIST. (Surround left speaker distance)

■ SR DIST. (Surround right speaker distance)

Lets you set the distance from your listening position to the surround speakers.

■ SB DIST. (Surround back speaker distance)

■ SBL DIST. (Surround back left speaker distance)

■ SBR DIST. (Surround back right speaker distance)

Lets you set the distance from your listening position to the surround back speakers.

■ SW DIST. (Subwoofer distance)

Lets you set the distance from your listening position to the subwoofer.

Note

Depends on the speaker pattern setting. Some parameters may not be available.

Tip

The distance between the center speaker and the listening position **B** cannot be more than 1.5 meters closer than the one between the listening position and the front speaker **A**. Place the speakers so that the difference in the length of **B** in the following diagram is no more than 1.5 meters closer than the length of **A**.

Example: Adjust the distance **B** to 4.5 meters or more when the distance **A** is 6 meters.

Also, the distance between the surround speakers/surround back speakers and the listening position **C** cannot be more than 4.5 meters closer than the distance between the listening position and the front speakers **A**. Place the speakers so that the difference in the length of **C** in the following diagram is no more than 4.5 meters closer than the length of **A**.

Example: Adjust the distance **C** to 1.5 meters or more when the distance **A** is 6 meters.

This is important because incorrect speaker placement is not conducive to the enjoyment of surround sound. Please note that placing the speakers closer than the required will cause a delay in the output of the sound from that speaker. In other words, the speaker will sound like it is farther away. Adjusting these parameter while listening to the sound often results in much better surround sound. Give it a try!

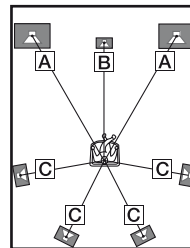

■ DIST. UNIT (Distance unit)

Lets you select the unit of measure for setting distances.

- FEET

The distance is displayed in feet.

- METER

The distance is displayed in meters.

■ FRT CROSS (Front speaker crossover frequency)

Lets you set the bass crossover frequency of the front speakers that have been set to “SMALL” in the SPEAKER menu.

■ CNT CROSS (Center speaker crossover frequency)

Lets you set the bass crossover frequency of the center speaker that have been set to “SMALL” in the SPEAKER menu.

■ SUR CROSS (Surround speaker crossover frequency)

Lets you set the bass crossover frequency of the surround speakers that have been set to “SMALL” in the SPEAKER menu.

Settings for the surround sound

(SURROUND menu)

You can use the SURROUND menu to select the sound field you want for your listening pleasure.

Select “SURROUND” in the amplifier menus. For details on adjusting the parameters, see “Navigating through menus” (page 42) and “Overview of the menus” (page 43).

SUR menu parameters

■ S.F. SELECT (Sound field selection)

Lets you select the sound field you want. For details, see “Enjoying Surround Sound” (page 56).

Note

The receiver lets you apply the last selected sound field to an input whenever it is selected (Sound Field Link). For example, if you select “HALL” for the DVD input, then change to a different input and then return to DVD, “HALL” will automatically be applied again.

■ E.SUR MODE (Enhanced surround mode)

Lets you select the surround mode you want. For details, see “Selecting enhanced surround mode” (page 58).

■ EFFECT (Effect level)

Lets you adjust the “presence” of the surround effect for the Cinema Studio EX A/B/C sound fields.

Adjusting the equalizer (EQ menu)

You can use the EQ menu to adjust the tonal quality (bass/treble level) of the front speakers.

Select “EQ” in the amplifier menus. For details on adjusting the parameters, see “Navigating through menus” (page 42) and “Overview of the menus” (page 43).

EQ menu parameters

■ BASS (Front speakers bass level)*

■ TREBLE (Front speakers treble level)*

* You can also adjust the front speaker bass and treble level with TONE MODE and TONE +/- on the receiver (page 7).

Note

This function does not work in the following cases.

- Dolby TrueHD signals with a sampling frequency of more than 96 kHz are being received.
- PCM signals with a sampling frequency of more than 96 kHz are being received.

Settings for the tuner (TUNER menu)

You can use the TUNER menu to set the FM station receiving mode and name preset stations.

Select “TUNER” in the amplifier menus. For details on adjusting the parameters, see “Navigating through menus” (page 42) and “Overview of the menus” (page 43).

TUNER menu parameters

■ FM MODE (FM station receiving mode)

• STEREO

This receiver will decode the signal as stereo signal when the radio station is broadcast in stereo.

• MONO

This receiver will decode the signal as mono signal regardless of the broadcast signal.

■ NAME IN (Naming preset stations)

Lets you set the name of preset stations. For details, see “Naming preset stations” (page 67).

Settings for the audio

(AUDIO menu)

You can use the AUDIO menu to make settings for the audio to suit your preference. Select “AUDIO” in the amplifier menus. For details on adjusting the parameters, see “Navigating through menus” (page 42) and “Overview of the menus” (page 43).

AUDIO menu parameters

■ A/V SYNC (Synchronizes audio with video output)

Lets you delay the output of audio to minimize the time gap between audio output and visual display. You can adjust from 0 ms to 300 ms in 10 ms steps.

Notes

- This parameter is useful when you use a large LCD or plasma monitor or a projector.
- This parameter is not valid when ANALOG DIRECT is selected.

■ DUAL MONO (Digital broadcast language selection)

Lets you select the language you want to listen to during digital broadcast. This feature only functions for Dolby Digital sources.

- MAIN/SUB
Sound of the main language will be output through the front left speaker and sound of the sub language will be output through the front right speaker simultaneously.
- MAIN
Sound of the main language will be output.
- SUB
Sound of the sub language will be output.

■ DEC. PRIO. (Digital audio input decoding priority)

Lets you specify the input mode for the digital signal input to the HDMI IN jacks.

- DEC. AUTO
Automatically switches the input mode between DTS, Dolby Digital, or PCM.
- DEC. PCM
PCM signals are output from the connected player. To prevent interruption when playback starts, set to “DEC. PCM”. When signals other than PCM signals are received, set this item to “DEC. AUTO”.

Note

Even when “DEC. PRIO.” is set to “DEC. PCM”, the sound may be interrupted at the very beginning of the first track depending on the CD being played back.

■ D. ASSIGN (Digital audio input assignment)

Lets you assign the digital audio input to other input source. For details, see “Listening to digital sound from other inputs (DIGITAL ASSIGN)” (page 76).

Settings for the HDMI

(HDMI menu)

You can use the HDMI menu to make various adjustments for HDMI settings.

Select “HDMI” in the amplifier menus. For details on adjusting the parameters, see “Navigating through menus” (page 42) and “Overview of the menus” (page 43).

HDMI menu parameters

■ CTRL:HDMI (Control for HDMI)

Lets you turn the Control for HDMI function on or off. For details, see “Control for HDMI” (page 70).

■ AUDIO OUT (Setting HDMI audio input)

Lets you set the HDMI audio output from the playback component connected to the receiver via an HDMI connection.

- AMP

The HDMI audio signals from the playback component are only output to the speakers connected to the receiver. Multi channel sound can be played back as it is.

Note

Audio signals are not output from the TV’s speakers when “AUDIO OUT” is set to “AMP”.

- TV+AMP

The sound is output from TV’s speaker and the speakers connected to the receiver.

Notes

- The sound quality of the playback component depends on the TV’s sound quality, such as the number of channels, and the sampling frequency, etc. When the TV has stereo speakers, the sound output from the receiver is also stereo as that of the TV, even if you play back multi channel software.
- When you connect the receiver to an image display component (projector, etc.), sound may not be output from the receiver. In this case, select “AMP”.

■ SW LEVEL (Subwoofer level for HDMI)

Lets you set the level of the subwoofer to 0 dB or +10 dB when PCM signals are input via an HDMI connection. You can set the level for each HDMI input independently.

- SW AUTO

Automatically sets the level to 0 dB or +10 dB depending on the frequency.

- SW 0 dB

- SW +10 dB

Note

This parameter is only available when HDMI input signals are detected.

Settings for the system

(SYSTEM menu)

You can use the SYSTEM menu to name inputs and change the brightness of the display.

Select “SYSTEM” in the amplifier menus. For details on adjusting the parameters, see “Navigating through menus” (page 42) and “Overview of the menus” (page 43).

SYSTEM menu parameters

■ NAME IN (Naming inputs)

Lets you set the name of inputs. For details, see “Naming inputs” (page 80).

■ DIMMER (Brightness of the display)

Lets you adjust the brightness in 3 steps.

Enjoying a pre-programmed sound field

When connecting Blu-ray disc players and other next generation HD players

This receiver supports the following audio formats.

Audio format	Maximum number of channels	Connection of the playback component and the receiver	
		COAXIAL/OPTICAL	HDMI
Dolby Digital	5.1ch	○	○
Dolby Digital EX	6.1ch	○	○
Dolby Digital Plus ^{a)}	7.1ch	×	○
Dolby TrueHD ^{a)}	7.1ch	×	○
DTS	5.1ch	○	○
DTS-ES	6.1ch	○	○
DTS 96/24	5.1ch	○	○
DTS-HD High Resolution Audio ^{a)}	7.1ch	×	○
DTS-HD Master Audio ^{a) b)}	7.1ch	×	○
Multi channel Linear PCM ^{a)}	7.1ch	×	○

^{a)} Audio signals are output in another format if the playback component does not correspond to the format. For details, refer to the operating instructions of the playback component.

^{b)} Signals with a sampling frequency of more than 96 kHz are played back at 96 kHz or 88.2 kHz.

Selecting Auto Format Direct (A.F.D.) mode

The Auto Format Direct (A.F.D.) mode allows you to listen to higher fidelity sound and select the decoding mode for listening to a 2 channel stereo sound as multi channel sound.

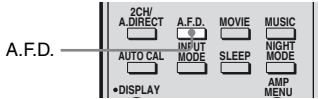

Press A.F.D. repeatedly to select the sound field you want.

For details, see “Types of A.F.D. mode” (page 57).

Types of A.F.D. mode

A.F.D. mode [Display]	Multi channel audio after decoding	Effect
A.F.D. Auto [A.F.D. AUTO]	(Detecting automatically)	Presents the sound as it was recorded/encoded without adding any surround effects. However, this receiver will generate a low frequency signal for output to the subwoofer when there is no LFE signals.
Enhanced surround mode [E. SURROUND]	(Depends on selected enhanced surround mode)	For details, see “Selecting enhanced surround mode” (page 58).
Multi Stereo [MULTI ST.]	(Multi Stereo)	Outputs 2 channel left/right signals from all speakers. However, sound may not be output from certain speakers depending on the speaker settings.

Selecting enhanced surround mode

The enhanced surround mode allows you to listen to higher fidelity sound and select the decoding mode for listening to a 2 channel stereo sound as multi channel sound.

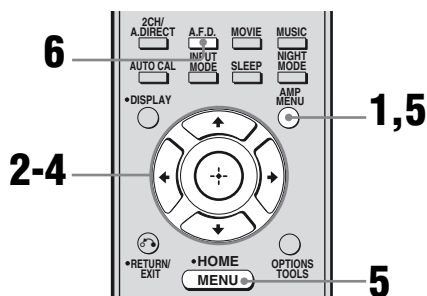

- 1** Press AMP MENU.
- 2** Press \uparrow/\downarrow repeatedly to select “SURROUND”, then press \odot or \rightarrow .
- 3** Press \uparrow/\downarrow repeatedly to select “E.SUR MODE” then press \odot or \rightarrow .
- 4** Press \uparrow/\downarrow repeatedly to select the enhanced surround mode you want, then press \odot or \rightarrow .
- 5** Press MENU/HOME or AMP MENU to exit the menu.
- 6** Press A.F.D. repeatedly to select “E. SURROUND”.

The enhanced surround mode you have selected in “E.SUR MODE” menu will be applied.

Types of enhanced surround mode

Enhanced surround mode [Display]	Multi channel audio after decoding	Effect
Pro Logic II* [PLII]	5 channel	Performs Dolby Pro Logic II decoding.
Pro Logic IIx* [PLIIx]	7 channel	Performs Dolby Pro Logic IIx decoding.
Neo:6 Cinema [NEO6 CIN]	7 channel	Performs DTS Neo:6 Cinema mode decoding.
Neo:6 Music [NEO6 MUS]	7 channel	Performs DTS Neo:6 Music mode decoding. This setting is ideal for normal stereo sources such as CDs.
Neural-THX [NEURAL-THX]	7 channel	Next generation of Neural-THX [®] Surround. In addition to stereo enhancement processing and pure discrete 5.1 surround sound, now capable of full 360° 7.1 surround sound playback from Neural-THX [®] surround encoded content.

* Depends on the speaker pattern setting, some enhanced surround mode may not be available.

If you connect a subwoofer

This receiver will generate a low frequency signal for output to the subwoofer when there is no LFE signal, which is a low-pass sound effect output from a subwoofer to a 2 channel signal. However, the low frequency signal is not generated for “NEO6 CIN” or “NEO6 MUS” when all speakers are set to “LARGE”. In order to take full advantage of the Dolby Digital bass redirection circuitry, we recommend setting the subwoofer’s cut off frequency as high as possible.

Notes

- This function does not work in the following cases.
 - PCM signals with a sampling frequency of more than 96 kHz are being received.
 - DTS 96/24 signals are being received.
 - DTS-HD signals with a sampling frequency of more than 48 kHz are being received.
 - Dolby TrueHD signals with a sampling frequency of more than 48 kHz are being received.
- The beginning of the sound stream may be dropped out when Neural-THX processing is turned on or off.

Tips

- You can identify the encoding format of DVD software, etc., by looking at the logo on the package.
- Dolby Pro Logic IIx decoding is effective, when a multi-channel signal is input.

Selecting movie/music mode

You can take advantage of surround sound simply by selecting one of the receiver’s pre-programmed sound fields. They bring the exciting and powerful sound of movie theaters and concert halls into your home.

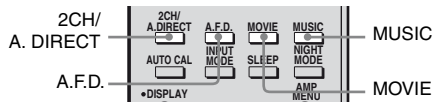

Press MOVIE repeatedly to select a sound field for movies or press MUSIC repeatedly to select a sound field for music.

For details, see “Types of movie/music mode” (page 60).

Types of movie/music mode

Sound field for	Sound field [Display]	Effect
Movie	Cinema Studio EX A DCS [C.ST.EX A]	Reproduces the sound characteristics of the Sony Pictures Entertainment "Cary Grant Theater" cinema production studio. This is a standard mode, great for watching almost any type of movie.
	Cinema Studio EX B DCS [C.ST.EX B]	Reproduces the sound characteristics of the Sony Pictures Entertainment "Kim Novak Theater" cinema production studio. This mode is ideal for watching science-fiction or action movies with lots of sound effects.
	Cinema Studio EX C DCS [C.ST.EX C]	Reproduces the sound characteristics of the Sony Pictures Entertainment scoring stage. This mode is ideal for watching musicals or films where orchestra music is featured in the soundtrack.
	V.Multi Dimension DCS [V.MULTI DIM.]	Creates many virtual speakers from a single pair of actual surround speakers.
Music	Hall [HALL]	Reproduces the acoustics of a classical concert hall.
	Jazz Club [JAZZ]	Reproduces the acoustics of a jazz club.
	Live concert [CONCERT]	Reproduces the acoustics of a 300-seat live house.
	Stadium [STADIUM]	Reproduces the feeling of a large open-air stadium.
	Sports [SPORTS]	Reproduces the feeling of sports broadcasting.
	Portable Audio Enhancer [PORTABLE]	Reproduces a clear enhanced sound image from your portable audio device. This mode is ideal for MP3 and other compressed music.
Headphone*	Headphone 2CH [HP 2CH]	This mode is selected automatically if you use headphones when 2CH STEREO mode (page 62)/A.F.D. mode (page 57) is selected. Standard 2 channel stereo sources completely bypass the sound field processing and multi channel surround formats are downmixed to 2 channels except LFE signals.
	Headphone Theater DCS [HP THEA]	This mode is selected automatically if you use headphones when sound field for movie/music is selected. It allows you to experience a theater-like environment while listening through a pair of headphones.
	Headphone Direct [HP DIR]	Outputs the analog signals without processing by the equalizer, sound field, etc.

* You can only select this sound field if the headphones are connected to the receiver.

Notes

- The sound fields for music and movies do not work in the following cases.
 - PCM signals with a sampling frequency of more than 48 kHz are being received.
 - DTS 96/24 signals are being received.
 - DTS-HD signals with a sampling frequency of more than 48 kHz are being received.
 - Dolby TrueHD signals with a sampling frequency of more than 48 kHz are being received.
- The effects provided by the virtual speakers may cause increased noise in the playback signal.
- When listening with sound fields that employ the virtual speakers, you will not be able to hear any sound coming directly from the surround speakers.
- When one of the sound fields for music is selected, no sound is output from the subwoofer if all the speakers are set to “LARGE” in the SPEAKER menu. However, the sound will be output from the subwoofer if the digital input signal contains LFE signals, or if the front or surround speakers are set to “SMALL,” the sound field for movie is selected, or “PORTABLE” is selected.

Tip

Sound fields with **DCS** marks use DCS technology. For details on Digital Cinema Sound (DCS), see “Glossary” (page 88).

To turn off the surround effect for movie/music mode

Press 2CH/A.DIRECT to select “2CH ST.” or press A.F.D. repeatedly to select “A.F.D. AUTO”.

Enjoying the surround effect at low volume levels (NIGHT MODE)

This function allows you to retain a theater like environment at low volume levels. This function can be used with other sound fields. When watching a movie late at night, you will be able to hear the dialog clearly even at a low volume level.

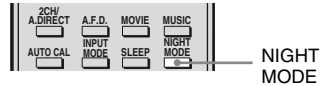

Press NIGHT MODE.

The NIGHT MODE function is activated. The NIGHT MODE is set to on and off as you press NIGHT MODE.

Note

- This function does not work in the following cases.
- Dolby TrueHD signals with a sampling frequency of more than 96 kHz are being received.
 - PCM signals with a sampling frequency of more than 96 kHz are being received.

Using only the front speakers (2CH STEREO)

In this mode, the receiver outputs the sound from the front left/right speakers only. There is no sound from the subwoofer. Standard 2 channel stereo sources completely bypass the sound field processing and multi channel surround formats are downmixed to 2 channel except LFE signals.

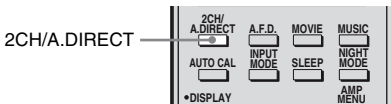

Press **2CH/A.DIRECT** repeatedly to select **“2CH ST.”**.

Note

No sound is output from the subwoofer in the 2CH STEREO mode. To listen to 2 channel stereo sources using the front left/right speakers and a subwoofer, select **“A.F.D. AUTO”** (page 57).

Listening to the sound without any adjustment (ANALOG DIRECT)

You can switch the audio of the selected input to 2 channel analog input. This function enables you to enjoy high quality analog sources. When using this function, only the volume and front speaker balance can be adjusted.

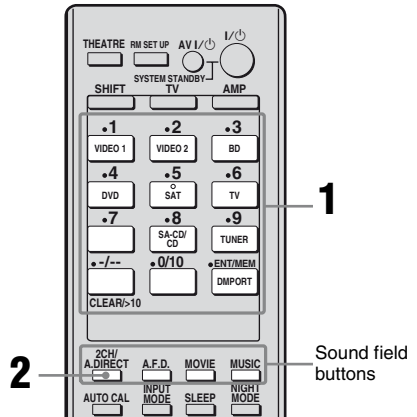

1 Press one of the input buttons to select the input you want to listen to in analog audio.

You can also use the **INPUT SELECTOR** on the receiver.

2 Press **2CH/A.DIRECT** repeatedly to select **“A.DIRECT”**.

The analog audio is output.

To cancel ANALOG DIRECT

Press **2CH/A.DIRECT** again.

You can also press any sound field buttons.

Notes

- When headphones are connected, **“HP DIRECT”** appears on the display.
- You cannot select **ANALOG DIRECT** when you select **BD** and **DMPORT** as input.

Resetting sound fields to the initial settings

Be sure to use the buttons on the receiver for this operation.

1,2

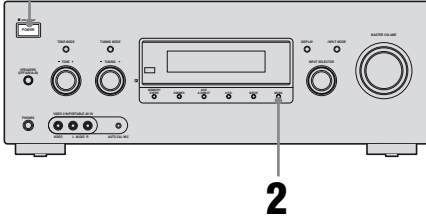

- 1** Press I/⏻ to turn off the receiver.
- 2** While holding down MUSIC, press I/⏻.
“S.F. CLEAR” appears on the display and all sound fields are reset to their initial setting.

Tuner Operations

Listening to FM/AM radio

You can listen to FM and AM broadcasts through the built-in tuner. Before operation, make sure you have connected the FM and AM antennas to the receiver (page 28).

Tip

The tuning scale for direct tuning differs depending on the area code as shown in the following table. For details on area codes, see page 3.

Area code	FM	AM
CEL, CEK, ECE,	50 kHz	9 kHz
AU	50 kHz	9 kHz*
E51	50 kHz	10 kHz*

* The AM tuning scale can be changed (page 98).

Tuner Operations

Automatic tuning



- 1** Press TUNER repeatedly to select the FM or AM band.

continued

2 Press TUNING + or TUNING –.

Press TUNING + to scan from low to high; press TUNING – to scan from high to low.

The receiver stops scanning whenever a station is received.

Using the controls on the receiver

- 1 Turn INPUT SELECTOR to select the FM or AM band.
- 2 Press TUNING MODE repeatedly to select “AUTO”.
- 3 Turn TUNING +/-.

In case of poor FM stereo reception

If the FM stereo reception is poor and “ST” flashes on the display, select monaural audio so that the sound will be less distorted.

- To select monaural audio, set “FM MODE” in TUNER menu to “MONO” (page 52).
- To return to stereo mode, set “FM MODE” in TUNER menu to “ST” (page 52).

Direct tuning

You can enter the frequency of a station directly by using the numeric buttons.

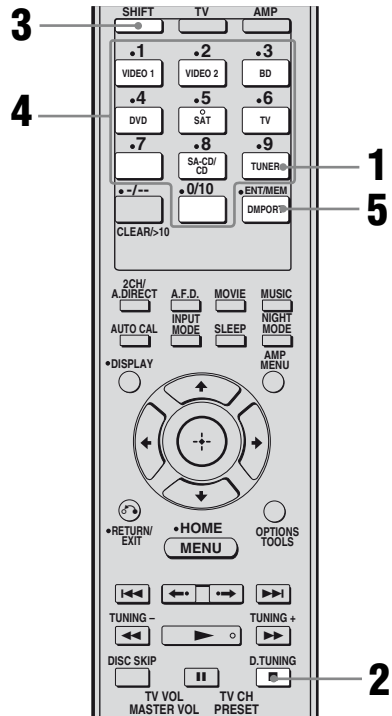

1 Press TUNER repeatedly to select the FM or AM band.

You can also use INPUT SELECTOR on the receiver.

2 Press D.TUNING.

3 Press SHIFT.

4 Press the numeric buttons to enter the frequency.

Example 1: FM 102.50 MHz

Select 1 → 0 → 2 → 5 → 0

Example 2: AM 1,350 kHz

Select 1 → 3 → 5 → 0

5 Press ENT/MEM.

You can also use MEMORY/ENTER on the receiver.

Tip

If you have tuned in an AM station, adjust the direction of the AM loop antenna for optimum reception.

If you cannot tune in a station

Make sure you have entered the right frequency. If not, repeat steps 2 to 5. If you still cannot tune in a station, the frequency is not used in your area.

Presetting radio stations

You can preset up to 30 FM stations and 30 AM stations. Then you can easily tune in the stations you often listen to.

Presetting radio stations

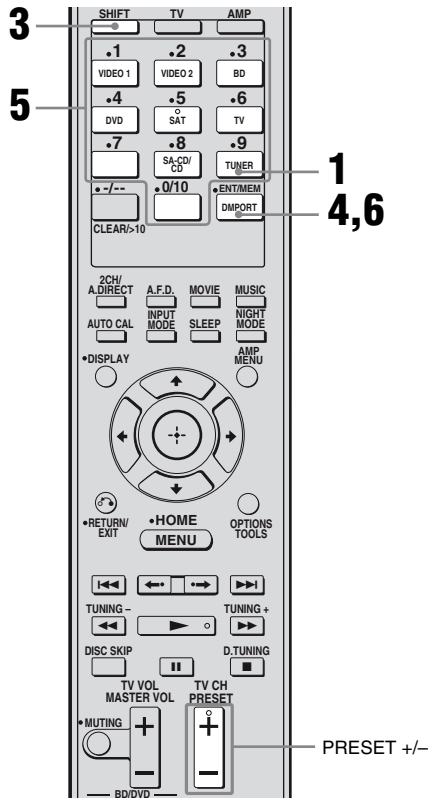

1 Press TUNER repeatedly to select the FM or AM band.

You can also use INPUT SELECTOR on the receiver.

2 Tune in the station that you want to preset using Automatic Tuning (page 63) or Direct Tuning (page 64).

Switch the FM reception mode, if necessary (page 64).

3 Press **SHIFT**.

4 Press **ENT/MEM**.

You can also use MEMORY/ENTER on the receiver.

“MEM” lights up for a few seconds.

Perform steps 5 and 6 before “MEM” goes out.

5 Press the numeric buttons to select a preset number.

You can also press PRESET + or PRESET – to select a preset number.

If “MEM” goes out before you select the preset number, start again from step 3.

6 Press **ENT/MEM**.

You can also use MEMORY/ENTER on the receiver.

“MEM” lights off.

The station is stored as the selected preset number.

7 Repeat steps 1 to 6 to preset another station.

Tuning to preset stations

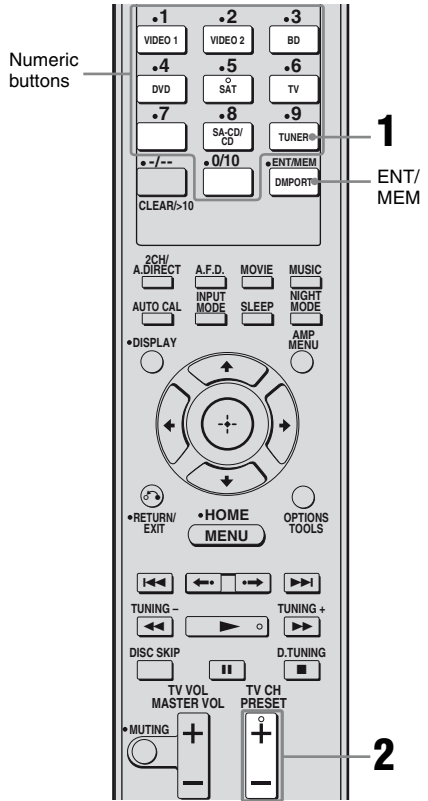

1 Press **TUNER** repeatedly to select the FM or AM band.

2 Press **PRESET +** or **PRESET –** repeatedly to select the preset station you want.

Each time you press the button, you can select a preset station as follows:

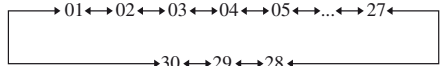

You can also press **SHIFT** and then press the numeric buttons to select the preset station you want. Then, press **ENT/MEM** to enter the selection.

Using the controls on the receiver

- 1 Turn INPUT SELECTOR to select the FM or AM band.
- 2 Press TUNING MODE repeatedly to select “PRESET”.
- 3 Turn TUNING +/- to select the preset station you want.

Naming preset stations

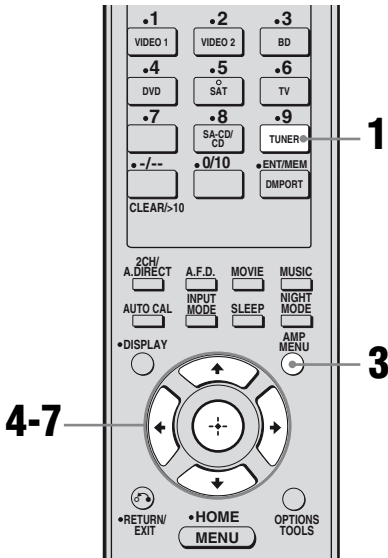

- 1 Press TUNER repeatedly to select the FM or AM band.
You can also use INPUT SELECTOR on the receiver.
- 2 Tune in the preset station you want to create an index name for (page 66).
- 3 Press AMP MENU.
- 4 Press \uparrow/\downarrow repeatedly to select “TUNER”.
- 5 Press \oplus or \rightarrow to enter the menu.

6 Press \uparrow/\downarrow repeatedly to select “NAME IN”.

7 Press \oplus or \rightarrow to enter the parameter.

The cursor flashes and you can select a character. Follow the procedure given in “To create an index name” below.

To create an index name

- 1 Use $\uparrow/\downarrow/\leftarrow/\rightarrow$ to create an index name.
Press \uparrow/\downarrow to select a character, then press \leftarrow/\rightarrow to move the cursor to the next position.

If you made a mistake

Press \leftarrow/\rightarrow until the character you want to change flashes, then press \uparrow/\downarrow to select the correct character.

Tips

- You can select the character type as follows by pressing \uparrow/\downarrow .
Alphabet (upper case) \rightarrow Numbers \rightarrow
Symbols
- To enter a blank space, you can press \rightarrow without selecting a character.

- 2 Press \oplus to enter the name.
The entered name is registered.

Note (Models of area code CEL, CEK, ECE only)

When you name an RDS station and tune in that station, the Program Service name appears instead of the name you entered. (You cannot change the Program Service name. The name you entered will be overwritten by the Program Service name.)

Using the Radio Data System (RDS)

(Models of area code CEL, CEK, ECE only)

This receiver also allows you to use RDS (Radio Data System), which enables radio stations to send additional information along with the regular program signal. You can display RDS information.

Notes

- RDS is operable only for FM stations.
- Not all FM stations provide RDS service, nor do they provide the same type of services. If you are not familiar with the RDS services in your area, check with your local radio stations for details.

Receiving RDS broadcasts

Simply select a station on the FM band using **Direct Tuning (page 64)**, **Automatic Tuning (page 63)**, or **Preset Tuning (page 66)**.

When you tune in a station that provides RDS services, “RDS” lights up and the program service name appears on the display.

Note

RDS may not work properly if the station you tuned to is not transmitting the RDS signal properly or if the signal strength is weak.

Displaying RDS information

While receiving an RDS station, press **DISPLAY** repeatedly on the receiver.

Each time you press the button, RDS information on the display changes cyclically as follows:

Program Service name → Frequency → Program Type indication^{a)} → Radio Text indication^{b)} → Current Time indication (in 24-hour system mode) → Sound field currently applied → Volume level

^{a)}Type of program being broadcast.

^{b)}Text messages sent by the RDS station.

Notes

- If there is an emergency announcement by government authorities, “ALARM” flashes in the display.
- When the message consists of 9 characters or more, the message scrolls across the display.
- If a station does not provide a particular RDS service, “NO XXXX” (such as “NO TEXT”) appears on the display.

Description of program types

Program type indication	Description
NEWS	News programs
AFFAIRS	Topical programs that expand on current news
INFO	Programs offering information on a wide spectrum of subjects, including consumer affairs and medical advice
SPORT	Sports programs
EDUCATE	Educational programs, such as “how-to” and advice programs
DRAMA	Radio plays and serials
CULTURE	Programs about national or regional culture, such as language and social concerns

Program type indication	Description
SCIENCE	Programs about the natural sciences and technology
VARIED	Other types of programs such as celebrity interviews, panel games, and comedy
POP M	Popular music programs
ROCK M	Rock music programs
EASY M	Easy Listening
LIGHT M	Instrumental, vocal, and choral music
CLASSICS	Performances of major orchestras, chamber music, opera, etc.
OTHER M	Music that does not fit into any categories above, such as Rhythm & Blues and Reggae
WEATHER	Weather information
FINANCE	Stock market reports and trading, etc.
CHILDREN	Programs for children
SOCIAL	Programs about people and the things that affect them
RELIGION	Programs of religious content
PHONE IN	Programs where members of the public express their views by phone or in a public forum
TRAVEL	Programs about travel. Not for announcements that are located by TP/TA.
LEISURE	Programs on recreational activities such as gardening, fishing, cooking, etc.
JAZZ	Jazz programs
COUNTRY	Country music programs
NATION M	Programs featuring the popular music of the country or region
OLDIES	Programs featuring oldies music
FOLK M	Folk music programs
DOCUMENT	Investigative features
NONE	Any programs not defined above

Using the Control for HDMI function for “BRAVIA” Sync

To use “BRAVIA” Sync, set the Control for HDMI function as explained below.

By connecting Sony components that are compatible with the Control for HDMI function with an HDMI cable (not supplied), operation is simplified as follows:

- **One-Touch Play:** When you play back a component such as a DVD/Blu-ray disc player, the receiver and the TV are turned on automatically and switched to the appropriate HDMI input.
- **System Audio Control:** While watching TV, you can select to output the sound from the TV speaker or the speakers connected to the receiver.
- **System Power Off:** When you turn off the TV, the receiver and connected components are also turned off simultaneously.

Control for HDMI is a mutual control function standard used by HDMI CEC (Consumer Electronics Control) for HDMI (High-Definition Multimedia Interface).

The Control for HDMI function does not work in the following cases:

- When you connect the receiver to a component which does not correspond with Sony Control for HDMI function.
- When you connect the receiver and components using other than HDMI connection.

We recommend that you connect the receiver to products featuring “BRAVIA” Sync.

Note

Depending on the connected component, the Control for HDMI function may not work. Refer to the operating instructions of the component.

Connecting a TV and other components

Before connecting cords, be sure to disconnect the AC power cord.

To enjoy TV multi channel surround sound broadcasting

You can listen to TV multi channel surround sound broadcasting from the speakers connected to the receiver.

Connect the OPTICAL output jack of the TV to the OPTICAL IN jack of the receiver.

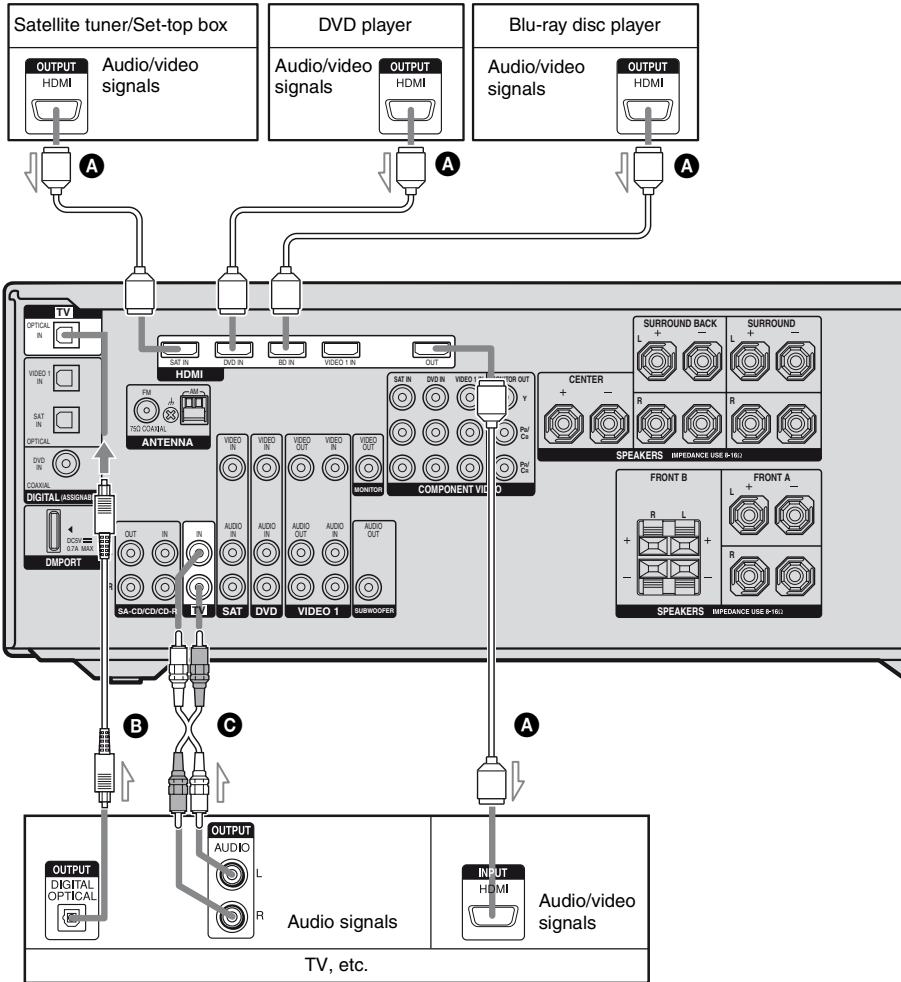

- A** HDMI cable (not supplied)
We recommend that you use a Sony HDMI cable.
- B** Optical digital cord (not supplied)^{a)}
- C** Audio cord (not supplied)^{a)}

^{a)} Connect at least one of the audio cords (**B** or **C**).

Preparing Control for HDMI function

This receiver supports the Control for HDMI-Easy Setting function.

This function is only available for certain types of TV. When you perform the Control for HDMI-Easy Setting from the TV, the Control for HDMI setting on this receiver will automatically change accordingly.

During the Control for HDMI-Easy Setting operation, “SCANNING” flashes in the display. This receiver will automatically change the input to HDMI input. When the setting is completed, “COMPLETE” appears on the display.

For details, refer to the operating instructions of the TV.

If your TV does not support the Control for HDMI-Easy Setting function, do the following procedures. For details on setting the TV and connected components, refer to the operating instructions of the respective components.

- 1** Make sure that the receiver is connected to the TV and components (compatible with Control for HDMI function) via HDMI connection.
- 2** Turn on the receiver, TV and connected components.
- 3** Set the respective Control for HDMI function for the receiver and TV to on. See “To set Control for HDMI” (page 73). For details on setting the TV, refer to the operating instructions of the TV.
- 4** Select the HDMI input of the receiver and TV to match the HDMI input of the connected component, so that the image from the connected component is displayed.

- 5** Set the Control for HDMI function for the connected component to on.
If the Control for HDMI function for the connected component is already set to on, you do not need to change the setting.
- 6** Repeat steps 4 and 5 for other components that you want to use the Control for HDMI function.

Notes

- If you unplug and reconnect the HDMI cable, be sure to repeat steps 1 to 6 above.
- You cannot perform One-Touch Play and System Audio Control during the Control for HDMI-Easy Setting operation.
- Before you do the Control for HDMI-Easy Setting from the TV, be sure to turn on the TV, connected components and receiver.
- If the playback components cannot function after you have made the settings for Control for HDMI-Easy Setting, check the Control for HDMI setting on your TV.
- If the connected components do not support Control for HDMI-Easy Setting, you need to set the Control for HDMI function for the connected components to on before you perform the Control for HDMI-Easy Setting from the TV.

To set Control for HDMI

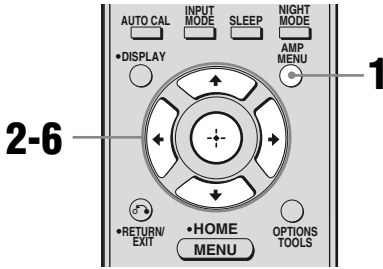

- 1 Press AMP MENU.**
- 2 Press ↑/↓ repeatedly to select “HDMI”.**
- 3 Press ⊕ or → to enter the menu.**
- 4 Press ↑/↓ repeatedly to select “CTRL:HDMI”.**
- 5 Press ⊕ or → to enter the parameter.**
- 6 Press ↑/↓ repeatedly to select “CTRL ON”.**

Control for HDMI function is activated.

Watching a DVD (One-Touch Play)

You can enjoy sound and image from the components connected to the receiver via HDMI connections by a simple operation.

Play back a connected component.

The receiver and the TV are turned on automatically and switched to the appropriate HDMI input.

Watching a DVD by simple operation

You can also select a connected component, such as a DVD/Blu-ray disc player using the TV menu. In this case, the receiver and the TV switch to the appropriate HDMI input.

Note

Depending on the TV, the start of the content may not be output.

Enjoying the TV sound from the speakers connected to the receiver (System Audio Control)

You can enjoy the TV sound from the speakers connected to the receiver by a simple operation.

You can operate System Audio Control function using the TV menu. For details, refer to the operating instructions of the TV. When System Audio Control function is turned on, the receiver will turn on and switches to the appropriate input automatically.

TV sound is output from the speakers connected to the receiver, and the volume of the TV is minimized simultaneously.

You can also use the System Audio Control function as follows.

- If you turn on the receiver while the TV is turned on, the System Audio Control function will automatically be set to on and the TV sound will output from the speakers connected to the receiver. However, if you turn off the receiver, the sound will output from the TV speakers.
- You can adjust the receiver's volume when you adjust the TV volume.

Notes

- If System Audio Control does not function according to your TV setting, refer to the operating instructions of the TV.
- When "CTRL:HDMI" is set to "CTRL ON", the "AUDIO OUT" settings in the HDMI menu will set automatically depending on the System Audio Control settings.
- When you connect a TV that does not have System Audio Control function, the System Audio Control function does not work.
- If the TV is turned on before turning on the receiver, the TV sound will not be output for a moment.
- When you switch to an input other than HDMI or TV, the System Audio Control function will automatically be set to off.
- If you switch from other input to HDMI or TV input, the System Audio Control function will automatically be set to on.

Turning off the receiver with the TV

(System Power Off)

When you turn the TV off by using the POWER button on the TV's remote, the receiver and the connected components turn off automatically.

You can also use the receiver's remote to turn off the TV.

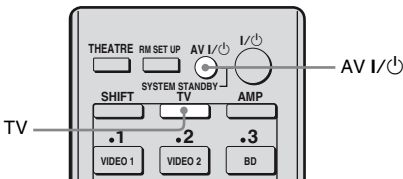

Press TV, then press AV I/⏻.

The TV, receiver and the components connected via HDMI are turned off.

Notes

- Set the TV Standby Synchro to "ON" before using the System Power Off function. For details, refer to the operating instructions of the TV.
- Depending on the status, the connected components may not be turned off. For details, refer to the operating instructions of the connected components.

Other Operations

Switching between digital and analog audio (INPUT MODE)

When you connect components to both digital and analog input jacks on the receiver, you can fix the audio input mode to either of them, or switch from one to the other, depending on the type of material you intend to watch.

1 Turn INPUT SELECTOR on the receiver to select the input.

You can also use the input buttons on the remote.

2 Press INPUT MODE repeatedly on the receiver to select the audio input mode.

The selected audio input mode appears on the display.

Audio input modes

■ AUTO

Gives priority to digital audio signals when there are both digital and analog connections. If there are more than one digital connection, HDMI audio signals have priority over COAXIAL and OPTICAL audio signals. If there are no digital audio signals, analog audio signals are selected.

■ COAX

Specifies the digital audio signals input to the DIGITAL COAXIAL jack.

■ OPT

Specifies the digital audio signals input to the DIGITAL OPTICAL jack.

■ ANALOG

Specifies the analog audio signals input to the AUDIO IN (L/R) jacks.

continued

Notes

- Some audio input modes may not be set up depending on the input.
- When the ANALOG DIRECT function is selected, audio input is set to “ANALOG” automatically and you cannot select other modes.
- When either satellite tuner or DIGITAL MEDIA PORT adapter is selected, “-----” appears on the display, and you cannot select other modes. Select an input mode other than the satellite tuner and DIGITAL MEDIA PORT adapter then set the audio input mode.

Listening to digital sound from other inputs (DIGITAL ASSIGN)

You can reassign digital audio input that has OPTICAL or COAXIAL (VIDEO 1 IN, SAT IN, DVD IN) signals to another input when they are not currently being used.

For example, to output the sound source for DVD player using the OPTICAL IN jack on the receiver, then:

- Connect the optical output jack of the DVD player to the OPTICAL VIDEO 1 IN jack of the receiver.
- Assign “VD1 OPT” to “DVD” in the D. ASSIGN setting.

- 1 Press AMP MENU.**
- 2 Press \uparrow/\downarrow repeatedly to select “AUDIO”.**
- 3 Press \oplus or \rightarrow to enter the menu.**
- 4 Press \uparrow/\downarrow repeatedly to select “D. ASSIGN”.**
- 5 Press \oplus or \rightarrow to enter the parameter.**
- 6 Press \uparrow/\downarrow repeatedly to select a vacant digital audio input (for example, “VD1 OPT”).**
- 7 Press \oplus or \rightarrow to enter your selection.**

8 Press **▲/▼** repeatedly to select the input (“VD1 → DVD” in the example) you want to assign to the digital audio input jack selected in step 6.

When DVD input is selected, the sound of the DVD player will also become a digital sound through the OPTICAL VIDEO 1 jack.

The input you can reassign to varies for each digital audio input. For details, see “Assignable inputs for digital audio input” (page 77).

Notes

- You cannot reassign more than one digital audio input to the same input.
- You cannot use the digital audio input for the original input when it is reassigned to another input.
- When you assign the digital audio input, the INPUT MODE setting may change automatically (page 75).

To return to the previous display

Press **◀**.

Assignable inputs for digital audio input

The initial setting is marked with an underscore.

Digital audio input [Display]	Assignable inputs	Display
OPTICAL VIDEO 1 IN [VD1 OPT]	VIDEO1	<u>VD1</u> →[VD1]
	VIDEO2	VD1→[VD2]
	BD	VD1→[BD]
	DVD	VD1→[DVD]
	SA-CD/CD	VD1→[CD]
COAXIAL DVD IN [DVD COAX]	VIDEO1	DVD→[VD1]
	VIDEO2	DVD→[VD2]
	BD	DVD→[BD]
	DVD	<u>DVD</u> →[DVD]
	SAT	DVD→[SAT]
OPTICAL SAT IN [SAT OPT]	VIDEO2	SAT→[VD2]
	BD	SAT→[BD]
	DVD	SAT→[DVD]
	SAT	<u>SAT</u> →[SAT]

Enjoying the DIGITAL MEDIA PORT (DMPORT)

The DIGITAL MEDIA PORT (DMPORT) allows you to enjoy sound from a network system such as a portable audio source or computer.

By connecting a DIGITAL MEDIA PORT adapter (not supplied), you can enjoy sound from the connected component on the receiver.

For details, refer to the operating instructions supplied with the DIGITAL MEDIA PORT adapter.

Notes

- Do not connect an adapter other than the DIGITAL MEDIA PORT adapter.
- Do not connect or disconnect the DIGITAL MEDIA PORT adapter while the receiver is turned on.
- Depending on the DIGITAL MEDIA PORT adapter, video output may not be possible.
- The DIGITAL MEDIA PORT adapters are available for purchase depending on the area.

Connecting the DIGITAL MEDIA PORT adapter

You can listen to the sound and view the images from the component connected through the DIGITAL MEDIA PORT adapter to the DMPORT jack on the receiver.

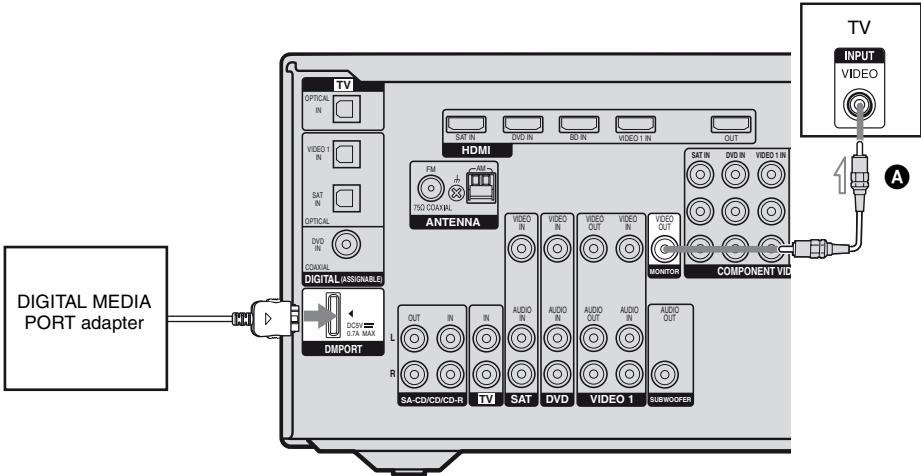

A Video cord (not supplied)

To detach the DIGITAL MEDIA PORT adapter from DMPORT jack

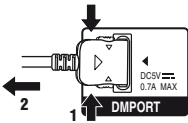

Press and hold both sides of the connector and then pull out the connector.

Notes

- When connecting the DIGITAL MEDIA PORT adapter, be sure the connector is inserted with the arrow mark facing towards the arrow mark on the DMPORT jack.
- Be sure to make DMPORT connections firmly, insert the connector straight in.
- As the connector of the DIGITAL MEDIA PORT adapter is fragile, be sure to handle with care when placing or moving the receiver.

Listening/watching a connected component through DMPORT connection

1 Press DMPORT.

You can also use the INPUT SELECTOR on the receiver to select “DMPORT”.

2 Start playback of the connected component.

The sound is played back on the receiver and the image appears on the TV.

For details, refer to the operating instructions supplied with the DIGITAL MEDIA PORT adapter.

Notes

- Depending on the type of DIGITAL MEDIA PORT adapter, you can operate the connected component by using the remote. For details on remote button operation, see page 11.
- Be sure you have connected the MONITOR OUT or HDMI OUT jack of the receiver to the TV (page 79).

Tip

When listening to MP3 or other compressed music using a portable audio source, you can enhance the sound. Press MUSIC repeatedly to select “PORTABLE” (page 60).

Naming inputs

You can enter a name of up to 8 characters for inputs and display it on the receiver’s display. This is convenient for labeling the jacks with the names of the connected components.

1 Press one of the input buttons to select the input you want to create an index name for.

You can also use INPUT SELECTOR on the receiver.

2 Press AMP MENU.

3 Press \uparrow/\downarrow repeatedly to select “SYSTEM”.

4 Press \oplus or \rightarrow to enter the menu.

5 Press \uparrow/\downarrow to select “NAME IN”.

6 Press \oplus or \rightarrow to enter the parameter.

The cursor flashes and you can select a character. Follow the procedure given in “To create an index name” (page 67).

Changing the display

You can check the sound field, etc., by changing the information on the display. Be sure to use the buttons on the receiver for this operation.

Press DISPLAY repeatedly.

Each time you press the button, the display changes cyclically as follows:

All inputs except the FM and AM band

Index name of the input^{a)} → Selected input
→ Sound field currently applied → Volume level → Stream info

FM and AM band

Program Service name^{b)} or preset station name^{a)} → Frequency → Program Type indication^{b)} → Radio Text indication^{b)} → Current Time indication (in 24-hour system mode)^{b)} → Sound field currently applied

^{a)} Index name appears only when you have assigned one to the input or preset station (page 67, 80).
Index name does not appear when only blank spaces have been entered, or it is the same as the input name.

^{b)} During RDS reception only (Models of area code CEL, CEK, ECE only) (page 68).

Note

Character or marks may not be displayed for some languages.

Using the Sleep Timer

You can set the receiver to turn off automatically at a specified time.

Press SLEEP repeatedly while the power is on.

“SLEEP” lights up in the display.

Each time you press the button, the display changes cyclically as follows:

OFF → 0:30:00 → 1:00:00 → 1:30:00 → 2:00:00

Tip

To check the remaining time before the receiver turns off, press SLEEP. The remaining time appears on the display. If you press SLEEP again, the sleep timer will be canceled.

Recording using the receiver

You can record from a video/audio component using the receiver. Refer to the operating instructions supplied with your recording component.

Recording onto a CD-R

You can record onto a CD-R using the receiver. See the operating instructions supplied with your CD recorder.

- 1 Press one of the input buttons to select the playback component.**

You can also use INPUT SELECTOR on the receiver.

- 2 Prepare the playback component for playing.**

For example, tune to the radio station you want to record (page 63).

- 3 Prepare the recording component.**

Insert a blank CD-R into the CD recorder and adjust the recording level.

- 4 Start recording on the recording component, then start playback on the playback component.**

Note

Sound adjustments do not affect the signal output from the SA-CD/CD/CD-R OUT jacks.

Recording onto a recording media

- 1 Press one of the input buttons to select the playback component.**

You can also use INPUT SELECTOR on the receiver.

- 2 Prepare the playback component for playing.**

For example, insert the video tape you want to copy into the VCR.

- 3 Prepare the recording component.**

Insert a blank video tape, etc. into the recording component (VIDEO 1) for recording.

- 4 Start recording on the recording component, then start playback on the playback component.**

Note

Some sources contain copy guards to prevent recording. In this case, you may not be able to record from the source.

Programming the remote

You can program the remote to control non-Sony components by changing the code. Once the control signals have been memorized, you can use those components as part of your system.

Furthermore, you can also program the remote for Sony components that the remote is unable to control. Note that the remote can only control components that accept infrared wireless control signals.

1 Press AV I/⏻ while pressing RM SET UP.

The RM SET UP button slowly flashes.

2 Press the input button for the component you want to control.

For example, if you are going to control a CD player, press SA-CD/CD.

The RM SET UP and the SHIFT button indicator light up.

3 Press the numeric buttons to enter the numeric code (or one of the codes if more than one code exists) corresponding to the component and the maker of the component you want to control (except TV).

See the tables on page 84–87 for information on the numeric code(s) corresponding to the component and the maker of the component (the first digit and the last two digits of the numeric code correspond to the category and the maker's code respectively).

4 Press ENT/MEM.

Once the numeric code has been verified, the RM SET UP indicator slowly flashes twice and the remote automatically exits the programming mode.

5 Repeat steps 1 to 4 to control other components.

Notes

- The indicator turns off while a valid button is pressed.
- In step 2, if you want to change to other input, press SHIFT and then press the new input buttons you want.
- In step 2, if you press TUNER, you can only program the button to control a tuner (page 87).
- For the numeric codes, only the last three numbers entered are valid.

To program the remote to control a TV

1 Press AV I/⏻ while pressing RM SET UP. The RM SET UP indicator slowly flashes.

2 Press TV.

The RM SET UP and the SHIFT button indicator light up.

3 Press the numeric buttons to enter the numeric code (or one of the codes if more than one code exists) for TV. For details, see page 86.

4 Press ENT/MEM.

Once the numeric code has been verified, the RM SET UP indicator slowly flashes twice and the remote automatically exits the programming mode.

To cancel programming

Press RM SET UP during any step. The RM SET UP indicator flashes 5 times in quick succession. The remote automatically exits the programming mode.

To activate the input after programming

Press the programmed button to activate the input you want.

If programming is unsuccessful, check the following:

- If the indicator does not light up in step 1, the batteries are weak. Replace both batteries.
- If the indicator flashes 5 times in quick succession while entering the numeric code, an error has occurred. Start again from step 1.

To clear the memory of the remote

To clear all programmes, do the following to reset the remote to factory settings.

While holding down MASTER VOL –, press and hold I/⏻ and then press AV I/⏻.

The indicator flashes 3 times, then goes off.

The numeric codes corresponding to the component and the maker of the component

Use the numeric codes in the tables below to control non-Sony components and also Sony components that the remote is normally unable to control. Since the remote signal that a component accepts differs depending on the model and year of the component, more than one numeric code may be assigned to a component. If you fail to program your remote using one of the codes, try using other codes.

Notes

- The numeric codes are based on the latest information available for each brand. There is a chance, however, that your component will not respond to some or all of the codes.
- All of the input buttons on this remote may not be available when used with your particular component.

To control a CD player

Maker	Code(s)
SONY	101, 102, 103
DENON	104, 123
JVC	105, 106, 107
KENWOOD	108, 109, 110
MAGNAVOX	111, 116
MARANTZ	116
ONKYO	112, 113, 114
PANASONIC	115
PHILIPS	116
PIONEER	117
TECHNICS	115, 118, 119
YAMAHA	120, 121, 122

To control a DAT deck

Maker	Code(s)
SONY	203
PIONEER	219

To control an MD deck

Maker	Code(s)
SONY	301
DENON	302
JVC	303
KENWOOD	304

To control a tape deck

Maker	Code(s)
SONY	201, 202
DENON	204, 205
KENWOOD	206, 207, 208, 209
NAKAMICHI	210
PANASONIC	216
PHILIPS	211, 212
PIONEER	213, 214
TECHNICS	215, 216
YAMAHA	217, 218

To control an LD player

Maker	Code(s)
SONY	601, 602, 603
PIONEER	606

To control a video CD player

Maker	Code(s)
SONY	605

To control a VCR

Maker	Code(s)
SONY	701, 702, 703, 704, 705, 706
AIWA*	710, 750, 757, 758
AKAI	707, 708, 709, 759
BLAUPUNKT	740
EMERSON	711, 712, 713, 714, 715, 716, 750
FISHER	717, 718, 719, 720
GENERAL ELECTRIC (GE)	721, 722, 730
GOLDSTAR/LG	723, 753
GRUNDIG	724
HITACHI	722, 725, 729, 741
ITT/NOKIA	717
JVC	726, 727, 728, 736
MAGNAVOX	730, 731, 738
MITSUBISHI/MGA	732, 733, 734, 735
NEC	736
PANASONIC	729, 730, 737, 738, 739, 740
PHILIPS	729, 730, 731
PIONEER	729
RCA/PROSCAN	722, 729, 730, 731, 741, 747
SAMSUNG	742, 743, 744, 745
SANYO	717, 720, 746
SHARP	748, 749
TELEFUNKEN	751, 752
TOSHIBA	747, 756
ZENITH	754

* If an AIWA VCR does not work even though you enter the code for AIWA, enter the code for Sony instead.

To control a DVD player

Maker	Code(s)
SONY	401, 402, 403
BROKSONIC	424
DENON	405
HITACHI	416
JVC	415, 423
MITSUBISHI	419
ORITRON	417
PANASONIC	406, 408, 425
PHILIPS	407
PIONEER	409, 410
RCA	414
SAMSUNG	416, 422
TOSHIBA	404, 421
ZENITH	418, 420

To control a DVD recorder

Maker	Code(s)
SONY	401, 402, 403

To control a TV

Maker	Code(s)
SONY	501
AIWA	501, 536, 539
AKAI	503
AOC	503
CENTURION	566
CORONADO	517
CURTIS-MATHES	503, 551, 566, 567
DAYTRON	517, 566
DAEWOO	504, 505, 506, 507, 515, 544
FISHER	508, 545
FUNAI	548
FUJITSU	528
GOLDSTAR/LG	503, 512, 515, 517, 534, 544, 556, 568
GRUNDIG	511, 533, 534
HITACHI	503, 513, 514, 515, 517, 519, 544, 557, 571
ITT/NOKIA	521, 522
J.C.PENNY	503, 510, 566
JVC	516, 552
KMC	517
MAGNAVOX	503, 515, 517, 518, 544, 566
MARANTZ	527
MITSUBISHI/MGA	503, 519, 527, 544, 566, 568
NEC	503, 517, 520, 540, 544, 554, 566
NORDMENDE	530, 558
NOKIA	521, 522, 573, 575
PANASONIC	509, 524, 553, 559, 572
PHILIPS	515, 518, 557, 570, 571
PHILCO	503, 504, 514, 517, 518
PIONEER	509, 525, 526, 540, 551, 555
PORTLAND	503
QUASAR	509, 535

Maker	Code(s)
RADIO SHACK	503, 510, 527, 565, 567
RCA/PROSCAN	503, 510, 523, 529, 544
SAMSUNG	503, 515, 517, 531, 532, 534, 544, 556, 557, 562, 563, 566, 569
SAMPO	566
SABA	530, 537, 547, 549, 558
SANYO	508, 545, 546, 560, 567
SCOTT	503, 566
SEARS	503, 508, 510, 517, 518, 551
SHARP	517, 535, 550, 561, 565
SYLVANIA	503, 518, 566
THOMSON	530, 537, 547, 549
TOSHIBA	535, 539, 540, 541, 551
TELEFUNKEN	530, 537, 538, 547, 549, 558
TEKNIKA	517, 518, 567
WARDS	503, 517, 566
YORK	566
ZENITH	542, 543, 567
GE	503, 509, 510, 544
LOEWE	515, 534, 556

To control a satellite tuner

Maker	Code(s)
SONY	801, 802, 803, 804, 824, 825, 865
AMSTRAD	845, 846
BskyB	862
GENERAL ELECTRIC (GE)	866
GRUNDIG	859, 860
HUMAX	846, 847
THOMSON	857, 861, 864, 876
PACE	848, 849, 850, 852, 862, 863, 864
PANASONIC	818, 855
PHILIPS	856, 857, 858, 859, 860, 864, 874
NOKIA	851, 853, 854, 864
RCA/PROSCAN	866, 871
BITA/HITACHI	868
HUGHES	867
JVC/EchoStar/Dish Network	873
mitsubishi	872
SAMSUNG	875
TOSHIBA	869, 870

To control a cable box

Maker	Code(s)
SONY	821, 822, 823
HAMLIN/REGAL	836, 837, 838, 839, 840
JERROLD/G.I./MOTOROLA	806, 807, 808, 809, 810, 811, 812, 813, 814, 819
JERROLD	830, 831
OAK	841, 842, 843
PANASONIC	816, 826, 832, 833, 834, 835
PHILIPS	830, 831
PIONEER	828, 829
RCA	805
SCIENTIFIC ATLANTA	815, 816, 817, 844
TOCOM/PHILIPS	830, 831
ZENITH	826, 827

To control a tuner

Maker	Code(s)
SONY	002, 005

To control a Blu-ray disc recorder

Maker	Code(s)
SONY	310, 311, 312

To control a PSX

Maker	Code(s)
SONY	313, 314, 315

To control a DVD/VHS COMBO

Maker	Code(s)
SONY	411

To control a DVD/HDD COMBO

Maker	Code(s)
SONY	401, 402, 403

Glossary

■ Cinema Studio EX

A surround sound mode that can be regarded as the compilation of Digital Cinema Sound technology, delivers the sound of a dubbing theater using three technologies: “Virtual Multi Dimensions,” “Screen Depth Matching,” and “Cinema Studio Reverberation.”

“Virtual Multi Dimensions,” the virtual speaker technology, creates a virtual multi-surround environment with actual speakers up to 7.1 channels, and brings the surround sound experience of a theater with the latest facilities into your home.

“Screen Depth Matching” reproduces treble attenuation, fullness, and depth of sound usually created in a theater using sound emission from behind the screen. This is then added to the front and center channels.

“Cinema Studio Reverberation” reproduces the sound characteristics of state-of-the-art dubbing theaters and recording studios, including Sony Pictures Entertainment’s dubbing studios. There are three modes, A/B/C, available according to the studio type.

■ Component video

A format for transmitting video signal information consisting of three separate signals: luminance Y, chrominance Pb, and chrominance Pr. High quality pictures, such as DVD video or HDTV pictures, are transmitted more faithfully. The three jacks are color-coded green, blue and red.

■ Composite video

A standard format for transmitting video signal information. The luminance signal Y and chrominance signal C are combined and transmitted together.

■ Deep Color

Video signals for which the color depth of signals passing through an HDMI jack have been raised.

The number of colors that could be expressed by 1 pixel was 24 bits (16,777,216 colors) with the current HDMI jack. However, the number of colors which can be expressed by 1 pixel will be 36 bits, etc., when the receiver corresponds to Deep Color.

Since the gradation of the depth of a color can be expressed more finely with more bits, continuous color changes can be more smoothly expressed.

■ Digital Cinema Sound (DCS)

A unique sound reproduction technology for home theater developed by Sony, in cooperation with Sony Pictures Entertainment, for enjoying the exciting and powerful sound of movie theaters at home. With this “Digital Cinema Sound” developed by integrating a DSP (Digital Signal Processor) and measured data, the ideal sound field intended by filmmakers can be experienced at home.

■ Dolby Digital

Digital audio encoding/decoding technology developed by Dolby Laboratories, Inc. It consists of front (left/right), center, surround (left/right) and subwoofer channels. It is a designated audio standard for DVD video and also known as 5.1 channel surround. Since surround information is recorded and reproduced in stereo, more realistic sound with fuller presence is delivered than with Dolby surround.

■ Dolby Digital Plus

Dolby Digital Plus provides the flexibility and efficiency to deliver more channels of compelling surround sound for high-definition video media. Its superior coding efficiencies enable up to 7.1ch of high-quality multichannel audio without negatively impacting bit budgets allocated for video performance or additional feature sets.

■ **Dolby Digital Surround EX**

Acoustic technology developed by Dolby Laboratories, Inc. Surround back information is matrixed into regular left and right surround channels so that the sound can be reproduced in 6.1 channel. Active scenes, especially, are recreated with a more dynamic and realistic sound field.

■ **Dolby Pro Logic II**

This technology converts 2 channel stereo recorded audio into 5.1 channel for playback. There is a MOVIE mode for movies and MUSIC mode for stereo sources such as music. Old movies encoded in the traditional stereo format can be enhanced with 5.1 channel surround sound. The GAME mode is suitable for video games.

■ **Dolby Pro Logic IIx**

Technology for 7.1 channel (or 6.1 channel) playback. Along with audio encoded in Dolby Digital Surround EX, 5.1 channel Dolby Digital encoded audio can be reproduced in 7.1 channel (or 6.1 channel). Furthermore, existing stereo recorded content can also be reproduced in 7.1 channel (or 6.1 channel).

■ **Dolby Surround (Dolby Pro Logic)**

Audio processing technology developed by Dolby Laboratories, Inc. Center and mono surround information is matrixed into two stereo channels. When reproduced, audio is decoded and output in 4 channel surround sound. This is the most common audio processing method for DVD video.

■ **Dolby TrueHD**

Dolby TrueHD is Dolby's lossless audio technology developed for high-definition optical discs. Dolby TrueHD audio is bit-for-bit identical to the original studio masters and provides supreme-quality audio up to 8 channel at 96 kHz/24 bit and up to 6ch at 192 kHz/24 bit. Together with high-definition video, it offers an unprecedented home theater experience.

■ **DTS 96/24**

A high sound quality digital signal format. It records audio at a sampling frequency and bit rate of 96 kHz/24bit which is the highest possible for DVD video. The number of playback channels varies depending on the software.

■ **DTS Digital Surround**

Digital audio encoding/decoding technology for theaters developed by DTS, Inc. It compresses audio less than Dolby Digital, delivering a higher quality sound reproduction.

■ **DTS-ES**

Format for 6.1 channel playback with surround back information. There are two modes, "Discrete 6.1" which records all channels independently, and "Matrix 6.1" which matrixes surround back channel into surround left and surround right channels. It is ideal for playback of motion picture soundtracks.

■ **DTS-HD**

Audio format which extends the conventional DTS Digital Surround format. This format consists of a core and an extension, and the core part has DTS Digital Surround compatibility. There are two kinds of DTS-HD, DTS-HD High Resolution Audio and DTS-HD Master Audio. DTS-HD High Resolution Audio has a maximum transmission rate of 6 Mbps, with lossy compression (Lossy), and DTS-HD High Resolution Audio corresponds to a maximum sampling frequency of 96 kHz, and a maximum of 7.1 channel. DTS-HD Master Audio has a maximum transmission rate of 24.5 Mbps, and uses lossless compression (Lossless), and DTS-HD Master Audio corresponds to a maximum sampling frequency of 192 kHz, and a maximum of 7.1 channel.

■ DTS Neo:6

This technology converts 2 channel stereo recorded audio for 6.1 channel playback. There are two modes to select according to the playback source or your preference, CINEMA for movies, and MUSIC for stereo sources such as music.

■ HDMI (High-Definition Multimedia Interface)

HDMI (High-Definition Multimedia Interface) is an interface that supports both video and audio on a single digital connection, allowing you to enjoy high quality digital picture and sound. The HDMI specification supports HDCP (High-bandwidth Digital Contents Protection), a copy protection technology that incorporates coding technology for digital video signals.

■ Neutral THX

Neural-THX Surround is taking surround sound to the next level. This revolutionary new technology delivers the rich envelopment and discrete image detail of surround sound in a format that is fully compatible with stereo. Neural-THX Surround reduces the bandwidth needed for broadcasters to deliver true, multi-channel surround presentations, and enables 7.1-channel support for gaming and movies. By unmasking the audio details, typically lost by other playback systems, audiences will experience the deep ambience and subtle details of movies, music and games. And with this technology being used by sound designers during content creation, as well as embedded into playback devices, Neural-THX Surround promises a listening experience that is true to the original mix.

Neural-THX Surround has been chosen as the official surround sound broadcast format for XM Satellite Radio's "XM HD Surround", as well as other leading FM/HD radio stations worldwide.

■ Sampling frequency

To convert analog audio to digital, analog data should be quantified. This process is called sampling, and the number of times per second the analog data is quantified is called the sampling frequency. A standard music CD stores data quantified at 44,100 times per second, which is expressed as a sampling frequency of 44.1 kHz. Generally speaking, a higher sampling frequency means better sound quality.

■ x.v.Colour

x.v.Colour is a more familiar term for the xvYCC standard proposed by Sony, and is a trademark of Sony. xvYCC is an international standard for color space in video. This standard can express a wider colour range than the currently used broadcast standard.

Precautions

On safety

Should any solid object or liquid fall into the cabinet, unplug the receiver and have it checked by qualified personnel before operating it any further.

On power sources

- Before operating the receiver, check that the operating voltage is identical with your local power supply.
The operating voltage is indicated on the nameplate on the back of the receiver.
- The unit is not disconnected from the AC power source (mains) as long as it is connected to the wall outlet, even if the unit itself has been turned off.
- If you are not going to use the receiver for a long time, be sure to disconnect the receiver from the wall outlet. To disconnect the AC power cord (mains lead), grasp the plug itself; never pull the cord.
- The AC power cord (mains lead) must be changed only at a qualified service shop.

On heat buildup

Although the receiver heats up during operation, this is not a malfunction. If you continuously use this receiver at a large volume, the cabinet temperature of the top, side and bottom rises considerably. To avoid burning yourself, do not touch the cabinet.

On placement

- Place the receiver in a location with adequate ventilation to prevent heat buildup and prolong the life of the receiver.
- Do not place the receiver near heat sources, or in a place subject to direct sunlight, excessive dust, or mechanical shock.
- Do not place anything on top of the cabinet that might block the ventilation holes and cause malfunctions.
- Do not place the receiver near equipment such as a TV, VCR, or tape deck. (If the receiver is being used in combination with a TV, VCR, or tape deck, and is placed too close to that equipment, noise may result, and picture quality may suffer. This is especially likely when using an indoor antenna (aerial). Therefore, we recommend using an outdoor antenna (aerial).)
- Use caution when placing the receiver on surfaces that have been specially treated (with wax, oil, polish, etc.) as staining or discoloration of the surface may result.

On operation

Before connecting other components, be sure to turn off and unplug the receiver.

On cleaning

Clean the cabinet, panel, and controls with a soft cloth slightly moistened with a mild detergent solution. Do not use any type of abrasive pad, scouring powder, or solvent, such as alcohol or benzine.

If you have any questions or problems concerning your receiver, please consult your nearest Sony dealer.

Troubleshooting

If you experience any of the following difficulties while using the receiver, use this troubleshooting guide to help you remedy the problem.

Audio

There is no sound, no matter which component is selected, or only a very low-level sound is heard.

- Check that the speakers and components are connected correctly and securely.
- Check that all speaker cords are connected correctly.
- Check that both the receiver and all components are turned on.
- Check that MASTER VOLUME is not set to “VOL MIN”.
- Check that the SPEAKERS (OFF/A/B/A+B) is not set to off (page 30).
- Check that headphones are not connected.
- Press MUTING on the remote to cancel the muting function.
- Check that you have selected the correct component with the input buttons (page 38).
- When only a very low-level sound is heard, check to see if NIGHT MODE is activated (page 61).
- The protective device on the receiver has been activated. Turn off the receiver, eliminate the short-circuit problem, and turn on the power again.

There is no sound from a specific component.

- Check that the component is connected correctly to the audio input jacks for that component.
- Check that the cord(s) used for the connection is (are) fully inserted into the jacks on both the receiver and the component.

There is no sound from one of the front speakers.

- Connect a pair of headphones to the PHONES jack to verify that sound is output from the headphones. If only one channel is output from the headphones, the component may not be connected to the receiver correctly. Check that all the cords are fully inserted into the jacks on both the receiver and the component. If both channels are output from the headphones, the front speaker may not be connected to the receiver correctly. Check the connection of the front speaker which is not outputting any sound.
- Make sure you have connected to both the L and R jacks of an analog component, and not only to either the L or R jack. Use an audio cord (not supplied).

There is no sound from analog 2 channel sources.

- Check that the INPUT MODE is not set to “AUTO” (page 75) and the DIGITAL and HDMI connection is not made for the selected input.
- Check that the INPUT MODE is not set to “COAX” or “OPT” for the selected input (page 75).
- Check that the DIGITAL ASSIGN function is not used to reassign the audio input of another source to the selected input (page 76).

There is no sound from digital sources (from COAXIAL or OPTICAL input jack).

- Check that the INPUT MODE is not set to “ANALOG” (page 75).
- Check that the ANALOG DIRECT function is not selected.
- Check that the DIGITAL ASSIGN function is not used to reassign the audio input of another source to the selected input (page 76).

There is pop noise from a specific component connected to this receiver when you turn on the component.

- Check that the INPUT MODE is not set to “AUTO” for the selected input (page 75).

The left and right sounds are unbalanced or reversed.

- Check that the speakers and components are connected correctly and securely.
- Adjust the balance parameters using the LEVEL menu.

There is severe hum or noise.

- Check that the speakers and components are connected securely.
- Check that the connecting cords are away from a transformer or motor, and at least 3 meters away from a TV set or fluorescent light.
- Move your audio components away from the TV.
- The plugs and jacks are dirty. Wipe them with a cloth slightly moistened with alcohol.

There is no sound, or only a very low-level sound is heard from the center/surround/surround back speakers.

- Select a CINEMA STUDIO EX mode (page 60).
- Adjust the speaker level (page 37).
- Make sure the center/surround speakers are set to either “SMALL” or “LARGE” (page 49).
- Check “SP PATTERN” setting (page 48).

There is no sound from the subwoofer.

- Check that the subwoofer is connected correctly and securely.
- Make sure you have turned on your subwoofer.
- Depending on the selected sound field, no sound output from the subwoofer.
- When all speakers are set to “LARGE” and “NEO6 CIN” or “NEO6 MUS” is selected, there is no sound from the subwoofer.
- Check “SP PATTERN” setting (page 48).

The surround effect cannot be obtained.

- Make sure the sound field function is on (press MOVIE or MUSIC).
- Sound fields do not function for signals with a sampling frequency of more than 48 kHz.

Dolby Digital or DTS multi channel sound is not reproduced.

- Check that the DVD, etc. you are playing is recorded in Dolby Digital or DTS format.
- When connecting the DVD player, etc., to the digital input jacks of this receiver, check the audio setting (the settings for the audio output) of the connected component.

Recording cannot be carried out.

- Check that the components are connected correctly.
- Select the source component using the input buttons (page 38).

There is no sound from the component connected to the DIGITAL MEDIA PORT adapter.

- Adjust the volume of this receiver.
- The DIGITAL MEDIA PORT adapter and/or component is not connected correctly. Turn off the receiver, then reconnect the DIGITAL MEDIA PORT adapter and/or component.
- Check the DIGITAL MEDIA PORT adapter and/or component device to make sure it supports this receiver.

Video

There is no picture or an unclear picture appears on the TV screen or monitor.

- Select the appropriate input using the input buttons.
- Set your TV to the appropriate input mode.
- Move your audio components away from the TV.
- Depending on the DIGITAL MEDIA PORT adapter, video output may not be possible.

The image of the COMPONENT VIDEO OUT is corrupted.

- Video input signals other than 480p component are not received when signals are output from the VIDEO jack. Input 480i component video signals.

Recording cannot be carried out.

- Check that the components are connected correctly.
 - Select the source component using the input buttons (page 38).
-

Tuner

The FM reception is poor.

- Use a 75-ohm coaxial cable (not supplied) to connect the receiver to an outdoor FM antenna (aerial) as shown below. If you connect the receiver to an outdoor antenna (aerial), ground it against lightning. To prevent a gas explosion, do not connect the ground (earth) wire to a gas pipe.

Outdoor FM antenna (aerial)

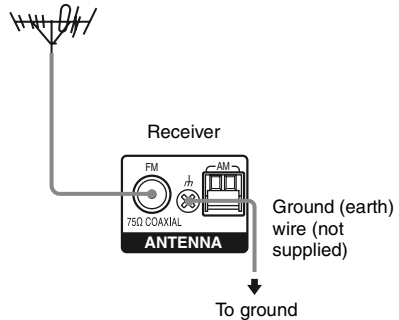

Radio stations cannot be tuned in.

- Check that the antennas (aerials) are connected securely. Adjust the antennas (aerials) and connect an external antenna (aerial), if necessary.
- The signal strength of the stations is too weak (when tuning in with automatic tuning). Use direct tuning.
- Make sure you set the tuning interval correctly (when tuning in AM stations with direct tuning).
- No stations have been preset or the preset stations have been cleared (when tuning by scanning preset stations). Preset the stations (page 65).
- Press DISPLAY repeatedly on the receiver so that the frequency appears on the display.
- Keep the satellite radio antenna (aerial) away from the speaker cords and the power cord to avoid picking up noise.

RDS does not work.*

- Make sure that you are tuned to an FM RDS station.
- Select a stronger FM station.

The RDS information that you want does not appear.*

- Contact the radio station and find out whether they actually provide the service in question. If so, the service may be temporarily out of order.

* Models of area code CEL, CEK, ECE only.

HDMI

The source sound input to the HDMI jack is not output from the receiver or the TV speaker.

- Check the HDMI connection (page 71).
- You cannot listen to the Super Audio CD by connecting HDMI.
- Depending on the playback component, you may need to set up the component. Refer to the operating instructions supplied with each component.
- Be sure to use a connecting cable for the HDMI jack corresponding to high speed (an HDMI version 1.3, category 2 cable) when you view images or listen to sound during a Deep Color transmission.

The source image input to the HDMI jack is not output from the TV.

- Check the HDMI connection (page 71).
- Depending on the playback component, you may need to set up the component. Refer to the operating instructions supplied with each component.
- Be sure to use a connecting cable for the HDMI jack corresponding to high speed (an HDMI version 1.3, category 2 cable) when you view images or listen to sound during a Deep Color transmission.

The Control for HDMI function does not work.

- Check the HDMI connection (page 71).
- Make sure “CTRL:HDMI” is set to “CTRL ON” in the HDMI menu.
- Make sure the connected component is compatible with the Control for HDMI function.
- Check the Control for HDMI settings on the connected component. Refer to the operating instructions of the connected component.
- Repeat the procedures of “Preparing Control for HDMI function” if you change the HDMI connection, connect/disconnect the AC power cord, or when there is a power failure (page 72).

No sound is output from the receiver and TV speaker while using the System Audio Control function.

- Make sure the TV is compatible with the System Audio Control function.
- If the TV does not have System Audio Control function, set the “AUDIO OUT” settings in HDMI menu to
 - “TV+AMP” if you want to listen to the sound from the TV speaker and receiver.
 - “AMP” if you want to listen to the sound from the receiver.
- If you cannot listen to the sound of a component connected to the receiver
 - Change the input of the receiver to HDMI when you want to watch a program on a component connected via HDMI connection to the receiver.
 - Change the TV channel when you want to watch a TV broadcast.
 - Select the component or input you want to watch when you watch a program on the component connected to the TV. Refer to the operating instructions of the TV on this operation.

Remote commander

The remote does not function.

- Point the remote at the remote sensor on the receiver.
 - Remove any obstacles in the path between the remote and the receiver.
 - Replace all the batteries in the remote with new ones, if they are weak.
 - Make sure you select the correct input on the remote.
 - When you operate a programmed non-Sony component, the remote may not function properly depending on the model and the maker of the component.
-

Error messages

If there is a malfunction, the display shows a message. You can check the condition of the system by the message. See the following table to solve the problem. If any problem persists, consult your nearest Sony dealer.

PROTECTOR

- Irregular current is output from the speakers. The receiver will automatically turn off after a few seconds. Check the speaker connection and turn on the power again.
-

For other messages, see “Message list after Auto Calibration measurement” (page 35).

If you are unable to remedy the problem using the troubleshooting guide

Clearing the receiver’s memory may remedy the problem (page 29). However, note that all memorized settings will be reset to their factory settings and you will have to readjust all settings on the receiver.

If the problem persist

Consult your nearest Sony dealer. Note that if service personnel changes some parts during repair, these parts may be retained.

Reference sections for clearing the receiver’s memory

To clear	See
All memorized settings	page 29
Customized sound fields	page 63

Specifications

Amplifier section

Models of area code CEL, CEK, ECE, AU¹⁾

Minimum RMS Output Power
(8 ohms, 20 Hz – 20 kHz, THD 0.09%)
85 W + 85 W

Stereo Mode Output Power
(8 ohms, 1 kHz, THD 0.7%)
100 W + 100 W

Surround Mode Output Power²⁾
(8 ohms, 1 kHz, THD 10%)
140 W per channel

Models of area code E51¹⁾

Minimum RMS Output Power
(8 ohms, 20 Hz – 20 kHz, THD 0.09%)
85 W + 85 W

Stereo Mode Output Power
(8 ohms, 1 kHz, THD 0.7%)
100 W + 100 W

Surround Mode Output Power²⁾
(8 ohms, 1 kHz, THD 10%)
140 W per channel

¹⁾Measured under the following conditions:

Area code	Power requirements
CEL, CEK, ECE	230 V AC, 50 Hz
AU, E51	240 V AC, 50 Hz

²⁾Reference power output for front, center, surround and surround back speakers. Depending on the sound field settings and the source, there may be no sound output.

Frequency response

Analog 10 Hz – 70 kHz,
+0.5/-2 dB (with sound field and equalizer bypassed)

Input

Analog Sensitivity: 500 mV/
50 kohms
S/N³⁾: 96 dB
(A, 500 mV⁴⁾)

Digital (Coaxial) Impedance: 75 ohms
S/N: 100 dB
(A, 20 kHz LPF)

Digital (Optical) S/N: 100 dB
(A, 20 kHz LPF)

Output (analog)

AUDIO OUT Voltage: 500 mV/
10 kohms

SUBWOOFER Voltage: 2 V/1 kohm

Equalizer

Gain levels ±10 dB, 1 dB step

³⁾INPUT SHORT (with sound field and equalizer bypassed).

⁴⁾Weighted network, input level.

FM tuner section

Tuning range 87.5 MHz – 108.0 MHz

Antenna (aerial) FM wire antenna (aerial)

Antenna (aerial) terminals
75 ohms, unbalanced

Intermediate frequency
10.7 MHz

AM tuner section

Tuning range

Area code	Tuning scale	
	10 kHz step	9 kHz step
CEL, CEK, ECE	–	531 kHz – 1,602 kHz
AU, E51	530 kHz – 1,710 kHz ⁵⁾	531 kHz – 1,710 kHz ⁵⁾

Antenna (aerial) Loop antenna
Intermediate frequency 450 kHz

⁵⁾You can change the AM tuning scale to 9 kHz or 10 kHz. After tuning in any AM station, turn off the receiver. While holding down TUNING MODE, press POWER on the receiver. All preset stations will be erased when you change the tuning scale. To reset the scale to 10 kHz (or 9 kHz), repeat the procedure.

Video section

Inputs/Outputs

Video: 1 Vp-p, 75 ohms

COMPONENT VIDEO:

Y: 1 Vp-p, 75 ohms

P_B/C_B: 0.7 Vp-p, 75 ohms

P_R/C_R: 0.7 Vp-p, 75 ohms

80 MHz HD Pass Through

General

Power requirements

Area code	Power requirements
CEL, CEK, ECE	230 V AC, 50/60 Hz
AU	240 V AC, 50 Hz
E51	120/220/240 V AC, 50/60 Hz

Power output (DIGITAL MEDIA PORT)

DC OUT: 5V, 0.7 A MAX

Power consumption

Area code	Power consumption
CEL, CEK, ECE, AU, E51	230 W

Power consumption (during standby mode)

0.7 W

(When “CTRL:HDMI” in HDMI menu is set to “CTRL OFF”)

Dimensions (width/height/depth) (Approx.)

430 × 157.5 × 318 mm

including projecting parts and controls

Mass (Approx.)

8.4 kg

Supplied accessories

Operating instructions (this manual)

Quick Setup Guide (1)

FM wire antenna (aerial) (1)

AM loop antenna (aerial) (1)

Remote commander (RM-AAP022) (1)

R6 (size-AA) batteries (2)

Optimizer microphone (ECM-AC2) (1)

For details on the area code of the component you are using, see page 3.

Design and specifications are subject to change without notice.

Index

Numerics

- 2CH STEREO 62
- 5.1 channel 16
- 7.1 channel 16

A

- AUTO CALIBRATION 31
- AUTO FORMAT DIRECT (A.F.D.) 57

B

- Blu-ray disc player
 - connecting 23
 - playback 41

C

- CD player
 - connecting 21
 - playback 40
- CD recorder
 - connecting 21
- Control for HDMI
 - connecting 71
 - preparing 72

D

- DIGITAL ASSIGN 76
- DIGITAL MEDIA PORT
 - connecting 79
 - input 38
- Dolby Digital 88
- Dolby Digital EX 56
- DTS 89
- DVD player
 - connecting 25
 - playback 41
- DVD recorder
 - connecting 27

E

- Error messages 96

H

- HDMI
 - connecting 23

I

- Initial setup 29
- INPUT MODE 75

M

- Menu
 - AUDIO 53
 - EQ 52
 - HDMI 54
 - LEVEL 47
 - SPEAKER 48
 - SURROUND 51
 - SYSTEM 55
 - TUNER 52
- Muting 39

N

- Naming 67, 80
- NIGHT MODE 61

O

- One-Touch Play 73

P

- Phase Audio 47
- Phase Noise 47

R

- RDS 68
- Recording
 - onto a CD-R 82
 - onto a recording media 82
- Remote commander 11

S

- Satellite tuner/Set-top box
 - connecting 26
- Selecting
 - component 38
 - sound field 60
 - speaker system 30
- Sleep Timer 81
- Sound fields
 - resetting 63
 - selecting 60
- Speakers
 - connecting 17
 - installing 16
- Super Audio CD player
 - connecting 21
 - playback 40
- System Audio Control 74
- System Power Off 75

T

- Test Tone 47
- Tuner
 - connecting 28
- Tuning
 - automatically 63
 - directly 64
 - to preset stations 66
- TV
 - connecting 19

V

- VCR
 - connecting 27
- Video game
 - connecting 27



* 3 2 8 9 4 5 0 4 5 * (1)

