

Trinitron Color TV

Operating Instructions _____ **GB**

- Before operating the unit, please read this manual thoroughly and retain it for future reference.

_____ **CT**

_____ **CS**

KV-XF25M80
KV-XF29M80

WARNING

- Dangerously high voltages are present inside the TV.
- Operate the TV only between 110 – 240 V AC.

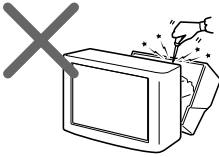

Do not open the cabinet or the rear cover of the TV. Refer servicing to qualified personnel.

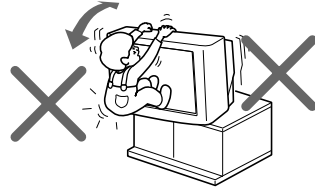

Install the TV in a stable position. Do not allow children to climb onto it.

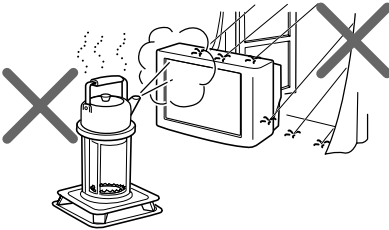

To prevent fire or shock hazard, do not expose the TV to rain or moisture.

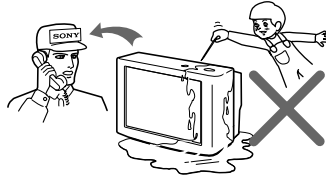

Do not operate the TV if any liquid or solid object falls into it. Have it checked immediately by qualified personnel only.

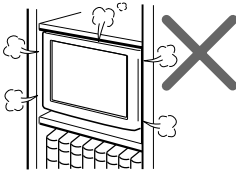

Do not install the TV in a confined space, such as a bookcase or built-in cabinet. Do not block the ventilation openings of the TV.

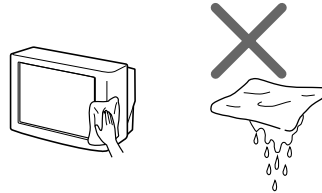

Clean the TV with a dry soft cloth. Do not use benzine, thinner, or any other chemicals to clean the TV. Do not scratch the picture tube.

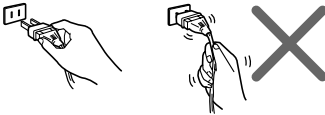

Do not pull the power cord to disconnect the TV. Pull it out by the plug.

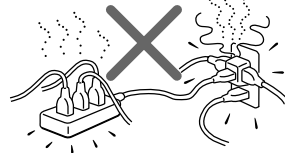

Do not plug too many appliances into the same power socket. Do not damage the power cord.

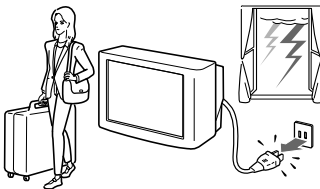

Disconnect the power cord during lightning storms or if you are not going to use the TV for several days.

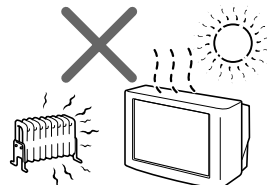

Do not install the TV in hot, humid or excessively dusty places.

Table of Contents

WARNING

Using Your New TV

Getting Started	4
Step 1: Connect the antenna	4
Step 2: Insert the batteries into the remote	5
Step 3: Preset the channels automatically	5
Connecting optional components	6
Securing the TV	7
Watching the TV	8



Advanced Operations

Selecting the picture and sound modes	11
Viewing your favorite channels — FAVORITE CHANNEL	12
Listening with surround sound	13

Additional Information

Troubleshooting	25
Self-diagnosis function	28
Identifying parts and controls	29
Specifications	Back cover

Adjusting Your Setup (MENU)

Introducing the menu system	14
How to use the menu	15
Changing the A/V CONTROL settings 	16
Changing the SET UP settings 	18
Changing the Channel Preset (CH PRESET) settings 	21

The features you will enjoy include:

- FAVORITE CH for quick and easy channel selection (page 12)
- PICTURE MODE/SOUND MODE/SURROUND for customizing your TV (pages 11, 13)

Your TV also offers the following setup features:

- Menu language options — English/Chinese (page 9)
- CHILD LOCK for preventing children from watching certain programs (page 19)
- INTELLIGENT VOL for automatic volume adjustment (page 20)
- PIC ROTATION for picture position adjustment (page 20)

Getting Started

Step 1

Connect the antenna

If you wish to connect a VCR, see the “Connecting a VCR” diagram below.

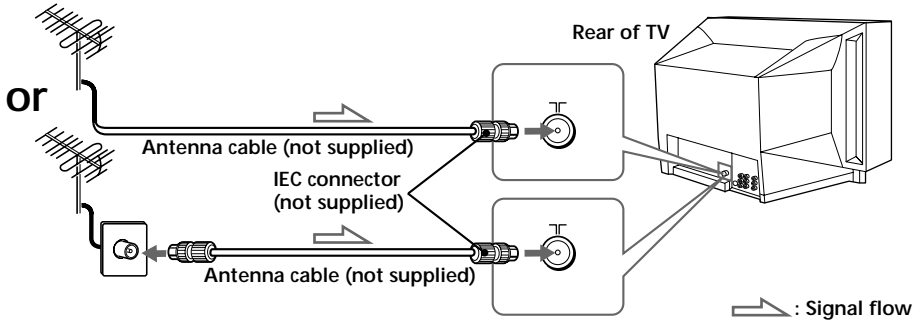

CAUTION





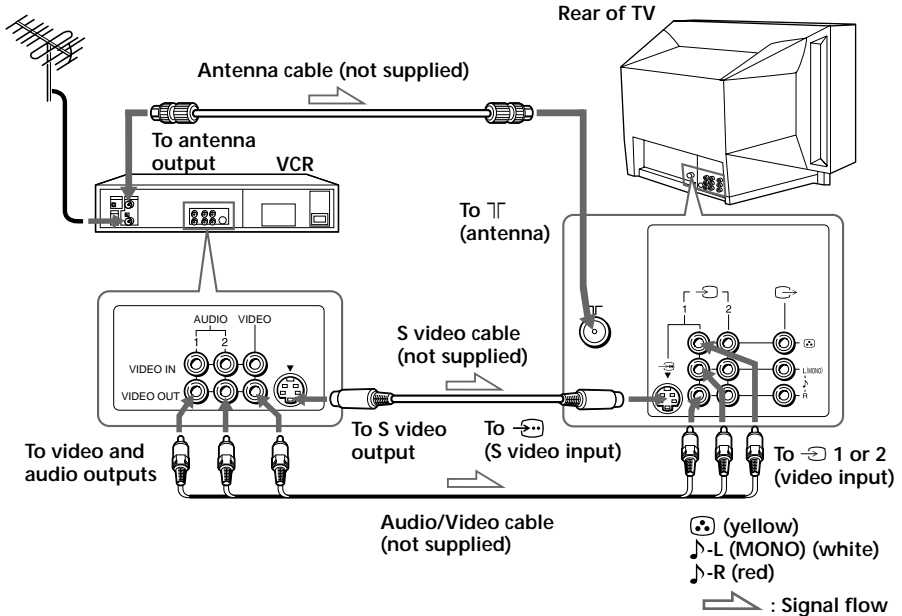

Do not connect the power cord until all other connections are complete; otherwise, a minimal current leakage through the antenna and/or other terminals to the ground could occur.

Connecting a VCR

To play a video tape, see page 9.



Notes

- If you connect a monaural VCR, connect the yellow plug to  (the yellow jack) and the black plug to -L (MONO) (the white jack).
- If you connect a VCR to the  (antenna) terminal, preset the signal output from the VCR to the program number 0 on the TV.
- When both the  (S video input) and 1 (video input) are connected, the  (S video input) is automatically selected. To view the video input to 1 (video input), disconnect the S video cable.
- When no signal is input to the connected video equipment, the TV screen becomes blue.

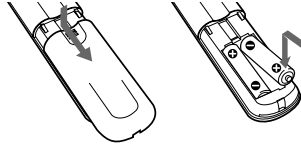
Step 2**Insert the batteries into the remote****Note**

- Do not use old batteries or different types of batteries together.

Step 3**Preset the channels automatically**

Front of TV

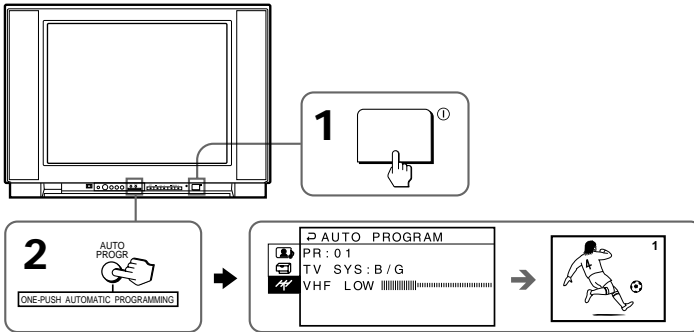
**Tip**

- To stop the automatic channel presetting, press MENU twice.

Now You Are Ready. . .

To preset the channels manually, see page 21.

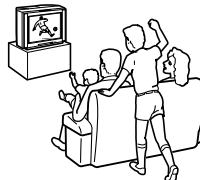

Connecting optional components



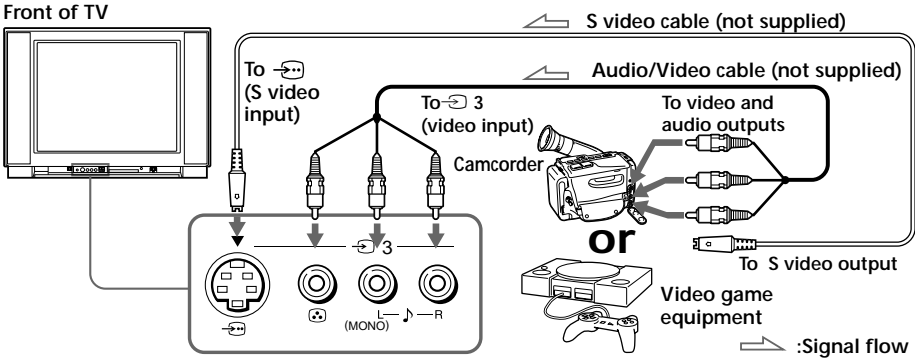

You can connect optional audio/video components, such as a VCR, multi disc player, camcorder, video game or stereo system.

To watch the picture of the connected equipment, see page 9.

Connecting a camcorder/video game equipment using the (video input) jacks



Notes

- You can also connect video equipment to the 1 or 2 (video input) jacks at the rear of your TV.
- When both the  (S video input) and 3 (video input) are connected, the  (S video input) is automatically selected. To view the video input to 3 (video input), disconnect the S video cable.

Connecting audio/video equipment using the (monitor output) jacks

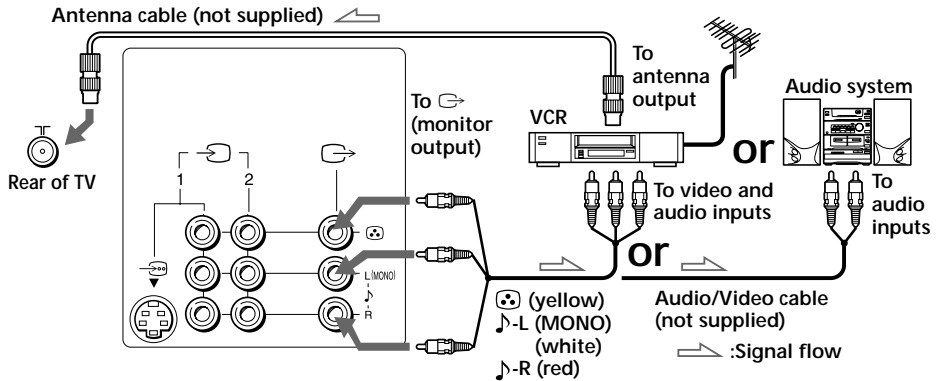

Note

- When connecting a monaural VCR, connect the yellow plug to  (the yellow jack) and the black plug to L-MONO (the white jack).

Securing the TV

To prevent the TV from falling, secure the TV using one of the following methods:

- A** With the supplied screws, attach the stabilizer band to the TV stand and to the rear of the TV using the provided hole.

or

- B** Pass a cord or chain through the clamps and secure them to the rear of the TV and a wall or pillar.

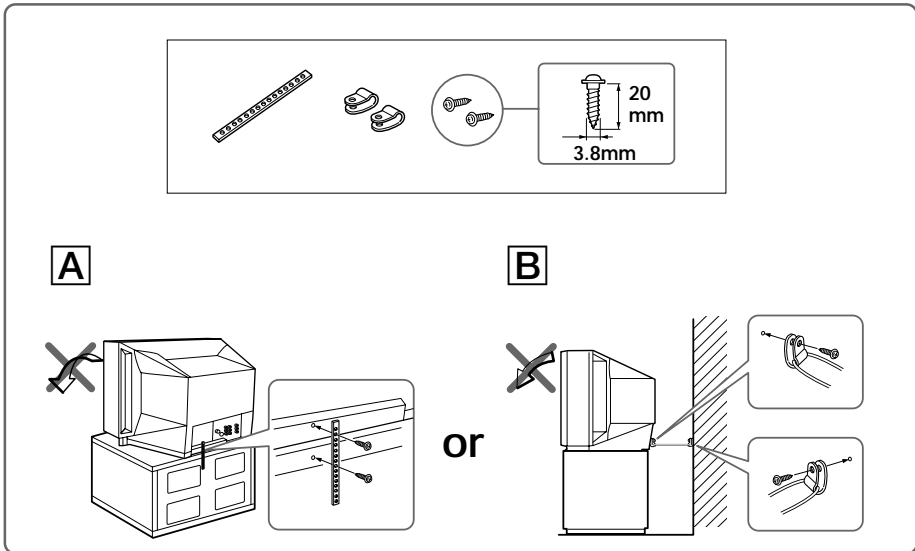



Note

- Use only the supplied screws. Use of other screws may damage the TV.

Watching the TV

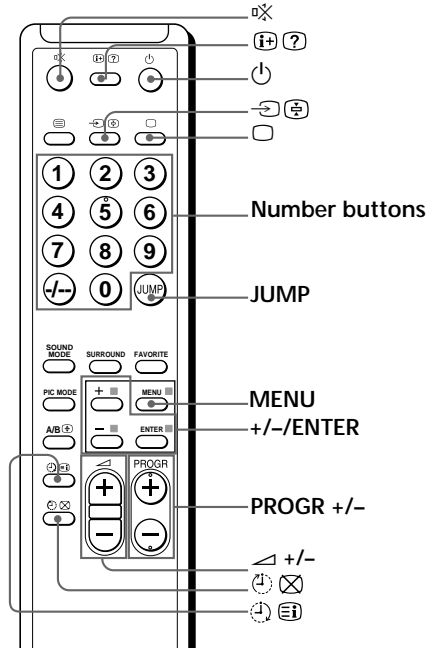
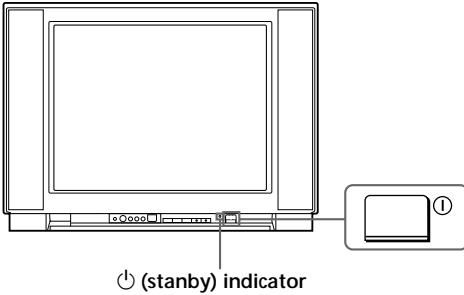
This section explains functions used while watching TV. Most operations can be done using the remote.



- 1 Press ① to turn on the TV.
When the TV is in standby mode (the  indicator on the TV is lit red), press  on the remote.



- 2 Press PROGR +/- or number buttons to select the TV program.
For double digit numbers, press -/-, then the number (e.g., for 25, press -/-, then 2 and 5).

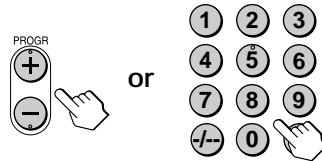

- 3 Press  +/- to adjust the volume.



Additional tasks

To	Press
Turn off temporarily	. The indicator on the TV lights up red.
Turn off completely	on the TV.
Mute the sound	.
Watch the video input (VCR, camcorder, etc.)	(or on the TV) to select "VIDEO 1", "VIDEO 2" and "VIDEO 3." To return to the TV program, press .
Jump back to the previous channel	JUMP.
Display the on-screen information*	.

* The picture, sound, and either the program number or video mode are displayed. The on-screen display for the picture and sound information disappears after about 3 seconds.

Changing the menu language

You can change the menu language as well as the on-screen language.

For details on how to use the menu, see "How to use the menu" on page 15.

1 Press MENU.

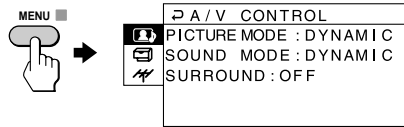

2 Press + or - to select the SET UP icon (), then press ENTER.

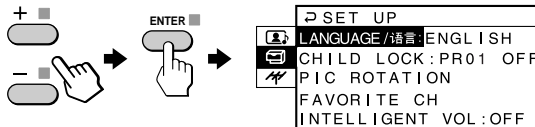

3 Make sure LANGUAGE/语言 is selected (highlighted), then press ENTER.

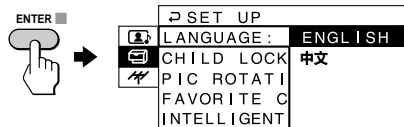

4 Press + or - to select 中文, then press ENTER.

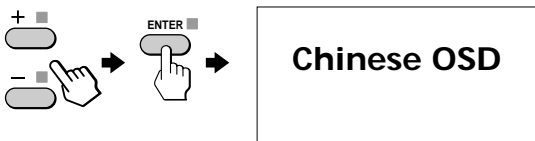

The menu language changes to Chinese.

To return to the normal screen

Press MENU.

continued

Watching the TV (continued)

Setting the Wake Up timer

- 1 Press until the desired period of time appears.

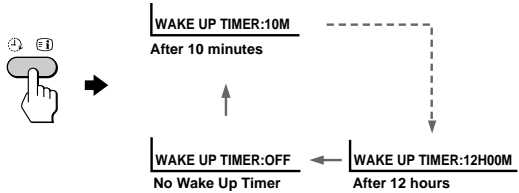

- 2 Select the TV program or video mode you want to wake up to.

- 3 Press or set the Sleep timer if you want the TV to turn off automatically.
The indicator on the TV lights up orange.

To cancel the Wake Up timer

Press until “WAKE UP TIMER: OFF” appears, or turn off the TV’s main power.

Notes

- The Wake Up timer starts immediately after the on-screen display disappears.
- If no buttons or controls are pressed for more than two hours after the TV is turned on using the Wake Up timer, the TV automatically goes into standby mode. To resume watching the TV, press any button or control on the TV or the remote.

Setting the Sleep timer

Press until the desired period of time appears.

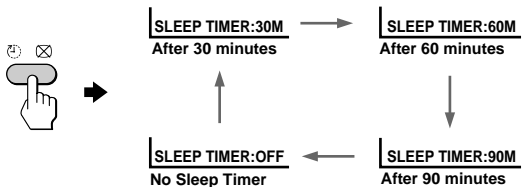

To cancel the Sleep timer

Press until “SLEEP TIMER: OFF” appears, or turn the TV off.

Selecting the picture and sound modes

You can select picture and sound modes and adjust the setting to your preference in PERSONAL option.

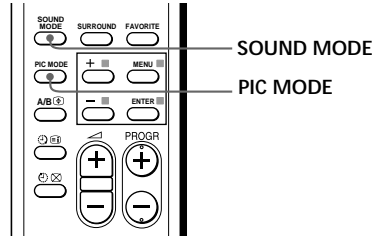

Selecting the picture mode

Press PIC MODE repeatedly until you get the desired picture mode.

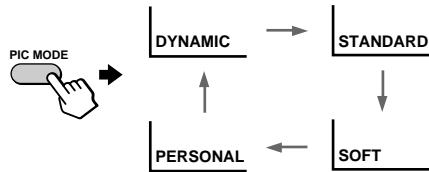

Select	To
DYNAMIC	receive high contrast pictures.
STANDARD	receive normal contrast pictures.
SOFT	receive mild contrast pictures.
PERSONAL	receive the last adjusted picture setting from the ADJUST option in the A/V CONTROL menu (see page 17).

Selecting the sound mode

Press SOUND MODE repeatedly until you get the desired sound mode.

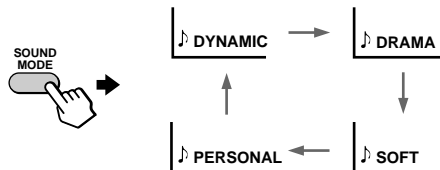

Select	To
DYNAMIC	listen to dynamic and clear sound that emphasizes the low and high tones.
DRAMA	listen to sound that emphasizes voice and high tones.
SOFT	receive soft sound.
PERSONAL	receive the last adjusted sound setting from the ADJUST option in the A/V CONTROL menu (see page 17).

Tip

- You can also set the picture and sound modes using the menu (see "Changing the A/V CONTROL setting" on page 16).

Viewing your favorite channels

— FAVORITE CHANNEL

You can display and select six of your favorite channels directly from your TV screen.

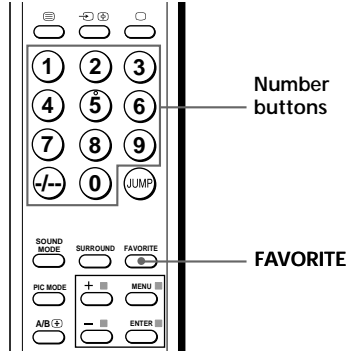

1 Press FAVORITE.

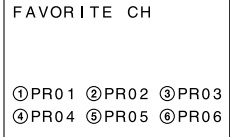

2 Press one of the number buttons to select the desired channel.

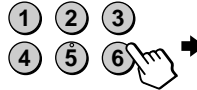

Tip

- To program your favorite channels, see "Programming your favorite channels" on page 18.

Listening with surround sound

The surround feature enables you to enjoy the sound effects of a concert hall or movie theater.

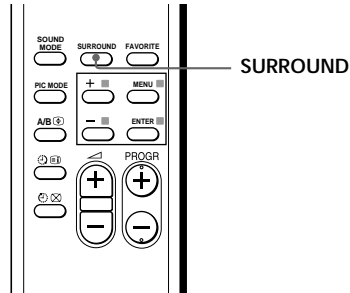

Press SURROUND repeatedly until you receive the desired surround sound.

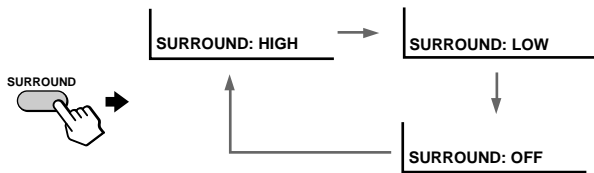

Select	To
HIGH	listen to the sound that spreads out over a large area, giving the feeling of being at a concert hall.
LOW	listen to the sound that gives the feeling of being at a live concert.
OFF	turn off the surround sound.



The surround of your TV is categorized as TruSurround.

“TruSurround™ is a trademark of SRS Labs, Inc. SRS and the SRS symbol are registered trademarks of SRS Labs, Inc. in the United States and selected foreign countries. SRS and TruSurround are incorporated under license from SRS Labs, Inc. and are protected under United States Patent Nos. 4,748,669 and 4,841,572 with numerous additional issued and pending foreign patents.”

Introducing the menu system

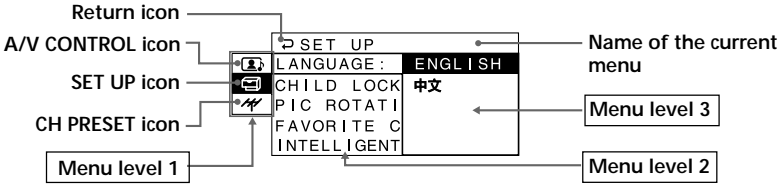
The MENU button lets you open a menu and change the settings of your TV. Here's an overview of the menu system.



Level 1	Level 2	Level 3/Function
	PICTURE MODE	Select the picture mode. DYNAMIC → STANDARD → SOFT → PERSONAL → ADJUST
	ADJUST	Adjust the PERSONAL option. PICTURE → COLOR → BRIGHT → HUE → SHARP
	SOUND MODE	Select the sound mode. DYNAMIC → DRAMA → SOFT → PERSONAL → ADJUST
	ADJUST	Adjust the PERSONAL option. BASS → TREBLE → BALANCE → BBE*
	SURROUND	Select the surround mode. HIGH → LOW → OFF
	LANGUAGE 语言	Change the menu language. ENGLISH ↔ 中文 (Chinese)
	CHILD LOCK	Lock out specific channels.
	PIC ROTATION	Adjust the picture position.
	FAVORITE CH	Program favorite channels.
	INTELLIGENT VOL	Adjust the volume automatically.
	AUTO PROGRAM	Preset channels automatically.
	MANUAL PROGRAM	Preset channels manually.
	SKIP	Skip unwanted or unused program numbers.
	TV SYS	Select the TV system. B/G → I → D/K → M
	COL SYS	Select the color system. AUTO → PAL → SECAM → NTSC3.58 → NTSC4.43

* The BBE is manufactured by Sony Corporation under license from BBE Sound, Inc. It is covered by U.S. Patent No. 4,638,258 and No. 4,482,866. The word "BBE" and the BBE symbol are the trademarks of BBE Sound, Inc.

How to use the menu

You can use the buttons on the remote and on the TV as well to display the menu and adjust the settings.

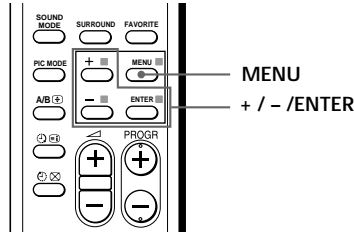

- 1 Press MENU to display the menu.

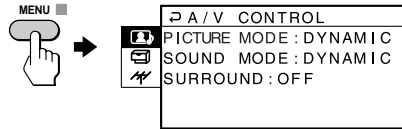

- 2 Press + or - to select the desired item.

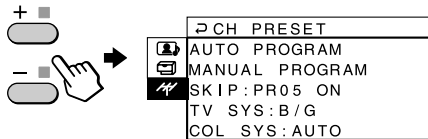

- 3 Press ENTER to confirm your option and go to the next menu level.



Other menu operations

To	Press
Adjust the setting value	+ / -
Return to the previous menu level*	ENTER
Cancel the menu	MENU

* To return from Menu Level 2 to Level 1, press +/- to select the return icon (↶), then press ENTER.

Tips

- If more than 60 seconds elapse between entries, the menu screen disappears.
- You can also use the buttons on the TV for menu operations. \triangleleft +/- work as +/- on the remote and \rightarrow works as ENTER on the remote.

Front of TV

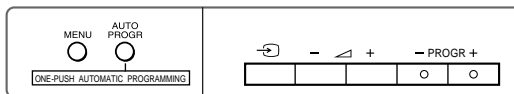

Changing the A/V CONTROL setting

The A/V CONTROL menu allows you to change the picture and sound settings.

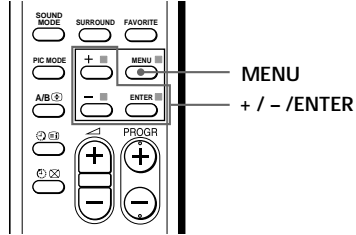

1 Press MENU.

2 Make sure the A/V CONTROL icon () is selected, then press ENTER.

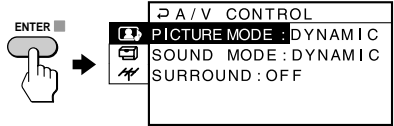

3 Press + or - to select either PICTURE MODE, SOUND MODE, or SURROUND, then press ENTER.

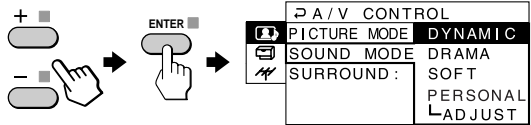

4 Press + or - to select the desired option, then press ENTER.

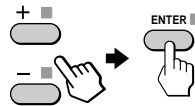

For	Select
PICTURE MODE	either DYNAMIC, STANDARD, SOFTPERSONAL*, or ADJUST
SOUND MODE	either DYNAMIC, DRAMA, SOFTPERSONAL*, or ADJUST
SURROUND	either HIGH, LOW, or OFF.

* When the PERSONAL mode is selected, the last adjusted picture and sound settings from the ADJUST option are received (see next page).

Tip

- For details on the options under “PICTURE MODE”, “SOUND MODE” and “SURROUND”, see pages 11 and 13 respectively.

To return to the normal screen

Press MENU.

Adjusting the ADJUST options under PICTURE MODE

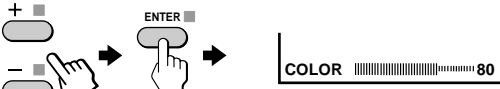
- 1** Press + or – to select the desired item (e.g., COLOR), then press ENTER.
- 

- 2** Adjust the value according to the following table, then press ENTER.

For	Press – to	Press + to
PICTURE	decrease picture contrast	increase picture contrast
COLOR	decrease color intensity	increase color intensity
BRIGHT	darken the picture	brighten the picture
HUE*	increase red picture tones	increase green picture tones
SHARP	soften the picture	sharpen the picture

* You can adjust HUE for the NTSC color system only.

- 3** Repeat the above steps to adjust other items.
The adjusted settings will be received when you select PERSONAL.

Adjusting the ADJUST options under SOUND MODE

- 1** Press + or – to select the desired item (e.g., BALANCE), then press ENTER.
- 

- 2** Adjust the value according to the following table, then press ENTER.

For	Press – to	Press + to
BASS	decrease the bass	increase the bass
TREBLE	decrease the treble	increase the treble
BALANCE	increase the left speaker's volume	increase the right speaker's volume
BBE	select "HIGH" for higher enhancement of sound clarity; select "LOW" for lower enhancement of sound clarity; select "OFF" to turn off the BBE sound	

- 3** Repeat the above steps to adjust other items.
The adjusted settings will be received when you select PERSONAL.

Tip

- For details on the menu system and how to use the menu, refer to "Introducing the menu system" on page 14 and "How to use the menu" on page 15.

Changing the SET UP setting

The SET UP menu allows you to change the menu language, lock channels, adjust the picture position, program your favorite channels and adjust volume automatically.

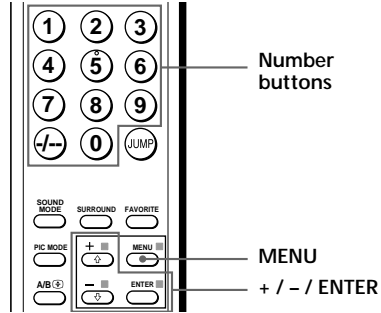

Programming your favorite channels

The FAVORITE CH feature enables you to program up to six channels for direct selection.

1 Press MENU.

2 Press + or - to select the SET UP icon (⊞), then press ENTER.

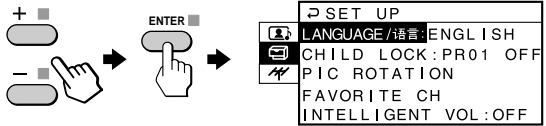

3 Press + or - to select FAVORITE CH, then press ENTER twice.

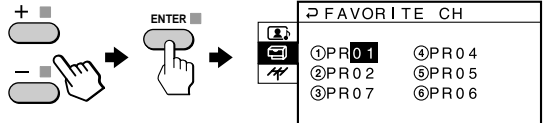

4 Press + or -, or number buttons to program the desired channel (e.g., PR03), then press ENTER.

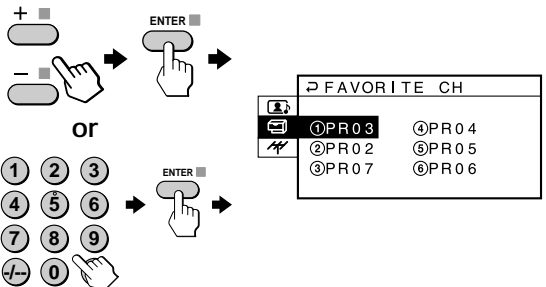

5 To continue programming other favorite channels, press + or - and then press ENTER. After that, repeat step 4.

To return to the normal screen

Press MENU.

Using the CHILD LOCK feature

You can prevent your children from watching certain programs by using the CHILD LOCK feature.

1 Press MENU.

2 Press + or - to select the SET UP icon (⚙️), then press ENTER.

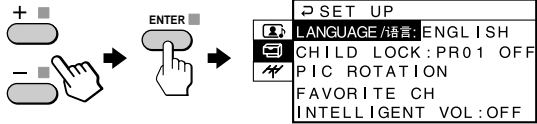

3 Press + or - to select CHILD LOCK, then press ENTER.

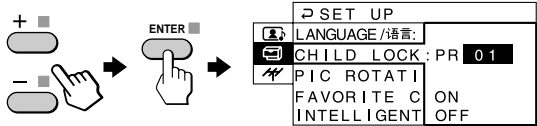

4 Press + or -, or number buttons to select the desired channel, then press ENTER.

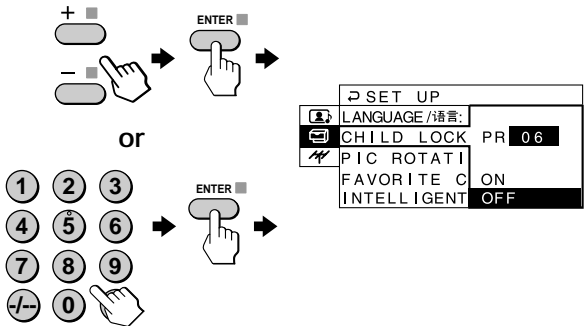

5 Press + or - to select ON, then press ENTER.

The lock symbol (🔒) appears on the screen.

To unlock the channel, select OFF.

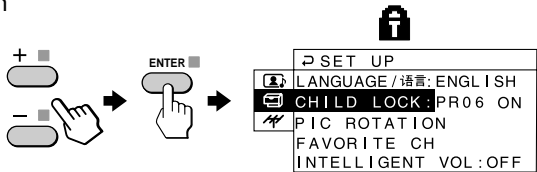

6 To lock other channels, press ENTER, then repeat steps 4 and 5.

To return to the normal screen

Press MENU.

continued

Changing the SET UP setting (continued)

Changing other SET UP menu options

1 Press MENU.

2 Press + or – to select the SET UP icon (☰), then press ENTER.

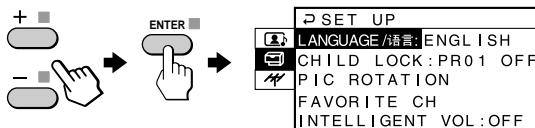

3 Press + or – to select the desired option (e.g., INTELLIGENT VOL), then press ENTER.

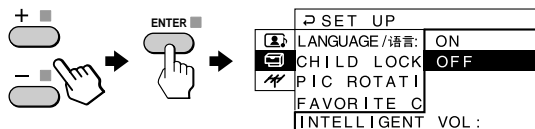

Select	To
LANGUAGE 語言	Change the menu language (see “Changing the menu language” on page 9).
CHILD LOCK	Prevent children from watching certain programs (see “Using the CHILD LOCK feature” on page 19).
PIC ROTATION	Adjust the picture position when it is not aligned to the TV screen. Press + or – to adjust the picture position, then press ENTER.
FAVORITE CH	Program channels for direct selection (see “Programming your favorite channels” on page 18).
INTELLIGENT VOL	Adjust the volume of each TV program automatically. Press + or – to select “ON,” then press ENTER. To turn off the Intelligent Volume function, select “OFF,” then press ENTER.



To return to the normal screen.

Press MENU.

Tip

- For details on the menu system and how to use the menu, refer to “Introducing the menu system” on page 14 and “How to use the menu” on page 15.

Changing the Channel Preset (CH PRESET) setting

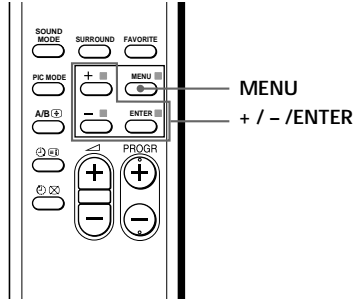

The CH PRESET menu allows you to adjust the setup of your TV. For example, you can receive a channel with a weak signal that fails to be tuned in by automatic presetting.

Presetting channels manually

1 Press MENU.

2 Press + or - to select the CH PRESET icon (⚡), then press ENTER.

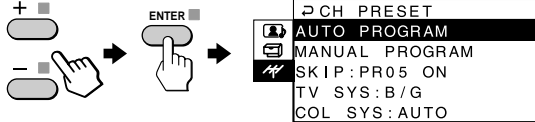

3 Press + or - to select MANUAL PROGRAM, then press ENTER.

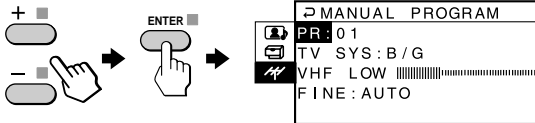

4 Select the program number to which you want to preset a channel.

(1) Make sure "PR" is selected, then press ENTER.

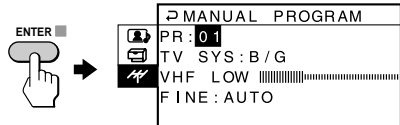

(2) Press + or - until the program number you want to preset (e.g., program number 10) appears on the menu, then press ENTER.

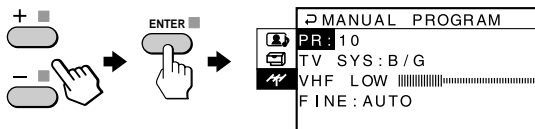

continued

Changing the Channel Preset (CH PRESET) setting (continued)

5 Select the desired channel.

- (1) Press + or - to select either VHF LOW, VHF HIGH or UHF, then press ENTER.

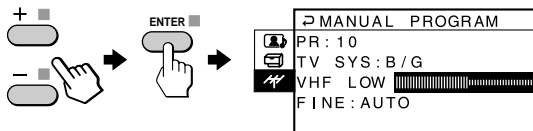

- (2) Press + or - until the desired channel's broadcast appears on the TV screen, then press ENTER.

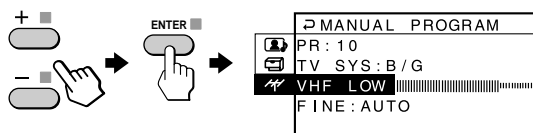

6 If the sound of the desired channel is abnormal, select the appropriate TV system.

- (1) Press + or - to select TV SYS, then press ENTER.

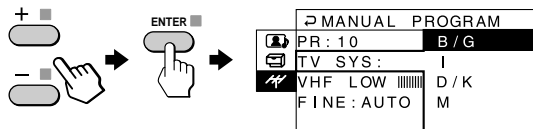

- (2) Press + or - until the sound becomes normal (e.g., M), then press ENTER.

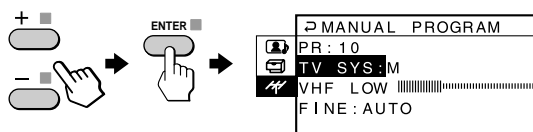

7 If you are not satisfied with the picture and sound quality, you may be able to improve them by using the FINE tuning feature.

(1) Press + or - to select FINE, then press ENTER.

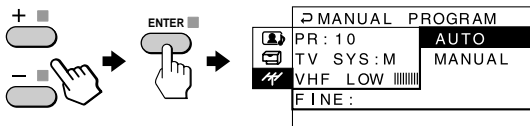

(2) Press + or - to select MANUAL, then press ENTER.

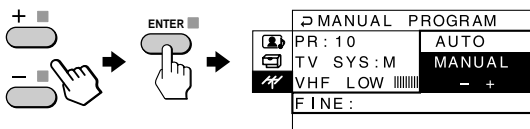

(3) Press + or - until the picture and sound quality are optimal, then press ENTER.

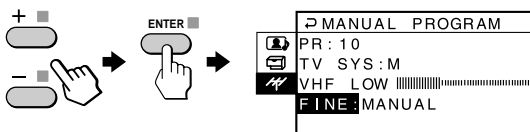

To return to the normal screen

Press MENU.

Note

- The TV system (TV SYS) and the fine tuning (FINE) settings are memorized for each program number.

continued

Changing the Channel Preset (CH PRESET) setting (continued)

Changing other CH PRESET menu options

1 Press MENU.

2 Press + or – to select the CH PRESET icon (📺), then press ENTER.

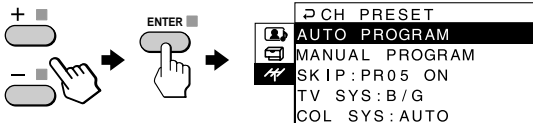

3 Press + or – to select the desired option (e.g., SKIP), then press ENTER.

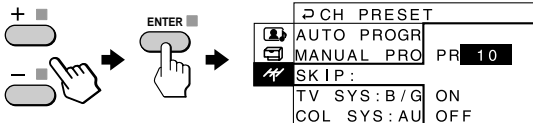

Select	To
AUTO PROGRAM	preset channels automatically .
MANUAL PROGRAM	preset channels manually . See “Pr resetting channels manually” on page 21.
SKIP	skip unwanted or unused program numbers. 1 Press + or – until the unused or unwanted program number appears, then press ENTER. 2 Press + or – to select “ON,” then press ENTER. To restore the skipped program number, select “OFF.”
TV SYS	select the TV system. See “Pr resetting channels manually” on page 22.
COL SYS	select the color system. Nor mally, set this to “AUTO.”

Tip







- For details on the menu system and how to use the menu, r efer to “Introducing the menu system” on page 14 and “How to use the menu” on page 15.

Note

- If you preset a locked channel, that par ticular channel will be unlocked.







Troubleshooting



If you have any problem while viewing your TV, please check the following troubleshooting guide. If the problem persists, contact your Sony dealer.

Symptom	Solutions	Possible cause
Snowy picture 	<ul style="list-style-type: none"> • Check the antenna cable and connection on the TV, VCR and at the wall. (page 4) 	<ul style="list-style-type: none"> • The connection is loose or the cable is damaged.
Noisy sound 	<ul style="list-style-type: none"> • Display the CH PRESET menu and select "MANUAL PROGRAM" to preset the channel again. (page 21) • Check the antenna type (VHF/UHF). Contact a Sony dealer for advice. • Adjust the antenna direction. Contact a Sony dealer for advice. • Try using a booster. 	<ul style="list-style-type: none"> • The channel presetting is inappropriate or incomplete. • The antenna type is inappropriate. • The antenna direction needs adjustment. • Signal transmission is low.
Distorted picture 	<ul style="list-style-type: none"> • Turn off or disconnect the booster if it is in use. 	<ul style="list-style-type: none"> • Broadcast signals are too strong.
Noisy sound 	<ul style="list-style-type: none"> • If the sound of all the channels is noisy, display the CH PRESET menu and check the TV system (TV SYS) setting (page 22), then select "AUTO PROGRAM" to preset the channels again. (page 24) • If the sound of some channels is noisy, select the channel, then display the CH PRESET menu and select the appropriate TV system (TV SYS). (page 22) 	<ul style="list-style-type: none"> • The TV system setting or channel presetting is inappropriate or incomplete.
Good picture 	<ul style="list-style-type: none"> • If the sound of all the channels is noisy, display the CH PRESET menu and check the TV system (TV SYS) setting (page 22), then select "AUTO PROGRAM" to preset the channels again. (page 24) • If the sound of some channels is noisy, select the channel, then display the CH PRESET menu and select the appropriate TV system (TV SYS). (page 22) 	<ul style="list-style-type: none"> • The TV system setting or channel presetting is inappropriate or incomplete.
No picture 	<ul style="list-style-type: none"> • Check the power cord, antenna and the VCR connections. • Press ⏻(power). • Press ⏻(main power) on the TV to turn off the TV about five seconds, then turn it on again. 	<ul style="list-style-type: none"> • The power cord, antenna or VCR is not connected. • The TV is not turned on.
No sound 	<ul style="list-style-type: none"> • Check the power cord, antenna and the VCR connections. • Press ⏻(power). • Press ⏻(main power) on the TV to turn off the TV about five seconds, then turn it on again. 	<ul style="list-style-type: none"> • The power cord, antenna or VCR is not connected. • The TV is not turned on.

continued

Troubleshooting (continued)

Symptom	Solutions	Possible cause
<p>Good picture</p> 	<ul style="list-style-type: none"> Press \triangle + to increase the volume level. 	<ul style="list-style-type: none"> The volume level is too low.
<p>No sound</p> 	<ul style="list-style-type: none"> Press \square to cancel the muting. 	<ul style="list-style-type: none"> The sound is muted.
<p>Dotted lines or stripes</p> 	<ul style="list-style-type: none"> Do not use a hair dryer or other equipment near the TV. Adjust the antenna direction for minimum interference. Contact a Sony dealer for advice. 	<ul style="list-style-type: none"> There is local interference from cars, neon signs, hair dryers, power generators, etc.
<p>Double images or "ghosts"</p> 	<ul style="list-style-type: none"> Use a highly directional antenna. Use the FINE tuning feature. (page 23) 	<ul style="list-style-type: none"> Broadcast signals are reflected by nearby mountains or buildings.
<p>No color</p> 	<ul style="list-style-type: none"> Adjust the antenna direction. Contact a Sony dealer for advice. 	<ul style="list-style-type: none"> The antenna direction needs adjustment.
	<ul style="list-style-type: none"> Turn off or disconnect the booster if it is in use. 	<ul style="list-style-type: none"> Use of a booster is inappropriate.
	<ul style="list-style-type: none"> Display the A/V CONTROL menu and select "ADJUST" in PICTURE MODE, then adjust the COLOR level. (pages 16 and 17) 	<ul style="list-style-type: none"> The color level setting is too low.
<p>No color</p> 	<ul style="list-style-type: none"> Display the CH PRESET menu and check the color system (COL SYS) setting (usually set this to AUTO). (page 24) 	<ul style="list-style-type: none"> The color system setting is inappropriate.
	<ul style="list-style-type: none"> Adjust the antenna direction. Contact a Sony dealer for advice. 	<ul style="list-style-type: none"> The antenna direction needs adjustment.
	<ul style="list-style-type: none"> Display the A/V CONTROL menu and select "ADJUST" in PICTURE MODE, then adjust the COLOR level. (pages 16 and 17) 	<ul style="list-style-type: none"> The color level setting is too low.
<p>Abnormal color patches</p> 	<ul style="list-style-type: none"> Keep external speakers or other electrical equipment away from the TV. Do not move the TV while the TV is turned on. Press $\textcircled{1}$ (main power) on the TV to turn off the TV for about five minutes, then turn it on again. 	<ul style="list-style-type: none"> There are magnetic effects from external speakers or other electrical equipment that may affect the TV. The direction of the earth's magnetic field may affect the TV.

Symptom	Solutions	Possible cause
Picture slant 	<ul style="list-style-type: none"> • Display the SET UP menu and adjust "PIC ROTATION" so that the picture is aligned to the TV screen. (page 20) 	<ul style="list-style-type: none"> • Terrestrial magnetism is affecting your TV set.
Lines moving across the TV screen.	<ul style="list-style-type: none"> • Use the FINE tuning feature. (page 23) 	<ul style="list-style-type: none"> • There is interference from external sources (e.g., heavy machinery or a nearby broadcast station, etc.).
The  indicator on your TV flashes red once or more in intervals of 3 seconds.	<ul style="list-style-type: none"> • Contact your nearest Sony service center. (page 28) 	<ul style="list-style-type: none"> • Your TV may need service.
TV cabinet creaks.	—	<ul style="list-style-type: none"> • Changes in room temperature sometimes make the TV cabinet expand or contract, causing a noise. This does not indicate a malfunction.
A small "boom" sound is heard when the TV is turned on.	—	<ul style="list-style-type: none"> • The TV's demagnetizing function is working. This does not indicate a malfunction.

Self-diagnosis function

Your TV is equipped with a self-diagnosis function. If there is a problem with your TV, the ⏻ (standby) indicator flashes red. The number of times the ⏻ indicator flashes indicates the possible causes.

Front of TV

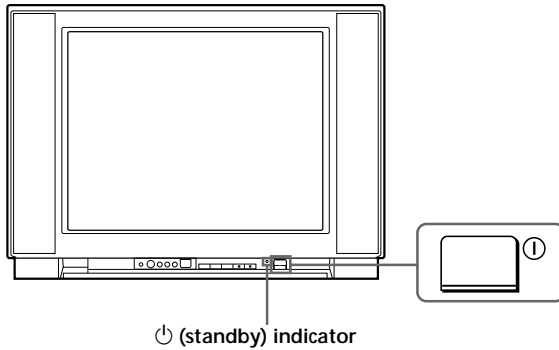

-
- 1** Check that the ⏻ indicator flashes red once or more in intervals of 3 seconds.

 - 2** Count the number of times the ⏻ indicator flashes.

 - 3** Press ⏻ (main power) to turn off your TV.

 - 4** Inform your nearest Sony service center about the number of times the ⏻ indicator flashed.
Be sure to note the model name and serial number located on the rear of your TV.
-

Identifying parts and controls

Refer to the pages indicated in parentheses () for details.

Front panel

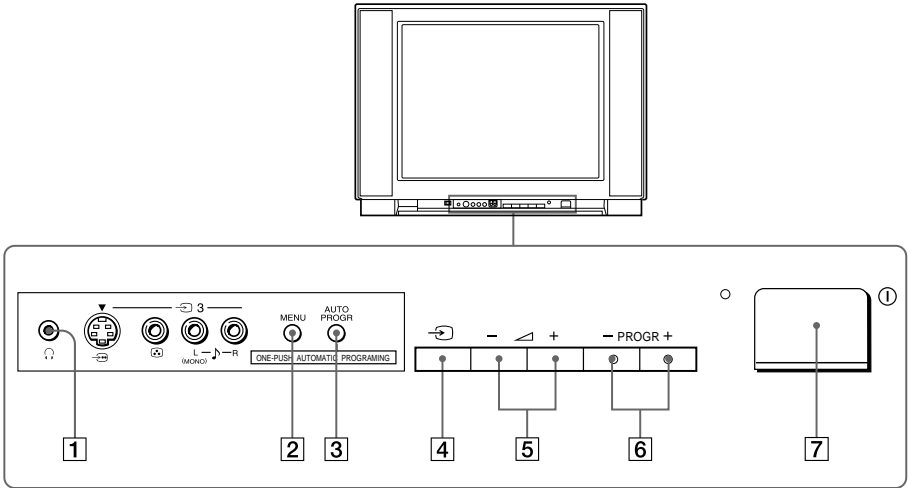

- 1 (headphones) jack
- 2 MENU button (15)
- 3 AUTO PROGR (program) button (5)
- 4 TV/video button (9)
- 5 +/- (volume) buttons (8)
- 6 PROGR +/- (program) buttons (8)
- 7 (main power) button (8)

continued

Identifying parts and controls (continued)

Remote Control

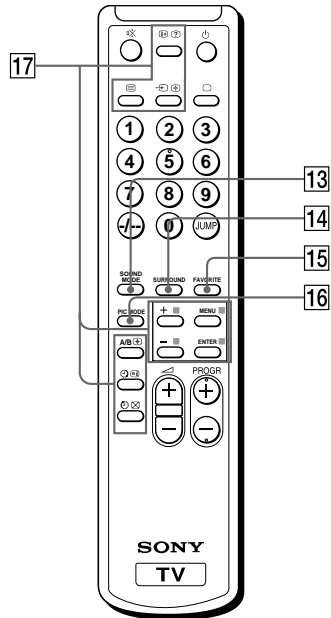
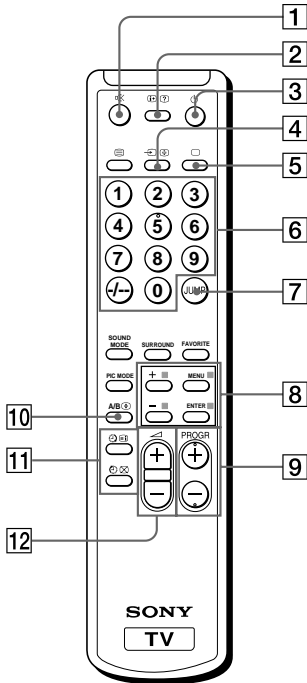

- 1** (muting) button (9)
- 2** (display) button (9)
- 3** (power) button (8)
- 4** (video) button (9)
- 5** (TV) button (9)
- 6** Number buttons (8)
- 7** JUMP button (9)
- 8** Menu operation buttons (15)
MENU button
+ or - buttons
ENTER button
- 9** PROGR +/- button (8)
- 10** A/B button
Not available on this model.
- 11** Timer setting buttons (10)
 (wake up timer)
 (sleep timer)
- 12** (volume) +/- buttons (8)

- 13** SOUND MODE button (11)
- 14** SURROUND button (13)
- 15** FAVORITE button (12)
- 16** PIC MODE button (11)
- 17** Teletext operation buttons
Not available on this model.
 (text) (enlarge)
 (reveal) (hold)
 (index) (text clear)
 (FASTEXT: red, green, yellow, blue)

Names/symbols of buttons on the remote are indicated in different colors to represent the available functions.

Label color	Button function
White	For general TV operations
Green	For Teletext operations

Specifications

	KV-XF25M80	KV-XF29M80
Power requirements	110-240 V AC, 50/60 Hz	
Power consumption (W)	Indicated on the rear of the TV	
Television system	B/G, I, D/K, M	
Color system	PAL, PAL 60, SECAM, NTSC4.43, NTSC3.58	
Channel coverage		
B/G	VHF : E2 to E12 UHF : E21 to E69 CATV : S01 to S03, S1 to S41	
I	UHF : B21 to B68 CATV : S01 to S03, S1 to S41	
D/K	VHF : C1 to C12, R1 to R12 UHF : C13 to C57, R21 to R60 CATV : S01 to S03, S1 to S41, Z1 to Z39	
M	VHF : A2 to A13 UHF : A14 to A79 CATV : A-8 to A-2, A to W+4, W+6 to W+84	
⌚ (Antenna)	75-ohm external terminal	
Audio output	6W + 6W	8W + 8W
Number of terminal		
📺 (Video)	Input: 3 Output: 1 – Phono jacks; 1 Vp-p, 75 ohms	
🎵 (Audio)	Input: 3 Output: 1 –Phono jacks; 500 mVrms	
📺 (S Video)	Input: 2 Y: 1 Vp-p, 75 ohms, unbalanced, sync negative C: 0.286 Vp-p, 75 ohms	
🎧 (Headphones)	Output: 1 Minijack	
Picture tube	25 in.	29 in.
Tube size (cm) – Measured diagonally	64	72
Screen size (cm) – Measured diagonally	60	68
Dimensions (w/h/d, mm)	722 × 515 × 512	794 × 573 × 517
Mass (kg)	38	50

Design and specifications are subject to change without notice.

Sony  line

<http://www.world.sony.com/>

Printed on recycled paper

Sony Corporation Tokyo, Japan