

SONY®

4-088-416-42 (1)



100 Hz WIDE Projection TV

Instruction Manual

GB

KP-44PX2U

NOTICE FOR CUSTOMERS IN THE UNITED KINGDOM

A moulded plug complying with BS1363 is fitted to this equipment for your safety and convenience.

Should the fuse in the plug supplied need to be replaced, a 5 AMP fuse approved by ASTA or BSI to BS 1362 (i.e. marked with ⚡ or ⚡) must be used.

When an alternative type of plug is used it should be fitted with a 5 AMP FUSE, otherwise the circuit should be protected by a 5 AMP FUSE at the distribution board.

If the plug supplied with this equipment has a detachable fuse cover, be sure to attach the fuse cover after you change the fuse. Never use the plug without the fuse cover. If you should lose the fuse cover, please contact your nearest Sony service station.

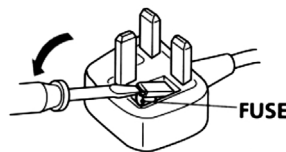

How to replace the fuse

Open the fuse compartment with a blade screwdriver, and replace the fuse.

• **IMPORTANT**

If the plug supplied is not suitable for the socket outlets in your home, it should be cut off and an appropriate plug fitted in accordance with the following instructions:

The wires in this mains lead are coloured in accordance with the following code:

Blue Neutral

Brown Live

As the colours of the wires in the mains lead of this apparatus may not correspond with the coloured markings identifying the terminals in your plug, proceed as follows:

The wire which is coloured blue must be connected to the terminal which is marked with the letter N or coloured black. The wire which is coloured brown must be connected to the terminal which is marked with the letter L or coloured red. Do not connect either wire to the earth terminal in the plug which is marked by the letter E or by the safety earth symbol \perp or coloured green or green and yellow.

WARNING

- To prevent the risk of electric shock, do not insert the plug cut off from the mains lead into a socket outlet. This plug cannot be used and should be destroyed.
- To prevent the risk of fire or electric shock, do not expose the unit to rain or moisture.
- Dangerously high voltages are present inside the set. Do not open the cabinet. Refer servicing to qualified personnel only.

Introduction

Thank you for choosing this Sony 100 Hz Projection TV.

Before operating the projection TV, please read this manual thoroughly and retain it for future reference.









- Symbols used in the manual:
 -  Important information.
 -  Information on a feature.
 - 1,2... Sequence of instructions.
 -  Shaded buttons on the remote control show you the buttons you have to press to follow the sequence of the instructions.
 -  Informs you of the result of the instructions.

Table of Contents

Notice for Customers in the United Kingdom	2
Introduction.....	3
Safety Information.....	4
Overview	
Overview of Remote Control Buttons	5
Overview of TV Buttons	6
Installation	
Connecting the Aerial and VCR	7
Inserting Batteries into the Remote Control	7
First Time Operation	
Switching On the TV and Automatically Tuning	8
Adjusting Colour Registration (Convergence).....	10
Menu system	
Introducing and Using the Menu System.....	10
On Screen Display Menus Guide	11
Menu Guide:	
Picture Adjustment.....	12
Sound Adjustment	12
Sleep Timer	13
Auto Format.....	13
AV3 Output.....	13
PIP Input.....	14
PIP Position.....	14
Language	14
Auto Tuning.....	14
Programme Sorting.....	15
Programme Labels	15
AV Preset.....	15
Manual Programme Preset	16
RGB Centring.....	17
Teletext	18
NexTVView	19
Additional Information	
Connecting Optional Equipment	20
Using Optional Equipment	21
SmartLink	22
Remote Control Configuration for VCR/DVD.....	23
Optimum Viewing Area	24
Specifications.....	25
Troubleshooting.....	26
Television Channel Guide for United Kingdom	27

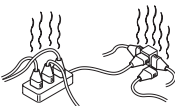
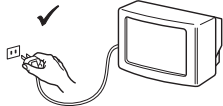
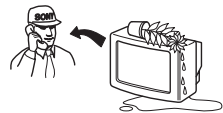
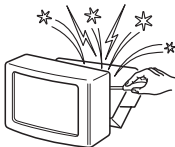
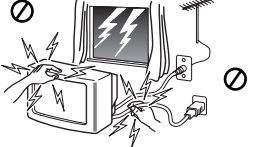
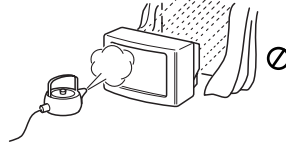
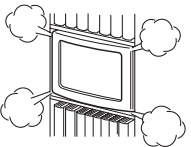
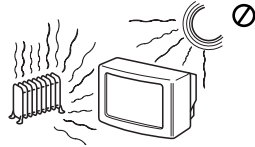
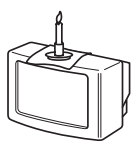
Safety Information

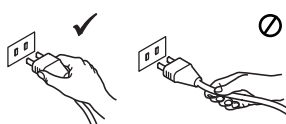
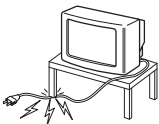
 <p>This set is to operate on a 220-240V AC supply only. Take care not to connect too many appliances to the same power socket as this could result in fire or electric shock.</p>	 <p>For environmental and safety reasons, it is recommended that the TV set is not left in standby mode when not in use. Disconnect from the mains.</p>	 <p>Never push objects of any kind into the set as this could result in a fire or electric shock. Never spill liquid of any kind on the set. If any liquid or solid object does fall into the cabinet, do not operate the TV. Have it checked immediately by qualified personnel.</p>
 <p>Do not open the cabinet and the rear cover of the TV. Refer to qualified service personnel only.</p>	 <p>For your own safety, do not touch any part of the TV, power lead or aerial lead during lightning storms.</p>	 <p>To prevent fire or shock hazard, do not expose the TV to rain or moisture.</p>
 <p>Do not cover the ventilation openings of the TV. For ventilation, leave a space of at least 10cm all around the set.</p>	 <p>Never place the TV in hot, humid or excessively dusty places. Do not install the TV where it may be exposed to mechanical vibrations.</p>	 <p>To prevent fire, keep inflammable objects or naked lights (eg candles) away from the TV.</p>
 <p>Clean the screen and cabinet with a soft, lightly dampened cloth. Do not use any type of abrasive pad, alkaline cleaner, scouring powder or solvent, such as alcohol or benzene, or antistatic spray. As a safety precaution, unplug the TV before cleaning it.</p>	 <p>Pull out the power lead by the plug. Do not pull on the power lead itself.</p>	 <p>Take care not to place heavy objects on the power lead as this could result in damage. We recommend you wind any excess lead around the holders provided on the rear of the TV.</p>
 <p>Place the TV on a secure stable stand. Do not allow children to climb on to it. Do not place the TV on its side or face up.</p>	 <p>Unplug the power lead before moving the TV. Avoid uneven surfaces, quick steps or excessive force. If the set has been dropped or damaged, have it checked immediately by qualified service personnel.</p>	 <p>Do not cover the ventilation openings of the TV with items such as curtains or newspapers etc.</p>

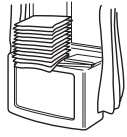
Additional Safety Information

-  After transporting the projection TV directly from a cold to a warm location, or if the room temperature has changed suddenly, pictures may be blurred or show poor colour over portions of the picture. This is because moisture has condensed on the mirrors or lenses inside the projection TV. Let the moisture evaporate before using the projection TV.
- To obtain a clear picture, do not expose the screen to direct illumination or direct sunlight. If possible, use spot lighting directed down from the ceiling.
- Displaying a still picture for long periods of time, for instance, when operating a video game or personal computer and viewing a programme in 16:9 mode, may damage the picture tube. To avoid this, keep the picture contrast level low.
- Avoid touching the screen, and take care not to scratch the surface with hard objects.
- Screen Burn / Image Retention**
An "image ghosting", or "screen burn" may appear on the screen if the television is left operating with, either a still image, or a programme displaying a bright corner channel logo, for an extended period of time. The risk of this is higher if the set is in "Live" mode or has a high contrast setting. This image cannot be removed once burnt onto the screen. To avoid the risk of occurrence do not leave the television operating on such a picture, or programme for long periods of time. Repeated extended daily usage of the same image, or programme can also result in this occurrence which is not covered by the Sony warranty.

Overview of Remote Control Buttons

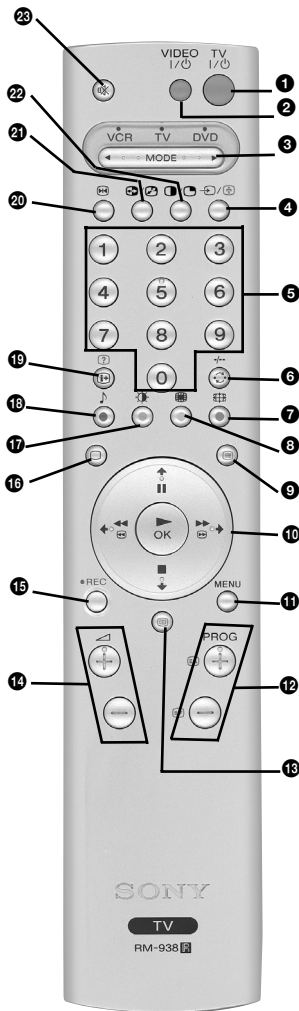

1 To Temporarily Switch Off TV:

Press this button to temporarily switch off TV (the standby indicator ⏻ on the TV lights up). Press again to switch on TV from standby mode.

To save energy we recommend switching off completely when TV is not in use.

⚠ After 15 minutes without a signal and without any button being pressed, the TV switches automatically into standby mode.

2 VCR or DVD on/off:

3 Media Selector:

With this remote control you can operate not only this TV but also the main functions of your VCR or DVD. Switch on the device you want to operate and next press this button repeatedly to select the VCR, TV or DVD. A green light will be momentarily lit to indicate the chosen function.

⚠ Before the first time you want to control a DVD or VCR by using this remote control, you have to set it up depending on the brand of the device to be used. For more details, refer to the chapter "Remote Control Configuration for VCR or DVD" on page 23.

4 Selecting input source:

5 Selecting channels:

If Media Selector is switched to TV or VCR, press this button to select channels. For double-digit programme numbers, enter the second digit within 2.5 seconds.

6 a) If Media Selector is switched to TV:

Press this button to watch the last channel selected (the last channel watched for at least 5 seconds).

b) If Media Selector is switched to VCR:

For Sony's VCR double-digit programme numbers, e.g. 23, press -/- first and then the buttons 2 and 3.

7 Selecting screen format:

Press this button repeatedly to change the format of the screen. For more details refer to the chapter "Auto Format" on page 13.

8 This button only works in Teletext mode.

9 Selecting Teletext:

10 Joystick:

a) If Media Selector is switched to TV:

- When MENU is switched on, use these buttons to operate the menu system. For details refer to "Introducing and Using the Menu System" on page 10.
- When MENU is switched off, press OK to show a channel overview. Then press \blacktriangledown or \blacktriangleup to select the channel and then press again the OK button to watch the selected channel.

b) If Media Selector is switched to VCR or DVD:

Using these buttons you can control the main functions of your VCR or DVD.

11 Displaying the menu system:

Press this button to display the menu on the TV screen. Press again to remove the menu display from the TV screen.

12 Selecting channels:

Press these buttons to select the next or previous broadcast channel.

13 NexTVView:

For more details refer to chapter "NexTVView" on page 19.

14 Adjusting TV volume:

Press these buttons to adjust the volume of the TV.

15 Recording button:

If Media Selector is switched to VCR, press this button to record programmes.

16 Selecting TV mode:

Press this button to switch off PIP, teletext or video input.

17 Selecting Picture mode:

Press this button repeatedly to change the picture mode.

18 Selecting Sound effect:

Press this button repeatedly to change the sound effect.

19 Displaying on Screen information:

Press this button to display all on-screen indications. Press again to cancel.

20 Freezing the picture:

Press this button to freeze the picture. The screen is divided into two screens. On the left with the normal picture, on the right the picture is frozen. Press this button again to return to the normal picture.

21 Swapping screens:

Whilst you are in "PIP" mode, press this button to swap the two screens.

22 PIP (Picture in Picture):

Press this button to watch another source in a small picture (PIP) within the main TV picture. Press again to cancel. To select the source you want to watch, refer to the chapter "PIP Input" on page 14.

23 Muting the Sound:

Press this button to mute TV sound. Press again to restore the sound.

i Besides TV functions, all coloured buttons as well as green symbols are also used for Teletext operation. For more details, please refer to the chapter "Teletext" on page 18.

Overview of Projection TV Buttons

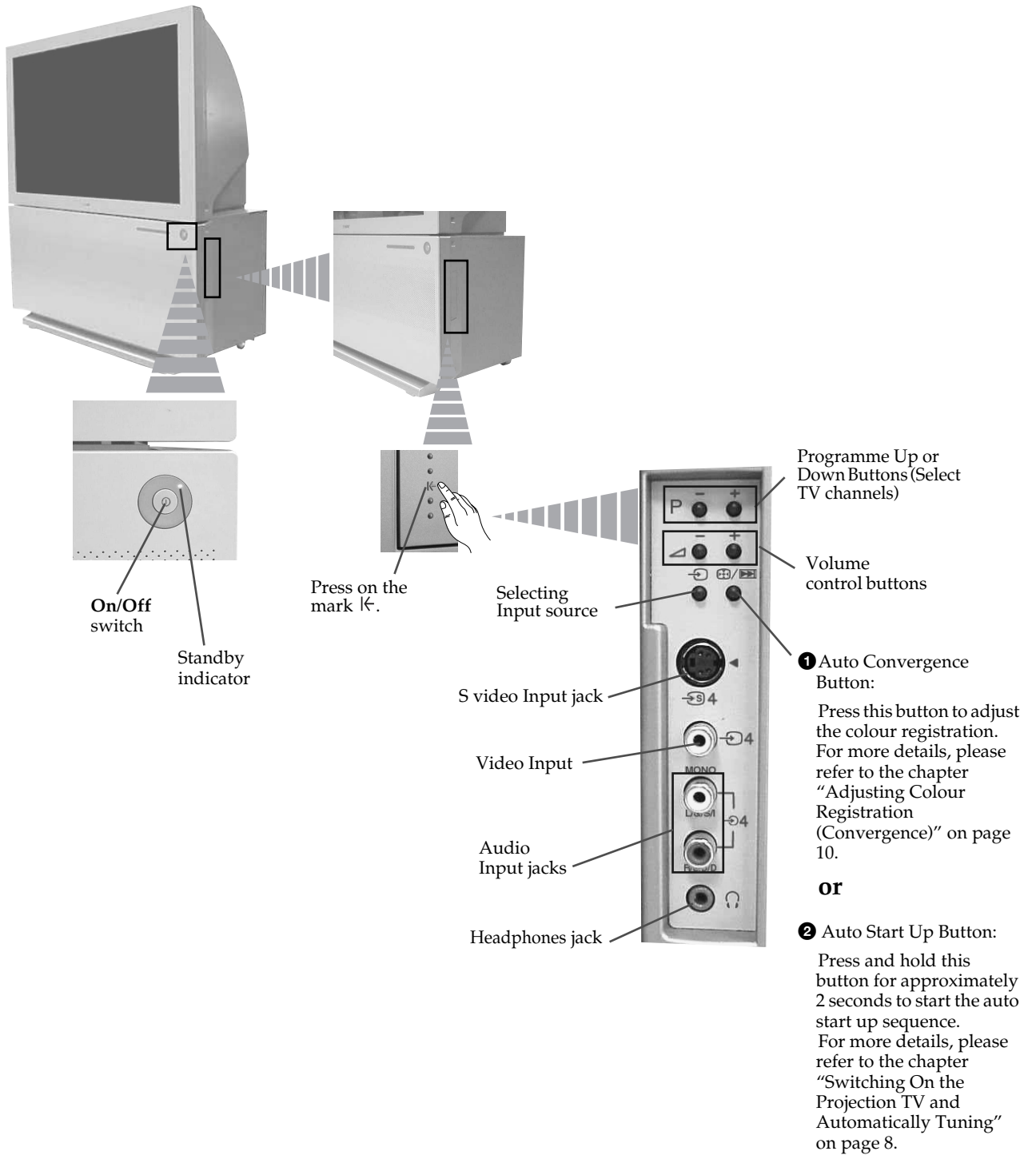

Connecting the Aerial and VCR

i Connecting cables are not supplied.

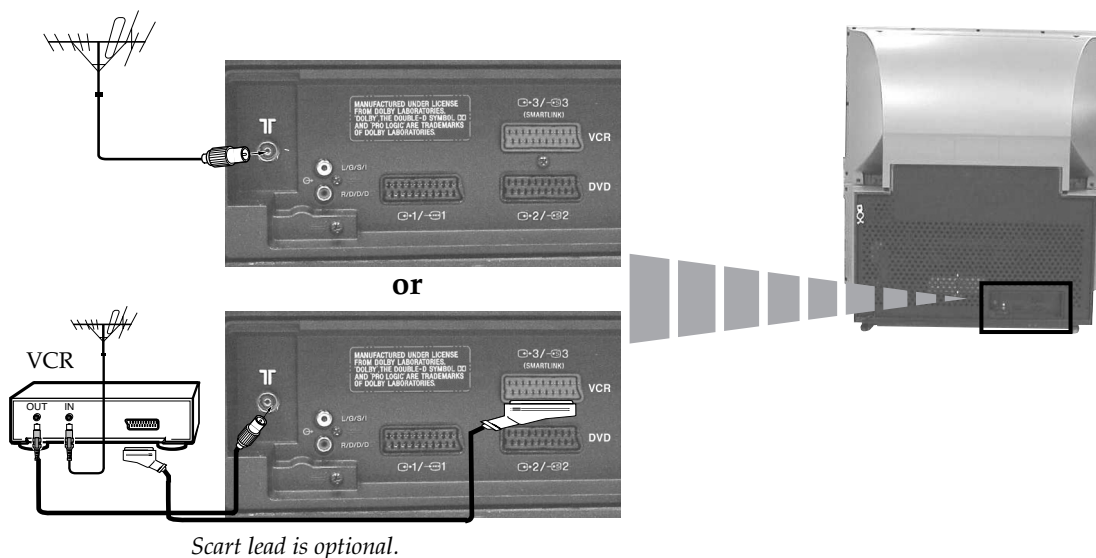

A For more details of VCR connection, please refer to the section "Additional information when connecting equipment" on page 21.

GB

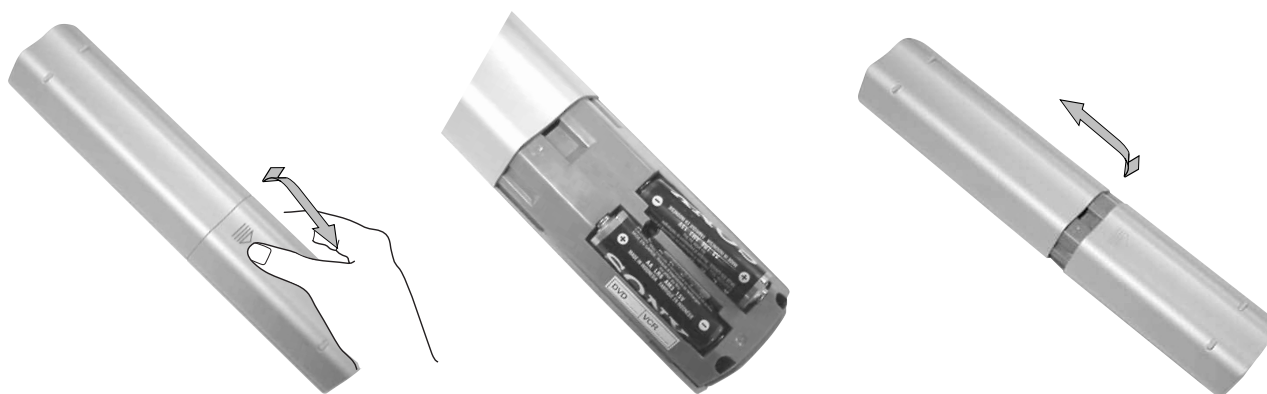

Inserting Batteries into the Remote Control

A Make sure you insert the supplied batteries using the correct polarities.
Always remember to dispose of used batteries in an environmental friendly way.





Switching On the Projection TV and Automatically Tuning

i The first time you switch on your TV, a sequence of menu screens appear on the TV enabling you to: 1) choose the language of the menu screen, 2) search and store all available channels (TV Broadcast) and 3) change the order in which the channels (TV Broadcast) appear on the screen.

However, if you need to change any of these settings at a later date, you can do that by selecting the appropriate option in the  (Set Up menu) or by pressing the Auto Start Up Button  on the TV set.

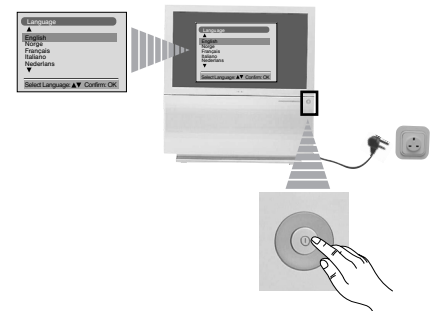
- 1 Connect the Projection TV plug to the mains socket (220-240V AC, 50Hz)
The first time that the TV set is connected, it is usually turned on. If the TV is off, press the  on/off button on the TV set to turn on the TV.
The first time you switch on the TV, a **Language** menu displays automatically on the TV screen.





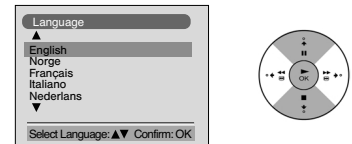

- 2 Press the  or  button on the remote control to select the language, then press the **OK** button to confirm your selection. From now on all the menus will appear in the selected language.

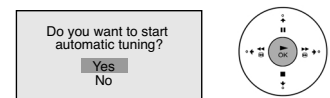

- 3 The Auto Tuning menu appears on the screen. Press the **OK** button to select **Yes**.



- 4 The projection TV starts to automatically search and store all available broadcast channels for you.

-  This procedure could take some minutes. Please be patient and do not press any buttons, otherwise automatic tuning will not be completed.
-  In some countries the TV Broadcaster installs the channels automatically (ACI system). In this case, the TV Broadcaster sends a menu in which you can select your city by pressing the  or  button and **OK** to store the channels.
-  If no channels were found during the auto tuning process then a new menu appears automatically on the screen asking you to connect the aerial. Please connect the aerial (see page 7) and press **OK**. The auto tuning process will start again.

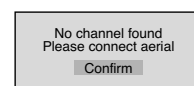
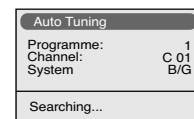





continued...

5 After all available channels are captured and stored, the **Programme Sorting** menu automatically appears on the screen enabling you to change the order in which the channels appear on the screen.

a) If you wish to keep the broadcast channels in the tuned order, go to step 6.

b) If you wish to store the channels in a different order:

- 1** Press the  or  button to select the programme number with the channel (TV Broadcast) you wish to rearrange, then press the  button.
- 2** Press the  or  button to select the new programme number position for your selected channel (TV Broadcast), then press **OK**.
- 3** Repeat steps b)1 and b)2 if you wish to change the order of the other channels.

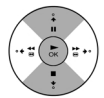
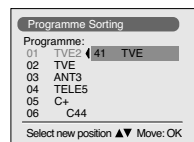
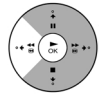
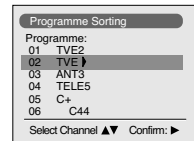

6 Press the **MENU** button to remove the menu from the screen.

MENU



GB

 *Your projection TV is now ready for use.*

Adjusting Colour Registration (Convergence)

- 1** Due to the earth's magnetism, the picture might become undefined and you could see different colours on the outlines of the images. In that case, proceed as follows.

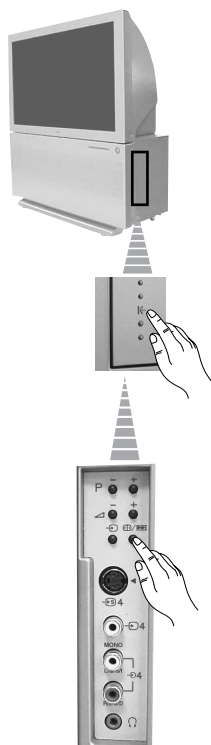

Auto converge the Red, Green, and Blue Lines

1 Press on the mark , on the right side of the projection TV.

2 Press  /  button.

 The Auto Convergence function works for about 10 seconds. When the white cross disappears from the screen, your projection TV is ready for use.

-  The Auto Convergence function does not work when:
- no signal is input.
 - the input signal is weak.
 - the screen is exposed to spotlights or direct sunlight.
 - you watch the teletext broadcast.
 - you watch NexTVView.

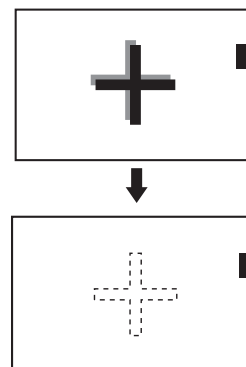







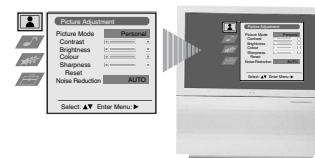

Introducing and Using the Menu system

- 1** Your projection TV uses an on-screen menu system to guide you through the operations. Use the following buttons on the Remote Control to operate the menu system:

1 Press the MENU button to switch the first level menu on.

MENU



- 2**
- To highlight the desired menu or option, press  or .
 - To enter the selected menu or option, press .
 - To return to the last menu or option, press .
 - To alter the settings of your selected option, press  /  /  or .
 - To confirm and store your selection, press OK.

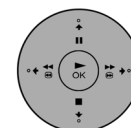

3 Press the MENU button to remove the menu from the screen.

MENU



On Screen display Menu Guide

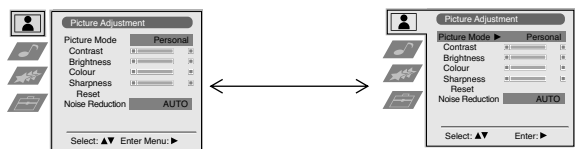

Refer to the section "Picture Adjustment", on page 12.

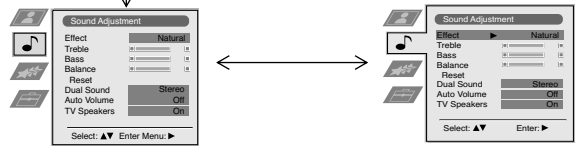

Refer to the section "Sound Adjustment", on page 12.

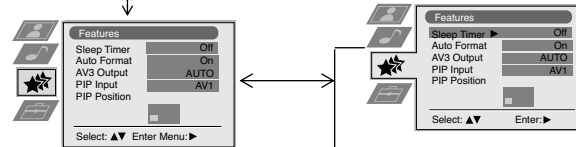

Refer to the section "Sleep Timer" on page 13.

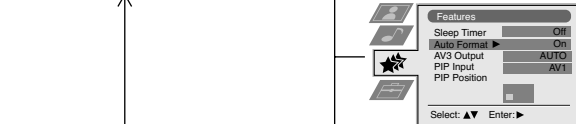

Refer to the section "Auto Format" on page 13.

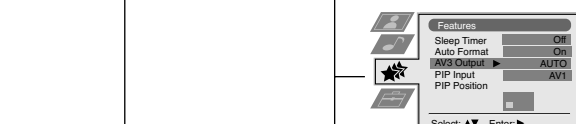

Refer to the section "AV3 Output" on page 13.

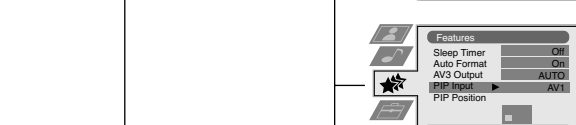

Refer to the section "PIP Input" on page 14.

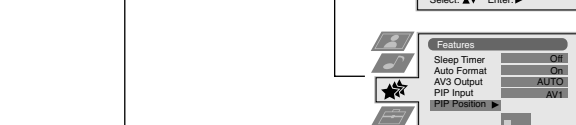

Refer to the section "PIP Position" on page 14.

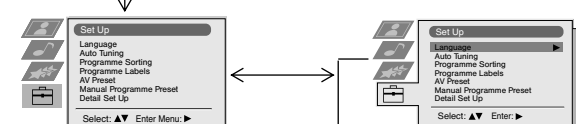

Refer to the section "Language" on page 14.

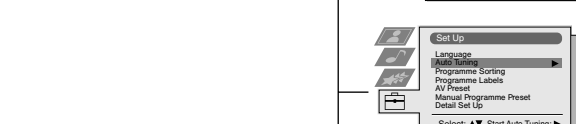

Refer to the section "Auto Tuning" on page 14.

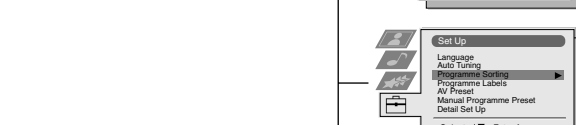

Refer to the section "Programme Sorting" on page 15.

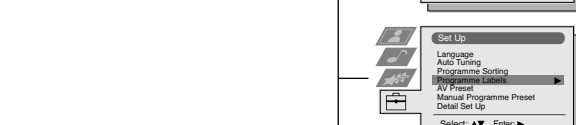

Refer to the section "Programme Labels" on page 15.

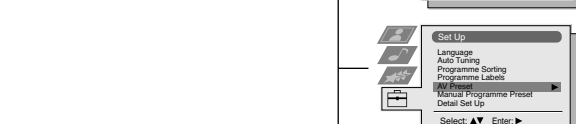

Refer to the section "AV Preset" on page 15.

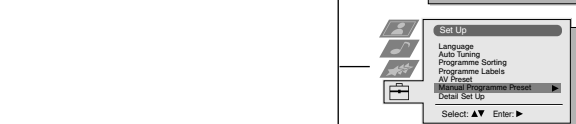

Refer to the section "Manual Programme Preset" on page 16.

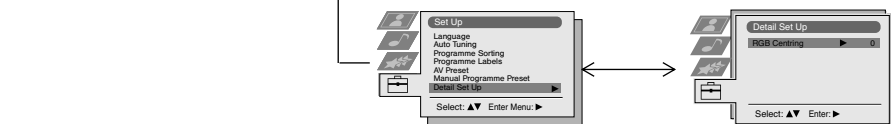

Refer to the section "RGB Centring" on page 17.

Menu Guide

Level 1

Level 2

Level 3 / Function

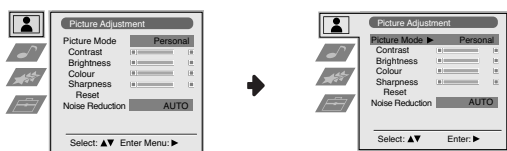

PICTURE ADJUSTMENT

The "Picture Adjustment" menu allows you to alter the picture adjustments.

To do this: after selecting the item you want to alter press **▶**, then press repeatedly **▼** / **▲** / **◀** or **▶** to adjust it and finally press **OK** to store the new adjustment.

- This menu also allows you to customise the picture mode based on the programme you are watching:
 - Picture Mode** **▶**
 - ▼ Live** (for live broadcast programmes, DVD and Digital Set Top Box receivers).
 - ▼ Personal** (for individual settings).
 - ▼ Movie** (for films).
- **Brightness, Colour and Sharpness** can only be altered if "Personal" mode is selected.
- **Hue** is only available for NTSC colour signal (e.g: USA video tapes).
- Select **Reset** and press **OK** to reset the picture to the factory preset levels.
- The **Noise Reduction** option is set to **AUTO** to automatically reduce the picture noise visible in the broadcast signal. To cancel this function, select "Off" instead of "AUTO".

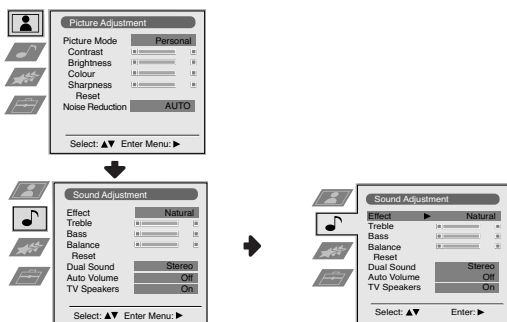

SOUND ADJUSTMENT

The "Sound Adjustment" menu allows you to alter the sound adjustments.

To do this: after selecting the item you want to alter, press **▶**. Then press repeatedly **▼** / **▲** / **◀** or **▶** to adjust it and finally press **OK** to store the new adjustment.

- Effect** **▶**
- ▼ Natural:** Enhances clarity, detail and presence of sound by using "BBE High Definition Sound system"*.
 - ▼ Dynamic:** "BBE High Definition Sound system"* intensifies clarity and presence of sound for better intelligibility and musical realism.
 - ▼ Dolby**V:** Dolby Virtual, simulates the sound effect of "Dolby Surround Pro Logic".
 - ▼ Off:** Flat response.

Treble **▶** **◀** Less **▶** More

Bass **▶** **◀** Less **▶** More

Balance **▶** **◀** Left **▶** Right

Reset **OK** Resets the sound to the factory preset levels.

- Dual Sound** **▶**
- For a stereo broadcast:
 - ▼ Mono.**
 - ▼ Stereo.**
 - For a bilingual broadcast:
 - ▼ Mono** (for mono channel if available).
 - ▼ A** (for channel 1).
 - ▼ B** (for channel 2).

- Auto Volume** **▶**
- ▼ Off:** volume level changes according to the broadcast signal.
 - ▼ On:** volume level of the channels will stay the same, independent of the broadcast signal (e.g. in the case of advertisements).

- TV Speakers** **▶**
- ▼ On:** to listen to the TV from the set speakers.
 - ▼ Off:** to listen to the TV from an external amplifier connected to the audio outputs on the rear of the projection TV set.

- If you are listening to the TV through headphones, the "Effect" option will automatically be switched to "Off".
 - If you select "Dolby Virtual" on the "Effect" option, the "Auto Volume" option will automatically be switched to "Off" and vice versa.
- ❗** * The "BBE High Definition Sound system" is manufactured by Sony Corporation under license from BBE Sound, Inc. It is covered by U.S. Patent No. 4,638,258 and No. 4,482,866. The word "BBE" and BBE Symbol are trademarks of BBE Sound, Inc.

** This TV has been designed to create the "Dolby Surround" sound effect by simulating the sound of four speakers with two speakers, when the broadcast audio signal is Dolby Surround encoded. The sound effect can also be improved by connecting a suitable external amplifier (for details refer to "Connecting to external audio Equipment" on page 21).

** Manufactured under license from Dolby Laboratories. "Dolby", "Pro Logic" and the double-D symbol **DD** are trademarks of Dolby Laboratories.

continued...

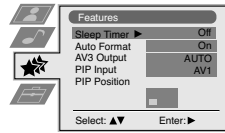
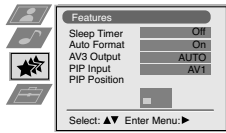
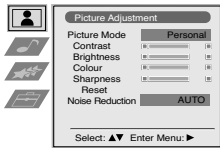

SLEEP TIMER

The "Sleep Timer" option in the "Features" menu allows you to select a time period for the TV to switch itself automatically into the standby mode.

To do this: after selecting the option press **➡**, then press **⬇** or **⬆** to set the time period delay (max. of 4 hours).

- While watching the TV, you can press the **⏸** button on the remote control to display the time remaining.
- One minute before the projection TV switches itself into standby mode, the time remaining is displayed on the TV screen automatically.

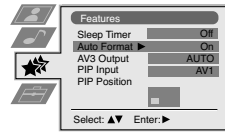
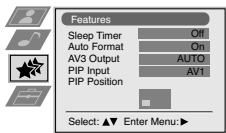
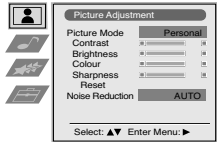

AUTO FORMAT

The "Auto Format" option in the "Features" menu allows you to automatically change the aspect ratio of the screen.

To do this: after selecting the option, press **➡**. Then press **⬇** or **⬆** to select **On** (if you wish the TV set to automatically switch the screen format according to the broadcast signal) or **Off** (if you wish to keep your preference). Finally press **OK** to store.

i Even if you have selected "On" or "Off" in the "Auto Format" option, you can always modify the format of the screen by pressing **⏸** repeatedly on the remote control to select one of the following formats:

- Smart:** Imitation of wide screen effect for 4:3 broadcast.
- 4:3:** Conventional 4:3 picture size, full picture information.
- 14:9:** Compromise between 4:3 and 16:9 picture size.
- Zoom:** Widescreen format for letterbox movies.
- Wide:** For 16:9 broadcast. Full picture information.

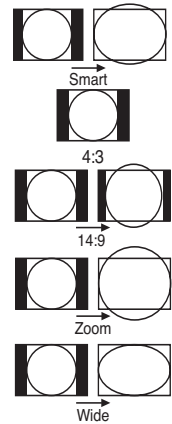

GB

i In "Smart", "Zoom" and "14:9" modes, parts of the top and bottom of the screen are cut off. Press **⬇** or **⬆** to adjust the position of the image on the screen (e.g. to read subtitles).

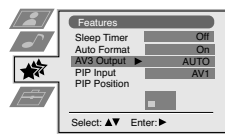
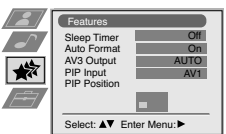
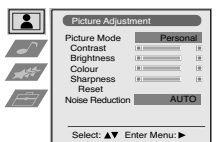

AV3 OUTPUT

The "AV3 Output" option in the "Features" menu allows you to select the source to be output from the Scart connector **Ⓜ3/Ⓜ3** so that you can record from this Scart any signal coming from the projection TV or from an external equipment connected to the Scart connectors **Ⓜ1/Ⓜ1** or **Ⓜ2/Ⓜ2** or side connectors **Ⓜ4** or **Ⓜ4** and **Ⓜ4**.

i If your VCR supports Smartlink, this procedure is not necessary.

To do this: after selecting the option, press **➡**. Then press **⬇** or **⬆** to select the desired output signal: **TV**, **AV1**, **AV2**, **AV4**, **YC4** or **AUTO**.

⚠ If you select "AUTO", the output signal will always be the same one that is displayed on the screen.

⚠ If you have connected a decoder to the Scart **Ⓜ3/Ⓜ3** or to a VCR connected to this Scart, please remember to change back the "AV3 Output" to "AUTO" or "TV" for correct unscrambling.

continued...

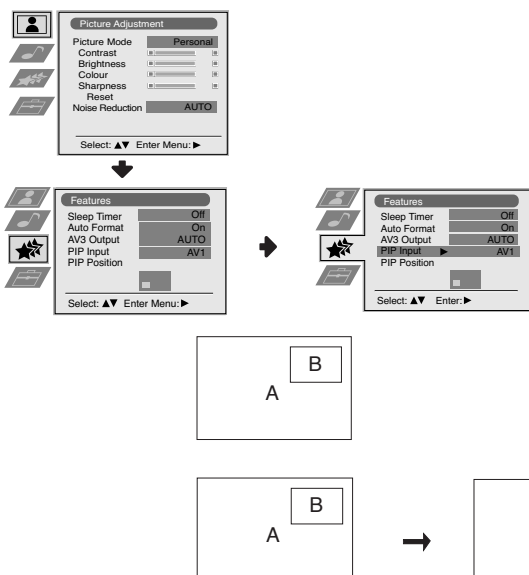

PIP INPUT

The “PIP Input” option in the “Features” menu allows you to select the source you want to watch in the “PIP” screen.

To do this: after selecting the option, press **➡**. Then press repeatedly **⬇** or **⬆** to select the desired source **AV1, AV2, AV3, AV4** or **TV**. Finally press **OK** to store.

i To watch the “PIP” screen with the selected source, press the **⏏** / **⏏** button on the remote control.

i You can swap the screens by pressing the **⏏** / **⏏** button on the remote control.

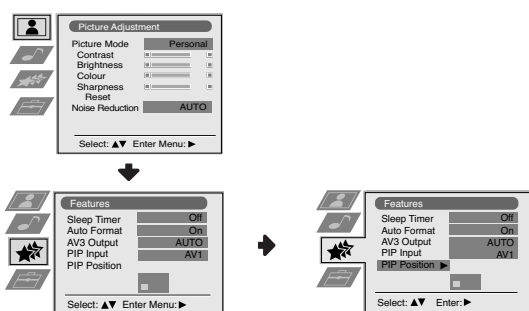

PIP POSITION

The “PIP Position” option in the “Features” menu allows you to change the position of the “PIP” screen within the main screen.

To do this: after selecting the option press **⬇**, **⬅**, **⬆** or **➡** to select the desired position. Finally press **OK** to store.

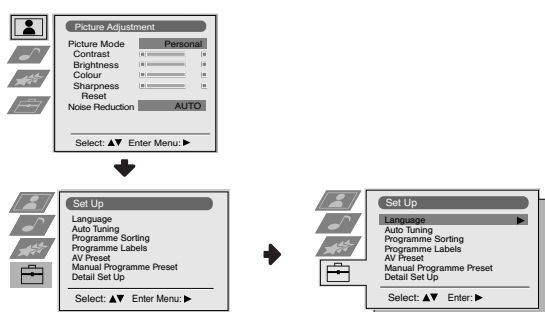

LANGUAGE

The “Language” option in the “Set Up” menu allows you to select the language that the menus are displayed in.

To do this: after selecting the option, press **➡** and then proceed in the same way as in step 2 of the section “Switching On the Projection TV and Automatically Tuning” on page 8.

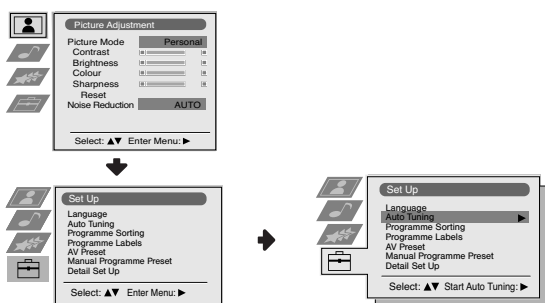

AUTO TUNING

The “Auto Tuning” option in the “Set Up” menu allows you to automatically search for and store all available TV channels.

To do this: after selecting the option, press **➡** and then proceed in the same way as in the steps 3 and 4 of the section “Switching On the Projection TV and Automatically Tuning” on page 8.

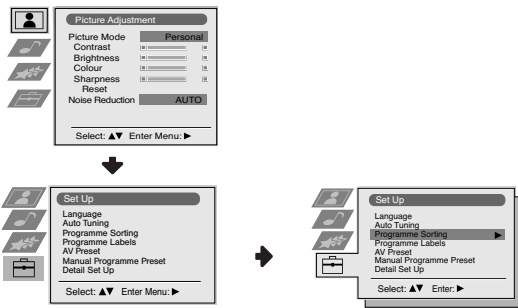

PROGRAMME SORTING

The "Programme Sorting" option in the "Set Up" menu allows you to change the order in which the channels (TV Broadcast) appear on the screen.

To do this: after selecting the option, press **▶** and then proceed in the same way as in step 5 b) of the section "Switching On the Projection TV and Automatically Tuning" on page 9.

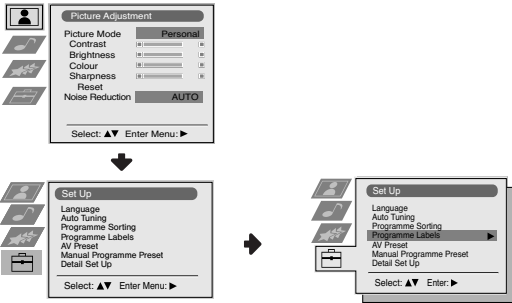

PROGRAMME LABELS

The "Programme Labels" option in the "Set Up" menu allows you to name a channel using up to five characters (letters or numbers).

To do this:

- 1 After selecting the option, press **▶**, then press **▼** or **▲** to select the programme number with the channel you wish to name.
- 2 Press **▶**. With the first element of the **Label** column highlighted, press **▼** or **▲** to select a letter or number (select "-" for a blank), then press **▶** to confirm this character. Select the other four characters in the same way. Finally press **OK** to store.

GB

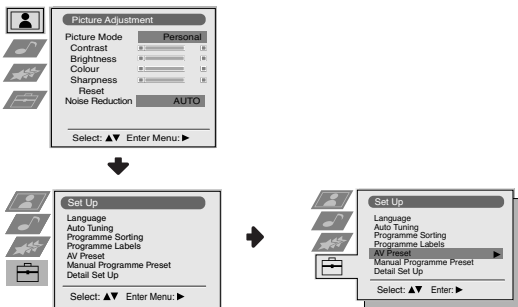

AV PRESET

The "AV Preset" option in the "Set Up" menu allows you to designate a name to the external equipment you have connected to the input sockets of this projection TV.

To do this:

- 1 After selecting the option, press **▶**, then press **▼** or **▲** to select the input source you wish to name (**AV1**, **AV2** and **AV3** are for the rear Scarts and **AV4** for side connectors). Then press **▶**.
- 2 A label automatically appears in the label column:
 - a) If you want to use one of the 6 predefined label (**CABLE**, **GAME**, **CAM**, **DVD**, **VIDEO** or **SAT**), press **▼** or **▲** to select the desired label and finally press **OK** to store.
 - b) If you want to set a different label, select **Edit** and press **▶**. Then with the first element highlighted, press **▼** or **▲** to select a letter, number or "-" for a blank, then press **▶** to confirm this character. Select the other four characters in the same way and finally press **OK** to store.

continued...

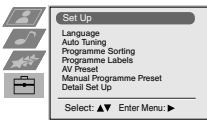
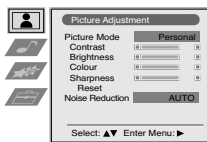

MANUAL PROGRAMME PRESET

The "Manual Programme Preset" option in the "Set Up" menu allows you to:

a) Preset channels or the VCR channel one by one to the programme order of your choice. To do this:

- 1 After selecting the "Manual Programme Preset" option, press **▶** then with **Programme** option highlighted press **▶**. Press **▼** or **▲** to select which programme number you want to preset the channel on (for VCR, select programme number "0"). Then press **◀**.
- 2 After selecting the **Channel** option, press **▶**. Then press the number buttons to enter directly the channel number of the TV Broadcast or the channel of the VCR signal. If you do not know the channel number, press **▼** or **▲** to search for it. When you tune the desired channel, press **OK** twice to store.

Repeat all the above steps to tune and store more channels.

b) Label a channel using up to five characters.

To do this: highlighting the **Programme** option, press the **PROG +/-** button to select the programme number with the channel you wish to name. When the programme you want to name appears on the screen, select the **Label** option and press **▶**. Next press **▼** or **▲** to select a letter, number or "-" for a blank. Press **▶** to confirm this character. Select the other four characters in the same way. After selecting all the characters, press **OK** twice to store.

c) Fine tune the broadcast reception. Normally the automatic fine tuning (AFT) will give the best possible picture, however you can manually fine tune the TV to obtain a better picture reception in case the picture is distorted.

To do this: while watching the channel (TV Broadcast) you wish to fine tune, select the **AFT** option and press **▶**. Next press **▼** or **▲** to adjust the fine tuning between -15 and +15. Finally press **OK** twice to store.

d) Skip any unwanted programme numbers when they are selected with the **PROG +/-** buttons.

To do this: highlighting the **Programme** option, press the **PROG +/-** button to select the programme number you want to skip. When the programme you want to skip appears on the screen, select the **Skip** option and press **▶**. Next press **▼** or **▲** to select **Yes**. Finally press **OK** twice to confirm and store.

To cancel this function afterwards, select "No" instead of "Yes" in the step above.

continued...

Level 1

Level 2

Level 3 / Function

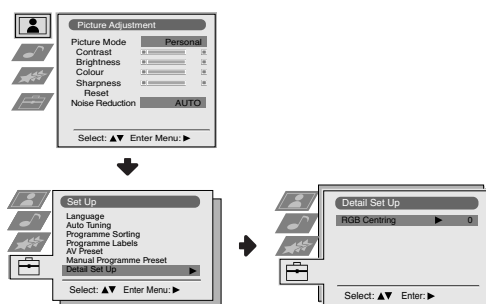

RGB CENTRING

When connecting an RGB source, such as a “PlayStation”, you may need to readjust the horizontal position of the picture. If this is the case, you can adjust it through the “RGB Centring” option in the “Detail Set Up”.

To do this: while watching an RGB source select the “RGB Centring” option and press **➡**. Then press **⬇** or **⬆** to adjust the centre of the picture between -10 and +10. Finally press **OK** to confirm and store.

Teletext

i Teletext is an information service transmitted by most TV stations. The index page of the teletext service (usually page 100) gives you information on how to use the service. To operate teletext, use the remote control buttons as indicated below.

- ⚠** • Teletext errors may occur if you use a channel (TV Broadcast) with a weak signal.
- After 5 minutes viewing the same teletext page and without any button being pressed, the brightness level of the picture automatically decreases notoriously to avoid any damage to the picture tube. Press any button of the remote control to reset the brightness level.



To switch on Teletext :

After selecting the TV channel which carries the teletext service you wish to view, press **⏏**.

To select a Teletext page:

Input 3 digits for the page number, using the numbered buttons.

- *If you make a mistake, retype the correct page number.*
- *If the counter on the screen continues searching, it is because the page is not available. If this is the case, input another page number*

To access the next or preceding page:

Press **PROG +** (**⏏**) or **PROG -** (**⏏**).

To superimpose teletext on to the TV:

Whilst you are viewing teletext, press **⏏**. Press it again to cancel teletext mode.

To freeze a teletext page:

Press **⏏** / **⏏**. Press it again to cancel the freeze.

To reveal concealed information (e.g: answer to a quiz):

Press **⏏** / **?**. Press it again to conceal the information.

To select a sub page:

A teletext page may consist of several sub pages. In this case the page number that appears on the upper left corner will change from white to green and one or more arrows will appear next to the page number. Repeatedly press the **⏏** or **⏏** buttons on the remote control to watch the desired sub page.

To Switch Off Teletext:

Press **⏏**.



Fasttext

i Fasttext service lets you access Teletext pages with one button push.

When you are in Teletext mode and Fasttext is broadcast, a colour coded menu appears at the bottom of the teletext page. Press the appropriate coloured button (red, green, yellow or blue) to access the page corresponding to your menu choice.

NexTVView*

*(depending on availability of service).

i NexTVView is an on-screen electronic programme guide, providing you with programme information for different broadcasters.

When looking for information you can search by theme (sports, art, etc...) or date.

A If wrong characters appear when viewing NexTVView, use the menu system to enter the "Language/Country" menu (see page 14) and select the same language as the NexTVView is broadcasted.

Displaying NexTVView

1 Select a broadcast channel providing a NexTVView service. In this case the indication "NexTVView" is displayed as soon as data is available.

2 To see NexTVView service you have two different types of NexTVView interface. These depend on the % of available data:

a) "Programme List" interface:

Whilst you are watching TV, and after the indication "NexTVView" (coloured white) is displayed on the screen, press the **□** button on the remote control to watch the "Programme List" interface (see fig. 1).

b) "Overview" interface:

Whilst you are watching TV, and after more than 50% of NexTVView data is available (100% data may not be available depending on the area) the indication "NexTVView" (coloured black) is displayed on the screen. Press the **□** button on the remote control to watch the "Overview" interface (see fig. 2).

i As soon as you enter the NexTVView service the % of NexTVView data available will be shown in the bottom left corner of the screen. Once you have entered the service, the % of data will not increase.

3 To navigate through NexTVView:

- moving to right or left press **▶** or **◀**.
- moving up or downwards, press **▼** or **▲**.
- confirming a selection, press **OK**.

4 To switch NexTVView off, press the **□** button on the remote control.

"Programme List" interface (fig. 1):

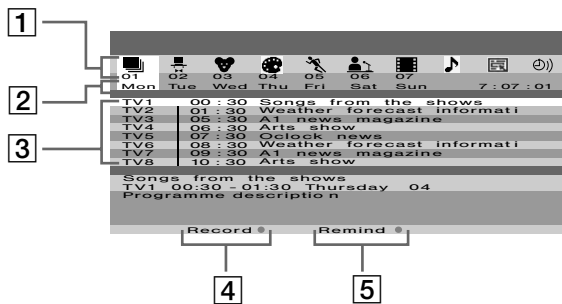

"Overview" interface (fig. 2):

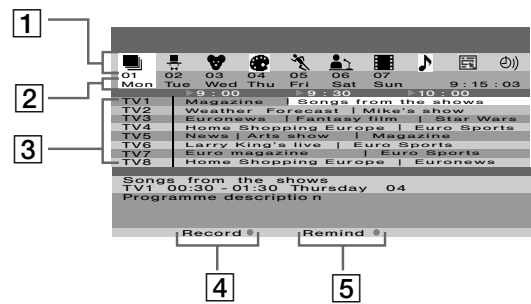

1 Icons for different themes (see the "Icons' key" below)

2 Date

3 Programme list

4 Record*

i This function only works if you have connected a VCR which supports SmartLink and Timer Programming feature.

If you wish to record the selected programme, press the red button on the remote control.

5 Remind*

If you wish to be reminded when the selected programme is broadcast, press the green button on the remote control. At the time that programme should be broadcast a reminder message is displayed on the TV.

A * "Record" and "Remind" options will be shown on the screen as soon as a programme have been selected, but they will not be shown if you are watching the NexTVView service on a TV channel which is not a NexTVView provider.

* "Record" and "Remind" will not be available if the programme that you have selected has already started.

Icons' key:

□ full selection list:
All the programme information is listed by time and broadcast channels order.

📺 entertainment

👶 children

🎨 arts

🏃 sports

📰 news

🎬 movies

🎵 music

📺 channel selection:

If the NexTVView provider sends information of more than 8 broadcast channels, you can select 8 of them to create your personal list.

After you have created your personal list, the default list can be restored. To restore it, select "Auto ▶" by pressing **▶** button on the remote control.

🕒 remind list:

Shows you the list with all the programmes (maximum 5 programmes) that you have selected to be reminded about.

Connecting Optional Equipment

i Using the following instructions, you can connect a wide range of optional equipment to your projection TV.

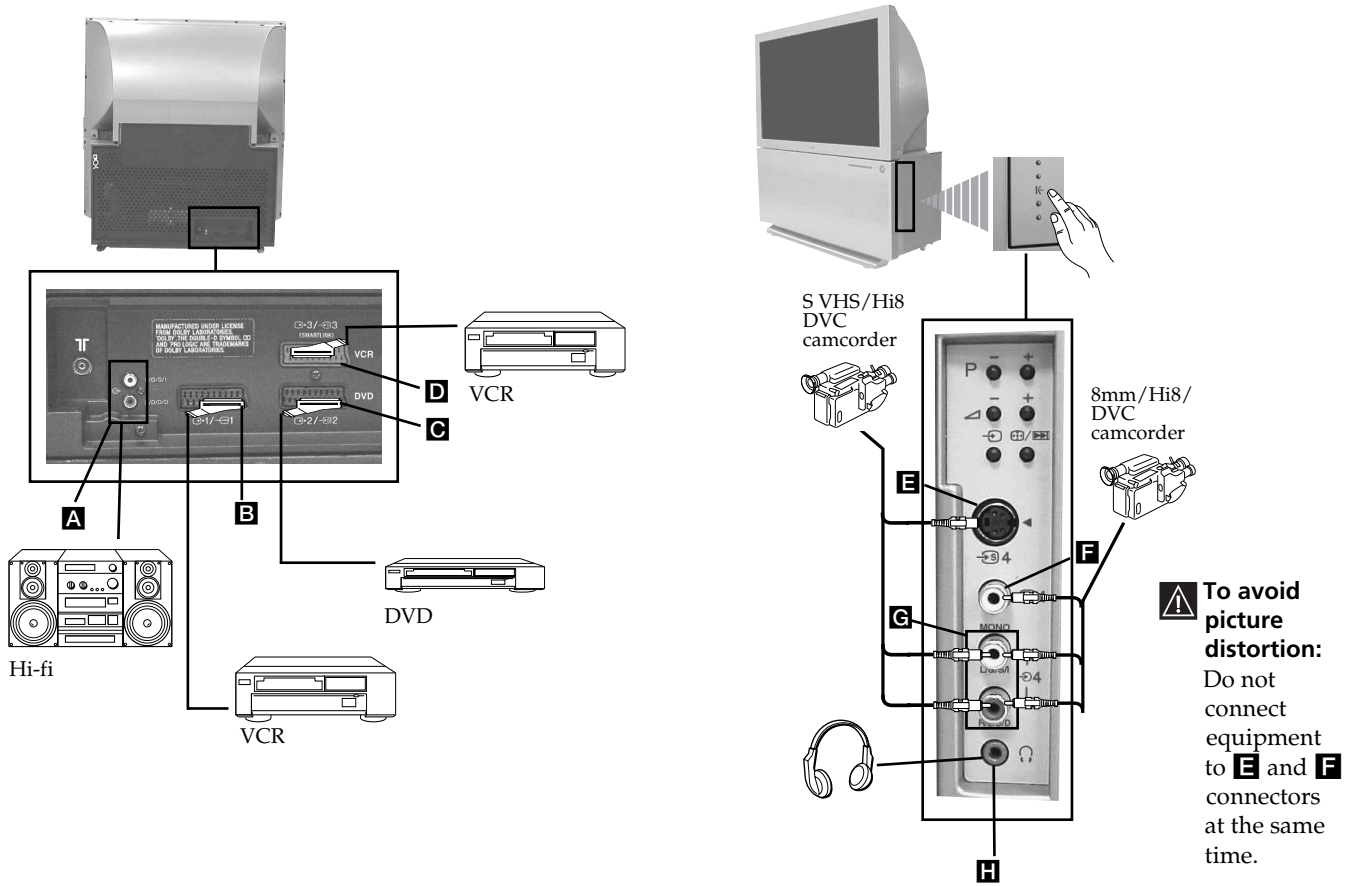

Acceptable input signal

- A** No inputs
- B** Audio/video and RGB signal
- C** Audio/video and RGB signal
- D** Audio/video and S video signal
- E** S Video signal
- F** Video signal
- G** Audio signal
- H** No input

Available output signal

- Audio signal.
- Video/audio from TV tuner.
- Video/audio displayed on TV screen (monitor out).
- Video/audio from selected source.
- No output.
- No output.
- No output.
- Audio signal to headphones.

continued...

Additional Information when connecting equipment

Connecting a VCR

We recommend you connect your VCR to the **D** socket using a scart lead. If you do not have a scart lead, use the "Manual Programme Preset" section on page 16 to tune in the channel of the VCR test signal to TV programme number "0". Also refer to your VCR instruction manual to get the VCR test signal.

If your video supports SmartLink please refer to the "SmartLink" section of this instruction manual on page 22.

Connecting to external Audio Equipment:

Plug in your Hi-Fi equipment to the audio output sockets **A** if you wish to amplify the audio output from projection TV. Next, using the menu system, select the "Sound Adjustment" menu and set the "TV Speakers" to "Off".

i Audio level of the external speakers can be modified by pressing the volume buttons on the remote control. Also treble and bass settings can be modified through the "Sound Adjustment" menu.



To enjoy "Dolby Virtual" sound effect through your Hi-Fi equipment:

Place the speakers of your equipment in front of your listening position and beside the projection TV set but keeping a distance of 50 cm between each speaker and the projection TV set.

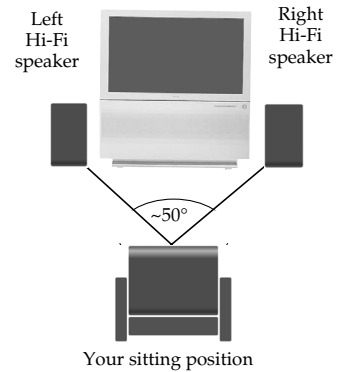
Then by using the menu system, select the menu "Sound Adjustment". Next select "Dolby V" on the "Effect" option.











Using Optional Equipment

i In order to get the input signal of a connected equipment onto the TV screen, you need to select the symbol of the connector to which you have connected the device.
e. g. : Your VCR is connected to the connector with the symbol  1. Press the button  on the remote control repeatedly until you see the symbol  1 on the screen.





- 1 Connect your equipment to the designated projection TV socket, as it is indicated on the previous page.
- 2 Switch on the connected equipment.
- 3 To watch the picture of the connected equipment, press the  button repeatedly until the correct input symbol appears on the screen.

Symbol Input Signals

-  1 • Audio / video input signal through the Scart connector **B**
-  1 • RGB input signal through the Scart connector **B**. This symbol appears only if an RGB source has been connected.
-  2 • Audio / video input signal through the Scart connector **C**.
-  2 • RGB input signal through the Scart connector **C**. This symbol appears only if an RGB source has been connected.
-  3 • Audio/video input signal through the Scart connector **D**.
-  3 • S Video Input signal through the Scart connector **D**. This symbol appears only if an S Video source has been connected.
-  4 • Video input signal through the phono socket **F** and Audio input signal through **G**.
-  4 • S Video Input signal through the front S Video input jack **E** and Audio signal through **G**. This symbol appears only if an S Video source has been connected.

- 4 Press  button on the remote control to return to the normal TV picture.

For mono equipment

Connect the phono plug to the L/G/S/I socket on the side of the TV and select  4 or  4 input signal using the instructions above. Finally, refer to the "Sound Adjustment" section of this manual and select "Dual Sound" "A" on the sound menu screen.



SmartLink

i SmartLink is a direct link between your projection TV set and a VCR.

For SmartLink you need:

- A VCR which supports SmartLink, NextView Link, Easy Link or Megalocic.

i Megalocic is a trademark of Grundig Corporation.
EasyLink is a trademark of Philips Corporation.

- A fully-wired 21 pin SCART cable to connect your VCR to the Scart connector 3/3 (SMARTLINK) on the rear of the Projection TV.

The features of SmartLink are:

- Tuning information such as the channel overview are downloaded from the projection TV set to the VCR.
- Direct projection TV recording: While watching TV you need to press just one button on the VCR to record this programme.
- Automatically switching on: With the projection TV in standby mode, pressing the "Play ▶" button on your VCR automatically switches the TV on.

i For more information on SmartLink, please refer to the Instruction Manual of your VCR.

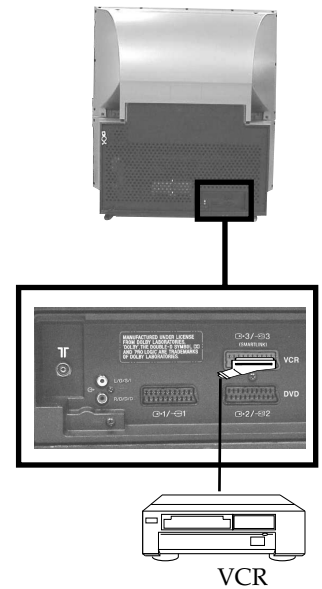

Remote Control Configuration for VCR/DVD

In its default condition this remote control will operate the basic functions of this Sony TV, Sony DVDs and most Sony VCRs. To control VCRs and DVDs of other manufacturers (and some Sony VCR models), please complete the following steps:

- i** • Before you start, look up the 3 digit code for your brand of DVD or VCR from the list below. On those brands that have more than one code, enter the first code number.
- Sony will endeavour to update the software according to market changes. Therefore, please refer to code table included with the remote control for latest code set.

1 Press the Media Selector button on the remote control repeatedly until the required green light (VCR or DVD) is lit.

⚠ If Media Selector is on TV position, code numbers will not be stored.

2 Before the green light goes out, press and hold the yellow button for approximately 6 seconds until the green light starts flashing.

3 Whilst the green light is flashing, enter all three digits of the code for your brand of VCR or DVD using the number buttons on the remote control.

i If your selected code is entered correctly, all three green lights will be lit momentarily.

4 Turn on your VCR or DVD and check that the main functions work.

⚠ • If your device is not working or some of the functions do not work please check that you entered the correct code set or try the next code listed against the brand.

- Your brand codes may be lost if weak batteries are not replaced within a few minutes. To reset your brand of DVD or VCR please repeat the above steps. A small label is added inside the battery door to allow you to record your brand codes.
- Not all brands are covered and not all models of every brand may be covered.



GB

VCR Brand List		DVD Brand List	
Brand	Code	Brand	Code
SONY (VHS)	301, 302, 303, 308, 309	SONY	001
SONY (BETA)	303, 307, 310	AIWA	021
SONY (DV)	304, 305, 306	DENON	018, 027, 020, 002
AIWA	325, 331, 351	GRUNDIG	009, 028, 023, 024, 016, 003
AKAI	326, 329, 330	HITACHI	025, 026, 015, 004
DAEWOO	342, 343	JVC	006, 017
GRUNDIG	358, 355, 360, 361, 320, 351	KENWOOD	008
HITACHI	327, 333, 334	LG	015, 014
JVC	314, 315, 322, 344, 352, 353, 354, 348, 349	LOEWE	009, 028, 023, 024, 016, 003
LG	332, 338	MATSUI	013, 016
LOEWE	358, 355, 360, 361, 320, 351	ONKYO	022
MATSUI	356, 357	PANASONIC	018, 027, 020, 002
ORION	328	PHILIPS	009, 028, 023, 024, 016, 003
PANASONIC	321, 323	PIONEER	004
PHILIPS	311, 312, 313, 316, 317, 318, 358, 359	SAMSUNG	011, 014
SAMSUNG	339, 340, 341, 345	SANYO	007
SANYO	335, 336	SHARP	019, 027
SHARP	324	THOMSON	012
THOMSON	319, 350	TOSHIBA	003
TOSHIBA	337	YAMAHA	018, 027, 020, 002

Optimum Viewing Area

i For the best picture quality, try to position the projection TV so that you can view the screen from within the areas shown below.

Horizontal viewing area

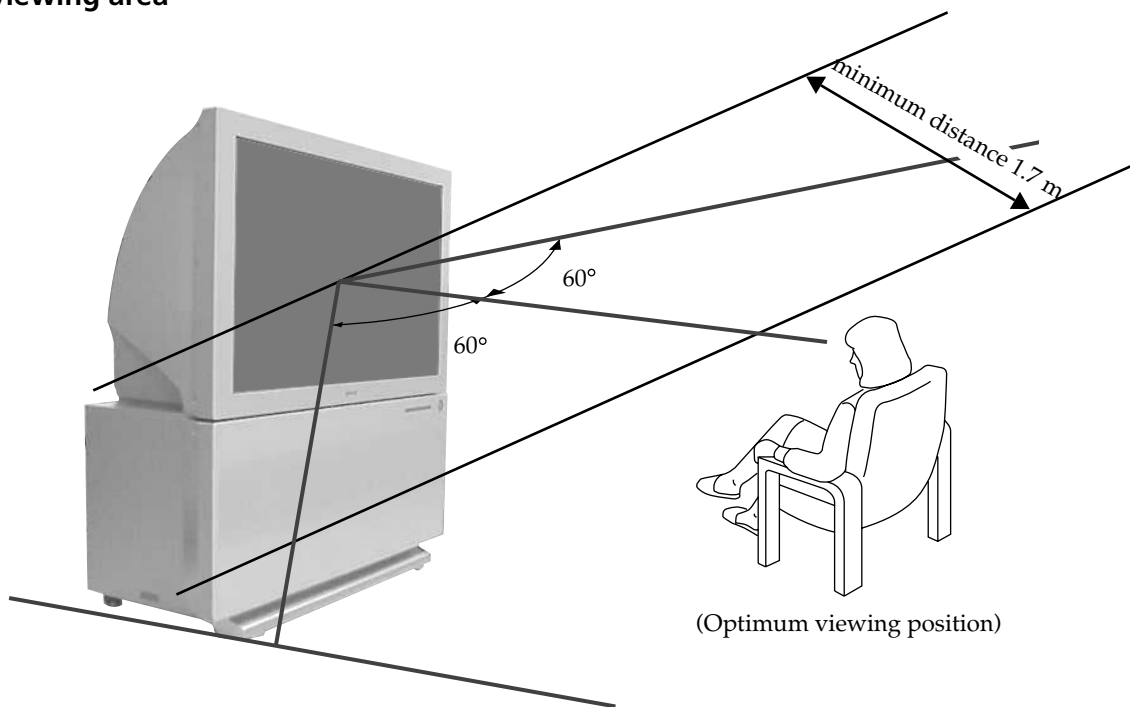

Vertical viewing area

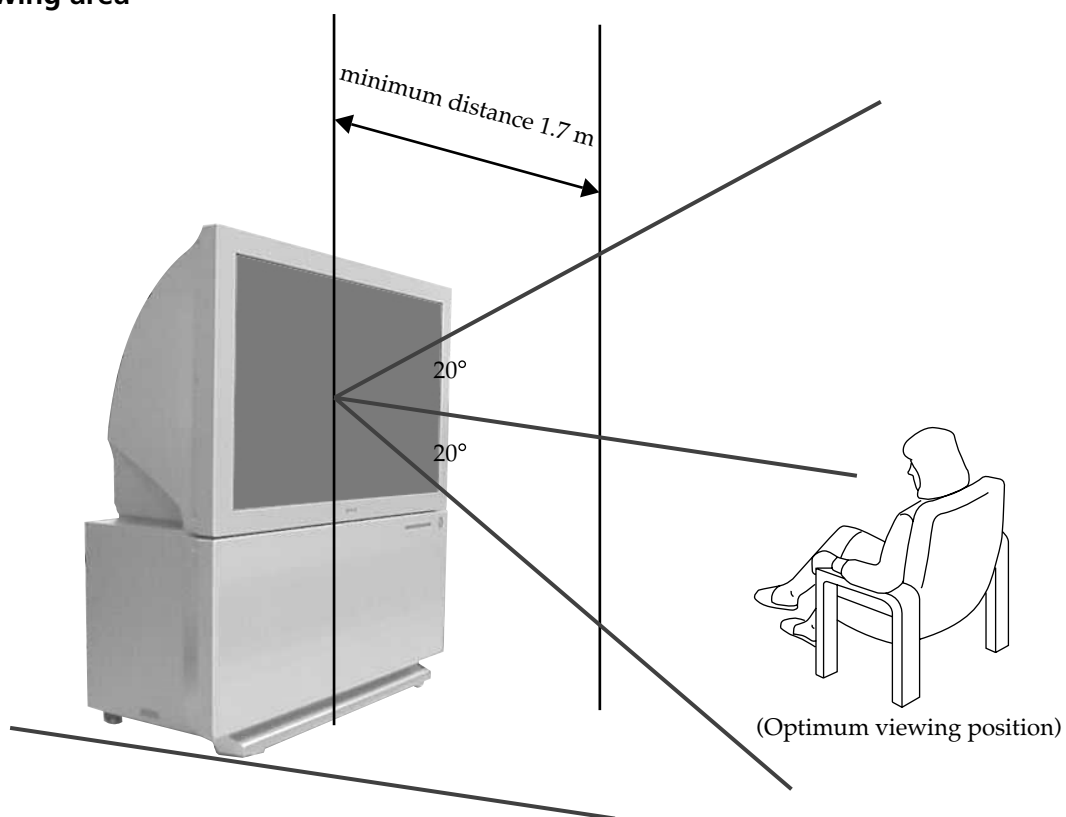

Specifications

TV system:

I

Colour system:

PAL

SECAM, NTSC 3.58, 4.43 (only Video In)







Channel Coverage:

I: UHF B21-B69





Projected picture size:

44" (approx. 112 cm. measured diagonally)

Rear Terminals

-  1/  1 21-pin scart connector (CENELEC standard) including audio/video input, RGB input, TV audio/video output.
-  2/  2 21-pin Scart connector (CENELEC standard) including audio / video input, RGB input, monitor audio/video output.
-  3/  3 21-pin Scart connector (CENELEC standard) including audio / video input, S video input, selectable audio / video output and Smartlink interface.
-  audio outputs (Left/Right) - phono jacks

Side Terminals

-  4 S Video input – 4 pin DIN
-  4 video input – phono jack
-  4 audio input – phono jacks
-  headphones jack

Sound Output:

2 x 30 W (music power)
2 x 15 W (RMS)

Power Consumption:

225 W

Standby Power Consumption:

< 0.7 W

Dimensions (w x h x d) :

approx. 1100 x 1160 x 536 mm.

Weight:

approx. 61 Kg.

Accessories supplied:

1 Remote Control (RM-938)
2 Batteries (IEC designated, AA size)

Other features:

- Digital Comb Filter (High resolution).
- 100 Hz picture, Digital Plus.
- Teletext, Fasttext, TOPtext (250 page TEXT memory).
- NICAM.
- Sleep Timer.
- SmartLink (direct link between your projection TV set and a compatible VCR. For more information on SmartLink, please refer to the Instruction Manual of your VCR).
- Dolby Virtual.
- BBE.
- PIP.
- Auto Format.
- ACI (Auto Channel Installation).







GB

Design and specifications are subject to change without notice.

Ecological Paper - Totally Chlorine Free 

Troubleshooting

 Here are some simple solutions to problems which may affect the picture and sound.

Problem	Solution
No picture (screen is dark) and no sound.	<ul style="list-style-type: none">• Check the aerial connection.• Plug the TV in and press the  button on the front of the projection TV.• If the standby indicator  is on, press TV I/ button on the remote control.
Poor or no picture (screen is dark), but good sound.	<ul style="list-style-type: none">• Using the menu system, select the "Picture Adjustment" menu and select "Reset" to return to the factory settings.
No picture or no menu information from equipment connected to the Scart connector.	<ul style="list-style-type: none">• Check that the optional equipment is on and press the  button repeatedly on the remote control until the correct input symbol is displayed on the screen.
Good picture, no sound.	<ul style="list-style-type: none">• Press the  + button on the remote control.• Check that "TV Speakers" is "On" in the "Sound Adjustment" menu.• Check that headphones are not connected.
No colour on colour programmes.	<ul style="list-style-type: none">• Using the menu system, select the "Picture Adjustment" menu and select "Reset" to return to factory settings.
When you switch on the TV the last channel you were watching before switching the TV off does not appear.	<ul style="list-style-type: none">• This is not a malfunction. Press the number buttons on the remote control to select the desired channel.
Undefined picture with different colour on the outlines of the images.	<ul style="list-style-type: none">• Adjust the colour registration. For more details, please refer to "Adjusting Colour Registration (Convergence)" section on page 10.
Noisy picture when viewing a TV channel.	<ul style="list-style-type: none">• Using the menu system, select the "Manual Programme Preset" menu and adjust Fine Tuning (AFT) to obtain better picture reception.• Using the menu system, select the "Noise Reduction" option in the "Picture Adjustment" menu and select "Auto" to reduce the noise in the picture.
Distorted picture when changing programmes or selecting teletext.	<ul style="list-style-type: none">• Turn off any equipment connected to the Scart connector on the rear of the projection TV.
Wrong characters appear when viewing NexTVView.	<ul style="list-style-type: none">• Use the menu system to enter the "Language" menu (see page 14) and select the same language that NexTVView is broadcast in.
Brightness level of the picture is notoriously decreased when viewing a teletext page.	<ul style="list-style-type: none">• This is not a malfunction. After 5 minutes viewing the same teletext page and without any button being pressed, the projection TV automatically decreases the brightness level to avoid any damage to the picture tube. To reset the brightness level, press any button of the remote control.
Remote control does not function.	<ul style="list-style-type: none">• Check that the Media Selector on the remote control is set to the device you are using (VCR, TV or DVD).• If the remote control does not operate the VCR or DVD even when the Media Selector has been set correctly. Enter the necessary code set as explained in the "Remote Control Configuration for VCR/DVD" chapter on page 23.• Replace the batteries.
The standby indicator  on the projection TV flashes.	<ul style="list-style-type: none">• Contact your nearest Sony service centre.

 If you continue to experience problems, have your projection TV serviced by qualified personnel. Never open the casing yourself.

Additional Information

Television Channel Number Guide for analogue channels

i Only the main transmitters are listed. Information regarding the regional sub-relay channel numbers can be obtained by contacting The BBC Engineering Information Dept., Telephone Number 020 7852 5040.

MAIN TRANSMITTERS	BBC1	BBC2	ITV	CH4	CH5
London & South East					
① Bluebell Hill	40	46	43	65	-
② Crystal Palace	26	33	23	30	-
③ Dover	50	56	66	53	-
④ Heathfield	49	52	64	67	-
⑤ Oxford	57	63	60	53	49
South-West					
⑥ Beacon Hill	57	63	60	53	-
⑦ Caradon Hill	22	28	25	32	-
⑧ Huntshaw Cross	55	62	59	65	67
⑨ Redruth	51	44	41	47	37
⑩ Stockland Hill	33	26	23	29	-
Channel Islands					
⑪ Fremont Point	51	44	41	47	-
South					
⑫ Hannington	39	45	42	66	-
⑬ Midhurst	61	55	58	68	-
⑭ Rowridge	31	24	27	21	-
West					
⑮ Mendip	58	64	61	54	37
East					
⑯ Sandy Heath	31	27	24	21	39
⑰ Sudbury	51	44	41	47	-
⑱ Tacolneston	62	55	59	65	52
Midlands (West)					
⑲ Ridge Hill	22	28	25	32	-
⑳ Sutton Coldfield	46	40	43	50	-
㉑ The Wrekin	26	33	23	29	-
Midlands (East)					
㉒ Waltham	58	64	61	54	-
Northern Ireland					
㉓ Brougher Mountain	22	28	25	32	-
㉔ Divis	31	27	24	21	-
㉕ Limavady	55	62	59	65	-
North					
㉖ Belmont	22	28	25	32	56
㉗ Emley Moor	44	51	47	41	37
North-West					
㉘ Winter Hill	55	62	59	65	48
North-East					
㉙ Bilsdale West Moor	33	26	29	23	-
㉚ Caldbeck	30	34	28	32	56
㉛ Chatton	39	45	49	42	-
㉜ Pontop Pike	58	64	61	54	-
Scotland					
㉝ Angus	57	63	60	53	-
㉞ Black Hill	40	46	43	50	37
㉟ Sandale	22	67	-	-	-
㊱ Caldbeck	-	-	28	32	56
㊲ Craigkelly	31	27	24	21	48
㊳ Darvel	33	26	23	29	-
㊴ Durriss	22	28	25	32	67
㊵ Eitshal (Lewis)	33	26	23	29	-
㊶ Keelylang Hill	40	46	43	50	-
㊷ Knock More	33	26	23	29	-
㊸ Rosemarkie	39	45	49	42	-
㊹ Rumster Forest	31	27	24	21	-
㊺ Selkirk	55	62	59	65	52
Wales					
㊻ Blaenplwyf	31	27	24	21	56
㊼ Carmel	57	63	60	53	-
㊽ Llanddona	57	63	60	53	-
㊾ Moel-y-Parc	52	45	49	42	-
㊿ Presely	46	40	43	50	37
㊽ Wenvoe	44	51	41	47	-

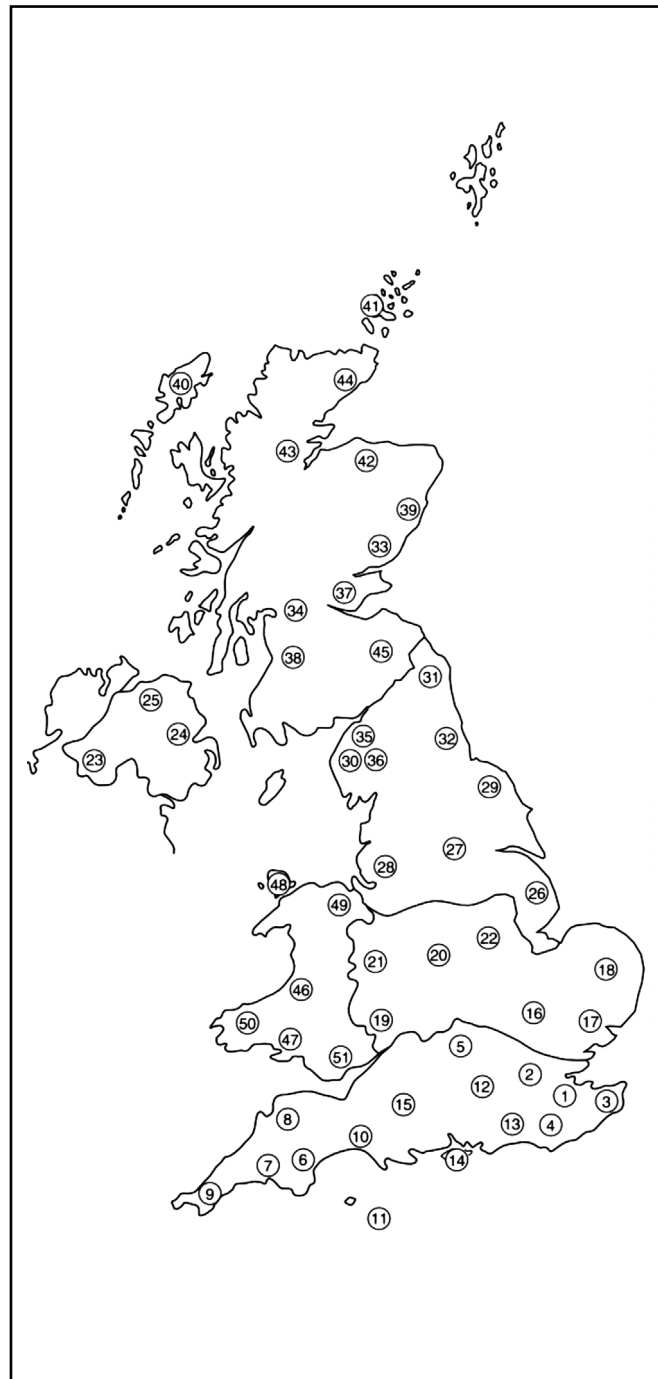

GB

<http://www.sony.net>

Sony España, S.A.

Printed in Spain

